

2009

2010



2009

2010

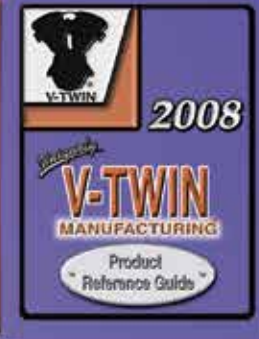

2009

2010



2009

2010



PRODUCT REFERENCE GUIDE

2017

V-TWIN MANUFACTURING

# V-TWIN PRODUCT GROUPS

## 1. *Touring 1984-up*

Pages 1-136

## 2. *Big Twin 1984-up*

Pages 136-480

## 3. *Classic 1915-83*

Pages 481-828

## 4. *Sportster 1957-up*

Pages 829-1014

## 5. *Multi-Fit/Chopper*

Pages 1015-1258

## 6. *Tools-Maintenance*

Pages 1259-1328

For our complete listings: [www.vtwinmfg.com](http://www.vtwinmfg.com)





# Index for Touring

<b>A</b>	
<b>AIR CLEANER</b> .....	81-94
Breather Kits.....	85
Filter.....	81,82,83,84,86,95
Insert.....	92
Scoop.....	86,134
<b>AXLE</b> .....	55,56
Spacer.....	55
<b>B</b>	
<b>BELT</b> .....	41
<b>BELT GUARD</b> .....	31
<b>BRAKE</b>	
Pad.....	43
Pedal.....	40
Pedal Pad.....	40
Rotor.....	44,45
<b>C</b>	
<b>CALIPER</b>	
Front.....	42
Rear.....	41
<b>CAM COVER</b> .....	28
Trim/Mount.....	28
Kit.....	28
<b>CAPS(Chrome)</b> .....	97,109
<b>CELL PHONE</b> .....	130,131
<b>CLUTCH</b>	
Cable.....	96
Lever.....	128,129
Release Kit.....	34
<b>CONTROLLER</b> .....	103
<b>D</b>	
<b>DASH CONSOLE</b> .....	101
<b>DASH STASH BOX</b> .....	101
<b>DERBY COVER</b> .....	25,26,27
<b>DISPLAY STAND</b> .....	51
<b>DIPSTICK</b> .....	35,80
<b>E</b>	
<b>EMISSION &amp; NOISE REGULATIONS</b>	
.....	71
<b>ENGINE</b>	
Bar.....	61,62
Dress Up.....	30,31,32,97
Mount.....	98
<b>EXHAUST</b>	
Baffle.....	74
Fishtail.....	66-67
Heat Shield.....	77
Muffler.....	65,66,67,68
Oxygen Sensor Tool.....	76
Plugs.....	76
Wrap.....	76
<b>F</b>	
<b>FAIRING</b> .....	18,19,20
<b>FENDER</b> .....	59,60
Bumper.....	60,62,70
Ornament.....	131
Trim.....	58
Tip.....	57,58,59
<b>FILTER</b>	
Air.....	81,82,83,84,86,95
Oil.....	79

<b>FOOTPEG</b> .....	125
<b>FORK</b>	
Cover.....	49
Dress Up Kit.....	46
Slider.....	48
Tube/Slider Assembly.....	48
<b>FOOT BOARD</b> .....	117-124
<b>FORWARD CONTROL</b> .....	36
<b>FUEL CONSOLE DOOR</b> .....	101
<b>H</b>	
<b>HANDLEBAR</b> .....	126-127
Control/Switch.....	129,131
Cover.....	48,51
Switch.....	109,131,132,133
Wiring.....	132,133
<b>HANDLEBAR GRIP</b> .....	130
<b>HEAD BOLT COVER SET</b> .....	32
<b>HEADLAMP</b> .....	104-105
Fork Cover Set.....	104
<b>HORN</b> .....	134
<b>I</b>	
<b>IGNITION POINTS COVER</b> .....	33
<b>INSPECTION TAG HOLDER</b> .....	125
<b>INSPECTION COVER</b> .....	27
<b>G</b>	
<b>GAS TANK</b> .....	101
<b>K</b>	
<b>KICKSTAND</b> .....	78
<b>L</b>	
<b>LEVER</b> .....	128
<b>LUGGAGE RACK</b> .....	14-15
Hardware.....	14
<b>LOWERING KIT</b> .....	48,51
<b>M</b>	
<b>MASTER CYLINDER COVER</b> .....	36
<b>MANUAL</b> .....	136
<b>MIRROR</b> .....	135
<b>MOTOR SHOP SERVICE</b> .....	1260-1265
<b>MUD FLAP</b> .....	58
<b>O</b>	
<b>OIL</b>	
Cooler.....	80
Filter.....	79
Dipstick.....	80
Pump.....	79
Pump Cover.....	35
<b>P</b>	
<b>PATCHES (CLOTH)</b> .....	1323
<b>PRIMARY</b>	
Cover/Trim.....	24,25
Derby.....	25,26-27
Dress Up Kit.....	24
<b>PUSHROD COVER</b> .....	29
<b>PULLEY COVER</b> .....	41
<b>R</b>	
<b>ROCKER BOX SET</b> .....	3-10,11
Hardware.....	4,5,8
<b>S</b>	
<b>SADDLEBAG</b> .....	3-10,11
Hardware.....	4,5,8

<b>SADDLEBAG CONTINUED</b>	
Latch.....	10
Lid.....	6,7
Riveting Tool.....	6
<b>SEAT</b> .....	
Back Rest.....	17
Handrail.....	16
Mount Kit.....	16
<b>SHIFTER</b>	
Lever.....	38,39
Linkage/Rod.....	37
<b>SHOCK</b> .....	50
<b>SHOW BIKE BOLT KIT</b> .....	97
<b>SIDE COVER</b> .....	11
<b>SISSYBAR/PAD</b> .....	17
Inserts.....	17
Side Plate.....	17
<b>SNAP CAP</b> .....	109
<b>SPARK PLUG COVER</b> .....	30
<b>SPEAKER</b> .....	12,18
<b>SPEEDOMETER</b>	
Bezel.....	95
Cables.....	96
Gauge.....	95
Visor.....	95
<b>SPOTLAMP</b> .....	110,111,113
<b>SUSPENSION</b> .....	50
<b>SWINGARM</b> .....	99-100
Bushing.....	99,100
Iso Mount.....	99
Mounting Kit.....	99,100
Passenger Footboard.....	118-120
<b>SWITCH</b>	
Handlebar.....	109,131,132,133
<b>T</b>	
<b>TAPPET</b>	
Base Cover.....	30
<b>THROTTLE</b> .....	96
<b>TRANSMISSION</b>	
Cover.....	34,35
Dipstick.....	35
Hardware.....	34
Trim.....	35
<b>TOOL KIT</b> .....	6,100,136
<b>TOUR PACK</b> .....	12,13
Latch.....	12,13
Hardware.....	12,13
Reflector.....	12,13
<b>TRIPLE TREE</b> .....	46
Cover.....	46
<b>TURN SIGNAL</b> .....	112,114,115
<b>W</b>	
<b>WHEEL</b> .....	53-54
<b>WINDSHIELD</b> .....	18,19,20,21,23,25



49-3505



**You Tube**

**Watch Our Video!**  
<http://www.youtube.com/user/TeddCycle>



## Deep Saddlebags

- Injection molded for smooth inside and outside surfaces.
- Full set includes left and right sides, lids and bottoms.
- Bottoms have indents for muffler body on the under side with a slight curve down towards the rear.

VT No.	Item	Fits
49-3505	Full Set, Tops & Bottoms	FLT 1993-2013
49-2667	Bottom Set	FLT 1993-2013
49-0723	Liner Kit For Bags	FLT 1993-2013



49-1135



49-3500

## Replica Saddlebags

- Plastic with a natural finish, ready for primer paint.
- Saddlebags are manufactured of FRP, fiberglass reinforced plastic.

VT No.	Item	Fits	Finish
49-3500	Full Set, Tops & Bottoms	FLT 1993-2013	Black
49-2712	Right Bottom	FLT 1993-2013	Black
49-2713	Left Bottom	FLT 1993-2013	Black
49-0535	Right & Left Bottom Set	FLT 1985-1992	Black
49-2714	Right Bottom	FLT 1985-1992	Black
49-2715	Left Bottom	FLT 1985-1992	Black
49-0730	Left/Right	FLT 1993-2013	Black
49-0680	Left/Bottom	FLT 1993-2013	White
49-0681	Right/Bottom	FLT 1993-2013	White

## Stretched Saddlebag Bottom Set

- Includes right and left side with black unfinished surface.
- This saddlebag set is a perfect fit with all mounting holes that match stock locations, may re-use stock hardware for a true bolt-on experience. All mount holes are pre-drilled in stock location and pre-fit for the ease of installation.
- The bottoms are 2" deeper in the front than stock and 3" deeper in the rear, which gives these the stretched look.
- Designed for models with dual exhaust.
- Complete hinge, latch, and hardware kit is available separately for Road King riders looking to keep stock bags complete or for converting from leather covered bags. Order lids separately.

49-1135



49-0535

VT No.	Item	Fits
49-1135	Black Stretched Bottoms	FLT 2014-up



49-3506



49-3507



### 3" Stretched Saddlebag Kit.

- Includes bags, lids, face plates, locks and mounting hardware.
- Bags are injection molded and have a smooth inside and outside surface. Bottoms are 2" deeper in the front, 3" deeper in the rear and have cutouts on both bags for dual exhaust.

VT No.	Fits
49-3506	1993-2013 FLT
49-3507	2014-up FLT



50-1135

50-1136



49-0468

### Saddlebag Filler Panels

- These kits fill in the gaps between the fender and the rear of the saddlebags, hiding the saddlebag mounting brackets.
- Available in chrome or gloss black finishes and smooth for bikes without a saddlebag guard or slotted for bikes with saddlebag guards.

Chrome	Black	Fits/Years	Type
50-1135	50-1136	1993-08	Smooth
49-0468	49-0469	2009-13	Smooth
50-1196		2014-up	Smooth
50-1197		2014-up	Slotted



49-0535



49-0535

### Black Saddlebag Bottom Set

- Constructed from a black PVC material, ready for primer and paint!
- Locks and hinges not included. Bags will accept OE or V-Twin lids and related hardware, available separately.
- All pieces are constructed of black fiberglass and reinforced FRP plastic, ready for primer and paint. FRP is made up of polyphenylene oxide/polyamide alloy.

VT No.	Fits
49-0535	1985-1992



42-1107

### Saddlebag Filler Panels

- Fit 2006-2008 FLHX.

VT No.	Finish
42-1107	Chrome
42-1108	Raw



51-0480



49-0873

### Chrome Saddlebag Support Set

- Left and right set used when saddlebag trim set are not used to create a cleaner custom appearance.

VT No.	Fits
51-0480	FLT 2009-2013, 90881-09A
49-0873	FLHX, FLTRX, FLT 2009-2013





50-0033

**Docking Hardware for FLT.**

VT No.	Item
50-0032	Shorty Detachable Sissy Bar, Chrome
50-0033	4 Point Docking Hardware Kit, Chrome, 2014-up
50-0034	4 Point Docking Hardware Kit, Black, 2014-up



49-1269

49-1262

49-1264



49-1005



49-2506

49-1268



49-1265



49-1266



49-0724

**Saddlebag Parts**

VT No.	Item	Fits
49-0723	Liner Kit	FLT 1993-2013
49-1280	Face Plate, Set of 2	FLT 1993-2013
49-1271	Saddlebag Hardware Kit	FLT 1993-2013
49-0900	Saddlebag Hardware Kit	FLT 1993-2013
49-1279	Saddlebag Hardware Kit	FLT 2014-up
37-0568	Saddlebag Rivets 3/8"	All Models
37-0566	Saddlebag Rivets 5/16"	All Models
28-0956	Saddlebag Bumper Set	FLT 2014-up
49-0724	Key and Lock Kit	FLT 1993-2013
49-1005	Key and Lock, Black, pair	FLT 1993-2013
49-0081	Hardware Left/Right Latch Assy	FLH 1993-2013
49-0095	Hardware/without Latch Set	FLH 1993-2013
49-2506	Hinge Kit	FLT 1979-92
49-1262	Mount Isolator Set	FLT
49-1263	Strike Set	
49-1264	Seal Set	
49-1265	Tether Set	
49-1266	Handle Kit, Chrome	
49-1267	Stud Set	
49-1268	Hinge Kit	
49-1269	Cover Gasket	
49-1270	Lock Set	



49-1271

Fits 1993-2013 FLT



49-0900

Fits 1993-2013 FLT



49-0081



49-1263



28-0956



37-0566



49-0095



49-2700

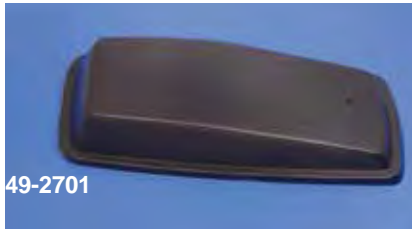

49-2701



15-0580

### FLT/FLHT Saddlebag Lids

- Primed finish.
- Hardware and gaskets are not included.
- Lids are sold each.

• All pieces are constructed of black fiberglass and reinforced FRP plastic, ready for primer and paint. FRP is made up of polyphenylene oxide/polyamide alloy.

VT No.	OEM	Item	Finish	Fits	Note
<b>1979-1984</b>					
49-2700	90756-79A	Right Lid	Primed	FLT 1979-1984	fiberglass
49-2701	90757-79A	Left Lid	Primed	FLT 1979-1984	fiberglass
49-0025		Left and Right Lid Kit	Black	FLT 1979-1984	with gasket and hinges
15-0580	90633-82A	Gaskets		1980-92	Gaskets



16-0011



16-0098

### DIY Touring Tool Kit

- For 1999-2013 models will fit in a kidney shaped tool box. Includes rider tools and service tools for the rider-mechanic.

VT No.	Fits
16-0011	1999-13
16-0098	2014-up



49-1610



49-1610 in use!

### Saddlebag Latch Rivet Tool

- Gives secure fastening of rivets while providing a clean factory look

VT No.	Brand
16-1610	V-Twin
16-1881	Jims



49-2679



49-2680

### Saddlebag Tool Tray Set

- Made of ABS plastic. Trays cover the length and width of the saddlebags.
- Easily lift the tray out with one hand when needed.

VT No.	Fits
49-2679	1993-2013
49-2680	2014-up



## Saddlebag Lids

- Lids are plastic with a smooth finish and ready for paint.
- Lids come individually or as a pair.
- Lids for are injection molded black plastic.



49-3503



49-3504



49-2738



49-2737



49-2725

49-2734  
Right Lid



49-2735  
Left Lid



49-2730



49-2703 Left Lid



49-2702 Right Lid

VT No.	OEM	Item	Finish	Fits	Note
<b>2014-up</b>					
49-2734	90201108	Right Lid	Black	FLT 2014-up	with speaker cutout
49-2735	90201109	Left Lid	Black	FLT 2014-up	with speaker cutout
49-3503		Right & Left Set	Black	FLT 2014-up	with speaker cutout
49-2737	90200411	Right Lid	Black	FLT 2014-up	without speaker cutout
49-2738	90200413	Left Lid	Black	FLT 2014-up	without speaker cutout
49-3504		Right & Left Set	Black	FLT 2014-up	without speaker cutout
<b>1993-2013</b>					
49-0499		Left and Right Set	Primed	FLT, FLHT 1993-2013	with speaker cutout
49-2730	90756-93	Left and Right Lid Set	Primed	FLT, FLHT 1993-2013	
49-2705	90757-93	Left Lid	Primed	FLT 1993-2013	
49-2704	90756-93	Right Lid	Primed	FLT 1993-2013	
<b>1985-1992</b>					
49-2725		Left and Right Lid Kit	Black	FLT 1985-1992	with gasket and hinges
49-2703	90757-85	Left Lid	Black	FLT 1985-1992	plastic, hole for lock
49-2702	90756-85	Right Lid	Black	FLT 1985-1992	plastic, hole for lock





49-0081

Fits 1993-up FLH

Saddlebag hardware kit with left and right latch assembly set, includes ball head studs.

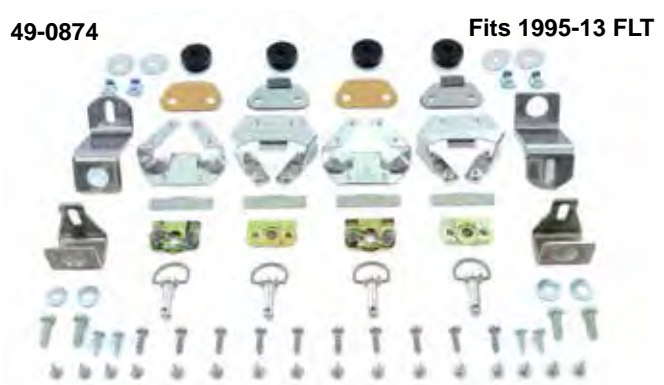

49-0874

Fits 1995-13 FLT



Fits 1993-up FLH



49-0729

28-0447

49-0095



49-0886

49-0882



49-0885

49-0887

### Additional Hardware for Saddlebags

- Replacement application.
- Some parts are also packaged with our mount kits, as indicated.

VT No.	Item	With Mount Kit			Fits
		49-0095	49-1271	49-0081	
49-0874	Mount Hardware Kit 20 pieces	x	x	x	FLT 1995-2013
49-0885	Reinforcing Lid Back Plate Set	x	x	x	FLT 1993-2013
49-0887	Top Straps with screws	x	x	x	FLT 1993-2013
28-0447	Rubber Bumper Set	x	x	x	FLT 1993-2013
49-0856	Gasket Hardware Kit	-	-	-	FLT 1993-2013
15-0581	Saddlebag Gasket, 62" long	x	x	x	FLT 1993-2013
15-0580	Saddlebag Gasket, pair	-	-	-	FLT 1980-1992
49-0886	Lid Wear Plates	-	-	x	FLT 1993-2013
49-0882	Latch Set	-	-	x	FLT 1993-2013
49-0729	Lock and Key Kit	-	x	-	FLT, FLHT 1993-up



### Saddlebag Lock Kit

- Fits 2014-up.
  - Includes 4 screws and 4 lock tabs.
- VT No. 49-1421**



49-2508



49-2508 Installed



49-0791



31-1562

49-0532

### Chrome Saddlebag Guard Kit

- Includes chrome rail set (right and left) & mount brackets.
- Brackets are 15% thicker than stock for added support to prevent breakage.

VT No.	Item	Fits
49-2508	Kit	FLHT 1997-2008, FLHR 1997-2008
50-1205	Kit	FLHT 2008-13
50-1206	Kit	FLH 2014-up
49-0791	Brackets	FLT 1979-2013
31-1562		Repair Brackets, FLT 1979-2013
49-0532		Bracket, Heavy Duty, FLT 1979-2013
49-1724	Set	Forged Alloy
<b>Bail Head Fastener Set. VT No. 49-1267</b>		

50-0959



### Chrome Saddlebag Trim Rail Kit

- Accents FL saddlebag top covers and offers protection from scratching.

VT No.	Fits
50-0959	FLT 1987-up



### Saddlebag LED Lamp Kit

- Set of red LED lamps with red lens and the Touring electrical connection update kit. OEM# 68000082
- **Note:** Does not work with stretched saddlebags.

VT No. 49-0000



49-0798



49-0799

### Chrome Lower Saddlebag Guard Sets

- Left and right saddlebag guards with a chrome finish.
- Eliminate the rear saddlebag guard for a sleek, custom appearance. The kit replaces the loop saddlebag guard with a bolt-on chrome plated support leg.

VT No.	Fits
49-0798	FLTR 2004-08, FLHRS 2004-08, FLHRX 2006-08
49-0873	2009-13 FLHX, FLT
51-0480	2009-13 FLHX, FLT
51-0482	2014-up FLHR, LHTC, FLHK

50-0873



50-1518



### Saddlebag Guard Eliminator Brackets

- Go from the frame to the lower support bracket and replace the saddlebag guards and upper saddlebag rails.

Chrome	Black	Fits
50-0873	50-1518	FLT 1997-2008

50-1113



### Chrome Saddlebag Rail Set

- Includes four chrome pieces to replace original.

VT No.	Fits
50-1113	FLT 1993-2008



### Saddlebag Guard Bracket Kit

- Forged alloy heavy duty construction which is 15% thicker than stock for added support to prevent breakage. Mounts with stock hardware. Fits FLT 1979-2013.

VT No. 49-1724

# Saddlebag Face Plate

TOURING



42-1117



42-1100



42-1104



42-1126



42-1064



42-1130



42-1111



42-1128



42-1127



42-1098



42-1129



42-1131



42-1163



42-0176



42-1099



42-1124



42-1097



49-0883



42-0365



42-7103

## Saddlebag Face Plate Set

• Fit 1993-2013 FLT

Style	Chrome	Black
Plain Winged	42-1099	42-1117
Flame Winged	42-1100	—
Billet Winged	42-0176	42-0179
Ball Milled Winged	42-1104	42-1126
Perforated Winged	—	42-1163
Speed Line	42-1064	—
Contour	42-1130	42-1124
Perforated	42-1111	—
Carbon Fiber	—	42-7103
Smooth with reflector	49-0867	—
Flame	49-1013	—
Louvered	42-1128	—
Deep Cut	42-1129	—
Ball Milled	42-1131	—



42-0179



42-0867



42-0180



42-1181

Style	Chrome	Black
Finned	42-0180	—
Swiss Cheese	42-1097	42-1127
Flair	42-1098	—
Chrome Face Plate Kit; includes flame insert	49-0883	42-1181
	42-0365	—

49-0773 Saddlebag Insert Set, Flame, 1993-2013



49-1281



49-1282



42-1162



49-1011



49-1012



48-1197



33-0221

## Wyatt Gatling Saddlebag Face Plate Insert Set.

VT No.	Fits
48-1197	FLT 1993-2013, flame
33-0221	Reflector Set Only

## 2014-up Saddlebag Hinge Cover Set.

Chrome	Black	Style
49-1281	49-1282	Edge Cut
49-1315	49-1316	with reflector
42-1162	—	Smooth with one indent
49-1011	49-1012	Smooth with cuts





49-2719  
Installed



49-2719



49-2720



49-2721



### Bertha Leather Saddlebags

- Feature full leather construction with fringe and 1/2" chrome spot.
- FLT models feature fiberglass backing and a battery cutout.
- The 1993-up models have a cut out for shock clearance.

VT No.	Fits
48-3178	1985-92
48-3183	1993-up

### Wyatt Gatling Contour Side Cover Sets.

- Made of formed FRP plastic, these side covers
- Feature a clean contoured look that flows back to the saddlebags and have more surface area than stock side covers for continuation of your paint scheme.
- These side covers will compliment our stretched saddlebags or stock saddlebags. Fit all FLT, FLHT, FLHR and FLHX models.

VT No.	Fits
49-2719	1997-2008
49-2720	2009-2013
49-2721	2014-up
49-1783	Pins
37-0900	Bushing, 1997-2007
37-0901	Bushing, 2008-up



### Universal Saddlebag Kit

- Features random key code for use with vinyl or leather soft side saddlebags. VT No. 49-1420



### Side Cover Rubber Grommets

- Help secure side covers.

VT No.	Fits
37-0902	2008-2014
37-0903	1996-2007



33-1187



33-1188



33-1189



49-0782  
Installed



49-0782



49-1245

### Aurora Touring Pack Accent Light Kit

VT No.	Item
33-1187	Red Accent light
33-1188	Smoke Accent light
33-1189	Clear Accent light



### Speaker Trim Rings.

VT No.	OEM	Fits
42-1744		1998-13 FLHTCU



**Tinted Radio Cover** protects aftermarket radios from the elements, and fits in the factory dash opening rather than the radio mounting surface. The radio cover is UV stable and scratch resistant. The O-ring seal creates a watertight fit.

VT No.	Fits
42-0009	1996-2013 FLHT, 1996-2013 FLHX.



49-0554

### Chrome Touring Luggage Pack Latch Kit

- For touring pack and saddlebags.
- The kit includes catch and spacer plate plus the screws for installation.
- Two sets are required for each tour pack

VT No.	OEM	Fits
49-0554		1995-05 FLT
49-0782	53000252	2006-13 FLT
49-1245		2014-up FLT



37-9136



50-1216



50-0683



49-0890



49-1006

### Hardware for Touring Pack

• Latch kits have parts for a single latch, order in quantity two for complete installation.

VT No.	Years	Fits
37-9136	Latch Set	FLT 1995-06
37-9774	Latch Spacer Set	FLT 1985-2006
37-0352	Latch Kit	FLT 1995-06
50-1216	Hinge Set, chrome	FLT 1988-2013
50-0683	Hinge Set, black	FLT 1988-2013
49-0890	Latch, black	FLT 2006-up
49-0893	Latch, black	FLT 1995-up
49-1006	Lock & Key Kit	FLTR 1992-2013 FLHTC 1992-2013 FLHT 1992-2013 FLHR 1992-2013 FLHX 1992-2013

49-2746



49-2665



15-0583



49-2666



33-1201



33-1202



33-1203



33-1206



33-1207

### Lamp Lenses for Tour Pack

• To be attached to the sides and tail of the Tour Pack.

Side Lens	
33-1201	Red
33-1202	Smoked
33-1203	Clear
Tail Lens	
33-1206	Red
33-1207	Smoked
33-1208	Clear

### Touring Pack

VT No.	Item
49-2746	Top and Bottom Set
49-2665	Bottom
49-2666	Top
49-2744	Hardware Kit
15-0583	Gasket
49-2747	Trim Kit, Chrome





## 50-2021 Contour Fender Racks

- Feature steel construction for use with solo seats for loads of 10 pounds or less.

VT No.	Year	Model	Rack Size
50-2021	1998-up	FLHR	11" x 6"

49-0304



49-0951



49-0832

49-0304 Installed



49-0832 Installed



## Old Style Luggage Rack

- Replica of 1940's accessory, contours all rear fenders 1934-up.
- Great for attaching thro-over saddlebags.
- Does not interfere with post mounted buddy or police

VT No.	Finish
49-0304	Polished Replica
49-0951	Chrome Replica
49-0832	Black Replica
37-2096	Chrome Screws, 4 pack, 5/16"-24 oval head slotted



50-1138



50-1526



50-1558



50-1559



31-1304



50-1512



31-1315

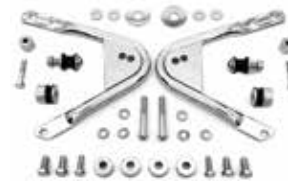

50-1513

## Detachable Solo Luggage Rack

- Order hardware separately.

VT No.	Item
50-1138	Rack, OE, FLHT, FLHX, FLHR 1997-2008
50-0723	Rack, Radian, FLT 1996-2008
50-1526	Docking Hardware, OEM 53803-06
50-1513	Docking Hardware, OEM 53804-06
50-1558	Rotary Latch Kit, chrome, OEM 12600036
50-1559	Rotary Latch Kit, black, OEM 12600036
31-1304	Bushing Set (2), wide style, rubber between chrome ends, FL 1996-up
50-1512	Stainless Steel Bushing Set (4), FLT 1996-up
31-1315	Bushing Set (2), rubber installed between chrome ends, FL 1996-up



50-2074



50-2075

## Retro Luggage Rack

- Fits FLHR with solo seat.

VT No.	Year
50-2074	1998-up
50-2075	1989-97



## Air Deflectors

- Fit the mid frame section of Touring models below the rider seating area to direct engine heat away
- Does not fit 2001-07 with adjustable rider backrest

VT No.	Year
50-0101	2001-08
50-0304	2009-up



50-1523



50-1185

## Chrome Luggage Racks for Tour Paks

VT No.	Style	Fits
50-1523	Standard	All King and Chopped lids.
50-1185	Stealth	FLHR 2008-up King, Chopped, Razor lids



## Chrome Streamlined Luggage Rack

- Flows with the long and lean lines of your ride.
- The rails and arched fender support with hidden hardware gives the appearance of a floating rack design.

VT No.	Fits
50-0679	FLHX 2006-08, FLHT 1999-05, FLHR 1999-08



50-0595



50-0596

## Chrome Luggage Racks.

VT No.	Fits	Year
50-0595	Side Car	1967-2011
50-0596	Tour Pack	1979-up



50-1523 Installed

**Note:** Racks are designed for loads of 10 pounds or less!



47-0835 Installed



47-0885



47-0886



47-0835

### Wyatt Gatling Saddle Solo Seat

• Frame mounted solo seat has Naugahyde covering.

VT No.	Fits
47-0885	1996-03 FLT
47-0886	1996-03 FLHR
47-0835	2008-14 FLT, Wyatt Gatling
31-1641	Back Rest Hardware



### Black Frame Cover

• Installed between the solo seat and the frame.

VT No.	Fits
42-0707	FLT 1997-up



50-0727



26-0872

**Passenger Seat Handrail** fits passenger seat area and mounts as stock. OEM No. 52400090.

VT No.	Finish
50-0727	Chrome
50-0728	Black
26-0872	Seat Handrail Cover Set



31-0611



31-0943

### Chrome Seat Handrails

• Fit behind driver seat area and mount as stock.

VT No.	Fits
31-0611	FLT 1999-2005
31-0943	FLT 2009-up Except FLHTCU & TG



31-9052



31-9052

42-0708



### Solo Seat Mount Kits

• Include "Tee" bracket, 2" springs and strut bars for rigid mounting.  
 • VT No. 32-9052 utilizes a center spacer for spring. Kits accept standard size police solos such as VT No. 47-0226. Bracket. VT No. 31-0177 required to mount buddy seats on these kits which is not included

VT No.	Year	Item
31-9052	1997-07	Kit
42-0708	1997-07	Black Cover





### Passenger Pillion Pad.

VT No.	Item
31-9901	Driver Backrest Mounting Kit
31-9902	Driver Backrest Mounting Kit
47-0004	Driver Backrest 52914-09A
47-0005	Passenger Pillion Pad 52000133
47-0006	Passenger Pillion Pad 51770-09



### Sissy Bar Inserts

- Featuring brass and chrome finishes as noted.
- Inserts mount with screws to cross bar.

VT No.	Style
50-0820	Chrome Maltese
42-0045	Brass Skull "Live to Ride"
42-0156	Brass Eagle "Live to Ride"



### Chrome Sissy Bar Luggage Rack

- Uniquely designed for easy installation

VT No.	Fits
50-1011	Custom application for 16" sissy bars



### Flatlander Mini Seat Pad Back Rest

- Measures 5½" wide x 3" tall x 1½" thick.

VT No.	Fits
47-0753	All models with a short sissy bar



### Pillow Passenger Pad

- 13" tall and fits stock seat rails on 1977-85 FLH-FLT-FLHT.
- Available in pillow style Naugahyde to match factory style seats.
- Includes bushings and washers.

VT No. 47-8654



### Side Bar Side Strap and Back.

Order top and straps separately.

Fitment	16" Back	11" Back	Sissy Bar Handrail	Width
1997-08 FLHR	50-0811	50-0815	50-0819	8¾"
2009-up FLHR	50-0811	50-0815	50-0819	8¾"
Round		50-0322		8¾"



### Sissy Bar Side Plates, Detachable Sissy Bar & Docking Hardware

- Use with 8¾" outside width sissy bar uprights

VT No.	Fits
50-1557	FLHR, FLTR, FLHX 2009-up, non-detachable
50-1556	FLHR, FLTR, FLHX 1997-2008, non-detachable
50-0031*	Standard Height Detachable Sissy Bar
50-0032*	Short Detachable Sissy Bar
50-0033	4 Point Docking Hardware, 2014-up, Chrome
50-0034	4 Point Docking Hardware, 2014-up, Black
50-2007	4 Point Docking Hardware, 2009-13

\*Note: Requires separate purchase of 51-0033 Docking Hardware



51-0420



51-0422



### Fairing Deflector Set.

VT No.	Color	Fits
51-0420	Dark Smoke	FLH 1996-2013, FLHX 1996-2013
51-0421	Dark Smoke	FLH 2014-up, FLHX 2014-up

### Mid-Frame Air Deflector Trim

• Adds a touch of chrome to the Mid-Frame Air Deflectors. These blend the look of chrome from the engine and help make the deflectors integrated with bike. Mounts to the frame below the seat for rider's comfort in the heat. The mounting hardware, the thumb screw, must be ordered separately. Fits 2009-up FLT and Trike models equipped with Mid-Frame Air Deflectors.

VT No. 51-0422



42-9999



42-9998

### Windshield Trim

• Four accent slots, includes stainless steel mounting hardware.

VT No.	Item	Finish
42-9999	1996-2013 FLH, FLHX	Polished
42-9998	1996-2013 FLH, FLHX	Stainless



42-9997



42-9996

**Inner Fairing Trim Kit** includes complete chrome trim for dressing all gauges, radio faceplate, and speakers, and a gloss black dash fascia. Easy to install with self-adhesive backing. Fits 2014-up FLHX, FLHT.

42-9997 Inner fairing trim kit 61400199

**Inner Fairing Trim Kit** includes complete chrome trim for dressing all gauges, radio faceplate, and speakers. Easy to install with self-adhesive backing. Fits 2015-up FLTR.

42-9996 Inner fairing trim kit 61400296



50-0010



50-0012



49-0736



49-0737

### Chrome Deep Cut Inner Fairing Speaker Grill Set

VT No.	Fits	Type
50-0010	FLT 2000-2013	Deep Cut
50-0012	FLT 2000-2013	Chrome with black skull
50-0736	FLT 2014-up	Chrome with black skull
49-0736	FLT 1996-2013	Chrome
49-0737	FLT 2014-up	Chrome



51-0050



51-0051



51-0052



51-0053

### Fairing Support Bar

VT No.	Fits	Type
51-0050	FLTRX 2010-2013	Chrome
51-0051	FLTR 2009	Chrome
51-0052	FLTR 2004-2008	Chrome
51-0053	FLTR 1996-2003	Chrome



51-0302

### Heavy Duty Windshields

• By National Cycle are wide frame windshields for bikes with widely spaced forks.

VT No.	Tint	Height Range	Fits
51-0242	Light	20" to 21½"	FLHS 1993-up
51-0302	Light	14½" to 15¾"	FLH 1977-1993



### 1980-92 FLT Headlamp & Spotlamp Kit

• Includes chrome ABS headlamp housing, 7" round lamp unit and complete spotlamp kit and turn signals.

VT No.	Item
33-0540	Kit
51-0242	Windshield
31-0438	Bracket for Shield
33-2036	Spotlamp Kit



49-0826



49-0819

### Air Duct Bezel.

VT No.	Finish	Years
49-0826	Chrome	2014-up <b>Note:</b> Tear off tape installation
49-0819	Black	2014-up <b>Note:</b> Tear off tap installation



50-0279

50-0278

### Heavy Duty Inner and Outer Fairing Support Bracket Set.

• Made with thicker grade steel to eliminate breaking, which is a problem on all Touring models.  
 • Each set has one left hand and one right hand support bracket included. Note: Hardware is not included. Fits all 1996-2013 FLHT and FLH models.

VT No.	Type
50-0278	Inner Support
50-0279	Outer Support



51-0328



51-0329



51-0304



51-0305



51-0327



51-0350

### Replacement Windshield Screen

• For models with fairings, height and tint as noted.

VT No.	Style	Height	Fits
51-0328	Tinted	14"	FLT 1996-2009
51-0329	Smoked	10"	FLT 1996-2009
51-0304	Clear	12"	FLHT 1986-1995
51-0305	Tinted	6"	FLHT 1986-1995
51-0327	Clear	Stock	FLHT 1996-2009
51-0350	Clear	Stock	FLHR 1997-2007



### Replacement Windshield Window

• Fits National windshields.

VT No.	Fits
51-0311	FLHS 1993-up Clear
51-0308	FLHS 1993-up Blue
51-0309	FLHS 1993-up Black



### Chrome FLST Windshield Bracket Kit

• Replaces OEM 57951-92 for 1986-up FLST, 1987-up FLSTF and 1988-up FXSTS.

VT No. 31-0437





# Windshield

## Chrome Fairing Support Bracket Set

- Mounts to fairing with stock hardware and features mounting holes for turn signal relocation if desired. **VT No. 31-0752**



50-1008

## Chrome Windshield Deflector Set

- Mount onto fork brackets.

VT No.	Fits
50-1008	FLHT 1985-13, FLT 1985-13, FLHR 1985-13

## Chrome Tie Down Brackets

- Mount to the front fork cover and provide a secure point to attach tie downs.

**VT No. 31-0025**



42-9960



42-9995

## Chrome Lower Fairing Trim

- Perfectly formed to cover cracked or peeling decals.

VT No	Year
42-9960	FLT 1986-95
42-9995	FLT 1996-13

## Chrome Windshield Mounting Bracket Kit

- Replaces 58069-93 right and left brackets to fit 1987-92 FLHS and 1983-92 FLHTC. Hardware included. **VT No. 31-0458**

31-0458



31-0438

## Chrome Windshield Bracket Kit.

- For use with a chopped style windshield

VT No.	Fits
31-0438	FLHS 1977-84



51-0751



50-0752



33-172

## Fairing Shell Only

VT No.	Item
51-0751	Shell Only, FLHT, 1996-13
50-0752	Shell Only, FLHT, 2014-up
34-0049	Mirror Block Plate Chrome
34-0052	Mirror Block Plate Black
33-1722	FLT vent trim kit includes door, clip & gasket. 2016-up



## FLT Upper Fair Bracket Repair Kit

- Repairs both left and right upper fairing bracket without removal of upper bracket from motorcycle. Kit includes left and right brackets and hardware.

**VT No. 31-0344**



50-0616

## Fairing Support Bar Kit

- The lower fairing support brackets when the engine bar is removed. Includes mounting hardware.

VT No.	OEM	Fits
50-0616	47200278	2015-up FLHR Chrome
50-0617	47200278	2015-up FLHR Black



### National Cycle Wave QR Windshield

• Manufactured from dark tint polycarbonate that features free flowing lines, adjustable rake partitioning and quick release mounting. Order mounting hardware separately.

• 10.50" (26.7cm) 18.00" (45.7cm)

\*Note: Will not work with spotlight bar

VT No.	Fits
51-0281	1994-16 FLHR Road King
51-0281	1998-14 FLHRC Road King Classic
51-0281	2004-07 FLHRS Road King Custom
31-9946	Mounting Hardware

51-0417



### FLHR Replacement Polycarbonate Shield

• Features pre-drilled mounting holes for use with stock mounting hardware and is 33% thicker than original windshield Available 13¾" tall dark tint. Fits 1994-up FLHR.

VT No.	Height	Color
51-0417	13¾"	Dark Tint

51-0426



51-0425



### 12" Wind Splitter Windshield

• A great look for all Touring models and is shaped for the perfect combination of effective air flow management and style. The sweeping design complements the shape of the fairing and the inner dash panel and adds height over a traditional low-profile wind-deflector in the center where it counts. The shape decreases wind noise and improves the ability to hear the motorcycle's sound system.

VT No.	Fits
51-0425	2015-up FLTR
51-0426	1998-2013 FLTR



### 10" Light Smoke Windshield

VT No.	OEM	Fits
51-0448	57400225	2014-up FLHX, FLHT
51-0449	58303-96	1996-2013 FLHX, FLHT



50-0423

### Clear Batwing Fairing Windshield

VT No.	OEM	Color	Fits
51-0423	57400227	Clear 10"	2014-up FLHT, FLHX
51-0424	58301-96	Clear 10"	1996-2013 FLHT, FLHX



## V-Stream Series Windshields

For FLHT 1996-13, FLHX 1996-13

51-0400	Clear	17"
51-0401	Clear	14"
51-0402	Dark	10¾"
51-0404	Light	10¾"
51-0403	Dark	7¼"

For FLTR 1998-2013

51-0405	Clear	18"
51-0406	Clear	15¼"
51-0407	Dark	9¼"
51-0408	Clear	9¼"

For FLT 1989-1996

51-0411	Clear	15¾"
---------	-------	------

For FLHT 2014-up Electra Glide/Tri Glide and FLHX (Street Glide)

51-0413	Light Tint	9.6"
51-0414	Light Tint	7.6"
51-0415	Dark Tint	7.6"



51-0400



51-0401



51-0404



51-0402



51-0403

The typical airflow pattern of the wake from most windscreens is called a van Karman vortex. At speeds of 50-90 mph, the air swirls off the windscreen in an approximate 90-degree segment of rotation, hits the bottom of the rider's neck on the way up, and curves off the shoulder at approximately 45 degrees.

The patented "V" shape is so quiet because it pushes this vortex out and away from the side of the rider's head. The rider's helmet then resides in still air, and the passenger's environment is greatly improved as well.

Reduced wind noise... less turbulence... superior strength... perfect style. The VStream revolution is here!



51-0405



51-0407



51-0408



51-0411

**National Cycle Wave Windscreens** offer riders a custom look for baggers. Wave windscreens are Quantum Hardcoated polycarbonate for unbeatable scratch resistance and impact strength. Available in clear, light tint and dark tint.

## Wave Series Windscreen.

For FLT 1996-2013, FLHX 1996-2013

VT No.	Tint	Height
51-0450	Dark	5¼"
51-0452	Light	7¾"
51-0454	Clear	10"

For FLTR 1998-2013

51-0451	Dark	5¼"
51-0453	Light	7¾"
51-0455	Clear	10"



51-0450



51-0452



51-0454



51-0451



51-0453



51-0455





51-0351



51-0361

51-0356

31-9946



### National Cycle Switchblade Removable Windshield

- Allows installation or removal in four seconds without tools.
- Available in three sizes for three styles of riding and features 4.0 mm Lexan Polycarbonate with quantum coating in either clean or tint.
- Also features a key lock for "lock solid" mounting.
- Order mounting system separately.

### SwitchBlade® Quick-Release Windshields Applications

#### HARLEY-DAVIDSON®

Model Name	Year	Mount Kit	2-up Clear	Chopped Clear	Chopped Tint
<b>FLH MODELS</b> (With/Without Light Bar Installed)					
FLHR Road King	1994-16	31-9946	51-0351	51-0356	51-0361
FLHRC Road King Classic	1996-13	31-9946	51-0351	51-0356	51-0361
FLHRS Road King Custom	2004-07	31-9946	51-0351	51-0356	51-0361



51-0286



51-0284



51-0285

### National Cycle Spartan Quick Release Windshield

- Features a full size quantum clear hand coated polycarbonate windshield, quick release hardware and a black powder coated mounting frame.

- Available in 16¼" and 18½" heights. Height is measured from head lamp cutout to top of shield.

VT No.	Height	Fits	Mt Hardware
51-0284	16¼"	1986-up FLST	31-9939
51-0285	16¼"	2006-up FXD	31-9947
51-0286	18½"	1986-up FLST	31-9939*
51-0287	18½"	2006-up FXD	31-9938

\*Note: When installing shield with spotlight bar use 31-9938 kit

51-0447



51-0447  
Installed



### Screens for Windshields

- Dark Smoke Tint
- Fit 1996-up
- Batwing Style

VT No.	OEM	Fits	Height	Style
51-0440	57185-05	1996-13 FLHT, FLHX	7"	Deflector
51-0441	57400205	2014-up FLHT, FLHX	7"	Splitter
51-0442	57400243	2014-up FLHT, FLHX	5"	Deflector
51-0443	57400091	1996-13 FLHT, FLHX	4.5"	Splitter
51-0444	57400204	2014-up FLHT, FLHX	4.5"	Splitter
51-0445	58207-04	1996-13 FLHT, FLHX	4"	Splitter
51-0446	57400229	2014-up FLHT, FLHX	7"	Deflector
51-0447	57164-10	1996-13 FLHT, FLHX	7"	Deflector



### Lightly Tinted Heavy Duty Windshield

- A wide frame windshield for bikes with widely spaced forks. Windshield offers plenty of height and width for larger riders. The height is adjustable and ranges from 20"-21½". The classic look enhances the front end of your bike. Mounting hardware is required and sold separately. \*\*Note: D.O.T. approved.

VT No.	Fits
51-0364	1993-up FLT.



43-0534



43-0515



8916-17T



### Chrome Primary Cover Screw Kits

• Include all necessary screws and washers.

VT No.	Head Style	Fits
9959-38	Knurled	FLT 1999-2006
9959-38T	Knurled	FLT 1999-2006
8916-17	Allen	FLT 1985-1999
8916-17T	Allen	FLT 1985-1999



#### Lower Only

9859-20	1989-99	FLT	Chrome
9928-20	1989-99	FLT	Allen
9928-20-P	1989-99	FLT	Polished Allen
<b>Trans to Motor Mount FLT</b>			
9935-8-P	1999-up	FLT	Polished Allen



43-0514

### Chrome Engine Dress Up Kits

• Include chrome parts and hardware for installation.

VT No.	Fits
43-0534	FLT 2001-2006 TC-88
42-0692	FLT 1999-2000 TC-88
43-0528	FLT 1994-1998
43-0515	FLT 1987-1988
43-0514	FLT 1985-1986



37-9185



37-9186

### Chrome Allen Screw Kit

• Connects motor mounts, front, top and rear to frame on models listed below. Knurled.

VT No.	Fits
37-9185	1987-90 FLT
37-9186	1991-07 FLT



### Starter Motor Chrome Cover

• For 2009-16 models.  
• Conceals starter motor and solenoid for a cleaner look.

VT No. 42-0185

42-1167



42-1168



### Starter Motor End Cover

• Dresses the end of the starter motor for a clean look on all 2017-up FLT models. Available with chrome or gloss black.

Black	Chrome
42-1167	42-1168





43-0883



43-0276



43-0560



43-0232



43-0209



43-0374



43-0248



### Chrome Outer Primary Cover Only

- With machined components installed.
- Order screws, gaskets, and other hardware separately.

VT No.	Fits
43-0885	FLT 2016-up
43-0883	FLT 2007-2016
43-0276	FLT 1999-2006
43-0248	FLT 1999-2006, Accepts a 5-hole derby
43-0560	FLT 1994-1998
43-0232	FLT 1989-1993
43-0209	FLT 1985-1988
43-0374	FLT 2007-15, Flat Black Finish

43-0885



43-0886



### Narrow Profile Outer Primary Cover

• 1" narrower than the stock outer primary that will allow easier reach to the ground and is shaped to slim the bike profile on the left side. Stock replacement for all 2015-up FLT models but can be used on all 2007-14 FLT models, but requires the purchase of narrow type 2015-up derby cover and primary gasket service gasket kit.

Chrome	Black	Fits 1999-2006 FLT.
43-0885	43-0886	

### Narrow Profile Derby Covers.

VT No.	OEM	Style
42-1376	25700388	Air Flow
42-0183		Flame
42-0184		Skull, 2015-up
42-1377	25700477	Black Air Flow 2016-up
42-0223	25700388	Chrome 5 Hole Smooth
42-0224	25700477	Black Skull 2016-up

43-0294



42-0272



43-0267



### Chrome Outer Primary Cover Kits

- With or without derby covers
- Die cast stock replacement outer cover kit comes with chrome primary cover, chrome allen screws, outer cover starter bearing derby, inspection and outer cover gaskets included.

Without Derby	With Derby	Fits
43-0341		FLT 1989-1993
43-0249		FLT 1999-2006
43-0782	43-0294	FLT 2007-2015
	43-0265	FLT 1994-2006
43-0341	43-0267	FLT 1989-1993
43-0340	43-0272	FLT 1985-1988



42-1376



42-0223



42-0224





# Primary Derby Cover

TOURING



## 2016-up





Style	3-Hole 1979-98	5-Hole* 1999-15	5-Hole 2016-up**
V-Tech	42-0036		
3-D Spinner	42-0108		
Maltese Type	42-0991		
Red Baron		42-0990	
Iron Cross		42-0975	
Iron Cross Billet	42-6070	42-6025	
Maltese	42-0958	42-0959	
Cross		42-6026	
Cross Type	42-0579		
Eagle Spirit Chrome Inlay	42-0107	42-0950	42-0226
Eagle Spirit Gold Inlay	42-9944	42-0849	
Chrome Flame	42-0747	42-0922	
Chrome Raised Flame	42-0470	42-0466	
Black Raised Flame	42-0471	42-0467	
Lady Luck	42-1073	42-1074	
Chrome Ball Milled	42-1086	42-1088	
Chrome Contour	42-1087	42-1091	
Black Contour	42-1118		
Chrome Perforated	42-1090	42-1089	
Black Perforated		42-1120	
V-Twin Ventilated	42-0616		
Smooth Ring	42-7102	42-0120	
Smooth Flat Chrome		42-0124	
Smooth Dome	42-0605	42-0129	
Early Bird Style	42-9965		
Polished Finned	42-0102		
Black Finned	42-0632		
Raised Center Skull on Black	42-0181	42-1252	42-0228
<b>Note:</b> Raised center portion on skull medallion.			
Indented Ring Skull on Black		42-1269	42-0230
Bad Skull Chrome on Chrome	42-1257	42-1253	42-0229
Bad Skull Black on Chrome	42-1258	42-1254	
Domed Black Skull	42-7101	42-7100	
Black Mesh Skull	42-1061	42-1062	
Evil Skull Chrome on Black	42-0558	42-0559	
Evil Skull Chrome on Chrome	42-0091	42-0092	
Raised Skull Black on Chrome	42-0131	42-0132	
Big Skull Chrome on Black	42-0580	42-1081	
Bonehead Chrome	42-0578	42-1057	
Black Ball Milled Cover		42-1140	
Grooved, Chrome	42-1142	42-1141	
Grooved, Black	42-1150		
Grooved, Chrome		42-1144	
Grooved, Black		42-1145	
Air Flow Chrome	42-1379	42-1372	42-1376
Air Flow Black	42-1380	42-1373	42-1377
Nostalgic Chrome		42-1387	
Nostalgic Black		42-1388	
Smooth Dome Chrome	42-1029		
Finned Polished	42-0102		
Vented Chrome	42-0616		
Flame Chrome	42-1075		
Skull Black	42-1265		
Smooth Chrome	42-0194	42-0190	42-0223
Smooth Black	42-0195	42-0191	42-0224
Domed Skull Black	42-7100		
Domed Skull	42-7101		
Eagle Spirit Derby Black		42-0481	
Eagle Spirit Derby Black with chrome accents		42-7104	42-0225
Raised Center Skull and Chrome with Black Insert			42-0227

## Primary Derby Covers

- Order screw kits and gaskets separately.
- \*Note: These fit 1999-up FXST, FLST, FXST, 1999-15 FLT.
- \*\*Fits 2016-up FLT only but can be used with 2007-up if equipped with a narrow profile primary cover



42-0817



42-1226



42-1225

## Chrome Derby and Inspection Oval Sets

- For primary covers.

VT No.	Style	Fits
42-0817	Flame	FLT 1979-1998
42-1226	V-Twin Vented	FLT 1979-1998
42-1225	Billet Vented	FLT 1979-1998



42-0740



42-0944

## Chrome Primary Inspection Covers

VT No.	Style	Fits
42-0740	Smooth	FLT 1985-2006
42-0944	Flame	FLT 1985-2006





42-0111



42-0118



42-0111 Installed

### Chrome Nose Cone Cam Trim

• Fit over stock cam cases on Big Twins.

No need to remove the cam case or disturb the cam or gears.

VT No.	Fits
42-0118	1993-1998 FLT
10-0286	1993-1999 FLT
42-0111	1979-1992 FLT
42-0121	1999-2016 TC-88

42-0702



10-0813



42-1054

### Cam Cover

VT No.	Fits	Item
42-0702	2001-2016	Chrome
10-0813	1999-2000	Chrome
42-1054	2001-2016	Black



10-1298



10-0088



10-0297 Installed



10-0297



10-0040



10-0080

**Nose Cone Gear Cover** fit Big Twin models. Bushings installed. Seal included.

VT No.	Years	Finish
10-1298*	1973-93	Black
10-0088*	1973-92	Polished
10-0040*	1973-92	Chrome
10-0111*	1973-92	Chrome
10-0297	1993-99	Black
10-0080	1993-99	Chrome
10-0040*	1973-92	Chrome
10-0111	1973-92	Chrome
10-0798	1993-99	Chrome

\*Note: Comes with mounting screws, gasket and seal.



9946-20



9819-12



8761-7



7402-7

### Cam Cover Mount Kit

VT No.	Head Style	Fits
9946-20	Stock	FLT 1999-2016
9946-20-P	Polished	FLT 1999-2016
9819-12	Allen	FLT 1993-1999
8761-7	Allen	FLT 1984-1992
9305-7	Stock	FLT 1979-1992
7402-7	Acorn	FLT 1979-1992





11-0938  
Installed

11-0938



11-0376



11-0909



### Chrome Pushrod Cover Kits

- Include tubes and all seals for complete installation.

VT No.	Style	Fits
11-0938	Stock	FLT 1999-2016
11-0376	Black	FLT 1999-2016
11-0943	Billet	FLT 1999-2016
11-1090	Titanium	FLT 1984-98
11-1081	Titanium	FLT 1999-up
11-0909	Stock	FLT 1984-1998
11-0947	Billet	FLT 1984-1998
11-0945	Curved	FLT 1984-1998



### Chrome Billet Pushrod Cover & Tappet Base Kit

VT No.	Fits
42-0937	FLT 1999-2016



### Chrome Pushrod and Tappet Trim Set

- Covers as a complete dress up kit for Big Twin models.

VT No.	Fits
42-0903	FLT 1984-1998



37-9078



37-9079



37-9078



11-1073

### Pushrod Cover Cup Sets

- Feature die-cast construction in chrome or gold, set of four.

VT No.	Finish	Style	Fits
37-9078	Chrome	Skull	FLT 1979-up
37-9079	Gold	Skull	FLT 1979-up
11-1073	Brass	Hex	FL 1941-1984

### Titanium Plated Pushrod Cover Kit

VT No.	Fits
11-1213	1999-up TC-88
11-1212	2017-up M-8





10-0811



10-0815

### Chrome Tappet Block Set

• Accepts standard sized tappet assembly in varied styles as noted. Sets include gaskets, \*except for 11-9506. Hardware sold separately.

VT No.	Style	Fits
10-0811	Stock	FLT 1999-2016
10-0815	Billet	FLT 1999-2016
11-9506*	Stock	FLT 1984-1998



42-0437



42-0437 Installed



42-0458

### Chrome Tappet Cover Trim Set

• Fits over stock blocks. Each cover has a slot which allows it to be installed without removing pushrods.

VT No.	Type	Fits
42-0437	Steel	FLT 1984-1998
42-0458	Die Cast	FLT 1984-1998



42-0929

### Chrome Head and Spark Plug Cover

• Held in place by rubber inserts which are supplied in kit.

VT No.	Fits
42-0929	FLT 1986-1990

### Hardware for Tappet Blocks

• For the installation of our tappet block sets.

VT No.	Style	Fits
9942-16	Chrome Allen	FLT 1999-2016
7628-8	Chrome Acorn	FLT 1979-1998
8726-8	Chrome Allen	FLT 1979-1998
8708-8	Chrome Stock	FLT 1979-1998
8710-8	Black Stock	FLT 1979-1998
15-1542	Gasket for 11-9506	FLT 1979-1998



42-0746

### Chrome Big Twin Engine Case Trim

• Mounts to center case stud.

VT No.	Fits
42-0746	FLT 1984-1998



### Chrome Rear Engine Cover.

VT No.	Fits
61-0134	1987-1995 FLT





11-2700



11-2701



15-1502

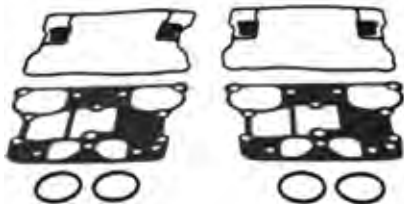

15-1503

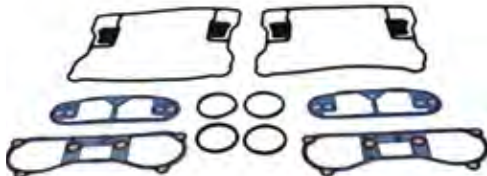

16-1673



### Chrome Rocker Box Set

- Includes two upper and two lower for two heads.
- Machined internally for rocker supports.

VT No.	Item	Fits
11-2700	Rocker Box Set	FLT 1999-2016
11-2701	Rocker Box Set	FLT 1984-1998
<b>Gaskets and Tool to Match</b>		
15-1502	Gasket	FLT 1999-2016
15-1503	Gasket	FLT 1984-1998
16-1673	Wrench Tool	FLT 1984-1998

42-0787



42-0754



### Chrome Rocker Box Cover Set

- Precision die cast and machined. The six piece set includes all necessary gaskets for installation for both heads.

VT No.	Fits
42-0787	FLT 1992-1999
42-0754	FLT 1984-1991

37-0585



11-0621



8868-16

### Hardware for Rocker Box Set

- Screw kits and cover kits are chrome finished. 37-0820 includes sealing washer with built in o-ring for position seal.

VT No.	Item	Fits
37-0585	Grooved Screw Cover Set	FLT 1999-2016
37-0043	Allen Rocker Box Screw Set	FLT 1999-2016
8868-16	Acorn Rocker Box Screw Set	FLT 1984-1998
8931-16	Allen Rocker Box Screw Set	FLT 1984-1998
37-0820	Rocker Box Collar and Screw Kit	FLT 1984-1998
15-0663	Red Fiber Washer Seal, 50 Pack	FLT 1984-1998
15-0221	Valve Cover Gasket	FLT 1984-1998
11-0621	Lower Cover Screw Set	FLT 1984-1998
2078-18	Lower Cover Screw Set	FLT 1984-1998



27-0941 Installed

27-0945



27-0941



### Chrome Lower Rear Belt Guard

- Belt drive models with 70 tooth rear pulley. **\*Note:** 27-1727 covers the existing plastic original lower belt guard.

VT No.	Fits
27-0941	FLT 2009-up
27-0945	FLT 1993-2001
27-1727*	FLT 1997-2008





11-0352

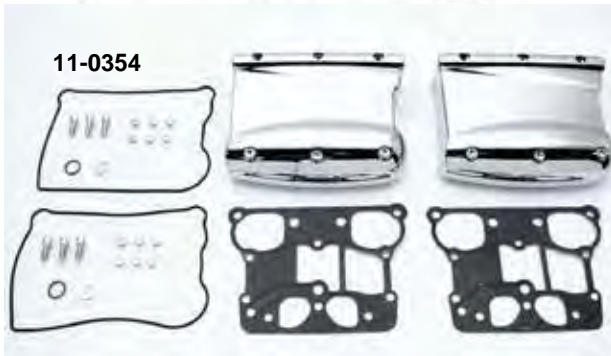

11-0354

### Top Rocker Box Sets from Radii

VT No.	Style	Fits
11-0352	Smooth	FLT 1999-2016
11-0354	Contoured	FLT 1999-2016



37-8799



37-9131



2024-4



2262-4



42-1092



37-8897

### Head Bolt Cover Sets

• Include four covers to conceal head bolts.

VT No.	Style	Fits
37-8799	Chrome Cylinder	FLT 1986-1998
37-9131	Chrome Grooved Cylinder	FLT 1986-1998
2024-4	Hex Chrome Dome	FLT 1986-1998
2262-4	Chrome Spike	FLT 1986-1998
42-1092	Solid Brass	FLT 1984-1998
37-8897	Chrome Dome	FLT 1984-1985

11-0946



11-0948



### Chrome Rocker Box Sets

• Includes 2 upper covers and 2 lower housings.

VT No.	Item	Fits
11-0946	Top Covers and Lower Housings	FLT 1999-2016
11-0948	Top Covers Only	FLT 1999-2016

43-9178



### Chrome Top Rocker Box Cover & D-Ring Set

• Order gaskets and screws separately.

VT No.	Year
43-9178	1984-91
43-0377	1992-99



42-1152



42-1153



42-1154

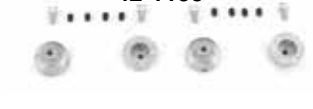

42-1155



42-1159

### Finned Head Bolt Bridge.

• Bolts on!

	Silver	Black	Model
	42-1152	42-1153	EFI
	42-1154	42-1155	Carb
	Chrome		
	42-1159	—	EFI



## Ignition Points Covers

- 2-hole covers fit FLT 1979-1998.
- 5-hole covers fit FLT 1999-up.

Style	2-Hole	5-Hole
Black Mesh Skull	42-0464	42-0461
Black Mesh Flame	42-0465	42-0462
Chrome Flame	42-0748	42-0969
Chrome Eagle Spirit	42-0106	42-0889
Gold Eagle Spirit	42-0088	42-0836
Chrome Red Baron	42-0177	42-0178
V Tech	42-0035	42-0146
Domed	42-0299	42-0119
Flat	42-0662	
Skull	42-1058	42-1059
Skull	42-1078	42-1079
Flame	42-0065	
Smooth	42-0155	42-0125
Maltese Flat	42-0960	42-0044
Maltese Raised		42-0961
Maltese Raised	42-6100	42-6055
Skull Face	42-0081	42-0075
Black Skull	42-0560	42-0562
Skull		42-1082
Skull	42-1176	42-1178
Skull		42-1259
Skull Black		42-1260
Black Domed	42-1116	
Black Perforated	42-1125	42-1119
Black Flame	42-1122	
Black Ball Milled		42-1123
Chrome Perforated		42-1093
Chrome Contour		42-1094
Chrome Ball Milled	42-1095	42-1096
Skull Design	42-0581	
Chrome Flame	42-0474	42-0472
Black Flame	42-0475	42-0473
Hidden Screws	42-0956	42-0957
Iron Cross Spinner	42-0162	
Smooth Black	42-0189	42-0197
Smooth Chrome	42-0198	42-0196
Grooved Chrome	42-1148	42-1144
Grooved Black	42-1166	42-1145
Chrome Hidden Mount	42-0956	42-0957
Chrome Air Flow	42-1383	42-1381
Black Air Flow	42-1384	42-1382
Chrome Nostalgic		42-1389
Black Nostalgic		42-1390

## Hardware for Points Covers

- Screw kits for points covers with head styles as noted

VT No.	Style	Fits
8765-2	Allen	FLT 1979-1998
8402-2	Acorn	FLT 1979-1998

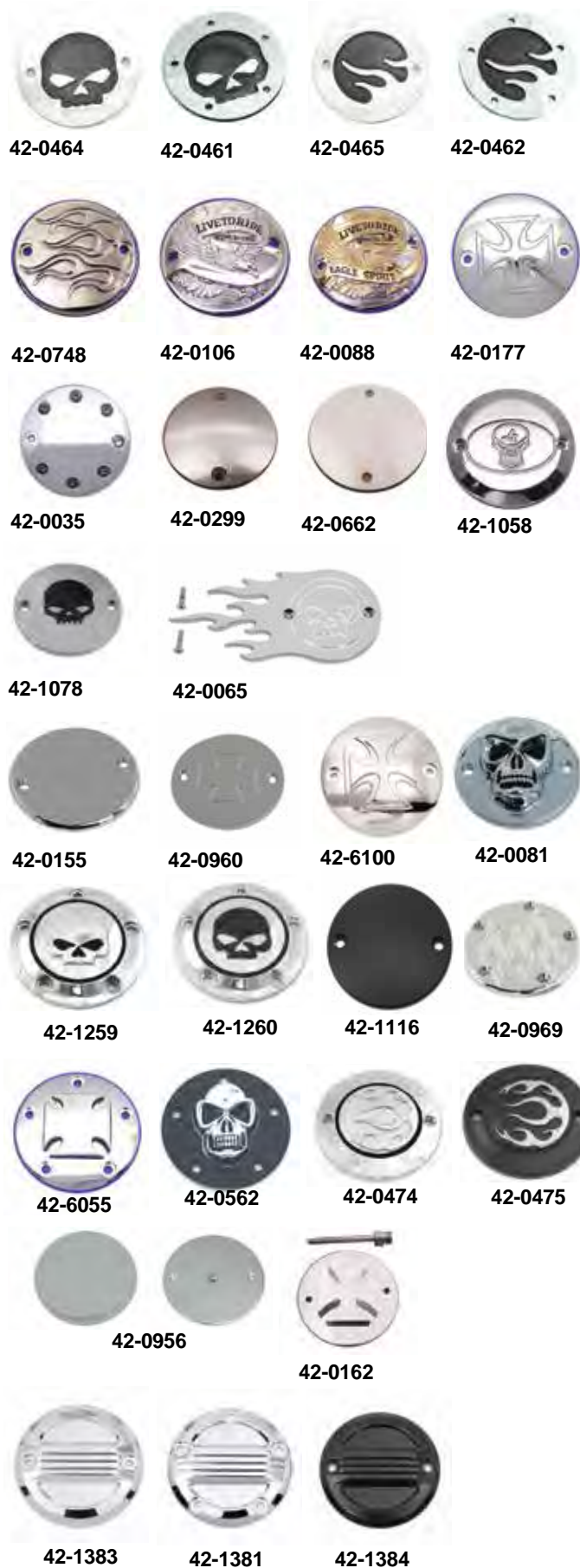



43-0790

## Chrome Trans Side & Top Cover Set

• Complete with top cover, side cover, chrome allen screws and chrome allen oil dipstick.

VT No.	Fits
43-0792	FLT 2000-2006
43-0790	FLT 1987-1999



43-0504

43-9136

43-9111

## Chrome Transmission Top Cover

VT No.	Fits
43-0504	FLT 2000-2006
43-9136	FLT 1987-1999
43-9111	FLT 1979-1986



## Clutch Release Kit

• Inner and outer ramps, 3/8" balls, retaining ring, cable coupling, and cover gasket.

VT No.	Fits
18-3212	FLT 1987-1999
18-3268	FLT 2000-up



43-0787



43-0789



43-0537



43-9131

## Chrome Transmission Cover

VT No.	Fits
43-0787	FLT 2007-up
43-0537	FLT 1999-2006
43-0789	FLT 1987-1999
43-9131	FLT 1987-1999, FLHR 1998

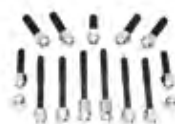

## Hardware for Transmission Covers

VT No.	Head Style	Fits
8912-13	Acorn	FLT 1987-2006, FLHR 1998
8912-13-P	As Above	Polished
8908-15	Allen	FLT 1980-1986 5-speed
8404-27	Acorn	FLT 1980-1985

### Gaskets for release covers.

15-1051	FLT 1987-2006, FLHR 1998
15-1050	FLT 1980-1986

## Chrome Hardware for Release Side Covers

VT No.	Head Style	Fits
9951-12	Acorn	FLT 1998-2006
9952-11	Allen	FLT 1998-2006
8907-5	Allen	FLT 1987-1999
8404-27	1980-85	Acorn
8906-5	1980-86	Allen
8907-5	1988-99	Allen
8907-5T	1988-99	Allen
8910-5	1987	Acorn
8911-5	1987	Cap
8922-5	1988-99	Cap
9952-11-P	2000-06	Chrome





### Chrome Transmission Dress Trim

- Fully covers end cover and inner door.

VT No.	Fits
42-0457	FLT 1987-1999



### Chrome Engine Dress Up Kit

- Includes chrome covers for oil filter housing, tappet blocks, and oil pump.

VT No.	Fits
42-0654	FLT 1992-1998



42-0794 Installed

### Chrome Top Oil Pump Cover

- Use for top replacement cover and includes mounting hardware.

VT No.	Fits
42-0794	FLT 1993-1995, FLHR 1993-1998



### Chrome Oil Pump Cover

- Mounts onto the existing bolts on Big Twin models.

VT No.	Fits
42-0530	FLT 1992-1998
42-0011	FLT 1979-1991



### Chrome Engine & Trans Interface Cover

- Designed to cover oil lines and cleans up the area in between the motor and transmission and still allows easy removal of dipstick. Fits 1999-2001.

VT No.	Fits
42-0698	

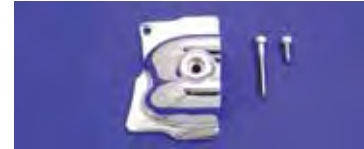

### Chrome Oil Hose Cover

- Includes all chrome plated mounting hardware

VT No.	Item	Year
42-0695	Oil Hose Cover	1999-06 FLHT
9949-6	Acorn Mounting Kit	
9949-6T	Acorn Mounting Kit	
9950-6	Allen Mounting Kit	
9950-6-P	Polished Allen Mounting Kit	



42-0887

### Chrome Oil Filler

- Spout fits 1993-06 FLT models. Replaces 62470-06.

VT No.	Fits
42-0887	



### Oil Filler Spout Cover

- Match the chrome transmission interface cover. Fits 1999-01 FLT.

VT No.	Fits
42-0824	



40-0673

17-1542

8405-2

8803-2

8804-2

40-0932

### Transmission Filler Plug with Dipstick

- All plugs are chrome except 8804-2 as noted.

VT No.	Head Style	Fits
40-0932	Allen	FLT 2007-up
17-0789	Allen	FLT 2007-up
40-0941	Knurl	FLT 2007-up
17-0958	Hex	FLT 2007-up
40-0673	Hex	FLT 2007-up
17-1542	Hex	FLT 1980-1986
8405-2	Acorn	FLT 1980-1986
8803-2	Cap	FLT 1980-1986
8804-2	Gold Cap	FLT 1980-1986



22-0905

23-0013

## Chrome Billet Forward Control Kit

• Bolt on for FLT models and includes a decorative plug for the shifter shaft hole. Related items also listed.

VT No.	Item	Fits
22-0905	Forward Control Set	Custom application
23-0013	Chrome Master Cylinder	FLT 1999-2007



42-0973



23-0768



23-0968

## Rear Master Cylinder Reservoir Cover

VT No.	Fits
23-0968	FLT 2008-up Rear
42-0973	FLT 2005-2007
23-0768	FLT 1999-2004
23-0770	FLT 1999-2004

A 23-9196



23-0954



B

23-1703



C

E



23-0874

## Complete Remote Mount Master Cylinders.

VT No.	#	OEM	Year	Fits
23-9266	A	41755-86	1986-91	FLT Chrome
23-0954	B	41755-92A	1992-94	FLT Black
23-0874	E	41708-08	2008-up	FLT Chrome
23-0874	E	41708-08	2008-14	FLT Chrome
23-1702	C	41755-95	1995-96	FLT Chrome
23-1703	C	41755-97	1997-98	FLT Chrome



## Police Style Shifter Control Kit

• Clamps to the left front lower neck tube saddle on touring models. Fits 1980-up FLT 5 Speed  
 • Saddle includes a smooth gate, and fits 1 1/4" diameter tube  
**VT No. 22-0736**



23-9317

23-0969

26-0179

23-0779

24-0604

23-0781

23-0782

## Front Master Cylinder Covers

VT No.	Style	Fits
23-9317	Smooth	FLT 2014-16 Clutch Side
23-9425	Smooth	FLT 2017-up Clutch Side
23-0969	Smooth	FLT 2008-up Brake Side
26-0179	Smooth	FLT 2005-2007 Front
23-0779	Smooth	FLT 1996-2005
24-0604	Smooth	FLT 1996-2004
23-0781	Billet Milled	FLT 1996-2004
23-0782	Flat	FLT 1995-2004
23-9426		FLHXXX 2017-up



## Chrome Shifter Rod Kit

• With swivel arms is 11" overall length.

VT No.	Includes Arms	Arm Length
21-2122	Yes	11"
21-2039	No	11"
21-0502	Yes	10½"



## Custom Shifter Rod.

• Swivel ends and studs built in.

VT No.	Style	Fits
21-0685	Chrome Flame	FLHR 1994-up
21-0991	Black Skull	FLHT 1999-2012
21-0992	Chrome Skull	FLHT 1999-2012
21-0852	Black Flame	FLT, FLHT, FLHR 1980-1998
21-0853	Black Flame	FLT, FLHT, FLHR, FLHX 1990-2010



## Custom Shifter Rod.

• Measured relative to stock length. For custom applications.

Style	Stock	+2"
Chrome Ball Milled	21-0286	21-0282
Black Ball Milled		21-0349
Black Agostinni	21-0342	21-0343
Chrome Drilled		21-0284
Black Ball Milled	21-0821	
Black Agostinni	21-0822	



## Custom Chrome Shifter Rod.

• Measurement includes threads or custom applications

Style	11"	12¼"	13¾"
Skull	21-0581	21-0582	
Flame	21-0555	21-0552	21-0544
Maltese	21-0556		
Skulls	21-0557	21-0554	
Goth	21-0560	21-0559	
Sword	21-0563	21-0562	21-0561
Lady Luck	21-0566		21-0564



## Chrome Shifter Maltese Rod Kit.

• With swivel arms is 11" overall length.

Rod measures 10¾" long and has an overall length including rod ends of 13¼".

VT No.	Fits
21-0680	Custom application





## Shifter Levers

• Styles as noted. \*Note: Two of VT No. 21-0072 are required for complete assembly.

VT No.	Style	Fits
21-0335	Center Balanced	FLT, FLHT 1986-up
21-0072*	Slotted	FLT 1983-up
21-0681	Offset Balanced	FLT 1986-up



## Chrome Stock Replacement Shift Levers

• With internal spline.

VT No.	Fits
21-2056	FLT 1983-1996, FLT 2000-up
21-2042	FLT 1982-1999

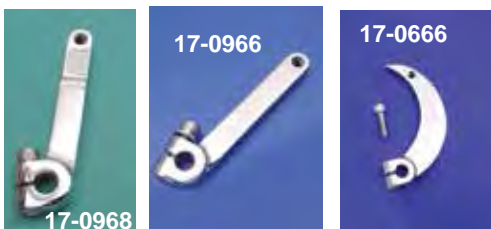

## Chrome Inner Shifter Levers

• Include a stainless steel allen screw and washer.

VT No.	Style	Fits
17-0968	Stock	6-Speed 2006-up FLT
17-0966	Stock	5-Speed 1980-06 FLT
17-0666	Sickle	5- or 6-Speed 1980-06 FLT



Stock



## Chrome Extended Shifter Lever

• Measures 9 $\frac{3}{4}$ " long for extended reach. Constructed of steel with chrome finish.

VT No.	Fits
21-0256	FLT 1986-up
21-0871	Set



## Chrome Lever

• Features a swivel footpeg mount slot to fold out of the way.

VT No.	Fits
21-0471	FLT, FLHT 1988-up

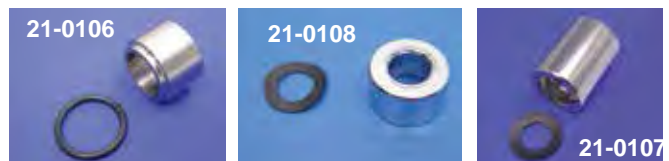

## Shifter Shaft Spacers

• For use with heel/toe shifters. 21-0107 is used to eliminate the heel shifter or for use on single shifter models.

VT No.	Item	Fits
21-0106	Short with Grease Elimination Spacer	FLT 1979-up
21-0108	Short with Anti-Rattle Washer	FLT 1979-up
21-0107	Long with Anti-Rattle Washer	FLT 1979-up



21-0389



21-0386  
Installed



21-0050 Installed



21-0386

**Billet Heel Toe Shifter Set.**

- Feature black or chrome finish with billet or without milled slots.

VT No.	Style	Fits
21-0386	Chrome Slotted	FLT, FLHT 1986-up
21-0389	Black Slotted	FLT, FLHT 1986-up
21-0050	Chrome	FLT 1986-up
21-0055	Black	FLT 1986-up



21-0050



**Greaseable Shifter Shaft with fitting.**

- Replaces OE shaft to send extra grease to bushing area for added lubrication.

VT No. 21-0580



21-0055



# Brake Pedal

23-0472

23-0472  
Adjustable

## Chrome Adjustable Forward Brake Pedal

- Allows multiple positions for riders comfort.

VT No.	Fits
--------	------

23-0472	1997-07 FLT
---------	-------------

23-0473	1997-07 FT, Center mount to end of pedal is 11"
---------	---

23-0402



## Chrome Forward Pedal

- Allow full use of footboard as pedal pad is moved to the edge of the board.
- Includes rubber pad.

VT No.	Fits
--------	------

23-0402	FLT 1997-07
---------	-------------



23-0477 Installed with pedal pad

23-0477



23-0061 Installed with pedal pad

23-0061



## Billet Pedals

Slot	Black	Smooth	Years
Chrome	Contrast	Chrome	
23-0937	23-0061	23-0057	FLT 2008-13
23-0062	23-0828	23-0059	FLT 2008-13
23-0830	23-0064	23-0058	FLT 2014-up
23-0477			FLT 1997-07
<b>Extended</b>			
23-0819			FLT 2008-13

Slotted 23-0244



Solid 23-0668



## Chrome Extended Brake Pedals

- Constructed of chrome steel with 2 1/4" extension.

VT No.	Style	Fits
23-0668	Solid	FLT 1997-2007
23-0244	Slotted	FLHT 1997-2007

23-0824



28-0761



28-0886



28-2252



28-2233

23-0824  
Installed

## Billet Brake Pedal Pad.

VT No.	Style	Fits
23-0824	Black Skull	FLT 1980-up
28-0761	Chrome Flame	FLT 1980-up
28-2252	Three Inserts	FLT 1980-up
28-2233	Stock Rubber	FLT 1983-up
28-0886	Stream Liner	FLT 1980-up

**Note:** Pedal pads feature die cast backing with black rubber insert pads.





### Chrome Rear Calipers

• Completely assembled with piston and seals but less mount brackets for exact stock replacement.

VT No.	Fits	Note
23-9055	1986-99 FLT	
23-0634	2002-07 FLT	Bracket
23-0987	2008-up FLT	
23-9038	1986-99 FLT	Caliper, black
23-0988	2008-up FLT	Bracket



### FLT

20-0599	2000-03	1.50	Chrome
20-0375	2000-03	1.50	18
20-0359	2004-06	1.125	Chrome



### Chrome Rear Disc Cover

• Bolts on for a secure installation.  
• Fits 1981-83 FLT-FLHT.

VT No. 42-0335



## Rear



### Chrome Caliper Kits

VT No.	Years
23-0815	2008-up
23-1101	2002-07
22-0372	1986-99
22-0365	1986-99, GMA, With stainless steel



**Chrome Caliper Mount Bolt Kits** mount through caliper to bracket.

VT No.	OEM	Type	Year
23-0140	44039-86	6 Point Rear	1987-99 FLT, Chrome
23-0125	44039-86	12 Point	Black, As Above

### Belts

23-0441



### Big Twin, 1½" Wide

Carlisle	BDL	# of Teeth	Fits
20-4010	20-0441	136	1984-96 FLT-FLHT
20-4018	20-0579	139	1997-03 All FLT

### Big Twin, 1⅜" Wide

20-0668 139 2004-06 FLT

### Big Twin, 1" Wide

20-4020	133	2007-08 FLT
20-4021	140	2009-up FLT



## Front



23-2226



23-0581



23-1712

### Front Caliper Set.

VT No.	Fits
23-2226	1984-99
23-0581	2000-07
23-1712	2008-up(Dual)



8792-5



9818-5



8847-5

### Chrome Rear Brake Disc Bolts.

Cast	1980-81	<b>8792-5</b>
Cast	1982-85	<b>8847-5</b>
Cast	1986-91	<b>9632-5</b>
Cast	1992-up	<b>9807-10</b>
Spoke	1997-up	<b>9818-5</b>

### Chrome Front Disc Brake Disc Bolts.

Cast	Dual	1982-85	<b>8847-5</b>
Cast	Dual	1980-81	<b>8792-5</b>
Cast	Single/Dual	1984-up	<b>8793-5</b>
Wire	Single/Dual	1984-up	<b>8793-5</b>



42-0706

### FLT-FLHT Chrome Brake Disc Covers

- Fit FLT with dual disc. Completely covers the front disc. Includes required spacers. Sold in pairs.

VT No.	Years	Type
42-0706	2000-up	Caliper Cover Set



23-1571

23-1570



### Front Caliper Adapter Brackets

- Allow the use of 13" floating brake disc on models listed by raising stock caliper. Brackets are a clear anodized finish.

VT No.	Item	Fits
23-1567	Bracket, Right	1986-99 FL
23-1568	Bracket, Left	1986-99 FL
23-1569	Bracket, Right	2000-up FLT
23-1570	Bracket, Left	2000-up FLT, FLST
23-1571	Front Brake Disc	For Above Stainless

### Chrome Brake Disc Bolts. See listing for applications.

#	Thread
8847-5	7/16 x 14 x 1 3/4
8792-5	7/16 x 14 x 1 1/4
9632-5	3/8 x 16 x 1
8793-5	5/16 x 18 x 7/8
9807-10	3/8 x 16 x 1
9818-5	3/8 x 16 x 1



## FLT Brake Pad Pin Kit

- Includes two pins & two retaining clips for stock type calipers only.
- Fits 2008-up FLHT, FLHR, FLHX and FLTR models.
- Includes pad set.
- Front Kit includes brake pads and pins for right and left caliper.
- Rear kit has one set of pads and pins.

VT No.	Fits
23-0975	Front
23-0976	Rear

**Dura Soft** designed to be compatible to all types of brake discs.

**Dura Ceramic** for general purpose use on carbon steel brake discs.

**Dura Semi Metallic** durable and have a reputation of excellent heat transfer for all types of brake discs.

**Dura Kevlar** provides excellent stopping on all types of brake discs.

**Dura Sintered** excellent stopping on all types of brake discs

**SBS Sintered** provides maximum stopping power with stainless steel discs.

**SBS Ceramic** for general purpose use on carbon steel brake discs

**SBS Carbon Tech** for use on all stock or aftermarket calipers and work well with stainless steel or cast iron discs.

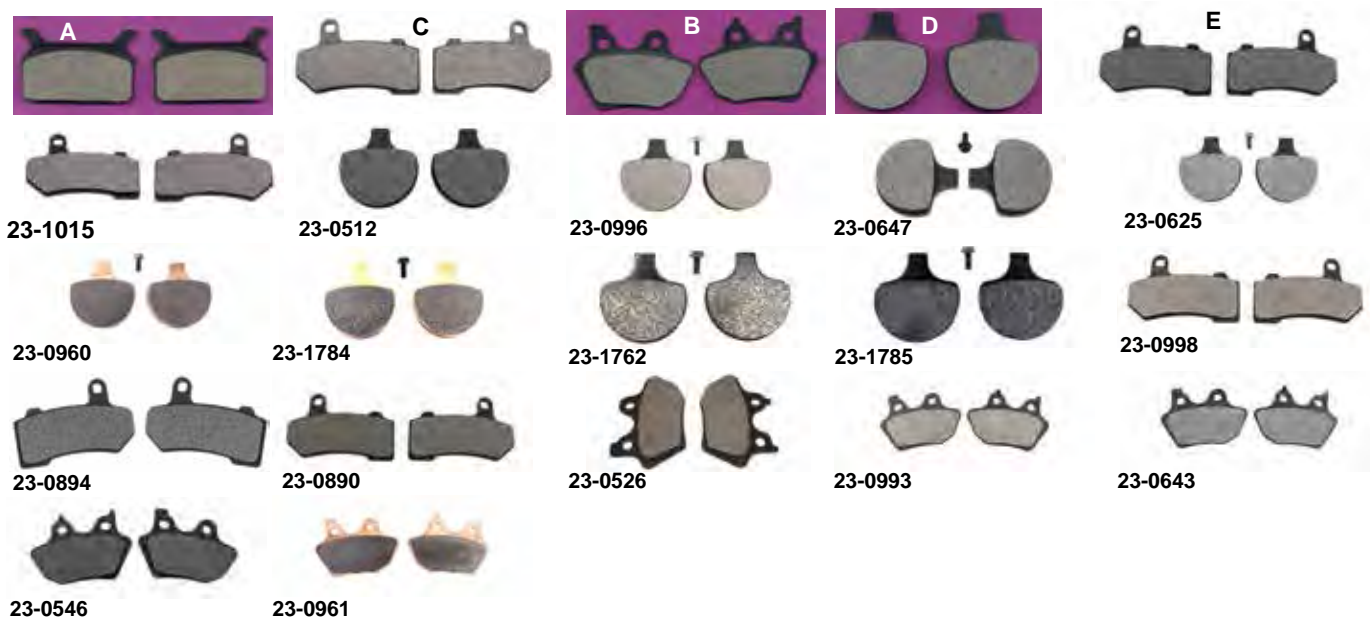

Fits	OEM	Dura Soft	Dura Ceramic	Dura Semi-Metallic	Dura Kevlar	Dura Sintered	SBS Sintered	SBS Ceramic	SBS Carbon Tech	Photo
<b>Rear Disc Pad Sets for Stock Type Calipers</b>										
1986-99 FLT	43957-86A	23-2282	23-0991	—	23-0627	23-0956	—	—	23-1777	A
2000-07 FLT	44082-00	23-0526	23-0993	23-0643	23-0546	23-0958	23-4559	23-1781	23-1782	B
2008-up FLT	41852-08	23-1015	23-0995	23-0894	23-0889	—	—	—	—	C
2009-13 Trike	83911-09B	—	—	—	23-0973	23-0980	—	—	—	
2014-up FLHT-CUTH with shim and spring	41300033				23-0001					
2014-up FLHTCUTH	41300033				23-0004					
2015-up FLHT, CUTG, FLRT	41300027				23-0002					
2015 XG	41300072				23-0005					
<b>Front Disc Pad Sets for Stock Type Calipers</b>										
1984-99 FLT,	44063-83	23-0512	23-0996	23-0647	23-0625	23-0960	23-1784	23-1762	23-1785	D
2000-07 FLT	44082-00	23-0526	23-0993	23-0643	23-0546	23-0961	23-4561	23-4560	23-1782	B
2008-up FLT	41854-08	—	23-0998	23-0894	23-0890	23-0909	—	—	—	E





11.5"



23-9048

Dura Disc		Russell		OEM	Bolt Kit	Fits
Polished	Standard	Polished	Standard			
<b>FRONT</b>						
23-0343	23-0334	23-9040	23-0319*	44136-84	8793-5 Cast 8794-10 Wire	1984-91 FLT
23-9206	23-0368	23-9040 1984-99	23-0319* 1984-99	44136-92	8793-5 Cast 8794-10 Wire	1992-99-FLT Cast or Wire Wheel
23-0467	—	—	—	44136-92	8793-5 Cast 8794-10 Wire	1992-99 FLT
23-0356	23-0379	23-9048	23-9049	44156-00	8793-5 Cast 8794-10 Wire	2000-up FLT Cast or Wire Wheel Left Side Brake Disc
23-0938	—	—	—			2014-up FLT

\*Note: Stainless

23-1040

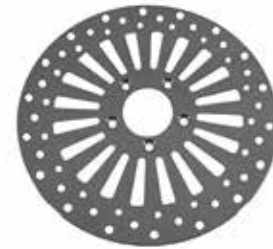

23-1540



### Wyatt Gatling Polished Spoke Disc.

20 Spoke	18 Spoke	Type	Year
23-0149	23-0679	Front	1984-99
23-0151*	23-1517*	Front	2000-07
—	23-1529	Front	2008-13

23-0906



23-0694



Front Brake Disc For Touring				U/M
23-1040	2008-13	Front (Pair)	Stainless	Set
23-1535	2008-13	Front	Polished Stainless	Each
23-1540	2008-13	Front	Stainless	Each
23-0906	2014-up	Front	Stainless	Set
23-0900	2014-up	Front	41500017	Set

### Front Dura Brake Disc.

• Vented swirl slots.

Polished			
VT No.	OEM	Type/Side	Model
23-0694	44156-00	Front, Left	FLT 2000-07
23-3774	44136-00	OE Styled	FLT 2000-07
Brushed Finish			
23-0535	44156-00	Front Left Custom	FLT 2000-07

23-1040



23-6768

### Brake Disc.

- Stainless or polished stainless.
- Fits 2008-13 FLT.

VT No.	OEM#	Side	U/M	Finish
23-6764	41500022	Left	Each	Stainless, Polished
23-6765	41500022	Left	Each	Stainless
23-6768		Right	Each	Stainless, Polished
23-6769		Right	Each	Stainless

### Polished Replica Brake Discs

• Feature full stainless construction with precision ground finish and slot style pattern. Fits 2008-up.

VT No.	Fits
23-1040	Front, Pair
23-1041	Front, Right



Polished Stainless



Standard Stainless



### Replica Brake Disc

• Feature full stainless construction with precision ground finish and slot style pattern.

23-0357

23-0354

Dura Disc		Russell		OEM	Dia	Bolt Kit	Fits
Polished	Standard	Polished	Standard				
<b>REAR</b>							
23-0260	23-0354	—	—	40939-86A	11.5"	9807-10	1986-99 FLT
23-0357	23-0387	23-9050	23-9051	41797-00	11.5"	9807-10 Wire 9818-5 Cast	2000-up FLT Cast or Wire
23-0598	—	—	—	41797-00	11.5"		2000-09 FLT
23-1043	—	—	—	41791-10	11.5"	9807-10 Wire 9818-5 Cast	2010-up FLT
—	23-1314	—	—	83425-09B			2009-12 Tri-Glide
—	23-1315	—	—	41500031			2013-15 Tri-Glide

42-1014



20-0832



20-0751



42-0963



### Chrome Outer Pulley Covers

• Fit over pulley and mount with the original five screws.

Chrome	Black	Glossy	Tooth	Fits
42-1014			66	FLT 2007-up
	20-0832	20-0751	70	FLT 2007-2013
42-0963			70	FLT 2004-2006



### Wyatt Gatling Polished Spoke Brake Disc.

18 Spoke	Type	Year
23-0678	Rear	1979-99
23-1518	Rear	2000-up
23-0895	Rear	1979-93

### Replica Brake Discs

• Feature full stainless construction with precision ground finish and slot style pattern.

23-0978	2008-up	Rear	Polish
23-0840	2008-up	Rear	Stainless



23-1530



23-1533



### Wyatt Gatling Rear Brake Disc 11.8"

VT No.	Item	
23-1530	18 Spoke Style	2008-up rear
23-1533	X-Spoke Style	2008-up rear

### 12" Polished Steel Brake Rotor.

Drilled	Plain	OEM	Bolt Kit	Fits
23-0297	23-0313	40939-79A	8792-5	1979-85 FLT
—	23-0321	40939-86A	8847-5	1986-99 FLT



### Front Brake Disc Hardware Set.

• For one side. Fits 2014-up FLT. 30 pieces. VT No. 23-0943



24-0085



### 6° Raked Triple Tree Set.

• For FLT models features 6° rake over stock tree set. Allows use of larger diameter wheels while still retaining the use of stock cowling assembly.

VT No.	Fits
24-0085	FLT 1997-2013



### 1987-up FLHT Chrome Lower Fork Stem Cover

VT No.	OEM
42-0911	66058-01



### Chrome Fork Dress Up Kit.

• Includes lower legs, upper fork cover, axle spacer set and outer nut covers. All necessary hardware is included for installation.

VT No.	Fits
24-1245	FLHR 2000-13, FLT 2000-13, FLHT 2000-13



### Lower Triple Tree Cover.

• Completely covers underside of tree.

VT No.	Fits
42-0920	FLT 2001-13



24-2042

24-2043

### Billet Lower Leg Cap

• Replaces stock cap.

VT No.	Year	Fits
24-2042	1986-99	3/4" Axle
24-2043	2000-up	1" Axle



24-0212



24-1314

### Replica Chrome Forged Steel Triple Tree Set

• Includes lower bearing pressed on, dust shield set and upper bearing and cone nut.

VT No.	Fits
24-0212	1984-08 FLT
24-1314	2009-13 FLT



### Chrome Lock Cover

• Fits 1994-up Road King.  
• Cover pivots to allow access to fork lock.

VT No.
48-0424

24-1056



24-1068

### Fork Leg Rebuild Kit

VT No.	MM	Fits
24-1068	41	1993-13 FLT
24-1056	49	2014-up FLT



### Fork Tube and Chrome Slider Assembly

• Available in right and left pairs, completely assembled.  
• Units have hard chrome fork tubes, and chrome lower sliders, with springs and all internal components installed.  
• Dual Disc

VT No.	Fits	MM
24-0522	1984-99 FLT	41
24-0538	2000-13 FLT	41
24-1730	2014-up FLT	49
24-1536	2014-up FLT	49
24-1367	2014-up FLT	49
24-9996	1986-99 FLT	41

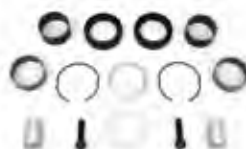

Fork Bushing Kit for assembly of 41 mm leg sets.

VT No.
24-1765





24-1221



24-2223

## Chrome Fork Assembly

• Features chrome triple trees, chrome or polished lower legs, axle, chrome upper fork covers and full chrome cowl and handlebar top chrome cover assembly. Units accept dual disc caliper as required by year. 1984-86 models require 1987-99 front caliper set.

### 1984-99

24-1220	Polish
24-1221	Chrome

### 2000-06

24-2223	Chrome
---------	--------

## Triple Trees for 2009-13

VT No.	Item	Finish
24-1311	Top	Chrome
24-1312	Lower	Chrome
24-0313	Lower	Black



24-0212



25-0985



24-1155

## Chrome Tree Set

VT No.	Item	Year
24-0212	Tree Set	1984-08
24-1314	Tree Set	2009-13
25-0985	Riser Set	1988-up
24-1155	Riser Top	2008-up

2736-1



2737-1



### FLT Top Fork Tube Plugs.

VT No.	Year	Type
2736-1	1984-01	Top
2737-1	1984-01	Lower



24-9999



24-0211



24-0178



24-0268



24-0210



17-0949

## FLT Fork Assembly

Fits 1984-99 FLT and includes chrome lower sliders with all internals and stock length tubes installed, chrome triple tree set, chrome slider covers, axle, bearings and dust covers. Accepts FLHR cowl set not included. Also accepts 11.5" dual disc components.

VT No.	Item
24-9999	Fork Assembly Complete w/Chrome Sliders
52-0856	16" Chrome Wheel
24-0355	Cowl Assembly
24-0268	Top Handlebar Chrome Cover
31-0246	Cowl Top Trim Piece
24-0522	Right and Left Leg Assembly, Chrome
24-0210	Chrome Upper Tree
24-0211	Chrome Lower Tree
24-0178	Black Upper Fork Triple Tree
24-0212	Chrome Tree Set
24-9960	Chrome Slider Covers
37-0860	Slider Cover Screws
24-0772	Fork Installation Kit
44-0675	Axle Kit Only
17-0949	Nut Lock Tab
37-1010	Pinch Bolt Set



## Fork Stem Nut Wrench

• Fits FLT.  
VT No. 16-1977



## Neck Hardware Kit

• FLT 1980-up  
• Available separately.  
VT No. 24-0367



### 24-0694 24-0389 24-0396 24-0394 24-0397 41 mm Lower Fork Slider Set.

• Include seals and lower leg cap.

Chrome	Black	Fits
24-1369		FLT 1986-99
24-0694		FLHT 2000-2013, FLHR 2000-2013
24-0389		FLT 2000-2013; does NOT include the lower leg cap
24-0396	24-0398	FLT 2000-13
	24-1368*	FLT 2014-up <b>Note:</b> Assembly
24-0394	24-0397	FLT 2014-up
24-0395		FLT 2000-2013
24-0593		Polished, FLT 1986-1999

### Chrome Lower Fork Slider.

VT No.	Fits
24-0583	FLHT 1984-99



### 20th Century Fork Spring Lowering Kit.

• Progressively wound springs that resist bottoming out.  
 • Installation requires minor disassembly to lower the front forks 1½" or 2" depending on the spacer used. Kit includes springs, spacers and hardware. Easily converts back to stock by re-installing stock fork springs.

VT No.	Size	Year/Model
24-1563	41 mm	1997-13 FLT



### Monotube Fork Cartridge Kit.

• By Progressive Suspension converts dual damper rod forks to high performance cartridge forks. Improves resistance to front brake drive, front end stability and cornering control.

VT No.	Fits
24-2101	1984-96 FLT, FLHT, FLHT, FLHR, FLHX
24-2100	1997-13 FLT, FLHT, FLHR, FLHX



### Fork Tube.

1984-96 FLT, FLHT, FLHR 41mm.	
24-0411	Stock 20 <sup>7</sup> / <sub>8</sub> " Chrome
24-0027	As above Hard Chrome
1997-13 FLT, FLHT, FLHR, 41mm	
24-0045	Stock 20 <sup>7</sup> / <sub>8</sub> "
24-1352	As Above, Hard Chrome
24-0053	22 <sup>7</sup> / <sub>8</sub> " Hard Chrome
24-0047	24 <sup>1</sup> / <sub>2</sub> " Chrome
24-0048	24 <sup>1</sup> / <sub>2</sub> " Hard Chrome
24-0056	26 <sup>7</sup> / <sub>8</sub> " Hard Chrome
24-0050	28 <sup>1</sup> / <sub>2</sub> " Hard Chrome
2014-up FLT	
24-1188	22 <sup>3</sup> / <sub>4</sub> " Hard Chrome



24-1453

### Fork Lowering Kit.

• Fits 2014-up FLT with 49 mm fork tubes.

VT No. 24-1453



24-1046

24-1045

### Handlebar Riser Cover.

• Fit one piece handlebars that have a rise greater than 12".

VT No.	Finish
24-1046	Black, 2003-13
24-1045	Chrome, 2003-13
24-1079	Chrome, 2014-up



### Fork Steering Damper Kit.

• Attaches to lower fork stem and crash bar

VT No.	Fits
24-1371	FLT 2000-2013
24-1372	FLT 2014-up



24-1166



24-1173



24-1167



24-9986



24-9960

### Fork Slider Cover

- Fit 1980-2013 FLT model forks.
- Stock length is 6 5/8" overall.

VT No.	Finish	Style
24-9960	Chrome	Smooth
24-9986	Stainless	Smooth

24-1183



24-1159



24-1169



24-1168



24-1047



24-1048



24-1192

24-1182

24-1180

### Fork Slider Cover Set

- Fits 2014-up FLT

Chrome	Black	Style
24-1047	24-1048	Fork Slider Cover Set
24-1182	24-1180	Edge Cut w/ milled accents
24-1192	24-1193	Billet Smooth
24-0387	24-1558	Flame

24-1165



24-1172



24-0386



24-1171



24-1170



24-1365



24-1752



24-1047

24-9962

### Stock Slider Covers

- Stock length is 6 5/8" overall.

VT No.	Fits	Finish
24-1365	FLT 1980-2013	Chrome
24-1752	FLT 1980-2013, FLH 1949-1984	Black
24-9962	FLH 1949-1984	Stainless
24-1047	FLT 2014-up	Chrome
24-1048	FLT 2014-up	Black

24-1048



### Fork Slider Cover Sets

- Black and chrome slider cover sets in various styles as noted.
- For FLT 1980-2013

Chrome	Black	Style
24-1166	24-1173	Grooved
24-1167		Tribal
24-1183	24-1159	Agostinni
24-1169	24-1168	Smoke Stack
24-1165	24-1172	Bellowed
24-0386		Flame
24-1171	24-1170	Tapered w/ Contrast Rings





### AEE Series Shock Sets

- Nitrogen charged with multi stage dampening and adjustable spring load. All shocks are measured eyelet to eyelet and feature chrome springs and caps with black body. **\*Note:** Denotes stock length.

Fits	11"	11.5"	12.5"	13"	13.5"	14.25"
1980-04 FLT	54-0020	54-0021	54-0022	54-0023*	54-0024	54-0025
1980-04 FLTS	54-0133	—	—	—	—	—



### Chrome Low Touring Shock

- Lower the seat height without altering the ride.
- Low Touring Shocks have been revalved for a comfortable ride while lowering the seat height by up to 3/4" The air adjustability feature of the stock shocks will be retained.

VT No.	Model	Brand
54-0147	2002-up FLT, FLHT, FLHS, FLTR & FLHR	AEE
54-0148	1991-01 FLT, FLHT, FLHS, FLTR & FLHR	AEE
28-0535	Rear Rubber Boot Set 1997-2012 FLT	



### Progressive Suspension 412 Series Chrome Shocks

- Manufactured from the finest material available.
- Magnum 412 Series shocks are nitrogen charged with six-stage automatic damping and an adjustable spring preload.
- Available with chrome spring and end caps, shock cartridge is not chrome.
- All shocks are measured eyelet to center of eyelet.
- Fit 1980-04 FLT, FLHT, FLHS

11"	11.5"	12.5"	13.0"	13.5"	14.5"
54-0093	54-0033	54-2000	54-2001*	54-2002	54-0059



### Progressive Suspension 440 Series Chrome Shocks

- Feature two rebound damping circuits and are available in standard for the average single rider, heavy duty for touring or carrying passengers.
- Fit 1980-04 FLT

Standard	Heavy	Size
54-4006	54-4011	11.5"
	54-4050	12"
54-4001		12.5"
54-4003	54-4021	13.5"



### Digital Shock Pump

- Includes pressure gauge replaces 54630-03A from 0-300 PSI.

VT No. 16-0002



16-0041

### Shock Pump

- Includes pressure gauge replaces 54630-03A from 0-60 PSI.

VT No. 16-0041



16-0578

### Shock Pump

- Pressure gauge 0-60 PSI. Manually operated.

VT No. 16-0578



**Center Stand**

- Bolts directly to the FLT model frame.
- Lifts the bike upright and stands by activating the lever on the left side. In this position the bike looks great for display or servicing.

\* **Note:** Adjustable Height

VT No.	Type	Fits
16-1110*	Chrome Adjustable	FLT 2009-up
16-1116	Black Adjustable	FLT 2009-up
16-1109	Chrome Adjustable	FLT 1989-2008
16-1600	Black Non-Adjustable	FLT 1980-2008



**Kickstand Angle Plate**

- Fits FLT 1981-up.

VT No.	Item	Finish	Use
27-0070	Plate	Alloy	Extended Forks
27-0853	Kit	Chrome	Lowered Forks



**Black Rear Shock Lowering Kits**

- Lowers rear frame area.
- Includes instructions, hardware and black brackets.

VT No.	Fits	Lowers Frame Area
54-0508	1985-1996 FLT	1 1/2"
54-0521	1997-2001 FLT	1 1/2" (except FLHRCI)
54-0534	2002-2003 FLT	1 1/2"
54-0125	2004-up FLT	1"
54-0126	2004-up FLT	1 1/2"





51-1607



51-1609



51-1601  
Installed



51-1601

51-1602



## The Touring Torque Linkage System

- No modifications are necessary to install this unit. After the unit is installed it will eliminate the lateral movement while still allowing the Iso mounted factory design of the "floating" drive train to move vertically as designed through connecting the rear of the transmission case to the frame. The kit utilizes an isolation link with a urethane plunger so there is no contact between the frame and engine transmission assembly, therefore reducing vibration.
- 51-1602 includes outer mount bracket in chrome.

VT No.	Finish	Fits
51-1607	Chrome	FLT 1993-2008
51-1609	Black	FLT 1991-2008
51-1601	Black	FLT 1993-2008
51-1602	Chrome	FLT 1993-2008
51-1608	Black	FLT 2009-up

**Note:** Installation on 1993-2001 models require 27-1235 foot peg spacer set as shown. Purchase 27-1235 separately.



## Touring Wide Swingarm Kit

- This new wide swingarm kit come complete with all bolt-on parts necessary to install without modification.
- Kits include new wide rear swingarm with a 1" axle, custom 14 gauge rear OE style fender, saddle bag support kit, drive components, billet primary spacers and all brackets and hardware necessary.
- Allows use of OE stock tail lamp, saddle bags and exhaust.
- Accepts 16" x 5.5" x 17" x 5.5" x 18" x 5.5" rear wheels and most tires up to 200mm wide.
- Requires a 20mm rear belt and pulley.
- Models with 18" rear tire, use OE brake caliper, models with 16" rear tire require a smaller custom brake caliper.
- Installation of a tour pak or backrest will require OEM detachable docking hardware.
- Fits 2002-06 FLHT, FLHR and FLTR touring models.

VT No.	Item
51-1252	Kit
51-1251	Replacement Swing Arm Only



## 1998-08 Frame for FLHR

- Accepts stock components for these years. Frame shipped in raw finish without swingarm.

VT No. 51-0800



## Tri Glide Leveling Kit

- Includes 2 black painted steel plates to raise the rear axle position for installing custom muffler.

VT No. 51-1744





## 1986-99 Front 40 Spoke Wheel

- Twirled spokes, chrome rim, chrome spokes and chrome hub.

Chrome Spokes	Rim Diameter	Rim Width
52-0859	16"	3.00"



52-0439



52-0440

## 21" x 3.25" Chrome Front Wheel.

VT No.	Year	Model
52-0440	2005-07	FLT Dual Disc
52-0491	2008	FLT Dual Disc



52-1020



52-2008

## FLT Front Wheels

Chrome Spokes	Stainless Spokes	Rim Diameter	Rim Width
<b>1984-99</b>			
52-0856	52-0854	16"	3.00"
52-0021		21"	2.15"
52-0441		21"	3.25"
52-1020		16"	3.00"
52-1033		23"	3.00"
52-0621	52-0622	26"	3.50"
<b>2000-07</b>			
52-2008	52-2009	16"	3.00"
52-0440		21"	3.25"
52-0462		23"	3.00"
<b>2008</b>			
52-0491		21"	3.25"
52-0465		23"	3.00"
<b>2009-up without ABS</b>			
52-1241		16"	3.00"
52-0492		21"	3.25"
52-0466		23"	3.00"
<b>2009-up with ABS</b>			
52-2060		16"	3.00"
52-2061		21"	3.25"



## 26" 60 Spoke Front Wheel.

- Bearings included. Fits 2000-2007.

VT No. 52-0794



52-0450 23"

## 23" x 3.00" Chrome Front Wheel.

VT No.	Year	Model
52-1033	1984-99	FLT
52-0462	2000-04	FLT
52-0463	2005-07	FLT
52-0465	2009-up	FLT



## 60 Spoke Front Billet Hub Wheel

- Features chrome plated billet hub, polished stainless spokes and chrome rim.

### Front Wheels

52-0739	FLT 2000-01	18" x 3.5"
---------	-------------	------------

## 50 Fat Spoke Radial Laced Wheel

- Feature 3/8" polished stainless steel spokes, billet chromed hub and polished chrome steel rim. All wheels include bearings, seals and center spacer.



### Front Dual Disc

52-0109	16" x 3.5"	2000-04 FLT, FLHT, FLR
52-0110	16" x 3.5"	1986-99 FLT, FLHT, FLHR



## Front Twirled Spoke Wheel

- Include chrome hubs with internals, rim and twirled chrome spokes assembled.

VT No.	Fits	Type	Width
52-0859	1984-99 FLT	16"	3.00"



## Chrome Front 17" x 3.0" Rim

- 40 spoke holes
- 2009-up FLT

VT No. 52-0793



52-0589



52-0665 16"

### Chrome Profile Rear Wheel.

• Includes chrome aluminum rim with smooth finish, chrome hub and chrome spokes. Laced and trued.

1986-90	Rim Diameter	Rim Width
---------	--------------	-----------

52-0589	16"	3.00"
---------	-----	-------

52-1242	16"	3.00"
---------	-----	-------

**Note:** 52-0589 has aluminum chrome hub and 52-1242 has steel chrome hub.

2000-01	Rim Diameter	Rim Width
---------	--------------	-----------

52-1240	16"	3.00"
---------	-----	-------

52-0665	16"	3.00"
---------	-----	-------



52-0976

### Rear 40 Spoke Wheel

• With twirled spokes, chrome rim, chrome spokes and a chrome hub.

52-0858	16"	3.00"
---------	-----	-------

2000-01		
---------	--	--

52-0976	16"	4.00"
---------	-----	-------

52-0978	16"	4.00"
---------	-----	-------



52-0858

### Twirled Spoke Wheel.

• Include chrome hubs with internals, rim and twirled chrome spokes assembled.

REAR			
------	--	--	--

52-0858	1986-99 FLT	16"	3.00"
---------	-------------	-----	-------

52-0976	2000-01 FLT	16"	4.00"
---------	-------------	-----	-------



Rear			
------	--	--	--

52-0112	16" x 3.5"	2000-01 FLHT, FLHR, FLTR
---------	------------	--------------------------

52-0113	16" x 3.5"	1984-99 FLHT, FLHR, FLTR
---------	------------	--------------------------



52-1289

### Rear Spoke Wheel.

VT No.	Diameter	Width	Fits
--------	----------	-------	------

52-1245	16"	5.00"	FLT 2009-up
---------	-----	-------	-------------

52-1289	16"	5.00"	FLT 2009-up
---------	-----	-------	-------------



52-2037



52-0857

### FLT Rear Wheels

Chrome Spokes	Stainless Spokes	Rim Diameter	Rim Width
---------------	------------------	--------------	-----------

1986-99			
---------	--	--	--

52-0857	52-0855	16"	3.00"
---------	---------	-----	-------

2002-07			
---------	--	--	--

52-1099		16"	3.00"
---------	--	-----	-------

2008 without ABS			
------------------	--	--	--

52-2037		16"	3.00"
---------	--	-----	-------

2009-up without ABS			
---------------------	--	--	--

52-1289		16"	3.00"
---------	--	-----	-------

2009-up with ABS			
------------------	--	--	--

52-2062		16"	5.00"
---------	--	-----	-------



9989-4



44-0115

## Chrome Front Axle Spacer Kit

- Include left and right side spacers, washers, and nuts.

Smooth	Grooved	Fits
2507-5	—	FLHR, FLT 2008-up
44-0115	—	FLT 2000-up Front Fitment
2036-5	2035-5	FLT 2000-2007
9989-4	—	FLHR, FLHRCT 1994-up



**Front Chrome Axle Nut Cap Set** for both axle nut and axle head where required. Includes set screws and hex key wrench. Each cap has an internal hex to allow more thickness for the set screws thread to eliminate thread stripping. Fits 2000-06 FLT-FLHR.

VT No. 37-0059



44-0675



44-0673

## Axle Kit

Fits	Kit	Nut	Axle	Fork	Dia
1984-99 FLT	44-0675	9989-4	44-0208	41 mm	.750"
2000-07 FLT	44-0673	2036-5	44-0359	41 mm	1"



44-0370



44-0371

## Front Axle Spacers

Chrome	Zinc	Side	Fits
44-0370	44-0371	Left	1995-99 FLT



12-0390



12-0631



12-0996

**Wheel Bearing** fits front and rear.

VT No.	OEM	Fits	U/M	Size	Year
12-0390	9247	FLT	Pair	1"	2000-07
12-0631	9276	FLT Rear	Pair	25mm	2008-up
12-0996		FLT Rear	Pair	25mm	2008-up



44-0399



44-0601

## FLT Axle Adjusters

44-0399 1984-96

44-0601 1997-01



44-1977

**Chrome Rear Wheel Spacer Set** fits Touring models.

VT No.	Year
44-1977	2002-07



2036-5



2035-5

## Wheel Spacer Kit

- For Touring, front axle with 1" inner diameter.

VT No.	Type	Year
2036-5	Smooth	2000-07
2035-5	Grooved	2000-07
2507-5	Smooth	2008-up



37-0036



37-0380

**Big Twin Front Axle Cap Cover Sets** include right and left caps with set screws for glide type forks. Chrome.

VT No.	Year/Model
37-0036	1972-84 FLT
37-0380	2000-up FLT-FLHT

44-0794



## Front Axle Kits.

- Axle end and spacers are chrome.

VT No.	Years	Size
44-0676	2000-01	.750"
44-0673	2002-07	1.0"
44-0794	2008-up	25 mm
44-0750	2000-07	25 mm
44-0793	2007-up	



44-0935



44-0936



44-0001



44-0002

## Flush Mount Front Axle Kit

- A new way to dress up your front wheel without the hex nut and lug sticking out.
- Kit includes two chrome washers and two chrome flat head

VT No.	Fits
44-0936	FLT 2008-up
44-0935	FLT 2000-2007
44-0001	FLT 2000-2007
44-0002	FLT 1984-1999



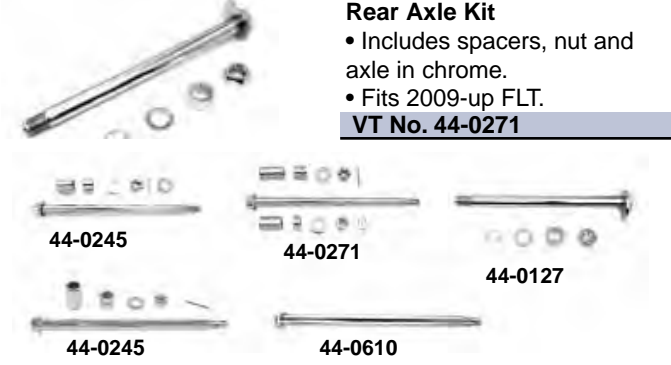

**Rear Axle Kit**  
 • Includes spacers, nut and axle in chrome.  
 • Fits 2009-up FLT.  
**VT No. 44-0271**

### Chrome Rear Axle

VT No.	OEM	Year	Model	Length	Finish
44-0219	41110-79A	1980-99	FLT	12½	Chrome
44-0127	41110-89	2000-01	FLT	12½	Chrome
44-0471	41056-02	2002-07	FLT	12¼	Chrome
44-0787	41056-08	2008	FLT		Chrome
44-0715	41056-09	2009-up	FLT		Zinc

### Rear Axle Kit

• Include chrome axle, nuts, sleeves and spacers for each application. Nut kit includes axle nuts in chrome. Fits belt drive.

Kit	Spacer	Axle only	Model/Year
44-0245	—	44-0610	1986-99 FLT
44-0247	2026-5*	—	2000-01 FLT
—	—	44-0127	2001-07 FLT
44-0241	—	—	2002-07 FLT
44-0275	—	—	2008 FLT
44-0271	—	—	2009-up FLT

\*Note: Includes Nut Kit



### Replica Rear Bearing Kits.

• Include inner spacer.

VT No.	Year	Model	Size	Note
44-0989	2000-07	FLT	1"	
44-0998	2008	FLT	25mm	
44-0999	2009-up	FLT	25mm	
44-0865	2008-up	FLT	25mm	Non-ABS
44-0866	2009-up	FLT	25mm	ABS

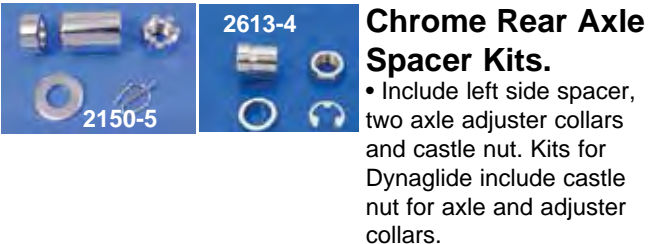

### Chrome Rear Axle Spacer Kits.

• Include left side spacer, two axle adjuster collars and castle nut. Kits for Dynaglide include castle nut for axle and adjuster collars.

VT No.	Years
2150-5	2000-01
2613-4	2002-07
2508-4	2008-up



### Rear Wheel Bearing Race and Seal Kit

• Includes two of each bearing, race and proper seals.  
 • Fits cast or wire wheel.

VT No.	Fits
44-0420	1983-99 FLT

### Wheel Bearing Only.

VT No.	OEM	Size	Type
44-0993	9267	.750"	Non-ABS
12-0390	9247	1"	Non-ABS
12-0631	9276	25mm	Non-ABS
12-0996	9252	25mm	ABS (1 Each)
44-0900	9252	25mm	ABS/Non-ABS
44-0901*	21"	25mm	ABS/Non-ABS
44-0902*	23"	25mm	ABS/Non-ABS
44-0903*	26"	25mm	ABS/Non-ABS

\*Note: Bearings for larger than stock diameter wheels have a greater reinforced magnetic area that will not set off any engine codes after proper installation.



### Bearings Kit

• Includes two tapered bearings and two races replacing 9052 for 1973-99 Big Twin swing arm 1958-85.

VT No.	Item
44-0425	4 Piece Kit
44-0405	Race and Bearing, one pair
44-0406	Bearing Only, one piece
44-0407	Race Only, one piece

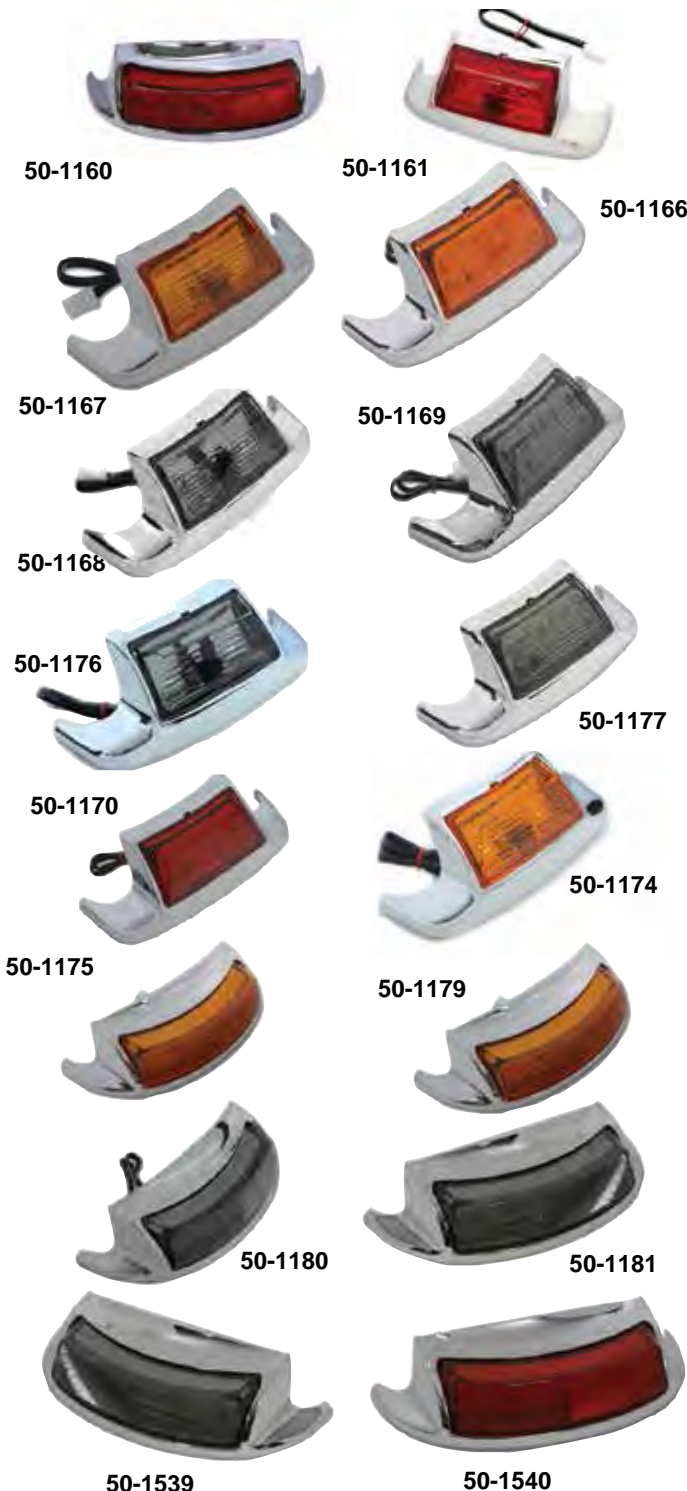

### Chrome Rear Fender Tip Lamps

Bulb	LED	Color	Fits
-	50-1160	Red	FLT 2009-up
-	50-1540	Red	FLT 2009-up
-	50-1539	Smoked	FLT 2009-up
-	50-1179	Amber	FLT 2009-2010
-	50-1180	Smoked	FLT 2009-2010
-	50-1181	Clear	FLT 2009-2010
50-1174	50-1175	Amber	FLT 2004-2010
50-1176	50-1177	Smoked	FLT 2004-2010
50-1161	50-1170	Red	FLT 1999-2008
50-1166	50-1167	Amber	FLT 1999-2008
50-1168	50-1169	Smoked	FLT 1999-2008

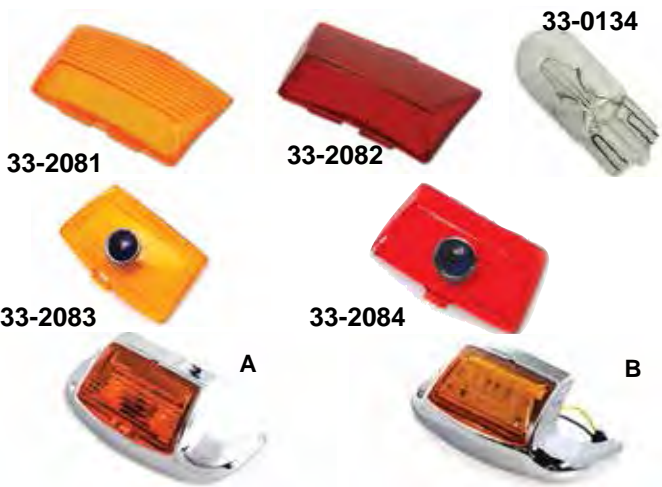

### Chrome Plated Tips fit 1979-99 FLT with light.

Front	Rear	Style
50-1025	50-1026	With Bulb Lamp (A)
50-1164	50-1165	With LED Lamp (B)
33-2081	33-2082	Lens only
33-2083	33-2084	Lens only with Blue Dot
15-0695	15-0694	Gasket
33-0134		Bulb, 10 pack



### Chrome Front Fender Tip Lamps

• With bulb or LED type lamps, and lenses in various colors.

VT No.	Bulb Type	Lens Color	Fits
50-1162	Bulb	Amber	FLT 2000-up
50-1025	Bulb	Amber	FLT 1985-up
33-0657	LED	Amber	FLT 1980-up
50-1173	LED	Smoked	FLT 2000-2010
50-1171	LED	Amber	FLT 2000-2010
50-1172	Bulb	Smoked	FLT 2000-2010
50-0045	LED	Clear	FLT 2014-up
50-0046	LED	Smoke	FLT 2014-up



### Chrome National Tips.

VT No.	Fits	Model
50-0691	Front front and front back	2000-13 FLT
50-0697	Rear	2002-08 FLT



### Chrome Fender Trim Strip Set.

• For left and right side. Extra t-bolt set also listed.

VT No.	Item	Fits
50-0531	Strip Set	FLT 1982-2013
37-8784	Tee Bolt Set	FLT 1982-up

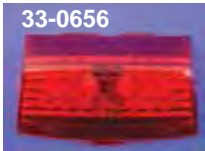

33-0656



33-0657

### LED Fender Tip Lamp.

• Fits 1980-up FLT models.

VT No.	Type	Color
33-0656	Rear	Red
33-0657	Front	Amber



28-0701



28-0702

### Mud Flap.

• Stock type for front and rear fenders on Big Twin

VT No.	Style
28-0701	Black Rubber
28-0702	White Rubber



### Front Fender Lamp Set Amber

• For the right and left side of FL type 2 rail stock front bumpers.

VT No.
33-2139



42-0720

### Chrome Fender Grill Tip.

VT No.	Fits
42-0720	FLT 1980-up

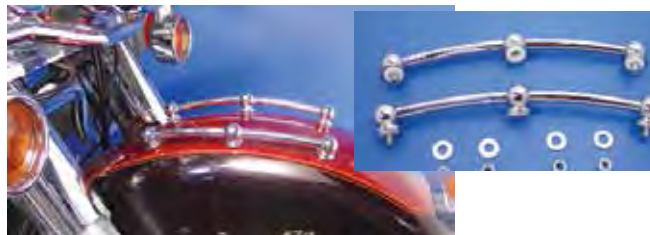

### Chrome Front Fender Rail Trim Kit

• Includes six stantions, two curved rails, and hardware.

VT No.	Fits
50-1084	Custom application



50-1061



50-0453 Installed



50-0453



31-1346



50-1058

### Chrome Front Fender Bumper Rail

• Available with or without rubber insert

VT No.	Item	Fits
50-1061	Rail w/ Insert	FLT 1983-up
50-0453	Rail w/o Insert	FLT 1983-up
50-1058	Insert	FLT 1980-1999
31-1346	Bracket	FLT 1980-1999



50-1094



50-1145



50-1146

### V-Design Fender Rail Trim.

VT No.	Application	Fits
50-1094	Front	FLT 1980-up
50-1145	Rear	FLT 2009-up
50-1146	Rear	FLT 1984-2008





### Glide Fork Front Fender.

VT No.	OEM	Year	Type
50-0138	59093-87	1987-99	Replica
50-0945	59093-00	2000-up	Replica
50-0946	Without holes	2000-up	Plain
50-0039	FLHXSE	2010-up	Raw
50-0548	FLH	1987-up	Raw
50-0472	FLH	2014-up	Raw
50-1193	FLH-FLHX	2014-up	Raw



### Chrome Die Cast Fender Tip.

• Features Eagle Spirit or a skull design.

Eagle Spirit	Skull	Fits
50-1659	50-1655	Front
50-1660	50-1656	Rear



### Fat Kid Steel Front Fenders

• Fit 16" wheels on Glide Forks.

VT No.	Fits
50-0185	1980-up



### Front Fender Lower Trim

• Fits 2014-up FLH

Chrome	Black	Type
50-1545	50-1548	Smooth
50-1546	50-1549	Flame

Chrome Eagle with Chrome Tip	Gold Eagle with Chrome Tip	Chrome Eagle w/ Black Tip	Gold Eagle with Black Tip	Style
50-1587	50-1588	50-1589	50-1590	Front
50-1591	50-1592	50-1593	50-1594	Rear
Chrome Tip with Black Skull		Black Tip w/Chrome Skull	Style	
50-1569		50-1570	Front	
50-1571		50-1572	Rear	



### Chrome Front Fender Lower Trim.

• Available in ribbed, flame or smooth.  
• Screw kit included.

Chrome	Black	Style	Fits
50-1066		Ribbed	FLT 1986-up
50-1132		Flame	FLT 1980-2013
50-1133		Smooth	FLT 1980-up
50-1220	50-1221		FLT 2014-up
37-1508		Screw Kit	



50-0715



50-0717



50-0896



50-0718



50-1517



50-0942

50-0471



50-0860



50-0718



50-1190



50-1525

## FLT Replacement Rear Fenders

VT No.	Fits
50-1508	1995-05
50-1509	2006-08
50-0715	1999-00
50-0717	1991-08
50-0896	2009-up
50-0718	2009-up, drilled
50-1517	2009-up longer
50-1515	2009-up

## Dresser Style Rear Fender

• Undrilled, fits models with modification.

VT No.	Width
50-0942	6.5"
50-0471	7.5"
50-0860	8.0"
50-1525	9.0"
50-1190	9.0"



50-1037



## Front Bumper

• Original cutter design. Includes parts pictured for mounting to FLH-FLT front fenders. Fender requires drilling for installation.

VT No.	Item
50-1037	Complete Kit
37-9024	Chrome Eye Bolt Set



50-0558

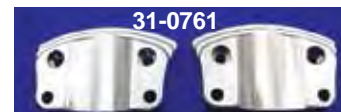

31-0761



31-0096

## Fender Adapter Brackets

• Allow installation of narrower Fat Kid (FLST Style) front fenders on FLT-FLHT with 16" front wheels.

VT No.	Years	Finish
50-0558	1980-99	Alloy
31-0096	1980-99	Chrome Billet
31-0761	2000-up	Chrome

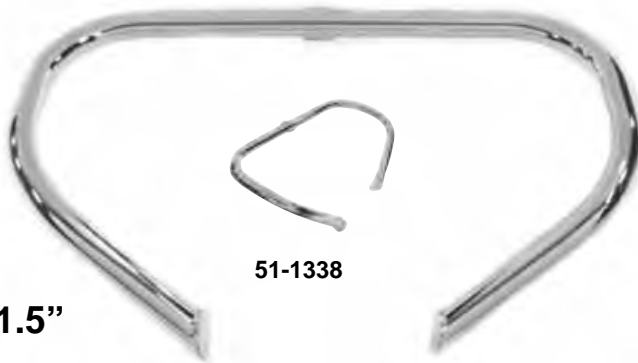

51-1338

1.5"

### Chrome Front Engine Bar

- Bar complements the traditional Touring style
- Features 1½" diameter tubing.

VT No.	Fits
51-1338	FLT 1997-2008



51-0991

51-0986

### Engine Guard

- Features integrated rubber pads for foot rests.

Chrome	Black	Year	Model
51-0991	51-0871	1997-08	FLT
51-0986	51-0873	2009-up	FLT
28-0852		Rubber Pads	



### Rear Engine Bar

- Available in black or chrome.
- Includes right and left guards and hardware.
- \*Note:** includes saddlebag supports, right, left guards and hardware. **\*\*Note:** Top of bars are angled downward to provide more leg room for passenger. Use stock supports.

Chrome	Black	Fits
51-1061*	51-1062*	FLH 2014-up
51-1057*	51-1058*	FLT 2009-2013
51-1063**	51-1064**	FLHTR, FLHX, FLHXSE, FLTRXSE, FLTRSES, FLHRC 2009-2013



51-0850



51-0937

### Rear Engine Bar Set

- Feature left and right side with style and tube diameter as noted.
- Bars do not include reflectors

Chrome	Black	Type	Fits
51-0935*		7/8"	FLHT, FLHR, FLHRC 1997-08
51-0850**		7/8"	FLHR 1997-08, FLHT 1997-up
51-0937***	51-1348***		FLT 1997-2013 1¼" Buffalo
49-0799			Lower Support Set

**\*Note:** Not to be used with saddlebag supports. **\*\*Note:** Top at bars are angled downward to provide more leg room. Uses stock lower supports or VT No. 49-0799 supports. **\*\*\*Note:** Uses lower saddlebag supports or VT No. 49-0799 supports.



50-2065



50-2066

### Rear Engine Bar

VT No.	Year	Model
50-2065	1996-up	FXST, FLST
50-2066	1994-up	FLHT, FLTR, FLHR
14-0977		O-Ring for Above Front or Rear Bars

FOR ENGINE BARS:

**Warning:** These Engine/frame bars may provide limited leg and cosmetic vehicle protection under unique circumstances (fall over while stopped, very low speed slide). They are not made nor intended to provide protection from bodily injury in a collision with an automobile or any other object.



51-1577



51-0878



51-0880



51-0883



51-1338

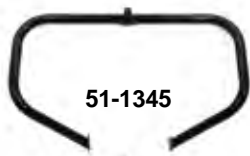

51-1345



51-1347

## 1 1/4" Front Engine Bar

- Bar complements the traditional Touring style and features 1 1/4" tubing.

Chrome	Black	Fits
51-1577	51-1345	FLT 2009-up
51-0878	51-1346	FLT 1997-2008
51-0880	51-1347	FLT 1988-1996
51-0883		FLT, FLHT, FLHS 1984-1987 with air
51-1338		FLT 1.5" O.D.



51-2085

## Nerf Bars

- Feature built in foot rest.
- 1 1/4" tubing.

VT No.	Fits
51-2085	1997-up FLT, FLT, FLHT, FLHR, 2009-up FL



50-2056

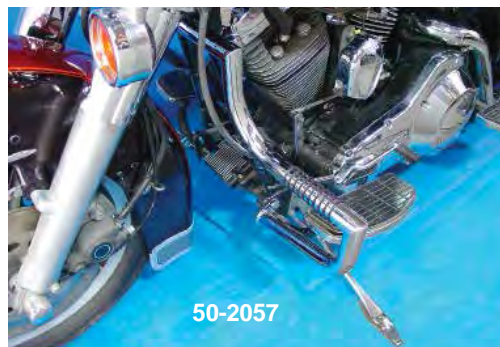

50-2057

## Engine Bars

Big Twin Front		
50-2056	1997-up	FLT, FLHT, FLHR
50-2057	1981-96	FLT, FLHT, FLHR



50-2069



## Chrome Custom Twinbar Combination Engine Guard

- With built in flip down footpegs. Constructed from 1 1/4" outside diameter tubing.

VT No.	Year	Model
50-2069	1997-up	FLT



30-4052



30-4045



30-0639



30-4044



30-1413



30-3183



30-0598



30-0638



30-0636



30-4095

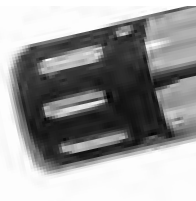

30-0613



30-0629



30-4053



30-4050



30-0613



30-4044

30-0598

## 4" Diameter Chrome Muffler Set

- Measure 4" outside diameter with removable tips.
- Fit 1995-16.

Tip Style	Chrome Tips	Black Tips
Short Tapered	30-4052	—
Medium Tapered	30-4045	30-4053
Long Tapered	30-0639	30-4044
Long Type Tapered	30-1413	—
Hollow Point	30-3195	30-3183
Slash	30-0598	—
Six Screw	30-0638	30-0636
Gun Barrel	—	30-4095
Revolver	—	30-0613
Billet	30-0629	—
Resonator	—	30-4050





30-3053



30-0635



30-3044



30-3050



30-4040



30-3023



30-4051



30-4054



30-1555

## Wyatt Gatling Muffler Set.

• Fits 1995-2016.

VT No.	Type
30-4040	4" OD
30-4051	Shooter
30-4054	Tapered

## Chrome Bub 7 True Dual Exhaust System

- Includes performance headers, heat shields, and slash cut mufflers. Chrome Bub 7 dual exhaust system utilizes performance proven stepped header technology running from 1 7/8" to 2". Without having the crossover tube you improve your mid-range and top-end performance.

- Features 2 1/4" 220° full coverage heat shields and 3 1/2" diameter mufflers with adjustable slash cut ends. Slash can be fixed in the upward or downward position.

VT No.	Fits
30-1554	1995-2016 FLT with crossover tubes
30-1555	1995-2016 FLHT, FLHTC, FLHX, FLHR, FLTR



**Important Note:** Some items on this page may be emission-related parts subject to California or other emission control laws. Please see note on page 71 for important information regarding emission control regulatory compliance and warranty information.







30-3110



30-3387



30-0634



30-3392



30-0600



30-4094



30-0635



30-0753



30-0754



30-3383



30-3382

## 3.5" Diameter Chrome Muffler Sets

• Fits 1995-2016.

Type	Chrome Tips	Black Tips
Long Tapered	30-3110	30-3387
Hollow Point	30-0634	30-3392
Slash	30-0600	30-4094
Six Screw	30-0635	30-0753
Shooter	30-0754	30-3383
Highlighted Shooter	-	30-3382
Long Gun Barrel	-	30-0752
Revolver	-	30-4056
Highlighted Revolver	-	30-4055
Shark Tail	30-0628	



30-0752



30-4055



30-0628



30-0596



30-0601



30-0627



30-0605



30-0845

## Custom Muffer Cap Set

• Chrome or black finished end caps fit stock mufflers, measured by muffler outside diameter.

**For 3 1/2" Diameter**

30-0601	Chrome Slash
30-0627	Chrome Shark

**For 4" Diameter**

30-0605	Chrome Slash
30-0845	Black and Silver Revolver



30-0599



30-3023

**3.5"**

## Muffer Sets with Short Tapered End Caps

- Touring style muffer set has a 3.5" outer diameter.
- Available with either a chrome or black body
- Features removable baffles, welded top mounts, accurate inner diameter inlets and formed inlet tubes, with black anodized or chrome end caps. Fits 1995-2016.

Chrome Body	Black Body	End Cap
30-0596		Black
30-0599	30-3023	Chrome

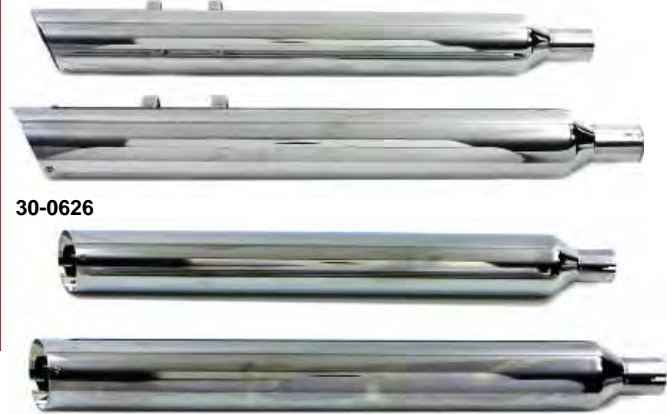

30-0626

30-0597

### Slash Down Chrome Muffler Set

• To stock OE brackets and features removable baffles which can be modified for alternate tuning characteristics.

VT No.	Fits
30-0626	FLT 2009-16
30-0597	FLT 1995-16

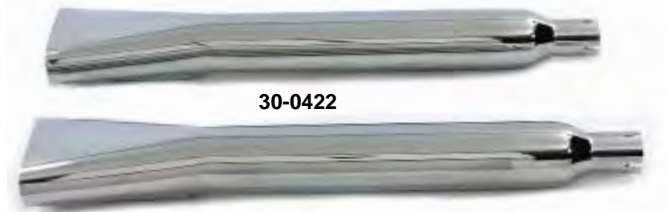

30-0422

### Radii Wide Oval Chrome Muffler Sets

• With built in baffles. Oval shape measures 2½" X 5". This muffler set has an overall length of 27¼".

VT No.	Fits
30-0422	FLT 1995-2016



30-1588

### Twin Slash Oval Slip-On Mufflers

• Complete your touring model exhaust system with Vance and Hines oval muffler set. The 4" diameter mufflers add a substantial power increase and crisper throttle response.

VT No.	Fits
30-1588	FLT 1995-2016



30-1568

### Vance & Hines Slash Slip-on Muffler Set

• Round 4" diameter muffler body with a straight through louvered baffle. Chrome finish.

VT No.	Fits
30-1568	FLT 1995-2016



30-1570



30-1581

### Twin Slash Monster Oval Slip-On Mufflers

• Vance & Hines FLT twin slash cut mufflers feature full coverage heat shields for blue proof protection.

VT No.	Fits
30-1570	FLT 1995-2016
30-1581	FLT, FLHT, FLHR 2009-2010



### Vance & Hines FLT Muffler Set

VT No.	Fits
30-0647	FLT 1995-2016



30-1544

30-1545

### Power Curve True-Dual Exhaust Header

VT No.	Fits
30-1544	1995-2016
30-1545	1995-2016



4"

### 4" Wyatt Gatling

• Fits 1995-2016.

Chrome Tip	Black Tip	Type
30-0932		Megaphone



30-1303



30-1303

### Wyatt Gatling Reverse Cone Vortex Type

• Fits 1995-2016.

VT No.	Item
30-1305	Chrome with black cap
30-1303	Black with chrome cap



30-1605

### Wyatt Gatling Tapered End Caps

• Fits 1995-2016.

VT No.	Item
30-1603	Chrome with black end cap
30-1605	Black with chrome end cap



3"

30-3184

### Short Tapered Tip Chrome Muffler Set

• 3" diameter.

• Features chrome short tapered style end tips. Baffles are 2.5" and are removable.

VT No.	Fits
30-3184	FLT 1995-16



30-3384



30-0213

### 31" Chrome Wyatt Gatling

• Turnout Muffler Set



VT No.	Fits
30-3384	FLT 1995-2016
30-0213	FLT 1985-1994



3.5"

30-0610

### Bullet Muffler Set

• Non-removable baffle has a 3.5" diameter.

VT No.	Fits
30-0610	FLT 1995-16



31-0598

30-0741

31-2136

### Muffer Clamp and Bracket Set

• Hardware for various types of muffer fitments.

• Sold as a pair

VT No.	Item	Fits
31-0598	Hanger Bracket Set	FLT 1985-16
30-0741	4" Muffer Bracket Cover Set	FLT 1986-16
31-2136	End Clamp Set	Custom application





30-0243



30-0023



30-3251

31-0280



30-0427



30-0781



30-3026



30-3026 Installed



30-0427 Installed

## Straight Fishtail Kits.

• Kits include pair of straight pipes and brackets.\*Compatible brackets for 30-3251 sold separately, 31-0280. Fit FLT.

Chrome	Black	Length	Bracket Type	Fits
30-0243		29"	Mounting	1985-94
30-0023		29"	Mounting	1995-16
30-3251*		30"	Hanger	1995-16
30-0427	30-3026	30"	Hanger	1995-16
30-0781	30-0783	32"	Channel	1995-16 Scalloped
30-0389	30-3029	33"	Hanger	1995-16
30-0386		33"	Channel	1995-16
30-0816		33"	Channel	1995-16
30-0449		36"	Channel	1995-16
30-0437	30-3028	36"	Channel	1995-16
30-0457		36"	Channel	1995-16
30-0958	30-0960	36"	Channel	2017-up
30-0973	30-0972	33"	Channel	2017-up
<b>Brackets for 30-3251</b>				
31-0280*	Fishtail Exhaust Clamp Set			1995-16

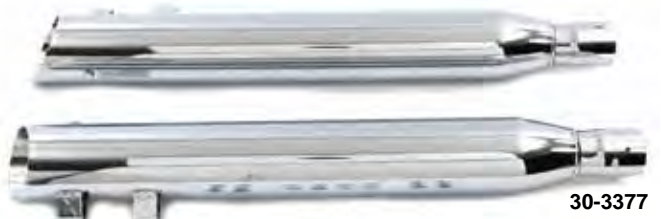

30-3377



30-3378

## Muffler Set for Dresser Dualie.

• Fits 2007-16.

VT No.	Style.
30-3377	Super Slash
30-3378	Straight



**Important Note:** Some items on this page may be emission-related parts subject to California or other emission control laws. Please see note on page 71 for important information regarding emission control regulatory compliance and warranty information.





30-0958 Installed on 2017 Milwaukee 8 model.

## Straight Fishtail Extensions

- Direct bolt on for Milwaukee-Eight 2017-up Touring model.
- Both extensions are straight through without any type of baffles not for legal use in any state or highway.

Chrome	Black	Length
30-0958	30-0960	36"
30-0973	30-0972	33"



## Chrome 36" Fishtail Extension

- Features a straight cut end. Set has an outer diameter of 1 7/8" to fit over 1 3/4" pipes. The straight thru design lets your engine breathe and has a great sound. Sold in a quantity of 2. Order baffle rings, clamps, and mounting hardware separately.
- Fits 1 3/4" pipes.

VT No. 30-0950



30-0349



30-0349 Installed



30-0435



30-0352

## Chrome Dumper Straight Exhaust Pipe Set

- 2 3/8" outside diameter by 28" long, includes removable baffles.
- Pipe set has an original style channel hanging bracket.

VT No.	Fits
30-0349	FLT 1995-2016
30-0435	FLT 1985-1994
30-0352	FLT 1985-1994

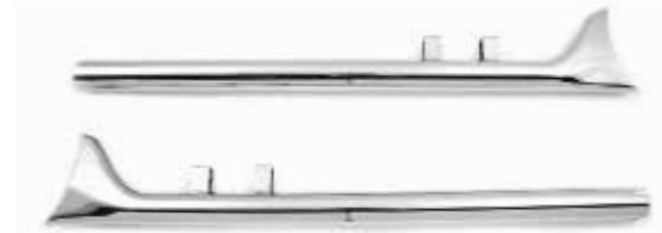

30-0389



30-0386



30-0437



30-0437 Installed

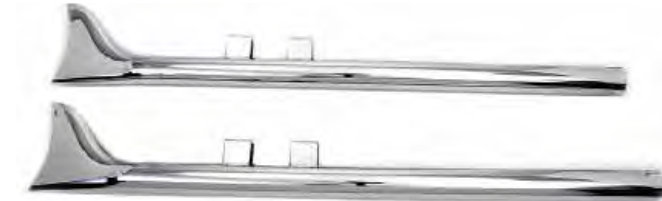

30-3027

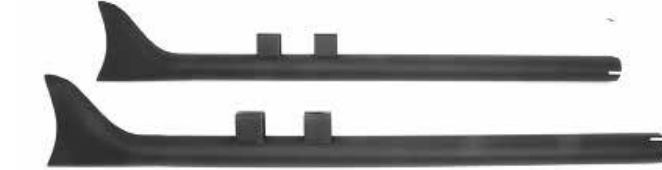

30-3028

**Note:** Straight fishtail extensions do not have baffles and are illegal in all states for highway use.

# Muffler Set



29-0044



## Dualie Straight Pipe Set

- Fits 1995-2016 FLT.
- 2 pipes on each side, hot ride style, with baffles.
- Ends are 2 1/8".

VT No. 30-0847



29-0044



29-0047

## 2 into 1 Exhaust Header Set

- Includes front and rear header featuring turn out ends is welded with chrome covers.

VT No.	Fits
29-0044	FLT 2007-15, Chrome
29-0047	FLT 2007-15, Black

## FLT Mufflers



30-0228

## Muffler Set for 1980-84 FLT-FLHT.

- Available in turnout or fishtail design. Mufflers fit the existing clamps and hangers.

VT No.	Size/Type	Outside Diameter	Body Clamp
30-0228	30" Fishtail	2.5"	31-9976
31-2103	End Clamp		



30-3380



30-0214

## Wyatt Gatling Chrome Fishtail Muffler Set

- 31" long fishtail style mufflers fit the existing clamps and hangers, and have a 3" body diameter. Muffler set features 4" waffle type baffle.

VT No.	Fits
30-3380	FLT, FLHT 1995-16
30-0214	FLT 1985-1994



## Replica Chrome Muffler End Clamps.

- A replica replacement.
- Fit 1985-1994.

VT No. 31-0450



## Chrome 3/4" Muffler Body Clamp Set

- Fits 1995-16 FLT.

VT No. 31-1560





## Emissions and Noise Regulations

### Important Information:

**Disclaimer:** The California Air Resources Board (CARB does not permit the use of aftermarket emission-related parts) that alter the performance of OEM emission-related devices unless CARB has issued an executive order, other than on racing vehicles on closed courses. Check your local laws and manufacturer's information.

**Disclaimer:** Emission related parts for OEM Non-emission control system equipped motorcycles as well as slip on mufflers that mount downstream of and which do not alter the performance of OEM emission-related devices, are considered legal replacement parts by CARB. More California exhaust information is available a [www. arb.aa.gov](http://www.arb.ca.gov).

**Disclaimer:** Aftermarket products, including but not limited to exhausts, fuel, air controllers, air filter kits, camshafts and carburetors and jet kits which alter, modify, or replace emission control devices or systems of an originally compliant highway motorcycle, are not legal for sale or street use in California unless they have been issued a CARB Executive Order. Aftermarket emissions related products which have not been issued an Executive Order or which are not aftermarket Replacement Parts, as defined in Title 13, California Code of Regulations, Section 1900 (b)(2). are authorized for closed circuit race use only. Products shown may be designed, manufactured, intended and sold for closed circuit race use only and use of the same on public roads or lands may be a violation of local, state and/or federal laws. See manufacturer's information and state and local laws to determine what is authorized for your use on your vehicle.

**Disclaimer:** Products shown may not conform to federal, state or local noise regulations.

### Warranty

**Disclaimer:** There is no warranty on exhaust pipes and mufflers with regard to any discoloration. Discoloration (blueing) is caused by tuning characteristics, i.e. cam timing, carburetor, etc. and is not caused by defective manufacturing.

**Disclaimer:** Check your applicable laws and manufacturer's publication(s) and/or website(s) for manufacturer's warranty, maintenance, safety, mounting and any regulatory compliance/non-compliance information.



### Wyatt Gatling Tru-Dual Head Pipe Set

• Includes independent exhaust pipes for both cylinders, chrome full length heat shields and allows the use of OE style mufflers. Has 12mm oxygen sensor bungs. Fits 2010-16 FLT.

VT No. 29-0077



29-1162

### Chrome Dual Pipe Crossover Systems less Mufflers

• Feature intersection of left side cross over at rear pipe, 1 3/4" O.D.

VT No.	Heat shield	Year/Model
29-1162	30-0297	1980-83 FLT



29-1163



30-0307

### Chrome Dual Crossover Exhaust Pipes

• Features intersection of left side crossover at rear pipe for Touring models. Pipes are 1 3/4" outer diameter.

VT No.	Fits
29-1166	FLT 1995-2006
29-1163	FLT 1985-1994
Heat Shields for Above	
30-0307	FLT 1985-2006



29-0079

### Independent Dresser Dual Exhaust Set

• Includes independent exhaust pipes for both cylinders, chrome full length heat shields and allows the use of OE style mufflers.

• By Vance & Hines

VT No.	Fits
29-0079	FLT 1995-2008



30-0585



30-0581



29-1158



29-1156



29-1156



30-0426

### Chrome Crossover Exhaust Header Pipes

• Steel and include heat shields and brackets. 30-0585 includes oxygen sensor.

VT No.	Fits
30-0585	FLT, FLHT, FLHR, FLTR 2007-2008
30-0581	FLT, FLHT, FLHR, FLTR 1995-2006

30-0612



### Chrome 2 into 1 Exhaust Header

VT No.	Fits
29-1158	FLT, FLHT, FLHS, FLHR 1996-2006
29-1156	FLT 1985-1999
<b>Heat Shields for Above</b>	
30-0426	FLT 1991-2006
30-0306	FLT 1985-1999

32-1315



29-1198

### Chrome Crossover Exhaust Header Pipes

• Use original heat shields and clamps.

VT No.	Fits
30-0632	FLT 2010-16
30-0612	FLT 2009
<b>Oxygen Sensor Harness for Above</b>	
32-1315	FLH 2009



30-0328

### Chrome True Dual Exhaust Pipes

• Features independent exhaust pipes.

VT No.	Fits
29-1198	FLT 1999-2006
29-1167	FLT 1995-1998
<b>Heat Shields for Above</b>	
30-0328	FLT 1985-2006



**Jims Oxygen Sensor Wrench** for removing and installing the 4 wire heated oxygen sensors. These sensors must be torqued to 14 ft-lbs. Lending to the design of this tool to be used with a 3/8" drive torque wrench.

• Fits 2010-16 FLT.

**VT No. 16-0382**





30-3157



### Chrome Slash Cut Exhaust Drag Pipe Set

- Slash cut ends and include mounting hardware.
- 30-3375 features O2 sensor bungs.

VT No.	Fits
30-3157	FLT 2007-09



### Vance & Hines Independent Chrome Dual Exhaust Header

- Full length 2 1/8" heat shields.

VT No.	Fits
29-0081	FLT 2009-2016
29-0079	FLT 1995-2008



30-1585

### Vance & Hines Power Dual Header Pipes

- The ticket to style, quality and performance.
- Features 12mm ports and chrome finish.

VT No.	Fits
30-1579	FLT, FLHT, FLHR 2010-16
30-1585	FLT, FLHT, FLHR 2009



30-0351

### Open Core Baffle Set.

VT No.	Tube I.D.
30-0351	2 1/4"
30-1434	1 3/4"

### Shovelhead Pipes for FLT



29-1109

### True Dual Chrome Exhaust Systems

- By Paughco
- Feature a single pipe for each side. Each pipe is independent, rear pipe for the left and front pipe for the right without intersection. Pipes have a 1 3/4" outside diameter. Order heat shield set separately. Does not include hardware. Uses 1 3/4" slip on mufflers

VT No.	Fits	Shield Set
29-1109	1980-83 Shovelhead FLT	30-0316



### Chrome Drag Pipe with Slash Cut End.

- Fits FLT 1980-1984 FLT.
- Includes mounting hardware for Shovelhead models.

VT No. 30-3208
----------------



30-0050

### Baffle Ring Set

- Set is for Samson extreme series exhaust pipe set with a 2 1/4" diameter. Creates back pressure.

VT No.	Fits
30-0050	Custom for Samson Extreme exhaust pipes



37-0977

31-2132

31-1250

31-3979

### Hardware for Exhaust Pipes.

- All hardware is chrome finished

VT No.	Item	Fits
31-1250	Mount Bracket	FLT 1986-2016
37-0977	2 3/8" Pipe Bolt and Spacer Kit	FLT 1985-2016
31-2132	1 3/4" Pipe Clamp Set Custom application	
31-3979	3" Muffler Body Clamp Set Chrome	



30-0763



30-0588



30-0609

## Wyatt Gatling Chrome Slash Cut

- Dual slash-cut crossover system includes headers, heat shields, brackets and slash down mufflers with removable baffles.

- **\*Note:** 30-0609 fits models with O2 sensor.

VT No.	Fits
30-0631	FLT 2010-2016
30-0621	FLT 2009
30-0609*	FLT 2007-2008
30-0608	FLT 1995-2008

## Chrome Tru Dual Oval Crossover Exhaust Header System

- With oxygen sensor ports.
- Includes crossover kit with clamps.

VT No.	Fits
30-0764	FLT 2009
30-0763	FLT 2007-2008
30-0588	FLT, FLHT, FLHR, FLTR 1995-2006



30-1578

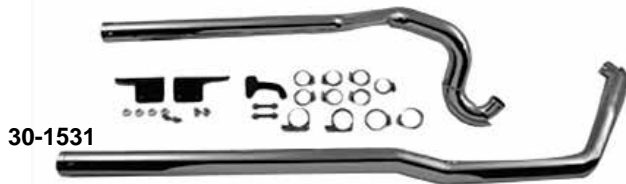

30-1531

30-0867



30-1572

## Big Radius Exhaust Drag Pipe Set

- Feature 2½" full header and muffler heat shield system, slash cut end caps, removable baffles and mounting hardware.

- By Vance & Hines

VT No.	Fits
30-1572	FLT 2010-2011
30-1556	FLT 2007-2008
30-1573	FLT 1999-2006



30-1524

## Vance & Hines Chrome Exhaust Drag Pipe Big Shot Dual Exhaust System

- Gives the bike a clean and uncluttered look.

VT No.	Fits
30-1524	FLT 1995-2006

## Vance & Hines Exhaust Drag Pipe Set

- Include pipes, heat shields, caps, baffles and hardware.

VT No.	Fits
30-1578	FLT 2010-2016
30-1577	FLT 2007
30-1531	FLT 1995-2006
30-0867	FLT 2017-2016



30-0423



### Exhaust Oxygen Sensor Plugs

• If you are doing away with your oxygen sensor, use this threaded plug in its place.

VT No.	Fits
30-0423	FLT 2004-09 18mm
30-0448	FLT 2010-16 12mm

32-6578



### Oxygen Sensor Reducer Plug Set

• Allow the use of late type 12mm sensors in earlier exhaust pipes with 18mm sensor bungs.

VT No.	Fits
32-6578	Custom application

31-1069



### Individual Header Pipe Components

• Clamp and bracket set, as well as specific pipe sections.

VT No.	Item	Fits
31-1069	Exhaust Clamp & Bracket Set	FLT 1995-2008
30-0637	Front Exhaust Header Pipe	FLT, FLHT 2010-13
30-0615	Front Exhaust Header Pipe	Custom application
30-0614	Rear Exhaust Header Pipe	FLT 2009-2013



48-0125

48-0157



### Stainless Steel Tie Wraps

• For securing exhaust wrap to pipes.

VT No.	Length	Qty.
48-0125	14"	4
48-0157	11 <sup>3</sup> / <sub>16</sub> " 300 mm x 7.9 mm x .25mm	10



16-1131



16-1132

### Oxygen Sensor Removal Tool

• Easily removes or installs sensors on fuel injected models.

Fits FLT 2006-16	
VT No.	Application
16-1131	7/8" wrench or 3/8" drive
16-1132	3/8" drive for 12mm sensors



16-1385



16-1386

### Oxygen Sensor Plug Thread Chaser Tool

• Used to repair damaged sensor threaded bungs in exhaust pipes.

VT No.	Size	Fits
16-1386	12mm	FLT 2010-2016
16-1385	18mm	FLT 2007-2009



### Oxygen Sensor Sealing Washer

VT No.	Year	MM
15-0081	2006-11	18
15-0012	2011-up	12



48-0126

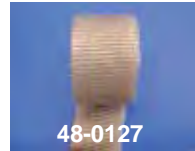

48-0127



48-0132

### High Temperature Exhaust Wrap

Hot exhaust pipes bothering you? Don't sweat it, wrap your exhaust pipes in this heat resistant material. Material withstands continuous heat of about 1200F & 2000F intermittent temperatures.



48-0131

VT No.	Color	Size
48-0126	Black	25' x 2" x 1/16"
48-0127	Tan	25' x 2" x 1/16"
48-0132	Black	25' x 1.5mm
48-0131	White	25' x 1.5mm



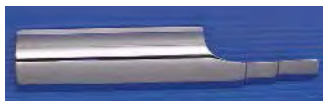

30-3245



30-3244



30-0256

30-1271



30-1272

### Chrome FLT Heat Shields

• Fit 1983-2016 models and fit stock heat pipe.

VT No.	Year	Type
30-3245	1992-16	Low, Right, Rear
30-3244	1983-16	Left, Top
30-0256	Clamp for Above, sold each	
30-1271	2009-16	Front Right
30-1272	2009-16	Rear Left



30-3371  
Installed

### Chrome Extended Front Heat Shield

• Covers exposed exhaust pipe adjacent to rider footboard. Uses stock mounting hardware.

VT No.	Fits
30-3371	FLT 2000-08



30-0120



30-0474



30-0121



30-0122



30-0123



30-0124

### Chrome Universal Heat Shields

• Mounting clamps included.

For 2 1/4" Pipes	
30-0120	4"
30-0474	6"
30-0121	10"
For 1 3/4" Pipes	
30-0122	10"
30-0123	12"
30-0124	18"



30-0221



30-0245

### Chrome Replica Heat Shields

• Fit 1 3/4" to 2 1/4" exhaust pipes.

For custom application	
VT No.	Length
30-0221	5 1/2"
30-0245	9"



30-3241



30-0244



30-3242



30-0215

### Chrome Stock Heat Shields

• Fit stock header pipes.

VT No.	Application	Fits
30-3241	Rear	FLT 1983-1997
30-0244	Lower	FLT 1981-1991
30-3242	Lower Right Side	FLT 1992-2016
30-0215	Front	FLT 1981-1988



30-0109



30-0106



30-0118



30-0117



30-3385



30-3386

### Chrome Custom Cut Universal Heat Shields

• Mounting clamps included.

Chrome	Black	Dia.	Length
30-0109	Perforated		9"
30-0106	Smooth	1 3/4"	7"
Skull			
30-3385	30-0466	2 1/4"	9"
30-3386	30-0467	2 1/4"	12"
30-0468	30-0471	1 3/4"	9"
Flame			
30-0470	30-0472	1 3/4"	12"
30-0118		1 3/4"	8"
30-0117		1 3/4"	11"
30-0481	30-0483	1 3/4"	9"
30-0482	30-0484	1 3/4"	12"
30-0473	30-0479	2 1/4"	9"
30-0478	30-0480	2 1/4"	12"



30-0321



30-0362



30-0365

### Chrome Custom Universal Heat Shield

• Available with grooved or flame pattern. Made from aluminum, mounting clamps included.

For custom application		
4"	6"	Style
30-0321	30-0362	Grooved
30-0364	30-0365	Flame



# Kickstand for FLT



27-1694



27-1695



27-1736



27-0987



13-9162



13-0182



13-0545



28-0400

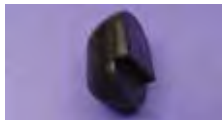

28-0437

## Chrome Kickstand and Springs

• To fit FLT stock as replacement.

VT No.	Year	Item
27-1694	1983-90	Kickstand with spring
27-1695	1991-06	Kickstand Leg Only
27-1817	1984-06	Kickstand Leg 1"
27-1736	1991-06	Kickstand with spring
27-0987	2007-up	Kickstand Leg Only
27-0998	2007-up	Kickstand with spring

### Springs Only

13-9162	1985-98	Chrome
13-0182	1999-06	Chrome
13-0545	2007-up	Chrome
13-0351	1999-06	Black
13-0350	2007-up	Black
28-0400	1985-2000	FLHR, FLHT, FLR Bumper Pad
28-0437	2001-2006	FLT, FLH Bumper Pad



## Chrome Kickstand Tab Kit

• Includes washer, acorn nut, and tab.

• Fits 1985-06 FLT.

VT No. 27-0546



27-0540



27-0539

27-0539 shown with 27-0536 extension

## Chrome Kickstand Kit

• Includes jiffy stand, leg, spring, bracket and bumper stop.

VT No.	Fits
27-0539	FLT 1985-2000
27-0540	FLT 2001-2006
27-1007	FLT 2009-up
27-2101	Extension Kit, FLT 1991-up

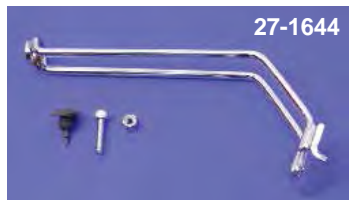

27-1644



27-0536



27-1275



27-1440



27-0091

## Kickstand Extension Kits

• Allow rider to more readily access side stand.

• Requires drilling 1/4" hole through kickstand.

VT No.	Model
27-1644	1984-90 FLT, 1986-06 FXST, FLST
27-0536	1984-90 FLT, 1986-06 FXST, FLST
27-1275	1991-up FLT, chrome
27-1440	1991-up FLT, black
27-0091	1991-up FLT



27-0526



27-1525

## Kickstand Mount Brackets

VT No.	Year
27-0526	1981-08
27-1525	2009-up



Hex

Stock

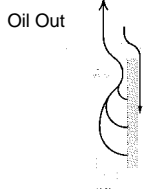

*Oil flows in around the outer diameter, through the filter media and out passing by the magnet. The magnet captures particles less than 10 microns which could have escaped through the filter wall.*

### Magnetek™ Oil Filter.

- Feature a magnetic ring in center tower to trap particles less than 10 microns which could have escaped thru the filter wall.
- Available in stock style or with built in hex nut.

Hex	Stock	OEM	Fits	Length
40-0864	40-0852	63796-77	1980-98 FLT	3.75"



35-6105



35-6106



35-6104



35-6109

### Fuel Filters.

VT No.	Fits	Item
35-6105	2007-08, FLT, FLHT, FLHR, FLST	Fuel Filter
35-6106	1995-01 FLT, FLHT, FLHR	Fuel Filter
35-6104	2002-07 FLHT, FLT, FLHR	Fuel Filter
35-6108	2000-07 FLHT, FLHR	Line
35-6109	1995-01 FLT, FLHT, FLHR	Fuel Filter



### Twin Cam Vent Line

- Replaces stock rubber vent hose from engine to transmission. Includes all necessary fittings. Fits 2002-06 FLHR, FLT, FLH. Stainless steel.

VT No. 40-0031



12-9990



### TC-88 Super Pump.

- By Sifon utilizes an oversized highly efficient Geo Rotor design. Provides a 40% increase in pump volume and a 60% more scavenging volume. This high volume pump bolts into the stock location and includes O-Rings and mounting hardware

VT No.	Fits
12-9902	1999-06 FLT
12-9990	2007-2016 FLT



### Motorshop™ Brand Filter Pack.

- Includes 6 pieces of individually wrapped and numbered chrome filters with 3" outside diameter and length as listed.

Chrome	Black	OEM	Type	Length
40-0198	40-0836	63782-80T	1982-84	2½"
40-0233	40-0838	63798-99	1999-up	¾"



### Spin-On Oil Filters.

- Replaces stock units in chrome or black, Perf-form or V-Twin Brand in stock or with hex nut.
- Perf-form Tall Chrome Filter is ¾" longer than stock and will not fit fuel injected models. All filters listed are low restriction type.
- Length is 3.75"

Hex	Stock	OEM	Finish	Fits
40-0860	40-0708	63805-80T	Black	1980-98 FLT
40-0872	40-0709	63796-77T	Chrome	As Above



### K&N Spin-On Oil Filters

- Available in chrome or black finish. Feature hex nut end for easy removal and installation, improved pressure relief valve, anti-drain back valve and heavy duty base plate with improved rolled seal.

Chrome	Black	Fits	Length
40-1710	40-1711	1980-98 FLT	3.75"





40-1500



40-1520



40-2527

## Jagg Oil Coolers

- Features multipass oil flow configuration, specially designed turbulators in each oil passageway, and highly concentrated mini louvered air fins.
- Available in various mounting orientations.

Vertical Mount		
40-1500	Black	FLT 1984-13 w/o ABS
Horizontal Mount		
40-1520	Chrome	FLT 1984-2008
Low Horizontal Mount		
40-2528	Black	FLT 1984-2008
40-2527	Black	FLT 2009-up



40-0886



40-0885

## Oil Temperature Dipsticks

- Features a hex design, lighted LCD readout, Fahrenheit or Celsius operation and a replaceable battery.

VT No.	Fits
40-0890	FLT 2017-up
40-0886	FLT 2007-2016
40-0885	FLT 1999-2006



40-0024

## Radium Engine Oil Filler Kit

- CNC machined from 6061-T6 billet aluminum
- A thread in one piece dip stick which eliminates dip-stick blow out on acceleration.

VT No.	Fits
40-0022	FLT 1993-1998
40-0023	FLHT 1999-2001
40-0024	FLHT 2002-2006



40-0661

40-1274

40-1281

## Custom Oil Dipsticks

- Chrome finish and designs as noted.
- For FLT

Style	1993-1999	2000-2006	2007-16
Smooth	40-0661		
Skull	40-1274	40-1278	40-0624
Flame	40-1281	40-1273	40-0625



40-0471

## Dual Oil Cooler Kit

- Includes dual tube vertical oil cooler with billet mount clamps measuring 10" long and 4 1/8" at top diameter.
- Stainless steel braided lines and 4 chrome seal ends included.

VT No.	Fits
40-0471	FLT 1998-2016



## Chrome Skull Air Cleaner Kit

- Includes bolts, brackets, and skull air cleaner cover.
- Air Cleaner ring holds outer cover in place on air cleaner.

VT No.	Fits
34-1506	FLT 1993-1999



34-0467



34-0625



### Velo Air Cleaner Backing Plate Kit

- Includes one piece alloy backing plate, washable element, stainless steel breather kit with fittings, chrome breather filter and mounting hardware.

VT No.	Cover Size	Fits
34-1105	7"	FLT 1993-2007
34-1076	8"	FLT 1993-2007



34-0596



34-1241



34-0638



34-0640



34-0703



34-0702

### Billet Scoop Air Cleaner

- Includes filter and mount brackets.
- Fits FLT 1993-1999

VT No.	Style
34-0703	Flame
34-0702	Smooth



34-0620



34-1070



### Chrome V-Charger Air Cleaner

- Features scoop "blower" design and includes a built-in chrome screen and filter element. Kits come with bracket and/or integral bracket, and breather system. Air filter measures 2" wide, 4" inner diameter, and 5 $\frac{5}{16}$ " outer diameter.

Full Kits		
VT No.	Style	Fits
34-0467	Raised Bevel	FLT 1984-1991
34-0625	Smooth	FLT 1992-2007
34-0596	Smooth Bevel	FLT 1993-2007
34-1241	Raised Bevel	FLT 1999-2006 with Carburetor, FLT 2002-2016 with EFI
Air Cleaner Assemblies Only		
34-0638	Raised Bevel	FLT 1990-2007
34-0640	Flame	FLT 1990-1992
34-0620	Smooth	Custom application for S&S E carburetor
34-1070	V-Charger	Replacement



34-1738

### Mesh Air Cleaner Kit

VT No.	Style	Fits
34-1738	Skull	FLT 2008-2016
34-1735	Skull	FLT 1993-2007
34-1742	Swiss Cheese	FLT 1993-2007
Cover Only		
34-0276	Swiss Cheese	Custom application
34-0280	Skull	Custom application



34-1113



34-0655

### From Sifton Air Power Air Cleaner Kit

• Includes die cast backing plate, filter, and breather canister.

VT No.	Item	Fits
34-1113	Air Cleaner Kit	FLT 1993-2007
34-0655	Teardrop Cover	FLT 1990-2006



### Tear Drop Air Cleaner Assembly

• Features high flow element with billet mount bracket and plate. Kit includes all hardware to mount on Evolution and TC-88 models.

VT No.	Fits
34-0672	FLT 1993-2007



34-2124 Installed



34-2124



34-2122

### Air Cleaner

VT No.	Item
34-2124	Stage 1 Air Cleaner Kit, 2002-07
34-2122	High Flow Kit EFI 2008-2016
34-2127	90° Filter Assembly



34-0700

### Velo High Flow Air Cleaner Assembly

• Features a cast mount bracket with built-in breather and filter.  
• Includes breather bolts and hardware to mount to 1992-up Evolution and TC-88 models.  
• Order cover separately.

VT No.	Fits
34-0700	S&S FLT 1992-2005
34-1163	CV Air Cleaner Backing Plate



34-0483



34-0484



34-0485

**Air Cleaner Assemblies** include intergrater breather bracket and related hardware. Fits 1993-07.

VT No.	Item
34-0483	Chrome Cover
34-0484	Chrome Cover
34-0485	Black Skull





34-0566



34-1064



34-1028



34-0548

## Round Air Cleaner Covers

• Feature embossed designs and center screw mounting. For CV type carburetors with stock backing plate.

VT No.	Diameter	Style	Fits
34-0566	7"	Smooth	FLT 1999-2007
34-1064	8"	American Motorcycle	FLT 1990-1999
34-1028	8"	V-Logo	FLT 1990-1999
34-0548	8"	Smooth	FLT 1990-1992



34-1053



34-0947

## 8" Round Air Cleaner Assemblies

• Filter element, backing plate, and cover included.

VT No.	Style	Fits
34-0407	Smooth Black	FL 1993-2007
34-1053	V Logo Chrome	FLT 1990-2007
34-0947	Smooth Chrome	FLT 1990-2007



34-0115

## Air Filter Upgrade Kit

• Includes washable filter and studs.

VT No.	Fits
34-0115	FLT 1999-2016

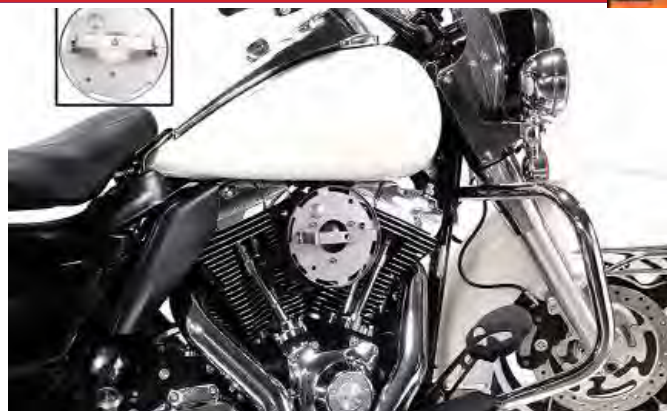

34-1428



34-1044



34-1369

## Backing Plate

• Made of steel.

VT No.	Fits
34-1428	FLT 2008-2016 EFI
34-1044	FLT 1993-07 CV
34-1369	FLT 2008-2016 TC models



## Chrome Air Cleaner Breather Snoot

• Fits FLT 1990-1992.

VT No. 34-1081



Caution: These products are not legal for sale or use in California on pollution controlled vehicles. These products are intended for non-highway only.





34-0067



34-0080



34-0081

### Heavy Breather Air Cleaner.

Chrome	Black	OEM
34-0067	34-0068	28716-10A
34-0080	34-0081	29098-09
34-0082	34-0083	29080-09

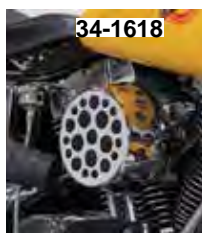

34-1618

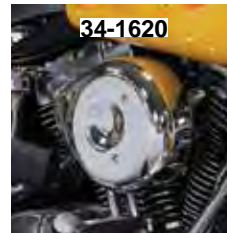

34-1620



34-1621

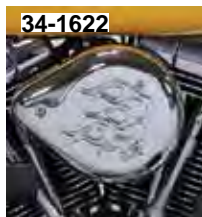

34-1622



34-1623

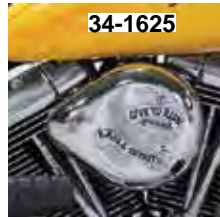

34-1625



34-1624



34-1361



34-1365

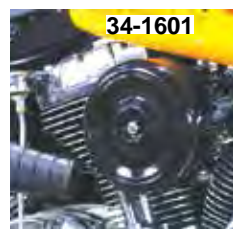

34-1601



34-1602

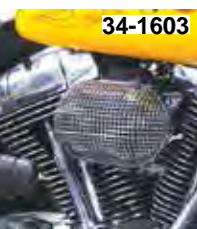

34-1603

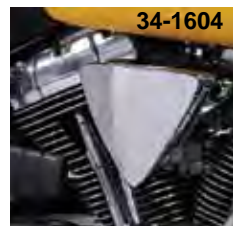

34-1604

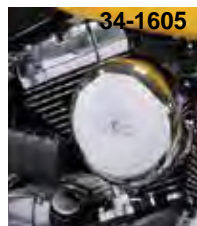

34-1605



34-1606

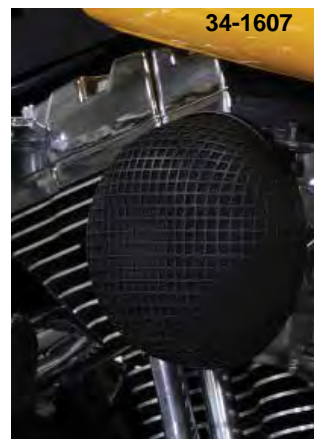

34-1607

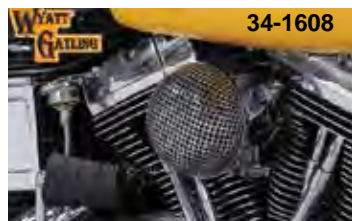

34-1608

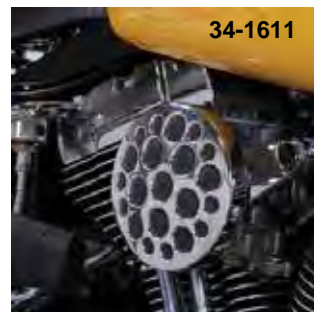

34-1611

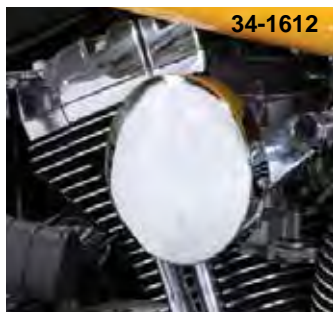

34-1612

## Wyatt Gatling Air Cleaner Assemblies

- Include integral breather system with bracket, mounting kit and air cleaner.

- Includes air filter element.

DIY easy install bolt-on assembly has no hoses to connect!

BT Assemblies fit 1993-2007 FLT

\*Note: Fits 1990-92 FLT

Assembly	Air Cleaner	Shape	Style
34-1601	34-0406	Round	Black, 7"
34-1602	34-0764	Oval	Black, Mesh
34-1603	34-0746	Oval	Chrome, Mesh
34-1604	34-1206	Diamond	Billet
34-1605	34-1373	Round	Chrome, 7"
34-1606	34-0475	Oval	Chrome
34-1607	34-0742	Round	Black, Mesh
34-1608	34-0732	Round	Chrome, Mesh
34-1609*		Velocity Stack	Chrome
34-1611	34-0762	Round	Chrome, Drilled
34-1612	34-0763	Round	Chrome, Baby Moon
34-1613	34-1374	Oval	Chrome, Late Style
34-1614	34-0628	Teardrop	Chrome, Maltese
34-1615	34-1735	Round	Chrome, Skull Mesh
34-1617	34-1429	V-Charger	Chrome, Skull
34-1618	34-1742	Round	Chrome, Hole Pattern
34-1619*	34-1081**	Breather Snoot	Chrome
34-1620	34-1022	Teardrop	Chrome, Smooth
34-1621	34-0530	Teardrop	Chrome, Finner
34-1622	34-0511	Teardrop	Chrome, Flame
34-1623	34-0630	Teardrop	Chrome, Slotted
34-1624	34-0629	Teardrop	Chrome, Skull
34-1625	34-1020	Teardrop	Chrome, Live to Ride
34-1361		V-Charger	Chrome, Flame
34-1365	34-1334	Inverted	

\*\*Note: Does not include filter element





**Crankcase Breather and Bracket Kit** allows installation of aftermarket CV type air cleaner on models with CV carb or EFI system. Includes bracket, filter, hose and mounting hardware.

VT No.	Fits
<b>35-0122</b>	1993-98 FXST, FLST, 1993-98 FLT 1993-98 FXD (Includes Evo bolts)
<b>35-0125</b>	1999-2015 FXST, FLST, 1999-2007 FLT 1999-up FXD (Includes Twin Cam breather bolts only)
<b>40-0350</b>	Filter for Above



**Air Cleaner Adapters** allow installation of Dragton II air cleaner to models listed. Plain machine finish.

VT No.	Fits
<b>34-1326</b>	2008-14 FLHT, FLHX, FLR FLTR and FL Trike
<b>34-1327</b>	2001-14 w/Delphi EFI except 2008-14 Dressers and FL Trike

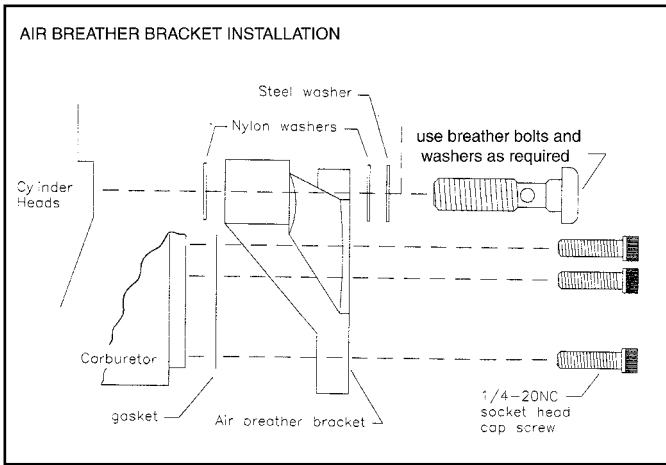

**Sifton Carburetor Bracket**  
**No Hoses Needed!**



**34-1369**  
**Air Cleaner Adapters**

- Will mount any CV carburetor air cleaner to performance aftermarket carburetor kits.
- Simply order any CV air cleaner and appropriate adapter flange for bolt on installation.

**Chrome Billet Support Brackets** allow crankcase to breathe back into the carb on throttle body so no external hoses are required.  
For use on 1993-98 Evolution and 1999-up Twin Cam models. Allow use of CV on S&S "E" bolt pattern air cleaners or velocity stacks to be installed on models listed.

<b>1993-07 FLT w/carb or EFI</b>
<b>34-0661</b> 1993-07 FLT with carb or EFI or S&S "E" type air cleaners or velocity stack to be installed in horizontal or vertical position.
<b>34-1519</b> 1993-up includes Evo & TC bolts
<b>34-0713</b> 1999-up includes TC breather bolts only 1999-07 FLT with carb or EFI. Allows the installation of CV type air cleaners

**34-0705**  
**2008-2016 FLT with 50 mm throttle body.**

**34-1369** Mounting Bracket  
**Replacement Bolts for Above Brackets.**

<b>35-0791</b>	Bolt Set	Evolution
<b>35-0792</b>	Bolt Set	TC-88





34-0941



34-0566 Installed on 34-0940

From Sifton

### Performance Air Cleaner Kit

• Includes element, and backing plate.

VT No.		Fits
34-0941	Full Kit	FLT 1999-2007
34-0944*	Filter Kit	FLT 1999-2007
34-0940*	Filter Kit	FLT 1992-1999
34-1390	Backing Plate	FLT 1999-2016

\*Note: Does not includes cover



34-1289



34-1290

### Sifton Air Cleaner Kit

• Includes a hi-flow "cycovator" filter with an integral metal backing plate for a direct bolt on application to carburetor and EFI models.

VT No.	Fits	Skull
34-1289	FLT 2008-up	34-1738
34-1290	FLT 1993-2007	



34-0809 Installed



34-0807 Installed

### Velo Dish Air Cleaners

• Chrome dish and full flow filter with bracket that has integral breather passages and hardware.

VT No.	Size	Fits
34-0809	6"	FLT 1991-2007
34-0807	8"	FLT 1993-2007
34-0533	Cover Only for 34-0807	FLT 1993-2007



34-0550



34-0555



34-0905

From Wyatt Gatling

### 7" Eagle Spirit Round Air Cleaner

VT No.	Fits
34-0550	FLT 1990-2007
34-0555	FLT 1990-1992
34-0905	Replacement filter



34-1255

### Cycovator Hi-flow Air Cleaner Kit

• Includes filter element, backing plate, integral bracket, breather bolts, gaskets, and hardware

VT No.	Item	Fits
34-1255	Full Kit	FLT 1992-2007
34-0098	Breather Bolts	FLT 1992-2016 Except 1995-01 EFI



### Chrome Air Scoop

• Mounts on left side top motor mount studs. Air scoop offers improved cooling and acts as a horn cover.

VT No.	Fits
42-1010	FLT 1991-2016



34-0732



34-0742



34-0506



From Wyatt Gatling

### Chrome Round Air Cleaner

- With chrome mesh includes element, backing plate, and screws for a Bendix carburetor.

VT No.	Fits
34-0506	FLT 1979-1989
34-0906	Filter for dragton type housings



34-0501



34-0733



34-0711



34-1325

From Wyatt Gatling

### Round Mesh Air Cleaners

- Element included.



VT No.	Style	Fits
34-0732	Chrome	FLT 1990-2007
34-0742	Black	FLT 1990-2007
34-0501	Chrome	FLT 1979-1989
34-1325	Black	FLT 1979-1989
34-0733	Chrome	S&S E Carburetor
34-0711	Foam Air Filter	For Above



34-1318



34-1318

From Wyatt Gatling

### New Era Air Cleaners

- Cleaners include chrome or black cover, filter, & backing plate.
- Fits FLT 1990-07 with CV Carburetor

VT No.	Finish
34-1095	Chrome
34-1318	Black



34-0802



34-0553

34-1041

34-1042

### 7" Round Air Cleaner

Includes with breather tube, backing plate, and foam element. For CV type carburetor.

VT No.	Item	Fits
34-1373	Kit w/o Brackets, logo	FLT 1993-2007
34-1032	Kit w/o Brackets, smooth	FLT 1993-2007
34-0553	Above with Brackets	FLT 1990-1992
34-1044	7" CV, Backing Plate	FLT 1990-2006
34-1041	7" Smooth, Cover Only	FLT 1979-1989
34-1042	7" V-Logo, Cover Only	FLT 1979-1989

### New Era Air Cleaner Kit

- Includes chrome air cleaner, mounting bracket, and breather kit to fit stock Keihin carburetors. Filter sold separately.
- Fits 1993-99.

VT No.	Finish
34-0802	Chrome
34-0937	Screen
34-0977	Foam



34-0475

### Oval Air Cleaner Assembly

- For CV carburetors includes chrome cover, filter element, backing plate, and two cover screws.
- Screws for mounting to carburetor are not included.

VT No.	Fits
34-0475	FLT 1993-2007
34-1350	FLT 1990-2007, Backing Plate



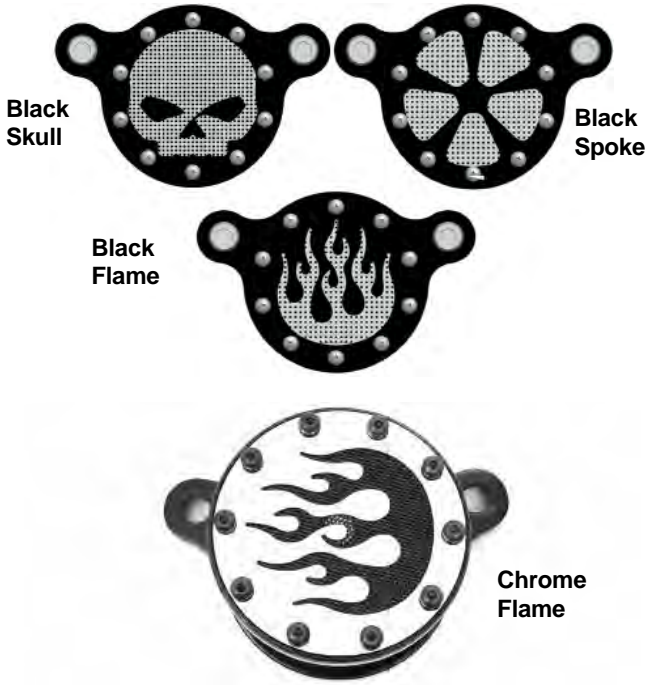

Fits FLT 2008-2016

Style	Black	Chrome
5 Spoke	34-0233	34-0242
Skull		34-0243
Flame		34-0244

Fits FLT 2000-2007

5 Spoke	34-0236	34-0245
Skull	34-0237	34-0246
Flame	34-0238	34-0247



34-0843



34-0844

## Wyatt Gatling Chrome Skull Air Cleaner

- For CV carbs in black or chrome finish.
- Fits FLT 1993-07

VT No.	Style
34-0843	Chrome
34-0844	Black

34-0705

34-0661



## Air Cleaner Breather Brackets

- Include bolts and chrome bracket.

VT No.	Year
34-0705	1993-07
34-0661	1992-07



34-2122 Installed



34-1236

## Air Cleaner Kit

- Includes backing plate, air filter, breather manifold & hardware.

VT No.	Fits
34-1236	2002-2007
34-0943	1999-2007
34-2122	2008-up, Wyatt Gatling



34-0762

34-0763

From Wyatt Gatling

## Chrome Air Cleaners

- Washable element

Cleaner	Element	Style	Fits
34-0762	34-0079	Drilled	FL 1993-2007
34-0763	34-0079	Baby Moon	FLT 1993-2007
34-0510	34-0079	Drilled	FLT 1979-1989
34-0512	34-0079	Smooth	FLT 1979-1989





34-0664



34-0657



34-0650



### Chrome Tear Drop Air Cleaners

• CV type carburetors. Includes cover, backing plate, filter, rubber hose and hardware.

• Fits FLT 1999-2007

Finned	Smooth	Flame
34-0664	34-0657	34-0651

• Fits FLT 1992-1999

34-0663	34-0656	34-0650
---------	---------	---------

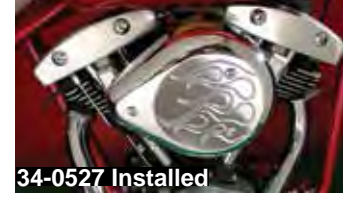

### Chrome Tear Drop Finned Air Cleaner & Breather Kit

• Includes a chrome air cleaner assembly with a finned teardrop cover, chrome mount bracket, backing plate, and a breather kit with a black hose and breather unit.

• Fits FLT 1990-07

VT No.	Style
34-1022	Smooth 34-0916 filter, 34-1054 Plate, 34-0515 Cover
34-0511	Flames
34-0530	Finned, 34-0916 filter, 34-1054 Plate, 34-1560 Cover
34-0630	Slotted
34-0628	Maltese
34-0629	Skull and Crossbones
31-0430	Air Cleaner Mount Kit 1992-98 FLT

34-1528



34-1527

### Siren Air Cleaner Assembly

• Includes chrome cover, backing plate and hardware.

VT No.	Fits
34-1528	FLT 2000-2007
34-1527	FLT 1992-1999



## Teardrop Air Cleaner Assembly

- Includes the filter and back plate for Keihin and CV carburetors, and also EFI.

VT No.	Fits
34-2123	FLT 1993-2007 Except 1995-2001 EFI



From Wyatt Gatling

## Chrome Scoop Air Cleaner

VT No.	Fits
34-0985	Custom for S&S E and G carburetor



From Wyatt Gatling

## Chrome Scoop Air Cleaner Cover

- \*34-0455 includes cover, backing plate, and filter

VT No.	Fits
34-0455*	FLT 1990-2007



34-0668 Installed



## Chrome Billet Sweeper Air Cleaner

- Fits CV carburetors. Order mount brackets separately.

VT No.	Fits
34-0668	FLT 1990-2007



34-0822



## High Flow Air Sweep Cleaner Kit

- Includes a low restriction filter.
- Backing plate kit includes air cleaner element, gasket, and mounting hardware.

VT No.	Item	Fits
34-0822	Air Cleaner Kit, FLT 1993-2007	
34-0948	Air Filter Replacement for Stage 1 kits	
34-1182	Replacement studs for velocity air cleaner	



## Sifton Dual Breather Kit.

- Includes 2 vent canisters, banjo bolts, for Evolution and TC-88 models with necessary fittings. The breather is on the top of the canister.

VT No.	Brand	Fits
35-0441	Dual Vent Kit	FLT 1992-2007
34-0500*	Breather Bolt and Banjo Kit	FLT 1992-2007



34-0400



34-0401



34-0444

## Chrome Oval Air Cleaner Cover.

- Steel oval air cleaner cover has a chrome finish.
- Insert also available.

VT No.	Application	Fits
34-0400	EFI	FLT 2000-2007
34-0401	Carburetor	FLT 2000-2007
34-0444	Insert for above	FLT 2000-2006





40-0346 installed on 34-1174



40-0346

### Chrome Acorn Billet Canister Set

• Made from chrome billet aluminum and comes with bolts for Evolution and TC-88 models.

VT No.	Item	Fits
40-0346	Full Set	FLT 1992-2007
40-0345	Single Canister	Custom for crossover metal tubes



31-0430

### Crankcase Breather and Bracket Kit

• Fits CV carburetors. Includes two 3/8" x 16 and 1/2" x 13 threaded breather bolts. Fits 1992-98 FLT.

VT No. 31-0430

34-0772



### Chrome Panzer Air Cleaner

• Can be installed on CV or S&S Super E carburetor.

VT No.	Style
34-0772	Slotted
34-1880	Round Holes

34-1882



### Chrome Billet Air Cleaner Kit

• For CV and EFI models.  
• Kit includes air filter element, chrome mounting bracket, and breather connectors.

VT No.	Fits
34-1882	FLT 1993-2007



### Velo High Flow Air Cleaner Assembly

• Features a one piece alloy back plate with chrome eagle spirit cover. Includes element, breather kit and mount hardware. For fuel injected 2002-2016 FLT

VT No. 34-0804

### Miscellaneous Air Cleaner for FLT

34-1286	Tapered Air Cleaner Assembly, FLT 1992-1999 FLT
34-1299	Hi Flow Chrome Air Cleaner with Skull, 2000-16 FLT
34-0469	Chrome EFI Bracket, Fits 2008-16
34-0927	Backing Plate, 2008-16



34-0773  
Installed



34-0773

### Cycovator Air Cleaner Kit

• Forward mount air cleaner kit with tapered air filter

VT No.	Fits
34-0773	FLT 1993-2007 Except 1995-2001 EFI





34-0594

### Eagle Spirit Air Cleaner Insert

- With gold inlay.

VT No.	Fits
34-0594	FLT 1999-2016

34-0557



34-0558



### Eagle Spirit Air Cleaner Inserts

- Gold or chrome inlay fit recessed area of round center screw type units.

VT No.	Finish	Fits
34-0557	Chrome	FLT 1984-1999
34-0558	Gold	FLT 1984-1999



34-0050



34-0051

From Wyatt Gatling

### Skull Air Cleaner Insert

- With a black raised skull for 7" or 8" air cleaners.

VT No.	Size	Fits
34-0050	7"	FLT 1999-2016
34-0051	8"	FLT 1984-1999



34-1431

34-1432

34-1433



34-1434

34-1435

34-1436



34-1437

34-1438

34-1439



34-1440

34-1441

From Wyatt Gatling

### Air Cleaner Inserts

- Features gold, chrome, or black inlay on a round chrome or black backing plate.
- Fit 1999-2013 FLT

Style	Chrome/Chrome	Gold/Chrome	Black/Chrome	Chrome/Black	Gold/Black
Eagle	34-1431	34-1433		34-1432	34-1434
Skull	34-1435		34-1437	34-1436	
Flame	34-1438	34-1440		34-1439	34-1441



34-0060

34-0088

### Air Flow Air Cleaner Insert.

- Available in chrome or black finish
- Includes mounting hardware
- Fits 1999-15 Big Twin except 2008-15 FXD and 2014-15 FLT models. For use with stock type air cleaner cover.

VT No.	Finish
34-0060	Black
34-0088	Chrome



34-1677

Air Cleaner Insert  
VT No. 34-1677



40-0452

### Sifton Chrome Dual Canister Set.

- Includes dual canisters and hardware.

VT No.	Fits
40-0452	FLT 1992-2016
40-0892	FLT 1999-2016



**Exposed Filter.** Fits 2008-2016 FLT.  
**VT No. 34-1672**

### 34-0451 Installed



34-0451

### Chrome Curved Air Cleaner Breather.

- Includes steel bracket with breather bolts and tapered filter element with chrome 90° intake tube to face forward on CV carburetors
- Fits FLT 1993-2007 Except 1995-2001 EFI

VT No.	Item
34-0451	Full Kit
34-0771	Breather Only
34-0274	Air Filter Replacement



### Carburetor Vent Fittings

VT No.	Angle	Notes
40-0581	Straight	All models, pack of 5
40-0532	90°	FLT 1979-1999, pair

**42-0532** Live to Ride" medallion measures 3½" in diameter, has a chrome finish, and an adhesive backing.



35-8025

35-8029

35-8032

**Chrome CV Carburetor Top** replaces black plastic cover on 1990-up Big Twin models.

VT No.	Type
35-8025	Smooth
35-8029	Eagle Spirit
35-8032	Ball Mill



40-0436



40-0446



40-0449



40-0450

### From Sifton Dual Breather Kit

- Chrome canister features enclosed breather filter and removable bottom cover for cleaning.
- Includes bolts, banjo tubes, and canisters.

VT No.	Item	Fits
40-0436	Full Kit	FLT 1992-2016
40-0446	Breather Canister	
40-0449	Tube Kit	
40-0450	Straight Tube	



40-0588



40-0451

From Sifton

### Chrome Mini Crankcase Breather Vent Set

- 40-0451 includes 2 canisters and banjo tubes with hardware.
- 40-0588 includes tie wraps and longer banjo bolts.

VT No.	Fits
40-0588	FLT 1992-2016 Except 1995-2001 EFI
40-0451	FLT 1992-2016 Except 1995-2001 EFI



35-0163

### Chrome CV Carburetor Cover

Cover without choke cable mount.

VT No.	Style	Fits
35-0163	Yost	FLT 1990-2006





34-0775



34-1211



34-0671



34-0770



34-0673



34-0693

## Chrome Cone Air Cleaner

• Features cone and integral breather mount bracket for vertical or forward mounting.

VT No.	Item	Fits
34-0775	Kit for Super E Carb	FLT 1992-07
34-1211	CV Carb Only	FLT 1993-07
34-0670	Horizontal	FLT 1993-2007 Except 1995-2001 EFI
34-0770	Breather Only	FLT 1993-2007
34-0671	Air Filter	Spike air cleaner breather
34-0673	Adapter Plate	Custom for S&S E Carburetor
34-0693	Adapter Plate	FLT 1993-2007



34-0076



34-0077

## K&N AirCharger® Intake Kits

• Features a mandrel bent mirror polished intake tube and a chrome top conical shaped K&N High flow air filter.

VT No.	Fits
34-0076*	2001-07 FLT
34-0077	2008-16 FLT

\*Note: Fits fuel injected models only



34-1374

## Oval Air Cleaner Assembly

• For CV carburetors which features late style shape chrome cover.

VT No.	Fits
34-1374	FLT 1993-2007 Except 1995-2001 EFI

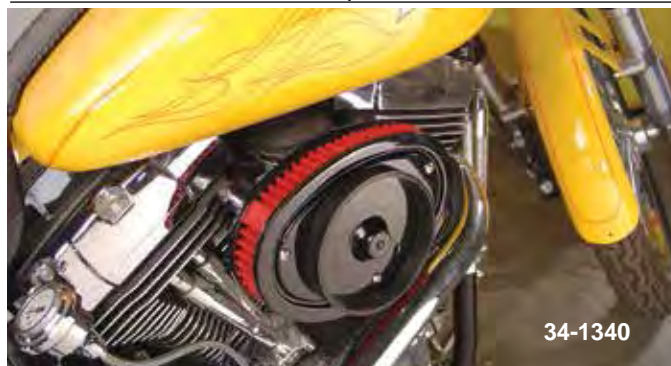

34-1340



34-0062 Kit with cover



34-1340 installed

## Cycovator Air Cleaner Kit.

• Features a high filtration element .

VT No.	Fits
34-1340	FLT 1999-2007
34-0062	FLT 1999-2007, Kit with cover



Important Note: Some items on this page may be emission-related parts subject to California or other emission control laws. Please see note on page 71 for important information regarding emission control regulatory compliance and warranty information.







## Replica Paper Air Filters

• Feature original shape and styling for exact fit. Washable construction.

VT No.	Fits
34-0933	1990-98 FLST, FLSTC, FLSTF, FLSTN, FLT/C/U, FLHT/C/P/U, FLHS
34-0962	1991-01 TC-88, carburetor, 2002-07 carburetor and electronic fuel injection
34-1208	2008-13 FLT, FLH
34-0063	2014-16 FLT



## Air Filters

• Available in 3 types, K&N paper, Unifilter foam and Accel 2-stage foam.  
• All have screen insert.

K&N	Accel	Uni-Foam	Fits
34-0736			2008-16 FLT, FLHR
34-0576			2002-07 FLT
34-0579			1999-2001 TC-88 FLT with electronic fuel injection
34-0917			1995-99 80" Evolution with electronic fuel injection
34-1047			1990-99 80" Evolution
	34-0973	34-0976	1990-92 80" Evolution
		34-0911	1986-89 80" Evolution

## Idle Adjustment Screws

• 35-0793 has flexible shaft, total length is 8". Kit includes flexible shaft, mounting bracket, and screw.



35-0793

VT No.	Type	Fits
35-0169	Rigid Polished Polished carburetor idle adjuster screw. FLT 1993-2006	
35-0793	Flexible Chrome Skull Knob This flexible shaft idler adjuster screw kit has a skull knob with a chrome finish. The total length is 8". Kit includes flexible shaft, mounting bracket, and screw. FLT 1993-2006	



39-0651  
Installed



39-0610



39-0610

## Electric Speedometer Assembly

• Features a digital odometer.

VT No.	Year	Model
39-0651	1995-03	FLHR
39-0610	As Above	Digital LED
39-0795	2004-07	FLHR
39-0597	2004-06	FLHR
39-0085	2004-13	FLHR with tach



## Speedometer Visor Ring

• Fits FLH style speedometer.  
VT No. 39-0224

## Chrome FL/FLH Speedometer/Visor

• Fits all FL/FLH with large type speedometers. Attaches with double sided tape. Used for seeing speedometer in bright sunlight.

VT No. 42-0136



## FLT Dash Console

• Includes tachometer and speedometer housing for 1981-84. KM/H.

VT No. 39-0398



Full Stainless Braid Covering with Clear Coat

## Braided Stainless Steel Clutch Cables

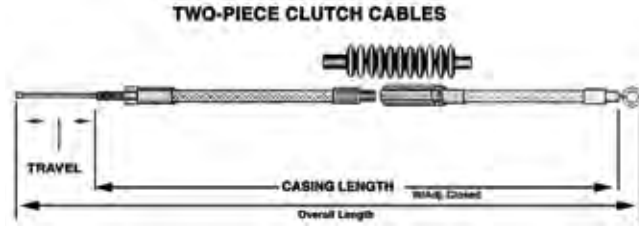

• Cables have braided stainless steel with clear outer coating.

## Braided Stainless Steel Throttle and Idle Cable Sets

• Braided stainless steel with clear outer coating

VT No.	Length	Fits
36-0826	40"	FLHRCI 2002-2007, FLHRI 2002-2007
36-0773	43"	FLHR 1994-1995, FLHT 1990-1995, FLHS 1990-1993
36-0825	46"	FLT 1998-2001, FLHTCUI 1996-2001, FLCUI 1996-1996
36-8046	49"	FLHR 1996-2001



Black



Stainless

## Front Wheel Drive Speedometer Cables.

Choose by application or by length and top nut size. Available in black vinyl, stainless or clear coated stainless.

Black Vinyl	Stainless	OEM	Length	Top Nut
<b>1987-95 FLST Models</b>				
36-2417	36-2428	67079-86A	34"	12mm
<b>1987-95 FLHT-FLHTC-FLHTC-U Models.</b>				
36-2418	—	67060-87A	39"	12mm
<b>1980-86 FLT</b>				
36-2412	—	67072-79A	40"	12mm
		67072-87B		
—	36-0127	Coated	40"	12mm



17-0595

## Electronic Speedometer Sensor Unit.

VT No.	Years	Model
17-0595	1995-up	FLT



**Vance and Hines Throttle Pak** designed for throttle by wire, the throttle pak improves the responsiveness of your engine by eliminating the factory programmed electronic lag. Fits FLT 2008-up. **VT No. 32-1035**



## Speedometer Drive Seal.

VT No.	OEM	Model
14-0966	67096-87	1987-95 FLT



**Speedometer Drive Spacer** replaces drive units.

VT No.	Year	Model
44-0370	1995-up	FLT

## Speedometer Drive Unit

• Fits front wheel only with .750 axle hole. Use for right and left side as noted.

VT No.	OEM	Side	Length	Length	Fits
36-0804	67073-81	Right	Flat	.532"	1984-86 FLT
36-2450	67073-87A	Left	.421"	1.245"	1987-95 FLT
36-2453	67101-96	Left	.442"	1.248"	1996-99 FLT



37-9537

From Wyatt Gatling

## Chrome Bolt Cap Kit

• Contain chrome bolt cap covers constructed of ABS plastic.

VT No.	Piece Qty.	Fits
37-9539	126	FLT 2009-2016
37-9537	105	FXCW, FXCW 2009-up
37-9540	148	FLT 1999-2008
37-9526	75	FLT 2007-2008



37-8103

From Gardner-Wescott

## Engine Chrome Dress up Screw Kits

VT No.	Fits
37-8103	FLT 1999-2006 TC-88
37-8088	FLT 1991-1998
37-9300	1987-90 Evolution Big Twin FLT



From Gardner-Wescott

## Chrome Allen Builders Fastener Sets

• The perfect combination of allen screws & acorn nuts.

VT No.	Fits
37-8098	FLT 1999-2006 TC-88
37-8095	FLT 1996-1998 Evolution
37-8090	FLT 1991-1995
37-0084	FLT 1984 Evolution 5-speed
37-0086	1987-90 Evolution FLT



7918-G

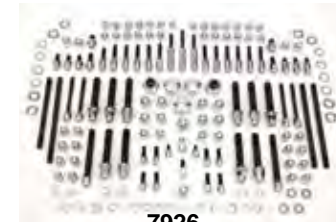

7926

## Engine Dress up Acorn Bolt Kit

• For motor and transmission area. \*All kits are chrome finished except 7918-G, which is gold finished.

VT No.	Fits
7926	FLT 1999-2006 TC-88
7918-G*	FLT 1985-1986 Evolution 5-Speed
7918	FLT 1985-1986 Evolution 5-Speed
7931	FLT 1996-1998
7930	FLT 1992-1995
7929	FLT 1987-1991

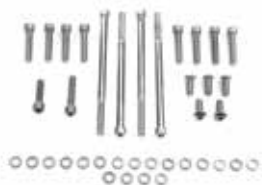

## Assorted Chrome Screw Kits.

For FLT 2007-up

VT No.	Head Style	Application
2400-12	Allen	Oil Pan Mount
2532-14	Acorn	Transmission Side Cover
2401-15	Allen	Transmission Side Cover
2534-19	Acorn	Primary Cover
2402-18	Knurled Allen	Primary Cover
2402-18T	Knurled Allen	Primary Cover
2403-22	Allen	Engine Mount
2533-6	Acorn	Transmission Shifter Cover

1009-P



## Chrome Polished Allen Head Show Bike Kits.

Model	VT No.	Year
FLT	1009-P	1979-84
FLT	1019-P	1987-91



## Cam & Primary Cover Chrome Screw Sets

• Include transmission, chain, clutch or derby provided where applicable. By Gardner-Wescott.

VT No.	Fits
37-8502	1987-06 FLT 5-Speed
37-8503	1985-86 FLT 5-Speed





## Chrome Velva Ride Engine Stabilizer

• Features a steel body with plunger and urethane dampener that creates a mini shock absorber.

VT No.	Fits
31-1983	FLT 1979-2008



## Chrome Front Engine Mount Assembly

• Includes bracket, link, and ISO mount with hardware.

VT No.	Fits
31-0625	FLT 1979-2007



## Urethane Engine Mount

• Replace stock on all Big Twins with rubber mounted engines. The formulated compounds enhance compression and rebound dampening properties for a 20% reduction in vibration.

• For FLT 1979-2008

VT No.	Brand	Finish
31-1975	V-Thunder	Black
31-0900	Sifton	Black
31-0682	Sifton	Chrome



Front Mount Brackets for 2008-up FLT.

VT No.	Finish
31-1277	Chrome
31-1278	Black



31-0905

## ISO Mount

• Replaces stock on all Big Twin rubber mounted engines. The mount plate is billet aluminum with a polyurethane bushing assembly.

VT No.	Year	Finish
31-0905	1979-2008	Chrome
31-0900	1979-2008	Black



31-0900



Front Engine Mount Set for 2009-16 FLT. Replaces 16207-09.

VT No.
31-0835



## FLT Stabilizer Bar Chrome

VT No.	Fits
31-0010	FLT 2009-up



## Chrome Front Engine Mount Stabilizer

VT No.	Fits
31-0286	FLT 1979-2008



## Front Engine Limiter Kit

• Dampens extreme movement on front motor mount cushion.

VT No.	Fits
31-1274	2009-up
31-1983	1970-08



31-1983



31-0256



31-0257

## Chrome Top Engine Mounts

• Feature two piece design, to be installed on rubber mounted engines in stock or custom solid mount frames.

VT No.	Fits
31-0256	1980-83 Shovelhead
31-0257	1984-98 Evolution

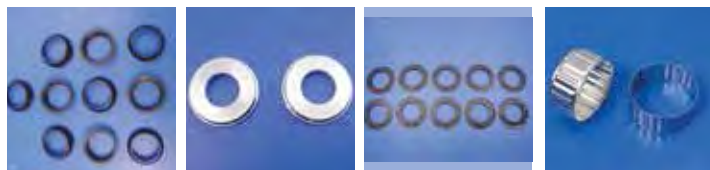

44-2039

44-2040

44-2041

31-0444



31-0452



44-0883



31-0442



31-0443



44-2061



31-3986



44-0887



44-2062



44-0882



44-2040



44-2054



44-1991



44-1984

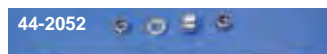

44-2052

## FLT Swingarm Rebuild Parts

VT No.	OEM	Year	Item
44-2039	47510-80	1980-01	Plastic Retaining Ring
44-2040	47511-80	1987-01	Spacer
44-2041	47513-80	1987-01	Nylon Washer
31-0444	47538-79	1979-01	Bushing Ring
31-0452	47556-81	1979-01	Bushing Assembly
31-3986	47553-79	1979-81	Mount Bushing, pair
31-0442	47564-82	1982-86	Mount Bushing, each
31-0443	47564-86A	1987-08	Mount Bushing, each
44-2061	47584-09	2009-up	Mount Bushing Set
44-2042	47491-89	1989-01	Cupwasher, 5 pack
44-0887	47606-02	2002-08	Nut Set
44-0883	9208	2002-up	Bearing Set
44-0882	47491-02	2002-10	Washing Set
44-2054	47505-02	2003-10	Shaft
44-1991	47492-89A	1989-01	Shaft
44-1984	47515-82A	1982-88	Shaft
44-2052	47515-80A	1980-81	Shaft
44-2062	47606-09	2010-up	Nut
37-0538	67865-89		Plug, Chrome



## Iso-Mount Swingarm Pin Kit

- Includes Iso sleeves, pin and side bushings for 1993-2010.

VT No.	Item
44-2063	Kit



44-2058

44-2044

44-2055

44-0982

## Swingarm Mounting Kit

- Includes two bushing assemblies, two spacers, two plastic retainer rings, two rubber isolators and pivot shaft with locknut and all parts required to mount transmission and swingarm to pivot block.
- Will work with stock or aftermarket rubber mount swingarm frames for FLT models.

VT No.	Year
44-2058	FLT 1980-81
44-2044	FLT 1982-01
44-2055	FLT 2002-08
44-2059	FLT 2009-10
44-0982	FLT 2011-up



44-0941

## 1982-02 FLT Kit

- All are pieces included for ease of installation.
- Updated Design
- Rubbers included
- Controls lateral and torsional movement at pivot point
- Close tolerance updated spherical bearings included.

VT No.	Item
44-0941	Kit
44-0960	Spacer Set



42-0030

### Chrome Swingarm Mount Kit

- Includes right and left chrome pivot caps, chrome passenger footboards mounts and chrome passenger footboards with rubber pads for Touring.

VT No.	OEM	Fits
42-0030	47850-88T	1982-89



44-2060

### Swingarm Kit

- Includes 2 offset steel bushings and 2 alloy washers.

VT No.	Fits
44-2060	FLT 1980-2008, FL 1980-2008, FLHTC 1980-2008



### Nylatron Swingarm Bushing Kit

- Four piece bushing set replaces swingarm bearings and stabilizes swingarm rubber mounts.
- Order pin separately. Order (31-3986 or 31-0443) frame mount bushings separately.

VT No.	Fits
44-0671	FLT 1982-2002, FLHT 1982-2002, FLHR 1995-2002



51-0992

51-0994



Key Tab Detail



51-0992 will retro fit 1982-02 to accept foot pegs and foot board mounts on the right and left side.

\*Note: Key tabs to secure rubber bushings.

### Chrome Pivot Mount End Caps

- Fit years as noted.

VT No.	Year
51-0992	1982-06
51-0994	2007-08



### Swingarm Iso Mount Pin Kit

- Includes pin and outer support bushings with steel side plates for upgrades.

VT No.	Fits
44-2064	1993-02 Touring

## Tool Kits



16-0011

### DIY Touring Tool Kit

- For 1999-2013 models will fit in a kidney shaped tool box. Includes rider tools and service tools for the rider-mechanic.

VT No.	Fits
16-0011	1999-13
16-0098	2014-up



16-0098





## Chrome Dash Cover and Extension.

• For use with shorter seats.

VT No.	Item	Fits
39-0571	Dash Cover	FLT 2003-2007
39-0606	Billet Dash Cover	FLHR 1994-2000
39-0221	Extension	FLT 1996-up models with a shorter seat



## Dash Stash Box

• Fits 1997-2007 FLHT with a short nose seat.

VT No.	Finish
39-0461	Raw
39-0460	Chrome



## Tank Petcock Valve

VT No.	Fits
35-1459	FLT 2002-2006
35-0222	FLT 1995-2001, OEM # 61338-94D



**Magneti Marelli Fuel Injection to Carburetor Petcock Conversion Fitting Set.** Converts all 1995-01 Big Twins equipped with Magneti Marelli Fuel Injection System to carburetor system. Can be used with any 22mm petcock. Fits 1995-01 FLT models.

**VT No. 35-0751**



**Delphi Fuel Injection to Carburetor Conversion Fitting Set** includes gas tank fitting to eliminate Delphi fuel injection and use a carburetor and late style petcock. Fits 2002-up.

**VT No. 35-9353**



35-0748

**Adapter Bushing** allows use of carb type petcock on electronic fuel injection FL models.

**VT No. 35-0748**



## Fuel Console Door.

**Fits 1992-07**

39-0654 Chrome

**Fits 2008-up**

38-0441 Chrome

38-0442 Black

38-0430 Black skull

38-0600 Black with chrome skull

38-0601 Chrome with black skull

38-0602 Black with chrome flame skull

38-0603 Chrome with black flame skull

38-0604 Black with chrome flames

38-0605 Chrome with chrome flames

38-0606 Chrome with Live to Ride

38-0495 Black Eagle Spirit



## Chrome Billet Fork Lock Cover

• Raised black skull design.

• Fits 1994-up FLHR.

**VT No. 42-0135**



## Console Fuel Door Push Button

• Fits 1992-up FLT

VT No.	Finish
38-0432	Chrome
38-1284	Black
38-0434	Chrome, Key Operated



38-0255



38-0925



38-0475



38-0571



38-0473



38-0474



38-0186



37-9329

### Custom Tank Mount Bolt Sets.

37-9329 1998-up FLT

### 5 Gallon Stretch Gas Tank

For FLT models including FLHT, FLHR and FLTR models without fuel injection.

- Tanks include custom console to cover OEM gauge sending unit.
- Use standard bung right and left caps and petcock.
- Shorter seat may be required.

VT No.	Year	Type	Gallon
38-0255	1997-03	Carburetor	5
38-0475	1996-06	Carburetor	7
38-0473	2003-07	EFI	7
38-0474	2008-up	EFI	7
38-0925	2008-14	EFI	6.6
39-0571	2003-07	Dash Panel	

### Bobbed Tank Kit

• For FLT models features a one piece 4 gallon design tank which includes chrome bung style caps and hardware for installation.

• Kits for 1980-99 include a chrome cast dash, 5 lamp dash base and a 6 post bobbed type key switch with a 2240:1 ratio speedometer and front wheel drive cable. Requires the use of solo seat or FXR style seat for installation. Models for 1980-85 require drilling for rear mount.

VT No.	Item
38-0186	Kit
38-0298	Tank Only
2530-6	Mount Bolts



**Power Commander V Fuel and Ignition Timing Control** for each cylinder in a new smaller enclosure. Rev Xtend feature increases stock rev limiter. Switch between two maps “sent on the fly” can be adjusted on a “per gear” basis and allows for one map per cylinder per gear if required. Adjustment of fuel and timing is based on engine temperature provided by the cold start feature. Will power up with USB cable only for programming. **Note:** Not legal for use on pollution controlled vehicles.

VT No.	Fits
32-1960	2009 FLT
32-1962	2010-13 FLT

**32-1965**



**Automatic Tune Kit** for all HD PC-V Power Commanders plugs directly into the PC-V with a single cable. It includes power connector that plugs into a bike’s harness. Rider can specify what air/fuel ratio to make each RPM and throttle position combination. Base settings are included and fully adjustable. Fits 1996-99 FLT.

VT No.	Fits
32-1965	



**EFI POWER COMMANDER V** features 2 position map switching function, gear and analog input. Power Commander V also allows each cylinder to be mapped individually and for each gear. This has 10 throttle position columns, and enhanced accel pump utility. Unit has a -100/+250 percent fuel change range and is compatible with 2009 and newer models. Fits 2014-16

VT No.	Fits
32-1089	



**DynoJet Power Vision Flash Tuner** offers the latest flash tuning technology and data logging. Includes a full color touch screen flash device, vehicle interface cable, and winPV. Types of tunes that are deliverable to your bike are pre-configured, which are loaded on th device from DynoJet. When using the pre-configured tunes, this device will identify the ECM strategy, stock calibration, and sort the tune files. Custom tunes option can be loaded or emailed to you by a custom tuner, or a copy of your stock tune can be used. The tuner holds any combination of the three types, but up to six tunes. Fits 2002-13 FLT.

VT No.	Fits
32-1056	



**Vance & Hines Fuel Pak** is a throttle position sensor based system that simplifies the process of fuel injection tuning. It enables you to fine tune the fuel mixture throughout the entire RPM range. No computer or software is required. Simply punch in the values supplied with the fuel pak. Requires use of high performance air cleaner. Order parts for Softail.

VT No.	Fits
32-0292	2002-07 FLT, FLHT, FLHR
32-0294	2008-up FLT, FLHT, FLHR
32-0295	2011-2016 FLT, FLHT, FLHR



**Power Commander III USB Engine Management Systems** are for fuel injected models and allow for both fuel and ignition adjustments. Each unit includes a specific map, designed to improve performance over stock. The Power Commander includes IBM compatible link cable and software package which allows you to fully map the fuel ignition curves on IBM compatible computers. If a computer is not available, the fuel curves can be adjusted by using three touch buttons on the face plate.

VT No.	Year	Model
32-3012*	2007	FLT
32-3037	2008	FLT

**\*Note:** Includes O<sub>2</sub> eliminators.



**Caution:** These products are not legal for sale or use in California on pollution controlled vehicles. These products are intended for non-highway only.







# Headlamp Cowl for FLT



24-0228



24-0229

## Chrome Upper Fork Covers

- Unique 2 piece design which allows easy installation over stock covers without fork disassembly or removal.
- All components are chrome plated steel.

VT No.	OEM	Fits
24-0228	68064-94	1980-95 FLT, 1987-93 FLHS
24-0229	68063-94	1986-95 FLHTC, FLHTCU



33-0080  
Installed



33-2134  
Installed



33-0547  
Installed



33-2004

24-0227

31-0499

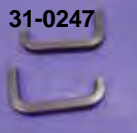

37-0997

31-0247

31-0246

### Parts Available Separately

33-2004	Headlamp Assembly
24-0227	Upper Chrome Fork Cover Set
31-0499	Spot Lamp Bracket
31-0246	Top Trim Strip
31-0247	Rear Trim Strip
37-0997	Speed Nut



### Chrome Front Fork Air Baffle

- Fits 1980-up FLT/FLHT models, does not fit 1998-up FLTR. Replaces 58520-79TC.

VT No. 24-0272



### Handlebar Cover

- Allows use of 1 1/4" bars with built in risers to fit Road King models with cowl assembly. 2003-13.

VT No. 24-1063

33-1198



33-0547  
Installed



Frenched Headlamp Ring fits 83-up models VT No. 33-0547

13-0983



33-1174  
Installed



33-1174



33-0808



33-1199

## Contoured Headlamp Mount Rim

1983-2013	2013-1983	2014-up	Type
33-0080			Contour, chrome
33-2134			Stock, chrome
33-0547			Frenched, chrome
13-0983			Clip
33-1174			Billet, chrome
		33-0808	Chrome
33-0812			Frenched, chrome
33-0813			Frenched,chrome
33-1199	33-1198		Burst, black



24-0286

24-0247



24-0287



24-0260

### Chrome Headlamp Housing Kit

• Fits 1980-86 FLT, 1983-85 FLHT-FLHTC and 1987-92 FLHS includes chrome ABS headlight housing, 7" H-4 lamp assembly with rim, upper fork covers (which can be installed without disassembly of fork) and chrome fork air baffle.

VT No.	Model
24-0286	1980-86 FLT, 1983-85 FLHT
24-0287	1987-92 FLHS

### Chrome ABS Headlamp Housing Only.

• For conversion order internal kit 33-2070 separately. Use on all 1980-92 FLT, 1983-85 FLHT, FLHTC, 1987-92 FLHS. Available with or without throttle cable hole. VT No. 24-0247 has hole for cable.

VT No.	OEM	Type
24-0247	67704-83	With throttle cable hole
24-0260	67680-91	Without throttle cable hole



24-0355



24-0267

24-0355



24-0318



### Chrome Headlamp Cowl Kit

• Includes right and left sides.  
 • Fits 1986-13 FLT models to update to Road King style.  
 • Includes housing assembly, handlebar top cover, headlamp assembly, top and rear trim strip and mounting hardware.

VT No.	Item
24-0355	Complete Housing Assembly Kit, 1986-13 FLT
24-0318	Complete Assembly with lamp, chrome upper fork leg covers and chrome fork air baffle
24-0267	Housing Set Only for stock FLHR





33-1008



### Wyatt Gatling 7" LED Headlamp Assembly

• Features six LED's on both sides of the bulb. Bulb features a parabolic lens design and the LED's acts as running lights or turn signals.

VT No. 33-1008



33-1044

### 7" LED Headlamp Unit.

• Features black shaded reflector. \*Note: LED lamp unit includes built in DRL (Day Running Light). Order adapter ring 31-0080 separately for FLH applications.

VT No. 33-1044



### Headlamp for FLT

Chrome	Black	Fits
33-1104	33-1105	1994-13 FLT
33-1106	33-1107	2014-up FLT



33-1100



33-1101

### Dual LED Headlamp Unit

• Includes two LED daylight headlamps mounted onto a backing plate for easy installation, features a housing with reflector

VT No. Finish

33-1100 Chrome

33-1101 Black

33-1447



### H9 High Beam Headlamp Replacement Bulb.

• Fits FLHX, FLHXS, FLHR 2014-up. OEM # 67717-01.

VT No. 33-1447



33-1737



33-1738

### LED H4 Bulbs.

VT No.	Color
33-1736	White
33-1737	White
33-1738	Yellow
33-1739	Yellow
33-1782	White

Caution: Do not touch any Halogen bulb glass with bare hands during installation or replacement. The manufacturer advises that the light unit is not washed with a water hose as the unit is not a sealed beam unit.

Lamps listed are for show or decorative use only, and not D.O.T. approved.





### Diamond Cut Lamp Unit

• Feature H-4 bulb and white LED ring.  
VT No. 33-0948



### 7" Faceted H-4 Lamp Unit

• Features 60/55 bulb with parking lamp.  
VT No. 33-0206

33-3072

12 V

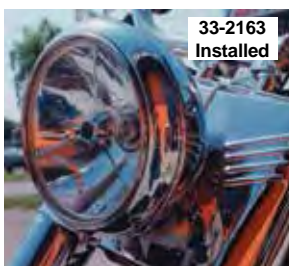

33-2163  
Installed



33-2163



33-0850

33-1557



33-0201



Round Sealed Beams are replacement type.

VT No.	10 Pack	Volt	Watt	Brand
33-2009*	—	12 Volt	60/55	Wagner
33-3072	33-1426	12 Volt		Beck
33-1032	—	12 Volt		Cycle Beam

\*Note: Halogen Type Sealed Beam



33-4080



### 7" H-4 Headlamp Assembly

• Without chrome outer rim. Headlamp is attached to a black housing.  
VT No. 33-3041



33-4081



### 7" Glide Chrome Deco Headlamp Visor

• Fits lamps in chrome shells or in cowls.  
VT No. 42-0209



33-0110



Visors 42-0200 and 42-0202 installed



42-9925 Signal Lamp

### Chrome Lamp Visors

• Easy-to-install.

VT No.	Type
42-0200	7" FLH Headlamp
42-9925	1963-85 FL Signal
42-9942	Signal 1986-up FL

### 7" Halogen Lamp Units

• feature early styling and H-4, 55-60 watt replaceable bulb included. Both fit stock or custom headlamp shells. Shell is not included.

VT No.	Type	Bulb
33-2163	Tri-Bar	33-2168
33-0850	Blue Dot	33-2170
33-0201	Flat	33-2170
33-0888	Center Cup	33-2170
33-1557	Flat	33-2170
33-3041	Flat	33-2170
33-4080	Amber	
33-4081	Black	
33-0110	Flat	



# LED Units

TOURING



33-1416



33-1008



33-1044



33-1008



33-1783



31-0080

### LED Units

33-1008	White
33-1019	Black
33-1415	Black
33-1416	Black with signal
33-1044	Clear
31-0080	Bracket
33-1783	White

### Touring

33-1104	1994-13
33-1106	2014-up



33-1415



- Snap On
- Tight Fit
- Easy Installation



37-1505



### 300 Pc Assortment (37-1505)!



**Snap Caps™** snap on knurled allen screws for ease of installation. Packs of 25 or 100.

100 pack	25 pack	Fits
37-1502	37-1526	1/4"
37-1503	37-1527	5/16"
37-1504	37-1528	3/8"
<b>300 Pieces</b>		
37-1505	—	Assortment



37-9537

From Wyatt Gatling

### Chrome Bolt Cap Kit

- Contain chrome bolt cap covers constructed of ABS plastic.

VT No.	Piece Qty.	Fits
37-9539	126	FLT 2009-2016
37-9540	148	FLT 1999-2008
37-9526	75	FLT 2007-2008



32-0564



32-0581

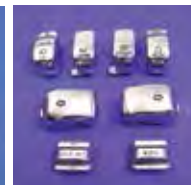

32-0563



32-0562



32-0565

### Chrome Switch Cover Set.

Snap on covers replace existing black switch covers.

VT. No.	Fits
32-0564	1996-up FLHTCU (Ultra Classic Electra Glide) 1996-up FLTR (Road Glide)
32-0563	1996-up FLHT (Electra Glide Standard); 1996-up FLHTC (Electra Glide Classic) without cruise control
32-0562	1996-up FLHR (Road King), 1998-01 FLHRCI (Road King Classic)
32-0565	2002-up FLHRCI (Road King Classic) with cruise control
32-0581	1996-up FLHT with cruise control, FLHTC, 2006-up FLHX without cruise control



32-1091 32-1092 32-1093 32-1094 32-1095

### Gold Switch Cover Kits.

VT No.	Fits
32-1091	FXD, FXST, FLHR 1996-up, VRSC 2002-2002, FLHRCI 1998-2001
32-1092	FLHT 1996-up without cruise control
32-1093	FLHTCUI, FLTR 1996-up
32-1094	FLHRCI 2002-up without cruise control
32-1095	FLHT, FLHTC 1996-up, FLHX 2006-up use on cruise control models



### Switch Cover Set

- Features a chrome finish and includes 12 pieces.
- Set is used to replace the stock black caps.
- Fits 2016-up FLHTCU, FLHTCUL, FLHTCUTG, FLHX, FLHXS, FLTRU, FLTRX and FLTRXS. OEM No# 71500187

VT No. 26-0846





33-0066



33-0073



33-1016



33-0903



33-0903 Installed

## 12 Volt Spotlamp Assembly

With mount spacer and clear bulb. Sold as pair.

VT No.	Type/Year
33-0066	1979-up FLT, Chrome
33-3051	1979-up FLT, Black
33-0073	Chrome, blue, 1979-up
33-1016	LED/1968-up
33-0903	2006-up Touring
33-0634	69227-04A, 1996-up

33-1282



33-1735



## Chrome 12 Volt Spotlamp

- Includes with mount spacer and amber running lamp.
- Fits 1979-up FLT.

VT No.	U/M
33-1282	Each
33-1735	Pair



33-0152



33-1304



33-1190



33-0098

## Spotlamp Bulb Kit

- Fits 1996-up FLT-FLHT models

VT No.	Item
33-0152	Bulb Set H-3
33-1304	881 12 Volt
33-1190*	881 12 Volt LED
33-0098**	Bulb Set with harness
*Note: LED type bulb set bright white beam 6000k.	
**Note: Includes harness that allows spotlamps to remain on when high is used.	
33-0973	4½" Halogen Beam Bulb, 2006-up
33-1042	Inner Mount Ring Set
33-1110	Chrome Shell and Wire Kit
33-1320	Screw and Nut Set



33-1184

**4.5" LED Spotlamp Assembly** is 12 volt, 55/60W, and features a H4 bulb. Fits 1960-up FL.

VT No.	U/M
33-1184	Each
33-1545	Set



33-1016

**12 Volt Spotlamp Assembly** with mount spacer and clear bulb. Sold as pair unless noted.

VT No.	Type
33-1016	4.5" LED, 1979-up FL, each
33-1732	4.5" LED, 1979-up FL, set



33-0354

## Front Turn Signal Relocation Kits

- Fit 1996-up FLT.

VT No.	Fits
31-0353	with Spot Lamp Bar
31-0354	without Spot Lamp Bar



33-0172

### 4 1/2" Chrome Bullet Style Spotlamp Trim

- Held in place by existing headlamp bulb and rim.

VT No. 33-0172



33-0551



33-1198



33-1198  
Installed

### Spotlamp Trim Ring Set

- Allow installation of visors on 1987-up models, sold as pair.

VT No.	Item
33-0551	Ring Set
33-1198	Billet Trim Ring Set
42-0202	Visors, pair



33-0546 Installed



33-0811  
Installed



33-0811

### Spotlamp Dress Ring

- Features a recessed "frenched" deep design. Also available with built in visor.

VT No.	Type
33-0546	Frenched
33-0811	Frenched with visor







33-1440



33-1444



33-1441



33-1445



33-1443



33-1446



31-0964



31-0964 Installed



## LED Turn Signal Sets.

Chrome	Black	Item
33-1440	33-1444	Combo Tail/Turn Signal Lamp 1989-up FLT
33-1441	33-1445	Front Turn Signal, Dual Function 1996-up FL, Smoke Lens
33-1443	33-1446	Rear Turn Signal, Signal Function 1996-up FL, Smoke Lens

## Chrome Turn Signal Bracket Set

- Mounts as stock. Mount holes are 6 $\frac{3}{4}$ " center to center.

VT No.	Fits
31-0964	FLHR 1997-up Road King Headlamp Nacelle, FLT 1997-13



## Chrome Turn Signal Block Off Bevel Style Plates

- For use when front fairing mounted on the turn signals are removed or relocated.

VT No.	Fits
31-0075	FLTR 1998-up



## Chrome Turn Signal Bracket Short

31-0216 Signal Bracket

VT No.	Fits
31-0216	FLT 1986-up



## Turn Signal Mount Kit.

VT No. 31-0093





31-0927



31-1343



31-1347



31-1349



31-1027



31-1344

**Spotlamp Brackets.** Clamp on style for engine guards, pair.

VT No.	Type
31-1347	Chrome, Fog Lamp Clamp 68000170
31-1348	Black Fog Lamp Clamp 68000142
31-1349	Chrome Fog Lamp Clamp 6800017
31-1350	Black, Fog Lamp 68000141

## Spotlamp Kit

• Fits 1996-up FLT-FLHT models.

Chrome	Black	Item
31-0927	31-1343	Bracket Set 2014-up
31-1027	31-1344	Bracket Set 1996-13

31-0482



31-0499



**Chrome Spotlamp Mount Bracket** is one piece type. Use VT No. 33-0010 Spotlamp.

VT No.	Fits
31-0482	1986-up FLHS
37-0552	Spacer for Above
31-0499	1994-01 FLHR, 1997-up FLHT

**\*Note:** Includes brackets which mount to lower pinch bolts.

31-0311



## Chrome V-Style Spotlamp Bracket

• Replace stock bracket.

VT No.	Year	Model
31-0311	1986-2001	FLST-FLSTF



31-0830



31-0828



31-0829



31-0831



31-0833

## Spotlamp Eliminator Bracket Set.

Chrome	Black	Type
31-0830	31-0828	Ball Milled
31-0831	31-0829	Drilled
Carbon Fiber		
31-0833		Ball Milled



**Spotlamp Bracket Covers** feature textured surface and stepped design. Fits all 1996-13 FLT models. Replaces 68613-01.  
**VT No. 42-0606**



# Rear Signal Mount



## V-Shape Rear Turn Signal Kit

• Fits FLT. Includes red/amber LED bulb lamps.

VT No.	Item
33-3040	Kit
33-0762	LED Lamp Set



## Chrome Round Turn Signal Bar

• Include hollow bolts to mount custom turn signals. Fits 1991-04 FLT.  
VT No. 31-0329



## Chrome Low Boyz Turn Signal Bar

• Replaces 68430-89 and is threaded to accept stock turn signals and mounts to license plate bracket holes.

VT No.	Item	Length
31-0206	Bar	12"
31-0776	Bar Kit	7"
37-0561	End Nuts	
31-1289	Bar Kit	9.72"

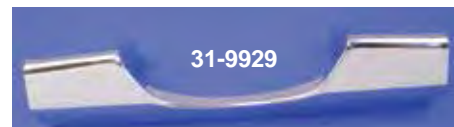
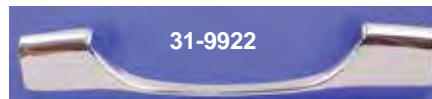
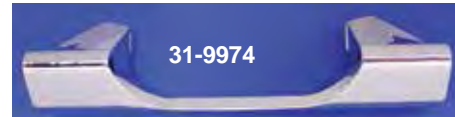

VT No. 31-9922 Installed

## Chrome Rear Turn Signal Mounts.

\*Note: Polish.

VT No.	Length	Model
31-3987	13"	1985-90 FLHS-FLT
31-3935	9"	As Above
31-0441	8¼"	1985-90 FLHS-FLT
31-4006*	12⅞"	1974-84 FLH, 1991-up FLT-FLHS-FLHR
31-2098	12⅞"	As above
31-9974	9"	As above
31-9922	8¼"	As above
31-9929	10"	As above



## Chrome Rear Directional Signal Bar

• Constructed of formed and welded steel which offers the greatest strength against vibration.

VT No.	Fits	Length
31-0494	1974-84 FLH 1991-up Road King	13"
31-0517	1985-90 FLT-FLHT	8¾"
31-0495	1974-84 FL	13"



33-3035



31-1235

### Chrome Rear Turn Signal Bar

1999-up FLT	
33-1288	LED
33-3035	Bulb
31-0865	Bracket Only
31-1235	Bracket
33-1480	Chrome LED
33-1481	Black LED
2011-up Street Glide	
33-1049	LED
33-1000	LED Black



33-1175



33-1177



33-1178

### Revox Turn Signal Bar

• Fits 1986-up FLST, 1991-08 FLT

Chrome	Black	Lens Color
33-1175	33-1176	Amber
33-1177	33-1178	Smoke





All Frames fit standard 4" x 7" size unless noted.

TOURING



33-0392



42-0987

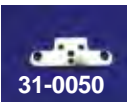

31-0050



31-0050 Installed

## Billet Chrome Tail Lamp & Plate Holder

• Include mounting bracket feature LED. Rail mount for 1997-up FLT models. **Note:** 42-0987 does not have a lamp.

VT No .	Style	Item
33-0388	Plain	LED
33-0387	Skull	LED
33-0389	Diamond	LED
33-0392	Slice	LED
42-0987	Spade	None
31-0050	Replacement Mounting Bracket for Above	



## License Plate Bar Eliminator Bracket Set

• Allows the license plate support tube to be removed and will still allow the stock saddlebags support brackets to be used. Sold in pairs.

VT No. 31-1268



## Chrome License Plate Frame Kit

• Fits 7 1/4" x 4" standard plates.

VT No. 42-0066



42-9985



## Marker Lamp Light Bar Set

- Includes four bullet lamps to fit 1997-08 Touring with stock rear fender rail and license plate mount.
- Fits 7 1/4" x 4" standard plates.

VT No	Item
42-9985	Marker Lamp Light Bar Set
31-1756	Bracket



31-0780 Installed



## Lay Down License Plate Bracket

- Fits 1997-up Road King models.

VT No	Item
31-0780	Plate and Bracket
42-1069	Plate Only



31-1006 Installed

## Billet License Plate Bracket

- Mounts below tail lamp in existing holes, by removing the stock turn signal bracket on 1991-08 FLT, 1978-84 FLH.

VT No.	Item
31-1006	Plate Holder
31-1268	Bracket Set



27-0500



27-0693 Installed

27-0815



27-0803



## Chrome Replica Passenger Footboard Set

• Fit all OE style brackets and will accept rubber pads from 1986-up.

VT No.	Item
27-0969	Board Set Only
27-0500	Board Set Only
27-0693	Flame
27-0815	Board/Rubber
27-0803	Pin Set, Fits OE
27-0864	Pin Set for 27-0500

27-0022



## Slasher Style Chrome Billet Passenger Footboard Set

• Features CNC machining, removable anti-vibration dampers and a unique shape. Fit 1984-up FL.

VT No. 27-0022



27-1523  
Installed



27-1523

## Passenger Peg Mount Kit

• Mounts to rear existing mount to accept a male peg set. Kit allows 360° rotation to raise or lower peg height. Fits 1993-up FLT models.

VT No. 27-1523

27-0834



## Billet Rear Passenger Footboard Set.

• Fit 1986-up FLT models. Chrome insert features inlay rubber pad.

VT No.	Type
27-0834	Rail

27-1549



27-1458



27-1456



27-0990



27-0991



27-1984



## Streamline Passenger Footboard Set.

VT No.	Item
27-1549	Board Set, Chrome
27-1458	Board Set, Black
27-1456	Board Set; order pins separately
28-0990	Right Rubber
28-0991	Left Rubber
27-1984	Chrome Set without rubber
27-1135	Rubber Inserts
27-0750	Board Set, Chrome



27-0561 Installed



27-0561



27-1522 Adjustable



27-1522



27-0616



27-1523

### Rear Passenger Footboard Mount

• For 1993-up models FLT, FLHT and FLHS. **Note:** Order footboards and mats separately.

Chrome	Black	Year	Note
27-0561	27-0832	1993-2009	Non-Adjustable
27-1522	27-0831	1993-2009	Adjustable
	27-0616	1993-2009	Non-Adjustable
27-1523		1993-up	Passenger Footpeg Mt Kit
27-0964	27-0977		Streamline Board Only



27-0854



27-1739

### FLT Chrome Passenger Footboard Kit.

Footboards fold up when not in use. Kit includes footboards and mounting hardware. Fits all 1993-up FLT models.

VT No.	Footboards
27-0854	Stock
27-1739	Streamline



### 1993-up FLT Rear Footpeg Kit

• Includes chrome brackets and large soft peg set. Replaces rear passenger floor guards.

VT No. 27-0578



### Male End Mount Adjustable Footpeg Kit.

• Chrome with rubber rails and include an adjustable mount bracket.

• Fits 1993-up FLT.

VT No. 27-0564



27-0517 Installed with 27-1586



27-1796

27-0441

### Passenger Footpeg Mount Bracket Set.

- Fits FLT 1993-up
- Adjusts to 3 height positions.
- Replaces stock rear footboards.
- Order male pegs separately.

Chrome	Black	Item
27-0517	27-1796	Peg Mount
27-0440	27-0441	Mini Board
27-0831		Footboard Mount Kit

27-1599



### Chrome Passenger Footboard Covers

• Fit fold up type factory cast boards. Includes 2 covers with 4 self tapping screws.

VT No.	Item
27-1599	Cover Set, 1986-up





27-0964



27-0977

### Streamliner Passenger Footboard Kit.

• Includes footboards, rubber pads, mounting hardware. Pads feature three chrome ribs. Set has bolt on installation. Replaces 50378-07B.

Chrome	Black	Item
27-0964	27-0977	Kit



### Black Rear Passenger Footboard Set

• Without rubber inserts.

Fits 1993-up FLT.

VT No. 27-1761



27-1125



27-1126



27-1123



27-1124

### Footboard Set

Chrome	Black	Item
27-1125	27-1126	Block Passenger Rear Footboard Kit
27-1123	27-1124	Ribbed Rear Passenger Kit
27-1549	27-1458	Streamline, FLT 1993-up
27-1456		Streamline, FLT 1993-up



27-1127



27-1128



27-1129



27-1130

### Mount Kit

Chrome	Black	Item
27-1127	27-1128	Reduced Reach Passenger Mount Kit
27-1129	27-1130	Adjustable Passenger Mount Kit



51-0998



51-0853

### Passenger Footboard Sets with Swingarm Mount Kit

• Includes right & left side chrome pivot caps, passenger footboard mounts and passenger footboard with rubber pads.

VT No.	Footboard Style	Fits
51-0998	D-Shaped	FLT 2007-2008
51-0853	D-Shaped	FLT 1982-2006
51-0867	Mini	FLT 1982-2006



### Passenger Streamliner Style Footboard Set

• Includes rubber inserts. Order pins separately. Black finish. Fits 1993-up FLT.

VT No. 27-1762



### Chrome Passenger Footboard Set

• Without rubber inserts. Accepts black passenger footboard mat black, OEM #50606-86A, and passenger footboard pin kit, OEM #50933-86.

VT No. 27-0016



28-2120



28-2148

### Stock Black Rubber Passenger Footboard

• Fits factory passenger floor boards.  
• 1987-up FLT.

VT No.	Style
28-2120	Block, pair
28-2148	Ribbed, each



27-0164



27-0229



27-0165



27-0703



27-0495



27-1550

**Passenger Footboard • Fits 1993-up FLT**

VT No.	Item
27-0164	Digi Cut, Chrome
27-0165	Digi Cut, Black
27-0495	Black Edge

**Passenger Footboard Set.**

• Fit 1993-up FLT.

VT No.	Style
27-0229	Rubber Pad
27-0703	Diamond
27-1550	Stock





27-0837

27-0837 Installed



27-0148

27-0149

## Left Side Footboard Heel Guards

• Fit 1986-up FL style boards.

VT No.	Finish
27-0148	Chrome
27-0149	Black
27-0837	Chrome



27-1527



27-1526

## Footboard Extender Kit

• Fits Touring. This kit is finished in black to extend footboards outward by 1¼" inches.

VT No.	Year
27-1527	1980-08
27-1526	2009-up



## 1" Footboard Extender

• Fits 1993-up FLT.

VT No. 27-1235



51-1601 Installed shown with 27-1235



27-0812



27-0811



27-1726



27-0811

## Chrome Footboard Mount Set

• For FLT is a 4 piece set. Available in stock or +2" forward.

VT No.	Type	Finish	Year
27-1726	Stock	Chrome	1983-08
27-0811	+2"	Chrome	1983-08
27-0812	+2"	Black	1983-08
27-0827		Black	2009-up
27-1793	Stock	Chrome	2009-up



27-0162



27-0163



27-0863

## Half Moon Footboard Set

• Features OE style pads and Iso mounted pads.

VT No.	Finish
27-0162	Black
27-0163	Chrome
27-0863	Trim



## Footboard Forward Relocation Kit

• Re-mount footboards 1" forward on 1997 and later Touring models.

VT No. 27-1539

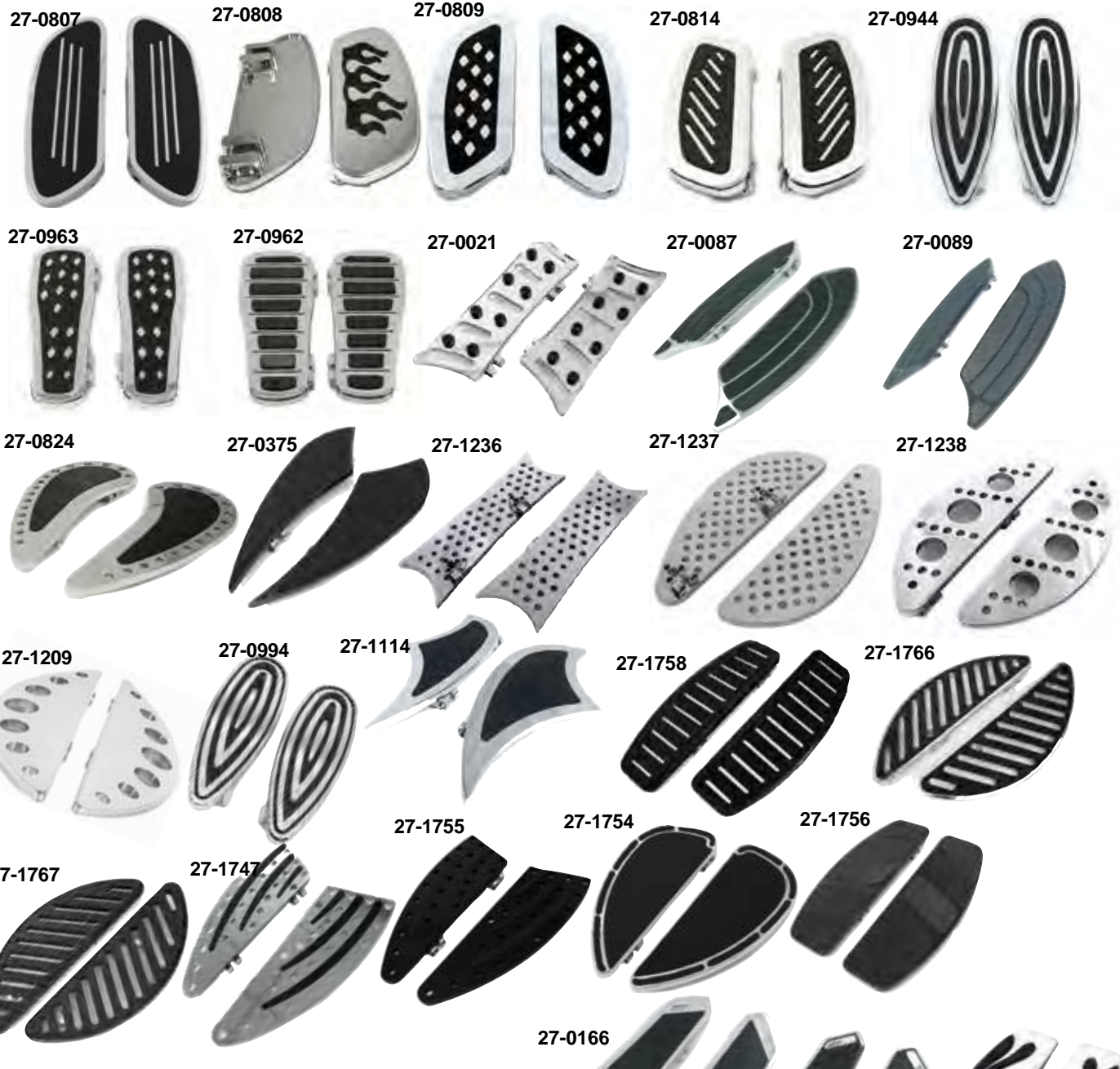

## Driver Footboard Set

• Fits 1980-up FLT and 1986-up FLST.

Chrome	Black	Style
27-0807	—	Rail
27-0808	—	Flame
27-0809	—	Diamond
27-0814	—	Shark Fin
27-0944	—	Teardrop
27-0963	—	Diamond Big Foot
27-0962	—	Big Foot
27-0021	—	Slasher
27-0087	27-0089	Rocket
27-0824	—	Half Moon with rubber
—	27-0375	Shark Fin
27-1236	—	Swiss Cheese, Rectangular
27-1237	—	Swiss Cheese, Half Moon
27-1238	—	Drilled Half Moon
27-1209	—	Half Moon Holes



27-0994	—	Oval Design
27-1114	—	Shark Fin with rubber
—	27-1758	Slotted Ball Milled
27-1766	27-1767	Half Moon Slotted
27-1747	27-1755	Slanted Shark Fin
—	27-1754	Oblong Teardrop
—	27-1756	Rectangular with raised rubber areas
27-0166	27-0167	Digi
27-1798	—	Flame
27-0452	—	Bolt Set (Zinc)





# Driver Footboard



27-1251



27-1251 Installed



27-1250



27-1250 Installed



27-0898



27-0898 Installed



27-0822



27-1200



27-1201



27-1202



27-1202 Installed



27-1752



27-1752 Installed

## “D” Billet Footboard Set.

• Note: Fit 1980-up FLT and 1986-up FLST

VT No.	Shape
27-1251	Diamond
27-1250	Rail
27-0898	Flame
27-0822	Wave

## Billet Footboard Set.

• Note: Fits 1980-up FLT and 1986-up FLST

VT No.	Shape
27-1200	Diamond
27-1201	Rail
27-1202	Flame
27-1752	Oval



27-0914



27-0863

## Vintage Footboard Sets

• Feature classic half moon design with “shaker” Iso-mount cushion area. Black pads included.

VT No.	Fits
27-0914	1980-up FLT
27-0863	Rail Trim



27-0855



27-0748

Chrome	Black	Item
27-0855	27-0748	Driver Set with Streamliner Design

27-0188



## Wyatts Driver Extended Reach Rider Footboard.

• Features Streamline design. Moves floorboard 1" forward.

VT No.	Finish/Fits
27-0188	Black, 2002-up FLT
27-0187	Chrome, 2002-up FLT



## Chrome Driver Footboard Set

• Features ISO mounted rubber pads. Fits 1986-up FLT.

VT No.	27-1784
--------	---------





27-1788



27-0698



27-0032



27-0033



27-0660  
Installed

27-0660



27-0034

## Chrome Extended Footpeg Mount Kit

For custom application

VT No.	Mount Diameter
27-0032	1"
27-0033	1 1/8"
27-0034	1 1/4"



27-0654

27-0587



27-0892 Installed



27-0892



27-0651



27-1452

27-1453



27-0753

## Footpeg Mounts

- For 1 1/4" front engine bars.
- Order pegs separately.

VT No.	Type
27-1452	Long
27-1453	Short
27-0753	Adjustable Kit

## Chrome Engine Bar Footpeg Mount Kits

- For the mounting of male footpeg sets to 1 1/4" engine bars.
- Hardware included.
- \*Includes footpegs. All other items purchase footpegs separately.

For custom application	
VT No.	Item
27-1788	Grooved Black Mount Kit
27-0698	Grooved Chrome Mount Kit
27-0654	Grooved Chrome Mount Kit
27-0660*	Above w/Cats Paw pegs
27-0587*	Above w/Railer pegs
27-0892	Rounded Chrome Kit
27-0651	Basic Kit



31-0201

31-0264

31-0983

31-0933

31-0282

## Inspection Tag Holder

- Available in stainless or chrome. Measuring 3 1/2" square with 1/2" or 3/8" mounting hole which can mount to footpeg or shock studs. 31-0282 is square type which clamps on to 1" to 1 1/8" tube with worm clamp included.

VT No.	Item	Type
31-0201	Stainless	.5"
31-0264	Chrome	.5"
31-0933	Black	.5"
31-0983	Chrome	3/8"
31-0282	Chrome	Clamp

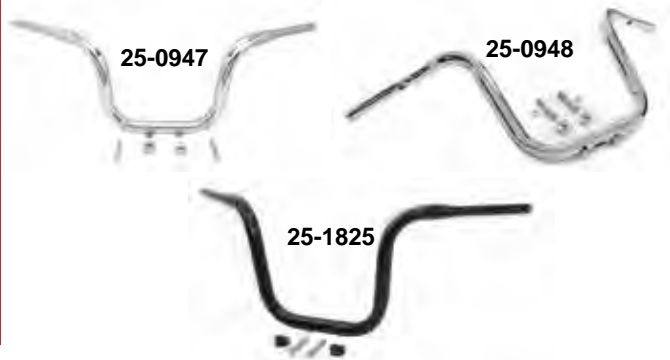

### Adjustable Ape-Hanger Bar

• Features a built in bolt which is in a track to allow fore and aft adjustment. Bars bolt directly to triple tree, no risers needed.

Chrome	Black	Height	Fits
25-0947	25-1825	12"	1980-83, 1984-13 FLT
25-0948	25-1826	14"	1980-83, 1984-13 FLT
25-0949	25-1827	15"	1980-83, 1984-13 FLT

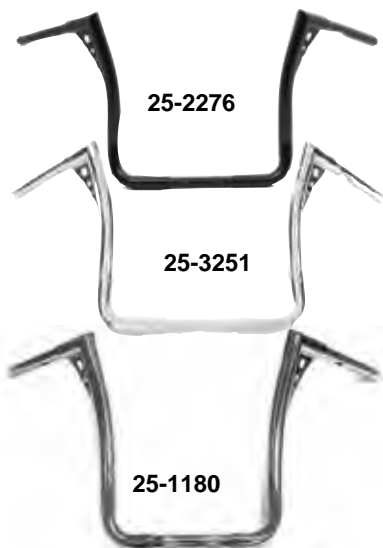

### Bagger Z Bar.

• Feature set back to accommodate fairing. Note: 2008-up style accept "throttle by wire" right side grip.

VT No.	Height	Description	Fits
25-2276	15"	with Indents & TBW	1982-13 FLT
25-0846	15"	with Indents	1982-07 FLT
25-3251	15"	with TBW	2008-13 FLT
25-1180	16"	with TBW	2008-13 FLT



### Poly Urethane Riser Bushing Set

• Includes 4 bushings with chrome covers.

VT No.	Fits	Year
28-2259	FLT	1983-13

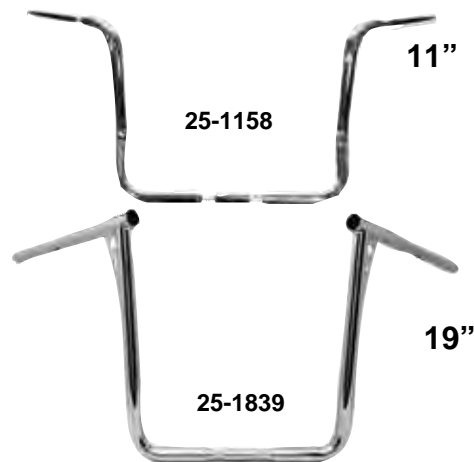

### Dresser Ape Hanger.

Chrome	Black	Height	Description	Fits
25-1158	25-1150	11"	With TBW	2008-13
25-0995	25-0982	13"	Ape Style w/TBW	2008-13
25-1129		14"	With Indents	1982-07
25-1131		19"	With Indents	1982-07
25-1159		14"	With TBW	2008-13
25-1838	25-1844	16"	With TBW	2008-13
25-1839	25-1845	19"	With TBW	2008-13
25-1161		19"	With TBW	2009-13



### Bagger Ape Style Bar.

• Fit 2014-up, 1 1/4" round

Chrome	Black	Size
25-0446	25-0501	12"
25-0447	25-0502	13"
25-0448	25-0503	14"
25-0449	25-0504	16"
25-0450	25-0505	18"

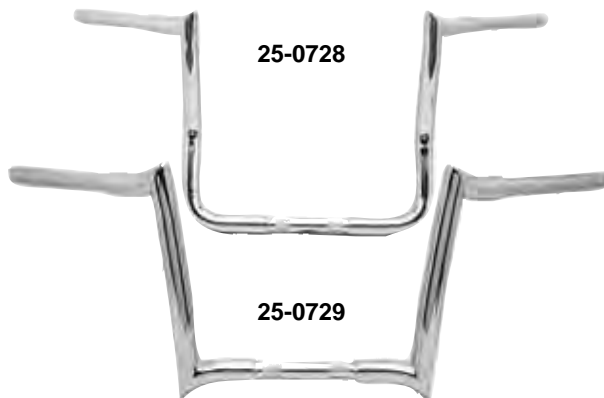

### Chrome Bar.

VT No.	Height	Fits
25-0728	15" without indent	2008-13 FLT
25-0729	12" without indent	2008-13 FLT



2008-up Throttle End

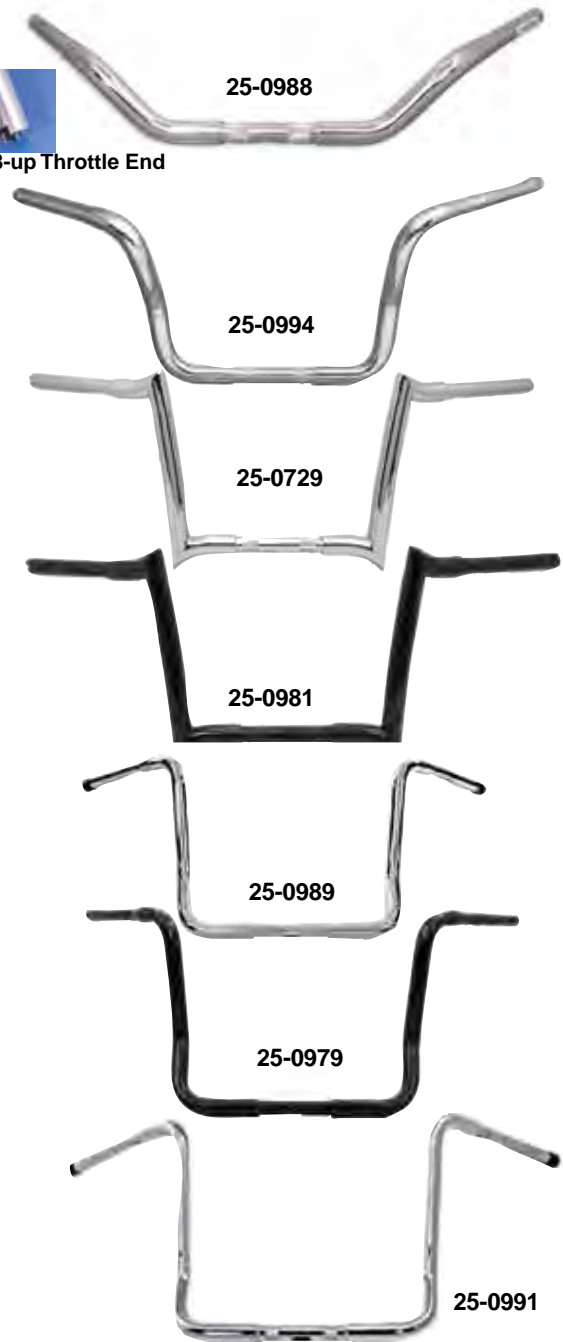

### Replica Handlebar.

Chrome	Size	Description	Fits
25-0875	6"	Replica Handlebars with Indents	1982-07 FLT
25-1840	8"	Glider Handlebar without Indents	1986-13 FLH
25-0665	8½"	Replica Handlebar with Indents	1982-07 FLT
25-0794	9"	Replica Handlebar with Indents	1982-07 FLT
25-1841	9"	Glider Handlebar without Indents	1986-13 FLHT
25-1835	9"	Vintage Handlebar without Indents	1986-13 FLHT
25-0876	10½"	Replica Handlebar with TBW	2008-13 FLT

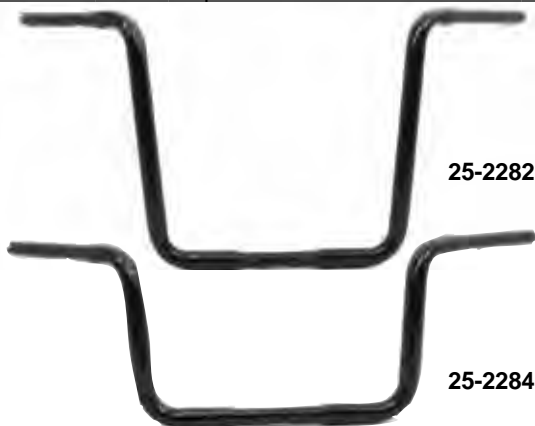

### Black Bar. \*Note: Throttle by wire

VT No.	Rise	Type
25-2282*	17"	Wide Body Ape Hanger
25-2283*	14"	Wide Body Ape Hanger
25-2284*	11"	Wide Body Ape Hanger

### Round Bars.

• 1¼" bars fit FLT models and feature set back to accommodate fairing. Note: 2008-13 style accept "throttle by wire" right side grip

Chrome	Black	Description	Fits
25-0988		3½" Without Indents	2008-13
25-0993		3½" With Indents	1982-07
25-0994		12" With Indents	1980-07
25-0729	25-0981	12" Without Indents	2008-13
	25-0452	13" With Indents	1982-07
25-0728	25-0980	15" Without Indents	2008-13
25-0989	25-0979	15" With Wiring Holes	2008-13
25-0786		16" With Indents	1982-07
25-0991	25-0978	16" With Wiring Holes	2008-13



# 1982-up Hand Lever



## Contour Lever Sets.

Chrome	Black	Year	Type
26-2178		1996-06	Smooth
26-0788	26-0984	1996-07	Drilled
26-0789	26-0111	1996-07	Slotted
26-0741	26-0981	2008-13	Smooth
26-0895	26-2113	2008-up	Slotted
26-0763	26-0762	2008-up	4 Hole
26-0765	26-0940	2014-up	Smooth
	26-0768	2014-up	Smooth
26-0767		2014-up	Trike Smooth
26-0326		2017-up	Slotted

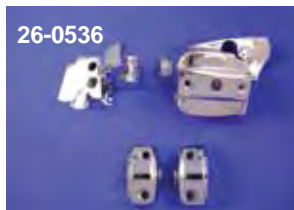

## Chrome Handlebar Control Cover Set.

• Includes clutch lever bracket, handlebar control clamps, master cylinder top and body cover, and hardware for complete installation.

VT No.	OEM	Disc	Year
26-0536	46098-98	Single	1996-2005
26-0537	46099-98	Dual	1996-2005



26-0527      26-0528      26-2133      26-0532



26-0519      26-0531      26-2153      26-2136

## Clutch and Brake Levers.

• Available in polished or chrome. Sold individually.

Chrome	Polish	OEM	Years	Type
26-0527	26-0528	45016-72	1972-81	Brake
	26-0517	Power	1972-81	Brake
	26-0519	Power	1972-81	Brake
26-0531	26-2136	45017-82	1982-95	Clutch
26-2133		45017-88	1988-95	Clutch
26-0532		45016-82	1982-95	Brake
	26-2135	45016-82	1982-95	Brake



26-0117      26-0325

## Handlebar Lever Sets

VT No.	Fits
26-0117	FLT 2008-up
26-0325	Wide Hand Levers FL 2014-up



26-0798      26-0799

## Hand Lever Set.

• Fits 2014-up FLT

Chrome	Black	Style
26-0798	26-0799	Vortex Lever Set
26-0800	26-0801	Drilled Lever Set



## Chrome Master Cylinder Assembly Kits

• Include switch housings. Kits fit 1996-06 with 1", 1¼" or 1½" handlebars. Available with or without chrome switches.

VT No.	Bore
22-0813	9/16"
22-0814	1 1/16"



22-0881

Models & Description	Bore	Without wiring
96-07 FLT Dual Disc with radio	1 1/16"	22-0883
96-07 FLT Dual Disc w/radio & cruise	1 1/16"	22-0881
08-up FLT Dual Disc with radio	15mm	22-0880
08-up FLT Dual Disc with radio & cruise	15mm	22-0882



26-0402

## Chopped Handlebar Master Cylinder and Control Housing Set

• For 1996-10 models.  
• Fits 1996-up FLT without cruise radio controls

With Switches	Without Switches	Years	Disc	Size
26-0410	26-0402	1996-05	Single	9/16"
26-0411	26-0405	1995-04	Dual	1 1/16"
—	26-0406	1996-2004 FLT/FLHT	Dual	1 1/16" w/Radio
—	26-0407	1996-2004 FLHT	Dual	1 1/16" w/Radio
—	26-0455	2014-up	Dual	Black



## 1996-07 Chrome Control Dress Up Kit

• Includes clutch lever bracket, handlebar control clamps, master cylinder top and body cover with levers and hardware for disc models as noted.

VT No.	Year	Model	Type
26-0549	1996-07	FLHT/TCU	Dual Disc
2553-10	2008-up	Screw Kit	



22-0821

22-0817



22-0818

## Chrome Smooth-Contour Control Kit

• Features a hidden underside mounting on the switch housings for an unobstructed smooth, rounded surface on top housing.  
• Switch housings use stock or chrome 1996-06 switches. Available in complete kits with or without chrome switches. Complete kits include clutch and brake levers, master cylinder, switch housings, brackets and hardware.

Without Switches	With Switches	Type	Disc
	22-0817	(.562) 9/16" MC	Single
22-0821	22-0818	(.687) 1 1/16" MC	Dual



26-0747

26-0181

## Chrome Handlebar Control Cover Kits

• Include master cylinder cover, clutch mount and two clamps.

VT No.	Model	Disc
26-0747	2008-up FLT without hydraulic clutch	Dual
26-0181	2005-07 FLT	Dual



## Chrome Handlebar Control Cover Kit

• Includes master cylinder

VT No.	Fits	OEM
26-0455	2014-up FLT	41700263



31-0519

34-9158

34-1968

## Mirror Mount Block.

• Fits 1996-2007 handlebar master cylinder to allow use of custom mirrors with larger than stock stem by moving the mirror stem up and out from the master cylinder.

VT No.	Item
31-0519	Right
34-9158	Right and Left
34-1968	As Above, black



28-0298



28-0857



28-0647



28-0891



28-0988



28-0856



28-0846



28-0646



28-0645



28-0654



28-0640



28-0664

## Handlebar Grip Sets

- For Touring models 2008-up
- Feature the built in serrations in the throttle side to twist the "TBW" throttle by wire electronic throttle assembly.

VT No.	Style
28-0298	Banded
28-0857	Flame
28-0647	Diamond
28-0891	Chrome Dome, 2008-up
28-0988	Swiss Cheese, Billet
28-0856	Vintage
28-0846	Stock Replica
28-0646	Iso Bar
28-0645	V-Tech
28-0654	Eagle Passion
28-0640	Tornado
28-0664	Slasher
35-9871	Tube

## Black Cobra Grip.

VT No. 28-0926



28-0934



28-0935



28-0934 Installed



28-0935 Installed

## Donkey Handlebar Grip Set

- With chrome end caps.

VT No.	Type
28-0934	Dual Cable
28-0935	TBW



28-0241



28-0242



28-0243



28-0244

## Handlebar Grip Sets.

2008-up Touring with TBW

28-0241	Plain, Chrome
28-0242	Shot Peened, Chrome
28-0243	Black with cut
28-0244	Stealth Tone Black



## Ignition Switch Cover Set

- Fits 1996-2009 FLHT-FLHTCU and FLHX Touring models.

VT No. 42-0166



## 12V Receptacle

- For cell phone, MP3 player or lighter.

VT No. 32-0845





## Handlebar Control Switch Housing Kits

VT No.	Item
32-0276	Chrome with chrome
32-0277	Chrome with black switches
32-0278	Black with black switches
32-0279	Black with chrome switches



## 2008-up Chrome Clutch Handle Assembly

- Includes mount bracket, clamp and handle assembled.

VT No. 26-2207

33-0561



## Universal Cigarette Lighter

- Available for panel mounting

VT No.	Type
33-0561	Without bracket
33-0562	With bracket



48-0490



48-0491



48-0492



48-0493



48-0494



48-0495



48-0496



48-1790



48-0497

## Pewter Emblems with adhesive backing.

VT No.	Size	Style
48-0490	4" x 3"	Skull with sickle
48-0491	3" x 1"	5 Skulls
48-0492	2" x 3"	Grim Reaper
48-0493	1.5" x 2.5"	Skull
48-0494	2.5" x 2.5"	Maltese Cross with Skull
48-0495	1.5" x 1"	Skull
48-0496	3" x 1"	Winged Skull
48-0497	5" x 2"	Bat Wing
48-1790		Bronze Patina Eagle



26-0765



26-0452



26-0455



22-0583

## Handlebar Control

Chrome	Black	Fits
26-0765	26-0768	Hand Lever for 2014-up, Chrome
26-0452	—	Switch Housing for 2014-up FLT
26-0455	—	Clutch Bracket & Master Cylinder Reservoir Kit
22-0583	—	Kit, 2014-up



48-0550

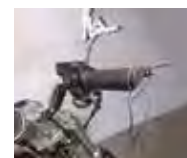

48-0449

## Black Leather Accessories.

VT No.	Description
48-0550	Lever Covers
48-0449	Grip Covers
48-1714	Lever Covers with 16" fringe



## Chrome Electronic Device Holder

- Mounts to left side control clamp on 1996-up models.

VT No. 31-1233



## Traffic Light Sensor

- Triggers stoplight from motorcycle when on traffic light pad.

VT No. 32-1352



## Cell Phone Mount

- Made of black ABS construction and features adjustable ball-socket swivel mount. For use with FLT dealer models.

VT No. 48-0842



32-1525

32-1526



32-1534

32-1528



32-1529



32-6660



32-6661



32-6662



32-6663



32-6652



32-6653



32-6654



32-6655



32-6680



32-6651

32-6686

## Chrome Handlebar Switch Kit.

VT No.	Years	Type
32-1525	2007-up	Radio
32-1526	2007-up	Radio/Cruise
32-1534	2007-up	As Above with black switches
32-1528	1996-06	Radio/Cruise
32-1529	1996-06	Radio



32-7015



32-7017



32-7016



32-7018

## Backlit LED Handlebar Switches & Wiring Harness

• Without switch housing. LED is amber & wires 60" in length.

Black	Chrome	Fits
32-7014	32-7019	1998-up FLHTCUI
32-7015	32-7020	2008-up FLHX
32-7016	32-7021	2006-2007 FLHX
32-7017	32-7022	1998-2003 FLHTC
32-7018		2004-up FLHTC

## Extended Handlebar Wiring Harness Kit

VT No.	Fits
32-7814	1996-06 FLT
32-7823	1996-2006 FLT with factory radio
32-7832	2009-2012 FLT with electric throttle

## Handlebar Wiring Extension Kits.

Fits 1996-06 FLT, FLHT (12 Wires per side)

32-6660	+4" Extension
32-6661	+8" Extension
32-6662	+12" Extension
32-6663	+15" Extension

Fits 2007-13 FLHT, FLHR, FLHX, FLTR (12 Wires right/14 left)

32-6652	+4" Extension
32-6653	+8" Extension
32-6654	+12" Extension
32-6655	+15" Extension

Fits 2007-13 FLHT, FLHR, FLHX, FLT (17 Wires, Note: Does not include wires for radio, CB or throttle controls).

32-6680	+4" Extension
32-6682	+8" Extension
32-6683	+12" Extension
Fits 2014-up FLHT, FLHR, FLHX	
32-6686	+18" Extension
Fits 2008-up FLHT, FLHT, FLHX	
32-6651*	One Size

\*Note: 18" Extended Throttle by Wire Harness Only

Throttle by Wire Handlebar Wiring Extension Kits includes factory type connectors for easy assembly.

32-6687		FLT 2014-2015
32-6688	+8"	2016-up FLT, FXST, FLST
32-6689	+15"	2016-up FLT, FXST, FLST





32-0564



32-0581



32-0563



32-0562



32-0565

## Chrome Switch Cover Set.

Snap on covers replace existing black switch covers.

VT. No.	Fits
32-0564	1996-up FLHTCU (Ultra Classic Electra Glide) 1996-up FLTR (Road Glide)
32-0563	1996-up FLHT (Electra Glide Standard); 1996-up FLHTC (Electra Glide Classic) without cruise control
32-0562	1996-up FLHR (Road King), 1998-01 FLHRCI (Road King Classic)
32-0565	2002-up FLHRCI (Road King Classic) with cruise control
32-0581	1996-up FLHT with cruise control, FLHTC, 2006-up FLHX without cruise control



32-0364



32-0365



32-0367



32-0366



32-0368

## Chrome Rocker Style Handlebar Switch Kit

VT No.	Item
32-0364	Rocker Switch Kit Chrome Set of 2. Cruise/Accessory with Harness & Connector 2008-up FLHX OEM 70219-08CP
32-0365	Rocker Switch Kit Chrome Set of 4. Cruise/Accessory/Spot Lamp/Speaker with Harness and Connector. 1998-up FLHTCUI OEM 70271-98CP
32-0366	Rocker Switch Kit Chrome set of 3. Cruise/Accessory/Spot Lamp 2004-up FLHT/C OEM 70278-04CP
32-0367	Rocker Switch Kit Chrome Set of 2. Cruise/Accessory with Harness and Connector. 2004-up FLTR OEM 71625-04CP
32-0368	Rocker Switch Kit Chrome Set of 2. Speaker with Harness and Connector. 1998-03 FLTR OEM 71655-98CP



26-2253

26-2254

26-2256

## Chrome Switch Housing Kit.

Includes press on chrome switch caps for easy installation.

VT No.	Model
26-2253	1996-2013 FX-XL-FXD-FLHR without cruise control
26-2254	1996-2013 FLHT/C/I
26-2255	FLHTCUI, FLTRI, 1996-up
26-2256	FLHRCI 2002-up



32-1129



32-1130



32-1131



32-1132



32-1133



32-1134

## LED Rocker Switch Kits

VT No.	Fits	Function
32-1129	2007-up FLT	Radio
32-1130	1996-06 FLT	Radio
32-1131	2007-up FLT	Cruise
32-1132	1996-06 FLT	Cruise
32-1133	2007-up FLT	Radio/Cruise
32-1134	1996-06 FLT	Radio/Cruise



32-1091



32-1092



32-1093



32-1094



32-1095

## Gold Switch Cover Kits.

VT No.	Fits
32-1091	FXD, FXST, FLHR 1996-up, VRSC 2002-2002, FLHRCI 1998-2001
32-1092	FLHT 1996-up without cruise control
32-1093	FLHTCUI, FLTR 1996-up
32-1094	FLHRCI 2002-up without cruise control
32-1095	FLHT, FLHTC 1996-up, FLHX 2006-up use on cruise control models





33-0922

**Complete Horn Kit**

• Includes 12 volt compressor, 150mm and 195mm chrome horn set, bracket and cover. **VT No. 33-0922**



33-1006

**Air Horn Kit**

• Includes dual chrome horns with black end caps, 12 volt compressor, cover, and chrome mount bracket.

**VT No. 33-1006**



33-1909



42-5043

**Chrome Air Horn Kit**

• Includes 12V compressor. 150 mm and 195 mm horns.

VT No.	Item
33-1909	Horn Kit
42-5043	Cover
31-1178	Bracket



**Chrome Air Scoop**

• Mounts on left side top motor mount studs on 1991-up Touring models. Will act as scoop for improved cooling and horn cover.

**VT No. 42-1010**



42-1134



42-5041



42-1135



42-1053



42-1179



42-1084



42-5047



42-1182



42-1194

**Horn Covers**

• Round and CVO style horn covers with finishes as noted  
 • Fits 1993-up FLT except where noted..

VT No.	Style	
42-1134	Round Spoke Chrome	
42-5041	Skull	
42-1135	Round Slotted Chrome	1991-up
42-1053	Chrome CVO	
42-1179	Black CVO	
42-1084	Louvered Chrome	
42-5047	Black Skull	1991-up
42-1182	Smooth Round, Black	1991-up
42-1194	Black Wrinkle	1991-up



**Replica Horn Kit fits 1991-up FLT.**  
**VT No. 33-0798**



34-8218 Installed

### Chrome Mirror Set.

- Offers updated styling as mirrors mount behind fairing at grip area. Drilling of fairing shell required.

VT No. 34-8218



34-0405

34-1335



34-1336

34-1337



### Fairing Mount Mirror Set

- Fits FLT models.
- Mount inside the "bat wing" style fairing and feature a wide range of adjustments.
- Mounting template for easy installation

1996-13	2014	Finish/Type
34-0405	34-0055	Chrome
34-1335	34-0056	Black
34-1336	34-0058	Black, Split Vision
34-1337	34-0057	Chrome, Split Vision

34-1736



34-1737



### Mini Fairing Mount Mirror Set.

Chrome	Black
34-1736	34-1737

34-1221



LED display

LED display

34-1222



34-1224

34-1591



### Touring Mirror Set.

- Available with optional LED turn signal set built in.

VT No.	Finish	Type
34-1221	Black	LED
34-1222	Chrome	LED
34-1224	Chrome	Plain
34-1591	Cover Set	



34-0049

34-0052

### Mirror Block Off Plate Set.

VT No.	Finish
34-0049	Chrome
34-0052	Black



### Roller Dolly

- Holds up to 1250lbs
- VT No. 16-1026



### Roller Dolly

- Features nylon wheel and has a capacity of 1250 lbs
- VT No. 16-1999



### Factory Spare Parts Book

VT No.	OEM	Fits
48-0602	99456-01	2001 FLT
48-0718	99456-03	2003 FLT



16-0529

### Mini-Lift

- For use lift on table or floor to free wheels.1000 lbs capacity with a rubberized top plate. V-Twin logo and bright orange paint.

VT No. 16-0529



### DIY Touring Tool Kit

- For 1999-2013 models will fit in a kidney shaped tool box. Includes rider tools and service tools for the rider-mechanic.

VT No.	Fits
16-0011	1999-13
16-0098	2014-up



### Ignition Switch Tools

VT No.	Fits
16-0003	2003-13
16-0017	2003-13
16-1137	2014-up
16-1265	2014-up



### Tool Kits

VT No.	Fits
16-0857	1985-up
16-0850	1979-84





# Big Twin 1984-up Index

## A

<b>ADVANCE UNIT</b> .....	<b>338,340</b>
<b>AIR CLEANER</b> .....	<b>371-387</b>
Adapter.....	389
Adapter Plates.....	389,401
Breather.....	390-392
Cone.....	386
EFI.....	372, 378,384
Filter.....	376,378,384,380,381,382,384,385,
.....	386,387,388
Hi Flow.....	373,376,377
Insert.....	383
Mount.....	389
Mount/Hardware.....	367,369,373,374
S&S.....	385
Teardrop.....	372,373,375,379,382
.....	374,385,399
Turbo.....	381,386
V-Charger.....	371,386
Velocity Stack.....	381, 387,399,400
<b>AIR FILTER</b> .....	<b>376,378,384,380,381,382,384,</b>
.....	<b>385,386,387,388</b>
TC Upgrade Kit.....	374
Recharge Service Kit.....	388
<b>ALLEN SCREW KIT</b> .....	<b>412</b>
Listing.....	1319
<b>ALTERNATOR</b> .....	<b>350-355</b>
Charging System.....	353-354
Ring Replacement.....	352
Rotor.....	351,352,353
Stator.....	350
<b>AXLE</b> .....	<b>453-458,459,461</b>
Adjuster.....	459
Cap Covers.....	272,458,461
Front.....	453-454,455
Nuts.....	456
Rear.....	456-459
Spacers.....	455,457

## B

<b>BACKREST</b> .....	<b>287,1240</b>
<b>BAFFLE</b> .....	<b>325</b>
<b>BATTERY</b> .....	<b>367-370,482</b>
Cable.....	367
Cover/Side/Top.....	370
Eliminator.....	338
FXST Hardware.....	370
Hydrometer.....	368
Mount Hardware.....	370,431
Pad Kit.....	370,431
Strap.....	370,431
Terminal Hardware.....	368
<b>BEARING</b>	
Cam.....	148,154-155
Clutch/Drum.....	197-201
Crankcase.....	145-148
Kick Start.....	196
Neck Post/Tree Stem.....	260,271,281-282
Primary.....	211,357,452
Pinion.....	147
Rod.....	145
Starter.....	360
Swingarm.....	304-307
Throttle Sleeve.....	403
Thrust Washer.....	404
ThrowOut.....	405
Wheel.....	460-461
<b>BELT BUCKLES</b> .....	<b>1325</b>
<b>BELT DRIVE</b> .....	<b>210-213</b>

## BELT DRIVE CONTINUED

Belt.....	212,215
Belts (Rear).....	215
Bolt Kit.....	207
Cover.....	211
Guard/Dress Up.....	211,212,288-289
Pulley.....	214,215,216-217

## BIKE KIT.....413

## BOLT LIST.....1319

## BOOK.....1268-1270

## BRAKE.....225-238

Banjo Bolt.....	256,263
Bleeder Screw.....	249
Caliper.....	242-249
Caliper Brackets.....	243,245
Caliper Front.....	246-248
Caliper Rear.....	242-245
Caliper Rebuild.....	249
Caliper Thread Chart.....	246
Disc.....	248,250-254
Disc Bolt.....	255
Disc Brake Pad.....	260
Disc Pulley Spacers.....	255
Fittings and Parts.....	256,257
Hose.....	256,257
Line.....	257-259
Master Cylinder (Front).....	1053
Master Cylinder (Rear).....	239,240,241
Master Cylinder Cover.....	241,1052
Master Rebuilds.....	240
Pad.....	250
Pedal.....	237-238
Pedal Pad.....	229,237-238,1069
Reservoir Cover.....	241
Plunger.....	240
Pulley/Brake Kit.....	243,244
Rod.....	235
Spring Fork.....	1219-1221
Switch.....	256,364
Tee/Tube.....	256

## BREATHER.....390-391

Banjo Bolts.....	390
Bolts.....	390
Canister.....	391
Gear.....	152
Oil Collector.....	392
Performance.....	377
Valve Service.....	1264

## BUMPERS.....245,296

## BUSHING LIST.....1307

## C

### CABLE

Battery.....	367
Choke.....	405
Clamp.....	257,405
Clutch.....	407,408
Fork Tube Clip.....	405
Heat Shrink Tube.....	367,408
Idle.....	404,406,409
Speedometer.....	410
Throttle.....	404,406,409
Wire Loom Clip.....	1290
Wrap.....	408

### CALIPER

Brake Inserts (Chrome).....	241,246
Front.....	246-248
Rear.....	242-245

## CAM

Bearing.....	148,154-155
Bushing.....	146,155
Bushing Replacement.....	1264
Chest Kit.....	154
Cover/Gasket.....	154,184,1309
Gasket/Sealer.....	184
Gear.....	156-157,158,159
Performance Kit.....	155
Rebuild.....	249
Shaft.....	148,156-159
Support Plate.....	148

## CAP(Chrome)

Axle.....	458,461,463
Chrome.....	428,461,1318
Fork.....	270,272
Gas.....	416,1202-1207,1232
Hub.....	463
Oil.....	433
Snap.....	412,413,1318

## CARBURETOR.....394-402

Adapter.....	394
Bendix.....	394
CV Keihin.....	396-398
Dell'Orto.....	394
EFI.....	395
Idle Screw.....	398
Jet.....	396,397,398,399,400
Keihin.....	396-398
Manifold.....	393-394
Mikuni.....	401,402
Power Tube.....	397
S&S.....	399-400
Seal.....	394
SU.....	402
Weber.....	402

## CASE.....142,143,189

Bolt Set.....	142
Boring Service.....	1263
Race.....	147
Seal.....	1316

## CHAIN

Adjuster/Tensioner.....	208
Bolt Kit.....	207
Diamond.....	209
Drive System.....	207
Guard.....	288-289
Masterlink.....	1355
Primary.....	208,209
Tensioner.....	208
Tsubaki.....	1054

## CHAIN GUARD.....288-289

## CHARGING SYSTEM.....353-354

## CHOKE CABLE.....405

## CIRCUIT BREAKER.....361

## CLAMP

Cable.....	257,405
Exhaust.....	320,324
Hose.....	1200,1201
Wire.....	1216

## CLEANER.....1271

## CLUTCH.....197-205

Adjuster.....	204
Cable.....	407-408
Control (Handle).....	205,1044-1051
Clutch Kit.....	202,203
Hub.....	197,198,199
Jockey.....	231
Lever.....	219

**CLUTCH CONTINUED**

Pack.....200-201  
 Pedal Pad.....229,237-238  
 Plate.....197-203  
 Police Kit.....203  
 Pressure Plate.....210  
 Pushrod.....204  
 Release.....204  
 Release Cover.....194,204  
 Rod.....204  
 Spring.....202  
**COIL.....327-333,339,340,341**  
 Bracket.....328,329  
 Cover.....331,333  
**COIN HOLDER.....1031**  
**CONDENSER.....340,1291**  
**CONNECTING ROD.....144,145,1261**  
**CONNECTOR (WIRE).....1290-1292**  
**COUNTERSHAFT.....190-191**  
**COTTER PIN LIST.....1316**  
**COWL.....1091,1095**  
**CRANKCASE.....146**  
 Bearing.....146-148  
 Breather Valve.....149  
 Bushing.....146  
 Crankpin.....145  
 Sensor.....148  
 Sprocket Shaft.....147  
**CRANKPIN.....146**  
**CRANKSHAFT.....146**  
 Balance Service.....1263  
**CUSTOMIZER KIT.....173**  
**CYLINDER.....178,179,180,181**  
 Base Cover.....172  
 Big Bore Kit.....179,180,181,  
 Boring Service.....1260  
 Evolution.....180-181  
 Gasket.....181,184,1308,1312  
 Head.....178,179,180,181  
 Sleeving.....1260  
 Twin Cam.....178-179

**D**

**DASH.....421-423**  
 Base.....419  
 Bracket.....414,418  
 Decal.....422  
 Dress Screw Kit.....422  
 Iso Mount.....370  
 Panel/Divider.....420,422  
 Stash Box.....101  
 Switch.....361-363,364,365  
 Wiring.....365  
**DERBY.....449,450**  
**DECAL.....422,1209**  
**DERBY COVER.....449,450**  
**DEUTSCH CONNECTOR.....1291,1292**  
**DIAGNOSTIC.....340,346,347**  
**DIPSTICK**  
 Oil Tank.....433  
 Transmission.....196  
**DOWEL PIN LIST.....1316**  
**DRAIN PLUG**  
 Engine.....434  
 Fork.....277  
 Transmission.....189,190  
 Oil.....434  
**DRESS UP KIT.....173**  
 Derby Cover.....449,450  
 Ignition Cover.....348  
 Primary Cover.....444-445,446

**E**

**ELECTRICAL**  
 Battery.....367-370,437  
 Charging.....353-354-  
 Coil.....331-333,339,340,341,342,343  
 Connector.....1290-1292  
 Regulator.....331-333,339,340,341,342  
 Spark Plug.....334  
 Spark Plug Wire.....336-337  
 Starter.....355-356  
 Switch.....361-363,364,365  
 Terminal Board.....361  
 Wiring.....361-363,365,366  
**ELECTRONIC FUEL INJECTION (EFI).....403**  
**EMBLEM.....296,1206,1208-1209**  
**END COVER.....194,195**  
**ENGINE**  
 Bar.....298  
 Bushing List.....1298  
 Case.....143  
 Case Set.....143  
 Chrome Valve Cover.....169  
 Drain Plug.....142  
 Dress Up Kit.....173  
 Flywheel.....144-145  
 Gasket.....185,186,1308,1312  
 Guard/Leggin.....298  
 Head.....169  
 Headbolt/Cover.....166,169  
 Mount.....142,144,327-330  
 Performance.....143,145,330  
 Race.....147  
 Remanufacture Service.....1260  
 Roller.....146,147  
 Seal List.....1315,1316  
 Sealant.....1271  
 Short Block.....144  
 Skid Plate.....305  
 Spacer List.....1320  
 Sprocket.....209  
 Stabilizer.....330  
 Stroker Kit.....144  
**EXHAUST.....308-322**  
 Baffle.....325  
 Blue Shield.....317  
 Bracket.....310,311,313,316,317,320  
 Clamp.....313,320,324  
 Clamp/Bracket.....313,320,324  
 Cross over.....320  
 Fishtail.....301,317  
 Goose.....317  
 Heat Shield.....316,323,325  
 Monster.....312  
 Muffler.....308-312,313,316,318,319  
 Oxygen Sensor.....315,320  
 Port Replacement.....1265  
 Sleeve.....323  
 Taper Valve.....323  
 Tip/End.....308,317,318  
 Torque Tube.....325  
 Upsweep.....311  
 Wrap.....323

**F**

**FENDER.....290-294**  
 Bolt Set.....291,292  
 Brace.....291,1227  
 Bracket.....291,292  
 Bumper.....296  
 Emblem.....296  
 Extension(Rear).....293,305

**FENDER CONTINUED**

49mm Fork.....260  
 Front.....290,291,292  
 Glide.....290,291  
 Grill.....296  
 Light.....1169  
 Luggage Rack.....286,479-480  
 Mount.....290,291  
 Mud Flap.....292  
 Mud Flap/Extension.....293  
 Pad (Seat).....1240  
 Spring Fork.....291,1220  
 Strut.....295  
 Rail.....296  
 Rear.....293-294  
 Rivet.....291,292,1316  
 Trim/Tip.....292,294,296,297  
**FILTER**  
 Air.....376,378,380,381,382,384  
 .....385,386,387,388  
 Fuel.....1199-1200  
 Oil.....436-439  
**FLASHER.....368**  
**FLYWHEEL.....142,145,1261**  
 Balance Service.....1262  
 Crank Sensor Cover.....148  
 Remanufacture.....1261  
**FOOTBOARD**  
 Extension.....225  
**FOOTPEG.....227,1058-1060,1064-1068,**  
**.....1070-1072**  
 Extended.....1068  
 Heel Rest.....1060  
 Relocate.....1059  
**FORK.....260-282**  
 Boot.....260,278  
 Boot/Cover.....260  
 Brace.....260,275  
 Bushing Service.....1265  
 Cap.....270,272,279,280  
 Conversion Kit (Glide).....271  
 Cover.....268  
 D Style.....265  
 Damper.....275,277  
 Drain Plug.....272,277  
 Glide.....268  
 Internal.....276,277  
 Installation Kit.....262  
 Inverted.....311  
 Leg Assembly.....270,272  
 Leg Bushing.....1265  
 Leg Set.....270,272  
 Lock Tab.....268  
 Lowering Kit.....276  
 Narrow Glide.....272  
 Neck Cup.....281-282  
 Phatt.....261  
 Plug (Top).....272,280  
 Raked Neck.....281  
 Seal.....279  
 Slider.....272,273  
 Spring.....276,277  
 Spring Fork.....1219,1221  
 Spring Fork Rebuild.....1265  
 Stabilizer.....275  
 Stem Nut/Cover.....271,272  
 Stem Parts.....268,269  
 Stop.....280  
 Triple Tree.....260,265,267,271  
 Tube.....260,273,274  
 Tube Clamp.....405

<b>FORK TUBE</b> .....	<b>260,273,274</b>
<b>FORWARD CONTROL</b> .....	<b>221-241</b>
<b>FRAME</b>	
Bar.....	298
Cover.....	306,313
Guard.....	298
Neck Kits.....	281-282
Offset Component.....	304
Right Side Drive.....	302
Pivot Kit.....	306
Skid Plate.....	305
Swing Arm.....	302,304,307
Trim and Cover.....	306

**G**

<b>GAS TANK</b> .....	<b>412-417,1231-1234</b>
Cap.....	416,1202-1207,1232
Dash/Tank.....	420,421,422
Decal.....	422,431
Divider.....	420
Emblem.....	298,1208-1209
Filter.....	1199,1200
Gasket (Cap).....	312
Line.....	1200,1201
Mount.....	414,415
Panel.....	421-423
Petcock.....	1196-1198
ShutOff.....	1199
Tank/Dash Kit.....	420,421,422
<b>GASKET</b> .....	<b>1308-1313</b>
Air Cleaner.....	1313
Cam Cover.....	184,1309
Carburetor.....	1313
Cometic.....	1313
Cylinder.....	181,184,1308,1312
Derby Cover.....	1310
Distributor Base.....	1310
Engine.....	185,186
Exhaust.....	1310
Gasket List.....	1308-1313
Gas Tank Cap.....	1312
Generator.....	1309
Head.....	1308
Ignition.....	1310
Inspection.....	1310
Manifold.....	1313
Master Cylinder.....	1312
Oil Pump.....	1309
Pushrod.....	1309
Primary.....	451,452,1303,1313
Rocker.....	1308
Sealant.....	1271
Tail Lamp.....	1312
Tappet Guide.....	1308
Top End.....	185,186
Transmission.....	1311
<b>GASKET KIT</b> .....	<b>185-186</b>
<b>GASKET LIST</b> .....	<b>1308-1313</b>
<b>GAUGE</b>	
Oil.....	440,441,443
Speedo/Tachometer.....	423-428
<b>GOGGLE</b> .....	<b>1271</b>
<b>GRIP</b> .....	<b>1083-1090</b>

**H**

<b>HANDLEBAR</b>	
Control/Switch.....	1044-1051
Clamp.....	1041
Damper.....	1039,1040
End Plug.....	1090

**HANDLEBAR CONTINUED**

Riser.....	1036-1043
Spring Fork.....	794-795
Wiring.....	1050-1051
<b>HANDLEBAR GRIP</b> .....	<b>1083-1090</b>
Cover (Leather).....	1086
Heated.....	1090
<b>HARDTAIL</b> .....	<b>307</b>
<b>HEAD</b>	
Bolt.....	168
Cover.....	166
Dress Up.....	169
Gasket.....	184,1308,1312
Remanufacture.....	1264
Resurfacing.....	1264
<b>HEADLAMP</b> .....	<b>1091-1093,1095-1109</b>
Bates.....	1099
Bracket.....	1101,1104,1108,1109,1220
Bulb.....	1106,1107
Connector.....	1096
Cowl.....	1091,1095
Cycle Ray.....	1105
Fork Cover Set.....	1094
HID.....	1104
Internal.....	1091,1104
Rim.....	1091,1092,1095,1102
Spring Fork.....	1104
Visor/Trim.....	1095,1096,1101,1102
	1103,1106,1107
<b>HEATSHIELD</b> .....	<b>324</b>
<b>HELICOIL</b> .....	<b>1306</b>
Installation Service.....	1264
<b>HIGHWAY BAR</b> .....	<b>1056,1058</b>
<b>HORN</b> .....	<b>1170-1175</b>
<b>HOSE</b> .....	<b>435,1200,1201</b>
Cover.....	435,1201
End.....	435,1200,1201
<b>HUB</b> .....	<b>463,464</b>

**I**

<b>IGNITION</b>	
Advance Unit.....	348,340
Bracket.....	348
Circuit Breaker.....	361
Clamp.....	340
Coil.....	349
Condenser.....	340
Controller.....	344-347
Cover(Points).....	335
Fuel Injected.....	345,346-347
Points.....	335
Magneto.....	1294-1296
Module.....	341,343,345
Spark Plug.....	334
Switch.....	361,362,363,364
Timing Plug.....	336
Tune Up.....	344
Vacuum Switch Assembly.....	345,364
Weight Spring.....	338
Wiring.....	366
<b>INDICATOR LAMP</b> .....	<b>1101</b>
<b>INSPECTION COVER</b> .....	<b>450</b>
<b>INSPECTION TAG</b> .....	<b>224</b>
<b>INTAKE</b> .....	<b>393-402</b>
EFI.....	395

**J**

<b>JIFFY STAND</b> .....	<b>283-284</b>
<b>JET</b> .....	<b>398</b>
<b>JOCKEY</b> .....	<b>231</b>

**K**

<b>KEYCHAIN/KEYHOLDER</b> .....	<b>1024,1325-1327</b>
<b>KEY</b> .....	<b>174,1317</b>
<b>KICKSTAND</b> .....	<b>283-285</b>
<b>KICKSTART</b> .....	<b>198</b>
Conversion Kit.....	198
<b>KROMMET</b> .....	<b>1145,1146</b>

**L**

<b>LAPEL PIN</b> .....	<b>1324</b>
<b>LENS</b> .....	<b>1137-1139,1153</b>
<b>LEVER</b> .....	<b>1041-1051</b>
Hand.....	1041-1051
Pin/Bushing.....	1041
Shift.....	218-219
Skull.....	1041
<b>LICENSE</b> .....	<b>1120-1128,1142-1147</b>
<b>LIFTER/TAPPET</b> .....	<b>162-165</b>
Base.....	160,165
<b>LIFT</b> .....	<b>1274</b>
<b>LIGHT</b> .....	<b>1091-1169</b>
Bar.....	1153
Bulb.....	1106,1140-1141,1168
Fender.....	1169
Gasket.....	1165
Headlamp.....	1091-1093,1095-1109
Indicator.....	1101,1168
Marker.....	1148-1151,1154
Reflector.....	1166
Signal.....	1155-1164
Spotlamp.....	1110-1115
Tachometer/Speedometer.....	1168
Tail Lamp.....	1116-1138
Turn Signal.....	1155-1164
<b>LOCK TAB LIST</b> .....	<b>1317</b>
<b>LONG BLOCK SERVICE</b> .....	<b>1260</b>
<b>LOCKWASHER</b> .....	<b>1320</b>
<b>LUGGAGE RACK</b> .....	<b>286,479-480</b>

**M**

<b>MAGNETO</b> .....	<b>1294-1296</b>
<b>MAINSHAFT</b> .....	<b>187,190-192</b>
<b>MANIFOLD</b> .....	<b>393-394</b>
<b>MASTER CYLINDER</b>	
Cover.....	241,1052
Front.....	1053
Gasket.....	239,1312
Rear.....	239,240
Rebuild Kit.....	240,1053
<b>MIRROR</b> .....	<b>1176-1195</b>
Extension.....	1195
Lighted.....	1178,1183
Metric Adaptor.....	1195
Vintage.....	1191
<b>MODULE</b> .....	<b>341-343,345</b>
<b>MOTOR PLAQUE</b> .....	<b>189,429,447</b>
<b>MOTOR SHOP SERVICE</b>	
Alternator Ring Replacement.....	1263
Breather Valve Machining.....	1265
Cam Bushing Big Twin.....	1264
Case Boring.....	1263
Crankshaft Balance.....	1263
Cylinder Boring.....	1260
Cylinder Sleeving.....	1260
Engine Remanufacture.....	1260
Exhaust Port Replacement.....	1265
Flywheel Balancing.....	1262
Flywheel Assembly.....	1262
Flywheel Remanufacture.....	1261
Fork Leg Bushing Install.....	1261
4/5 Speed Rebuild.....	1265



**MOTOR SHOP SERVICE CONTINUED**

5/6 Speed Conversion Service.....	1265
Generator Rebuild.....	1263
Head Remanufacture.....	1264
Head Resurface.....	1264
Linkert Rebuild Service.....	1263
Long Block Remanufacture.....	1260
Magneto Rebuild.....	1294
Short Block Remanufacture.....	1260
Spark Plug Helicoil Service.....	1264
Spring Fork Rebuild.....	1265
Transmission Remanufacture.....	1265
Valve Seat Service.....	1264
Wheel Truing/Build.....	1265
<b>MOTORCYCLE COVER.....</b>	<b>1266</b>
<b>NECK CUP KIT.....</b>	<b>281-282</b>
<b>NUT LIST.....</b>	<b>1321,1322</b>

**O****OIL**

Change Service Kit.....	439
Cooler.....	442,443
Dipstick.....	433
Drain Plug.....	431,434
Filter.....	436-439
Fitting.....	149,434,435
Gauge.....	440,441
Line.....	435,437
Motor/Transmission/Gear.....	1262
Mount Hardware.....	431
Oil(Quarts).....	1262,1272
Plug.....	431,433,434
Pressure Switch/Pressure.....	364,441
Pump.....	149-151,153
Seal List.....	1315
Tank.....	430,431,432
<b>O-RING.....</b>	<b>1314</b>

**P**

<b>PARTS MANUAL.....</b>	<b>1268-1270</b>
<b>PATCHES (CLOTH).....</b>	<b>213,1323,1327</b>
<b>PETCOCK.....</b>	<b>1197-1198</b>
<b>PEDAL PAD.....</b>	<b>229,237-238,1069</b>
<b>PEGS.....</b>	<b>1064-1068,1070-1075</b>
<b>PILLION PAD.....</b>	<b>1240</b>
<b>PIN LIST.....</b>	<b>1316</b>
<b>PINIION.....</b>	<b>147,155</b>
<b>PIPES.....</b>	<b>308-322</b>
<b>PISTON.....</b>	<b>143,144,179,181</b>
<b>PLUGS</b>	
End Plug.....	1090,1316
Engine.....	434
Fork (Top End).....	272,280
Fork Drain.....	272,280
Magnetic.....	189,434
Oil Tank.....	431,433,434
Spark Plug.....	334
Timing.....	336
Transmission Fill.....	196

**POINTS**

Conversion Kit.....	338
Cover.....	340

**POLISH/CLEANERS.....1261****POUCH.....1267****PRIMARY**

Chain.....	209
Cover/Trim.....	444-445,446
Derby.....	449,450
Dress up Kit.....	173
Drive Kit.....	201

**PRIMARY CONTINUED**

Gasket.....	451,452,1308,1313
Hardware.....	357,451-452
Inner (Cover).....	313,447-448
Inspection (Cover).....	450
Outer.....	444-446
Screw Kit.....	444-446
<b>PULLEY.....</b>	<b>214,216,217</b>
Bolt.....	207
Brake/Rotor Kit.....	244
Disc/Spacer (Rear).....	207,215
Cover.....	217
Spacers.....	207,215
<b>PUSHROD.....</b>	<b>160-163,176</b>
Clutch.....	204
Cover.....	166,167
Seal.....	171,1315

**R****RACE**

Case.....	147
Rod.....	145

**RAIL**

Fender.....	296
Sissy Bar.....	287

**REFLECTOR.....1166****REGISTRATION HOLDER.....224****REGULATOR/RELAY.....348,349**

Brackets.....	348
Covers.....	348
Wiring.....	366

**RIM.....470-471****RING.....179,182-183****RISER.....1032-1040**

Glide.....	1035
Spring Fork.....	792-793

**RIVET**

Brake/Clutch.....	291,292
List.....	1316

**ROCKER.....169-172**

Arm.....	172
Box/Kit.....	169-171
Clutch Kit.....	229-230
Cover(Chrome).....	169-171
Gasket.....	1308

**ROD**

Brake.....	235
Connecting.....	144,145,1261
Clutch.....	204
Shift.....	191,219

**ROLLER PIN LIST.....1316****ROLLER.....146****ROTOR**

Alternator.....	351,352,353,354
Brake.....	242,243,244,246,247,248
Cover.....	245
Kit.....	352-354
Shim.....	351

**S****SADDLEBAG.....475,480**

Filler Panel.....	4,9
Relocation Signal.....	475
Support Trim.....	475

**SCREW LIST.....1322****SEAL LIST.....1315,1316****SEALANT.....1271****SEAT**

Buddy.....	1253,1254
Hardware.....	474
Rigid.....	473

**SEAT CONTINUED**

Mounts.....	474,1241-1244,1245-1246,1254
Police.....	1249-1252
Rear Pad.....	1240
Rigid.....	1235,1246
Solo.....	482,1236-1239,1249-1254
Springs.....	1248

**SERVICE MANUAL.....1269****SHIFT.....218-220,222**

Arm.....	190-191
Brackets.....	218
Foot Control Kit.....	229
Lever/Arm.....	191,218
Linkage/Rod.....	219
Pawl Assembly.....	191
Pedal Pad.....	237
Peg.....	1061
Rocker.....	230
Rod.....	220
Shaft.....	190,452

**SHIM LIST.....1307****SHOCK.....299-301**

Lowering Kit.....	300
-------------------	-----

**SHOP SERVICE.....1260-1265****SHOW BIKE BOLT KIT.....413,1318****SIGNAL.....1155-1167****SIREN.....576****SISSY BAR.....286-287,1235****SISSY BAR/PAD.....1240****SKID PLATE.....305****SKULL STUFF.....1017-1022****SLIDER.....270-273****SOLENOID.....355,359****SNAP CAPS.....412,413,1319****SPACER LIST.....1320****SPARK PLUG.....334**

Cover.....	334
Helicoil Replacement.....	1264
Wire.....	336,337

**SPEEDOMETER.....410,411,423-428**

Cable.....	410
Digital.....	427,428
Drive Unit.....	411
Electronic.....	424,428
Lamp Socket.....	425
Mini.....	425-428
Mount.....	429
Reset Knob.....	425
Sensor/Sending.....	411,422

**SPOKE.....465-469****SPOKE WHEEL.....465-469,1218****SPOTLAMP.....1110-1115****SPRING FORK.....1219-1221**

Rebuild.....	1265
--------------	------

**SPROCKET**

Bolt Kit.....	207
Compensating.....	209
Motor.....	209
Rear.....	206
Shaft.....	147
Transmission.....	206

**STANDS.....301,1273-1274****STARTER.....355-356,359,360**

Cover.....	355
Drive.....	356,358
Housing.....	360
Relay.....	355,359
Repair.....	359
Ring Gear.....	357
Shaft.....	355,359

**STARTER CONTINUED**

Solenoid.....	350
<b>STATOR.....</b>	<b>357</b>
<b>STRUT.....</b>	<b>295</b>
<b>STUD LIST.....</b>	<b>1307</b>
<b>SWINGARM.....</b>	<b>304-307</b>
Rebuild.....	305
Wide Drive Kit.....	304
<b>SWITCH</b>	
Brake.....	256,264
Button.....	365
Flasher.....	364
Hi Lo Beam.....	1051
Hinge.....	362-363
Ignition.....	361-363,364,365
Neutral.....	364
Oil Pressure.....	364
Vacuum.....	364

**T**

<b>TACHOMETER.....</b>	<b>421,425,426,427,429</b>
<b>TAIL LAMP.....</b>	<b>1116-1138</b>
Assemblies.....	1116-1137
Bulb.....	1141
Connector.....	1141
Derby Mount.....	1127
Fender Mount.....	1117,1129,1131,1132
Gasket.....	1310
Lamp.....	1116-1137
Lens.....	1137-1139
License Bracket.....	1116,1124,1131,1137
Side Mount.....	1120-1128
Tombstone.....	1134,1135
Vintage.....	1132-1134,1135
Visor.....	1137,1138
Wiring.....	1128
<b>TAPPET.....</b>	<b>165,166,167</b>
<b>TERMINAL.....</b>	<b>361</b>
<b>THROTTLE.....</b>	<b>400</b>
Cable.....	404
By Wire.....	402,403
Internals.....	402,403
<b>TIMING</b>	
Fuel Injected.....	346
Plug.....	336
<b>TRANSMISSION.....</b>	<b>187-196</b>
Case.....	189
Conversion.....	187,196
Countershaft.....	190-191
Cover.....	194,195
Dipstick.....	196
Drain Plug.....	189,190
Door.....	189
Fill Plug.....	196
5 Speed Rebuild.....	1265
Gasket.....	193,1311
Internals.....	190,192
Kicker Conversion.....	196
Mainshaft.....	190-192
Mount Plate.....	188
Neutral Switch.....	364
Offset Plate.....	188
Oil Seal Kit.....	185
Pawl.....	191
Plug.....	189,190
Remanufacture Service.....	1265
Right Side Drive.....	185
Seal List.....	1215,1316
6 Speed.....	187,188
Sprocket.....	206

**TRANSMISSION CONTINUED**

Vent Canister.....	195
<b>TRIPLE TREE.....</b>	<b>260,265,267,269,280</b>
Glide.....	268
Raked.....	269
Spring Fork.....	1221
<b>TUBE (Tire).....</b>	<b>1217</b>
<b>TUNE UP.....</b>	<b>347</b>
<b>TURN SIGNAL.....</b>	<b>1155-1164</b>
Canceler.....	1166,1167
Equalizer.....	1167
Flasher.....	1166
Gasket.....	1165
Relocation.....	1162,1165
<b>TWIN CAM</b>	
Cam.....	156,157,158,159
Cam Chest.....	148
Cylinder.....	178-179
Dress Up Kit.....	173
Engine Upgrade.....	178
Flywheel.....	144
Gasket.....	184,185
Head.....	169
Oil Pump.....	148,149
Piston.....	183
Pushrod.....	161
Rocker Arm.....	172
Rocker Box.....	169
Tappet.....	165
Top End Kit.....	178
Valve.....	175-176

**V**

<b>V-ROD.....</b>	<b>225</b>
<b>VALVE.....</b>	<b>175</b>
Breather.....	149
Cover.....	169
Guide.....	177
Keepers.....	176
Relief.....	149
Seal.....	177
Seat Service.....	1264
Springs/Collar/Key.....	174,175,176
<b>VELOCITY STACK.....</b>	<b>381,387,399,400</b>
<b>VOLTAGE REGULATOR.....</b>	<b>348,349,352-354</b>

**W**

<b>WASHER LIST.....</b>	<b>1320,1322</b>
<b>WHEEL.....</b>	<b>465-471</b>
Assemblies.....	465-469,470
Axle.....	453-458,459,461
Bearing.....	460-461
Building and Truing.....	1265
Cast/Forged.....	470-471
Hub/Cap.....	471,473
Greaser.....	461
Rim.....	462
Seal/Race.....	460
Spacer.....	455,457
Spoke.....	464-465
Spool.....	1218
Truing/Build Service.....	1265
Tube.....	1217
<b>WIND DEFLECTOR.....</b>	<b>478</b>
<b>WINDSHIELD.....</b>	<b>476-477</b>
<b>WIRING</b>	
Clamp.....	1293
Connector.....	1290-1292
Dash.....	366
Deutsch Connector.....	1290,1292

**WIRING CONTINUED**

Diagnostic System.....	365
Grommets.....	367
Fuse.....	368,1296
Handlebar.....	1296
Harness.....	365,366
Ignition.....	366
Primary.....	367
Shrink Wrap.....	323
Spark Plug.....	336-337
Tail Lamp.....	1141,1193
Terminal/Connectors.....	368,1290-1292
Tie Strap.....	1296
Wire.....	367
Wire Loom Clip.....	689
<b>WRIST PIN.....</b>	<b>182,183</b>



# Short Block

**V-Twin™ 80" Short Blocks** are shipped fully assembled as shown. All 80" units feature an S&S Crankcase, Sifton Oil Pump/Breather assembly, stock stroke flywheel, Timken Bearings, stock cam properly installed with a matched pinion and cam gear with Torrington bearing. Assembly is supplied with a chrome nose cone cover and chrome lifter blocks are fitted with standard tappets.

VT No.	Fits
10-0007	1984-90 Evolution
10-0008	1992-99 Evolution



## Engine Mount Bolt



### Upper and Lower

VT No.	Years	Model	Type	Finish
9854-28	1984-99	FXST		Chrome
9855-28	1984-99	FXST		Zinc
9927-28	1984-99	FXST	Allen	
9927-28-P	1984-99	FXST	Allen	Polished

### Lower Only

9859-20	1989-99	FXR		Chrome
9928-20	1989-99	FXR	Allen	
9928-20-P	1989-99	FXR	Allen	Polished

### 1999-up Front Only

9937-20	1999-up	FXD	Allen	Chrome
9936-28	1999-up	FXD	Acorn	

### Lower Front

2116-15	2000-up	Softail	Allen	Chrome
2117-15	2000-up	Softail	Hex	Chrome
2118-15	2000-up	Softail	Hex	Zinc

### Transmission to Motor Mount TC-88, FXD

9935-8-P	1999-up	FXD	Allen	Polished
----------	---------	-----	-------	----------

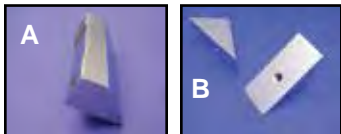

**Chrome Front Engine Bolt Mount Block.** Front engine mount bolts thread into regulator mount block.

### VT No. Type

31-0635	A
31-0739	B



**Engine Case Drain Plug**  
VT No. 2549-2



V-Twin Mfg. supplied components for every aftermarket motorcycle company who sprang up due to the shortage of Harley-Davidson motorcycles. Startups included:

- Big Dog (1994-2011)
- Excelsior-Henderson
- Ultra
- American Iron Horse (1995-2008)
- Confederate
- Gilroy Indian Co. (1999-2003)
- Orange County Choppers



## Case Bolt



**Engine Case Bolt Kit** includes the necessary hardware to bolt together the cases of the years listed. Available as OEM stock in chrome, cadmium plating or custom acorn in chrome.

Acorn	Chrome	Fits
9882-22	9883-20	1996-99 Evolution
9955-27	—	2000-up FLST, FXD, FXST



**Chrome Engine Case Allen Bolts** fasten engine case halves together.

VT No.	Year	Model
37-9191	1983-95	Big Twin Evo 1340
37-9360	1996-99	Big Twin Evo 1340

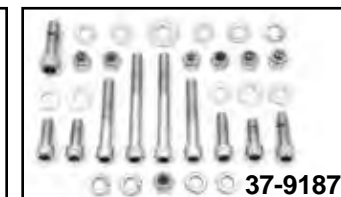
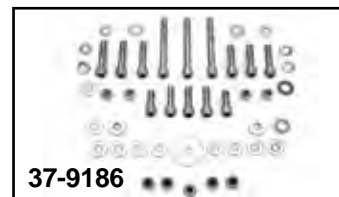
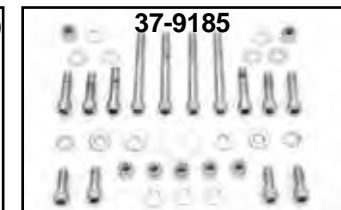

**Chrome Allen Screw Kit** connects engine mounts, front, top and rear to frame on models listed below.

VT No.	Fits
37-9180	1991-up Dynaglide
37-9185	1987-90 FXR
37-9186	1991-99 FXR
37-9187	1984-99 FXST, 1985 FXWG-FXE



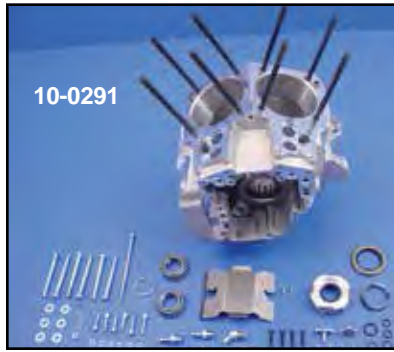

10-0291



10-0576

For TC-88 Models



# Case Set

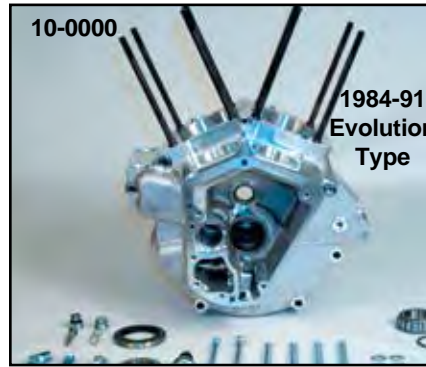

10-0000

1984-91 Evolution Type



## 124" Engine Upgrade Kit

**S&S 124" Twin Cam Hot Setup Kit** allows owners of 1999-up 96" Twin Cams to upgrade to 124" using the stock crankcases. Kits include 4 $\frac{5}{8}$ " flywheels, .640 gear drive cam set, 4 $\frac{1}{8}$ " bore cylinders, pushrods, roller rocker arms, 91cc cylinders heads (10.8:1 compression), electric compression releases and chrome rocker boxes. Available in natural.

**VT No. Fits**

**10-0494** 2006-up FXD, 2007-16 FLT

**Replacement Pistons and Rings** for S&S motors. Piston kits include rings, wrist pins and clips. Replacement ring sets are for two pistons.

Motor	Bore Size	Standard	.010	.020
111"	4 $\frac{1}{8}$ "		11-1561	11-1562
113"	4"	11-1410	11-1411	11-1412
124"	4 $\frac{1}{8}$ "			11-1558

**Replacement Ring Sets** for S&S Pistons Only.

Bore Size	Standard	.010	.020
4"	11-1300		
4 $\frac{1}{8}$ "		11-1401	11-1402



**Motor Plaques** measure 18" x 24" and are made of metal. **Motor Plaque Set** includes 9 plaques. VT No. 48-1811

**S&S Crankcase Sets** are shipped set up with Timken left side bearing and race assembly, seal and seal spacer, oil pump drive bushing, needle bearing and pinion race for right side, (pressed in and line honed) ready to assemble. Also included are cylinder studs, nickel plated case bolts, crankcase fittings and a timing and magnetic drain plug. Accepts wheels up to 8 $\frac{1}{2}$ " diameter. Note: Oil pump required for assembly.

VT No.	Year/Model	Bore	Oil Pump
10-0000	1984-91 V2 Type	Stock	12-8002
10-0005	1992-98 V2 Type	Stock	12-9975
10-0575	1992-99 V2w/EFI	Stock	12-9975
10-0576	2000-06 TC-88A	Stock	Stock
10-0291*	TC-88A/Evolution	Stock	Stock
10-0001	1984-91 V2 Type	3.878 (3 $\frac{5}{8}$ ")	12-8002
10-0011	1992-99 V2 Type	3.878 (3 $\frac{5}{8}$ ")	12-9975
10-0577	2000-06 TC-88A	4.00	Stock
10-0292*	TC-88A/Evolution	4.00	Stock

\*Note: Features Evolution Engine Mounts.

1 cubic inch = 16.38 cc

1 cubic inch = .0163871 liter

**Cubic Inch =  $\pi r^2 \times \text{Stroke}$**

**r = 1/2 of Bore**

		CUBIC INCH CHART								
		Stock 74				Stock 80				
B O R E	STROKE	3 $\frac{1}{2}$ "	3 $\frac{13}{16}$ "	3.968"	4 $\frac{1}{4}$ "	4 $\frac{1}{2}$ "	4 $\frac{5}{8}$ "	4 $\frac{3}{4}$ "	5.00"	
				74"	80"					
	2 $\frac{3}{4}$ "		45"							
	3 $\frac{5}{16}$ "	61"								
	3 $\frac{7}{16}$ "	64.8"		73.7"	78.7"	83.4"	85.7"	88.0"	92.8"	
	3 $\frac{1}{2}$ "	67.2"		76.3"	81.6"	86.6"	89.0"	91.4"	96.1"	
	3 $\frac{5}{8}$ "	72.1"		81.7"	87.4"	92.9"	95.5"	99.0"	103.2"	
	3 $\frac{11}{16}$ "	74.6"		84.7"	90.7"	96.1"	98.8"	101.5"	106.8"	
	3 $\frac{3}{4}$ "	79.9"		90.6"	97.0"	102.8"	103.7"	108.9"	114.2"	
	3 $\frac{7}{8}$ "	82.3"		93.4"	100.1"	100"	108.9"	111.9"	117.8"	
4.00"	87.9"		99.7"	106.8"	113.0"	116.1"	119.3"	125.6"		
4 $\frac{1}{8}$ "	93.4"		106.0"	113.5"	120.2"	123.5"	126.9"	133.6"		
4 $\frac{1}{4}$ "	99.2"		112.6"	120.5"	127.6"	131.1"	134.7"	141.8"		



# Flywheel



**Complete Stock Stroke Flywheel Assembly** is shipped assembled and trued with shafts. VT No. 10-1091 requires the use of 1987-up type Pinion Shaft Bearing assembly and VT No. 12-0967 late bearing retainer.



**4 5/8" Stroke S&S Flywheel Assembly** fits 1984-99 Big Twin. Features heavy duty rods, pinion and sprocket shaft. Assembled by S&S. Ready to install. Can be used with our 11-0064 3 5/8" Evolution S&S cylinder kit for 96 cubic inch or with 89" piston kits and stock type cylinders which yields 89 cubic inches. 1990-99 requires 10-2560 pinion conversion package for carburetor models only.  
**VT No. 10-0063**

VT No.	OEM	Fits	Note	Brand
<b>For Big Twin 80"</b>				
10-1091	23906-78G	1984-90 80"	3,4	VT
10-0062	23906-90A	1991-92 Evolution	5	OE
10-1042**	23906-93B	1993-99 Evolution	3, 4	VT
10-0374	—	2007-up FXD	5	S&S
		2007-16 FLT		

**Notes:**  
 1-Special 80" flywheel assembly used for alternator-generator case sets only. Feature late type sprocket shaft and early style pinion shaft.  
 2-Features replaceable pinion and sprocket shafts.  
 3-Features replaceable pinion and sprocket shafts and narrow sprocket side flywheel  
 4 Require use of 1987-up type pinon shaft bearing and retaining ring.  
 5-One piece type flywheel with non-removable shafts.

### Flywheel Assembly for Twin Cam.

VT No.	OEM	Year	Model
10-1290	23729-07	2007-up	FXD



**S&S 89" Evolution Stroker Replacement Piston Sets** for 4 5/8" flywheels. 9.25:1 compression with rings.  
**VT No. Size**  
**11-0475** Standard  
**11-0479** .030

# Stroker Flywheel for TC-88



**Stroker Flywheel Assemblies** are 4 3/8" stroke when combined with Big Bore Cylinders. Fits 2006 FXD.

Bore	Cubic Inch
3 7/8	103"
4.00	110"
4.06	113"

**VT No. 10-1522**

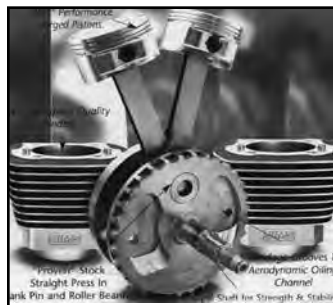

**Jims 116" Stroker Kits** with natural finish cylinders. Each kit includes a balanced and trued flywheel assembly with integral pinion shaft, sprocket shaft and crank pin for maximum stability and resistance to flywheel distortion. Each kit is press fit with Jims H-Beam forged connecting rods and prebalanced with Arias pistons. Fits all 1999-06 carbureted Twin Cam A motors only. 4 5/8" stroke and a 4" bore.  
**VT No. 11-2053**



**Timken Bearing Sleeve** will convert 2003 and later TC-88 models from a roller bearing to a Timken tapered bearing. Bearing sold separately.

**VT No. 10-0856**



**S&S TC-88 Stroker Flywheel Assemblies** for all 1999-02 TC-88 models. Feature 1.500 crank pin and replaceable race bearing. Fits all models with non-balancer Twin Cam engines. Pistons not included.

VT No.	Size	Stroke
10-1094	106"	4 1/2"



**S&S Flywheel Hot Setup** includes 4-5/8" assembled flywheels, 561 cam, spring kit, pushrods and Super E carburetor kit. Yields 89 cubic inches with 9-1/4:1 compression ratio. Order piston set separately.

VT No.	Fit	Year
11-1505	89" Evo	1993-1998





# Rod Assembly



10-1607



10-1607

**Connecting Rod Set** crank pin, two solid caps, and bearings. The upper bushing is installed. Wrist pin bushings installed fits for twin cam Big Twin models. Set is crafted with high precision. Fits 1999-up.  
**VT No. 10-1607**



10-1205

**Rod Set and Crank Pin Kit** for replacements in 1999-2006 models. Rods include wrist pin bushings.

- VT No. Item**
- 10-1205** Bearing Set
- 10-1607** Rod Set
- 10-8755** Crank Pin, STD
- 10-8756** Crank Pin, .001
- 10-8757** Crank Pin, .002
- 10-0921** Pin Plugs
- 10-2586** Bronze Shim Set



10-8755

**\*Note:** Press required for installation



"H-Beam"



**Sifton™ Big Twin Rod Complete Assembly** features forged and machined H-Beam design of certified 4340 steel with multi staged heat treatment and are fitted with Torrington rollers with extruded alloy cages and a Sifton™ pin and matching nuts. Unfinished type requires honing of upper and lower bushings. Rods are 7.440" center to center and will accommodate up to 5" stroke.

- VT No. Year Item**
- 10-0272** 1981-99 Assembly
- 10-0274** Unfinished Rods Only



10-0268

**S&S Genuine Rods** are heavy duty replacement rod sets which include wrist pin bushings, rod races, matched rods, pins, rollers, cages and nuts for stock or stroker use. Fits 1984-99 Big Twin Evolution.

**VT No. 10-0268\***

**\*Note:** Have 16 bearing steel cages.



**V-Twin™ Replica Stock Replacement Rod Sets** include new rods, crank pin, nuts, cages and standard rollers fitted and assembled. Piston pin bushings are installed. Replaces 24281-83. Fits 1984-99 Evolution 1340cc.  
**VT No. 10-0188**



10-2571

**L1981-86 Big Twin 2-Hole Crank Pin Kit** includes 2-hole crank pin, rod races, standard rod rollers, and retainers.  
**VT No. 10-2571**



**Sifton Steel Rod Cage Set** includes 4 cages, 24366-51 and standard Torrington Roller Set for 1936-98 Big Twin. Replaces 42385-40.  
**VT No. 10-2522**



**Rod Bearing Sets With Set of 3 Cages** for Big Twins fitted with standard size Torrington rollers for connecting rods. The

cage material is noted.

VT No.	OEM	Cage	Year	Brand
<b>12-2556</b>	24366-51	Steel	1936-86	S&S
<b>10-2556</b>	24346-87A	Steel	1987-99	Sifton



**Connecting Rod Race Sets** made from 52100 steel use and hardened. Fits 1936-99 Big Twin.

VT No.	Brand	Size
<b>10-0138</b>	Replica	STD
<b>10-0828</b>	Replica	.001 O/S
<b>10-0826</b>	Replica	.002 O/S
<b>10-0830</b>	Replica	.005 O/S
<b>10-0829</b>	Replica	.010 O/S
<b>10-0823</b>	Replica	.002 O/S
<b>10-0809</b>	Jims	STD

## Crank Pin



**Big Twin Crank Pin Nut Sets.**

Eastern	Jims	OEM	Year
<b>12-0559</b>	<b>12-0606</b>	23969-83	L1983-99

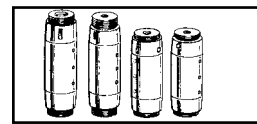
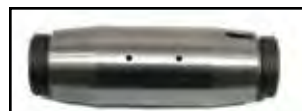

**80" Crank Pins** available from Jims, Eastern, and V-Twin. Pins are made of 8620 steel with .062 heat treated penetration. O.S. Pins are oversize on bearing diameter. 180° oil location pins have more complete bearing lubrication.

Years	OEM	Jims 3 Hole	Eastern 3-Hole	V-Twin 2-Hole
L1981-99	23961-80A	<b>10-8357</b>	<b>10-0130</b>	<b>10-1211</b>
L1981-99	.001 O/S	<b>10-0353</b>	—	—
L1981-99	.002 O/S	<b>10-8358</b>	—	—
L1981-99	180° Oiling	<b>10-0354</b>	—	—





# Crank Shaft Component

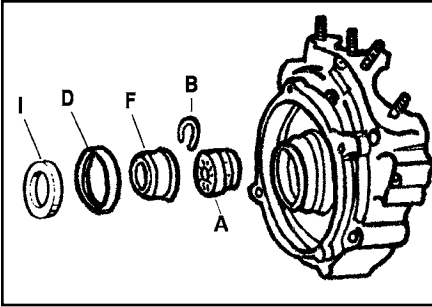

Left Crankcase Bearing and Spacers for 1958-99 Big Twin models.

VT No.	OEM	Description
12-0309	9028	(A) 1969-02 Left crankcase bearing
12-0947	11160	(B) 1985-up Left bearing retainer ring
14-0108	12026B	(D) 1970-99 Crankcase oil seal
14-0810	12068	(D) 2000-up Crankcase oil seal
10-0427	24002-70	(F) 1970-99 Sprocket shaft spacer
12-0813	24039-01A	(F) 2000-02 Sprocket shaft spacer
12-0814	24038-03	(F) 2003-up Sprocket shaft spacer
10-0442	24032-70	(I) 1970-up .060 Sprocket shaft spacer
10-0443	24033-70	(I) 1970-98 .090 Sprocket shaft spacer
10-0444	24034-70	(I) 1970-98 .120 Sprocket shaft spacer
10-0445	24035-70	(I) 1970-98 .150 Sprocket shaft spacer
10-0446	24036-70	(I) 1970-98 .180 Sprocket shaft spacer
10-0447	24037-70	(I) 1970-98 .210 Sprocket shaft spacer
10-0428	24038-70	(I) Same as above, Assortment
10-1212	35850-84	(I) 1970-98 .010 Sprocket shaft spacer
10-1213	35851-84	(I) 1970-98 .020 Sprocket shaft spacer
10-1214	35852-84	(I) 1970-98 .030 Sprocket shaft spacer
10-0461	35853-96	(I) 1970-98 .055 Sprocket shaft spacer
10-0466	8972	(I) 2000-up Thrust washer

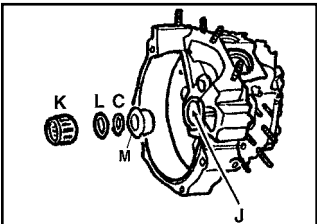

Right Crankcase Bearing and Spacers for 1958-99 Big Twin models.

VT No.	OEM	Description
12-0904	11007	(C) 1958-86 Right bearing retainer ring
12-0946	11177	(C) 1987-92 Right bearing retainer ring
12-0967	11177A	(C) 1993-99 Right bearing retainer ring
12-0250	24608-54	(J) Screw right case bushing
10-2533	24650-58	(K) 1958-86 Right bearing assembly, Standard
10-1274	24626-87A	(K) 1987-99 Right bearing assembly, white/gray
10-1275	24628-87A	(K) 1987-99 Right bearing assembly, green
10-1276	24641-87A	(K) 1987-99 Right bearing assembly red
10-1277	24643-87A	(K) 1987-99 Right bearing assembly, blue
10-1157	24692-58	(L) 1958-86 Right bearing washer
10-1278	23928-87A	(M) 1987-99 Pinion Shaft Race

Wrist Pin Bushings are available in bronze replica type or Sifton Ampco 45 for all 1936-up Twins. Replica type sold in pairs. Sifton type sold each.

Size	1936-99 Big Twin	1999-up TC-88	Type
STD	10-0756	—	Replica
STD	10-0765	—	Sifton
.002	10-0757	10-8557	Replica
.005	10-0758	—	Replica
.010	10-0759	—	Replica

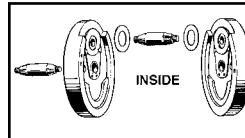

1971-99 Big Twin Bronze Inside Crank Pin Flywheel Washers sold in pairs.

VT No.	OEM	Size
10-1150	6506	Standard
10-1149	6506B	.005 Oversize



Sifton Cam Bushing Kits includes cam and gear shaft bushings/bearings with lock pins and thrust plate.

VT No.	Fits
10-8272	1993-99 Big Twin
10-8260	1973-92 Big Twin



Motor Shaft Spacer features built in seal flange to give added support for alternator rotor.  
VT No. 10-0948

## TORRINGTON®

Connecting Rod Roller Sets for Big Twins. Each set supplies enough rollers for application only for use in alloy cages.

### 1973-86 Big Twin

Size	Part Number
Standard	10-0144
.0002 oversize	10-0145
.0004 oversize	10-0146
.0006 oversize	10-0147
.0008 oversize	10-0148



### Bulk Pack Rollers (100 Quantity)

#### 1973-86 Big Twin

Size	Long	Short	OEM
.0002		12-4554	9442A
.0004		12-4555	9443A
.0006	12-4548		9182
.0008	12-4549		9183
.001	12-4558		9446A
.003	12-4552		



**Left Crankcase Bearing by Timken.** Factory assembled with correct spacer for proper end play.

Timken	VT No.	OEM	Fits
12-0309	12-0428	9028	1969-02
	12-0768	24605-07	2000-up

**Crankcase Bearing and Race Only.** Two Required. Order snap ring and the spacer separately. 1969-up, OEM 9045.

For more applications see [www.vtwmfg.com](http://www.vtwmfg.com). **VT No. 12-0345**

**Timken Bearing Spacer Shims** available in 5 packs.

**1969-up Big Twin**

VT No.	OEM	Size	VT No.	OEM	Size
10-8523	9110	.0895-.0905	10-8506	9126	.1045-.1035
10-8500	9120	.0915-.0925	10-8507	9127	.1065-.1055
10-8501	9121	.0945-.0935	10-8508	9128	.1085-.1075
10-8502	9122	.0965-.0955	10-8509	9129	.1105-.1095
10-8503	9123	.0985-.0975	10-8510	9130	.1125-.1115
10-8504	9124	.1005-.0995	10-8522	9131	.1145-.1135
10-8505	9125	.1025-.1015	10-8511	9132	.1165-.1155
			10-8512	9133	.1185-.1175
			10-8513	9134	.1205-.1195

# Sprocket Shaft



**Sprocket Shafts** for L1981-86 Big Twins. Replaces OEM# 23909-80.  
**Jims Eastern Replica Length**  
**10-8318 10-0416 10-0440** Stock



**Sprocket Shaft Spacer and Seal Kit** for 1970-99 Big Twin.  
**VT No. 10-8284**

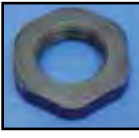

**Pinion Shaft Nut, Taper End.**  
**Eastern Jims OEM Fits**  
**12-0517 12-0609 24016-80 L1981-89**



**Pinion Keys** available in ten packs.

VT No.	OEM	Type	Fits	Style
12-0202	23985-54	Gear Side	1987-90	Semi Circle
12-0205	26348-15	Gear Side	1975-86	Semi Circle
12-0209	11218	Taper Side	1981-92	Semi Circle
12-0215	11219	Gear Side	1991-99	T-Key

# Pinion Shaft



**Pinion Side Case Race** machined and ground to factory specifications.

Sifton	Replica	OEM	Size	Year/Model
10-0296	10-0278*	24599-58A	Standard	1958-92
—	10-0797	24599-58B	Standard	1993-99
Jims	Eastern			
10-0245	10-0214	24599-58A	Standard	1958-92
10-0248	10-0217	—	.010	1958-92
—	10-0231	24599-58B	Standard	1993-99
10-0250*	10-0232	24599-58B	.002	1993-99
—	10-0233	24599-58B	.005	1993-99

**\*Note:** 1993-98 Pinion Bearing Race features 360° oiling groove. Can be used on 1958-87 models with later Torrington roller assembly VT No. 10-1274 standard through 10-1277.

**Pinion Shaft Gears.** Orange is largest, black is the smallest.

Size	1977-89	1990-92	1993-99
	OHV BT	Evo BT	Evolution Big Twin
Orange	12-9938	12-1200	—
White	12-9943	—	—
Yellow	12-9945	—	—
Red	12-9940	—	12-1210
Blue	12-9941	—	—
Green	12-9942	—	—
Black	12-9939	12-1206	—



**Sifton 1990-99 Pinion Shaft Conversion Package Kit** is for those installations of multiple piece aftermarket flywheels in 1990-99 engines, or replacement of 1990 and later assemblage with stock 1981-89 parts. Kit includes 1977-89 red pinion gear, 1954-89 pinion shaft oil pump drive gear, 1954-89 pinion shaft gear spacer and 1954-89 pinion shaft gear nut.

VT No.	Brand	Year
10-2560	S&S	1990-99
10-2585	Sifton	1977-99



**Pinion Shaft** for Big Twin.

Year	OEM	Jims	Eastern	Replica
1987-89	24006-87	10-8329	10-0432	10-0889



**1958-86 Pinion Bearing Set** for right side includes rollers, cages, washers and snap rings.  
**VT No. 10-2533**

**1987-99 Pinion Gear Side Bearing Set** for Big Twin. Includes cages.

VT No.	OEM	Color
10-1274	24626-87A	White/Grey
10-1275	24628-87A	Green
10-1276	24641-87A	Red
10-1277	24643-87A	Blue
10-1278	23928-87A	Pinion Shaft Race

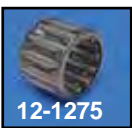

# Case Rollers TORRINGTON®

**1958-86 Big Twin Right Side Case Rollers.**

Size	28-Piece	100 Pack	OEM
Standard	10-0319		9220
.0002	10-0320	12-4511	9221
.0003	10-0339		9218
.0004	10-0321	12-4512	9222
.0006	10-0322		9223
.0008	10-0323	12-4514	9224
.001	10-0324		9225
.002	10-0325		



# 1999-up Cam Shaft Component for TC-88

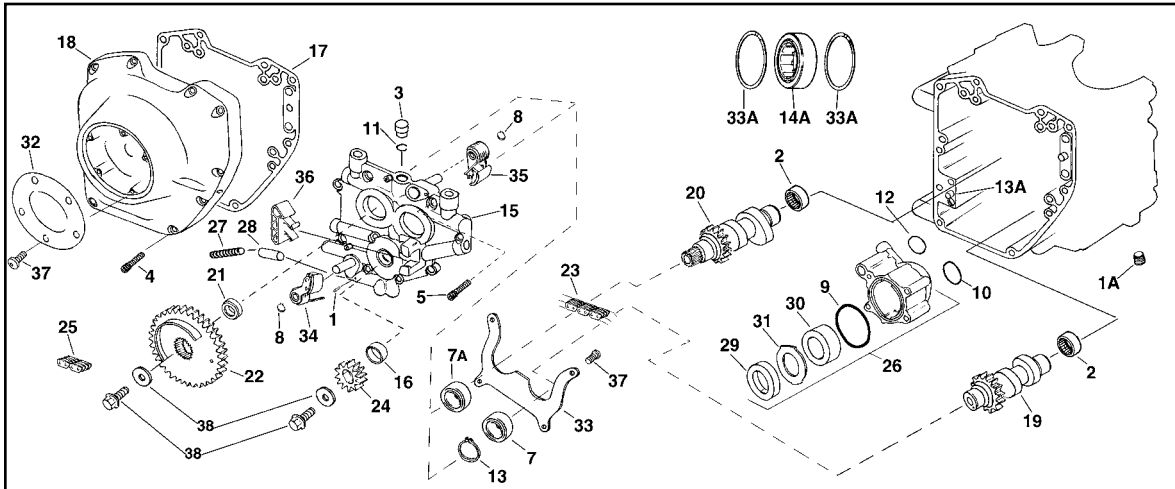

## Cam Shaft Components for TC-88 models, 1999-up unless noted.

VT No.	OEM	#	Item
12-1178	601	1	Roll Pin
12-0750	9198	2	Left Side Cam Shaft Bearing 1999-05 FXD, 1999-06 FXST, FLST, FLT
12-0765	9215	2	As Above 2006-up FXST, FLST, FLT
9946-20	4740A	4	Allen Screw Set, As Above
37-1002	4741A	5	Screw, As Above
12-0751	8990A	7	Ball Bearing 1999-05 FXD, 99-06 FXST, FLST, FLT
12-0762	8983	7A	Bearing 1999-05, As Above
12-0905	11031	8	Retaining Ring 1999-05, As Above
14-0814	11286	9	O-Ring 1999-05, As Above
14-0803	11293	10	O-Ring, As Above
14-0819	11298	11	O-Ring, Viton 1999-05 As Above
12-0753	11494	13	Retaining Ring 1999-05 As Above
12-0761	16589-99	13A	Dowel Ring, 1999-up FXST, FLST, FXD 1999-16 FLT
10-0587	14761-00		Pad Set, TC-88B, 2000-up FXST, FLST
15-1214	17045-99	14	Cam Service Gasket Kit, 1999-up FXST, FLST, FXD, 1999-16 FLT
13-0233	18223-98		Performance Valve Spring Set 1999-04 FXST, FXD
12-0754	24623-99C	14A	Right Side Main Bearing 1999-06 FXST, FLST, FLT, 1999-05 FXD
12-0768	24605-07	14A	As Above 2007-up FXST, FLST, FLT, 2006-up FXD
15-1198	25244-99A	17	Cam Cover Gasket, 1999-up FXST, FLST, FXD, 1999-16 FLT
10-0813	25247-99	18	Chrome Cam Cover, 1999-00 FXST, FLST, FXD, FLT
42-0702	25369-01A		Chrome Cam Cover, 2001-up FXST, FLST FXD, 2001-16 FLT
10-0904	25674-99	21	Cam Drive Spacer, .360 1999-05 FXD, 1999-06 FXST, FLST, FLT
10-0905	25675-99	21	Cam Drive Spacer, .365, As Above

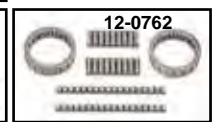

10-0913	25738-06	21	Cam Drive Spacer .150, 2007-up FXST, FLST, 2007-16 FLT, 2006-up FXD
10-0481	25607-99	23	Secondary Cam Drive Chain 99-05
10-0915	25683-06	23	Secondary Cam Drive Chain 2007-up FXST, FLST, 2007-16 FLT, 2006-up FXD
10-0483	25610-99	25	Primary Cam Drive Chain, 1999-05 FXD, 1999-06 FLT, FXST, FLST
10-0917	25675-06	25	As Above 2007-up FXST, FLST, 2006-up FXD, 2002-16 FLT
12-9902	26035-99	26	Oil Pump Assembly Cpt 1999-05 FXD, 1999-06 FXST, FLST, FLT
12-9990	26037-06	26	As Above 2006-up FXD, 2007-up FXST, FLST, 2007-16 FLT
12-1418	26400-82B	28	Oil Pump Relief Valve
42-0119	32679-99	32	Sensor Cover, Chrome
12-0760	35115-99	33A	Retaining Ring 1999-01
10-0485	39954-99	34	Primary Cam Drive Chain Tensioner 1999-06 FXST-FLST, FLT, 1999-05 FXD
10-0918	39968-06	34	As Above 2007-up FXST-FLST, 2006-up FXD, 2007-16 FLT
10-0486	39964-99A	35	2nd Cam Drive Chain Tensioner L1999-06 FXST, FLST, FLT, BT except 2006-05 FXD
10-0919	39969-06	35	As Above 2007-up FXST-FLST, 2007-16 FLT, 2006-up FXD
10-0924		34& 35	Cam Chain Tensioner Set 2007-up FXST, FLST, 2006-up FXD, 2007-16 FLT
10-0487	39965-99	36	Chain Guide 1999-05 FXD, 1999-06 FXST, FLST, FLT
9954-5	68042-99	37	Sensor Cover Screw Set



**V-Twin Inner Cam Bearing Tool** safely installs the inner cam bearings to the proper depth in the case without damaging bearings.

VT No. 16-1390



**Inner Cam Bearing Remover Tool** allows removal of needle bearing and will also keep needles from falling into engine. For use on 2006-up FXD, 2007-up FXST, FLST, 2007-16 FLT.

VT No. 16-1351



**Chrome Crank Sensor Cover** Includes mount screw. 1999-up FXD-FLT. VT No. 42-0953



**Crank Sensor** fits 1999-up FXST-FLST, FXD, 1999-16 FLT. VT No. 32-0988



**Twin Cam Heavy Duty Billet Cam Plate** features enlarged oil passages for improved oil flow and hard anodized finish. The billet aluminum and anodized finish increases the strength of plate over stock plate and allows the plate to hold tolerances under high temperatures. Use with gear drive cams.

VT No. Item

43-1059 1999-06 FXST, FLST, FLT; 1999-05 FXD

43-1060 2007-up FXST, FLST, 2007-16 FLT; 2006-up FXD

**Chain Tensioner Spacer Kit.**

VT No. 10-7001





# Oil Pump for TC-88



**TC-88 Oil Pump Alignment Tool.** This tapered tool threads into the oil pump and perfectly aligns the pump to the cam plate. Use on all TC88 engines. Fits 1999-up FXST-FLST-FXD, 1999-16 FLT. **VT No. 16-0998**



**E.R.T. Products SP-TC "Superpump-Kit"** for all 1999 and up "Twin Cam" engines. This color coded 3 spring kit ensures that your engine maintains the factory recommended oil pressure of at least 10 p. s. i. @ idle and up to 38 p. s. i. @ road speed with a warm engine. Each spring is individually installed in the pressure relief valve of the cam support plate. To simplify the installation of the SP-TC "Superpump-Kit" we recommend the TC-EZ installation tool! By using this tool VT No. 16-0300 you will not have to remove the cam support plate from the engine to increase your oil pressure. Each kit includes 3 separate 1/8" split pins.  
**VT No. Item**  
**13-0097** Spring Kit  
**16-0300** Spring Alignment/Installation Tool



**TC-88 Super Pump** by Sifton utilizes an oversized highly efficient Geo Rotor design. Provides a 40% increase in pump volume and a 60% more scavenging volume. This high volume pump bolts into the stock location and includes O-Rings and mounting hardware.  
**VT No. Fits**  
**12-9902** 1999-05 FXD, 1999-06 FXST FLST, FLT  
**12-9990** 2006-up FXD 2007-up FXST, FLST, 2007-16 FLT  
**12-0058** 2007-up FXST, 2006-up FXD 2007-16 FLT



**TC-88 "A" Crankcase Breather Valve** features a machined Billet aluminum body which contains four steel reed valves. Valve body slides over pinion shaft and fits inside pinion bearing bore and will allow air and oil mist to escape from the crankcase but will not allow them to re-enter. Fits TC-88A only.  
**VT No. Fits**  
**12-2070** 1999-02  
**12-2071** 2003-up FXST, FLST, FXD 2003-16 FLT



**TC-88 Oil Pressure ByPass Shim.** This machined shim assures proper spring pre load improving oil pressure and volume. its 1999-up FXST-FLST-FXD, 1999-16 FLT.  
**VT No. Unit of Measure**  
**12-0108** 5 Pack  
**12-0141** Each



**TC-88 Oil Pump and Cam Plate Saver.** These handy screens are placed into scavenger ports on the oil pump to prevent foreign particles from being drawn up into georotor. Installation tool is included. Fits 1999-up FXST-FLST-FXD, 1999-16 FLT. **VT No. 12-0130**

## Oil Pump Fitting



**Oil Pump Fitting Kit** for Big Twin models.  
**VT No. Year Type**  
**40-0562** 1984-91 Stock  
**40-0563** 1970-91 Custom

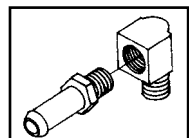

**Chrome Oil Pump Fittings** for 1968-99 Big Twin, 5 pack or four piece kit.  
**VT No. OEM Type**  
**12-1416** 26338-68 90° Elbow  
**40-0566** 63533-41 Nipple for 3/8" hose  
**40-0574** Kit 90° And Nipple



**Chrome Oil Line Fitting Set** will allow use of 3/8" braided steel lines. Built in compression fitting so no need for clamps. Reusable three piece set.  
**VT No. Thread Fits**  
**40-0575** 1/2" NPT TC-88  
**40-0583** 1/8" NPT Early  
**40-0584** 1/4" NPT TC-88



**Chrome Tight Spot Oil Pump Fitting Set** features a 5/16" allen socket for easy installation or removal. Includes 1/8" NPT nipples.  
**VT No. 40-0577**



**Oil Fittings** for Big Twin models.  
**VT No. OEM Type**  
**12-1412** 63533-65 Oiler Return  
**40-9982** 63541-70 Oiler Tee, Rear Chain



# Big Twin Oil Pump Assembly

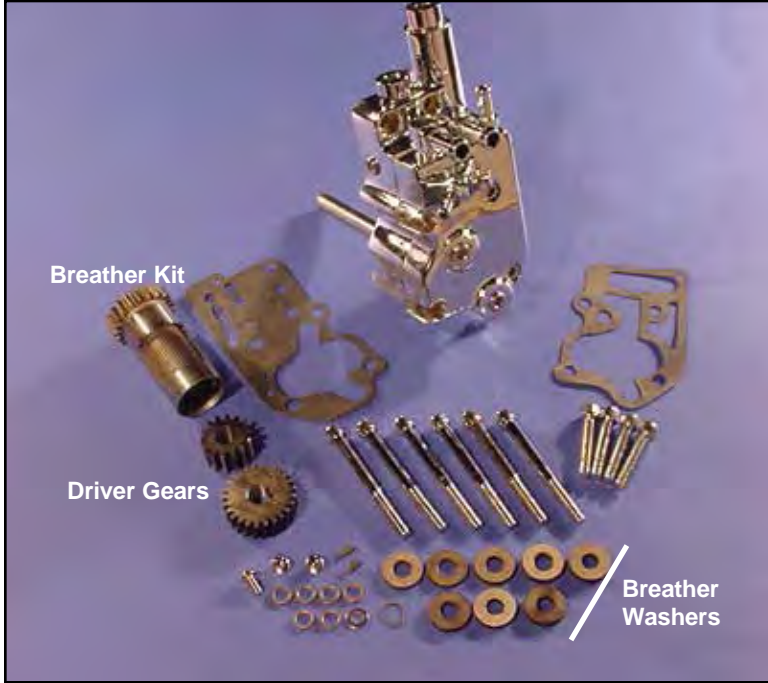

Sifton™ Oil Pump Assembly features improved oil pump pressure regulation that will ensure correct oiling to all areas of Big Twin engines. This pump kit includes all necessary fittings, snap rings, keys, gaskets and mounting bolts. Can be used on either chain drive or belt drive models.

Pump	Pump W/Breather	Years	Finish
12-9971	12-9802	1984-91	Polish
12-9972	12-9803	1984-91	Chrome
12-9975	12-9804	1992-99	Polish
12-9976	12-9805	1992-99	Chrome
15-0657	Gasket	1973-91	Mylar
15-0658	Gasket	1973-91	Paper
15-0362	Gasket	1992-99	Mylar
15-0363	Gasket	1992-99	Paper



## COLONY

Oil Pump Mount Kits for Big Twin.

VT No.	Years	Type
8744-12*	1978-91	Chrome, Stock
9787-12*	1978-91	Zinc, Stock
8747-12	1978-91	Allen
7827-12*	1978-91	Chrome Acorn
9763-16*	1992-99	Acorn Style
37-9000	1992-99	Chrome Acorn
37-9001	1992-99	Chrome Allen

\*Note: Includes studs where required.



**Sifton Big Twin Oil Pump Drive Shaft Kit** includes 3 keys, shaft gear, bushing and snap ring. Fits 1973-99 Big Twin.  
VT No. 12-0810

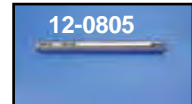
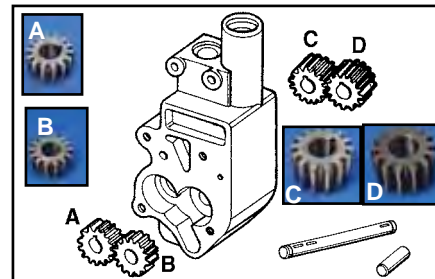
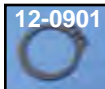

**Oil Pump Drive Shafts** fit 1970-99 Big Twin, replaces 26346-70.  
VT No. 12-0805

**Big Twin Oil Pump Gears** fit 1968-99 stock type and some aftermarket units. Available in V-Twin Mfg. or Jims brand.

VT No.	Jims	#	OEM	Type
12-0166	12-1434	C	26315-68A	Return Drive
12-1420	12-1435	D	26317-68A	Return Idler
12-0174	12-1436	B	26326-62A	Feed Idler
12-0183	12-1437	A	26328-74	Feed Drive



**Motor Shop Oil.** All are sold in case of six in quart size bottles.

VT No.	Type	Weight
41-0991	SynGold	20w50w
41-0992	Heavy Duty	60w
41-0993	Synthetic Gear Lube	Transmission/Primary
41-0994	Synthetic Clean	20w50w
41-0995	Heavy Duty	20w50w
41-0996	Heavy Duty/Synthetic	50w

**Chain Oil Adjuster Screws** sold each.

VT No.	OEM	Fits	Head
12-2523	63610-70	1970-99 FLH	Slot

**Oil Pump Seals.**

James	GB No.	OEM	Fits
14-0623	14-0114	26227-58	1968-99 Big Twin

**Oil Pump Snap Rings.**

VT No.	OEM	Fits
12-0901	11002	1970-up Big Twin





# Oil Pump



12-6208



12-0859



**Sifton Oil Pump** features geo-rotor compact cad/cam design, modular billet aluminum construction, superior scavenging, increased feed flow rate which eliminates wet-sumping in crankcase. Fits 1992-99 Evolution.

- VT No. Item**  
**12-0859** Pump  
**15-0549** Gasket Kit

## S&S HVHP Oil Pump

### HVHP Pump Only

VT No.	Type	Year
12-6209	Standard Cover	1992-99
12-6208	Universal Cover	1992-99
12-6214	Universal Cover	1984-91
HVHP Pump Kits		
12-6307	Universal Cover	1984-91

### S&S High Volume High Pressure Oil Pumps

- Feature a new tooth profile with fewer but larger teeth that provide greater oil volume for both supply and return sides of the pump.
- Supply gear is 9% wider than stock type oil pumps to give the HVHP pump more oil capacity.
- Return gears are 28% wider than stock type pumps to insure that the additional volume of oil supplied to the engine is scavenged and returned to the oil tank. In spite of wider supply and return gears the HVHP pump is no thicker than stock type pump and uses the stock type oil pump drive shaft.
- The standard style cover has feed and return holes in stock 1992-99 locations. Universal cover has a number of oil feed and return options allowing maximum flexibility for customized installations.
- Both types are available as oil pump assembly only or as a complete pump kit that includes pump, drive gear, pinion gear, breather gear and shim kit.



12-8002



12-8008



Gasket and Master Rebuild Kit

**S&S Oil Pump Gasket and Master Rebuild Kits** are available with paper or mylar gaskets. Gasket kits include inner and outer gaskets, drive shaft key and snap ring. Master rebuild kits include seal, snap rings, springs, ball, inner and outer gasket, O-rings, and keys.

**S&S Complete Oil Pump Assemblies** with billet style bodies. Include all internal gears and shafts for years listed. Also available as complete kits that include drive shaft gear, pinion shaft gear and breather gear kit.

### Billet Oil Pumps Assemblies

VT No.	Years
12-8002	1973-1991 Big Twin
12-8003	1992-1999 Big Twin

### Oil Pump Kits with Breather Assembly

12-8008	1973-1991 Big Twin
12-8009	1992-1999 Big Twin

Gasket Kit Only	Master Rebuild Kit	Type	Year
15-0657	15-0361	Paper	1936-91 Big Twin
15-0658	—	Paper	1936-91 Big Twin
15-0362	15-0364	Mylar	1992-99 Big Twin
15-0363	—	Paper	1992-99 Big Twin
15-1269	—	Metal	All HVHP Pumps





# Breather Gear



**Sifton™ Breather Gear Kit** is constructed of precision ground steel with screen installed. 8 piece steel thrust washer set included. Fits 1978-85 BT.

**VT No. 12-1540**



**S&S Reed Breather** features three steel reeds that are normally in the closed position. The downward cylinder motion increases crankcase pressure to open the reeds. On the upward stroke a vacuum is created. Can be used in Shovel motors with open primary or sealed primary not connected to the oil scavenge system. Replaces stock breather on 1991-99 Evolution motors.

pressure to open the reeds. On the upward stroke a vacuum is created. Can be used in Shovel motors with open primary or sealed primary not connected to the oil scavenge system. Replaces stock breather on 1991-99 Evolution motors.

**VT No. Size**  
**12-1949** Stock  
**12-1950** .030 Oversize

**Sifton Air Ramp** fits S&S/Sifton Breather Gear on 1936-99 models to remove more air and oil from crankcase. Requires removal of screen for installation. Gear not included.  
**VT No. 12-1945**

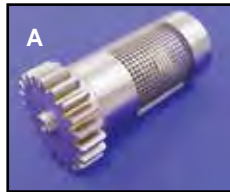

**A-Big Twin Steel Breather Valve** is a machined breather valve and gear. Designed to replace the stock steel or plastic units.

Order 8-piece thrust washers separately. Available in stock duration only with either standard or +.030 oversize outside dimension.

VT No.	Years	Size	Brand
<b>12-9906</b>	1978-99	Standard	S&S
<b>12-1537</b>	1978-99	Standard	Sifton
<b>12-9957</b>	1978-99	+.030	S&S
<b>12-9909</b>	All	Washer Set	S&S
<b>12-1510</b>	All	Washer Set	Sifton



Installed



12-1945



**B 12-1531**



**C 12-1510**

**B-Stock Plastic Breather Valves.**

**VT No. OEM Year**

**12-1531** 25310-82A L1977-99

**12-1953** As Above .005 Oversize

**C-Thrust Washer Set, Breather Valve** for 1979-99 Big Twin includes one of each size as noted.

**VT No. Fits Set**

**12-1510** 1979-82 8 Steel

.110, .115, .120, .125

.130, .135, .140, .145

**12-1530** 1982-99 8 Plastic

.130, .135, .140, .145

.150, .155, .160, .165



**Newburgh, NY Motor Shop Ready & Warehouse**



**Kansas City, MO Warehouse**

**V-Twin Mfg., your original aftermarket supplier since 1968!**



**V-Twin Mfg. Call Center**

Over the past 40 years, V-Twin Mfg. has built the most comprehensive selection of original replacement products and custom accessories for Harley-Davidson motorcycles. We have more than 10,000 supporting dealers in over 39 countries servicing the Harley enthusiasts as builders, restorers and maintenance technicians. We sustain over 450,000 square feet of inventory, production and sales to ensure a high level of order fulfillment.



**Big Twin Oil Pump Gasket Kits** include gaskets, seals, snap ring balls and keys. Spring and ball not included with James Kits.

James	GB No.	Type	Year
15-0854	15-0233	Mylar	1981-91
15-0855	14-0026	Paper	1981-91
15-0856	15-0710	Paper	1992-99
15-1226	—	Coated	1992-99, Metal



**Big Twin Oil Pump Gaskets** are available in 10 pack.

James	GB No. #	OEM	Use	Years
15-0952	15-0137	B 26273-80B	Case	1980-91
15-0957	15-0683	A 26276-92	Cover	1992-99
—	15-0682	B 26273-92	Case	1992-99
15-0955	15-0138	A 26276-80A	Cover	1980-91
<b>Mylar</b>				
15-0953	15-0295	B 26273-80B	Case	1980-91
15-0956	15-0296	A 26276-80A	Cover	1980-91



**Keys for Oil Pump Gears.**

VT No.	OEM	Fits
12-0204	26340-36	1941-1967 Big Twin
12-0205	26348-15	1941-up Big Twin, 1972-76 XL-XLCH



**Tappet Oil Screen, Oil Pump Check Valve and Relief Valve Plugs.** Replacement styles as shown.

VT No.	#	OEM	Fits	Finish
8707-6	A	26263-80	1981-99 3 Piece Set	Chrome
37-9226	B	3 Plugs	1981-99 Set	Chrome
2074-6	B	3 Plugs	1981-99 Set	Chrome
2073-2	B		1981-99 Each	Chrome
8703-2*	A	26263-80	1980-99 All	Chrome
9644-2*	C	26263-80	1980-99 All	Chrome
9645-2*	C	26263-80	1980-99 All	Cadmium
9634-4	C	26263-80	1980-99 2 Piece Set	Chrome
9635-4	C	26263-80	1980-99 2 Piece Set	Cadmium
37-8960*	D	26279-89	1981-99 Dome Acorn	Chrome

\*Note: The 1981-up uses the same plug on check valve, tappet screen and relief valve.



**“Super-Pump” Spring Kit** for 1966-99 Big Twin engines. This color coated spring kit ensures that your engine maintains the recommended oil pressure of at least 10 p.s.i. @idle and up to 36 p.s.i. @road speed with a warm engine. Each spring is individually installed in the pressure relief valve of the oil pump. Works in all stock oil pumps as well as S&S and other aftermarket pump.

VT No.	Brand
13-0575	VT
13-9222	E.R.T. SP-1



**Pro Just Adjustable Pressure Relief Cap** allows the precise adjustment of oil pressure by turning the adjusting screw clockwise to increase oil pressure or counterclockwise to reduce oil pressure. Comes with a “super pump” spring provided in our spring kit 13-9222. Works in stock 1981-99 oil pumps as well as S&S and other aftermarket oil pumps. Fits 1981-99 without oil vent.

**VT No. 12-9921**

# Oil Pump

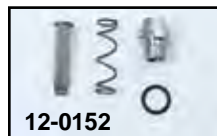

**Oil Screen Kit** includes proper plug, screen, O-ring and spring.

Chrome Cap	Stock Replica	Years
12-0152	12-0220	1981-99

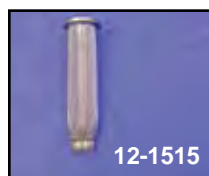
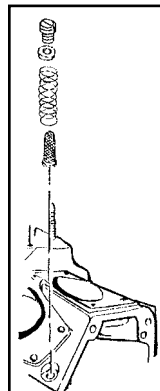

**Tappet Oil Screens** are exact replacement of OEM, each.

VT No.	OEM	Years
12-1515	24981-70	1970-99
12-0392	24983-00	2000-up

**Oil Screen Spring** for the tappet oil screen, 10 pack. 24982-70, 1970-82.

**VT No. 13-0109**

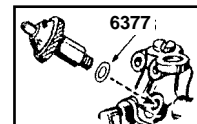

**Sealing Washers** for pressure switch, relief valve and tappet oil screen.

VT No.	OEM	Fits	Type
14-0033	6377	1950-99	O-Pressure, 5 pack
14-0503	11105	1970-99	Tappet, Relief Check Plugs, O-Ring

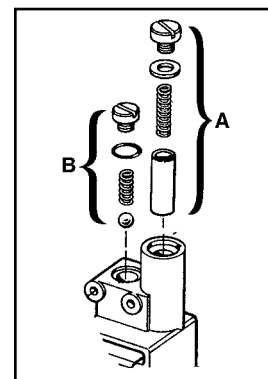

**1981-2000**

**A-Relief Valve/By Pass Kits** include spring, plug and valve.

**VT No. 12-1486**

**B-1981-99 Check Valve Kits** include ball, spring and cap.

**VT No. 12-1487**

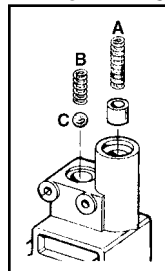

**A-Relief Valves and Springs.**

VT No.	OEM	Years	Item
13-0111	26207-83	1983-00	Spring
12-1418	26400-82	1983-99	Valve

**B-Check Valve Springs.**

VT No.	OEM	Years
13-0112	26262-80	1981-99
<b>C-Ball</b>		
12-0158	8866	1954-99



# 1999-up TC-88



42-0702



10-0813

**Chrome Gear Cover** for all TC-88 Big Twins models.

VT No.	Years
42-0702	2001-up FXST, FLST, FXD, 2001-16 FLT
42-1054	Black, As Above
10-0813	1999-00 FLT, FXD, 2000 FXST



**Form Fitting Chrome Steel Cover** fits over stock cam cases on 1999-up Big Twin TC-88, No need to remove cam case or disturb cams or gears. Covers are held in place by existing screws. Fits 2001-up FXST, FLST, FXD, 2001-16 FLT.

VT No. 42-0121



42-1054



**Jims Cam Cover Heat Sink** manufactured out of solid 6061 billet aluminum and reduces temperatures in the cam chest. Uses existing timing cover hardware. Fits 2001-16 FLT, 2001-up FXST, FXD and FLST.

VT No. 16-1180

## Cam Cover for 1973-99 Big Twin

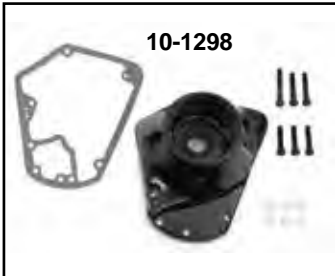

10-1298



10-0088



**1999-up TC-88 Gear Cover Screw Sets.**

VT No.	Finish	Type
9946-20	Chrome	Allen
9946-20-P	Polished	Allen



10-0040



10-0080



42-0111



42-0118

**Form Fitting Chrome Steel Covers** fit over stock cam cases on Big Twins. No need to remove cam case or disturb cam or gears. Covers are held in place by existing screws.

VT No. Fits

42-0111 1970-92

42-0118 1993-99



10-0111



10-0297



10-0111

**Chrome Cam Gear Cover** fits 1973-92. Bushing and seal are installed. Gasket, mounting bolts, and washers are included in this kit.

VT No. 10-0111

**Nose Cone Gear Covers** fit 1973-99 Big Twin models. Polished or chrome with bushings installed. Seal included.

VT No.	Years	Finish
10-1298*	1973-92	Black
10-0088*	1973-92	Polished
10-0040*	1973-92	Chrome
10-0111	1973-92	Chrome
10-0080	1993-99	Chrome
10-0297*	1993-99	Black
10-0798	1993-99	Chrome

\*Note: Comes with mounting screws gasket and seal.



**Cam Chest Kit** fits 1987-99 Evolution, as shown with Sifton 140 cam. VT No. 10-0672



Acorn Screw



Allen Style



Stock Screw

**Gear Cover Screw Sets.**

1970-92	1993-99	Type	Finish
9305-7	—	Stock	Chrome
9306-7	—	Stock	Cadmium
8761-7	9819-12	Allen	Chrome
7402-7	—	Acorn	Chrome





# 1984-99 Big Twin Pinion Hardware

BIG TWIN

## 1984-99 Big Twin Pinion Hardware

VT No.	OEM	#	Year/Item
12-1184	275	1	1970-up Bushing Pin
12-1153	358	2	1970-up Dowel Pin
8761-7	Kit	4	1970-92 Chrome Allen Screw Set
9305-7	Kit	4	1970-92 Stock Chrome Screws
9306-7	Kit	4	1970-92 Stock Cadmium Screws
9633-50	6099	14	1970-up Washer, Chrome
12-0316	9058	18	1970-up Needle Bearing
37-8971	10046	19	1981-up Wire Clamp
12-0901	11002	20	1970-up Oil Pump Retainer Ring
12-0202	23985-54	23	1970-up Key, Gear Shaft
<b>Note:</b>	24/26		See Chart for Pinion Gear Listing
12-0507	24023-54	25	1970-89 Pinion Gear Nut
12-0613	As Above		Jims
12-0512	24022-90	25	1990-92 Pinion Gear Nut
12-0577	7916A	25	1993-up Pinion Gear Nut
10-0703	24641-36	28	1970-up Oil Pump Shaft Bush
12-1539	24703-54B	29	1970-89 Pinion Gear Spacer
12-9922	24704-90	29	1990-up Pinion Gear Spacer
15-0871	25225-70B	33	1970-92 Gasket and Seal Kit
15-0872	25225-93	33	1993-up Gasket and Seal Kit
12-9906	25313-77	38	1978-99 Breather Valve, S&S
12-9957	—	38	As Above .030 O.S.
12-9909	S&S	37	Washers for Above (Set)
12-1537	25313-77	38	1978-99 Breather Gear, Sifton Steel
12-1531	25310-82	38	1982-90 1992-up Breather Valve(Plastic)
12-1530	Nylon	39	1982-up .130-.165 Set, 8 pk.
12-1533	25329-91	39A	1991-up Big Twin Air/Oil Separator
12-1508	25550-36	43	1970-up Cam Gear Washer Set .050-.095 (10 pieces)
10-1254	25550-84	43	1984-up .045 Thick, 5 pack
12-1440	—	43	.050 Cam Gear Washer
12-1441	—	43	.055 Cam Gear Washer
12-1425	—	43	.060 Cam Gear Washer
12-1426	—	43	.065 Cam Gear Washer
12-1427	—	43	.070 Cam Gear Washer
12-1428	—	43	.075 Cam Gear Washer

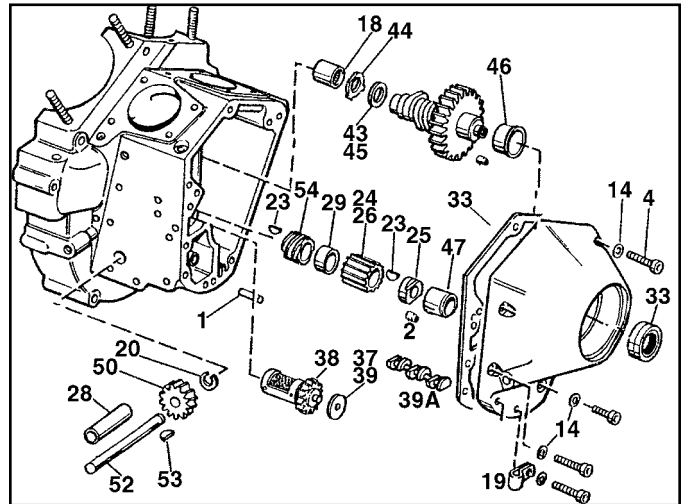

12-1429	—	43	.080 Cam Gear Washer
12-1430	—	43	.085 Cam Gear Washer
12-1431	—	43	.090 Cam Gear Washer
12-1432	—	43	.095 Cam Gear Washer
12-1433	—	43	.100 Cam Gear Washer
17-0908	25550-57	44	1958-up Lock Washer, 5 p
10-0705	25581-70	46	1970-up Bushing
10-2525	As Above	46	.005 Oversize
10-0708	25582-73	47	1973-92 Bushing Standard
10-2529	As Above	47	1973-92 Bushing .005 Oversize
10-8536	25582-93	47	1993-up Bushing
10-8556	As Above	47	1993-up Bushing .005 O/S
12-1407	26345-73	50	1973-up Drive Gear, 24T
12-0805	26346-70	52	1970-up Gear Shaft
12-0205	26348-15	53	1936-up Oil Pump Key, 10 pack
12-1392	26349-84	54	1984-89 Drive Gear
12-1438	26354-90	54	1990-92 Drive Gear
12-1439	26354-93	54	1993-up Drive Gear



## Cam Kit



**Pinion Shaft Conversion Package Kit** includes 1977-89 red pinion gear, 1954-89 pinion shaft oil pump drive gear, 1954-89 pinion shaft gear spacer and 1954-89 pinion shaft gear nut.  
VT No. 10-2585



**Sifton Evolution Pushrod Performance Cam Kit** includes cam E-Z install pushrods, chrome tappet bases and roller tappets.  
.495 lift cam.  
VT No. 11-1600

## Cam Bushing Kit



**Sifton Cam Thrust Washers and Lock Washers.**

VT No.	OEM	Year	Note
17-0908	25550-57	1957-up	5 pack
10-1254	25550-84	1984-up	.045 thick, 5 pack
12-1508*	25550-36	1936-99	10 Piece Set

\*Note: Set includes .050, .055, .065, .070, .075, .080, .085, .090, .095 and .100.

**Cam Bushing Kits Big Twin kits** include cam and gear shaft bushings/bearings with lock pins and thrust plate.

VT No.	Year
10-8272	1993-99
10-8260	1973-92
10-8261	1970-72



# Camshaft for Evolution



VT No.	Year	Application Hydraulic	P/N	Duration @ .053		Valve Lift		Valve Timing Open/Close		Lift @ TDC	
				Intake	Exhaust	Intake	Exhaust	Intake	Exhaust	Intake	Exhaust
10-5000	84-99	Good for stock replacement	EVL2000	220	214	.480"	.456"	2/38	35/1	.059"	.049"
10-5001	84-99	Good for two-up riding and pulling trailers	EVL3000	224	224	.500"	.500"	10/34	34/10	.080"	.080"
10-5002	84-99	Good low end torque and midrange in stock motor	EVL3010	234	234	.500"	.500"	15/39	39/15	.096"	.096"
10-5003	84-99	Strong midrange pipes, carburetor	EVL3020	240	240	.500"	.500"	18/42	42/18	.106"	.106"
10-5004	84-99	Strong midrange good roll-on in high gear. Carburetor, pipes and headwork	EVL3030	240	240	.530"	.530"	16/44	44/16	.099"	.099"
10-5039	84-99	Mild performance in light bike. Pulls hard through power range. Need carb pipes and valve springs.	EVL3040	242	242	.510"	.510"	17/45	50/22	.101"	.117"
10-5006	84-99	Good performance with carburetor, pipes and springs. More top end.	EVL3050	252	252	.510"	.510"	22/50	50/22	.117"	.117"
10-5008	84-99	Hot streets/strip cam. Recommended for big inch motors. Must increase compression. Valve springs, headwork, carburetors and pipes a must. 7,000 RPM.	EVL3070	270	274	.608"	.608"	29/61	63/31	.144"	.149"

V-Thunder by Comp Cams X-Treme Energy Cams for 1984-99 Evolution Big Twins are designed to maximize torque, acceleration and throttle response while providing excellent high RPM horse power.

VT No.	Application	Duration @ .053		Valve Lift		Valve Timing Open/Close		Lift@TDC	
		Intake	Exhaust	Intake	Exhaust	Intake	Exhaust	Intake	Exhaust
10-5038	For serious power in 88 cubic inch and up with 10.5:1 compression.	268	272	.601	.601	32/56	64/28	.263	.240



## 1984-99 Cam for Evolution



VT No.	Duration .053"		Gross Valve Lift		Series Grind#	Type and Application
	Open/Close		Int.	Exh.		
	Int.	Exh.	Int.	Exh.		
10-8255	226 12/34	236 41/15	.490 <sup>a</sup>	.490 <sup>a</sup>	Hydraulic Fire Ball 300-2B	Hydraulic Bolt-in. Broad power range for streetable performance. Works well with stock compression ratio and stock exhaust. No spring change required. Basic RPM idle-4000. Does not have multi-index gear. Cam lift at TDC: Intake: .094" Exhaust: .093".* Replaces EV-13.
10-8535	236 16/40	242 43/19	.490 <sup>a</sup>	.490 <sup>a</sup>	Hydraulic Fire Ball 310-2	Hydraulic Bolt-in Street performance for heavier bikes that are slightly modified. Can be used with stock compression or increased up 9.5:1. Complements exhaust and intake modifications. No spring change required. Basic RPM 1500-4500. Replaces EV-3. Cam lift at TDC: Intake: .101" Exhaust: .114".*
10-4386	242 19/43	252 48/24	.490 <sup>a</sup>	.490 <sup>a</sup>	Hydraulic Fire Ball 316-2B	Hydraulic Bolt-in designed for speed or touring. Works well with engine modifications. Works best with 9.5:1 compression ratio. Early Evolution's that do not have notched pistons must be checked for valve to piston clearance. Basic RPM 2000-5000. Replaces EV-35. Cam lift at TDC: Intake: .110" Exhaust: .127".*

Note: <sup>a</sup> Gross Valve lift for Evolution with 1.6 Rocker Arm Ratio.

To convert cam lift to valve lift, multiply the cam lift figure by the Rocker Arm Ratio: Evo-1.6

10-2651



# ANDREWS Cam for 1984-99 Evolution



For a better street cam for a stock motor, a big lift cam for a dragster or in between, Andrews Products can supply it. All cams are computer designed and precision ground from alloy steel billets.

**Andrews Engine Cams** for Evolution. Evolution series cams are designed to maximize Evolution motor performance while retaining hydraulic tappets. Both cams offered bolt in with no head work in most cases. Note Shovelhead and V2 cams are not interchangeable.

VT No.	Grind	Timing*	Duration	Lift	Springs	Application
—	Stock	01/37	218	.495	STOCK	Listed for comparison. 1984-87 cam is 212° intake 202° exhaust .472" lift on both valves.
—	89-91	53/01	232	.495		
—	Stock	-02/30	208	.472	STOCK	Listed for comparison. 92 cam very close to 84-87 specs. California cams are approximately 178° duration.
—	92-95	31/-09	202	.472		
10-1171	EV13	15/31	226	.485	STOCK	Bolt-in cam for street or touring with more mid range and upper end power more power than stock EV cam.
		45/13	238	.495		
10-1123	EV23	10/30	220	.498	STOCK	Bolt-in cam. Crisp throttle response and strong pulling power from 1500 to 6000 RPM.
		40/8	228	.498		
10-2651	EV3	21/37	238	.495	STOCK	Bolt-in cam for light bikes (FXRS, etc). More mid range power. Idle smoothness unaffected. This is a 6000 RPM cam for stock heads and springs with hydraulic tappets.
		43/15	238	.495		
10-1180	EV27	20/36	236	.495	STOCK	Bolt-in street cam with fast open and close ramps. Similar timing to EV3 but designed to produce a broad torque band. Pulls 1500-6000.
		44/16	240	.495		
10-1146	EV46	25/41	246	.495	STOCK	Bolt-in performance with fast open and close ramps. Similar to EV3 but higher static compression pressure for 6000+ RPM with stock heads and hydraulic tappets.
		49/17	246	.495		
10-1183	EV51	28/44	252	.510	STOCK	Easy installation with longer duration for modified street engines with hydraulic tappets. Power range from 3000-6500 RPM.
		54/22	256	.510		
10-1181	EV59	28/48	256	.560	HI-LIFT	Updated EV57, fast ramps for modified 80-88" motors. Use with AP springs and collars. Broad power band; 6000 RPM, okay for hydraulic tappets.
		56/24	260	.560		
10-1182	EV72	30/54	264	.560	HI-LIFT	Updated EV7, for 92" + Street. Use with Andrews springs and titanium collars. Broad power band; 2800-6000 RPM, okay for hydraulic tappets.
		60/28	268	.560		

\*Note: Timing measured at .053 cam lift.



## S&S Performance Camshaft

10-5075



VT No.	Cam Name	Application	Valve Timing * Intake	Valve Timing * Open/Close	Valve Timing * Exhaust	Valve Timing * Open/Close	Valve Duration Intake	Valve Duration Exhaust	Valve Lift V2	Lift @ TDC + Intake	Lift @ TDC + Exhaust	Requirements Spring Spacing	Requirements Tappet Type
10-5049	S&S 520	Engines to 96" with 8.5 to 10:1 Comp ratio. Good low end mid range	0°/40°	50°/2°	220°	232°	.520"	.086"	.094"	Yes	Hydraulic		
10-5053	S&S 546	For 4" Bore Engines 9.1:1 to 10.1:1 CR	5°/55°	52°/5°	240°	237°	.546"	.126"	.106"	Yes	Hydraulic		
10-5076	S&S 561	Best cam for 80" to 93" 9.5:1+ CR engines.	32°/40°	50°/26°	252°	256°	.560"	.252"	.210"	Yes	Hydraulic		
10-5054	S&S 585V	80" to 96" Engines 10:1-10.5:1 Comp Ratio	20°/45°	60°/20°	245°	260°	.585"	.186"	.180"	Yes	Hydraulic		
10-5055	S&S 600	80" to 96" Engines 10.5:1-11:1 Comp Ratio	20°/55°	60°/20°	255°	260°	.600"	.218"	.198"	Yes	Hydraulic		
10-5056	S&S 640	Big Inch Engines 10.5-11:5.1	26°/50°	65°/20°	265°	265°	.640"	.222"	.192"	Yes	Hydraulic		

\*Note: Timing designation is function of zero lash @ .053" off base circle.

+Lifts at TDC are measured at the valve and are for reference only. Overlap valve lifts must be checked on assembled engine. Minimum valve to valve clearance of .040" is recommended.



## Sifton Cam

For Identification check these applications: 1987-99 Evolution

Sifton Stock Cams are replica type. Also available with matching pinion gear.

Cam	Cam Kit	OEM	Fits
—	10-8188	24582-88	1987-90 Evolution (OE)
10-8172	—	24582-88	1987-90 Evolution



For Big Twins	VT No.	Year	Cam	Degrees	At .053	Lift	TDC	Travel to	Free
For 1987-99 Evolution	10-0621		140 Ev	Open	Closes	Total	TDC	Coil Bind	Travel
			Inlet	30	42	.450	.222	.480	.530
			Exhaust	55	27	.450	.177	.480	.530
Viper (146 Evolution) Cam delivers excellent performance throughout the RPM range. Bolt in street cam with first open & close ramps.									
	10-8182	1987-99	495	20°	36°	.495	.236		
				44°	16°		.240		



**ANDREWS**

# Camshaft for TC-88



Andrews TC-88 Camshafts are available to fit stock type chain drive or S&S gear drive. Early style cams fit 1999-2006 FXST, FLT and 1999-2005 Dynaglide with silent chain drive. Late style cams fit 2007-16 FXST, FLT and 2006-up Dynaglide with roller chain drive. All cams listed are for use with stock hydraulic tappets and stock type splined gears or S&S gear drives.

VT No.	Drive Type	Grind	Timing*	Duration		Valve Lift	Lift @ TDC	Springs	Application
				.053	.020				
10-6309	Late Roller Chain	09H	02/28 40/04	206 216	242 252	.492 .486	.075 .075	Stock	Bolt-in cam more power through entire RPM range
10-8162**	Late Gear Drive	12	37/05 02/34	220 216	259 256	.474	.110 .088	Stock	Bolt-in cam with similar specs to stock 06 Dynaglide cams. Slight power increase. No retuning necessary.
10-8121 10-8131** 10-8163**	Early Chain Drive Early Gear Drive Late Gear Drive	21	10/30 40/08	220 228	255 264	.498 .498	.134 .121	Stock	Bolt-in cam with more torque. All around riding with stock comp. ratio and heavy bikes. 21 Cams work well with fuel injection or carburetors. (1700-4800 RPM)
10-8127 10-8131** 10-8139 10-8164**	Early Chain Drive Early Gear Drive Late Roller Chain Late Gear Drive	26	11/35 41/09	226 230	262 266	.490 .490	.138 .112	Stock	Bolt-in cam for low RPM torque; FLT, etc. For two up touring, this cam will add more torque and HP at lower and middle RPM range.(1800-5500 RPM) 26 Cams work well with fuel injection or carburetors
10-8141 10-8142** 10-8143 10-8189**	Early Chain Drive Early Gear Drive Late Roller Chain Late Gear Drive	31	10/46 52/08	236 240	272 276	.510 .510	.131 .120	Stock	Great cam for motors with 95+ inches and 10:1 compression ratio, lower TDC lift means easy installation similar to 37 but different timing. 2400-5800 RPM power range.
10-8191** 10-8192 10-8193**	Early Gear Drive Late Chain Drive Late Gear Drive	32	10/46 52/08	236 240	272 276	.510 .510	.131 .120	Hi Lift	Hi-Lift version of 31 much more power thru RPM range with 10:1+ compression ratio 2800-5800 RPM Power Range.
10-8137 10-8132**	Early Chain Drive Early Gear Drive	37	18/38 46/14	236 240	272 276	.510 .510	.174 .148	Stock	Twin 88's with this bolt-in cam grind have shown 80+ rear wheel HP. Smooth idle, broad torque band. Runs (2200-5600 RPM)
10-6348 10-8146	Late Roller Chain	48	13/29 43/15	222 238	257 273	.548 .548	.153 .163	Stock	Broad tip cams for Baggers with stock motors. Max torque at low and mid RPMs.
10-8147 10-8195**	Late Roller Chain Late Gear Drive	44	49/17	246	283	.495	.158	Stock	Engines with 88 inches 9.5 compression ratio or higher. Maximum torque and HP at middle and upper RPM.
10-8154 10-8210** 10-8211**	Early Chain Drive Early Gear Drive Late Gear Drive	54	16/42 43/15	238 238	273 273	.555 .555	.165 .158	Hi-Lift	Specifically designed for 96 and 103 engines with compression ratio up to 10:1 (2200-5600 RPM range).
10-8150 10-8134** 10-8148 10-8196**	Early Chain Drive Early Gear Drive Late Roller Chain Late Gear Drive	50	20/48 54/18	248 252	283 287	.510 .510	.184 .168	Stock	Cams for maximum torque and HP higher RPM ranges. For lighter bikes and engines with 9.5 compression ratio (or higher) and 88-95 inches (2600-6000+ RPM).
10-8155 10-8135** 10-8156 10-8197**	Early Chain Drive Early Gear Drive Late Roller Chain Late Gear Drive	55	22/46 52/20	248 252	283 292	.550 .550	.197 .181	Hi-Lift	Cams for maximum torque and HP at higher RPM ranges. For engines with 9.5 compression ratio or higher and 88-95 inches.
10-8151 10-8136** 10-8198**	Early Chain Drive Early Gear Drive Inter Gear Drive	60	24/56 58/22	260 260	296 296	.560 .560	.205 .205	Hi-Lift	For a well prepped engine with 95 inch cylinders and head work, 100+ HP is within reach. Tuning also includes exhaust changes (2400-6000+ RPM).
10-8149** 10-8199**	Early Gear Drive Late Gear Drive	67	24/48 58/22	252 260	287 297	.570 .570	.209 .187	Hi-Lift	Performance Cam for 95-107+ inches, 10:0 to 10:8 compression ratio with high flow head setup (2600-6400+RPM).
10-8152** 10-8200**	Early Gear Drive Late Gear Drive	59	29/57 63/27	266 270	303 307	.590 .590	.238 .218	Hi Lift	Great cam for 95-107" inches 10:2 compression ratio or higher max torque and HP (2700-6500 RPM).
10-8153** 10-8209**	Early Gear Drive Late Gear Drive	64	30/62 66/30	272 276	307 312	.640 .640	.262 .232	Hi-Lift	Big cams for modified 95-116+ inch motors running 10:2 compression ratio or higher. Heads must be set for .700 lift and modified for max air flow (3000-6500 +RPM).

\*Note: Timing and duration listed for .053 cam lift. \*\*Note: Requires S&S Gear Drive

## Camshaft Kit for TC-88



Andrews TC-88 Cam Upgrade Kit for converting all 1999-06 Twin Cam Big Twins to the 2006-up roller chain drive with hydraulic chain tensioners. Instead of super powered spring adjusters the roller cam chain adjuster uses engine oil pressure to maintain proper chain tension and roller chain camshafts have larger journal bearing for extra support on the sprocket shaft ends. Kit includes cams only and requires separate purchase of 2007-up oil pump, support plate, chain tensioners sprockets and hardware. See camshaft components page for additional parts required to complete conversion. Note: For 1999, 2000 and 2001 engines a rear cam drive sprocket with an ignition trigger ring must be used.

VT No.	Grind	Timing*	CL	Duration		Valve Lift	Lift @ TDC	Springs	Application
				0.053	0.020				
10-6821	21N	10/30 40/08	100 106	220 228	255 264	0.498 0.498	0.135 0.121	Stock	Bolt-in cam: More torque for all around riding with heavy bikes, stock compression ratios and stock pistons. Similar to #23 cam for EV80 (1700-4800 RPM).
10-6826	26N	11/35 41/09	102 106	226 230	262 266	0.490 0.490	0.138 0.120	Stock	Bolt-in cam 88-95 inches and stock compression ratio. Great for two up touring, this cam will add torque and HP at lower and middle RPM ranges (1800-5200 RPM).
10-6831	31N	10/46 52/08	108 112	236 240	272 276	0.510 0.510	0.131 0.120	Stock	Great cam for motors with 95 inches and 9.8 to 10.2 compression ratio. Lower TDC lift for easy installation. Similar to TW37 with different timing. (2000-5600 RPM).
10-6837	37N	18/38 46/14	100 106	236 240	272 276	0.510 0.510	0.174 0.148	Stock	For engines with 88 or 95 inches and compression ratios from 9.5 to 10.2 compression ratio; Max torque range; (2300-5800 RPM).
10-6850	50N	20/48 54/18	104 108	248 252	283 287	0.510 0.510	0.184 0.168	Stock	Designed for easy installation in 95 inch motors with stock heads for 9.5 to 9.8 compression ratio. (2400 to 6000 RPM).
10-6855	55N	22/46 52/20	102 106	248 252	283 292	0.550 0.550	0.197 0.181	Hi-Lift	Great cam for 95 inch with 9.8 to 10.2 compression ratio. Max HP-torque at mid and upper RPMs (2600 to 6200).
10-6015	Sprocket with trigger rign for 1999-01 applications only								

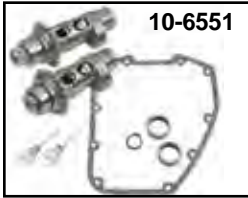

# Cam Kit for TC-88



Andrews TC-88 Steel Camshaft Drive Sprocket fits 1999-06.

VT No.	Type	Sprocket Type
19-8010	34T Cam	Key Drive
19-8015	34T Cam	Spline Drive
19-8020	17T Crank	Spline Drive



## S&S Easy Start Cams

- Start any engine even with a stock starter
- Save your starter and battery
- Reliable-tested for 10,000 consecutive starts and never ran down the battery
- Fully automatic no buttons to push
- Start any TC-88 engine regardless of displacement or compression available in chain or gear drive versions-proven performance again from an industry leader

S&S, kits include cams, gear drive kit (when required) and cam installation kit.

2007-16 FLT      2007-16 FLT      99-06 TC-88 Series

chain drive kit	gear drive kit	gear drive kit	
10-6551	N/A	10-9551	551
10-6570	N/A	N/A	570
10-6583	N/A	10-9583	583
N/A	N/A	10-9585	585
N/A	10-7625	10-9625	625
10-6640	10-7640	N/A	640
N/A	10-7675	10-9675	675



S&S TC-88 Gear Drive Cams and Camshaft Kits increase valve timing accuracy by eliminating timing chain lash and also reverses the rear cams direction of rotation providing additional operating clearance between cam lobes that will allow higher cam lifts.

**Complete Cam Kits** include cams, complete gear drive kit and cam installation kit.  
**Gear Drive Cams** can only be used with gear drive kit and also must be used with adjustable pushrods and performance valve spring kit.  
**Cams only** include inner gears. Outer cam drive gear kit must be ordered separately. Material must be removed from the inner surface of the stock gear cover and crank case modification is required on .625" and .640 lift cams.

00-05 FXD		06-up FXD-		Series (See Note*)	Valve Timing		Valve Duration		Valve Lift	Centerline		Lift@TDC	
00-06 FLT	00-06 FLST	07-up FXD-FLST	2007-16 FLT		Intake	Exhaust	Intake	Exhaust		Intake	Exhaust	Intake	Exhaust
—	10-5182	—	—	509G <sup>5</sup>	18°/18°	46°/11°	216°	237°	.509"	90°	106°	—	—
10-5160	10-5177	10-5246	10-5266	510G <sup>1</sup>	20°/38°	52°/20°	238°	252°	.510"	99°	106°	.187"	.178"
—	10-5178	10-5247	10-5267	570G <sup>2</sup>	20°/40°	55°/20°	240°	250°	.570"	100.0°	107.5°	.187"	.179"
10-5168	10-5179	10-5248	10-5268	585G <sup>3</sup>	20°/40°	60°/20°	245°	260°	.585"	102.5°	110.0°	.186"	.176"
—	10-5180	10-5249	10-5269	625G <sup>4</sup>	20°/55°	60°/20°	255°	260°	.625"	107.5°	110.0°	.189"	.184"
10-5172	—	10-5250	10-5270	640G <sup>5</sup>	25°/60°	60°/25°	265°	265°	.640"	107.5°	107.5°	.228"	.221"
10-4276	—	10-4268	—	Outer cam drive gear kit									
10-4275	—	10-4285	—	complete gear drive kit includes pinion gear, front and rear inner cam gears and outer cam gear.									

11-7715 adjustable pushrod set

11-2077 valve spring kit w/steel top collars

1. Camshaft Set 510G: designed for 88-95 cubic inch engines with compression ratio below 9.7:1
2. Camshaft Set 570G: designed for 88-95 cubic inch engines with compression ratio below 10:1
3. Camshaft Set 585G: designed for 88-95 cubic inch engines with compression ratios from 10 to 10.75:1
4. Camshaft Set 625G: designed for engines of 95 cubic inches or more with compression ratios between 10.0 and 10.75:1
5. Camshaft 640G: designed for engines of 95 cubic inches or more with compression ratios of 10.5-11.5:1
6. Camshaft 510G: designed for 88 cubic inches with stock compression ratio



## S&S TC-88 Adjustable Pushrods and Cover Kit.

Chromoly pushrods feature simple trouble-free installation that does not require the removal of gas tank or rocker assemblies. Includes pushrods, gaskets, O-rings, retainer clips and upper pushrod covers that have been designed to provide a more stable and rigid cover assembly. Fits 2006-



**Cam Installation Support Kit** includes cam cover gasket, two inner cam needle bearings, two outer cam bearings and a retaining ring.

VT No.	Type	Years
12-0125	Gear	2000-05 FXD, 2000-06 FXST FLST, FLT
12-0126	Chain	As Above
12-5240	Gear	2006-up FXD, 2007-up FXST FLST 2007-2016 FLT

up FXD, 2007-up FXST FLST, 2007-2016 FLT.

VT No.	Item
11-7715	Kit
11-7716	Pushrods Only



## TC-88

Crane Cam Sets are available as a replacement style to be used with stock cam drive assembly or with S&S gear drive assembly. Computer designed hydraulic cams that feature lube-to-lube cam profile accuracy for off idle torque to high RPM horsepower.

99-05 FXD	06-up FXD	Duration @.053	Exhaust	Gross Valve Lift @ TDC	Exhaust	Specifications
99-06 FLT, FXST	07-16 FLT, 07-up FXST-FLST	Intake	Exhaust	Intake	Exhaust	
comp.	10-4411**	226°	236°	.505"	.505"	<i>Mild Street, Cruising, Touring.</i> Bolt-in cam, low-end torque and mid-range HP. Good for heavy bikes. Stock
10-4392		13/33	42/14	.147"	.152"	Best power with performance air cleaner, free-flow exhaust. Use stock v/springs. Range: Idle to 5,000 RPM
10-4407*		236°	242°	.505"	.505"	<i>Moderate Street, Cruising.</i> Bolt-in. Mild performance for Dynaglide, Softail or single riders. Stock compression ratio or up to 9.5:1. Must use performance air cleaner and free-flow exhaust. Uses stock v/springs.
N/A		20/36	47/15	.185"	.157"	Range: 1,500 to 5,500 RPM
10-4393	10-4419	242°	252°	.505"	.505"	<i>Street Performance, Some Engine Modifications.</i> Bolt-in. Okay with stock compression but works best with up to 10:1:1 compression ratio. Must use performance air cleaner and free-flow exhaust. Use stock valve springs.
N/A		19/43	48/24	.178"	.205"	Range: 1,800 to 5,800 RPM
N/A		240°	248°	.570"	.570"	<i>Hot Street Performance, Modified.</i> Okay with stock cubic inch or big-bore kit (95 cubic inch). Best power with increased compression ratio 9.5:1-up, head mods. Must use Crane valve springs, cleared for .570" lift. Great low-end and mid-range torque with added upper RPM power. Must use performance air cleaner and free-flow exhaust. Range 1,800 to 5,800 RPM
10-4395		18/42	46/22	.173"	.198"	
10-4416**		254°	260°	.600"	.600"	<i>Max Hot Street, Modified.</i> For modified engines. Higher compression, 10.5:1-up big-bore kits, head modifications, etc. Must use Crane valve springs, cleared for .600" lift. Strong mid-range torque with upper RPM power. Must use performance air cleaner and free flow exhaust. Range: 2,000 to 6,200 RPM
10-4416**		25/49	56/24	.211"	.206"	

\*Note: Use S&S Gear Drive Assembly 10-4275

\*\*Note: Cam and lifter kits include replacement style cams and Crane Performance tappets.



# Pushrod Cover for TC-88



**Chrome Billet Pushrod Cover Set** for TC-88 engines and includes seals and O-Rings necessary. Replaces 18096-00. Fits 1999-up FXST, FLST, FXD and 1999-2016 FLT.

VT No.	Item
11-0943	Billet Kit
11-9969	Inner Steel Tubes

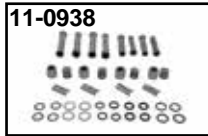

**Replica Pushrod Cover Kit** for TC-88 models and includes all pieces necessary for installation.

VT No.	Finish
11-0938	Chrome
11-0376	Black
11-8081	Titanium Plated

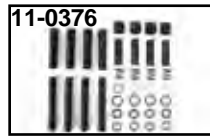

Fits 1999-up FXST, FLST, FXD and 1999-2016 FLT.



**Chrome Billet Pushrod Cover and Tappet Base Kit** for TC-88 fits 1999-up FXST, FLST, FXD and 1999-2016 FLT. VT No. 42-0937

## Tappet



**Crane Hydraulic Roller Tappet** provides improved RPM capability, superior reliability and quieter operation. Features include use of a precision, hardened ball-type valve to provide superior sealing and lash control. A rotating check ball prevents localized wear and pitting. Fits 1999-up.

VT No. 10-2200



**TC-88 Replacement Hydraulic Tappet** replaces 18538-99. Sold each. Standard size.

VT No.	Brand
10-0820	Sifton
10-0824	Sifton Set
10-1821	Sifton (anti pump)
10-1822	Sifton (heavy springs)



**Jims TC-88 Powerglide Standard Tappet Assemblies.** Sold each.

VT No.	Type
10-0568	Hydra II
10-0569	Hydro Solid II



**Powerglide II™ Advantage** for TC-88.

VT No.	Type	Size
10-0568	Hydraulic Tappet	Standard
10-0571	Hydraulic Tappet	.005
10-1811	Hydraulic Tappet	.010
10-0569	Hydrosolid Tappet	Standard



**TC-88 V-Thunder Hydraulic Roller Tappet** available in High Energy which is a performance replacement for the stock tappet or Pro Magnum which is designed to perform at higher engine speeds. Both feature a unique anti-pump up retainer designed to replace the stock retainer clip which precisely limits plunger travel. Standard size, sold each.

VT No.	Item
10-8750	High Energy
10-8751	Pro Magnum



**Tappet Base Bolt Sets** for 2000-up TC-88 without taper. Fits 1999-up FXST, FLST, FXD and 1999-2016 FLT.

VT No.	Type
9942-16	Allen
9942-16-P	Allen Polished



**TC-88 Chrome Tappet Top** replaces 17964-99 front and 17966-99 rear. Fits 1999-up FXST, FLST, FXD and 1999-2016 FLT. VT No. 10-0811



**Chrome Billet Tappet Bases** for TC-88 models. Fits 1999-up FXST, FLST, FXD and 1999-2016 FLT. VT No. 10-0815





# Pushrod for TC-88

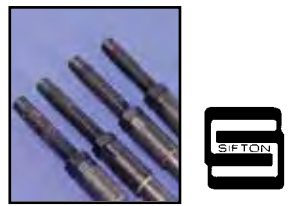
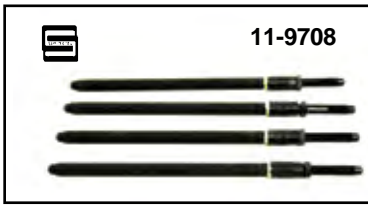

**Sifton Quick Install Pushrod Sets** are designed to be installed without removal of rocker boxes or cylinder heads. Precision made from 4130 chromoly tubing. For TC-88 Fits 1999-up FXST-FLST, FXD and 1999-16 FLT. **VT No. 11-9708**



**"Elevator" Solid Tappet Conversion Set** raises the tappet top for better pushrod angle of travel. Fits 1999-up FXST-FLST-FXD and 1999-16 FLT.

- VT No. Item**
- 10-0786** Tappets
- 11-0843** Pushrods
- 11-1067** Cover Set
- 11-0865** Kit, see web for instructions



**S&S TC-88 Adjustable Pushrods and Cover Kit.** Chromoly pushrods feature simple trouble-free installation that does not require the removal of gas tank or rocker assemblies. Includes pushrods, gaskets, O-rings, retainer clips and upper

pushrod covers that have been designed to provide a more stable and rigid cover assembly. Fits 1999-up FXST-FLST- FXD and 1999-16 FLT.

- VT No. Item**
- 11-7715** Kit
- 11-7716** Pushrods Only



**V-Thunder Big Twin Pushrod Kits** are made from .049 wall 4130 chromoly steel tubing. Exacting tolerances for reliability. Fits 2000-up TC-88 with stock blocks. **\*Note:** Saves time without the disassembling of the heads or tappet blocks. Fits 1999-up FXST-FLST-FXD and 1999-16 FLT. **VT No. 11-7013\***



**Performance Pushrod Sets for TC-88** are E-Z install type which are designed to be installed without removal of the heads or rocker boxes. Rods feature chromoly tube construction with rolled thread adjusters. Fits 1999-up FXST-FLST-FXD and 1999-16 FLT.

- VT No. Brand**
- 11-0824** Sifton **Note:** Pushrod covers only.
- 11-9709** Complete Kit, Pushrods and covers
- 11-1078** Clips

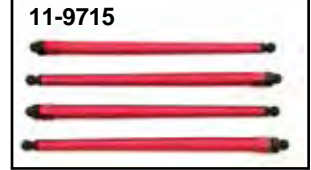
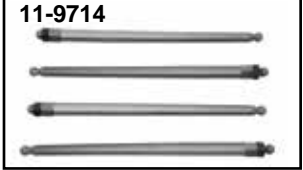

**Sifton Taper Lite Adjustable Pushrods** are with hardened adjusters and ball ends. Designed to be installed without removing gas tank, rocker box or camshaft cover. Set of four. Fits 1999-up FXST-FLST-FXD and 1999-16 FLT.

- VT No. Type**
- 11-9714** Steel
- 11-9715** Alloy



**Andrews Anodized TC-88 E-Z Install Pushrods** are available in chromoly or aluminum. Installation does not require removal of tank or rocker boxes. All are stock diameter, so there is no cover interference. Fits 1999-up FXST-FLST-FXD and 1999-16 FLT.

- VT No. Type**
- 11-2188** Aluminum
- 11-2088** Chromoly



# Pushrod for Evolution 1984-99

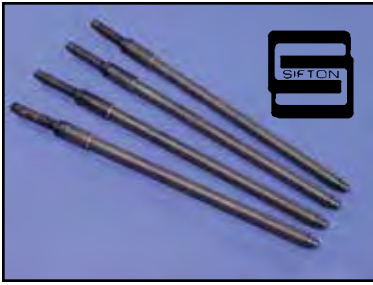

**Sifton™ Quick Install Pushrod Sets** are designed to be installed without removal of rocker boxes or cylinder heads. Precision made from 4130 chromoly tubing. Fits Evolution Big Twins 1984-99. **VT No. 11-9707**



11-9702

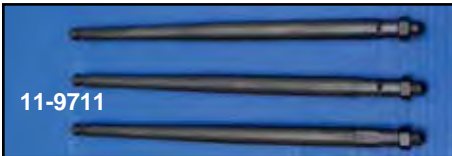

11-9711

**Tapered Adjustable Pushrods** are manufactured from 4130 steel with hardened adjusters and ball ends. Designed to be installed without removing gas tank, rocker box or camshaft cover. Set of four. Fits Evolution Big Twin hydraulic or solid.

<b>VT No.</b>	<b>Brand</b>
11-9702	Rivera
11-9711	Sifton



11-9542



11-9543

**Solid Tappet Adapter Kit** permits use of hotter cam to run solid tappets by deactivating the hydraulic portion of the stock tappets, uses stock pushrods for 1340 models.

<b>VT No.</b>	<b>Fits</b>
11-9542	1984-Early85
11-9543	Late1985-99



7132-89



7132-96

**Crane Adjustable Pushrods** made from aircraft grade seamless 4130 chromoly steel tubing and heat treated to 128,000 psi tensile strength for a stronger and lighter than stock pushrod. New style adjuster helps minimize the effects of poor geometry found in stock pushrods, the smaller diameter eliminates pushrod "rub" completely. Set contains two intake and exhaust pushrods. These are not the time saver type.

<b>VT No.</b>	<b>Fits</b>
7132-89	With stock hydraulic tappets
7132-96	With long stroker cylinders



**E-Z Pushrod Sets** designed to be installed without removal of the heads or rocker boxes. Rods feature chromoly tube construction with rolled thread adjusters. Fits Evolution 1340. **VT No. 11-7713**



11-9221

**Andrews E-Z-Install Evolution 80 Pushrods** are available in either aluminum (6061T6) or steel (4130 moly). Kits include four adjustable steel or aluminum pushrods which will install without removing tanks or rocker boxes.

<b>VT No.</b>	<b>Type</b>
11-9221	Aluminum
11-9224	Chromoly Steel



11-9866

**Andrews Pushrods** available in chromoly steel or aluminum, adjustable or fixed type as noted. All are stock diameter, so there is no cover interference.

<b>VT No.</b>	<b>Adjustable</b>
11-9865	Aluminum
11-9866	Chromoly



# Pushrod for 1984-99 Evolution

BIG TWIN



**Sifton Performance Cam Kit** includes cam E-Z install pushrods, chrome tappet bases and roller tappets. .495 lift. Fits Evo. VT No. 11-1600



**Sifton Solid Tappet Kit** for Evolution 1340 includes four (4) solid tappets, standard size, with rollers installed and four (4) adjustable pushrods.

VT No. 11-9630



**V-Thunder Evolution Pushrod Sets** are made from .049 wall 4130 chromoly steel. Exacting tolerances for reliability. VT No. 11-7712 is a 2-piece style which can be removed or installed without disassembling heads. These rods fit stock or Velva Touch Tappet units. **\*Note:** Saves time without the disassembling of the heads or tappet blocks

VT No.	Application
11-7710	Stock
11-7711	Stroker
11-7712*	Stock



### Adjustable Evolution Pushrod Sets.

VT No.	Style	Year
11-9528	Hydraulic	1986-99
11-9536	Solid	1984-Early 85



**Sifton Chrome 1986-99 Tappet and Pushrod Assembly** includes four tappet units, four pushrods and a tappet base set with screws and gaskets.

VT No.	Type
11-0350	Hydraulic
11-0356	Solid



**S&S Limited Travel Spacer Kit for Hydraulic Tappets.** Designed to maximize the efficiency of the stock hydraulic tappets. Kit consists of four (4) machined heat treated and ground spacers when installed in the tappets. They reduce the travel of the hydraulic unit in high RPM situations thereby eliminating potential damage to the engine due to high RPM valve float. Under normal conditions they allow the tappets to operate as designed resulting in low valve train maintenance and minimal noise. VT No. 10-8532

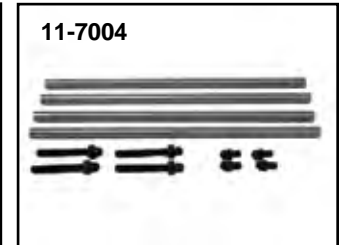

**Comp Cams "Build Your Own" Stroker Pushrod Kits** are designed for stroker motors with tall cylinders. Feature 7/16" diameter tubing in either .049 wall thickness with press-in ends on .080 wall thickness with screw in ends.

VT No.	End Type
11-7003	Press In
11-7004	Screw In





# 1984-99 Evolution Tappets



**Sifton Hydraulic Tappet Assembly Sets of 4**, feature centrifrifal surface fine grinding and precision fit rollers and pins.

VT No.	Size
10-0779	Standard
10-0780	.002
10-0781	.005



Sifton



**Evolution 1340 Solid Tappets** can only be used with adjustable pushrods. Jims brand sold each. Sifton™ brand sold in set of four.

Jims Big Axle	Sifton™	Size
10-0636	10-8256	Standard
10-0637	10-8257	.005
—	10-8258	.010



**V-Thunder Evolution Replacement Tappet** features precision grinding and performance hydraulics.

VT No.	Item
10-7391	Set of 4



**Jims Hydrosolid Big Axle Tappet Assemblies** have a built in anti-pump device, perform like a hydraulic from start up to about 5500 RPM and turns into a solid at 5600 RPM.

Size	VT No.
Standard	10-0657
.002	10-0658

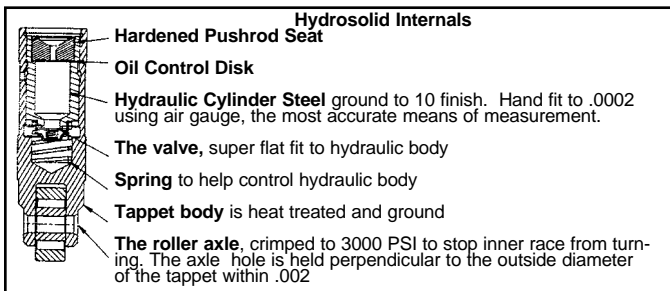

**Evolution Big Twin Replacement Hydraulic Tappets.** Replaces OEM# 18523-86A. Sold each.

VT No.	Size
10-8373	Standard
10-8374	.002
10-8375	.005



**Crane Evolution Hydraulic Roller Tappet Performance Assemblies** features precision ground plunger, high strength pushrod seat and a heavy duty wafer for positive sealing. Sold each.

VT No. 10-2050



**Tappet Roller Repair Kit** includes four pins and four roller assemblies.

VT No.	Brand
10-2534	V-Twin
10-0529	Crane
10-0934	Maxi and Pin



**Sifton Hydraulic Tappet Unit Sets** feature maxi-axle roller and pin design and unique "no-bleed" integral pump unit. Unique pump design features full hydraulic action up to 5000 RPM, then act as solid. Set of four.

VT No.	Size
10-0583	Standard
10-0584	.002



**Power Glide Evo Hydraulic Tappets** available as individual units replacing 18523-86 in standard and .005.

Big Axle	Size
10-0645	Standard
10-0646	.005

**Jims Powerglide Steady Roll Tappet** feature a special bronze alloy roller bushing in place of stock type loose needle roller bearing.

Size	1984-98 FXST, FLT	1999-up FXST, FLST
Standard	10-1824	10-1827
.002	10-1825	10-1828
.005	10-1826	10-1829



# Tappet Blocks for TC-88



**TC-88 Chrome Tappet Top** replaces 17964-99 front and 17966-99 rear. Fits 1999-up FXST-FLST-FXD and 1999-16 FLT.

VT No.	Type
10-0811	Top Kit
11-1403	Screw Kit



Fits 1999-up FXST-FLST-FXD and 1999-16 FLT.

**Chrome Billet Tappet Bases** for TC-88 models. Gaskets included. **VT No. 10-0815**



**Tappet Base Bolt Sets** for 1999-up TC-88 without taper. Fits 1999-up FXST-FLST, FXD and 1999-16 FLT.

VT No.	Type
9942-16	Allen
9942-16-P	Allen Polished

**Tappet Base Bolt Sets** for Big Twin models. **1976-up with Stock Tappet Blocks. 1/4" — 20 thread without taper.**

VT No.	Type	Finish
7628-8	Acorn	Chrome
8726-8	Allen	Chrome
8709-8	12 point	Cadmium
8708-8	12 point	Chrome
8710-8	12 point	Black
8709-8T	Hex	Zinc

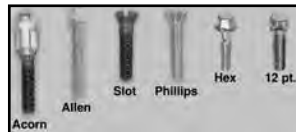

# Tappet Blocks for Evo



**Chrome Tappet Guide Set** includes front and rear tappet guide. Fits all 1984-99 1340 Evolution Big Twin.

VT No.	Item
11-9506	Tappet Block Set
15-1542	Gasket Kit



**Billet Tappet Blocks** are machined from solid blocks. Made and polished by Jims, sold pairs. Fits 1985-99 1340 Big Twin Evolution.

**VT No. 10-0069**



**S&S Tappet Block Sets** for V-2. The burnished aluminum finish matches S&S cylinder heads and crankcases. Blocks accommodate a cam, base circle of .960", with up to .630" lift. Screws and gaskets included.

VT No.	Fits
11-9290	Big Twin
15-0715	Gasket Rear
8708-8	Screws 12 point 1/4"-20 x 7/8"



**42-0437 Installed**



**Chrome Evolution Tappet Covers** fit over stock blocks. Each cover has a slot which allows it to be installed without removing pushrods. Install by lifting the pushrod tube cover and inserting the covers. Fits 1985-99 Big Twins.

VT No.	Type
42-0437	Steel
42-0458	Die Cast





# Pushrod Cover and Seal for Evolution



11-0909  
Installed

V-Twin Chrome Pushrod Cover Kits in stock style gives all the parts needed for complete installation. All are sixteen piece kits for 1984-90 Evo.  
**VT No. Finish**  
11-0909 Chrome  
11-0359 Black  
11-1090 Titanium



42-0903

**Chrome Pushrod Cover Set** with chrome tappet base covers as a complete dress up kit for 1984-99 Big Twin Evolution.  
**VT No. 42-0903**



11-0909



**Chrome Billet Pushrod Cover Kit** fits 1984-99 Evolution models.  
**VT No. 11-0945**



11-0359



**Chrome Head and Spark Plug Cover** fits 1986-99 Evolution models. Covers are held in place by rubber inserts supplied.  
**VT No. 42-0929**

## Head Bolt Cover Sets

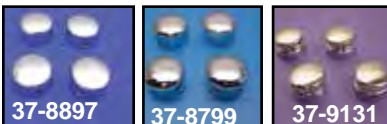

37-8897



37-8799



37-9131

**Chrome Head Bolt Covers** fit Big Twin models.

VT No.	Type	Year
37-8897	Smooth	1983-84
37-9131	Grooved	1985-99
37-8799	Smooth	1985-99
42-1092	Brass	1985-99



42-1092



9001-4

**Headbolt Covers** fit over 12 point headbolts on 1986-99 Evolution models. Evolution styles include four pieces for left side only. Styles include hex acorn or cap with chrome finish. Allen wrench included.



9000-4

Style

9002-4

Acorn

9002-4

Cap



42-0772



42-0773



42-0774

**Head Lockers** fit Big Twin Evolution 1340 available shot peened natural aluminum or black with highlighted fin edge. Sold in a pair with two set screws included to install.

Aluminum	Black	Year
42-0772	42-0774	1986-91
42-0773	—	1992-99



2262-4  
Installed



2262-4



2024-4

**Cam Head Bolt Cover** for Evolution/Twin. Headbolt covers to hide dull 12 point headbolts on late 1985-up FL-FX. Installation with set screw.

VT No.	Style
2024-4	Hex Dome
2262-4	Spike



**Chrome Head and Spark Plug Cover** fits 1986-99 Evolution models. Covers are held in place by rubber inserts supplied.  
**VT No. 42-0929**





**1984-99 Chrome Billet Pushrod Cover Kit** includes all pieces and seals for complete installation on Evolution Big Twin models.  
**VT No. 11-0947**

# Pushrod Cover Components



11-0928



7508-20



11-1206



11-0913

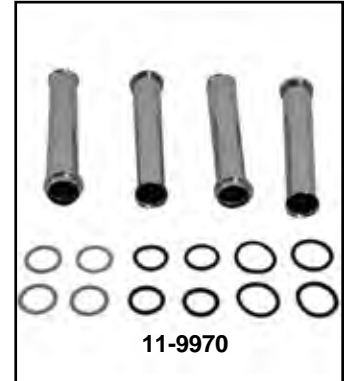

11-9970

**Lower Pushrod Tube Sets. Chrome Plated**

**VT No. Brand Fits**

- 11-0913** V-Twin 1984-99 Evolution
- 9202-12** Colony 1984-99 Evolution
- 9968-12** Colony TC-88; 1999-up FXST, FLST, FXD, 99-16 FLT
- 11-9970** V-Twin TC-88; 1999-up FXST, FLST, FXD, 99-16 FLT

**Replacement Chrome Upper Pushrod Cover Kits (Outer).**

Each kit contains 4 chrome clips, 4 springs, 4 cork gaskets, and 4 steel washers.

VT No.	Brand	Fits
<b>7508-20</b>	Colony	Evolution
<b>7508-20T</b>	V-Twin	Evolution
<b>11-0928</b>	V-Twin	Evolution
<b>9970-20</b>	Colony	TC-88, 1999-up FXST, FLST, FXD, 99-16 FLT
<b>11-1206</b>	V-Twin	TC-88, 1999-up FXST, FLST, FXD, 99-16 FLT

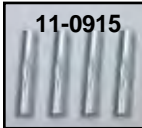

11-0915

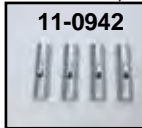

11-0942



11-0917

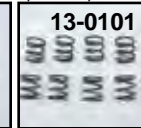

13-0101



12-1157



15-0117



15-0116



11-0908

**Inner Quad Pushrod Covers** in zinc plated steel.

**VT No. Brand**

- 11-0908** V-Twin
- 9213-4** Colony
- 9969-4** Colony, TC-88
- 99-up FXST, FLST, FXD, 99-16 FLT
- 11-9969** V-Twin, TC-88, As above



37-9078



37-9079



11-1073

**Pushrod Cover Cups** feature die-cast construction in chrome or gold, set of four.

VT No.	Item
<b>37-9078</b>	Chrome Skull
<b>37-9079</b>	Gold Skull
<b>11-1073</b>	Brass Hex



37-9078



37-9078



11-0915

**Pushrod Cover Individual Parts**, in chrome steel.

VT No.	Model	U/M
<b>11-0915</b>	1966-99 BT Clip Stock	4
<b>11-0942</b>	1999-up TC-88 Clip	4
	99-up FXST, FLST, FXD, 99-16 FLT	
<b>11-0917</b>	1936-up Cup	4
<b>13-0101</b>	Spring	10
<b>12-0711</b>	Washer, Inner	10
<b>12-1157</b>	Washer, Lower, Evolution	20
<b>15-0117</b>	Large Cork	100
<b>15-0116</b>	Small Cork	100

## Pushrod Seal Kits

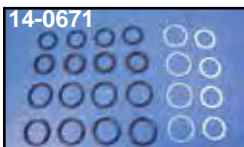

14-0671

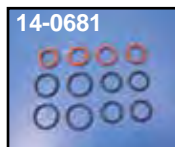

14-0681

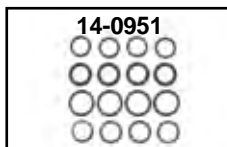

14-0951

**Pushrod Cover Cork-Seal Kits** include enough pieces to seal 4 complete pushrod covers on years listed. Rubber seals.

James	VT No.	Model/Year
<b>14-0671</b>	<b>14-0951</b>	1984-99 Big Twin 1340 Evolution
<b>14-0686</b>	<b>14-0681</b>	TC-88, 99-up FXST, FLST, FXD, 99-16 FLT



**Pushrod Cover Rubber Seal Kit** includes twelve (12) machined rubber seals for Big Twin Evolution. 1984-99.

VT No.	Type
<b>9529-12</b>	Black
<b>14-0981</b>	Blue



**Blue Silicone Seals** are lathe cut, then ground with perfect outside diameter finish, to withstand heat, oil and gas.

VT No.	Item	U/M
<b>14-0028</b>	Small Push Rod	50 pack
<b>14-0029</b>	Large Push Rod	50 pack



**Pushrod Tube Quad Seals and O-Rings.** Quad Seals feature four side seal design, 10 pack.

VT No.	Use	Type	Year	OEM
<b>14-0550</b>	Lower	O-Ring	1984-up	1145
<b>14-0532</b>	Upper	O-Ring	1984-98	1157
<b>14-0803</b>	Upper	O-Ring	1999-up	111293



# Head Bolt & Stud for 1984-99 Evolution

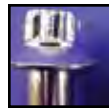
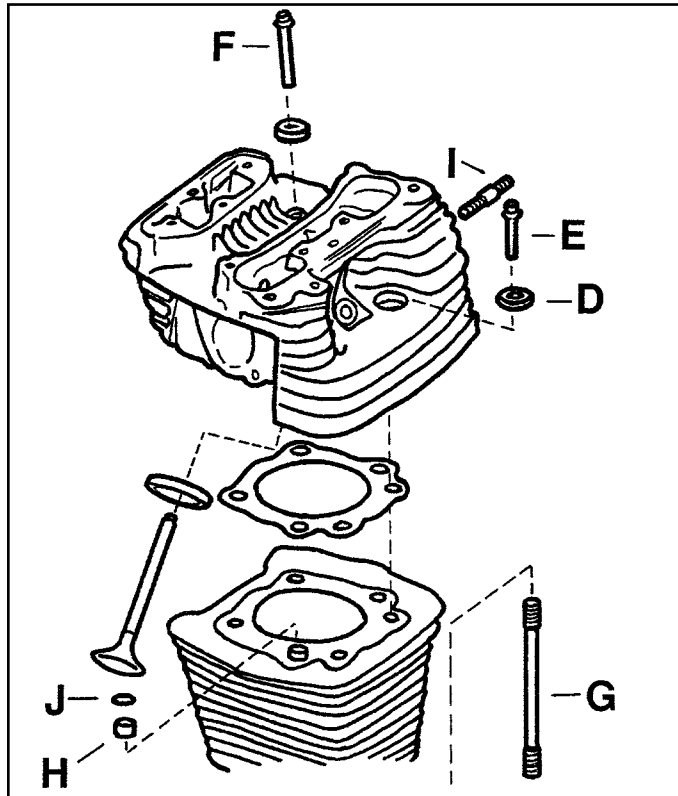

**Chrome 12 Point Head Bolt Set** includes 8 washers and 8 head bolts for 1986-91 FXST, FLST, FLT, FXR, 1986-92 XL and 1991 FXD.  
VT No. 37-9019

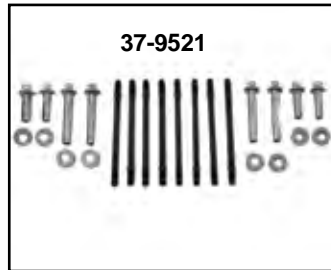

Components for One Head



**Head Bolts and Hardware Kits** for Evolution 1340 models for one head.

VT No.	#	OEM	Item
37-9521*		1986-91	Chrome Head Bolt Stud & Screw Kit
37-9322		As Above	1992-99, zinc
37-8139	E	16478-83	Head bolt, Chrome, 8 pack
	F	16480-83	Screw Set, 1984-Early 1985
2011-8	E	16478-85A	Head bolt, Chrome, 8 pack
	F	16480-85A	Screw set Late 1985-91 Big Twin
2012-8	E	16478-85A	Head Bolt Chrome, Colony, 8 pack
	F	16480-92	Screw Set 1992-up Big Twin
37-8951	G	16837-85A	Studs only, 1986-99 Big Twin 4 pack
9424-8	G	As above	Colony, 1986-99 Big Twin
37-9259	G	As Above	Sifton
37-8935	H	16573-83	Insert, 8 pack
12-1187	I	16715-83	Exhaust Stud, 5 pack
14-0516	J	26432-76	O Ring, 10 pack
37-9074	D	16482-83	Washer 1984-Early 85, Zinc, 4 pack
37-9075	D	16482-85	Washer Late 1985-92, Zinc, 4 pack
37-9265	D	As Above	Chrome, 8 piece
2017f8	D	As Above	Chrome, 8 piece

\*Note: For Both Cylinder Heads

**Sifton Racers Evolution Stud Kit** has 8 inserts, drill tap and 8 chromoly studs. Allows more torque to be applied, to cure oil leaks and protects case threads during frequent disassembly. Detailed instructions included.

VT No.	Item
11-0634	Complete Shop Kit
37-9259	8 Studs only
11-0636	8 Inserts only



**Cylinder Oil Passage Drain Tubes** for stock bore size cylinders only. Each kit is supplied with tap, hex wrench, two drain tubes and instructions. Fits Evolution.

VT No.	Item
16-0911	Kit
16-0912	Pair Replacement Tubes only





# Rocker Box for TC-88

BIG TWIN

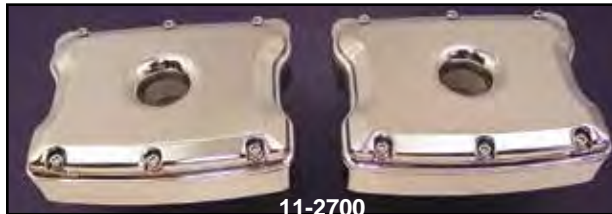

11-2700

**Chrome Rocker Box Set** for TC-88, fits 99-up FXST, FLST, FXD, 99-16 FLT for two heads.

**VT No. Item**  
11-2700 Rocker Box Set  
15-1502 Gasket Set



11-2700 Underside



**Evolution/Twin Cam Head Bolt Cover.** Headbolt covers to hide dull 12 point headbolts. Installation with set screw. Fits 1999-up FXST, FLST, FXD, 1999-16 FLT.

**VT No. Style**  
2024-4 Hex Dome  
2262-4 Spike



11-2701

**Chrome Two Piece Rocker Box Set** for 2 heads for 1984-99 Evolution models. Fit 1999-up FXST, FLST, FXD, 1999-16 FLT.

**VT No. Item**  
11-2701 Rocker Box Set  
15-1503 Gasket Set  
16-1673 Wrench Set



11-0948

**Rocker Box Breather Kit** fits TC-88 model. Replaces 17650-02. Fit 1999-up FXST, FLST, FXD, 1999-16 FLT.  
**VT No. 11-0799**



11-0352



11-0354

**Radii Top Rocker Box Set** for TC-88 models. Fit 1999-up FXST, FLST, FXD, 1999-16 FLT.

**VT No. Type**  
11-0352 Smooth  
11-0354 Contoured

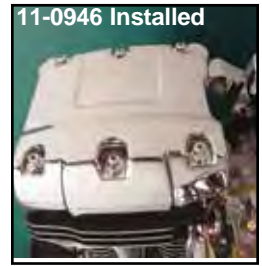

11-0946 Installed

**Rocker Box Set** for TC-88. Includes two upper covers and two lower housings. Fit 1999-up FXST, FLST, FXD, 1999-16 FLT.

**Chrome Black**  
11-0946 11-1086



11-0948



11-1071

**Top End Components** for TC-88. Fit 1999-up FXST, FLST, FXD, 1999-16 FLT.

**VT No. OEM Finish/Item**  
11-0948 17572-99 Chrome Upper Rocker Cover Set  
11-1071 Black Upper Rocker Cover  
11-0584 63815-99 Element  
9944-24 — Allen Screw Kit

11-0584



37-0043



37-0043 Installed



37-0585

**Grooved Valve Cover Screw Cover** for TC-88, Set of 4, match head bolt covers. Fit 1999-up FXST, FLST, FXD, 1999-16 FLT.

**VT No. Item**  
37-0585 Cover Set  
37-1209 Cover Set  
37-0043 16 Piece Chrome Screw Set





# Rocker Box for Evolution

42-0787



42-0754

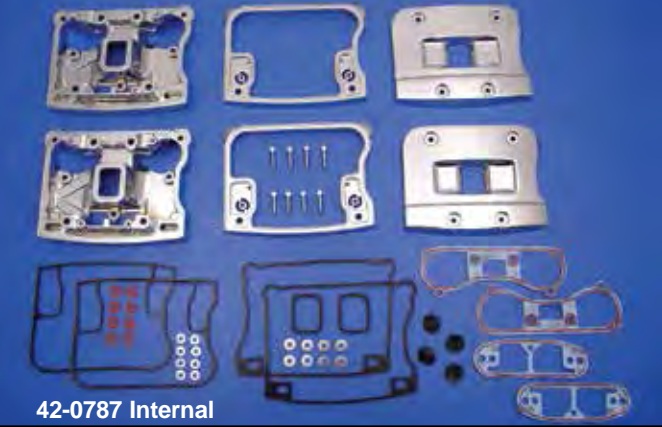

42-0787 Internal

42-0754 Internal

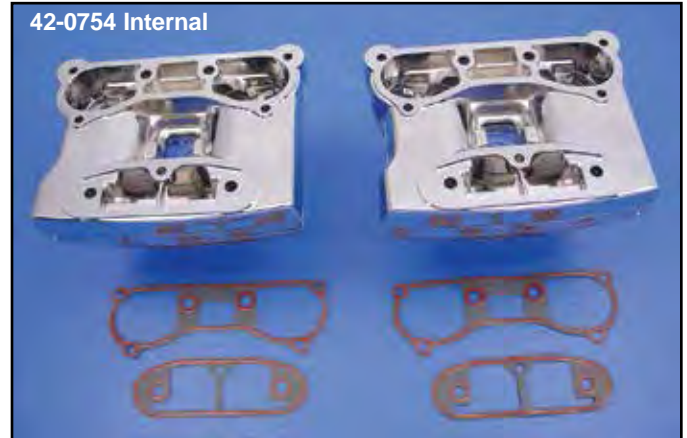

42-0356

11-2701



11-2701 Internal



**V<sup>2</sup> Rocker Box Sets** are precision die-cast covers that are machined. Six piece complete set includes all necessary gaskets for installation for both heads.

Chrome	Black	Fits
42-0754	42-0355	1984-91
42-0787	42-0356	1992-99



**S&S Two Piece Chrome Rocker Covers** fit all 1984-up Evolution Big Twins. Both vented out of the crankcase or through the head type. Umbrella valves included for use with 1993-99 cylinder heads. Each kit includes front and rear cover assemblies complete with base and top cover, rocker shaft supports, gaskets and mounting hardware.

VT No.	Item
11-4050	Rocker Box Set
15-1221	Gasket Set

**Chrome Two Piece Rocker Box Set** for 2 heads for 1984-99 Evolution models.

VT No.	Item
11-2701	Rocker Box Set
15-1503	Gasket Set



**Sifon Evolution Rocker Box Breather Upgrade Kit** includes tap, drill bit, breather tubes and instructions. Fits 1992-99 Big Twin.

VT No.	Item
16-0914	Breather Upgrade Kit
16-1069	Breather Tube Insert Set



16-1069



**Umbrella Valve** fits inner rocker box cover on 1992-99 Evolution.  
VT No. 14-0925

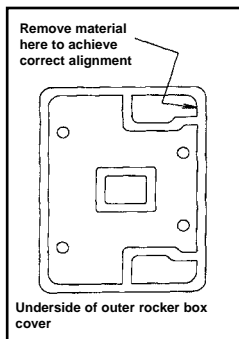
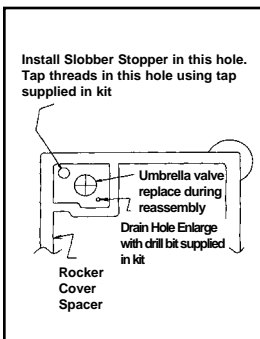



# Rocker Box for Evolution

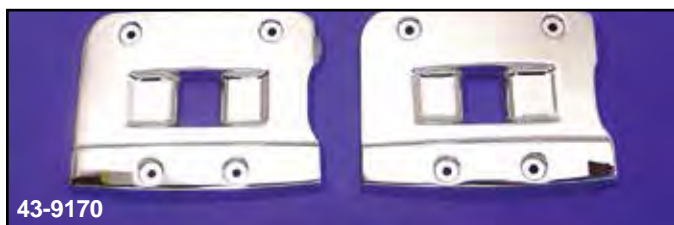

**Chrome Rocker Box Individual Parts** for Evolution Big Twin.

VT No.	Item	Fits
43-9127	D-Ring	1984-91
43-9169	D-Ring	1992-99
43-9146	Lower	1984-91
43-9168	Lower	1992-99
43-9128	Top	1984-91 Smooth
43-9162	Top	1984-91 Chrome
43-9170	Top	1992-99

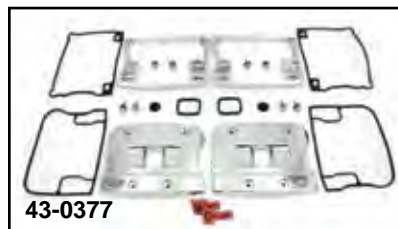

**Chrome Top Cover and D-Ring Set** fits 1984-91. Order gaskets separately.

Chrome	Year
43-9178	1984-91
43-0377	1992-99

## Screw Set



**Chrome Rocker Box Screw Set** fits 1985-99 Big Twin.

VT No.	Type
8868-16	Acorn
9788-24	Button Head Allen



**Evolution Big Twin Lower Rocker Box Mounting Hardware Set** includes all correct bolts, allen screws and washers necessary for bolting lower rocker cover to cylinder head. Complete set for two heads.

VT No.	U/M
11-0621	Set
2078-18	Each



**Rocker Box Screw Kit** for Evolution includes chrome allen screws and washers, and copper sealing washers.

VT No.	OEM	Item
8931-16	Allen Kit	Kit
15-0663*	63858-49	Fibre Washer, 50 pack
15-0221	6114	Copper Washer



**"Tru-Seal" Evolution Rocker Box Chrome Cover Collar and Screw Kit** includes sealing washers with built in O-Ring for position seal.

VT No. 37-0820





# Rocker Arm



**Sifton Roller Rocker Arm Set** features drop forged construction with hardened steel roller. Fitted with bushings at shaft area. Four piece

rocker set. Fits Evolution and TC-88. Order shafts separately. Fits 1984-up FXST, FLST, FXD and 1984-16 FLT.

VT No.	Item
11-0553	Arm Set
11-0571	Shaft Set



**Evolution/TC-88 Rocker Arm and Shaft Kit** by Sifton fits 1984-up Big Twin. Includes two (2) 17375-83 rocker arm, two (2) 17360-83 rocker arm and four (4) 17611-83 shafts. Fits 1984-up FXST, FLST, FXD and 1984-16 FLT.  
**VT No. 11-0572**



**Rocker Arm Shaft** for Big Twins 1984-up. Replaces OEM# 17611-83. Fits 1984-up FXST, FLST, FXD and 1984-16 FLT.

VT No.	Brand	U/M	Size
11-0571	Sifton	4	Standard
11-0576	Jims	4	Standard
11-0814	Sifton	Each	.005 Oversize

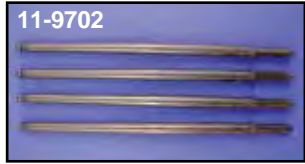

**Rivera Evolution/TC-88 Big Twin Rocker Arm Geometry Kit** includes 4 adjustable rocker arms with bushings which feature oversize swivel foot adjusters, pushrod gauge, pushrod tool and valve stem height gauge. An adjustment of +/- 3° enables absolute correct valve train geometry for the cam being used. Order Taper Lite Pushrod Kit separately. Fits 1984-up FXST, FLST, FXD and 1984-16 FLT.

VT No.	Item
N/A	Rocker Arms Only
11-9702	Taper Lite Pushrod Set



**Big Twin Rocker Arms** include bushings installed to fit TC-88 and Evolution. Fits 1984-up FXST, FLST, FXD and 1984-16 FLT.  
**VT No. OEM Exhaust/Intake**

11-9511	17360-83	Rear, Front
11-9512	17375-83	Front, Rear



**Rocker Arm Bushings** replace 17428-57. Use on 1966-up Big Twin models. Eight pieces.

VT No.	Type
10-0700	Stock Split type
10-2106	As Above, Sifton

# Left Cylinder Base Cover



**Left Side Cylinder Cover** bolts to engine center stud for secure installation. Fits 2007-up FXST.

**VT No. 42-1172**





# Dress Up Kit



### **Evolution Models FXST-FLST, 5-Speed**

- 43-0520** 1987-88
- 43-0521** 1989-91
- 43-0522** 1993
- 43-0523** 1994

### **Evolution Models FLT-FXR, 5-Speed**

- 43-0514** 1985-86      FLT or FXR
- 43-0515** 1987-88      FLT Only
- 43-0528** 1994-98      FLT Only

### **V-Twin™ Chrome Dress Up Kits**

- Include parts and hardware for installation as pictured.
- Kits require removal of engine to install rocker box covers.
- All kits for electric start models unless noted as kickstart and electric. Smooth derby and inspection covers are included on FXST kits. Inspection cover on FXR, FXE, FLT and FLH applications must be purchased separately. **\*Note:** Does not include gasket. 1980-84 kits do not include transmission top cover.

#### **TC-88 FLT 5-Speed**

**42-0692** 1999-2000

**43-0534** 2001-06 includes cam dress cover trim and tappet base cover

#### **TC-88 FXD 5-Speed**

**42-0691** 1999-2000 FXD

**43-0545** 2001-2005 FXD

#### **TC-88 FXST 5-Speed**

**43-0536** 2001-06



# Sifton Valve Spring Kit

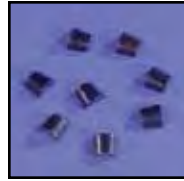
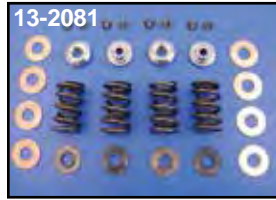

**Sifton Valve Spring Keeper Sets.** Keepers are CNC machined and then heat treated. Fits Evolution/TC-88 1984-04  
**VT No. 11-2096**



**Valve Spring Kits.** Includes all springs, collars and keepers necessary for each application. Fits 1985-04 1340 Evolution/TC-88.  
**VT No. 13-9196**

**All Evolution FX, FL 1986-98**

- 13-2081** 150-160 lb seat pressure, up to .550" valve travel with titanium retainers
- 13-2082** 150-160 lb seat pressure, up to .550" valve travel with heat treated steel retainers
- 13-2083** 150-160 lb seat pressure, up to .550" valve travel with hard anodized retainers
- 13-2080** 170-180 lb seat pressure, up to .600" valve travel with titanium retainers
- 13-2085** 170-180 lb seat pressure, up to .600" valve travel with heat treated steel retainers
- 13-2093** 170-180 lb seat pressure, up to .600" valve travel with hard anodized aluminum retainers
- 13-2140** 170-210 lb seat pressure, up to .800" valve travel with titanium retainers
- 13-2141** 170-210 lb seat pressure, up to .800" valve travel with hard anodized aluminum retainers
- 13-2142** 170-210 lb seat pressure, up to .800" valve travel with heat treated steel retainers



**Valve Springs** include inner and outer as required. Fits 1984-04 Big Twin Evolution/TC-88. Replaces OEM 18201-83.  
**VT No. 13-0104**

**TC-88 1999-2004**

- 13-2022** 170-180 lb seat pressure up to .600" valve travel with titanium retainers
- 13-2060** 190-210 lb seat pressure up to .650" valve travel with titanium retainers

**TC-88 2005-up FXST, FLST, FXD, 2005-16 FLT**

- 13-2061** 170-180 lb seat pressure up to .600" valve travel with titanium retainers



**Valve Keeper Keys** are split type sold in four pairs per package enough for one engine. Fits 1983-04 Evolution and TC-88. Replaces 18229-83.  
**VT No. 11-0805**



**Steel Valve Collars** for 1984-04 1340 Evolution and TC-88.

VT No.	OEM	Use
11-0810	18222-83	Lower
11-0811	18219-83	Upper



**Beehive Valve Spring Kits.**

VT No.	Lift	Fits
13-0650	.600"	1984-2004 FXST, FLST, FLT, FXD
13-0660	.630"	1984-2004 FXST, FLST, FLT, FXD
13-0670	.600"	2005-up FXST, FLST, FXD, 2005-16 FLT
13-0680	.630"	2005-up FXST, FLST, FXD, 2005-16 FLT



# Replica Valve



BIG TWIN

ROWE VALVES					PRECISION MACHINING		
Fully Machined Head					Stainless		
Model and Year	Application	Hard Chrome Stem (1)	Melonite Special Black Stem (2)	Titanium Nitride Gold Coat Stem	Black Diamond (5)	Racing (3)	Razor Back (4)
TC-88 and Evolution 1340cc All Years	Intake 18074-83	—	—	—	11-6002	11-6018	—
	O.S. As above	—	—	—	11-6014	—	11-6087
	Exhaust 18082-83	11-6059	—	11-0802	11-6009	11-6019	—
2005-up FXST, FLST, FXD 2005-16 FLT	Intake 18074-05	—	—	—	11-6119	—	—
	Exhaust 18085-05	—	11-6191	—	11-6120	—	—

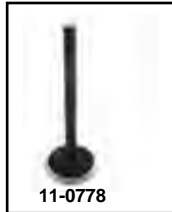

Model and Year Type	OEM	Nitrate Steel
Evolution BT Exhaust	18082-83	11-0778

Valves by Rowe or Precision Machining (Kibblewhite). Intake valves are made of 8645 heat treated valve steel and the exhaust valves are made of 21-2N heat treated non-magnetic stainless steel. These valves are available with the following stems & heads:

- (1) Hard Chromed Stem:** Very slick and hard. The standard in wear resistance.
- (2) Melonite, Special Black Stem:** This is a heat treating process developed and patented in Germany. Gives the valve a Black Smokey look. Very hard and slippery. Currently being used on O.E.M. valves available in Rowe or Black Diamond brands.
- (3) Racing by Kibble White Precision Machining** feature a sharper profile angle to maximize flow, 11-6015 has 2.00 head, 11-6016 has 1.812 head, 11-6017 has 1.780 head, 11-6018 has 1.90 head and 11-6019 has 1.63 head.
- (4) Razor Back by Kibble White** are one piece forged EV-8 stainless steel, fully CNC machined with hard chrome stems.
- (5) Black Diamond:** One piece stainless steel valve with a stellite tip and black nitrone impregnated stem to improve wear properties and reduce friction.

## MANLEY Valves



Manley's "Street Master" Intake and Exhaust Valves feature stainless steel construction, chrome plated stems, hard tips, smooth turned underhead angle and radius, forged combustion dish and machined combustion

face rim. Fits All Evolution/Big Twin and 1999-04 TC-88 (standard overall length).

VT No.	Type	Head Diameter	Stem Diameter	OEM
11-9061	Exhaust	1.615 stock	.3095 stock	18082-83
11-9060	Intake	1.850 stock	.310 stock	18074-83



Manley Stainless Valve machined from 1-piece forging with a swirl polished finish and chrome plated stem. Sold pairs. Fits All Evolution Big Twin and 1999-04 TC-88.

VT No.	Type	Head Diameter	Stem	Diameter	OEM
11-9081	Exhaust	1.615 stock	.3095	Standard	18082-83
11-9086*	Exhaust	1.615 stock	.3095	Standard	18082-83
11-9015	Exhaust	1.650 Oversize	.3095	Standard	
11-9082	Intake	1.850 stock	.310	Standard	18074-83
11-9087*	Intake	1.850 stock	.310	Standard	18074-83
11-9084	Intake	1.940 Oversize	.310	-.060	

\*Note: Nitrate finish.



Manley Valve Related Kit for Evolution models.

VT No.	Item
11-9610	Valve Key Set
11-9228	.600 Lift Kit Titanium
11-9227	.550 Lift Kit Steel

## Valve Seats



Valve Seats can be used with unleaded gas. Replacement size is actual size of seat supplied by V-Twin Number. Stock size is noted as reference only.

VT No.	Fits	Stock Size
11-0641	1340 Evolution	1.948 x 1.632 x .400
	Replacement Size	2.016 x 1.635 x .453
11-0788	1340 Evolution	1.7135 x 1.379 x .400
	Replacement Size	1 3/4" x 1 3/8" x 7/16"

## Valve Shims



Valve Spring Shims for Evolution/TC-88 1985-04 are sold in 25 pack.

VT No.	Width
10-8516	.030
10-8553	.060





# Valve Spring Kits for Evolution/TC-88

VALVE SPRING RETAINERS					VALVE LOCKS			
VT No.	Description	Lock Angle	Valve Stem Size	Valve Spring Diameter	VT No.	Description	Lock Angle	Valve Stem Size
11-7401	Chromoly	10°	All	1.437-1.500"	11-6164	Super Locks +.050 without recess for lock cap	10°	3/8"
11-7411	Chromoly	10°	All	1.500-1.550"				
11-7321	Titanium Double Springs	10°	All	1.500-1.550"				

SPRING KITS INCLUDE SPRINGS, LOCKS, RETAINERS AND LOWER SEATS								
VT No.	Application	Description	Outside	Inner Diameter	Pressure @ Checking Ht.	Pressure @ Opening Ht.	Coil Bind Height	Retainer
11-7702	1984-04 Big Twin	Good Street and Performance Spring up to .600" lift	1.460"	.700"	Lbs-160 In-1.850	Lbs-440 In-1.250"	1.200"	Chromoly
11-7703	1984-04 Big Twin	Good Street and Performance Spring up to .600" lift	1.460"	.700"	Lbs-160 In-1.850	Lbs-440 In-1.250"	1.200"	Titanium
11-7752	1984-04 Big Twin	Super Springs. Street and performance up to .675" lift	1.510"	.745"	Lbs-184 In-1.850	Lbs-422 In-1.250"	1.080"	Chromoly
11-7753	1984-04 Big Twin	Super Springs. Street and performance up to .675" lift	1.510"	.745"	Lbs-184 In-1.850	Lbs-422 In-1.280"	1.080"	Titanium
11-7704	1984-04 Big Twin	Performance Spring up to .675" lift	1.540"	.725"	Lbs-195 In-1.900	Lbs-515 In-1.280"	1.175"	Titanium
11-7705	1984-04 Big Twin	Performance Spring up to .709" lift	1.550"	.710"	Lbs-230 In-1.875	Lbs-700 In-1.200"	1.100"	Titanium



**Andrews High Lift Valve .550+ Springs** fits 1986-04 Big Twin 1340 Evolution and TC-88. Andrews # 294150. No machining required.

**VT No 13-9251**



**Andrews Anodized TC-88 E-Z Install Pushrods** are available in chromoly or aluminum. Installation does not require removal of tank or rocker boxes. Fit 1999-up FXST, FLST, FXD and 1999-16 FLT.

VT No.	Type	Item
11-2188	Aluminum	Pushrods
11-2088	Chromoly	Pushrods
13-9251	High Lift Valve	Springs

# Valve Guide



BIG TWIN

Size	V-Twin Cast Iron		Rowe Cast Iron	Rowe Ampco 45		Precision Machine Cast Iron Shouldered Guide .420 top shortened up to .600"	
	Intake	Exhaust	Intake	Intake	Exhaust	Intake	Exhaust
<b>All Evolution Big Twin and TC-88 1999-2004</b>							
STD						11-1182	11-1188
+.001						11-1183	11-1189
+.002						11-1184	11-1190
+.003	11-0683	11-0683	11-9809			11-1185	11-1191
+.004			11-9810	11-1898	11-1898	11-1186	11-1192
+.006				11-1899	11-1899		
+.008							
+.010							11-1193



<b>Fit TC-88 2005-up FXST, FLST, FXD; 2005-16 FLT</b>				
Size	Precision Machine Ampco 45		Precision Machine Cast Iron	
	Intake	Exhaust	Intake	Exhaust
STD	11-1054	11-1057	11-1060	11-1063
+.001	11-1055	11-1058	11-1061	11-1064
+.002	11-1056	11-1059	11-1062	11-1065

<b>Fit All Evolution Big Twin and 1999-04 TC-88 models</b>						
Size	Precision Machine Ampco 45		Precision Machine Cast Iron		Precision Machine Manganese Bronze	
	Intake	Exhaust	Intake	Exhaust	Intake	Exhaust
Standard	11-1019	11-1019	11-1014	11-1014	11-2316	11-2321
+.001	11-1020	11-1020	11-1015	11-1015	11-2317	11-2322
+.002			11-1016	11-1016	11-2318	11-2323
+.003	11-1022	11-1022	11-1017	11-1017	11-2319	11-2324
+.004	11-1023	11-1023	11-1018	11-1018	11-2320	11-2325

## Valve Seals



Valve Stem Oil Seal Kit includes four pieces of proper guide seal and installation tool. Fits 1985-04 Big Twin. VT No. 16-1745

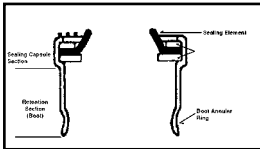

Valve Stem Seals are sold in packs of 10 for years listed. Installation tools and plastic 10 pack sleeves available separately.

VT No.	Fits	Mfg. No.
14-0164	Big Twin 1984-04 Evolution TC-88	1400

16-1751 Sleeve 5/16

### Installation Tools

16-1746 1984-04 Evolution Red

Note: 14-0164 is 5/16



Sifton Valve Stem Seal features a Viton seal with double coil spring for tension, and steel band to secure to guide.

VT No.	Fits
14-0969	1983-2004 Evolution/TC-88
14-0978	TC-88; 2005-up FXST, FLST, FXD; 2005-16 FLT
14-0983	TC-88; 2005-up FXST, FLST, FXD; 2005-16 FLT

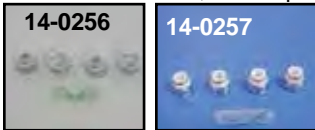

Teflon Valve Stem Seal Set provides maximum valve stem oil control as seals wipe excess oil from the valve stem by means of a unique spring loaded wiper assembly which prevents unwanted oil from reaching and contaminating the cylinder. Machining required.

\*Note: Use with valve guide that a .620 top.

VT No.	Fits	Type
14-0256	1984-04	Crane
14-0257	1984-04	Sifton
14-0260*	1984-04	Crane



### Rowe Unhoned Cast Iron Valve Guides

Intake and Exhaust Guide is the same unless noted.

Size	Evolution Big Dia .300 Shorter with built-in shoulder	Evolution Standard Diameter Top All Evolution	Evolution Big Diameter .200 Shorter	Rowe Iron Tru-Bore Guides I.D. Honed	
				1984-up Evolution, 1999-04 TC-88	1984-up Evolution, 1999-04 TC-88
				Intake	Exhaust
Standard	11-2171	—	—	11-1942	11-1950
.001	—	—	—	—	—
.002	—	—	—	11-1944	—
.003	—	—	—	11-1945	11-1953
.004	—	—	—	—	11-1954
.006	—	11-2110	11-2111	11-1947	—
.008	—	—	11-2113	11-1948	—
Top Diameter	.531	.420	.531	.200"	.200"
Seal#	14-0143	14-0164	14-0143	14-0143	14-0143
Overall Length	2.10"	2.40"	2.20"	2.20"	2.20"

Precision Machining 80" Evolution Ampco 45 Shouldered Valve Guides. Supplied with Viton stem seal that locks into a machined groove on guide. Can be used with up to .600" lift cam.

	Intake	Exhaust
Size	VT No.	VT No.
Standard	11-1044	11-1049
.001	11-1045	11-1050
.002	11-1046	11-1051
.004	11-1047	11-1052
.006	11-1048	





# 103" 2007-2010 Cylinder Kit for TC-96

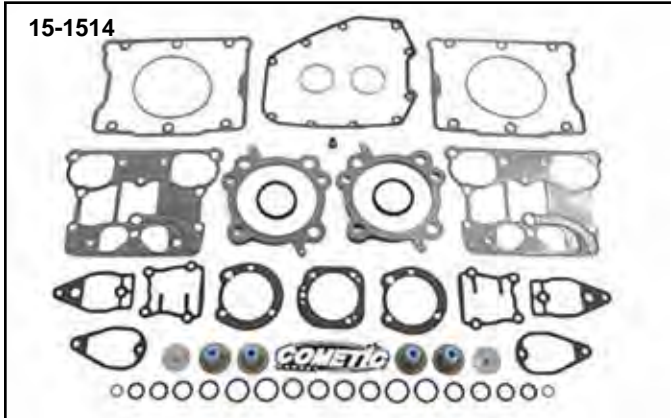

103" TC-96 2007-2010 Cylinder Kits include forged 9:1 or 10:1 Wiseco pistons fitted to cylinder.  
**Black Silver Compression**  
 11-1754 11-1755 9:1  
 11-1752 11-1753 10:1  
 15-1514 Gaskets

**S&S Chrome Rocker Box Cover Set** for TC-88 models.  
 VT No. 11-4105

## TC-88 Hot Setup Kit



**S&S TC-88 Cam, Carburetor, Pushrod and Piston Hot Setup Kit** include Super "E" carburetor, adjustable pushrod set, pushrod covers, 570G cam (.570 lift), cam gear drive set and gear cover gasket kit. Installation of kit requires stock bore cylinders to be bored out to 3 7/8" and will increase compression ratio to 9.7:1 with stock cylinder heads. Order piston kit separately.  
 VT No. 11-0027

**Edelbrock Performance Grommet Mount Intake.**  
 VT No. 35-9285



**95"**



**95" TC-88 Big Bore Kits** available in black wrinkle or silver finish with pistons. These cylinder sets will increase TC-88 engines to 95 cubic inches. No crankcase machining required for installation. Cylinder kits include pistons pre-fitted to cylinders and head gaskets.

10.25:1 Cast	9:1 Forged	Finish
11-0074	11-0880	Black
11-0075	11-0881	Silver
9.3:1 Cast		
11-1575		Black
11-1563		Silver
9.3:1 Cast Chromoly Coated	10.5 Forged	Finish
11-2615	11-0882	Black, Sifton
11-2619	11-0883	Silver, Sifton
Gasket Set		95"
15-0377		



**95" Silver Cylinder Sets.**  
VT No. 11-0073



**MC Forged Piston Sets** for Big Bore cylinders on TC-88. Rings are included.

VT No.	Size	Ring Set (Standard)
—	98"	11-0290
11-0287	107"	11-0291

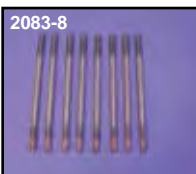

**Colony Cylinder Base Stud Set** fits TC-88.  
VT No. 2083-8

# TC-88 Big Bore Kit



**110"**



**110 Cubic Inch Cylinder Kit** is for 96 and 103 motors to increase to 110 cubic inch. Fit 2007-up FXST, FLST, FXD and 2007-16 FLT.

**VT No. Finish**  
11-1523 Black  
11-1522 Silver

**107"**



**107" TC-88 Big Bore Cylinder Kit** requires case machining and includes forged 10.5:1 piston kit and either silver or black highlighted cylinders.

VT No.	Item
11-1257	Kit, Black
11-1259	Kit, Silver
11-0287	Piston Kit
15-1375	Top End Gasket Kit



**S&S Twin Cam 106" Big Bore Cylinder Kit** can be used with stock cylinder heads and requires no crankcase machining. Available in natural aluminum. Fit 2007-up FXST, FLST,FXD and 2007-16 FLT.  
**VT No. 11-7060**



**TC-88 Big Bore 95" Piston Kits** sold in pairs, include rings, clips and pins, available in flat top 9.3:1 compression ratio or high compression 10.25:1. Order gasket set separately.

Size	9.3:1	10.25:1	Type
Standard	11-0338	—	Cast No Coating
Standard	—	11-0331	Cast
Standard	11-0263	—	Cast, V-Twin, Moly Coated
.005	—	11-0332	Cast
Head Gaskets	15-0376	15-0376	
Top End Kit	15-0377	15-0377	
Standard Ring	11-1354	11-1354	
Pin Lock	11-0856	11-0856	



# Cylinder for 1984-99 Evolution



11-2627



16-2628

**93.4" Cylinder Kit** includes Wiseco 9.5:1 compression piston set with rings pre-fit to new 3.75" cylinders. Cases must be bored to accept this kit.

VT No.	Finish
11-2627	Silver
11-2628	Black
11-1699	Piston Kit



**Big Twin 3 5/8" Big Bore Cylinder Kits** by S&S are supplied with fitted forged flat top pistons, ring, wrist pins, head and base gaskets. Stock crankcases must be machined to accommodate the larger spigot diameter. Available with black or natural finish cylinders. Fit 1984-99 Evolution.

VT No.	Finish	Stroke	Compression	Displacement
11-0086	Silver	4 1/4"	9:1	88"
11-0064	Silver	4 5/8"	9.75:1	96"
<b>VT Pistons</b>				
11-1694	Kit		10.5:1	88"



11-2618

Stock Cylinder Kit  
1340cc bore

**Cylinder and Piston Kits** for Evolution Late 1985-99 1340 cc are honed and pre-fitted with stock compression cast pistons and Hastings Rings. They are ready to run and will require break-in as suggested in the appropriate shop manual. Sold in pairs for stock stroke only. Order gasket set separately.

VT No.	Finish	Compression
11-2618	Black	8.5:1
11-2610	Silver	8.5:1
11-0594	Silver	11:1



11-0345



11-0340

**1340cc Cylinders** to fit Evolution are sold each and include wrist pin, piston and rings except as noted.

VT No.	OEM	Finish
11-0345	16512-86A	Black
11-0340	16510-83A	Silver



Tube Installed



16-0911



16-0912

**Oil Passage Drain Tubes** for stock bore size cylinders only. Each kit is supplied with tap, hex wrench, two drain tubes and instructions. Fit Evolution Cylinder.

VT No.	Item
16-0911	Kit
16-0912	Pair Replacement Tubes only



**Sifton Cylinder Drain Inner Filter** for returning top end oil. Features a stainless steel screen and a ceramic magnet that will stop all ferrous debris from common valve train wear and is most effective in stopping broken valve spring material from entering engines oiling system through cylinder drain. The thin wall steel dowel protects the magnet and provides proper head to cylinder alignment. Fit Evolution.

**VT No. 40-0250**



**83"**



**Bolt-On Cylinder Kit**  
 includes 10:1 compression  
 Wiseco forged piston kit fitted.  
 No case boring required. Fits  
 Evo 83".  
**VT No. Finish**  
**11-1253 Black**  
**11-1258 Silver**  
**11-0156 Piston Set**  
**11-0157 Ring for 1 Piston**

## Bolt-On Cylinder Kit

The Sifton cylinders have a very thick, large outside diameter, "cast in" liner which has been proven to be an important factor to maintain thermal stability which is the ability to retain the important cylinder bore dimension through repeated heat cycles.

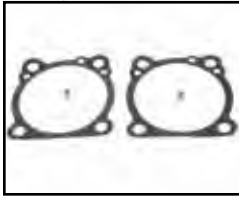

**Oil Fix Kit for Big Twin Evolution** on models includes two cylinder base gas-kets and two oil jet controls which control the oil coming from the head through the barrel and into the case, so the oil does not touch the base gasket thereby not leaking through the base gasket.

**VT No. 15-0597**



**Cylinder Base Sealing Kit** includes two double beaded gas-kets and two cylinder inserts to insure oil return.

**VT No. 15-1288**

## V-Rod Kit



**1320cc Big Bore Kit for V-Rod** includes 12:1 compression forged Wiseco Piston Set with rings and matched 4.250 bore gas-kets and sleeve set. Case boring required.

**VT No. Item**  
**11-0333 Piston and Sleeve Kit**  
**14-0683 O-Ring Set (W6165)**  
**60-0165 Case Boring Service**



**60-0165**

**Cubic Inch =  $\pi r^2 \times \text{Stroke}$**   
 **$r = \frac{1}{2}$  of Bore**

**1 cubic inch = 16.38 cc**

**1 cubic inch = .0163871 liter**



# Big Bore Cylinder for Evolution



**88"**

**11-0094**



**11-0095**



**11-1513**



**11-1513**



**11-0533**

**3/8" Big Bore Cylinder** for Evolution motors with 4 1/4" stroke forged pistons are with Hastings Rings pre-fit in the heavy wall cylinders. Cylinder Sets 3/8" and larger require case boring.

**VT No. Ratio Piston Finish**  
**11-0094 9.25:1 Wiseco Silver**  
**11-0095 9.25:1 Wiseco Black**  
**11-1513 9.25:1 Sifton Silver**  
**60-0165 Machine Crankcase for above cylinder**  
**11-0532 Silver Cylinder, each**  
**11-0533 Black Cylinder, each**  
**11-9948 Sifton Piston**

### CUBIC INCH CHART

**Stock 74 Stock 80**

B O R E	STROKE	3 1/2"	3.968"	4 1/4"	4 1/2"	4 5/8"	4 3/4"	5.00"
	3 5/16"	61"						
3 7/16"	64.8"	73.7"	78.7"	83.4"	85.7"	88.0"	92.8"	
3 1/2"	67.2"	76.3"	81.6"	86.6"	89.0"	91.4"	96.1"	
3 5/8"	72.1"	81.7"	87.4"	92.9"	95.5"	99.0"	103.2"	
3 11/16"	74.6"	84.7"	90.7"	96.1"	98.8"	101.5"	106.8"	
3 13/16"	79.9"	90.6"	97.0"	102.8"	103.7"	108.9"	114.2"	
3 7/8"	82.3"	93.4"	100.1"	100"	108.9"	111.9"	117.8"	
4.00"	87.9"	99.7"	106.8"	113.0"	116.1"	119.3"	125.6"	
4 1/8"	93.4"	106.0"	113.5"	120.2"	123.5"	126.9"	133.6"	
4 1/4"	99.2"	112.6"	120.5"	127.6"	131.1"	134.7"	141.8"	





# Piston Kit



**V-Twin Piston Kits** include 2 cast alloy pistons, genuine Hastings 3-piece ring set, 2 wrist pins and 4 circlips. **OHV Piston Set use 22588-78 pin lock, VT No. 12-0929 Standard Comp**

Size	1340cc V2 Evolution Stock Stroke 8.5:1 Comp	3 5/8" Big Bore Evolution Stock Stroke 9.25:1 Comp	3 5/8" Big Bore Evolution 4 5/8" Stroke 9.75:1 Comp
Standard	11-0231	11-9949	11-1709*
.005	11-0292		
.010	11-0293		
.020	11-0294		
.030	11-0295		
.040	11-0296		

\*Note: Rings Only 11-0859



# Moly Piston Kit



**MC Moly Coated Piston Kits** feature cast construction with moly (moS2) coating which helps reduce friction and wear, while allowing adequate break in. Hastings Moly Rings Set, wrist pins and locks included. \*Note: Rings only 11-0859

Size	1340 Evolution 1984-99 Stock Stroke 8.5:1 Comp	1340 Evolution 1984-99 Stock Stroke 11.1:1 Comp	Evolution 3 5/8" 1984-99 4 5/8" Stroker 9.75:1 Comp
Standard	11-0279	11-1702	11-9948*
.005	11-0280	11-1704	—
.010	11-0281	—	—
.020	11-0282	—	—

**Wrist Pin Locks**, 10 pack.  
VT No. OEM Years  
12-0949 22589-83 1983-99

**Wrist Pin and Lock Kit**  
VT No. OEM Fits  
11-0871 22764-83 1985-99 Evolution



# HASTINGS® The Original Ring Leader®

Over 250,000 Sets Served!

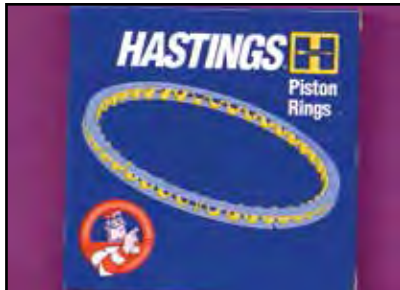

Hastings Piston Ring Sets are replacements for OEM ring sets and will also fit our cast pistons. Available in standard and oversized versions with either a cast or moly compression ring and 3-piece oil control ring. Sold in sets for two pistons.

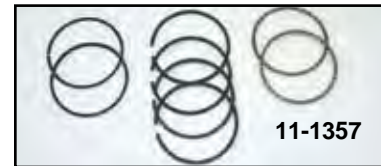

80" FL-FX Evolution 1340cc		
Mfg. #	6164 Cast	2M6164 Moly
Standard	11-0190	11-1357
.005	11-0191	11-1358
.010	11-0192	11-1359
.020	11-0193	11-1360
.030	11-0194	11-1361
.040	11-0195	11-1362



Hastings Patch.  
VT No. 48-1479



88" Twin Cam; 1999-06 FXST, FLST, FXD, FLT		
Mfg#	Cast	Moly
Standard	—	11-1350
.005	—	11-1351
.010	—	11-1352
.020	—	11-1353
95" Big Bore Twin Cam		
Mfg. #	Cast	Moly
Standard	—	11-1354
.005	—	11-1355
.010	—	11-1356
96" Twin (1584cc) 2007-up FXST, FLST, FXD, 2007-16 FLT		
Mfg#	Cast	Moly
Standard	—	11-1397
.005	—	11-1398
.010	—	11-1399

### SHOP TIP Piston Installation

**Caution:** Do not install piston pin without lubricating it first with motor oil or assembly lube. Touch up outer edges of piston pins with emery cloth before installation.

1. Refer to applicable service manual for proper installation methods.
2. Piston should be measured front-to-rear at the base of piston skirt, perpendicular to wrist pin.
3. Piston should be set-up with the following tolerances:

Recommended piston/cylinder running clearances:	Minimum	Maximum	Preferred
Evolution® Models (Aluminum Cylinders)	.0015	.0022	.002
Big Twin Models (Cast Iron Cylinders)	.0015	.003	.0025
Sportster Models (Cast Iron Cylinders)	.003	.004	.0035

Specifications for ring end-gap are supplied with the ring sets and vary by type and size.

**Note:** Run engine at moderate speeds for at least 500 miles, avoiding excessive running in lower gears, in order to properly break in new pistons and rings.

# WISECO Forged Piston Kit



BIG TWIN

2007-up TC-96 Piston Kits fits 2007-up FXST, FLST, FXD and 2007-16 FLT						
1691cc 9:1 Compression 3.875" Bore						
	Standard	.005	.010			
Piston Kit	11-1011	—	—			
Wiseco Rings	11-9923	11-9924	11-9925			
1691cc 9:6:1 Compression 3.875" Bore						
	Standard	.005	.010			
Piston Kit	11-1214	11-1215	11-1216			
Wiseco Rings	11-9923	11-9924	11-9925			
1691cc 10.5:1 Compression 3.875" Bore						
	Standard	.005	.010			
Piston Kit	11-1012	11-1261	—			
Wiseco Rings	11-9923	11-9924	11-9925			
1999-up TC-88 Piston Kits fits 1999-06 FXST, FLST, FXD, FLT						
1448 cc 10.5:1 Compression 3 3/4" Bore						
	Standard	.005	.010	.020	.030	
Piston Kit	11-9928	—	—	—	11-9932	
Wiseco Rings	11-9933	11-9934	11-9935	11-9936	11-9937	
1550cc Big Bore Kit 9:1 Compression 3.875" Bore, 4" stroke						
Piston Kits include Hastings X Ring Pack						
	Standard	.005	.010	.020		
Piston Kit	11-9938	—	11-9940	11-9944		
Wiseco Rings	11-9923	11-9924	11-9925	11-9926		
1550cc Big Bore Kit 10.5:1 Compression 3.875" Bore, 4" stroke						
Piston Kits include Hastings X Ring Pack						
	Standard	.005	.010	.020	.030	
Piston Kit	11-9918	11-9919	11-9920	11-9921	11-9922	
Wiseco Rings	11-9923	11-9924	11-9925	11-9926	11-9927	
1984-99 Evolution Piston Kits						
1340cc 8.5:1 Stock Compression 3 1/2" Bore. Piston Kits include Hastings X Ring Pack.						
	Standard	.010	.020	.030	.040	
Piston Kit	11-9830	11-9831	11-9832	11-9833	11-9834	
Wiseco Rings	11-9759	11-9762	11-9760	11-9764	11-9765	
1340cc 10:1 Compression 3 1/2" Bore. Piston Kits include Hastings X Ring Pack.						
	Standard	.005	.010	.020	.030	.040
Piston Kit	11-9895	11-9896	11-9897	11-9898	11-9899	11-9900
Wiseco Rings	11-9759	11-9901	11-9762	—	11-9764	11-9765
1340cc 11:1 Compression 3 1/2" Bore Piston Kits include Hastings X Ring Pack.						
	Standard	.005	.010	.020	.030	.040
Piston Kit	11-9840	—	—	—	—	11-9845
Wiseco Rings	11-9759	11-9901	11-9762	11-9760	11-9764	11-9765
1340cc 9.25:1 Compression 3 3/4" Bore Stock Stroke. Includes head and base gasket. Achieves 88 cubic inch. Piston Kits include Hastings X Ring Pack.						
	Standard	.005	.010	.020	.030	
Piston Kit	11-9903	—	—	—	—	
Wiseco Rings	11-9908	11-9909	11-9910	11-9911	11-9912	
1340cc 3.75" Bore, 93.4"						
1340cc 9.5:1 Compression 3 3/4" Bore Stock Stroke achieves 93.4 cubic inch. Piston kits include Hastings X Ring Pack.						
	Standard	.005	.010	.020	.030	
Piston Kit	11-1699	—	—	—	—	
Wiseco Rings	11-9971	—	—	—	—	



Note: All Wiseco Rings are sold per piston.



**Wiseco Replacement Circlips** fit all Wiseco pistons, available in pairs.

VT No. Bore  
11-9773 3 7/16" & 3 1/2"  
11-9774 3 3/4"

**Wiseco Replacement Wrist Pins** are sold each.

VT No. Bore  
11-9778 3 1/2"  
11-9981 3 3/4"



## KB PERFORMANCE PISTONS

The Keith Black 390 Hypereutectic alloy is cast in a permanent steel mold which makes it possible to build a light weight piston that makes more power and uses less fuel and lasts longer than any other type of piston being made today. We can now forget about running loose, noisy, oil-burning pistons. The low heat transfer of the alloy keeps the skirts cool so piston expansion is minimal. Test engines have run with as little as .0005" (1/2 thousandth) piston-to-wall clearance. The combination of a low heat transfer piston alloy and high compression ring placement increases power and economy. The high ring placement alone reduces detonation and increases the top ring temperature. It is important to see our ring end gap instructions to avoid ring butting.

The KB piston will make maximum power at 2 to 4 degrees less total timing than conventional pistons. All KB piston sets are supplied with Hastings Moly Ring sets. Safe top ring end gaps can be found by multiplying the bore diameter by the appropriate ring end gap factor from the adjoining chart.

**Example:** 3.5" bore "Street Normally Aspirated" = 3.5" bore x .0065" = .023" top ring end gap.

**Note:** Second ring end gaps do not need extra clearance

Engine Model	1340cc Evolution FLH-FX	1340cc Evolution FL-FX	1340cc Evolution FL-FX	TC-88 FL-FX 1999-06	TC-88 FL-FX 88"	TC-88 FL-FX 2007-up
Years	1984-up	1984-up	1984-up	1999-06	88"	2007-up
C.I.D.	80"	80"	80"	88"	3.750"	FXST, FLST, FXD, 2007-16 FLT
Bore	3.498	3.498	3.498	3.750"	4.00"	95"
Stroke	4.250"	4.250"	4.250"	4.00"	4.938"	3.875"
Cylinder	5.550"	5.550"	5.550"	4.938"	10.6:1	4.00"
Height	8.6:1	9.6:1	10.5:1	8.8:1		9.3:1
Comp. Ratio						
Standard	11-2216	11-2257	11-2222	11-2264	11-2269	11-2274
.005	11-2217	11-2258	11-2223	11-2265	11-2270	11-2275
.010	11-2218	11-2259	11-2224	11-2266	11-2271	11-2276
.020	11-2219	11-2260	11-2225	11-2267	11-2272	11-2277
.030	11-2220	11-2261	11-2226	11-2268	11-2273	11-2278
.040	11-2221	11-2262	11-2227	—	—	—

APPLICATION	RING END GAP FACTOR	PISTON TO WALL CLEARANCE
Street Normally Aspirated	.0065"	.00075"-.0015"
Street Nitrous or Supercharged	.0080"	.0015"-.0025"
Flat Track Gasoline	.0080"	.0010"-.0030"
Flat Track Alcohol	.0060"	.0010"-.0030"
Drag Gasoline	.0075"	.0010"-.0030"
Drag Alcohol	.0065"	.0010"-.0030"
Drag Supercharged or Nitrous Gas	.0095"	.0015"-.0030"
Drag Supercharged Alcohol	.0085"	.0010"-.0030"
Drag Supercharged Fuel	.0115"	.0020"-.0040"





# Cylinder & Base Gasket



16-0911



VT No. 16-0911  
Tube Installed

16-0912

**Oil Passage Drain Tubes** for stock bore size cylinders only. Each kit is supplied with tap, hex wrench, two drain tubes and instructions. For Evolution Cylinder.

**VT No. Item**

16-0911 Kit

16-0912 Pair Replacement Tubes only

**GB Three Piece Rubber Coated Gaskets.** A three piece design that features a stainless center sandwiched between two rubber coated stainless spring steel outer layers. The outer layers are embossed at the oil drain hole and cylinder bore area that provides a correct seal. Sold in pairs. Fits Evolution Big Twin.

**Cylinder Base Gaskets**

1984-99 Big Twin

Size	3 1/2" Bore	3 5/8" Bore	3 13/16" Bore	3 3/4" Bore
.010	15-0483	15-0485	—	—
.020	15-0484	15-0486	—	—



**Head Gaskets**

1984-99 Big Twin

.030	15-0475	15-0477	15-0479	15-0481
.040	15-0476	15-0478	15-0480	15-0482

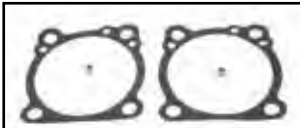

**Oil Fix Kit for Big Twin Evolution models**

includes two cylinder base gaskets and two oil jet controls which control the oil coming from the head through the barrel and into the case, so the oil does not touch the base gasket thereby not leaking through the base gasket.

**VT No. 15-0597**



15-0475



15-0483



15-0389

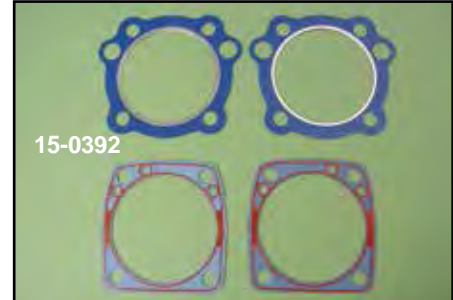

15-0392

**GB Head Base Gasket Set** for Evolution with .040 head gasket.

**VT No. Base**  
15-0389 Metal  
15-0392 Beaded



15-1072

**Metal Cylinder Base Gasket** has a steel base metal which has been coated on both sides with a specially formulated high temperature oil resistant rubber compound. Silicone beading around the inner and outer perimeter forms a seal on both sides of gasket, pairs. Available from James.

**VT No. Fits**

15-1072 Evolution Big Twin

15-1101 Evolution 3 5/8" Big Twin

## Cam Cover



15-0659

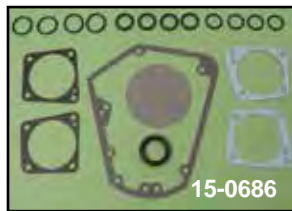

15-0686

**Quick Change Cam Gear Gasket & Seal Kit** fits Shovelhead and Evolution motors, includes both cork and quad seals for pushrods to fit all year range.

**James GB Fits**

15-0871 15-0659 1970-92 Big Twin

15-0872 15-0686 1993-99 V<sup>2</sup> Big Twin

— 15-1214 TC-88, 1999-up FXST, FLST, FXD, 1999-16 FLT.

## Head and Base Gasket

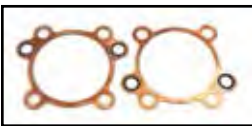

**Parker Gasket by Rivera** for Evolution 1340 Cylinder Head Gasket features

full copper construction and integral O-Ring at critical areas, using the principle of controlled compression when the cylinder base and head is torqued down the metal maintains the correct diameter between the surfaces requiring sealing while the boned flexible sealing material completes the seal. The base gasket is metal with an integral seal of Viton molded to the metal gasket. Sold in pairs for base or head. 3 5/8" head.

**VT No. 15-0731**

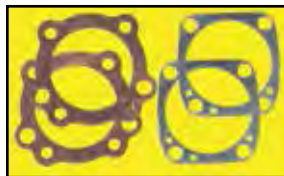

**GB Head/Base Gasket Set** has .040 special copper head gaskets and .007" thick aluminum base gaskets, will not compress or torque. Kit includes two head and two base gaskets.

**VT No. Fits**

15-0312 1984-99 Evolution 80"

15-0314 Sidewinder Big Twin Evo

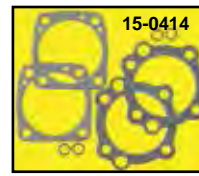

15-0414

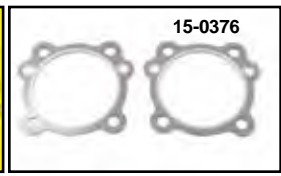

15-0376

**Cylinder Head/Base Gasket Set.**

VT No.	Year	Bore	Thick	Brand
15-0414	1984-99	Standard	.045"	James
15-0877	1984-99	3 5/8"	.062"	James
15-0376*		9.3:1	3.935	
15-1234	4" S&S	4"	.045"	James
15-1235*	TC-88	Standard	.045	James
15-1293*	TC-88	Standard	.045	GB

\*Note: 1999-up FXST, FLST, FXD, 1999-16 FLT.





# Top End Gasket Set

BIG TWIN

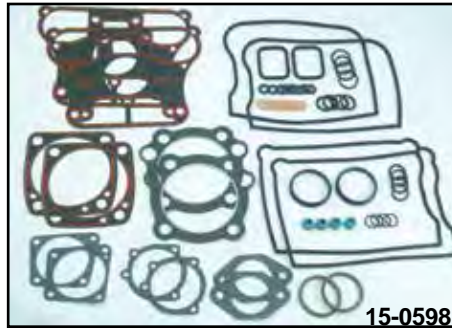
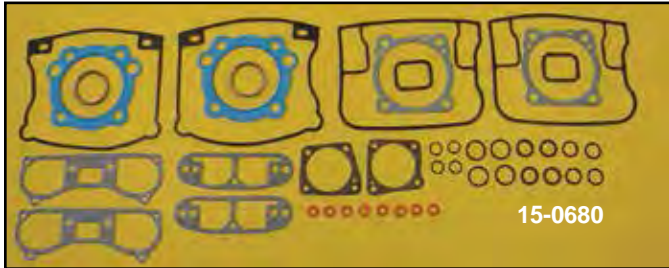
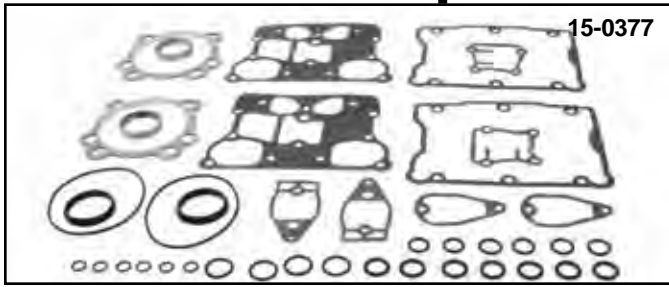

**GB Top End Kits** include all gaskets and O-rings including pushrod corks from the cylinder base and up. Perfect for piston and valve jobs.

VT No.	OEM	Years	Fits
15-0598	17033-83	1984-91	V2 Evolution
15-0680	17040-92A	1992-99	V2 Evolution
15-0377	17052-99	1999-up	TC-88

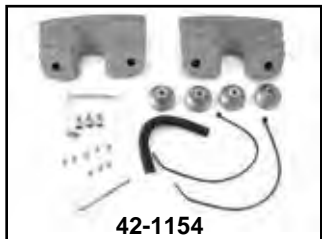
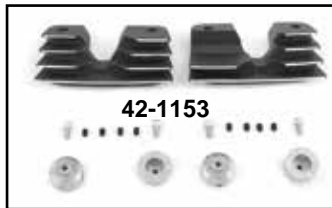

**Head Bolt Bridge. Bolts on!**

	Silver	Black	Model
42-1152	42-1153		EFI
42-1154	42-1155		Carb
42-1159			EFI

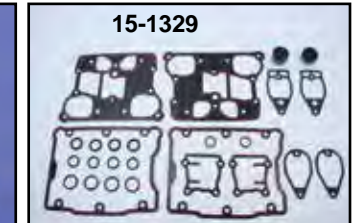
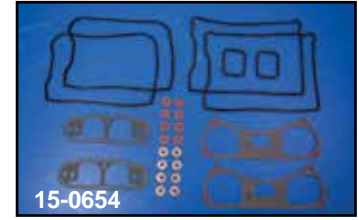
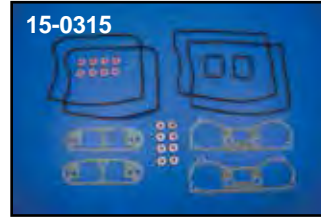

**Rocker Box Gasket Kits** include upper and lower gaskets in Cork or Molded O-Ring type with bolt seals and washers for both heads.

James	GB	OEM	Type	Fits
15-0845	15-0315	17033-83R	Cork	84-91 1340 Big Twin
15-0847	15-0654	17038-90	O-Ring	84-91 1340 Big Twin
15-0848	14-0932	17042-92	O-Ring	92-99 1340 Big Twin
15-1210*	15-1329*	—	O-Ring	99-up Twin Cam
15-1221	—	—	O-Ring	S&S Two Piece Rocker Covers

\*Note: 1999-up FXST, FLST, FXD and 1999-16 FLT

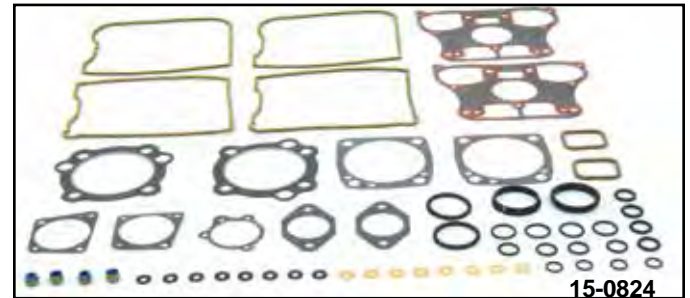

## James Top End Sets

VT No.	OEM	Years	Models
15-0824	17033-83	1984-91	Evolution
(Teflon Head Gaskets/Cork Rocker Gaskets)			
15-0859	17033-83A	1984-91	Evolution
(.045" Teflon Head Gaskets/Rubber Rocker Gaskets)			
15-1191	—	1984-91	Evolution 3 5/8" Big Bore
(.045" Head Gaskets /Steel Base/Rubber Rocker Gaskets)			
15-0825	17040-92A	1992-99	Evolution
(.045" Head Gaskets/Rubber Rocker Gaskets)			
15-1192	—	1992-99	Evolution 3 5/8" Big Bore
(.045" Head Gaskets/Rubber Rocker Gaskets)			
15-1209	17052-99	1999-04	TC-88/96"
(.045" Fire Ring Head Gaskets/Rubber Coated Rocker Cover Gaskets)			
15-1343	17052-99 MLS	1999-04	TC-95/103"
(.040" MLS Head Gaskets/Rubber Coated Rocker Cover Gaskets)			
15-1344*	17052-05	2005-up	TC-88
(.045" Fire Ring Head Gaskets/Rubber Coated Rocker Cover Gaskets)			
15-1345*	17054-05 MLS	2005-up	TC-88
(.040" Fire Ring Head Gaskets/Rubber Coated Rocker Cover Gaskets)			

\*Note: 2005-up FXST, FLST, FXD and 2005-16 FLT

**Fits**

1999-up FXST, FLST, FXD, 1999-16 FLT
1999-06 FXD, FXST, FLST, FLT
1999-up FXST, FLST, FXD, 1999-16 FLT



# Complete Big Twin Gasket Set

**GB™ Complete Gasket Kits** are produced of the finest materials and include all of the gaskets, seals and O-rings necessary to rebuild each model listed. Models which require quad pushrod seals include the genuine quad type. Head gaskets are Teflon, all other components are stock replacement type.

**Fits Big Twin Evolution**

**GB Complete Engine**

VT No.	OEM	Years	Fits
15-0513	17035-83A	1984-88	4 and 5-Speed FXST
15-0638	17035-84B	1984-88	5-Speed FXR/FLT
15-0529		1989-91	5-Speed FXR/FLT
15-0518	17035-89	1989-91	5-Speed FXST
15-0679*	17041-92A	1992-99	All Twins

\*Note: Does not include primary side gaskets



15-0513



15-0638



15-0529



15-0518



15-0679

## Motor Gasket Sets



15-1169



15-1208

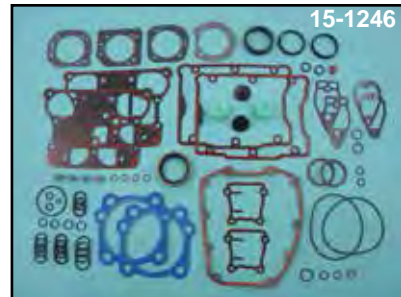

15-1246

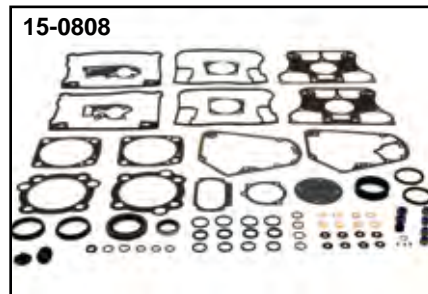

15-0808

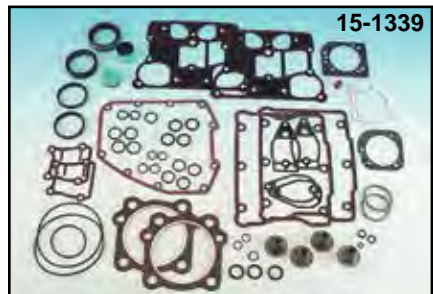

15-1339

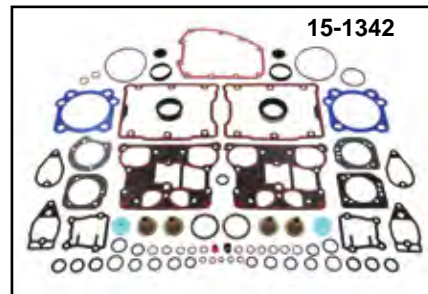

15-1342

**James Complete Motor Gasket Sets** do not include primary gasket or seal.

VT No.	OEM	Years	Models
15-1169	17035-83B	1984-91	Big Twin (Rubber Rocker Gaskets/.062" Teflon Head Gaskets)
15-0808	17041-92A	1992-99 V <sup>2</sup>	Big Twin (Rubber Rocker Gaskets/.062" Teflon Head Gaskets)
15-1208	17053-99	1999-2004	TC-88 Big Twin (Includes. 046" Fire Ring Head Gaskets)
15-1246	17055-99	1999-2004	TC-88 1550 Big Bore (Includes. 046" Fire Ring Head Gaskets)
15-1339*	17053-05	2005-up	TC-88/96 (Includes. 045" Fire Ring Head Gaskets)
15-1340*	17053-05	2005-up	TC-88/96 (Includes. 036" Fire Ring Head Gaskets)
15-1341*	17055-05	2005-up	TC-95/103 (Includes MLS Head Gaskets)
15-1342*	17055-05	2005-up	TC-95/103 (Includes .036" Teflon Coated Head Gaskets)

\*Note: 2005-up FXST, FLST, FXD and 2005-16 FLT





# 6-Speed Conversion

BIG TWIN



**1986-99 Softail 6-Speed Conversion Kit** includes complete assembled 6 Speed transmission with chrome mount plate, chrome top and chrome end cover, chrome inner and outer primary covers, full clutch pak and 1.7 kw chrome and polished starter with shaft assembly. Right Side Drive kits include hydraulic clutch side cover. Transmission accepts electric speedometer sensor (not included).

<b>Right Side Drive</b>	<b>Left Side Drive</b>	<b>Case</b>
—	<b>17-0036</b>	Black
<b>17-0778</b>	—	Polish



**Replacement 6 Speed Gear Set** includes all parts pictured. Fits 6-Speed V-Twin Transmission Only. Fits 1986-2006 FLST.

<b>VT No.</b>	<b>Type</b>
17-0462	Complete
17-0473	Partial



## 6 Speed Transmissions



**Motor Shop Ready 6-Speed FXST Polished Transmission Assembly** for 1991-99 models. Features include either polished case, chrome top and side cover, machined shift forks, heavy duty trap door, precision ground full width gears with back cut dogs and pulley. Each unit is completely factory assembled to OEM specs. Unit is close ratio 1st gear 2.94:1 overdrive 6th gear .86 :1. Accepts 1996-up speedometer sensor VT No. 17-0561.

**VT No. 17-0453**





# 5-Speed Transmission



**5-Speed Transmissions** feature stock style case. FXST solid mount style with full assembled internals. Top and late style clutch release cover are chrome. **Note:** Choose clutch pack for mainshaft and 5th gear for appropriate years. 17-0003 features natural case finish.

VT No.	Mainshaft/5th
17-0003	1991-93 FXST
17-0014	1996 FXST



**5-Speed Transmission** fits 1991-94 FXR.

- Features stock style cases in FXR rubber mount style with full assembled internals.
- Top and late style clutch release covers are chrome.
- **Note:** Both Mainshaft and 5th gear year, to choose appropriate clutch pack.

**VT No. 17-0009**

# Right Side Drive 6-Speed Transmission

**Motor Shop Ready York 6-Speed FXST Right Side Drive Transmission Assembly** with hydraulic or cable clutch for 1991-99 models. Features include either polished, natural or black wrinkle finish case, chrome top and side cover, full width gears, machined shift forks, heavy duty trap door, precision ground gears with back cut dogs and pulley. Each unit is completely factory assembled to OEM specs. Unit is stock ratio 1st gear and overdrive 6th gear .86 :1. Accepts 1996-up speedo sensor 17-0561. Order hydraulic clutch handle assembly and hydraulic line separately. RSD is the only way to make a balanced big tire, big horsepower creation. Uses a 10 mm banjo bolt on hydraulic line with a 1/16" master cylinder.

Hydraulic	Cable	Case Finish
17-0454	17-0470	Black
17-0455	17-0471	Natural
17-0456	—	Polished
18-0672	—	Hydraulic Handle



# Mount Plates



**1986-99 Softtail 5-Speed Chrome Transmission Plate Kit** includes chrome transmission mount plate with chrome installation hardware.

VT No.	Item
17-9994	Kit
<b>Bolt Kits</b>	
9867-18	Zinc
9866-18	Chrome
9866-18T	Chrome

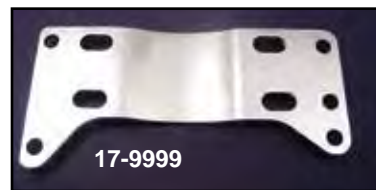
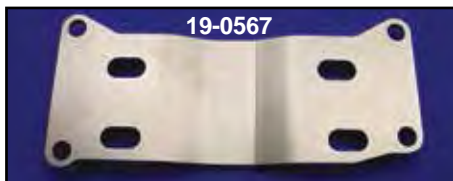

**Offset Transmission Plates** fit 5 or 6 speed Softtail transmissions.

VT No.	Offset
19-0565	1/4"
19-0566	3/4"
17-0859	1"

**Chrome Steel Transmission Mount Plates.**

VT No.	OEM	Fits	Finish
17-6651	Custom	Fits Rigid mount 5-Speed Transmission in 4-Speed, Frame	Zinc
17-6658	Custom	Fits 4-Speed Transmission in 5-Speed, Frame	Chrome
17-9999	Stock	1986-99 FXST-FLST	Chrome

# 5-Speed Gear Box



**5-Speed Stock OE Gear Box** includes both left side bearings and one seal. Will accept original components. Fits 1986-88 FXST, silver. Replaces 34731-86. **VT No. 43-9097**



**Side Cover Stud** fits 5 and 6-Speed to mount exhaust or other brackets. Stud has  $\frac{5}{16}$  — 18 threads both ends. 5 pack. **VT No. 37-0958**

**Sifton Big Twin Billet Transmission Door** fits 5-Speed models 1987-99, and includes bearings pressed in with appropriate retaining rings.

VT No.	Years	Item	Type
17-9956	1987-99	Complete	5-Speed
17-9946	1987-99	Door Only	5-Speed
17-9940	1979-86	Door Only	6-Speed
17-8300	2006/07-up	Door Only	6-Speed FXD/Softail only



**Transmission Mount Case Studs** are heat treated as original. Available in set of 4 for 1984-up 5-Speed.

VT No.	OEM	Brand
12-1197	11733	V-Twin
9863-5	11733	Colony



**Magnetic Drain Plugs** prevent metal particles from circulating through engine and transmission cases, oil tank, etc.

VT No.	OEM	Size	Use
37-0096	707	$\frac{1}{2}$ — 13	74 Transmission
37-0097	700	$\frac{3}{8}$ — 24	Big Twin Case Plug 74 and 80
37-0095	60348-65A	$\frac{1}{2}$ — 20	74 & 80 Inner Primary
37-0098	720, 706A	$\frac{5}{8}$ — 18	Oil Tank & Time Hole
37-8934	734-739	$\frac{1}{8}$ — 27	NPT 1987-89 Big Twin Primary Transmission, FXST-FXR
37-0099	739A	$\frac{1}{8}$ — 27	NPT 1990-up Big Twin Transmission
37-9242		$\frac{1}{8}$ — 27	As Above with Hex
37-8961	718	$\frac{1}{4}$ — 18	NPT Chain Cover
37-9217	722	$\frac{5}{8}$ — 18	FXR Drain
40-0498	60328-98A		2001-up Softail Tank



**13 in 1 Folding Tool Kit.**  
**VT No. 16-0078**



48-0498  
80" UL



48-0470  
Knucklehead



48-0030  
1340 cc



48-0033  
Dual Cam



48-0025  
Panhead



48-0044  
Shovelhead



48-0048  
Shovelhead



48-0372  
XLCH 1971



48-1824  
45"

**Motor Plaques** measure 18" x 24" and are made of metal. **Motor Plaque Set** includes 9 plaques. **VT No. 48-1811**





# 5-Speed Big Twin Transmission



VT No.	OEM	#	Item
12-1178	601	1A	Roll Pin
17-0512	3784	1	Set Screw Fork
37-9195	6016	2	Washer 11/32" x 11/16" x 1/16"
12-0562	7515	3	Jam Nut 7/16" x 1/4" x 11/16"
12-0938	11016	5	Retaining Ring, 10 pack
12-0948	11083	6	Retaining Ring, 1979-99
12-0992	11319	6	Retaining Ring, 2000-up
N/A	9114	7	Right Cam Shifter Bearing
N/A	9115	8	Left Cam Shifter Bearing
17-9854	33119-79B	9	Adjusting Screw Shifter Arm
17-9855	Set	10	8 Pieces, 1 Each Thrust Washer Assortment
17-0530	33205-80	10	.017 Shift Thrust washer
17-0531	33206-80	10	.020 Shift Thrust washer
17-0532	33207-80	10	.022 Shift Thrust washer
17-0533	33208-80	10	.025 Shift Thrust washer
17-0534	33209-80	10	.028 Shift Thrust washer
17-0535	33210-80	10	.031 Shift Thrust washer
17-0536	33211-80	10	.035 Shift Thrust washer
17-0537	33212-80	10	.039 Shift Thrust washer
37-9134	3993	11	Bolt 1/4"-20 1 1/4" Hex Head
37-9135	6736	12	Washer 9/32" x 5/8" x 1/16"
17-0597	33320-98	13	Shifter Cam
17-0514	33332-79	14	Support Shifter Cam Right
17-0515	33326-79A	15	Support Shifter Cam Left, each
21-2057	34084-86	16	1986-up Lever, Shifter Shaft with 17-18
17-0576	—	16	As Above, V-Twin Includes 2, 5, 17, 20, 21, & 56
17-0547	34082-79	17	Pin, Shifter Shaft Lever
13-0131	34083-79A	18	Spring, Shifter Shaft Lever
17-0516	34085-79A	19	Cam Follower
17-0578	37086-79	20	Pawl, Shifter Cam, V-Twin
13-0132	34087-79A	21	Spring, Shifter Shaft Lever
17-1169	34088-87	22	1987-up Shifter Shaft
17-9932	34088-79	22	1979-86 Shifter Shaft
13-9176	34089-79	23	Spring
17-8081	34191-79D	24	Shifter Fork
17-8082	34193-79D	25	Shifter Fork
17-8083	34195-79D	26	Shifter Fork
12-0338	8998	27	Bearing, each 1979-99
12-0388	8992A	27	Bearing, each 2000-up
12-0951	10998	29	Retaining Ring
12-0158	8873	30	Ball
18-3209	25452-87A	31	Inner Ramp, 1987-99
18-3210	25453-87A	32	Outer Ramp, 1987-99
15-0172	36801-80	33	Gasket, Side Cover, 1980-86
15-0240	36801-87	33	Gasket, Side Cover, 1987-up
18-3211	34920-86	34	Coupling
12-0927	11020	35	Retaining Ring
17-9850	35076-79	36	Spacer
12-0557	35078-79	37	Nut, Mainshaft/Countershaft
43-9131	37105-87A	38	Chrome Clutch Release Cover
17-9846	37109-87A	38	Chrome End Cover 1987-94 FXR
43-0131	37104-84	38	Chrome End Cover 1980-86 FXR
37-8934	734, 739	39	Plug, 1987-97
40-4098	60328-98A	39	Plug, 1998-up
15-1272	—	39	Plug Washer, 1980-up
43-9136	34468-86A	40	Upper Chrome Cover, 1987-97
43-9097	34731-86A	41	1986-88 Transmission Case FXST
<b>The Cases Include Parts Listed 42-49</b>			
12-1197	11733	42	Mounting Stud
12-0339	8977	43	Needle Bearing
12-0337	8978	44	Mainshaft Bearing, 1980-83
12-0361	8996	44	Mainshaft Bearing, 1984-00
12-0426	8996A	44	Mainshaft Bearing, 2001-06
17-9852	33114-79	45	Spacer
14-0534	11165	46	Seal
17-0546	33334-79	47	Spacer, Sprocket 1979-84
17-9851	33334-85	47	Spacer, Sprocket 1985-93
17-0560	33344-94	47	Spacer, Sprocket 1994-up
14-0157	12050	48	Seal, 1984-Early1994
14-0962	12067A	48	Seal, Late1994-up
12-0952	11161	49	Snap Ring, 1985-00
12-0926	11057	49	Snap Ring, 1980-84
15-0237	34904-86A	50	Gasket, Upper cover
15-0213	35652-79B	51	Housing Gasket
17-9940	—	52	Transmission Door 1979-86 Billet

17-9946	—	52	Transmission Door 1987-99 Polished Billet
17-0519	62375-57	53	Fitting, Upper Cover, each
17-9853	6003	54	Thrustwasher 1 3/16" x 3/8" x 5/16"
12-0366	8876A	55	Bearing, 4 pack
17-0538	35068-79	56	Spring Plate
17-7652	35025-79B	57	As Above Andrews
17-9857	35026-79C	58	Andrews Gear, Mainshaft 2nd and Countershaft 3rd, 1979-93
17-9922	35026-79C	58	As Above (V-Twin)
17-9858	35027-79B	59	Andrews Gear, Mainshaft 3rd and Countershaft 2nd, 1979-93
17-9860	35028-79B	60	4th Gear Mainshaft 1979-93
17-0558*	35028-94	60	As Above 1994-up High Contact
17-9861	35029-79	61	Fifth Gear, Mainshaft 1985-84, Andrews
17-9862	34029-85A	61	Fifth Gear, Mainshaft 1985-90, Andrews
17-9942	35029-91A	61	Fifth Gear, Mainshaft 1991-93, Andrews
12-9997	35051-89	62	1991-up Bearing 5th Gear
12-0336	8904	62	1984-90 Needle Bearing 5th Gear
17-9899	35042-85	65	Mainshaft, 1985-89, Andrews
17-8238	35042-90	65	Mainshaft, 1990 Belt, Andrews
17-9943	35042-91	65	Mainshaft, 1991-up Belt, Andrews
17-0153	35042-91	65	Mainshaft, 1991-up
17-9848	35064-79	66	Spacer, Mainshaft
17-0526	35622-79C	67	First Gear Countershaft
17-7653	35622-79A	67	As Above Andrews
17-9859	35625-79B	68	Fourth Gear Countershaft 1979-93, Andrews
17-0559*	35625-94	68	As Above 1994-up High Contact
17-9849	35629-79B	69	Spacer
17-9863	35626-79A	70	3.24 stock 1st gear for countershaft, Andrews
17-9897	35632-79	71	Countershaft Andrews
17-0529	35632-79	71	Countershaft, Sifton
17-0544	35632-79	71	Countershaft V-Twin
8907-5	—	72	Top Screw Kit, Chrome Allen
8907-5T	—	72	Top Screw Kit, Chrome Allen
8909-13	—	73	Side Cover Kit, Chrome Allen
8909-13T	—	73	Side Cover Kit, Chrome Allen
37-8985	—	74	Filler Plug, Chrome
32-9065	33900-59C	75	Neutral Switch, 1979-97
32-0069	33902-98	75	Neutral Switch, 1998-99
15-0685	33043-80	76	Switch Washer
14-0821	12035A	77	Seal
37-9133	6497HW	78	Washer
12-0950	11150	79	Retainer Ring
17-0966	33715-85A	80	Shift Lever, Chrome 1985-96
17-0968	33849-97	80	Shift Lever, Chrome 1997-up
12-0928	11067	81	Retaining Ring
17-9941	34091-85	82	Inner Race
17-0594	34091-06	82	Inner Race, 6 Speed
17-0603	34091-08	82	Inner Race, 2008-up
8408-1	35211-36	83	Sprocket Nut
8408-1T	35211-36	83	Sprocket Nut
14-0922	6007	84	Nylon Washer
12-1172	375	85	Dowel Pin
18-3212	8998	86	Ramp Kit includes 29-30-31-32-34
12-1199	609	87	Pin
14-0149	12045	88	Shift Shaft Seal
12-0959	634	89	Door Pin
17-9931	35628-79	90	4th Gear Spacer, 1979-83 only
12-0212	37523-85D	91	Clutch Hub Key 1985-89

\*Note: 1994-up gears can be used in earlier transmissions but only in matched sets.







# 5-Speed Transmission Parts

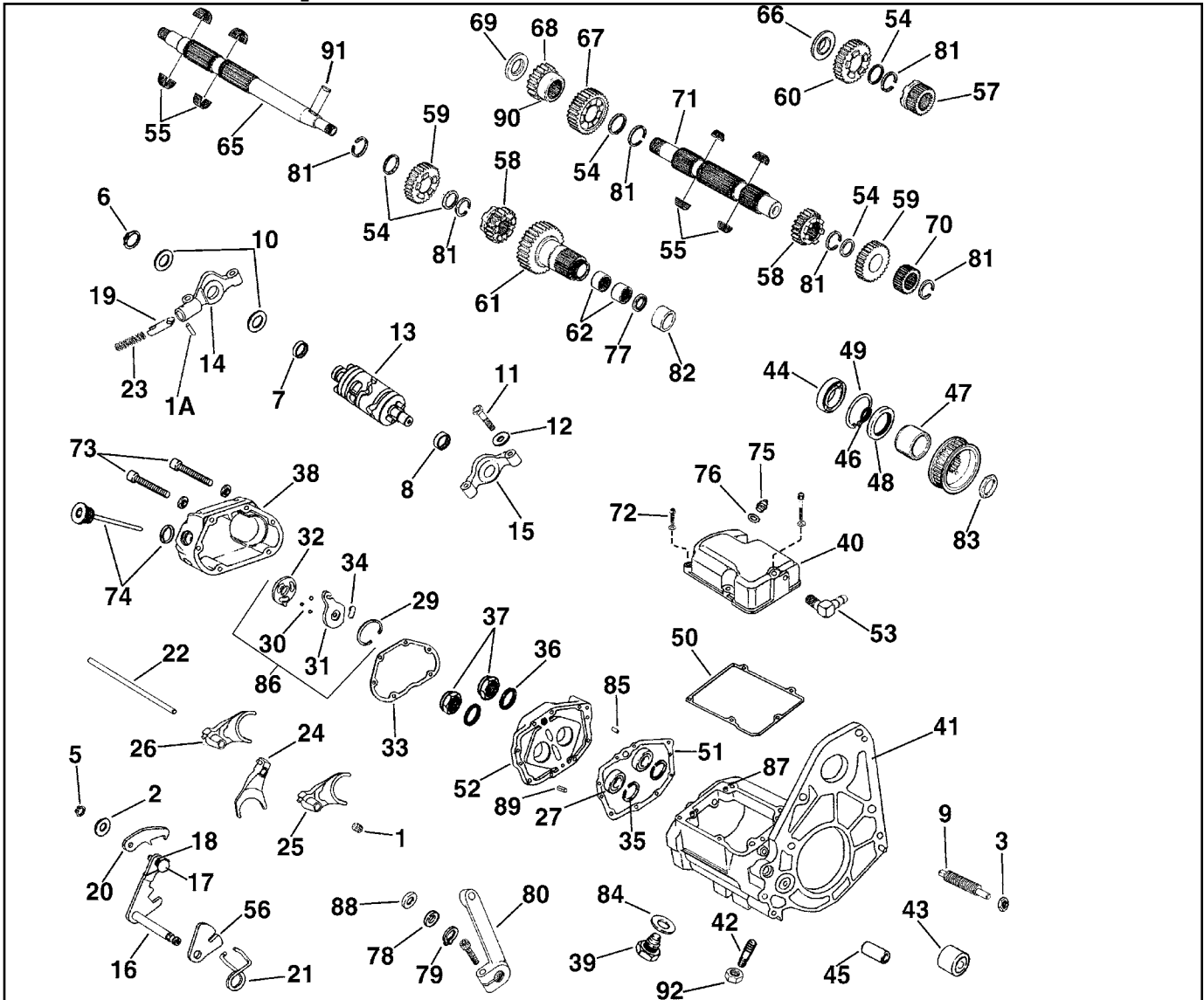

## Shifter Parts



**Chrome Steel Inner Shifter Lever**  
Includes stainless allen screw and washer.

VT No.	Speed
17-0966	5
17-0968	6

This V-Twin part is a steel forging. In this process, the steel is first fired as a red hot ingot. Next a huge air hammer compacts and orients the grain structure into a rough shape of the part. Subsequent hits form the part into its final shape. After which it is machined and heat treated which results in greater strength and resistance to wear. V-Twin supplies many products which are of forged construction, including connecting rods, frame components and kicker arms.



**Billet Shift Arm** fits 5 and 6-Speed Big Twin transmission.  
VT No. 17-0666



**5-Speed Big Twin Transmission Shift Pawl Assembly** includes shift shaft with lever, pin, lever and shaft springs and pawl as pictured.

VT No.	Brand	Year
17-0576	V-Twin	1986-01 Softail, 1986-2000 FLT, FXD
17-0590	Sifton	1986-01 Softail, 1986-2000 FLT, FXD
17-0596	Sifton	1989-2005 Big Twin
17-0604	Sifton	2002-2006 FLT
17-0605	Sifton	2006-up FXST



**5 Speed Shifter Fork Set** fits 1986-06 FXST.  
VT No. 17-8391



# 5-Speed Transmission Internals

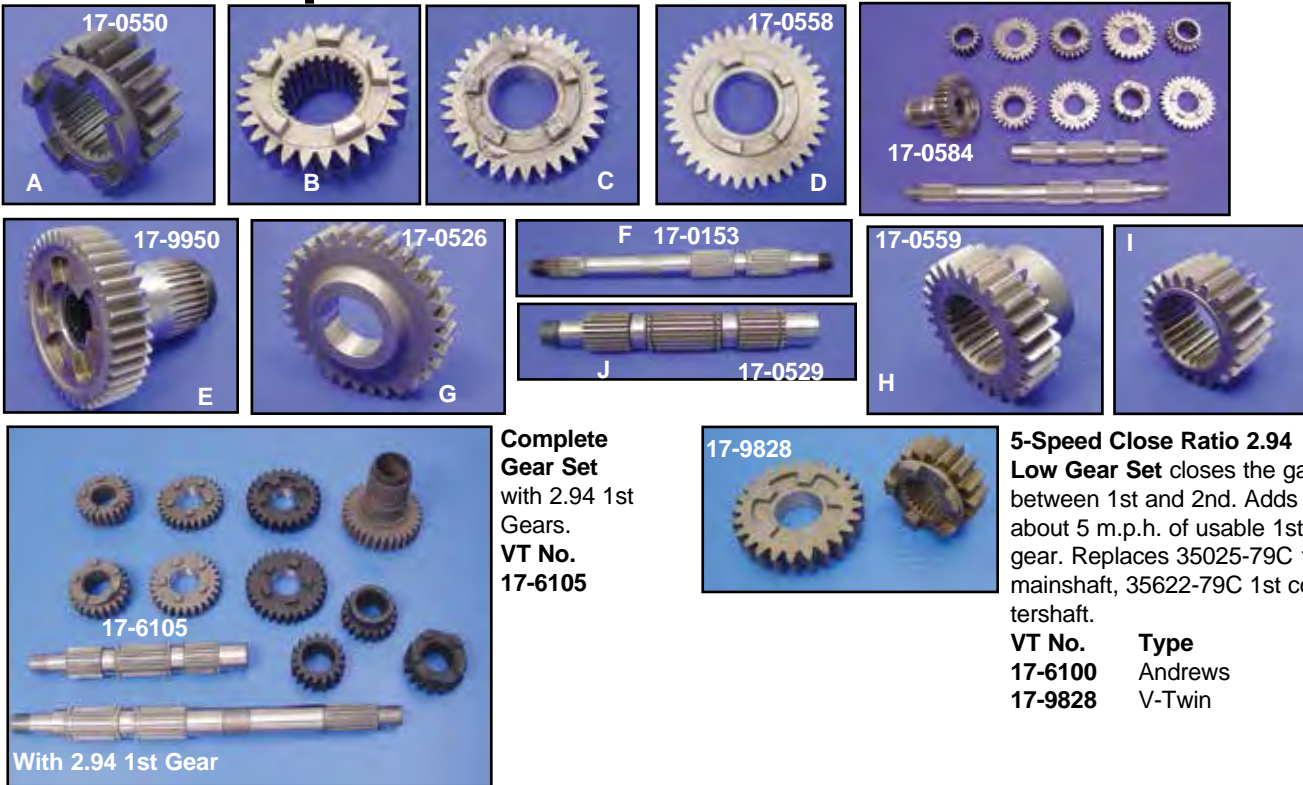

5-Speed Transmission Gears and Shafts, Stock Ratio.								
Gear/Shaft	Stock	Stock	OE	Andrews		Jims	Year	#
	OEM	V-Twin		w/stock 1st	w/2.94 1st			
First Mainshaft	35025-79B	<b>17-0550</b>	—	<b>17-7652</b>	—	<b>17-0562</b>	1979-up	A
Mainshaft 2nd	35026-79C	<b>17-9922</b>	—	<b>17-9857</b>	—	—	1979-93	B
Countershaft 3rd	35026-94	—	—	—	—	—	1994-up	B
Mainshaft 2nd								
Countershaft 3rd	35027-79B	<b>17-0549</b>	—	<b>17-9858</b>	—	—	1979-93	C
Mainshaft 3rd								
Countershaft 2nd	35028-79B	—	—	<b>17-9860</b>	—	<b>17-0568</b>	1979-93	D
4th Mainshaft								
4th Mainshaft	35028-94	—	<b>17-0558*</b>	—	—	—	1994-up	D
5th Mainshaft	35029-79	—	<b>17-0577</b>	<b>17-9861</b>	—	—	1979-84	E
5th Mainshaft	35029-85A	—	<b>17-0524</b>	<b>17-9862</b>	—	—	1985-90	E
5th Mainshaft	35029-91A	—	—	<b>17-9942</b>	—	—	1991-93	E
5th Mainshaft	35029-94	—	—*	—	—	—	1994-up	E
Mainshaft	35042-79	<b>17-9920</b>	—	<b>17-9898</b>	—	—	1981-84	F
Mainshaft	35042-85	<b>17-0579</b>	—	<b>17-9899</b>	—	—	1985-89	F
Mainshaft	35042-90	—	—	<b>17-8238</b>	—	—	1990 only	F
Mainshaft	35042-91	<b>17-0543</b>	<b>17-0153</b>	<b>17-9943</b>	—	—	1991-up	F
1st Countershaft	35622-79C	—	<b>17-0526</b>	<b>17-7653</b>	—	—	1979-up	G
4th Countershaft	35625-79A	—	—	<b>17-9859</b>	—	<b>17-0565</b>	1979-93	H
4th Countershaft	35625-94	—	<b>17-0559*</b>	—	—	—	1994-up	H
5th Countershaft	35626-79B	—	—	<b>17-9863</b>	—	—	1979-93	I
5th Countershaft	35626-94	—	—*	—	—	—	1994-up	I
Countershaft	35632-79	<b>17-0544</b>	<b>17-0529</b>	<b>17-9897</b>	—	<b>17-0574</b>	All	J
Countershaft	Sputhe	<b>17-0548</b>	—	—	—	—	Shorter	J
<b>Twelve Piece Gear Sets</b>								
Gear Set A-J	VT	<b>17-0584</b>	—	—	<b>17-6105</b>	—	1991-up	Set
Gear Set A-J	Andrews	—	—	<b>17-6016</b>	<b>17-6081</b>	—	1981-84	Set
Gear Set A-J	Andrews	—	—	<b>17-6017</b>	<b>17-6085</b>	—	1985-89	Set
Gear Set A-J	Andrews	—	—	<b>17-6018</b>	<b>17-6090</b>	—	1990	Set
Gear Set A-J	Andrews	—	—	<b>17-6019</b>	<b>17-6091</b>	—	1991-up	Set

\*Note: 1994-up gears can be used in earlier transmissions but only in matched sets.



## 5-Speed Transmission Gasket Kit

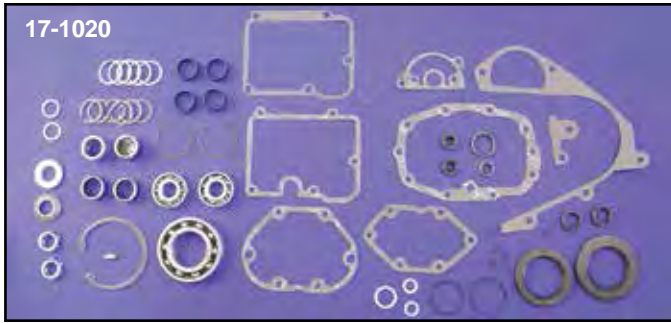

**5-Speed Jims Hardware and Rebuild Kit** includes bushings, locks, keys and snap rings for completing as 5 speed transmission rebuild. James gasket set included.

VT No.	Year
17-1019	1980-Early84
17-1020	Late1984-90
17-1021	1991-98
17-1035	1999-up



**Transmission Gasket Sets.** Complete gasket and oil seal kits listed below for individual application.

James	GB No.	OEM	Fits
15-0841	15-0619	33031-82	1980-84 Big Twin 5-Speed
15-0841	15-0641	33031-85	1985-99 Big Twin 5-Speed
15-0842	15-0762	33031-91	1991-99 Dynaglide FXDB-S
—	15-0767	—	1999-up FXD
15-0843	15-0763	33031-93	1993-99 FLHS-FLHTC
15-1211	15-0764	33031-99	1999-up TC-88



**James Transmission 5-Speed Seal Kits.**

VT No.	Year
15-1166	1984-93
15-1167	1994-up



**Big Twin Transmission Sprocket Oil Seal Kit** for 2006-up Dynaglide and 2007-up Big Twins.  
VT No. 15-1276



**5-Speed Big Twin Main Drive Gear Oil Seal and Spacer Kit** features three lip seal and coated sprocket spacer. The coating provides superior surface lubricity and increased corrosion resistance. Fits 1994-up as a replacement or on ratio change on earlier models with late pulley.  
VT No. 17-0752

## Transmission

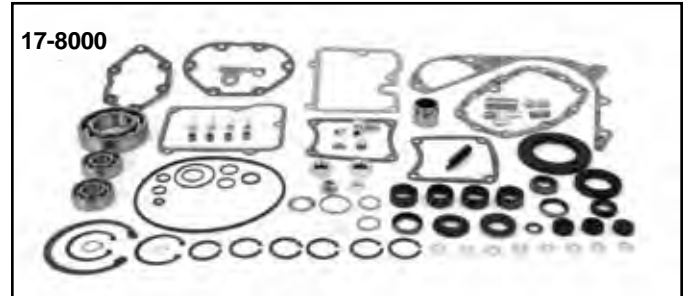
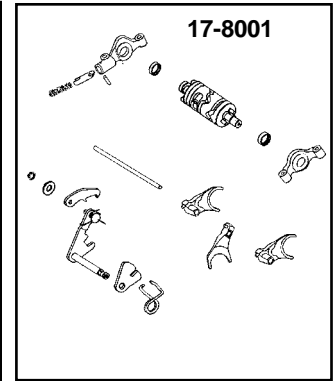
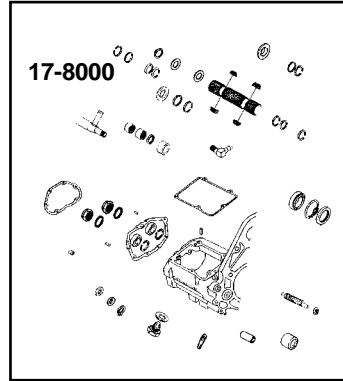

**GB™ Big Twin 5-Speed Builder's Kits** include all parts noted by each illustration.

VT No.	Type
17-8000	Internal Small Parts Kit
17-8001	Shifter Shaft Drum Assembly, 1979-97

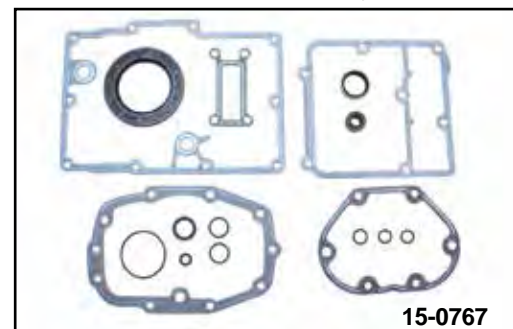

**Transmission Sprocket Oil Gasket and Seal Kit** fits 1999-2005 FXD.

VT No. 15-0767





# End Cover



43-9131



43-0540



43-0537



43-0787



43-0131



17-9846



18-3212

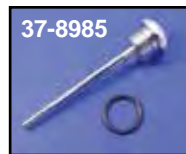

37-8985



42-0452



42-0456



42-0457

Chrome Big Twin Transmission Dress Trim fully covers end cover and inner door.

VT No.	Year
42-0452	2000-06
42-0456	1987-99 FXST
42-0457	1987-99 FXR



8908-15



8912-13

Chrome Clutch Release Covers. Order release kits separately.

VT No.	OEM	Fits/Item
43-9131	37105-87A	1987-99 FXST-FXD
43-0540		1987-99 Billet Type
17-9846	37109-87A	1987-94 FXR Chrome Cover
43-0537	37105-99	2000-up FXST 1999-05 FXD
43-0787	37116-06	2006-up FXD, 2007-up FXST
43-0131	37104-84	1980-86 Chrome Cover
18-3212		Release Ramp Kit
37-8985		Allen Chrome Dipstick
17-9946	35250-90B	Bearing Housing, 1990-up

## Release Cover Screw Kits

8908-15	1980-86 Allen
8909-13	1987-up Allen
8909-13-P	As Above Polished 2006-up 6 Speed
8404-27	1980-86 Acorn
8912-13	1987-up Acorn
8913-13	1987-up Cap
15-1050	Gasket, 1980-86
15-1051	Gasket, 1987-99



# 5 and 6-Speed Top Cover

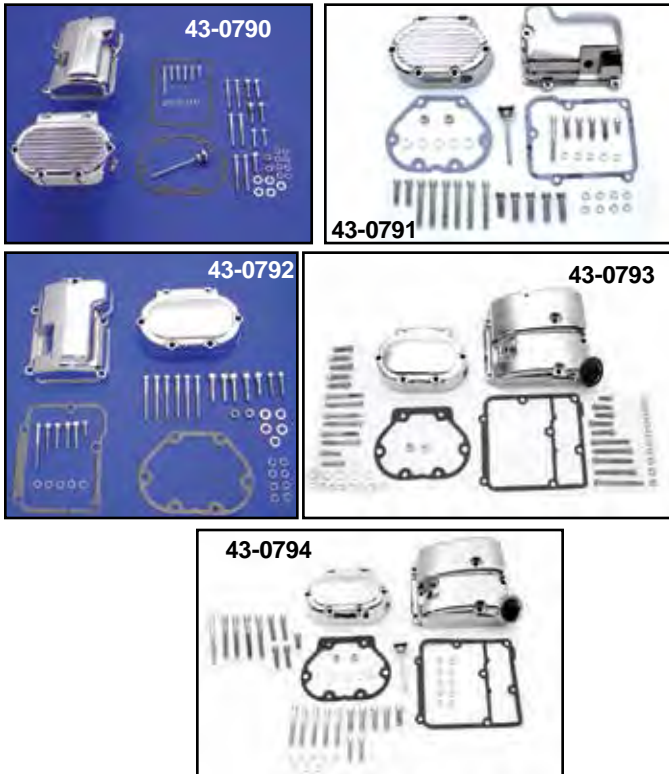

43-9136 Installed



**5-Speed Big Twin Chrome Transmission Side Cover and Top Cover Set** includes chrome allen screws and chrome allen dipstick.

**VT No. Year Model**

**43-0790** 1987-99 FXST-FLST

**43-0791** 1987-94 FXR

**43-0792** 2000-06 FXST-FLST

**43-0793** 1999-00 FXD

**43-0794** 2001-05 FXD

**8909-13** Transmission Side Cover Allen Screws

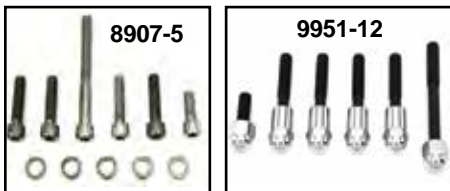

## Top Cover Screw Kits

### FXST-FLST

<b>8404-27</b>	1980-85	Acorn
<b>8906-5</b>	1980-85	Allen
<b>8907-5</b>	1988-99	Allen
<b>8907-5T</b>	1988-99	Allen
<b>8910-5</b>	1987	Acorn
<b>8911-5</b>	1987	Cap
<b>8922-5</b>	1988-99	Cap
<b>9951-12</b>	2000-06	Acorn
<b>9952-11</b>	2000-06	Allen
<b>9952-11-P</b>	2000-06	Polished Allen

### Dynaglide

<b>9785-9</b>	1991-05	Acorn
<b>9789-17</b>	1991-05	Allen
<b>9789-17-P</b>	As Above	Polished

## Chrome 5-Speed Transmission Top Covers.

VT No.	Year	Model
<b>43-9111</b>	1979-86	FXST, FXR
<b>43-9136</b>	1987-99	FXST, FXR
<b>43-0504</b>	2000-06	FXST, FLST
<b>43-0786</b>	2007-up	FXST, Softail
	2006-up	FXD



42-1020



43-0786

**Chrome Oil Fill and Transmission Top Covers** fit 1990-up FXD.

VT No.	OEM	Item	Year
<b>42-1020</b>	62511-06	Oil Spout	2006-up
<b>43-0786</b>	34469-06	Transmission Top Cover	2006-up



**Chrome Transmission Vent Canister** accepts  $\frac{5}{16}$ " or  $\frac{3}{8}$ " hose.

**VT No. 40-0457**



# 5-Speed Kicker Kit

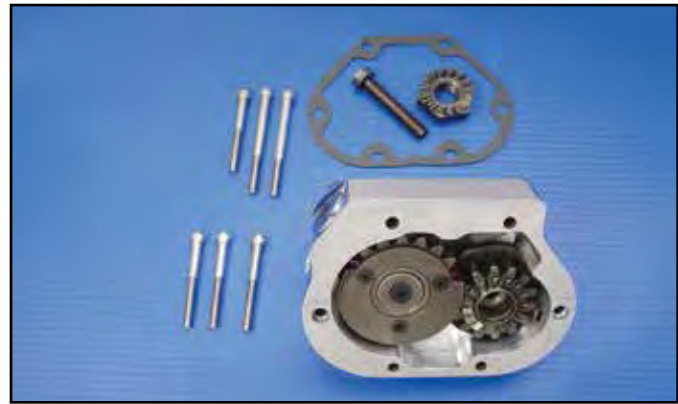
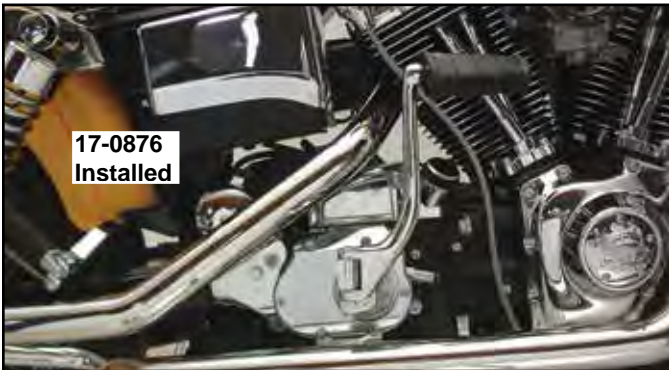
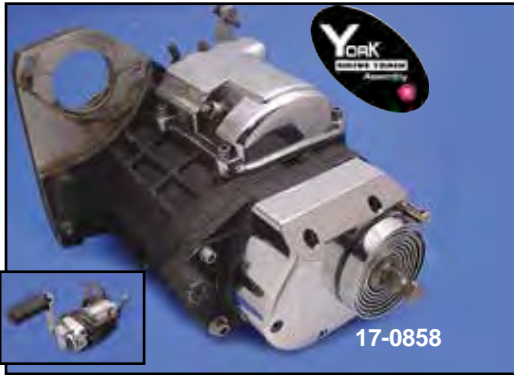

**5-Speed Kick Starter Kit** features slim profile design. Pushrod modification may be required. Order kick starter arm and pedal separately. Fits all 5-Speed replacement OEM transmissions.

- | VT No.  | Item               |
|---------|--------------------|
| 17-0858 | Kit                |
| 17-0876 | Kit with arm       |
| 17-0857 | Gear Set           |
| 17-0989 | Inner Clutch Ramp  |
| 17-0869 | Shaft, 1" longer   |
| 12-1968 | Bearing            |
| 13-0123 | Replacement Spring |
| 17-0353 | Dipstick           |
| 15-0688 | Gasket Kit         |



**5-Speed Kick Starter Installation Tool.** Save time when installing 5-Speed conversion units, because the complete transmission does not have to be dismantled. Mainshaft and clutch pack can remain in place. Reduces labor from 6 to 3 hours.

VT No. 16-0756

## Dipstick



**Chrome Transmission Filler Dipsticks.**  
2006-up FXD, 2007-up FXST, FLST

- | VT No.           | Style                  |
|------------------|------------------------|
| 40-0932          | Hex                    |
| 17-0789          | Allen                  |
| 40-0941          | Knurl                  |
| 17-0958          | Hex                    |
| 40-0941          | Knurl                  |
| <b>1987-2006</b> |                        |
| 17-0353          | Allen                  |
| 9885-2           | Allen                  |
| 9885-2T          | Allen                  |
| 37-8985          | Allen                  |
| 40-0456          | Hex                    |
| 17-0872          | Hex Plug (No Dipstick) |



**5 and 6 Speed Bearing Support Plate** for 1984-2000 Big Twin with kick starter. Billet aluminum support plate includes bearing.  
VT No. 20-0250



**Alloy Billet Kick Starter Pedals.**

- | VT No.  | Style        |
|---------|--------------|
| 17-0386 | Knuckle      |
| 17-0765 | Maltese      |
| 17-1491 | Knuckle Only |

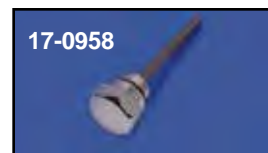



# 1998-up Clutch Pack Assembly

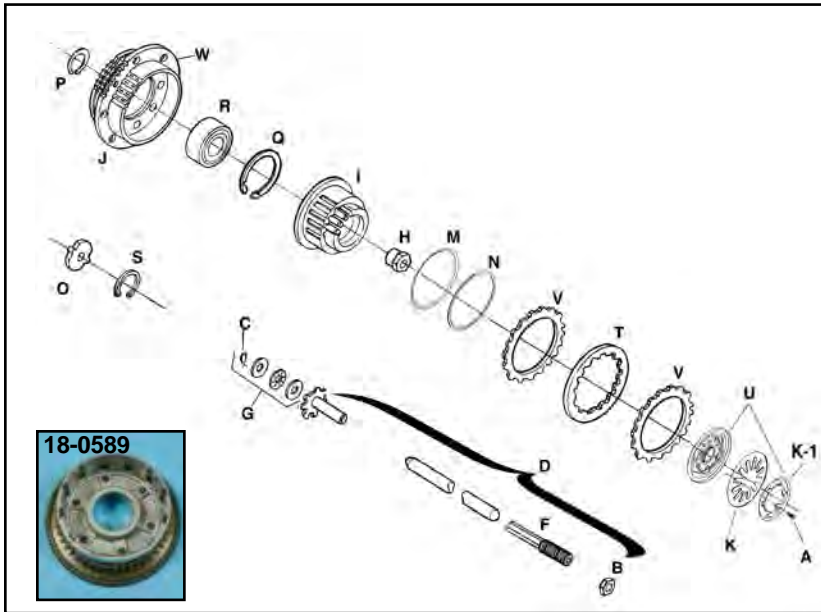

Order VT No. 18-0133 Complete Assembly  
1998-06 5-Speed

1998-up Big Twin Clutch Parts. Clutch Drum "J" has "W" Ring Gear installed.

VT No.	OEM	#	Item
12-0585	2980	A	Screw (6 used)
12-0563	7848W	B	Locknut
12-0923	11096	C	Retaining Ring
17-9252	37069-90	D	Pushrod Release Set
	37088-90		
	37090-98		
18-0169	37090-98	F	End, Rod, Left only
18-3623	37312-75	G	Bearing, Kit includes Thrust Washer (2) Retaining Ring
	37313-80		
	11096		
12-9914	37496-90	H	Mainshaft Nut
18-0160	37550-98	I	Clutch Hub (OE), 1998-06
18-0171	37550-98	I	Clutch Hub (V-Twin), 1998-06
18-0588	31626-06	I	Clutch Hub, 2007-10
18-0592	37554-11	I	Clutch Hub, 2011-up
18-0161	37707-98A	J	Clutch Drum
			Includes Q and R
18-0589	Clutch Drum J		As Above 2011-up
			2007-10 FXST
			2006-2010 FXD
18-0180	37707-98A	J	Clutch Drum Only
18-3252	37871-98A	K	Diaphragm Spring (BTE)
18-8317	37871-98A	K	Diaphragm Spring
18-0163	37872-98	K-1	Spring Retainer
18-0164	37883-98	M	Damper Spring Seat
18-0165	37884-98	N	Damper Spring
18-8257	37903-90	O	Release Plate
18-8258	37904-90	P	Retaining Ring, External
18-8259	37905-90	Q	Retaining Ring, Internal
12-0160	37906-90	R	Bearing 1990-10
12-0178	37906-11	R	Bearing 2011-up
18-8261	37909-90	S	Retaining Ring, Internal 1990-99
18-3251	37913-98	T	Steel Plates (8)
18-0166	37912-98A	U	Pressure Plate Kit
18-3250	37932-98	V	Plate Set (9)
18-8319		V	Starter Ring Gear
18-0723	2007-10		Clutch Drum Kit
18-0455	2007-10		Clutch Retaining Ring Internal
18-0456	2011-up		Clutch Drum Only
18-0193	2007-10		Clutch Drum Shell

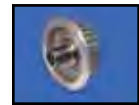

Clutch Hub.  
VT No. Year  
18-0171 1998-06  
18-0588 2007-10  
18-0592 2011-up

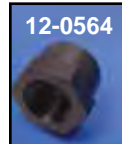

Big Twin Clutch Hub Nuts secure clutch hub to main shaft.  
VT No. OEM Fits  
12-0564 37496-84 1984-89  
12-9914 37496-90 1990-up



Big Twin Starter Ring Gears for replacement on stock clutch drums only. **Note:** Bolt on types include bolts.  
VT No. Year Teeth  
18-8307 1991-93 66T  
18-8308 1994-97 102T  
18-8319 1998-06 102T  
37-0018 Allen Bolt

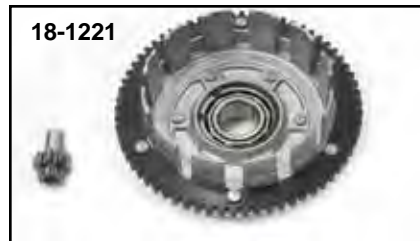

**Easy Starter Kits for Big Twin Models.** Improves starting on high compression big inch engines through an improved starter-to-clutch basket gear ratio. Complete kits include a clutch basket with bearing for Big Twin models with 66-tooth starter ring and a 9-tooth starter pinion gear.  
VT No. Year  
18-1220 1994-97  
18-1221 1998-2006  
32-9201 9T Gear



# Clutch Parts for 1991-97 Big Twin

## Big Twin Clutch Parts for 1991-97.

VT No.	OEM #	Item
12-0563	7848W	A Locknut
12-0923	11096	B Retaining Ring
17-9250	37069-90	C Pushrod
	37088-90	Release Set
	37090-84A	
18-3253	37090-84A	E End, Rod, Left only
18-3623	Kit	F Bearing Kit
	37312-75	Bearing
	37313-80	Thrust Washer
	11096	Retaining Ring
12-9914	37496-90	G Mainshaft Nut
18-0159	37550-90A	H Clutch Hub, V-Twin
18-8263	37707-90	I 91-93 Clutch Drum with Gear, OE
18-8310	37707-90	I As Above, V-Twin
18-8311	37707-94	I 94-97, Clutch Drum w/Gear, V-Twin
<b>Note:</b> Order bearing for above separately VT No. 12-0160		
18-8308	102T	I Ring Gear Only
18-3234	37871-90	J Diaphragm Spring
18-3267	Heavy	J Diaphragm Spring
18-8256	37872-90	K Spring Seat
18-8257	37903-90	L Release Plate
18-8258	37904-90	M Retaining Ring, External
18-8259	37905-90	N Retaining Ring, Internal
12-0160	37906-90	O Bearing
18-8260	37908-90	P Retaining Ring, Internal
18-8261	37909-90	Q Retaining Ring, Internal
18-3231	37913-90	R Steel Plates (6), Barnett
18-8255	37912-91	S Pressure Plate
18-3230	37911-90	T Plate Set (8), Barnett
18-8262	37977-90	U Spring Plate, Smooth
18-8313	37977-90	U Spring Plate, Smooth
18-8307	—	V Ring Gear 1990-92
18-8308	—	V Ring Gear 1993-97

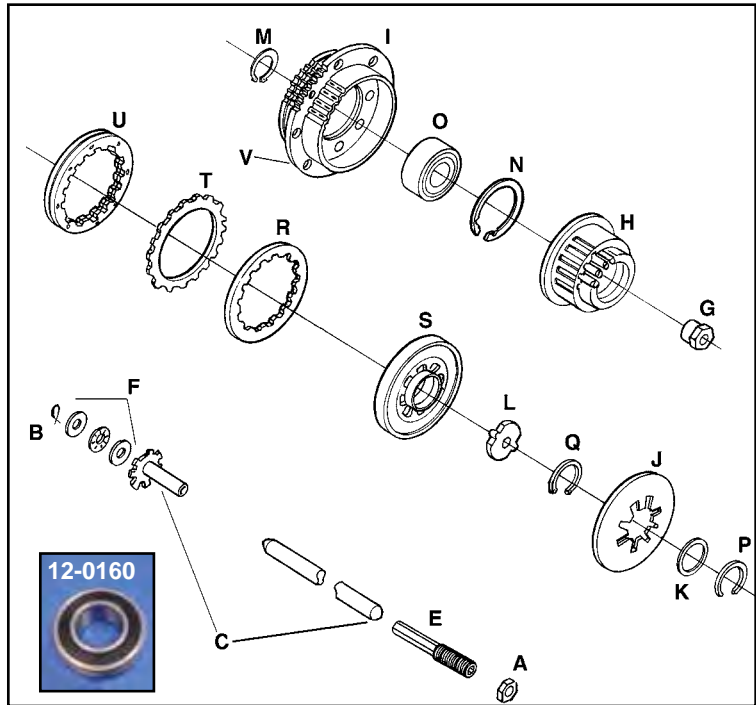

### Complete Clutch Pack Assembly.

VT No.	Years	Model
18-0131	1991-93	Big Twin
18-0132	1994-97	Big Twin



**18-0159 Clutch Hub** replaces stock units. Replaces 37550-90A. Fits 1991-97.  
**VT No. 18-0159**





**Complete Assembly**  
1985-90.  
VT No.  
18-0130

# 1985-90 Big Twin Clutch Parts

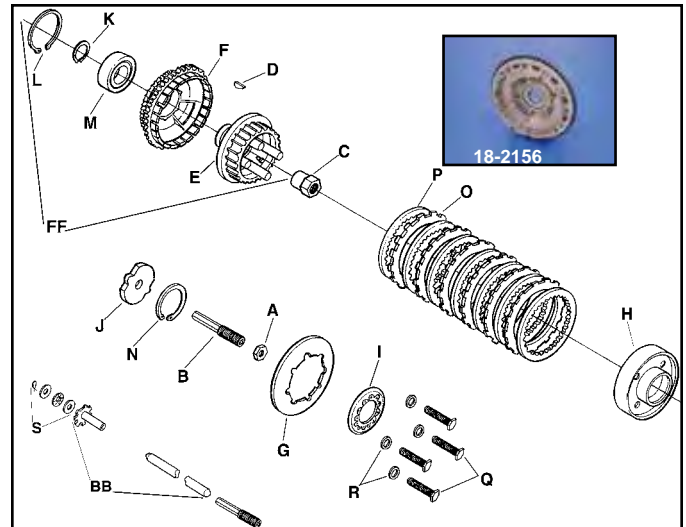

**1984-90 Big Twin Clutch Hubs** feature the updated factory construction which has a machined steel center with aluminum outer

splined ring, secured by allen screws, with steel studs welded in place. Order related hardware separately.

VT No.	OEM	Year	Type
18-8153	37550-84A	1984-90	V-Twin
18-8170*	37550-84	1984-90	V-Twin

\*Note: Early style hub with aluminum studs



## 1985-90 1340 Big Twin Clutch Pack Hardware.

VT No.	#	OEM	Item
12-0563	A	7848W	Nut, 5 pack
18-3259	B	37357-84	Adjusting Screw for Stock
18-3253	B	37090-84A	Adjusting Screw for 18-3680
17-9246	BB	Kit	Rod Set, 1985-86
17-9248	BB	Kit	Rod Set, 1987-89
17-9249	BB	Kit	Rod Set, 1990
12-0564	C	37496-84	Nut, Mainshaft
12-0212	D	37523-85	Key, 10 pack
18-8153	E	37550-84A	Clutch Hub, V-Twin
18-3641	F&M	37702-84A	84-Early85 Clutch Drum with Ring Gear
18-2156	F&M	37707-84A	Late85-90 Clutch Drum with Ring Gear
18-8290	G	37875-86A	Diaphragm Spring
18-0186	FF	Kit	1984-Early85 Drum/Hub Assembly
18-0187	FF	Kit	Early1985-90 Drum/Hub Assembly
18-3680	H	37901-84A	Pressure Plate
18-3255	I	37902-86B	V-Twin Adjuster Plate
18-3215	J	37903-84	Release Plate
12-0953	K	37904-84	Retaining Ring External
12-0954	L	37905-84	1984-97 Retaining Ring Internal
12-1375	L	37905-84	1984-97 Retaining Ring Internal, 5 pack
12-0308	M	37906-84	Bearing
12-0955	N	37907-84	Retaining Ring, 10 pack
18-1147	O	37931-84	Friction Disc, 6 pack
18-1148	P	37975-84	Drive Disc, 7 pack
37-8944	Q	2881W	Bolt and Washer
37-9272	R	6242W	Washer
18-3623	S	Kit	Bearing Kit
12-0923	T	11096	Retaining Ring



**1984-89 Big Twin Clutch Hub Kit** includes updated reinforced steel center clutch hub, steel drive plate set and friction plate set.  
VT No. 18-0541



**1985-90 Clutch Hub Sleeve** is a reinforcement ring for hubs at the tapered end. Sleeve is pressed on with beveled side out toward inner primary, after clutch drum with bearing is set over hub, so that clutch drum and hub will be installed as one unit.

VT No.	Type
18-8240	Aluminum one piece type hub
18-8241	Steel two piece type hub

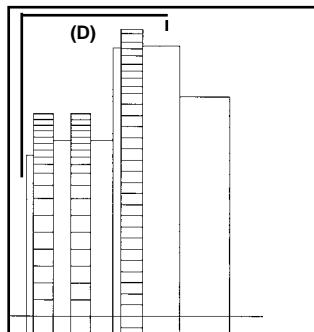

**Clutch Drum and Hub Assembly.** Bearing and snap ring are installed in drum. Starter ring gear offset dimension shown (D).

VT No.	Year	Starter Ring Offset
18-0186	1984-Early85	1.670
18-0187	Late1985-90	2.087





# Clutch Pack



18-0586



York Patch.  
VT No.  
48-1781



18-0590



18-0591

**York Hi Performance Clutch Kits** have been especially designed for better clutch operation and to deliver more torque and horsepower capacity. All parts are made from the highest quality materials to ensure a trouble free operation. The Kevlar clutch plates are made for heavy duty operation and deliver a smooth power transfer to the rear wheel. The adjustable coil springs allow you to tailor your clutch lever pressure and clutch operation as needed. These kits also boast very low maintenance, "Set it and Forget it." They are great upgrade kits.

**VT No. Year Model**

18-0586 1998-06 5-Speed Big Twin

18-0590 Replacement Pack for 18-0587

18-0591 Replacement Pack for 18-0586



**Complete Clutch Pack** fits 2011-up FXST, FLT. Kit includes clutch hub, thrust washer, spring washer and retaining ring, clutch spring seat, spring damper spring seat, damper spring, release place, internal retaining rings, double row ball bearing, clutch pressure plate, 8 clutch plates, and 9 friction plate kit.

VT No 18-0595



18-0780

**York Posilock Clutch Kit** fits 1998-2006 Big Twin featuring positive engaging ball ramp activation.  
VT No. 18-0780



**Barnett Scorpion Clutch Kit** features over twice as much friction surface area compared to stock clutch. All Scorpion Clutches provide a positive engagement and release. Scorpion clutches incorporate 6 heavy duty coil springs. In addition, an extra spring set with a different spring rate is

included which allows the clutch to be tuned for street or race application depending on usage. Tunability is easy without removal of the primary cover. Barnett Friction Plates are compatible with any primary oil. Each kit is designed to be used with stock type clutch basket.

**VT No. Year**

18-3833 1986-89 Big Twin

18-3842 1990-97 Big Twin

18-3852 1998-06 FXST, FLST, FLT; 1998-05 FXD

18-3853 2007-09 FXST, FLST, FLT; 2006-09 FXD



**BDL Competitor Clutch Kit** features 9 springs and shoulder bolts for simple adjustment, large 40mm double row hub bearing, polished pressure plate and Kevlar clutch.

**VT No. Fits**

20-0628 1990-97 Evolution Big Twin with Chain Primary Drive

**Replacement Friction/Steel Sets for Above**

**VT No. Fits**

18-0548 20-0628

## Pro-Clutch by Rivera Engineering



20-0580

**Pro-Clutch by Rivera Engineering** converts old style clutch packs to smooth modern diaphragm spring function. Available for early chain or belt drive with wet or dry clutch. Kit includes clutch hub with bearing, clutch discs (friction and steel), diaphragm spring, spring retainer, pressure plate and four shoulder bolts. 1984-up kits utilize existing clutch basket, supplies a clutch hub to allow use of clutch plates that increase surface area by 100% to reduce slipping.

**VT No. Year**

20-0549 1984-89 Big Twin

20-0550 1990-97 Big Twin

20-0580 1998-06 Big Twin

20-0732 2006-10 Dynaglide and 2007-10 Big Twin

20-0736 2011-up FXST, FLST, FXD, FLT

16-0310 Puller Tool

**Type**

Chain

Chain

Chain

Chain

Chain

**Replacement Friction/Steel Sets**

**VT No. Fits**

18-0542 Special application for chain or belt drive

18-0544 20-0549, 1984-89 Chain

18-0545 20-0550, 1990-97 Chain

18-0546 20-0580, 1998-up Chain



16-0310



20-0550



20-0736



# Big Twin Clutch Pack

BIG TWIN



**Big Twin Clutch Packs** feature stock style components for a complete clutch installation.

VT No.	Year
18-0134	1984-Early 85
18-0130	1985-90
18-0131	1991-93
18-0132	1994-97
18-0133	1998-06
18-0723	2007-10
18-0595	2011-up



## Primary Drive Assembly



**Primary Drive Assembly Kit** includes clutch pack assembly, chain, chrome inner and outer primary covers with all bushings, seals, spacers, gaskets and mount screws including the starter jack shaft assembly.

VT No.	Years	Model
43-1002	1994-97	FXST
43-1000	1998-06	FXST

**Primary Chain Drive Systems** for Big Twins include 76 or 82 link Diamond primary chain, chain shoe adjuster assembly, clutch drum basket with starter ring gear and steel and fiber clutch plates with pressure plate assembly. Correct front compensator sprocket assembly includes all parts necessary for installation. Including sprocket nut. 5-Speed Big Twin Softail models and all pre1985 FLH-FX 4-Speeds require 82 link primary chains, 1980-up FLT-FXR 5-Speeds require 76 link primary chains.

82 Links	76 Links	Year
18-0102*	18-0114*	1998-06
18-0103*	18-0113*	1994-97
18-0104*	18-0112*	1991-93
18-0105*	18-0111*	1985-90

\*Note: Units include compensator front sprocket assembly.





# Big Twin Clutch Kit

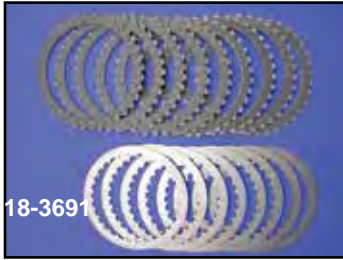

**Carbon Fiber Clutch Sets** by Barnett for wet clutch applications. Carbon fiber clutches feature excellent lubricity and very good energy absorption.

**SERIES K** Kevlar Clutches by Barnett

- Series K™ clutches perform flawlessly under extreme heat conditions
- Smooth precise shifting
- Steel backing plates for maximum strength
- Kevlar is the most durable friction material made.
- 100% asbestos free

**Kevlar**

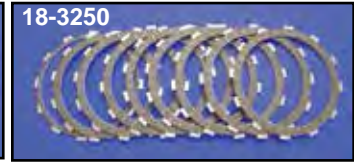
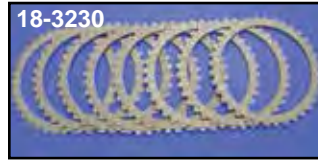

18-3695

VT No.	Year	Note
18-3693	1984-89	1
18-3690	1990-97	
18-3691	1990-97	2
18-3694	1998-up	

**Note 1:** Plates are wider than stock. Adds 25% more surface area.

**Note 2:** Consists of nine friction plates and eight steel plates. Adds 12% more surface area double steel drive plate is not used.

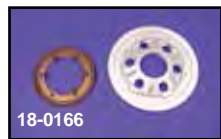

VT No.	Note	Item
<b>Fits 1984-89</b>		
18-1147	A	Friction Plate (6)
18-1148		Steel Set (7)
<b>Fits 1990-97</b>		
18-3230		Friction Plate (8)
18-3231	C	Steel Set (6)
18-3233	F	Extra Plate Friction Set
<b>Fits 1998-up</b>		
18-3250		Friction Plate (9)
18-3251		Steel Set (8)
18-3695	H	Extra Plate

### Notes

- A. Plates are 25% wider than stock for a greater surface area contact.
- C. Stock double riveted Drive Plate must be reused.
- D. OEM replacement type, Not Genuine Barnett
- E. Bonded with carbon graphite compound by Raybestos. Dry flex clutch. Includes steel plates. For dry clutch conversion only. 1990-up models will not reuse spring plate.
- F. Consist of 9 Friction Plates and 8 Steel Plates. Add 12% more surface area to clutch double steel Drive Plate not used with kit.
- G. 1967 and older models, 1 extra steel plate is required.
- H. Consists of 10 friction plates and nine steel plates. Adds 11% more surface area.

### Barnett Diaphragm Clutch Spring.

VT No.	Year	Type	Item
18-3213	1984-89 Big Twin	Stock	Spring
18-8306	1990-97 Big Twin, 25% stronger	Heavy	Spring
18-3252	1998-05 FXD, FLT 1998-06 FXST, FLST	Stock	Spring
18-3696	As Above, 25% stronger	Heavy	Spring
18-0166	As Above	Stock	Kit
18-3255	1984-89 Adjuster		Plate

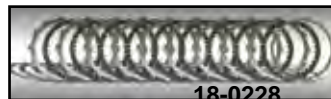

# Alto™ Clutch Set



### KEVLAR CLUTCH SET

**Alto Clutch Sets.** Available in fibers and steel. Sold Kevlar or Red Eagle type. Both are bonded to steel.

### Alto Clutch Sets For Big Twin Models

18-8281	1984-89	Red Eagle
18-8292	1984-89	Kevlar
18-8290	1984-89	Diaphragm Clutch Spring
18-8276	1990-97	Red Eagle
18-8299	1991-97	Kevlar
18-8315	1998-up	Red Eagle
18-8316	1998-up	Kevlar
18-8317	1998-up	Diaphragm Spring

### Steel Plates For Big Twin

18-8289	1984-90	Set
18-8286	1990-97	Set
18-8318	1998-up	Set

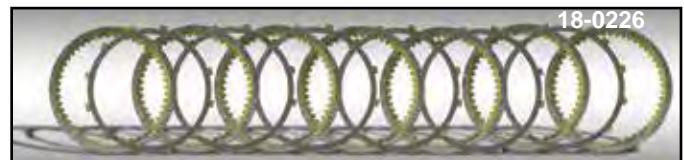

**Alto Carbonite Power Pack Clutch Kits** for Big Twin include friction and steel plates. Friction plates feature 3M carbon based friction material to withstand high friction and heat temperatures. Steel plates are melonite treated for better engagement and cooler running. Order spring plate separately.

VT No.	Year
18-0226	1984-89
18-0227	1990-97
18-0228	1998-up





# Police Clutch Kit



BIG TWIN

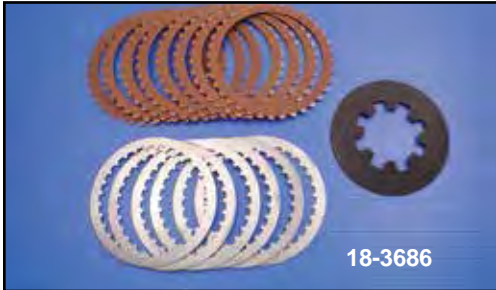
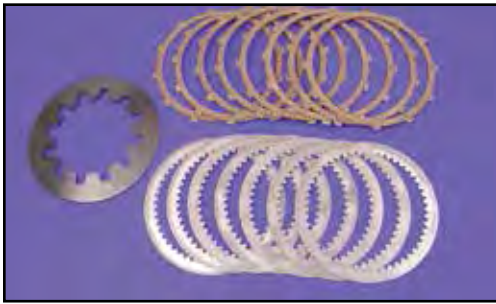

**Clutch Pack-Kit.** Heavy duty factory "wet" type for Big Twins. Complete kit includes our original bonded police Kevlar clutch steel plates with diaphragm spring.

VT No.	Year
18-3669	1985-89
18-3686	1990-97
18-5053	1998-up

## Diaphragm Springs



### Sifton Springs.

VT No.	Big Twin	Type
18-3234	1990-97	Stock
18-3267	1990-97	Heavy
18-0533	2006-up	Stock
18-0539	2006-up FXD	Blue
18-0670	2006-up FLT	Yellow



**York Patch.**  
VT No. 48-1781

48-1781

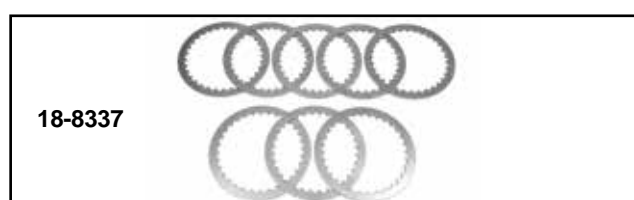
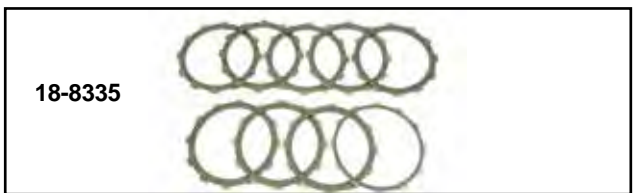
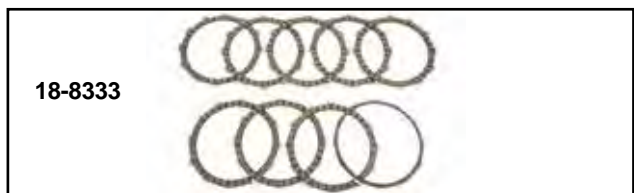
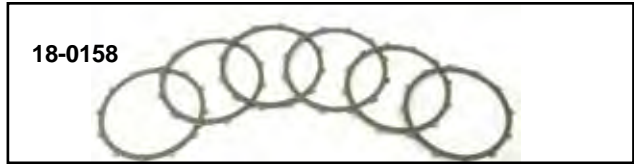

### Clutch Sets Only.

VT No.	Year	Type
18-1740	1990-97, complete kit	Kit with steel
18-0154	1990-97 8 piece	Friction
18-0158	1985-89	Kevlar
18-8333	1998-up	Coprene
18-8335	1998-up	Red Devil
18-8337	1998-up	Steel



**Tamer Style Clutch Hub Activator** fits 1998-up Big Twin for easier clutch pull. eliminates all clutch drag and lunging while in gear or while stopped. Greatly reduces gear clash, and increases clutch and transmission life by providing a clean and free clutch release.

VT No. 18-0834



# Clutch Release 5-Speed

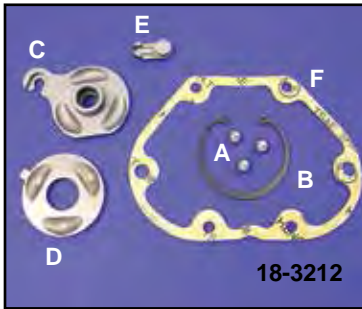

18-3212



18-3268

**Clutch Release Kit** for cable direct operated clutch on 5-speed models. Fits 1987-up.

VT No.	#	OEM	Item
18-3212	All	Kit	1987-99 Complete
18-3268	All	Kit	2000-up Complete
12-0158	A	8873	1987-up Ball
12-0951	B	10998	1987-up Retainer Ring
18-3209	C	25452-87	1987-99 Inner Ramp
18-3210	D	25453-87	1987-99 Outer Ramp
18-3211	E	34920-86	1987-up Coupling
15-0240	F	36801-87	1987-up Gasket
15-1504	F	36801-87	1987-up Gasket with bead



43-0131



18-3653 B



18-3661 A

**5-Speed Clutch Release Lever Set** fits 5-Speed models 1982-86. It replaces the stock release arm. Cable bracket, mounting hardware and acorn nut included. Replaces 37085-80, 37096-83 and 37096-85.

VT No.	#	OEM	Item
43-0131			Chrome Cover Only
18-3661	A	37084-79	Release Finger
18-3653	B	—	Release Lever Kit
12-1159		11019	Shaft Snap Ring
17-9980		37083-80A	Finger Shaft

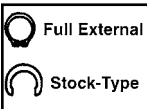

**Clutch Pushrod Snap Ring** for 1975-up Big Twin, replaces 11096 in stock or full external configuration.

VT No.	Type
12-0923	"C" Type, Stock
12-9992	Full External Type

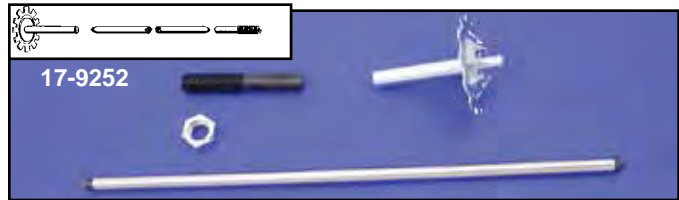

17-9252



17-1545

**5-Speed Clutch Push Rod Kits** are three piece. Replaces OE parts for all 5-speed transmissions.

VT No.	OEM	OEM	Model
17-9243	37089-79 37088-79	37090-79	1980-E84 FLT-FLHT 1982-83 FXR
17-9244	37089-84 37088-84	37090-84	Late 84 FLT Classic Late 84 FXRS-FXRT Late 84 FXRP-FLHTP
17-9245	37089-84 37285-84	37090-84	Late 84 FXST 1985-86 FX
17-9246	37089-84 37088-85	37090-84	1985-86 FLHT-FLT 1985-86 FXRS-FXRT 1985-86 FXRP-FLHTP 1986 FXST
17-9248	37089-84 37088-87	37090-84	1987-89 FLT-FXR-FXST
17-9249	37089-84 37088-90	37090-84	1990 FLT-FXR-FXST
17-9250	37069-90 37090-84A	37088-90	1991-97 FLT-FXR- FXST-FXD
17-9252	37069-90 37090-98	37088-90	1998-06 FLT-FXST-FXD
17-1545	—	—	2007-up 6 Speed



**Thrust Washer Bearing Kit** includes oversize washer and related parts.

VT No. 18-0261



**Oil Slinger** includes rod end. Replaces 37069-90. For 1990-up Big Twin.

VT No. 17-9255

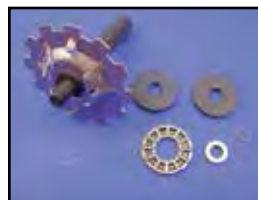

**1987-up Big Twin Clutch Release Kit** includes end rod with slinger, bearing, washers and snap ring.

VT No. 18-0260



**Big Twin Clutch Adjusting Screws** sold each.

VT No.	Years
18-3259	1985-90
18-3253	1991-up





**Chrome Smooth Contour Control Kit** features a hidden underside mounting on the switch housings for an unobstructed smooth, rounded surface on the top housing. Switch housings use stock or chrome rounded switches (introduced on 1996 models). Complete kits include clutch and brake levers, master cylinder, hydraulic clutch, switch housings, brackets and hardware. Master cylinder is 1 1/16" bore, hydraulic dual disc. Clutch handle is 1 1/16" bore.

VT No.	Style
22-0377	Milled
22-0378	Contour
26-0590	Lever Set



**Hydraulic Clutch Handle Kit.** Fits 1987-2006  
VT No. 26-0996



18-0675 Installed

# E-Z Clutch Control



**Soft Pull Clutch Ramp Kit** includes spring plate for 1998-up Big Twins.  
VT No. 18-0559



18-3232



18-3269



**E-Z Pull Clutch Assist** reduces manual effort required to pull the clutch lever by 40%. Mechanism fits inside transmission side cover and extends clutch operating mechanism for improved leverage.

VT No.	Year
18-3232	1987-99
18-3269	2000-12



18-0675



18-0362



18-0672



18-0571

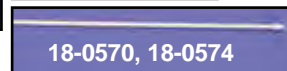

18-0570, 18-0574

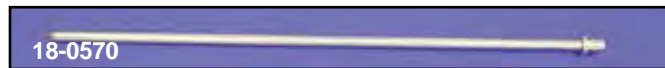
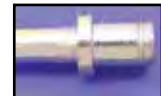

18-0570

**Components**

- 18-0672 Complete Hydraulic Handle
- 18-0362 Cover Only 1999-up TC-88
- 18-0675 Cover Only 1987-05
- 18-0676 Cam Cover, 2006-up 6 Speed
- 18-0570 Clutch Rod 1999-up 15.25"
- 18-0571 Hydraulic Clutch Fitting
- 18-0572 Clutch Rod, 1987-05 15.5" Long
- 23-1715 Rebuild Kit for 18-0672





# Rear Sprocket

9.8mm Offset



Chrome Lazer Design Rear Sprockets with 9.8mm offset for 1973-84 FX-FL or flat.

Offset	Flat	Teeth
19-0129	19-0132	48
19-0130	19-0133	49
19-0131	19-0134	51

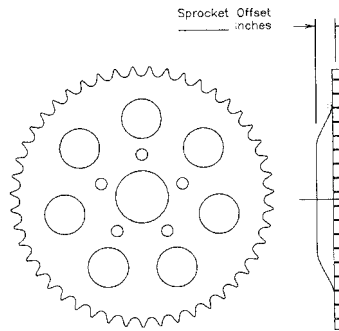

**Chrome 5-Spoke Sprockets.** Offset models have 9.8mm offset.

Offset	Flat	Teeth
<b>1973-99</b>		
19-0672	19-0674	48
19-0673	19-0675	51
<b>2000-up</b>		
19-0218	19-0251	48
19-0250	19-0221	51

## Transmission Sprockets

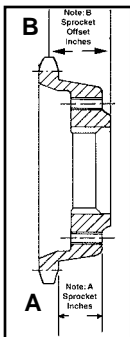

\*Note: To use on 1994-up models, Drive Sprocket Spacer & Seal must be changed to Pre-94 type.  
Seal: Replaces 12050  
VT No. 14-0157 Spacer:  
Replaces 33334-84  
VT No. 17-9851

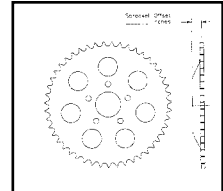

Offset Transmission Sprockets fit 1994-2003 Big Twin for chain drive conversion..900 offset is the maximum offset without any modification to the stock inner primary, to allow the installation of a 180 tire, without transmission offset. Fender modification may be required.

A	.250"	.500"	.810"	.900"	Teeth
	—	19-0400	—	—	21
	—	19-0401	19-0214	—	22
	—	19-0488	19-0215	19-0223	23
	19-0213	19-0489	19-0216	19-0224	24
B	.715"	.940"	1.236"	1.350"	

**Offset Sprocket Kit** with .200" offset for FXST and FXR.

Allows installation of 150 series tire by converting from belt to chain drive on 1986-99 FXST and 1985-94 FXR models. The stock final drive ratio is 2.1875 with belt drive and then new drive ratio will be 2.125 when used with 24 tooth front sprocket and 51 tooth rear sprocket and 2.00 when used with a 48 tooth rear sprocket. \*Note: Includes rear sprocket spacer.

VT No.	Item	Teeth
19-0164*	Drive Sprocket	22T
19-0402*	Drive Sprocket	23T
19-0122*	Drive Sprocket	24T
19-0128	Rear Sprocket Spacer	3/16"
19-0021	Rear Sprocket FXR	48T
19-0022	Rear Sprocket FXR	51T
19-0037	Rear Sprocket FXST	48T
19-0041	Rear Sprocket FXST	51T



**Rear Chain Tensioner** by LBV reduces chain vibration and frequency of adjustment by utilizing a durable urethane roller which revolves on sealed bearings mounted on stainless anchor plates.

VT No.	Year	Model
19-0433	1984-85	FXST
19-0436	Roller only	All



**6-Speed Transmission Sprocket**

VT No.	Tooth	Offset
19-0605	26T	Standard
19-0606	25T	Standard
19-0607	24T	Standard
19-0608	26T	1/2"
19-0609	25T	1/2"
19-0610	24T	1/2"

# Chrome Chain & Belt Sprocket Bolt Kit



BIG TWIN

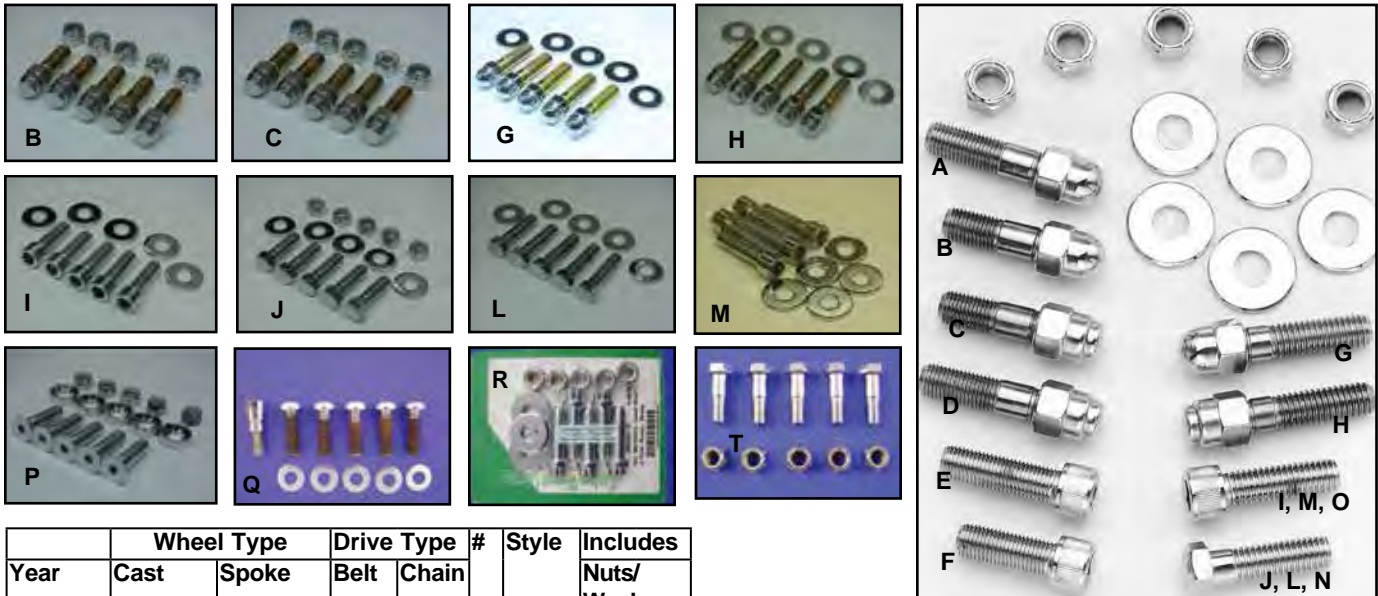

Year	Wheel Type		Drive Type		#	Style	Includes
	Cast	Spoke	Belt	Chain			
<b>FLH-FX-FXST-FLST</b>							
1985-92		8843-10	•		A	Acorn	•
1973-98		8834-10		•	F	Allen	•
1973-98	8835-10			•	I	Allen	•
1973-98	9608-10	9609-15	•	•	J	Dome	•
1993-96	2053-10			•	L	Dome	•
1985-92		8844-10	•		D	Cap	•
1985-92		8842-10	•		E	Allen	•
1973-up		8836-10		•	B	Acorn	•
1973-up	9857-10				P	Collar	•
1985-96	9858-15		•		P	Collar	•
1985-96	37-8671		•	•	Q	Torx	•
1985-96	37-9256	37-9254	•		R	12pt	•
1997-99	2053-10	2053-10	•		L	Dome	•
1997-99	2054-10	2054-10	•		M	Allen	•
1997-99	2054-10T	2054-10T	•		M	Allen	•
2000-06	2052-10	2052-10	•		O	Allen	•
<b>FXR-FXD-FXDWG</b>							
1985-96	9857-10	9858-15	•		P	Collar	•
1997-98	2054-10			•	M	Allen	•
1997-98	2053-10			•	L	Dome	•
1999	2053-10	2053-10	•		L	Dome	•
2000-up	2051-10	2051-10	•		N	Dome	•
2000-06	2052-10	2052-10	•		O	Allen	•
2006-06	2340-10	2340-10	•		O	Allen	•
<b>FLT</b>							
1985-92		8843-10	•		A	Acorn	•
1997-98	2053-10			•	L	Dome	•
1999-up	2053-10	2053-10	•		L	Dome	•
1997-98	2054-10				M	Allen	

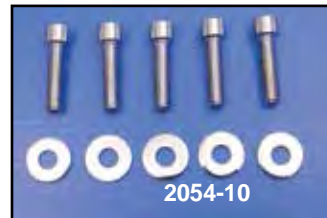

### 2000-up Pulley Bolt Kits.

VT No.	Type
37-0990	Allen
37-0031	Hex
37-8671	Button

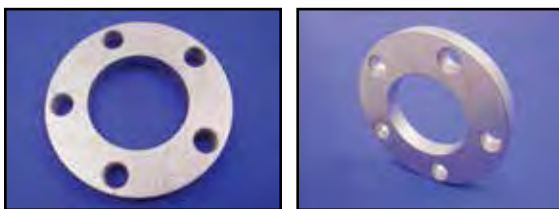

**Pulley Spacers** provide offset when required, with 7/16" bolt holes. Each disc measures 2 1/16" Inner Diameter with 4 5/16" Outside Diameter for 1980-99.

VT No.	Thick	Material	*Note: Use when installing flat rotor on 1973-75 Big Twin.
23-0320*	1/16"	Steel	
19-0128	3/16"	Steel	
19-0452	3/16"	Billet	
19-0413	1/4"	Steel	
19-2001	5/8"	Billet	

**2000-up Rear Pulley-Disc Spacers** with 2.25" inner diameter  
Sold as each.

VT No.	Thick
20-0346	1/16"
20-0347	.125"
20-0343	.200"
20-0344	.250"
20-0345	.300"

**Note:** Offset is measured from sprocket bolt mount surface to center line of teeth as shown.







# Chain Tensioner Primary Chain

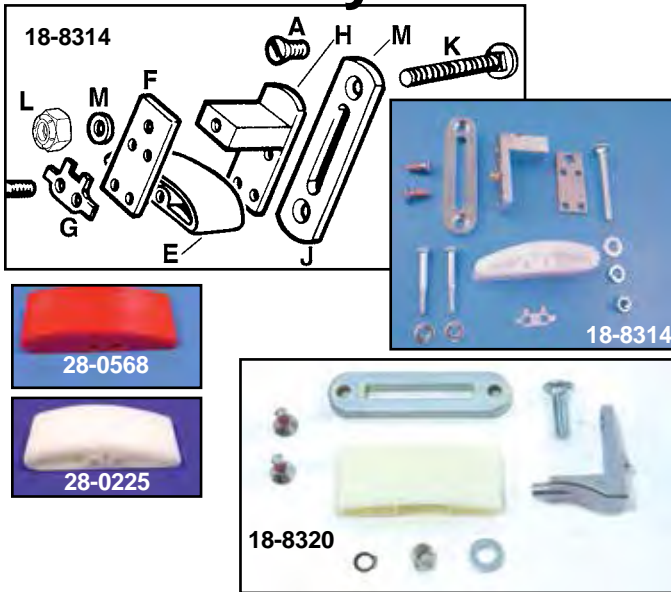

**York Chain Adjuster Kits** feature automatic self adjusting by use of spring loaded shoe.

**VT No. Year**  
**18-0580** 1965-00  
**18-0581** 2001-05  
**18-0582** 2007-up

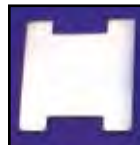

**18-0581**



**18-0580**

## Installation Instructions

1. Drain oil.
2. Remove the primary cover, the original adjuster shoe with the bracket and the carriage screw.
3. Install the longer carriage screw from the kit into the serrated adjuster pad.
4. Install the inner guide onto the carriage screw. Install the shoe with the springs onto the inner guide and place the outer guide onto the inner guide pins as shown.
5. Position the shoe, springs and guide assembly at the lowest point of possible adjustment on the pad. Install the original carriage screw lock nut and tighten it.
6. The amount of spring exposed from the bottom of the shoe will depend on chain wear. It should be 5/8 inch or less.
7. If more than 5/8 inch exists, raise the bottom of the spring by loosening the nut and raising the assembly for kit 18-0580 or by using shims provided for kit 18-0581. Make this adjustment until 5/8 inch of spring is exposed.
8. Replace the primary cover with a new gasket and fill it with oil to the proper level.

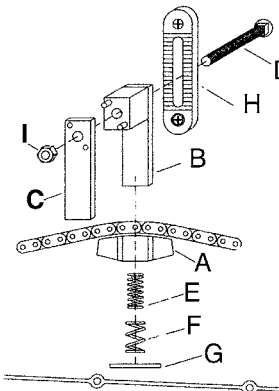

A	Shoe	1	
B	Inner guide	1	
C	Outer guide	1	
D	Carriage Screw	1	37-8802
<b>3/8 - 16 x 3"</b>			
E	Inner Spring	1	
F	Outer Spring	1	
H	Adjuster Pad	Not Included	
I	Lock Nut	Not Included	

A	Shoe	1	
B	Inner guide	1	
C	Outer guide	1	
D	Carriage Screw	1	37-8802
<b>3/8 - 16 x 3"</b>			
E	Inner Spring	1	
F	Outer Spring	1	
G	Shim	6	
H	Adjuster Pad	Not Included	
I	Lock Nut	Not Included	

**Chain Tensioner Parts** fits Big Twin models.

VT No.	#	OEM	Type	Years
18-8314		All	Complete Kit	1985-2000
18-8320		All	Complete Kit	2001-2005
18-3217		B-C-F-G	Hardware Kit	
37-9030	A	1783	Screw, 10 pack	
37-8801	B	3862B	Bolt, 5 pack	
18-3682*	C	4401W	Hex Bolt, each	
28-0225	E	39976-65B	Nylon Pad	1965-2000
28-0568		Red	Nylon Pad	1965-2000
28-0234	E	39976-01	Nylon Pad	2001-2005
17-0915	G	39996-65	Lock, 10 pack	
18-3218	H	39990-65	Shoe Mount Bracket	1965-2000
18-3219	F	39993-65	Plate	
18-3622	I	39992-65A	Nut and	
	J	39998-65	Anchor Plate	
18-3634	J	—	Anchor Plate with carriage bolt (K)	
37-8802	K	5444	Carriage Bolt, 5 pack	
18-3223	I	39992-65A	Nut Only	

\*Note: Early style Hex Bolt, screws into 18-3223 Nut.



## York Big Twin Hydraulic Primary Chain Tensionator™

features a hydraulic valve which controls the motion of the submerged piston which constantly keeps the chain in tension for 1965-up Big Twins.

**VT No. Item**

- 18-0120 Chain Tensionator
- 18-0128 Chain Tensioner Shoe

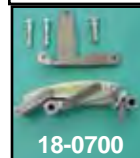

**18-0702**

## Automatic Spring Loaded Chain Tensioner.

**VT No. Year**  
**18-0700** 1985-05 Big Twin  
**18-0702** 2006-up FXD,  
 2007-up FXST



**18-8328**

**Manual Primary Chain Adjuster Kit** for all 2006-up FXD, FLT and 2007-up FXST, FLST with stock type spring loaded primary adjuster assembly allows precise adjustment of primary chain and creates less drag and loss of power like stock spring loaded assembly. **VT No. 18-8328**





# Primary Chain



BIG TWIN



**Primary Chain.** Made from select steel alloys that are light yet provide maximum strength. These primary chain has shot-peened, heavy-duty side plates and solid roller construction.

## Diamond Endless Primary Chains

VT No.	Size	Year	Model
19-0361	428x2-76	1979-06	FLT-FXR
19-0368	428x2-74	1994-06	FLT
19-0360	428x2-82	1986-06	Softtail
		1991-05	FXD
19-0786	428x2-92	2007-up	Softtail
19-0583	428x2-86	2007-up	FLT

TYK	Diamond	Fits	Links
19-0878	—	1980-06 FLT	76
19-0876	—	1980-06 FXWG and FXST	82
19-0933	—	1980-06 FXWG and FXST	84
19-0835	19-0786	2007-up FXST	92
19-0836	19-0583	2007-up FLT	86
19-0837	—	1994-06 FLT	74

## Replica Compensator Sprockets



### 1984-up Big Twin Compensator Engine Sprockets

VT No.	Teeth	Year	Type
19-0394	24	1985-93	FXR-FLT
		1991-93	FXST
19-0403	24	1984-90	FXST
19-0416	25	1994-01	All Big Twin
19-0585	27	1994-01	All Big Twin
19-0007	21	2002-06	Big Twin
19-0785	34	2007-up	FXST-FLST-FXD



**Compensator Sprocket Kit** includes all parts pictured with 24T sprocket.

VT No.	Fits
19-0300	1984-90 FXST
19-0301	1991-93 FXST
19-0102	1994-05 FXST Note: 25T
19-0584	2006-11 FXST-FLST-FXD, 2007-10 FLT
19-0923	2007-up FXST-FLST-FXD-FLT 30T, Solid Kit with primary chain
19-0586	30T Sprocket Only As Above



**Spline Engine Sprockets** fit 1955-up with spline.

VT No.	Teeth
19-0050	22
19-0051	23
19-0052	24
19-0053	25



### Big Twin Offset Motor Sprockets.

24T	25T	Offset
19-0135		1/4"
19-0104		3/4"
19-0105	19-0161	1"
19-0106	19-0162	1 1/4"
17-0945	17-0945	Nut Kit

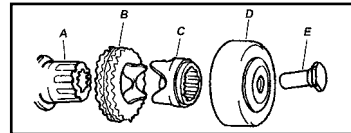

### Compensator Sprocket Parts.

VT No.	#	OEM	Item	Year	Model
19-0394	B	40269-85A	Sprocket	1985-93	FXR-FLT
				1991-93	FXST-Dynaglide
				1984-90	FXST
19-0403	B	40275-83	Sprocket	1994-01	Big Twin
19-0416	B	40308-94	Sprocket	2000-06	Big Twin
19-0007	B	40327-02	Sprocket	1984-06	
19-0395	C	40299-83A	Slide cam	1986-06	
19-0396	A	40266-85	Extension	1984-90	
19-0378	D	40384-83A	Retainer with cover		
19-0405	D	40384-91	As Above	1991-06	
12-0506	E	40392-70	Nut	1970-90	
12-0578	E	40392-91	Nut	1991-06	
12-0630		3594	Plate	2007-up	
12-0998		37810-08B	Retainer	2008-up	

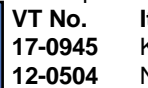
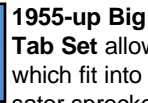

### Compensator Sprocket Motor Nuts.

VT No.	Year
12-0506	1970-90
12-0578	1991-06
12-1102	2007-up
12-1946	1970-90 (Chrome)



**Compensator Sprocket Kit.** Three piece design that eliminates spring and weight less than stock components. 34 tooth sprocket fits 2007-up FXST, FLST and FXD models.

VT No.	Type
19-0167	Kit
19-0171	Sifton Kit, 34 tooth
19-0175	34 tooth sprocket only
19-0586	30 tooth sprocket
12-1102	Bolt Set

**Order Spacer and Shims separately** for 1970-up.

VT No.	OEM	Size	Item
10-0427	24002-70		Spacer
10-0428	24032-70	.060"	Shim
	24033-70	.090"	Shim
	24034-70	.120"	Shim
	24035-70	.150"	Shim
	24036-70	.180"	Shim
	24037-70	.210"	Shim

Set of 6

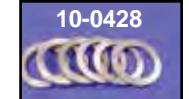

VT No.	Item/Fits
19-0299	Heavy Duty
19-0682	Stock Kit

**Compensator Sprocket Kit.** 34 Tooth engineered with heavier springs and increased travel. Stock Replacement for 2012-16 FXST-FLST, 2012-13 FXD, 2011-13 FLT. Can also be used to upgrade 2007-11 FXST-FLST and 2006-11 FXD to late type compensator. Heavy Duty Kit is should be used for higher than stock horse power engines.



# 3" BDL Belt Drive



20-0600

**BDL 3" Electric Start Belt Drives** with billet motor plate. Includes 8mm belt, polished motor plate, double row sealed mainshaft support bearing, polished side guard, polished dome pulley covers and Kevlar clutch. **\*Note:** Can only be used with 1991-up starter motor and some modifications will be necessary to install these kits.

VT No.	Year	Belt	Front Pulley	Rear Pulley
20-0600*	1985-89	20-0603	20-0900	20-0914
20-0601	1990-up	20-0603	20-0900	20-0914



**Sealed Inner Primary Bearing** fits York and BDL models.

VT No. 12-0993



**Round Dog Clutch Plate Set** includes steel and friction plates to fit BDL units.

VT No. 18-0701

## 8mm x 42mm BDL Belt Drive Kits



**BDL 8mm x 42mm Electric Start Belt Drives.** Includes a polished pressure plate, Kevlar clutch, sealed inner primary bearing and features a shorter length clutch hub that eliminates unnecessary weight past the end of the mainshaft and can be installed without any modifications to inner primary.

VT No.	Fits	Belt	Front Pulley
20-0605	1986-89 All FXST	20-0630	20-0902
20-0629	1994-up All FXST	20-0630	20-0902
18-0554	Replacement Clutch Pack for Above Units		



20-0090

**BDL Polished Billet Belt Drive Support** for all BDL Softail and Dynaglide belt drives. The support plate keeps the engine and transmission shafts from flexing. Each kit includes support plate, pulley covers, new pressure plate and hardware.

VT No. 20-0090



# Components for BDL



20-2052

**Chrome Out Board Support Kit** fits 3" BDL and York Unit  
VT No. 20-2052



**Chrome Billet Clutch Pressure Plate** fits BDL 4 Bolt Style.  
VT No. 20-2051



**Auto Slip Clutch** fits all BDL belt and York 3" drive units.  
VT No. Item  
20-2023 Kit  
20-2024 Plates (2)

**Note:** There is no warranty on belts when sold as part of kit or individual replacements.





20-0645

**BDL "Super Street" 3" x 8 mm Belt Drive** for 1990-2000 FXST models. Drive includes complete clutch pak featuring billet clutch basket and aluminum hub with nine (9) Kevlar clutch discs and eleven (11) steel plates, billet pressure plate, nine (9) clutch springs for unrelenting pressure, polished motor plate, polished clutch dome and polished belt guard.

**VT No. 20-0645**

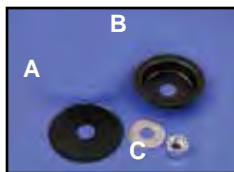

**BDL Front Belt Drive Parts**

VT No.	#	Item
20-0925	A	Inside Belt Guard
20-0926	B	Outside Belt Guard
20-0927	C	Motor Nut 55-up w/washer

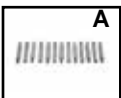

**BDL Belt Drive Parts**

- 20-0928 A Round Dogs 5-Speed
- 20-0929 A Round Dogs 4-Speed
- 20-0930 B Splined Hub 1990-up 3" only
- 20-0931 B Tapered Hub 1986-89
- 20-0932 B Tapered Hub 1965-83



20-0036



20-0038

**BDL Ball Bearing Lock-Up Clutch.** This ball bearing ramp style clutch set reduces clutch slip for a more positive clutch engagement. Available for all BDL belt drives with coil spring clutch except top fuel drives. All Primo belt drive and pro-clutches with diaphragm spring and all Big Twins 1998-07 with stock clutch pak.

**VT No. Fits**

- 20-0036 BDL Drives
- 20-0037 Primo Drives
- 20-0038 Stock Clutch 1998-07



**5 and 6 Speed Bearing Support Plate** for 1984-2000 Big Twins with kick start. Billet aluminum support plate includes bearing.

**VT No. 20-0250**

**Note:** There is no warranty on belts when sold as part of kit or individual replacements.



# BDL Belt Drives

14mm x 3 $\frac{3}{8}$ " Wide Drives



BIG TWIN



20-0635



20-0632

**BDL TF-1000 and TF-2000 "Top Fuel" Street Belt Drives** for 1991-up FXST. Features 14mm by 3 $\frac{3}{8}$ " wide belt, Kevlar Nine (9) Plate Clutch with eleven (11) steels, special pressure plate that uses nine (9) springs for varying spring pressure. Drive includes pulleys, belt, clutch pak, starter jack shaft, inner motor plate with oil filter mount pulley domes and side guard. Polished finish. The TF-2000 features out board bearing support and polished finish.

VT No.	#	Replacement Belt
20-0632	TF-1000	20-0127
20-0635	TF-2000	20-0127



20-0755



20-0005

**Chrome Belt Drive Cover Set** as shown,

VT No.	Style
20-0005	Smooth
20-0755	Flame



20-0900



20-0935

**BDL 3" Wide Offset Front Primary Drive Pulley.** Use with correct insert and nut for offset desired.

VT No.	Item
20-0900	Pulley Only, 47 T
20-0935	1/4" Insert and Nut
20-0936	1/2" Insert and Nut
20-0937	3/4" Insert and Nut
20-0938	1" Insert and Nut
20-0939	1 1/4" Insert and Nut
20-0940	1 1/2" Insert and Nut
20-0941	1 3/4" Insert and Nut
20-0942	2" Insert and Nut





# Brute V

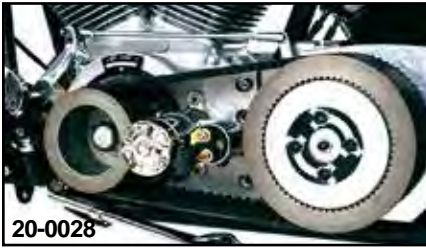

**Primo Brute V "Direct Starter Drive" Belt Drive Kit.**  
 Features a 78 tooth starter ring gear on the back side of front pulley and an inner primary mounted starter motor that allows a 54:1 starting ratio at the crank. Mechanical efficiency is improved 96% over stock type starter configuration. Drive kit includes chrome starter motor, 14 mm x 3 1/2" wide belt, front pulley, rear pulley, pro clutch 2 piece polished motor plate and belt guard.

VT No.	Fits	Guard Type
20-0027	2000-up FXST	Flame
20-0028	2000-up FXST	Smooth

**18-0556 Replacement Clutch Set** for all Brute III belt drives. Includes 6 fiber plate and 7 steel plates.



VT No.	Fits
18-0555	Early Style with Flange
18-0556	Late Style without Flange

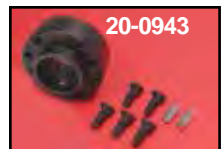

**Primo Offset Front Pulley Inserts** for 2.5" diameter Brute III and 3.0" inserts for Brute IV Pulleys. Special nuts and flanges (outside guide plates) are required.

Offset	Insert for Brute III Pulley	Insert for Brute IV Pulley	Special Motor Nut
1/2"	20-0943		20-0957
1"			20-0959
1 1/4"	20-0946	20-0953	20-0960
1 1/2"	20-0947	20-0954	20-0961
1 3/4"	20-0948	20-0955	20-0962
2"	20-0949	20-0956	20-0963
	20-0964	Outside Guide Plate	

# 3" Brute IV

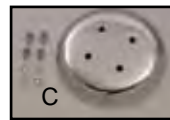
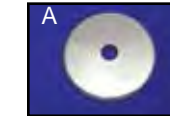
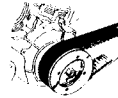

**3" Brute IV Primo Combination Belt Drive/Motor Plate Kit** includes inner motor plate, clutch pack, starter housing and chrome solid belt guard. Order chrome dome cover and rotor cover separately. Motor plate and starter housing have satin finish.

VT No.	#	Item	Year	Model
20-0209		Combination Kit	2000-up	FXST
20-0018		Combination Kit	1990-99	FXST
20-0105		Replacement Belt for Above Kit	1990-99	
20-0035		Combination Kit	1990-up	FXDG
20-0238	A	Alt. Rotor Cover	All	Chrome
20-0225	C	Chrome Dome	All	Chrome
18-0556		Clutch Pack	1990-up	All
20-0033		Ring Gear		66 Tooth



**Brute III from Primo Products** includes dry clutch pack pulley assembly which retains diaphragm spring function, while increasing the clutch friction surface area 70% for smooth light fingered action. Kit includes pulleys, 1 3/4" Kevlar reinforced rubber belt, complete clutch pack/pressure plate assembly and necessary hardware, bolt in kit. Available in 8 mm or 11 mm drive kits.

8 mm Drive Kits		
Kit	Repl. Belt	Fits
20-0665	20-0553	1984-85 FXSB-FXWG
20-0013	20-0553	1986-89 FXST
20-0016	20-0554	1986-89 FXR-FLT
20-0017	20-0554	1990-93 FXR, FLT
20-0015	20-0554	1994-06 FXR-FLT
11 mm Drive Kits		
20-0012	20-0553	1994-99 FXST, 1994-99 FXD
20-0666	20-0553	2000-06 FXST, 2000-05 FXD

**Note:** There is no warranty on belts sold when as part of kit or individual replacements.



# 3.5" Brute V



20-0680



20-0684

**Belt Guard Mounts** to Brute IV and V units.

VT No.	Style	Width
20-0680	Flame	3.5"
20-0682	Smooth	3.5"
20-0683	Flame	3"

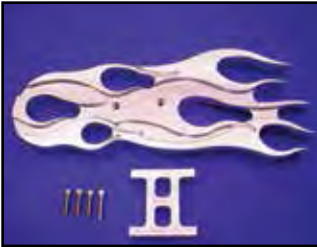

**Chrome Billet Aluminum Flamed Belt Guard.** The enhanced three dimensional characteristics of the guard allow you to customize the guard by applying paint or other effects to the recessed areas to match your existing custom paint job. Fits Primo Brute IV and Brute V

belt drives and includes Super Duty "H" mounting bracket.

VT No.	Fits
20-0025	Brute IV
20-0026	Brute V



**Outside Belt Guide Plate** is for all Primo 8, 11, and 14 front pulleys except taper shaft. **VT No. 20-0230**



20-0331



20-0331 Installed

**Polished Alternator Cover for Big Twins.** Use on all Cone motors. Designed to protect your alternator, also helps cooling by acting as a heat sink. Has a mounting lug for belt shroud built in.

**VT No. 20-0330**



**Chrome Big Twin Alternator Rotor Cover** presses over 1981-up rotors for tight fit. **VT No. 20-0216**



**Chrome Alternator Rotor Cover** fits major brand belt drive and open primary set ups. Installs to completely cover the steel alternator rotor. **VT No. 20-0238**



18-0200

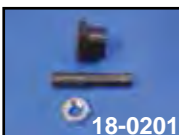

18-0201

**Primo Belt Drive Clutch Hub Nut and Adjuster Kit** will prevent oil leakage through the mainshaft when using a belt drive system. Kit includes clutch hub nut, seal and adjuster screw with nut.

Note: For Belt drive primary system only.

VT No.	Year	Mainshaft Type
18-0200	1984-89	Tapered (Seal Type)
18-0201	1990-up	Splined (O-Ring Type)

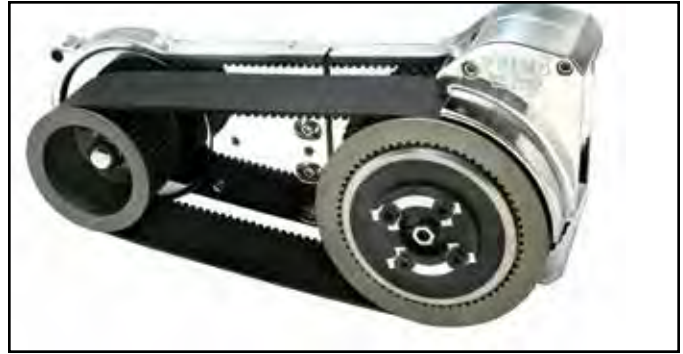

**Primo Brute V 14mm x 3 1/2 inch wide open "Super Street" Belt Drive.** Features diaphragm clutch spring that eliminates spring adjustment while distributing pressure evenly across clutch pak, motor plate, starter housing, hardware and outer guard. **\*Note** Can only be use with 1990-up starter.

VT No.	Fits	Replacement Belt
20-0075	2000-up FXST	20-0126



**Chrome Alternator Cover Set** includes polished outer housing and chrome rotor cover. **VT No. 20-0337**



**Belt Shroud and Side Guard Kit** for alternator Big Twins with 1 1/2", 2" or 3" open belt drives. Includes chrome belt shroud and polished side guard. **VT No. 20-0251**



27-1729

**Frame Mount Kickstand Stop** for use on all open belt drive Big Twin by clamping to frame tube. Fits 1 3/8" and must be cut to desired length. **VT No. 27-1729**



**Acorn Motor Nuts** for Big Twins with splined sprocket shaft. **VT No. 7816-1**



**Chrome Pike Motor Nut** fits Big Twin 1955-up sprocket shaft. **VT No. 37-0890**



12-0588

**Sealed Clutch Drum Bearing** for belt drive applications on Big Twins.

VT No.	Years
12-0587	1985-90
12-0588	1991-up

**Note:** There is no warranty on belts when sold as part of kit or individual replacements.





# Belt and Pulley Kit

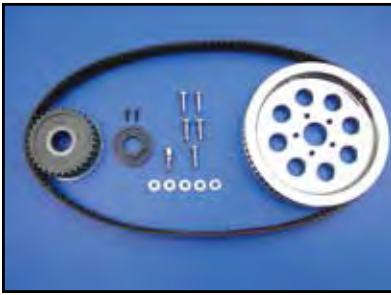

**1986-up Rear Belt and Pulley Kits** for Softtail models. Kits include transmission pulley with locknut kit, rear pulley in chrome or natural finish and Dayco belt.

VT No.	Year	Type	Tooth	Width
20-0314	1986-93	Alloy Pulley	32-70	1.50"
20-0315	1986-93	Chrome Pulley	32-70	1.50"
20-0317	1994-99	Alloy Pulley	32-61	1.50"
20-0298	1994-99	Chrome Pulley	32-65	1.50"
20-0698	2000-05	Chrome Pulley	32-70	1.125"
20-0748	2007-up	Chrome Pulley	32-66	20mm

**Note:** There is no warranty on belts sold when as part of kit or individual replacements.

## Front Pulleys



**Final Drive Front Pulleys** available for Big Twin models as supplied by V-Twin, Karata, Andrews or BDL. All BDL pulleys are 1/8" lighter than stock. Include nut, lock plate and screws. Stock Size Pulley Noted by \***Note:** Nut lock plate and screws sold separately.

# of Teeth	84-93 BT Karata 5-speed	84-93 BT V-Twin 5-speed	84-93 BT Andrews 5-speed	84-06 BT BDL 5-speed	94-06 BT Andrews 5-speed	94-06 BT V-Twin 5-speed	07-up V-Twin 6-speed	07-up Andrews 6-speed
28	—	—	—	—	—	—	—	—
29	—	—	20-0700	20-0703	20-0709	—	—	—
30	20-0481	20-0734	20-0701	20-0704	20-0710	—	—	20-0728
31	—	—	—	20-0705	—	20-0733	—	—
32	—	20-0447*	—	20-0661*	—	20-0706*	20-0696	—
33	—	—	—	20-0707	—	—	—	—
34	—	—	20-0702	20-0708	20-0711	—	—	20-0729
35	—	20-0735	—	—	—	—	—	—



**Front Pulley Lock Plate Kit.**

VT No.	Year
20-0338	1994-06
20-0389	1984-93

**Big Twin Drive Pulley Kits** include pulley which accepts 1.125" or 1.5" wide belts, indexing nut seal and seal spacer as required. Fit 5-Speed, 32 tooth.

VT No.	Year
20-0721	1984-93
20-0722	1994-06



**Pulley Indexing Flange Nut** allows drilling and tapping of additional set screw locations.

VT No.	Year
20-0214	1993-06
20-0215	1993-06
20-0217	2007-up

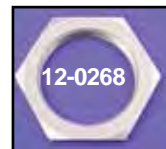
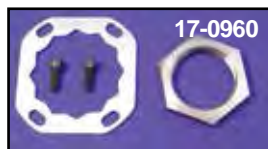

**Front Belt Lock Plate and Nut Kit** includes 2 allen screws, sprocket lock nut and lock plate.

VT No.	Item	Year
20-0308	Kit	1993-06
17-0960	Kit	2007-up
17-0934	Lock Only	1993-06
17-0959	Lock Only	2007-up
12-0268	Nut Only	2007-up
12-0579	Nut Only	1991-06
37-0429	Set Screw	2007-up



**Big Twin Front Pulley Conversion Kit** allows use of 1994-06 front pulley on 1984-93 models.

**VT No. 20-0432**



Final Drive Belts by BDL, Carlisle, Goodyear, Gates or OE.



# Rear Belt



BIG TWIN

Carlisle	Goodyear	BDL	VT No.	Width	Teeth	Brand
<b>Big Twin, 1½" Wide</b>						
20-4010	—	20-0441	136	1984-96	FLT-FLHT	
20-4011	—	20-0440	132	1986-92	FXST-FLST, 1994 FXST	
20-4012	—	20-0120	126	1980-86	FXSB-FXWG	
20-4013	—	20-0478	133	1991-99	FXD	
20-4014	—	20-0479	128	1993	FXST-FLST	
20-4017	—	20-0501	130	1995-99	FXST-FLST	
20-4015	20-0725	20-0500	127	Ratio Change		
20-4016	20-0726	20-0455	135	Ratio Change		
20-4018	—	20-0579	139	1997-03 All FLT		
<b>Big Twin, 1⅝" Wide</b>						
—	—	20-0582	135	2000-05 FXST-FLST, 2000-06 FLST		
—	—	20-0586	133	2000-06 FXD		
—	—	20-0668	139	2004-06 FLT		
<b>Big Twin 20 mm Wide</b>						
—	—	20-0786	135	2006-up FXST		
—	—	20-0787	133	2007-up FXST		
<b>Big Twin 1" Wide</b>						
—	—	20-4019	133	2007-11 FLST		
—	—	20-4020	137	2007-08 FLT		
—	—	20-4021	140	2009-up FLT		
—	—	20-4022	131	2007-up FXD		
<b>Big Twin 24mm wide</b>						
—	—	20-4023	133	2012-up FXST, FLST		



**Narrow Belts.**

VT No.	Width	Teeth	Brand
20-0456	1.125"	125T	BDL
20-0060	1.125"	128T	BDL
20-0592	1.125"	130T	OE

**Note:** There is no warranty on belts when sold as part of kit or individual replacements.

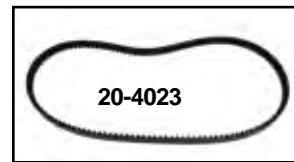

# Rear Pulley Spacers



**Pulley Spacers** provide offset when required, with 7/16" bolt holes. Each disc measures 2 1/16" inner diameter with 4 5/16" outer diameter. For 1980-99.

VT No.	Thick	Material
23-0320	1/16"	Steel
19-0128	3/16"	Steel
19-0452	3/16"	Billet
19-0413	1/4"	Steel
19-2001	5/8"	Billet



**Pulley Adapter Ring** will adapt the 2000-up 1.125" wide types to 1999 and earlier wheel hubs, which will allow use of a 170 mm wide tire on 1999 and earlier applications.

VT No. 20-0342



**Chrome Cast Big Twin Rear Axle Reinforcement Collars** fit Softail models, and include bolts and bearings to act as outboard bearing support for stock or long axles or wide conversions. VT No. 44-0145



20-0343



20-0147



20-0145



20-0146

**2000-up Rear Pulley-Disc Spacers**, sold as each.

VT No.	Thick	Type
20-0346	1/16"	Steel
20-0347	.125	Steel
20-0343	.200	Steel
20-0344	.250	Steel
20-0345	.300	Steel
20-0136	.500	Alloy
20-0148	.500	Steel
20-0143	.750	Alloy
20-0144	1 5/16"	Alloy
20-0145	1"	Alloy
20-0146	1 1/4"	Alloy
20-3088	1.00"	Alloy
20-3090	1 3/8"	Alloy
20-0147	1 1/2"	Alloy



20-0148



20-0641



20-0640

**Pulley Adapter Flange.** 20-0641 allows use of late model 1 1/8" wide pulley on early wheel. 20-0640 allows the use of any combination of early or late wheel pulley or sprocket combination.

VT No.	Thick	Piece
20-0641	3/8"	3
20-0640	1/4"	2



**1980-99 Polished Pulley Spacers** are threaded to adapt pulley to hub. This offers extra support as it uses 2 sets of bolts to mount.

VT No	Thickness
20-0130	1/2"
20-0129	1 1/16"
20-0132	1"
20-0134	1 3/8"

# Tools



**Belt Tension Gauge** designed to aid in properly adjusting belt tension on models with a secondary drive belt.

VT No. 16-1765



**Big Twin Final Drive Tool** fits final drive pulley, so the nut can be properly set to torque specifications. Replaces 41184.

VT No. 16-0649



# Rear Pulley

# 2000-up Rear Pulley for Softail models



**5 Spoke Billet Chrome Rear Pulley** fits 2000-05 with 1.125" width belt.

VT No.	Tooth
20-0689	68
20-0354	70

**Big Twin Rear Drive Pulley** for 2000-up models 70T unless noted.

VT No. Year Width Finish  
FXD

20-0678	00-05	1.125	Chrome
20-0716	00-05	1.125	Chrome
20-0649	00-05	1.125	Chrome, 66T
20-0647	06-up	1.125	Chrome



**Chrome Billet Rear Pulley** features spoke design. Pulleys with 2 1/4" inner diameter fit hubs with 1" bearings on 2000-up models.

VT No.	Tooth	Year	Belt	Spoke
20-0691	65	2000-05	1.125"	18
20-0717	70	2000-05	1.125"	None
20-0379	61	2004-06	1.25"	18

**Big Twin Rear Drive Pulley** fit Big Twin models, 1986-99.  
1.5 Wide

VT No.	Teeth	Finish
20-0597	61	Natural
20-0313	65	Chrome
20-0353	65	Chrome
20-0434	65	Chrome
20-0671	65	Chrome
20-0675	70	Chrome
20-0452	70	Silver
20-0498	70	Chrome
20-0352	70	Chrome
20-0674	70	Chrome



**Chrome Pulley** fits FXST, with 20mm wide belt.

20-0692	2006-up	70T
20-0697	2007-up	66T



**Pulley Adapter Ring** will adapt the 2000-up 1.125" wide types to 1999 and earlier wheel hubs, which will allow use of a 170 mm wide tire on 1999 and earlier applications.

VT No. 20-0342





# Pulley Cover

BIG TWIN

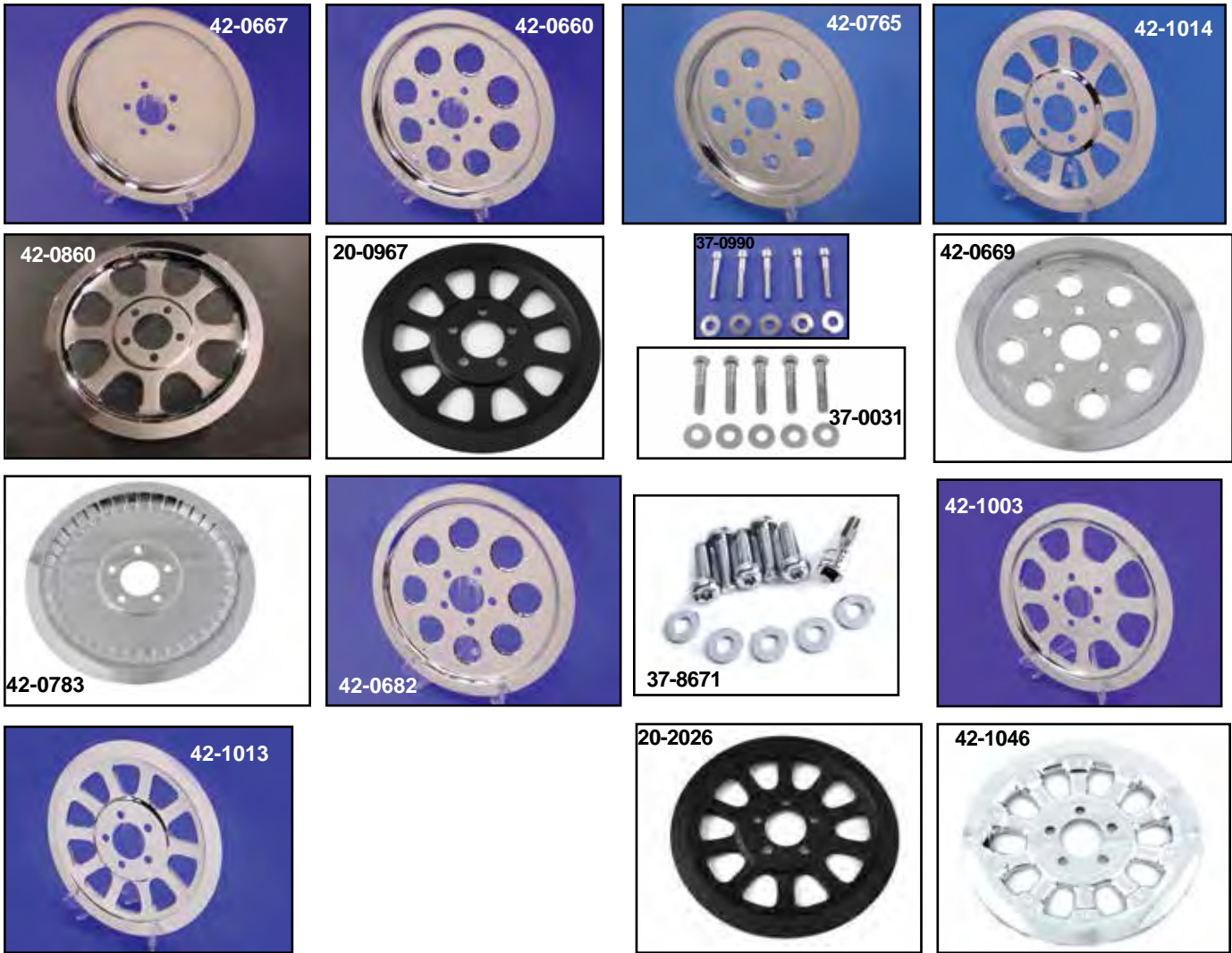

## Outer Pulley Cover.

VT No.	Tooth	Fits/Type
<b>FXST-FLST</b>		
42-0667	70	1984-93 FXST-FLST, Smooth, 1991-99 Dynaglide
42-0660	70	As Above
42-0765	65	1995-99 FXST-FLST
42-1014	66	2007-up FXST
42-0860	70	2000-06 FXST-FLST
20-0967		2007-up FXST, Black
37-0990		Allen Bolt Kit
37-0031		Hex Bolt Kit
42-0669	61	1990-99 FXST 11" OD, .984 Deep
42-0783	70	2000-up FXSTD
42-0682	70	2000-05 Dynaglide
37-8671	70	Chrome Torx bolt kit with socket
20-0832	20-0751*	2007-up FLT *Note: Glossy Black

## FXD

42-1003	70	2006 FXD
42-1013	70	2007-up FXD
20-2026	70	2007-up FXD, Black
42-1046	70	2007-up FXD-FXDWG



**Chrome Inner Pulley Insert** fits inside 70T rear pulley. VT No. 42-0535



**Chrome Inner and Outer Pulley Covers** allow both sides of 70 tooth pulleys on 1980-99 Big Twin to be covered with inserts to match to stock hole pattern for the look of a completely chrome pulley.

VT No.	Type
42-0660	Outer Cover
42-0752	Inner Cover





# Shifter Bracket



**Chrome Frame Mount Shifter Brackets** as stock replacements or when installing forward controls. The 21-0105 and 21-0101 are the exact FXST-FXWG type which features footpeg boss welded to shift plate, stock on 1980-up models which have corresponding brake unit. Order inner shift arm separately.

VT No.	Style	Fits
21-0101	Heavy	1984-89 FXST
21-0111	Black	Custom Applications
21-0105	Stock	1990-99 FXST
21-0123	Stock	2000-06 FXST
21-2061	Stock	1986-99 FLST
37-9104	Nylon	Inner Outer Washer Set



**Chrome Jiffy Stand and Shifter Mount Plate Bolt Kit** to attach assembly to left side of frame.

VT No.	Type	Year
7803-11	Acorn	1936-99
9617-18	Hex	1936-99



### Shifter Bracket Bushing

VT No.	Fits
10-2511	1985-93 FXST
10-2561	1994-up FXST-FLST

## Inner Shifter Arms



**Chrome Inner Shifter Arms** fit through frame mount shifter plates on Big Twins and feature splined ends.

VT No.	Year/Model
17-9770	1984-94 FXR
21-2065	1986-up FLST
21-2074	1990-99 FXST 1993-02 FXDWG
21-0794	2003-up FXDWG
21-0743	2006-up FXDWG
21-0675	Solid, 2000-06 FXST
21-0676	Slotted, 2000-06 FXST
21-0880	Solid, 2007-up FXST



**Chrome Replica Foot Shifter Lever Cover** fit 1986-99 FLST.  
VT No. 42-0433



**V-Twin Shifter Kit** includes 5 small and 5 nylon washers to reduce vibration at inner shift arm and pedal.  
VT No. 37-9104

# Shifter Rod Ends



**Ball End Swivel** with 5/16 x 24 thread.  
VT No. Thread  
21-2077 Left Hand Short Stud  
21-0548 Left Hand Long Stud



**Chrome Forked Rod End Clevis** is threaded 5/16 - 24 for use on shifter rod. Pin size is 1/4.  
VT No. 21-2033



**Clevis Pins**, zinc plated includes cotter pins and washers.  
VT No. Use  
23-0421 1930-69 Brake, 1982-up Brake  
1952-84 Shifter  
21-1986 1970-81 Brake



**Shifter Rod Jam Nut Set** features tapered design to cover excess rod thread, pair, 5/16 x 24 thread.  
VT No. 37-0863

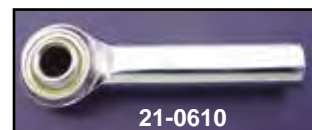
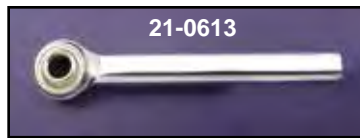

**Self-Aligning Rod Ends.** Heim joint type swivel allows alignment up to 28° off center. Self lubricating brass ball socket available for shifter or brake rod ends, 5/16 x 24 or with 5/16 hole. 21-2016 has 5/16 x 24 stud.

VT No.	Size
21-0613	5/16" x 24 x 2"
21-0610	5/16" x 24 x 51.4mm
21-0611	5/16" x 24 and 48mm
21-2016	1984-94
21-2020	Custom
21-0547	5/16 x 24 x 3/8
21-0549	5/16 x 24 x 5/8

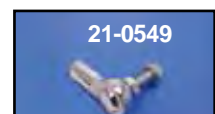



# Billet Shifter Lever



**Chrome Billet Shifter Lever** features slotted design. Fits 1990-up FXST and 1991-up FXDWG. **VT No. 21-0670**



**Slotted Billet Lever** with cats paw footpeg. **VT No. 21-0691**



**Chrome Billet Shift Lever** fits 1990-up FXST and 1991-up FXDWG models. **VT No. 21-0221**



**Billet Lever with Cats Paw Footpeg** for 1990-up FXST, 1991-up FXDWG. **VT No. 21-0690**

## Stock Shifter Lever



21-0311



21-2063



21-2056



21-2068



21-0307



21-0793



21-0302

### Chrome Shifter Levers for Big Twin models.

- | VT No.  | Fits/Type                                   |
|---------|---|
| 21-0311 | 1984-85 FXST, not threaded                  |
| 21-2068 | As Above, Stainless Steel                   |
| 21-0302 | 1986-89 FXST                                |
| 21-2063 | 1990-up FXD-FXST Spline                     |
| 21-0307 | 1982-94 FXR Spline                          |
| 21-2056 | 1987-up FLST Heel and Toe                   |
| 21-0793 | 1990-05 FXD Heel Toe fits only with 27-0920 |



21-0684



**Heel Shifter Lever** features swivel peg location to fold out of the way. Fits 1986-up FLST.

**VT No. 21-0471**

- | VT No.  | Item                                  |
|---------|---------------------------------------|
| 22-0452 | BRAKE CONTROL KIT, BLACK              |
| 22-0498 | FOOT CLUTCH CABLE BRACKET, BLACK      |
| 22-0585 | HANDLEBAR CONTROL KIT, CHROME         |
| 22-0816 | HANDLEBAR CONTROL KIT, SMOOTH CONTOUR |
| 23-0673 | PAD PIN KIT, FRONT OR REAR            |
| 23-0721 | UPPER BRAKE HOSE                      |
| 23-0815 | REAR CALIPER KIT, CHROME              |
| 23-0871 | FORWARD BRAKE PEDAL                   |
| 23-0935 | WHEEL LUG BOLT SET, PARKERIZED        |



21-0687

### Shifter Rod Kit Flame Style

- | VT No.  | Fits               |      |
|---------|--------------------|------|
| 21-0684 | FXDWG 1993-2005    |      |
| 21-0686 | V-ROD 2002-up      |      |
| 21-0687 | 2000-up FXST, FLST | 12½" |
| 21-0688 | 2000-up FXST, FLST | 13½" |

**Chrome Billet Forward Control Kit** has bullet foot pegs and a 3/4" master cylinder. Order shifter rod, brake lines and kickstand assembly separately. Fits custom application.

**VT No. 22-0995**



# Shifter Rod Kit for ST

Complete Chrome Shifter Rod Kits as listed below include rod and ends.

## FXD-FXDWG Shifter Rod Kits

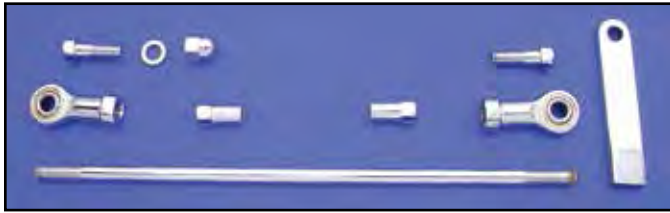

**Chrome Shifter Linkage Kit** replaces original shift linkage on 2000-up Softail models and 1980-up FLT-FLHT models and replaces 33814-98A.

VT No.	Type
21-0502	Kit
21-0791	Rod Only

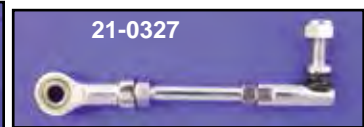
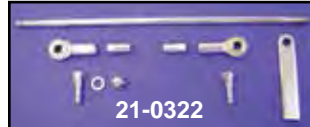

### Shifter Rod Sets.

VT No.	Year	Model	Finish
21-0322	1991-05	FXDWG	Chrome
21-0327	1991-05	FXD	Chrome
21-0328	1991-05	FXD	Zinc
21-0300	1991-05	FXD	Stainless Steel
21-0338	2006-up	FXDWG	Chrome



**Billet Twisted Shifter Linkage** fits 1986-up Softail.  
VT No. 21-0228

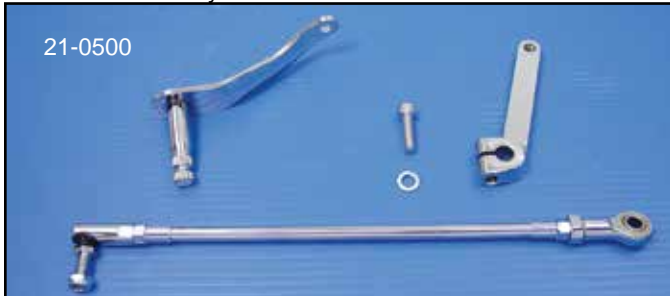

**Chrome Shifter Arm and Linkage Kits** include inner arm, inner shifter lever, rod with ball and swivel ends.

VT No.	Model
21-0500	1986-up FXST
21-0501	1990-up FLST

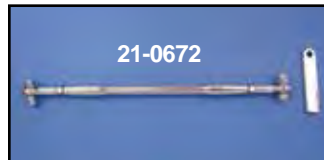

**Chrome Billet Shifter Rod Kits** includes heim joint ends. Stock length rod is 10<sup>5</sup>/<sub>16</sub>" long.  
VT No. Length  
21-0672 Stock  
21-0678 Stock  
21-0223 Extension +2"



**Chrome Shifter Rod Kit** fits 1980-up FLT and 2000-up Softail.  
VT No. 21-2039

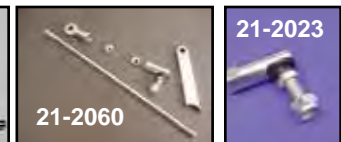

**Chrome FXST Shifter Linkage** includes transmission arm cover, rod, two swivel ends and nuts. Parts sold separately.

VT No.	#	Item
21-2060	A, B, C, D	Rod Kit with cover
21-2031	B, C, D	Rod Kit only
42-0722	A	Arm Cover only
21-2022	B	Rod only
21-2020	C	Swivel End
21-2023	D	Ball Joint End
21-2028	E	Inner Lever

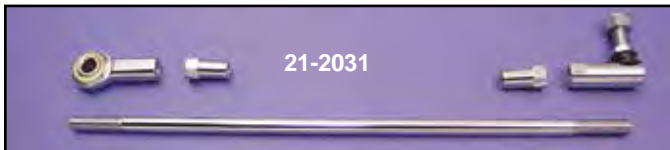

**Chrome Shifter Rod Kit** fits 1985-99 FXST-FLST.

VT No.	Item
21-2031	Kit
21-2022	Rod Only

# Shifter Rods

**Straight Shifter Rods** are 5/16" diameter with 5/16" x 24 thread at each end. \*Note: Offset

VT No.	Length	Finish
21-0324	3 <sup>5</sup> / <sub>8</sub> "	Chrome
23-0252	7 <sup>3</sup> / <sub>4</sub> "	Chrome
23-0934	8 <sup>1</sup> / <sub>4</sub> "	Chrome
23-0253	10 <sup>1</sup> / <sub>2</sub> "	Chrome
23-0255	11"	Stainless Steel
21-0546*	11 <sup>1</sup> / <sub>4</sub> "	Chrome

VT No.	Length	Finish
21-0330	11 <sup>3</sup> / <sub>4</sub> "	Chrome
21-2022*	12"	Chrome
21-0321	12"	Chrome
21-0333	12 <sup>1</sup> / <sub>2</sub> "	Chrome
21-0334	13 <sup>1</sup> / <sub>2</sub> "	Chrome
23-0257	14 <sup>1</sup> / <sub>2</sub> "	Chrome
21-0332	20 <sup>1</sup> / <sub>4</sub> "	Chrome



**Chrome 5/16" Shifter Rod Extension** with male and female ends.



VT No.	Length
21-0270	2"
21-0271	3"





# Forward Control Set



22-0755 Right

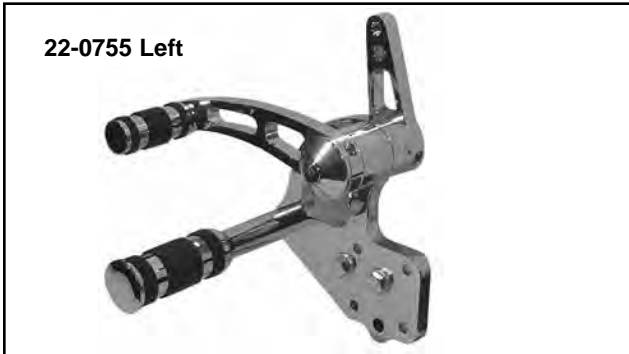

22-0755 Left

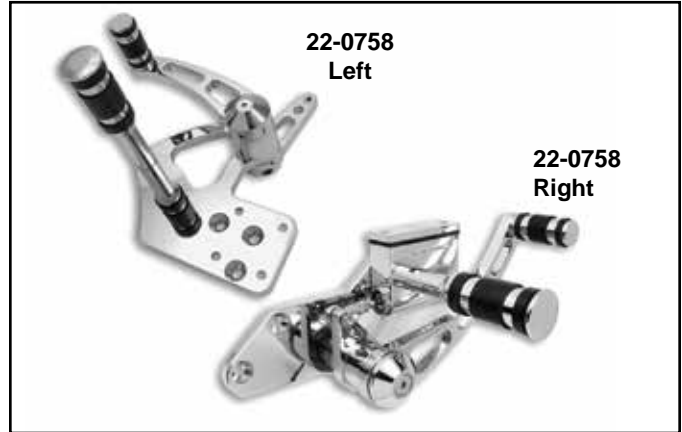

22-0758 Left

22-0758 Right



22-0758 Installed Right



22-0760 Installed Right



22-0758 Installed Left

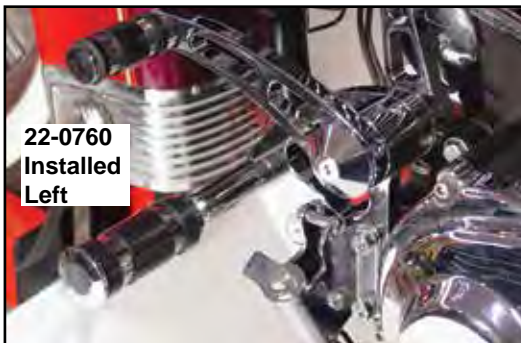

22-0760 Installed Left



22-0767 Right

22-0767 Left



22-0760 Left

22-0760 Right

**Chrome Billet Forward Control Set** fits 1986-99 Softail, 1958-84 FX-FL. Includes rubber belted pegs as shown. Includes left and right sides complete with master cylinder. Order shifter rod and stainless steel brake lines separately.

**Note:** 3" extended units 22-0758 not suitable for FLST models with stock fender.

VT No.	Position
22-0760	Stock, Note: this is chrome
22-0755	+2"
22-0767	+2" with Pirate Pegs
22-0758	+3"

**Chrome Shifter Rod, Stock**

- 21-2031 1986-up Softail
- 21-0220 1986-99 Softail
- 37-6500 Replacement Mounting Bolts

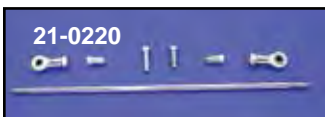

21-0220

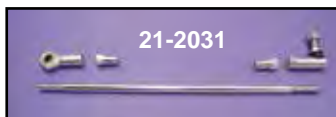

21-2031



# Billet Forward Control Kit

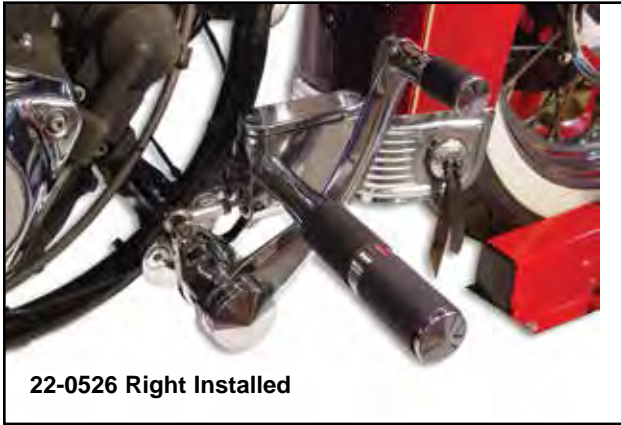

22-0526 Right Installed



22-0526 Left Installed

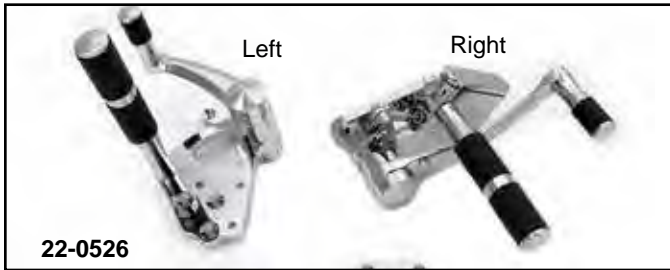

22-0526

**Billet Shifter Rod Kit** fits 2" and 3" extensions.

**VT No. 21-0223** fits 1986-99 Softail.

**Replacement Hardware**

- 23-3005 Master Cylinder Only (3/4")
- 23-0859 Master Cylinder Kit (3/4")
- 23-0574 Master Cylinder Top Only with Top and Screws
- 28-0607 Matching Grip Set
- 27-0615 Matching Passenger Peg Set
- 21-0673 Shift Peg
- 28-0634 Shift Peg Rubber
- 21-0677 Shift Lever, Inner
- 21-0154 Shift Lever
- 23-0773 Brake Plunger Rod
- 21-0785 Plunger Clevis
- FXST Brake Line Required Components**
- 23-0946 Spike Brake Pad
- 23-4050 Banjo 10mm 35°
- 23-8120 Stainless Line 32"
- 23-9228 T Fitting
- 23-4396 Line Fitting
- 23-8020 Stainless Line 12"
- 23-4047 Banjo 10mm Straight



21-0223 Billet Rod

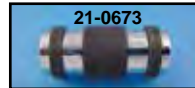

21-0673



27-0615



22-0767 Right

22-0767 Left

**Chrome Billet Forward Control Set** for 1986-99 Big Twin.

VT No.	Extended
22-0767	2"
22-0526	3"



21-0223 Installed

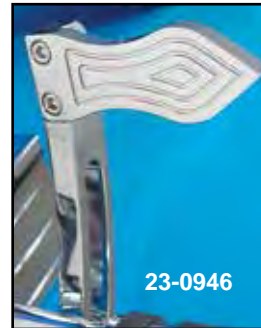

23-0946

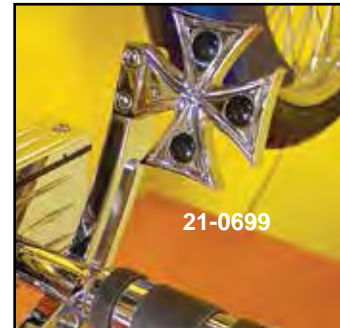

21-0699

**Brake Pedal Pad**

VT No.	Style
23-0946	Pirate
21-0699	Maltese

### Behind the Scenes at V-Twin Mfg.



<http://www.youtube.com/watch?v=oyA9qU7Y4q0&list=UUoK-fvCXCqOKPF5smOwNON1A&feature=share&index=1>



# Forward Control Kits for 1982-99 FXST



22-0493 Right

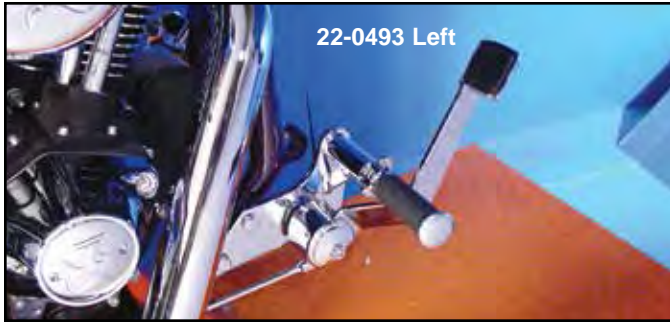

22-0493 Left

**V-TWIN KITS**  
Since 1978  
**THEY'RE STILL**  
**THE BEST WAY...**



22-0493

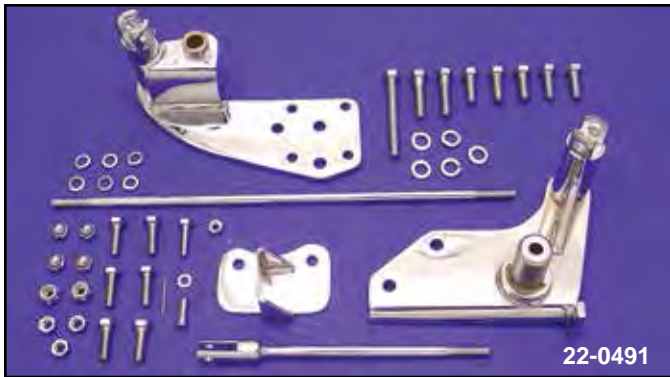

22-0491

**Extended Forward Controls For FXST.** Designed for riders over 6 ft. tall. These chrome units extend the footpegs 4" forward and keep the right and left peg parallel while retaining stock peg to pedal distance. Extension kits utilize stock brake pedal shifter arm and lever. Brake and shifter plate supplied in heavy 5/16" steel along with longer brake and shift rods. Fits FXST, FXSTC and FXSTS. Also available in complete units with all hardware, for both sides.

- | VT No.   | Year/Type                      |
|----------|--------------------------------|
| 22-0490* | 1986-Early87 Extension Kit     |
| 22-0491  | 1987-99 Extension Kit          |
| 22-0492* | 1986-Early87 Complete assembly |
| 22-0493  | 1987-99 Complete assembly      |

\*Note: Above models fit 1986 models when oil filter on shift side is relocated. Can fit 1984-85 models if master cylinder bracket is fabricated and welded in place.

**Chrome Billet Forward Control kit** includes shift and brake side controls. Kit is stock length with rods included. Fits 1987-99 FXST.

VT No. 22-0860



22-1085

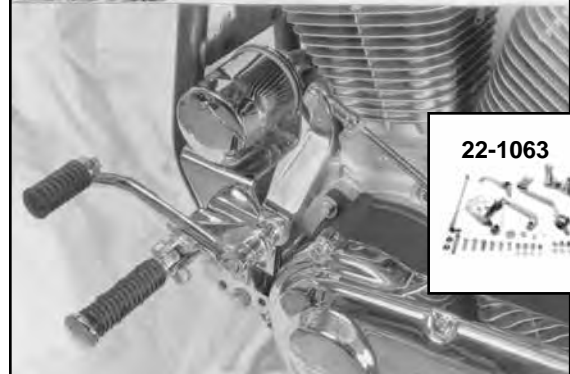

22-1063

**FXST Chrome Replacement Style Forward Control Kits** include mounting brackets, levers and correct linkage for 1982-99 FXWG and FXST models. Master cylinder not included.

- | VT No.  | Fits         |
|---------|--------------|
| 22-1062 | 1982-Early87 |
| 22-1063 | 1987-89      |
| 22-1085 | 1990-99      |

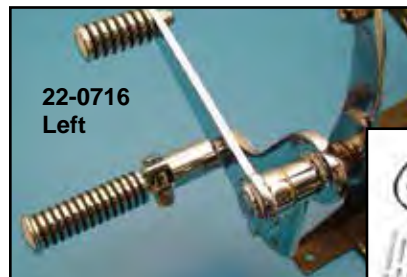

22-0716  
Left

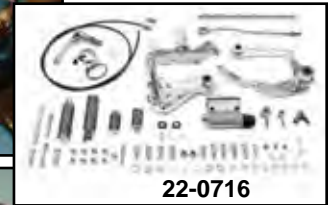

22-0716

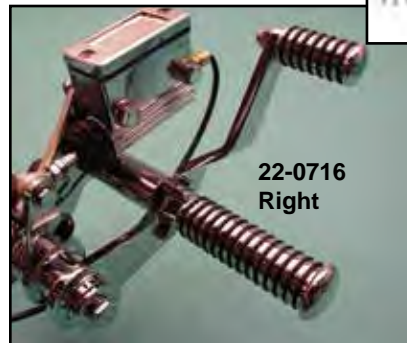

22-0716  
Right



21-0109

**Chrome Forward Control Kit** fits 1958-86 Big Twins, 1986-99 FXST. Includes shift and brake sides including 3/4" bore chrome Kelsey Hayes style master cylinder. Kit is supplied with O-ring pegs, but can be replaced with other style of clevis mount pegs. A universal nylon brake line kit, chrome mount hardware and 4 and 5 speed styles shift rods are also included.

- | VT No.  | Item             |
|---------|------------------|
| 22-0716 | Kit Complete     |
| 21-0109 | Shift Lever Only |





# Shifter Kit



**5-Speed FXST Replica Forward Shifter Kit** is complete with all hardware necessary for installation on 1981-up 5-speed Big Twins. Use in conjunction with

our FXST Replica Controls listed on the opposite page, as all kits place pegs in a forward position. Foot rests on peg while shifting for added comfort. This is an exact stock replacement in chrome for 1984-up FXST. Kit includes chrome heavy duty shifter bracket, inner lever, shifter lever, rod, rubber shift peg and foot peg.

VT No.	Fits
22-1004	1981-99 FXR
22-1006	1985-89 FXST
22-1009	1990-99 FXST

**V-TWIN KITS**  
Since 1978  
**THEY'RE STILL**  
**THE BEST WAY...**

2000-06



22-0522



22-0523  
Chrome Kit

**Brake and Shifter Kits.** Order footpeg, left and right side separately.

VT No.	Item	Item	Type
22-0523	Kit	Chrome	Shift
22-0522	Kit	Chrome	Brake

## Extension Bracket Sets



**3" Extension Kit** fits 2000-06 FXST.  
VT No. 22-0305



**2000-06 3" Extension Kit** moves controls 3" forward for FXST-FXSTD-FXSTC-FXSTB.  
VT No. 27-0566



**2" Forward Control Extension Bracket** will relocate the stock or custom forward controls 2" forward on 1936-99 Big Twin models. Note that hoses and linkage will also have to be extended.  
VT No. 27-0594

Shift Hardware.

VT No.	OEM	Item
22-0523	Kit	Chrome
17-9300	6057	Nylon Washer
14-0913	11191	O-Ring
21-2074	33660-90B	Shift Lever
21-0111	33683-00	Lever Bracket
10-2561	33708-94	Bracket Bushing
21-2039	33719-79A	Shifter Rod Kit
21-2063	34564-90A	Shift Lever Arm
21-0317	34611-65	Shifter Rubber

10-2561



31-0201

31-0264

31-0282

31-0983

31-0933



**Remote Inspection Tag Holder First Offered by V-Twin Mfg. in 1969**

**Inspection Tag Plate** is available in stainless or chrome. Measuring 3 1/2" square with 1/2" or 3/8" mounting hole which can mount to footpeg or shock studs. 31-0282 is square type which clamps on to 1" to 1 1/8" tube with worm clamp included.

VT No.	Item	Type
31-0201	Stainless	.5"
31-0264	Chrome	.5"
31-0983	Chrome	3/8"
31-0282	Chrome	Clamp
31-0933	Black	.5

# 1986-99 Forward Control for FLST

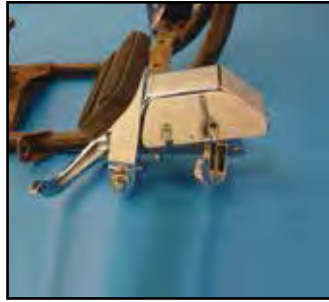
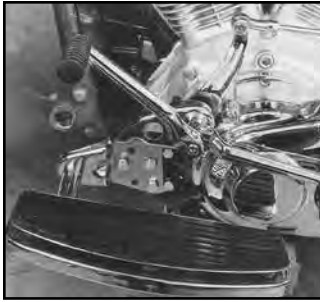

**Brake Side Kit** includes black or chrome backing plate, chrome pedal, chrome master cylinder and cover. Related hardware included. Order line separately.

VT No.	Item
22-0507	Complete Kit
22-0512	Complete Kit with chrome plate

**Brake Side Components 1986-99 FLST.**

23-9229	42407-87B	Brake Pedal Chrome
28-2233	42416-83	Rubber for above
23-9235	42431-87	Mount Plate, Black
23-9246	42431-87A	Mount Plate, Chrome
23-9236	50992-87	Rod End
23-0650	42468-87	Master Cylinder
28-2005	40922-87	Rubber Boot
42-0316	41745-79	Master Cylinder Cover
23-8822	40957-87A	Brake Line
23-9234	42301-87	Master Cylinder Stud
23-0759	5797A	Pedal Washer

**FLST Brake and Shifter Control Mounts** use these brackets and mounts to put FLST Controls and floorboards on 1984-99 FXST 5-Speed models. Order components separately or as kits. Floorboards not included.

**Shift Side Kit** includes chrome shift mount plate, 2 chrome shift levers with rubbers, chrome floorboard mounts, chrome inner and rod assembly. Related hardware included.

**Shift Side**

**VT No. 22-0508**

**Shift Side Components 1986-99 FLST.**

VT No.	OEM	Item
21-2061	33630-90	Shift Mount Plate
27-1692	50990-86B	Floorboard Mount Strap
27-1690	50989-86	Mount Stud
21-2065	33668-90A	Inner Shift Lever FLST
21-2042	33895-82	Lever, 2 used
21-2031	11729	Chrome Shift Rod Kit with Ends



## 2" Extension Kits



**FLST Foot Control/Floorboard Extension Kit** for 1986-99 models. 2" extension kit includes adapter plates and shifter rod.  
**VT No. 22-0307**

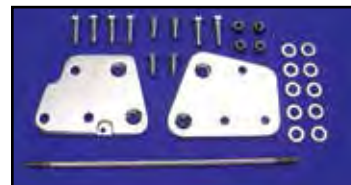

**2" Footboard Extension** moves controls 2" forward for 2000-2006 FLST.  
**VT No. 22-0306**



**COLONY**

**Chrome Hardware Kits** for 2002-up V-Rod by Colony

VT No.	Item
2154-3	Front Axle Nut & Spacer Kit
2156-4	Rear Axle Nut & Spacer Kit
2158-11-P	Rear Shock Mount Kit
2160-1	Motor Oil Filter Plug & Dipstick
2161-2	Front Axle Cover Set
2167-2	Upper Case Plug
2171-17-P	Clutch Cover Mount Kit
2172-16-P	Alternator Derby Cover Mt Kit
2173-3-P	Sprocket Cover Mounting Kit
2175-4-P	Fork Bracket Mount Kit
2176-8-P	Frame Assembly Kit
2177-8-P	Shifter Mount Kit
2178-4-P	Headlamp Mount Kit
2179-7-P	Windshield Mount Kit
2180-12	Handlebar Master Cylinder Cover Allen Screws
1021-P	Polished Allen Show Bike Kit
2168-22-P	Polished Cam Cover Mount Kit

## For V-Rod



**Shock Absorber Mounting Kit** includes spacers, allen polished screws, washers and nut. Fit 2002-up VRSCA. **VT No. 2158-11-P**



**Motor Oil Filler Plug/Dipstick** with O-Ring. Replaces 26541-01K. Fits 2002-up VRSCA. **VT No. 2160-1**



**Rear Axle Covers** add a smooth, finished look. Easily installed with a set screw. Fit 2002-up VRSCA. **VT No. 2163-2**



**Rear Axle Nut and Spacers Kit** available with smooth spacers. Replaces 43571-01 and 40437-01 spacers. Fits 2002-up VRSCA. **VT No. 2156-4**



**Chrome Hose Shield** fits V-Rod models. **VT No. 42-0965**



**Front Axle Nut and Spacers Kit** available with grooved or smooth spacers. Replaces 43642-01 spacers. **VT No. Type**  
2153-3 Grooved  
2154-3 Smooth



**Upper Crankcase Plug and Gasket Kit.** Custom knurled and decorative chrome plug with gasket. replaces 1034M and 6298M. **VT No. 2167-2**





# 2000-up Forward Control for FLST



**Chrome Brake and Shifter Mount Plates** replace original units on FLST models.

VT No.	OEM	Side	Years
23-0095	42431-00	Right	00-06
21-0122	33630-00	Left	00-06
21-0126	—	Set	00-06



**2000-06 Brake/Shifter Side Components** for TC-88 models FLST, FLSTF, FLSTS. FLST style controls accept footboards.

**Brake, FLST**

VT No.	OEM	Item
22-0520	Kit	Chrome

**Shifter Side**

22-0521	Kit	Chrome
---------	-----	--------

**Shifter Side Components 2000-up FLST.**

VT No.	OEM	Item
17-9300	6057	Nylon Washer
14-0913	11191	O-Ring
21-0110	33630-00	Lever Bracket, 2000-06
21-2039	33719-79A	Shifter Rod Kit
21-2065	33668-90B	Shifter Lever, 2000-06
10-2561	33708-94	Bracket Bushing
21-2042	33895-82C	Shifter Lever Arm (2)
21-0317	34611-65A	Shifter Rubber



**Shifter Cover Kit** fits 2000-06 FLST.  
VT No. 42-0900

**Brake Side Components FLST, 2000-up.**

VT No.	OEM	Item
12-0597	7951	Jam Nut
12-0987	40918-87	Retaining Ring
13-9170	40920-87	Return Spring
28-2005	40920-87	Pushrod Boot
23-0458	41755-99	Master Cylinder Assembly, 2000-05
23-7740	41957-97	Pushrod Kit
28-2233	42416-83	Brake Lever Pad FLST, 2000-05
23-0095	42431-00	Foot Brake Mount FLST, 2000-06
23-0010	42454-99	Reservoir, 2000-05
15-0540	42455-99	Gasket Reservoir, 2000-05
23-0460	42597-00	Chrome Brake Lever FLST, 2000-06
23-0768	45149-99	Chrome Reservoir Cover, 2000-05
44-0557	50972-75	Grease Fitting, 2000-05
14-0568	41731-88A	Gasket, 2000-06
23-0612	41747-82A	Banjo Bolt
23-9177	42382-87B	Rebuild Kit, 2000-05
23-0405	42460-80B	Clevis Pin
32-0443	72023-51C	Stoplamp Switch

# 2000-up FXST Control Pieces



**Chrome Brake and Shifter Mount Plates** replace original units on FXST models.

VT No.	OEM	Side	Year
21-0250	33920-00	Right and Left	2000-06
23-0094	42507-00A	Right	2000-06
21-0123	33683-00	Left	2000-06
22-0829	—	Kit, Left	2000-06

**Brake Side Components FXST 2000-up.**

VT No.	OEM	Item
12-0597	7951	Jam Nut
12-0987	40918-87	Retaining Ring
13-9170	40920-87	Return Spring
28-2005	40920-87	Pushrod Boot
23-0458	41755-99	Master Cylinder Assembly, 2000-05
23-7740	41957-97	Pushrod Kit
23-0094	42507-00	Foot Brake Mount FXST, 2000-06
28-0548	42532-82	Brake Lever Pad FXST, 2000-05
23-0010	42454-99	Reservoir, 2000-05
15-0540	42455-99	Gasket Reservoir, 2000-05
23-0459	42515-00	Chrome Brake Lever FXST, 2000-06
23-0768	45149-99	Chrome Reservoir Cover, 2000-05
44-0557	50972-75	Grease Fitting
14-0568	41731-88A	Gasket
23-0612	41747-82A	Banjo Bolt
23-9177	42382-87B	Rebuild Kit, 2000-05
23-0405	42460-80B	Clevis Pin
32-0443	72023-51C	Stoplamp Switch

**Chrome Forward Control Bracket Set** fits 2007-10 FXST. Reuse of forward control components necessary.

VT No.	Item	Type
22-0742	Bracket Set	Extended 2"
23-1210	Brake Line	Extended 2"



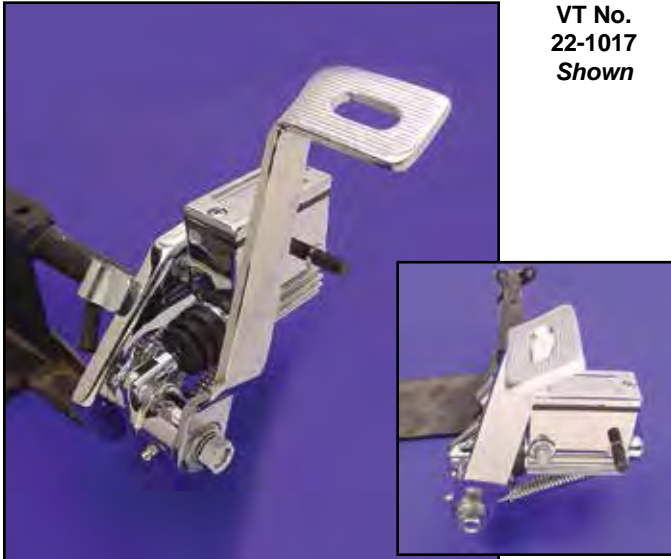

VT No. 22-1017 Shown

# Forward Brake Kit



22-0506 Installed



22-1017



22-0505



**Original Forward Brake Control Assemblies** will equip all Big Twins with hydraulic brakes and powered by either 1970-83 Shovel or 1984-99 Evolution engines. Available in either Wagner or Kelsey Hayes styles, with or without master cylinders. Footboards can be fitted to our Wagner style kits VT No. 22-0500, 22-0505 or 22-0506. Wagner styles use 41761-73 master cylinder, or Kelsey Hayes type 41576-79A, for those wishing to utilize their existing master cylinder. Complete assemblies include detailed instructions and diagram for installation. Display packaged.

VT No.	Type	Master Cylinder
22-0500	Wagner	Without
22-0505	Wagner	With Plain
22-0506	Wagner	With Chrome
22-0501	Kelsey Hayes	Without
22-1017	Kelsey Hayes	With Chrome

**\*Note:** For kits 22-0500, 22-0505, 22-0506, 22-0501, and 22-1017, use Russell front line 23-8809 and rear line 23-8915 for disc brake models and tee 23-0707.

**Footpeg Mounting Studs** fit through Wagner or Kelsey Hayes master cylinders to mount foot pegs to these forward assemblies. Stud side shown accepts that size footpeg yoke.

VT No.	Type
37-8986	Kelsey Hayes Type 3/8 - 24
37-8987	Wagner Type 1/2 - 20



22-1015



22-1008

**Original Forward Shifter Control Kit.** FLH type allows the use of foot pegs. Order complimenting forward brake control on opposite page. Units allow 1 down and 3 up shifting pattern. The 22-0801, and 22-1055 kits include proper ratchet arm and dust cover. All other kits attach to existing components on shifter mechanism. Instructions and diagram included with each kit. Display packaged! 5-Speed

VT No.	Fits
22-1015	1982-94 FXR
22-1008	1985-99 FXST

**No Mix-Ups No Searching One Kit Does It All For Less!** Shifter kit on this page is compatible with VT No. 22-0500, 22-0501, 22-0505, 22-0506, 22-0510, 22-0511 and 22-0512. **Note:** FLH models 1979-83 rotary transmission tops have the down turned shifter top arm. Check motorcycle or your factory parts book for correct application.



22-0772 Installed

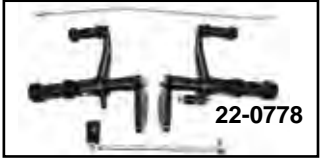

22-0778

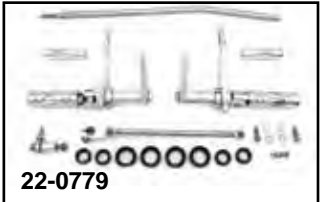

22-0779

**Billet Forward Control. Black Polish Fits**  
22-0772 22-0777 1984-99 FXST, FLST  
22-0778 22-0779 2003-2013 FXD



# Forward Control for FXR-FXRS



22-0761

Right



Left

22-0761

1982-94 FXR Billet Forward Control includes master cylinder.

**VT No. Item**

22-0761 Kit

21-0223 Rod

23-0859 Master Cylinder Rebuild

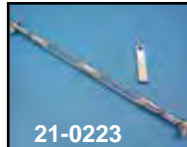

21-0223

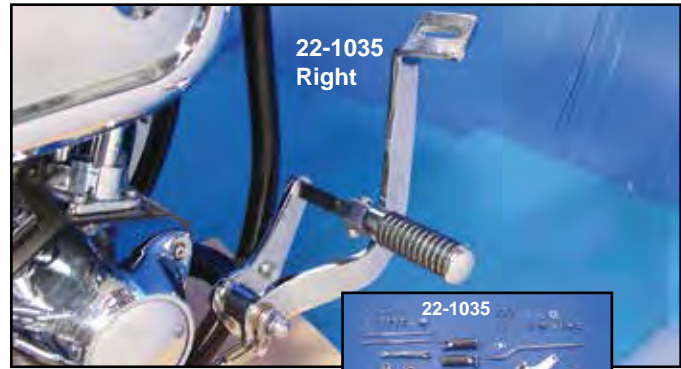
22-1035  
Right

22-1035



22-1035 Left



22-1004 Shift

**Chrome FXR Forward Control Set.** Complete chrome set brake and shifter units are a replica of the comfortable FXST style which has pegs in full forward position. Features one piece brake rod which adapts directly to stock master cylinder, No need to relocate master cylinder on all 1982 and later FXR-FXRS-FXRT also 1985 FXS-FXE. Chrome cover included to cap shifter shaft after installation.

VT No.	Year	Type
22-1074	1982-E87	FXR Set
22-1004	1982-up	Shift Side
22-1073	1988-up	Brake Side
23-0251	1982-up	Brake Clevis



22-0782

**FXR-FXRS Forward Control Set** fits all 5-Speed FXR-FXRS series Shovelhead or Evolution powered 1982-up. Installation does not require the primary cover to be removed. All parts are chromed and the footpegs provided are "O" ring style, does not fit Dynaglide.

VT No.	Year/Model
22-1035	1982-94 FXR Chrome
22-0782	1982-94 FXR Black

**Shift Shaft Cover.** Chrome acorn style has 1/2" inner diameter to fit over unused shifter shaft in primary cover when installing forward controls. Sold each. VT No. 37-8872



## Covers for FXR



**Chrome Left Side Frame Cover** for all 5-Speed FXR 1984-94. Fits directly under the standard left side frame cover. Supplied complete with chromed button head allen hardware, and an allen key wrench.

VT No. 42-0008



43-0233

**Cast Inner Primary Cover** fits 1990-93 FXR.  
VT No. Finish  
43-0233 Inner  
43-0204 Outer Chrome



**Chrome Oil Tank** fits 1982-94 FXR models. Includes mounting hardware and hose. Replaces 62406-81.

VT No. 40-0094



42-0100

**Chrome Steel FXR and FXRS Side Cover Set** fits 1984-94 FXR-FXRS. VT No. 42-0100



**Chrome FXR Driver Footpeg Mount Brackets** fit 1982-94 all FXR. Use with male style pegs.  
VT No. # OEM Type  
27-0640 A 50531-81 Right Mt  
27-0639 B 50636-81A Right Ext  
27-0638 C 50639-81 Left Ext  
27-0641 A,B,C 3 Piece Set



**FXR Passenger Footpeg Kit** includes chrome brackets and bolts, which moves passenger footpeg higher and more forward. Stock or custom 1/2" stud footpegs can be used.

VT No. 27-1531





# 5-Speed Foot Clutch Control Kit

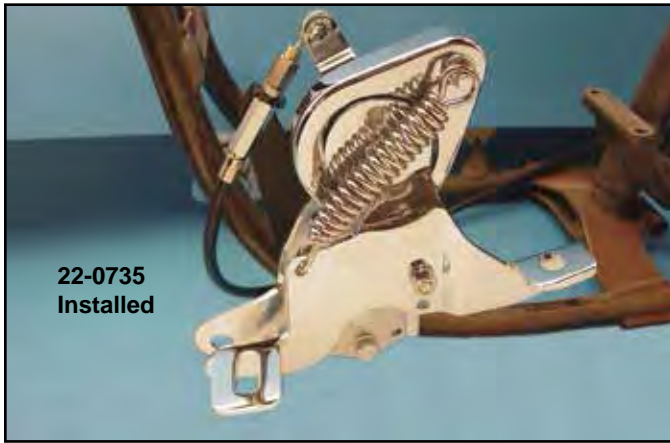

22-0735  
Installed

**Note:** Clutch is disengaged in heel down position.



22-0499

22-0727  
1986-99  
Softail Kit

**Note:** Clutch is disengaged in heel down position.

**1986-99 Softail Foot Clutch Kit** includes chrome rocker assembly, cable bracket and spacer block.

VT No.	Finish
22-0727	Chrome
22-0732	Black



22-0735

**Slap Stick Jockey Kit** includes assembly with jockey handle for 5 Speed 1989-99 Big Twins models.

VT No. 22-0735



**Left Side Frame Spacers** will position forward pedals for primary clearance.

VT No.	Height
21-0175	.50"
21-0313	1.25"
21-0178	1.75"

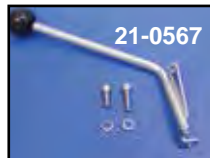

21-0567



21-0570

**Jockey Handle** includes knob.

VT No.	Model	Speed
21-0567	1986-05 FXST-FLST	5
21-0570	1986-up FXST-FLST	5 & 6
21-0589	1980-up FLT	6



**Billet Jockey Shifter Kit** includes top mount and rod for 1986-99 Softail models. Order knob separately.

VT No.	Item
21-0180	Kit
21-0129	Lever Assembly

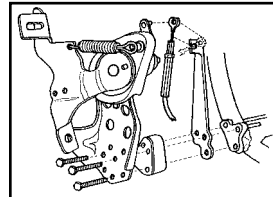

**Foot Clutch Conversion Kit** allows use of Police Rocker Clutch VT No. 22-0720 or 22-1016 on 1987-99 FXST-FLST where the clutch cable goes directly into transmission side cover. Kit includes bracket and cable. May not be used with front engine bar.

VT No.	Item
22-0499	Kit (Bracket and Cable)
22-0720	Rocker Only
36-0516	Cable Only
21-0162	Spacer Block (0.75")
21-0313	Spacer Block (1.25")
21-0178	Spacer Block (1.75")



22-0720  
Installed



22-0720

**Rocker Type Clutch Pedal Assembly.** Replaces 36810-65A for 1936-78 Big Twins. When installed on any 1965-78 FL, 18-3606, clutch release arm must be used. Order appropriate rod separately. For 1965-up primary applications order VT No. 21-0313 alloy spacer block separately.

VT No.	Item
22-0720	Chrome Complete
22-1016	Black, with Chrome Spring Friction Cover
22-0997	Parkerized Replica

## Rubber Pad Sets



**Clutch and Brake Pads** in a three piece sets.

VT No.	Color	Item
28-0301	Black	Three piece
28-0302	White	Three piece
28-0551*	Black	One piece *Note: Oval Pad only
28-0312	Black	Three piece, Replica



28-0301  
Left Side



Right Side





# Foot Clutch Control Kit

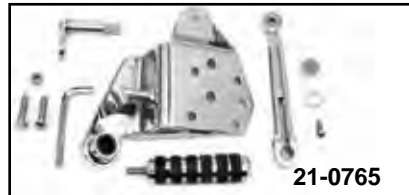
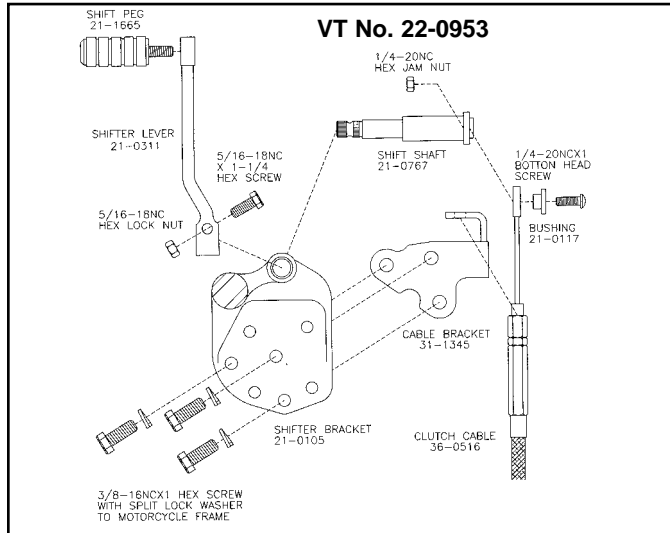
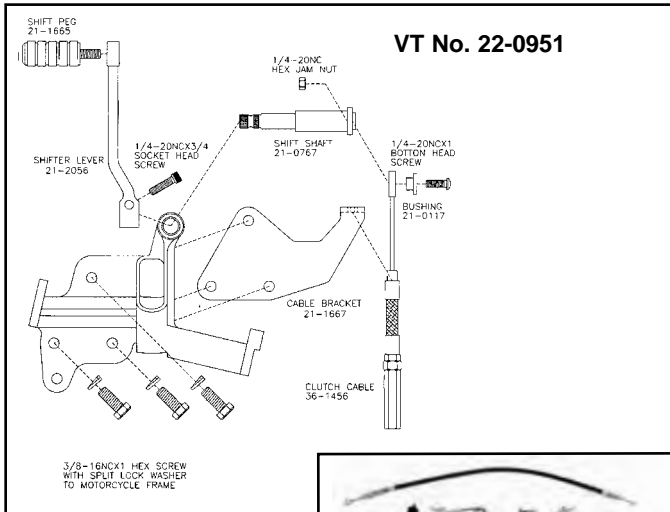

**VT No. 21-0765**  
**VT No. 31-1345**  
**VT No. 21-1667**  
**VT No. 21-0767**



**Jockey Kits** include shifter peg.

VT No.	Year	Model	Type
22-0950	1986-99	FLST	Footboards
22-0951	2000-06	FLST	Footboards
22-0952	1986-99	FXST	Footboards
22-0953	1990-99	FXST	Pegs
21-0765	1980-99	FX	Pegs
31-1345	1990-99	ST	Bracket
21-1667	2000-06	ST	Bracket
21-0767	1990-99	ST	Shaft

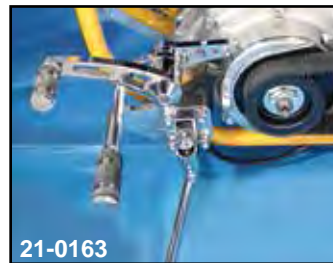

**Jockey Pedal Conversion Kit** allows conversion of shift side of our Big Twin extended 2" and 3" forward controls to operate as foot clutch. Kit includes splined inner billet arm, black bracket and black cable with ends. Order shift arm or kit separately for appropriate year.

VT No.	Year	Type	Model
21-0151	1987-up	5 Speed	Softail
21-0163	1979-84	4 Speed	Big Twin
36-0516	All	Cable	



**Chrome Billet Spacers** fit left side shift (3 hole) and right side brake (2 hole) for 1984-99 Softail.

Shift	Brake	Thick
21-0175	21-0164	0.50"
21-0165	21-0166	0.75"
21-0169	21-0170	1.25"
21-0171	21-0172	1.5"



# Softail Jockey Shift Kit

BIG TWIN

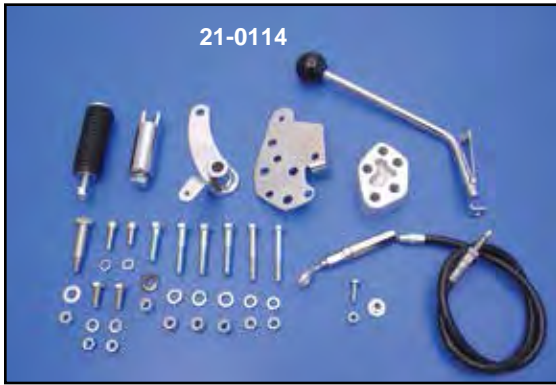

21-0114



22-0711  
Installed

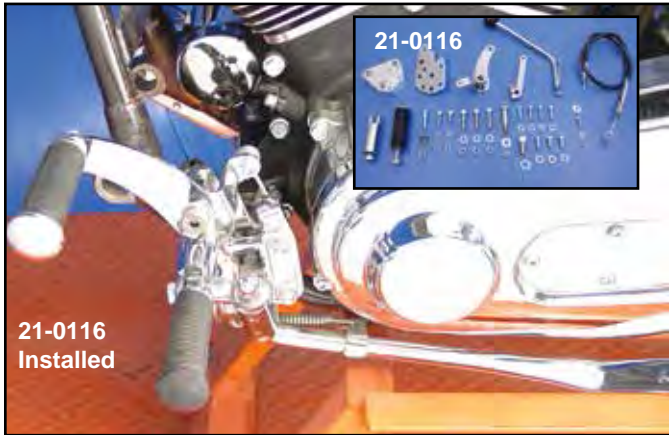

21-0116  
Installed



21-0116



22-0712



22-0712  
Installed



36-0516

**Jockey Pedal/Handle Kit** fits FXST models. Includes chrome pedal, plate, cable and chrome handle. Order skull knob separately VT No. 21-2015.

VT No.	Item	Years
21-0114	Kit	1986-99
21-0116	Kit	2000-2006
21-0570	Handle Only	6-Speed
36-0516	Cable	1986-up
21-0117	Cable End Bushing	



36-1456

**Braided Foot Clutch Cable** fits 22-0953 kit.

VT No. 36-1456

### Jockey Shifter Knobs.

VT No.	Style	Thread
21-2082	Black	1/2 - 20
21-2084	Brass	3/8 - 24
21-2011	Black, large	3/8 - 24
21-1936	Black, small	3/8 - 24



21-2011



21-1936

**Police Style Jockey Shift Kit** clamps to all Big Twin front frame with 1/8" tubes for 4-Speed ratchet type, 4-Speed rotary and 5-Speed model. VT No. 22-0711 and 22-0712 feature a smooth gate for shifting. Use either rocker clutch pedal or jockey pedal will fit with 3.5 or 5 gallon tanks.

VT No.	Year	Speed	Type	Tank
22-0710	1936-79 only	4	Handshift	5
22-0711	1952-79 Big Twin	4	Ratchet Top	5
	1979-84 FLH	4		
22-0712	1979-84 FXE	4	Rotary	5
	1979-84 FX-FLST	5		
	1984-2012 FXST			
	1986-2012 FLST			
22-0737	1979-84 FLT	5		3.5



21-0697



21-0697 Installed

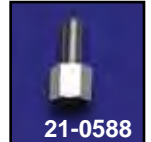

21-0588

**Red Baron™ Shifter Knob** is 1.5" shape cross. Machined of Billet with natural finish.

VT No.	Thread
21-0697	3/8 - 24
21-0703	7/16 - 20
21-0588	Adapter 1/4 - 24 Internal Thread, 3/8-24 Ext. Thread



### Brass Skull.

VT No.	Size
21-2121	3/8 - 24
21-2015	None
21-0650	7/16 - 20
21-0651	1/4 - 20





# Billet Forward Control Kit for 2000-up Softail



**2000-up FXST Chrome Billet Forward Control Kit** includes right and left sides and adapter block to use 27-3562 stand. Order shift rod and stainless steel brake line separately. Kit is 2" extended.

VT No.	Item	Year	Extension
22-0525	Kit	2000-06	3"
21-0220	Rod	2000-up	
23-0891	Line	2007-up	

### FXST Brake Line Required Components

23-4281	45° Fitting
23-4051	Banjo 10mm x 90°
23-4282	3/8 Fitting 90°
23-8212	18" Brake Line
23-8100	28" Brake Line
23-4050	Banjo 10mm x 35°
23-0612	10mm Banjo Bolt

### Replacement Hardware

23-1717	Master Cylinder Rebuild
23-3006	Master Cylinder
23-0574	Master Cylinder Top



**Chrome Brake Pedal Extended.** Extender allows the use of any style peg to be used as a brake pedal pad. Brake pedal pad extender can also be used to move the foot position out for more comfort. Extender attaches through the existing 5/16" bolt hole in the brake pedal. Fits 1984-up FXST. **VT No. 31-0053**



**Chrome Billet Rear Passenger Peg Set** features 3 band rubber insert. Matches Billet forward controls.

VT No.	Item
27-0615	Pegs
28-0607	Handgrips



**Order banjo bolt, union and stainless steel line to complete installation.**

VT No.	Item
23-0891	Line
23-0688	Union
23-0612	Banjo Bolt





# Black Forward Control Kits

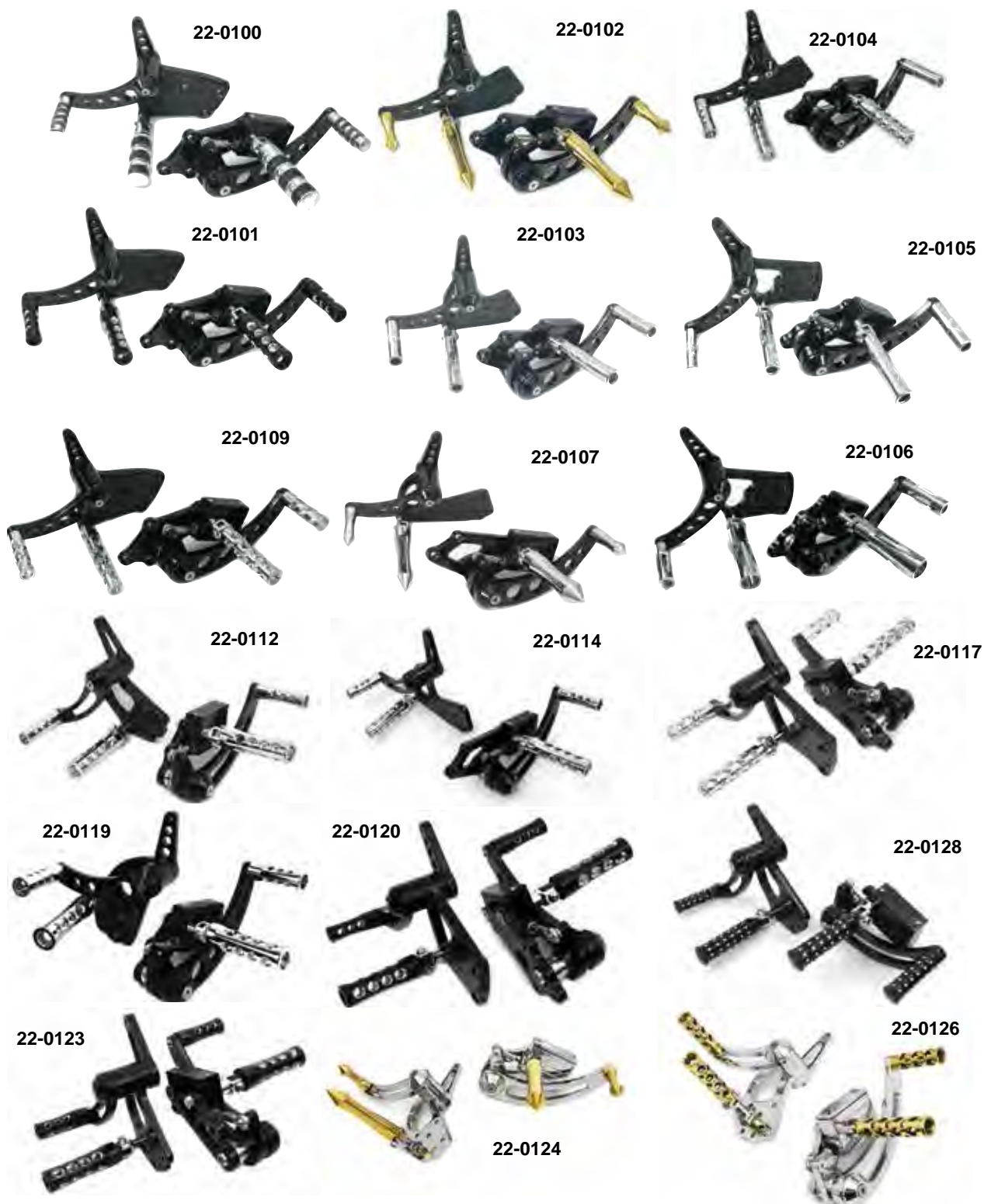

**Black Forward Control Kits.**

VT No.	Peg Style	Fits	Ext Forward Control				
22-0100	3 Band	2000-up FXST	+2" Standard	22-0115	Spearhead	pre1999	+2" Slotted
22-0101	Concave	2000-up FXST	+2"	22-0116	Chrome Concave	pre1999	+2" Slotted
22-0102	Brass Spearhead	1970-99 FX	+2"	22-0117	Chrome Swiss Cheese	2000-up	Slotted
22-0103	Flame	1970-99 FX	+2"	22-0118	Chrome Swiss Cheese	2000-up	+2" Slotted
22-0104	Concave	1970-99 FX	+2"	22-0119	Chrome Concave	pre1999	Drilled
22-0105	Flame	2000-up FXST	Standard	22-0120	Black Concave	2000-up	Drilled
22-0106	Deep Cut	2000-up FXST	Standard	22-0125	Black Concave	2000-up	+2" Slotted
22-0107	Spearhead	1970-99 FX	+2"	22-0127	Black Swiss Cheese	2000-up	+2" Slotted
22-0109	Swiss Cheese	2000-up FXST	+2"	22-0128	Black Micro Hole	pre1999	Slotted
22-0110	Swiss Cheese, black	1970-99 FX		22-0123	Black	pre1999	Black
22-0129	Swis Cheese, chrome	1970-99 FX		22-0124	Chrome	pre1999	Brass Pegs
22-0112	Chrome Concave	pre1999	Slotted	22-0126	Chrome	pre1999	Brass Swiss
22-0114	Chrome	pre1999	+2" Slotted				



# Footboard Kit for FXD



Left Side



Right Side

Wyatt's Footboard Kit for FXD is designed for use on all 1996-up FXD models. It features the same style used on all touring models to maximize rider comfort. The kit comes complete with footboards and mounts, brake pedal, an extended brake rod and a one piece chrome heel toe shifter, mounting hardware, toe shifter and mid shift retainers. Cannot be used with engine guards.

VT No.	Item	Fits
27-0920	Kit	1995-05
22-0453	Kit	2006-up
23-0289	Pedal	
27-1011	Board	
21-0793	Shifter	
51-0434	Engine Bar	



Left Side Installed



Right Side Installed



Chrome Engine Bar features 1/4" tubing.  
VT No. 51-0434

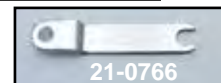

21-0766

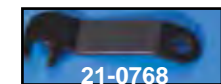

21-0768

**Mid Shift Lever Retainers** will secure inner primary shift lever when installing forward controls.

VT No.	Year
21-0766	1991-05
21-0768	2006-up



51-0434 installed with 27-0920



21-0768 Installed



**Reduced Reach Forward Control Conversion Kit** fits 2006-up with mid controls. Kit includes left and right supports, brake and shift lever, brake and shift linkages. This moves the rider's feet 10" forward from the mid control position.

VT No. 22-0226



Forward Controls on this page use existing master cylinder.



22-0509 Left



22-0561



**Dynaglide Chrome Forward Control Kit.** The stock control kit (22-0509) will move mid mount controls on 1991-05 Dynaglide models to the forward position and can be used as stock replacement on 1993-02 FXDWG. The 2" extended control kit (22-0510) will move mid mount controls on Dynaglide models to the forward position and can also be used on FXDWG for increased leg room. Order foot rest and shifter pegs separately.

2006-up	1991-05	Item
22-0517	22-0509	Control Kit, Stock
22-0561	—	Control Kit, Stock, Black
—	22-0510	Control Kit, 2" Extended



27-0759

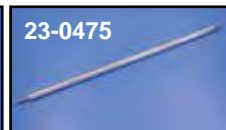

23-0475

**Dyna Wide Glide Chrome Forward Control Extension Kit** allows stock forward control pedals to be moved 2" forward for extra leg room. Kit includes two chrome extension plates, chrome extended shift rod and chrome extended brake rod. Installation requires utilization of stock brake and shifter pedal components.

VT No.	Year	Item
27-0759	2006-up	Kit
23-0475	1992-02	Brake Rod Only

\*Note: 2003/2004/2005 OE Style Replacement



23-9191



23-0850

**Chrome Brake Rods** fit FXDWG models.

VT No.	OEM	Year
23-9191	41955-93	1993-02
23-0850	41955-03	2003-up



**Chrome Billet Forward Brake Pedal** features forged aluminum construction with milled slots. Fits 2003-up FXDWG.  
VT No. 23-0478

# Forward Control for FXD-FXDWG



22-0956

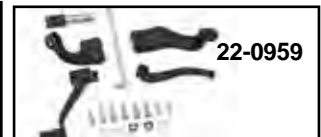

22-0959

**Forward Mid Control Sets** . Comfortable as slightly more forward than stock 2006-up FXD with mid controls and 2014-up FXDL.

VT No.	Finish
22-0956	Chrome
22-0959	Black



22-0770 Right



22-0770 Left

**Note: Shifter Rod Position for Installation**

**Chrome Billet Forward Control Set** fits 1991-05 FXD. Includes rubber belted pegs as shown, and includes left and right sides. Order shift rod separately. This kit will utilize stock master cylinder in the original position. Rod included fits directly to master cylinder.

VT No.	Item
22-0770	Set
21-0222	Shifter Rod

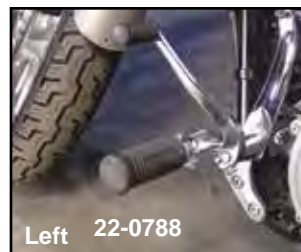

Left 22-0788

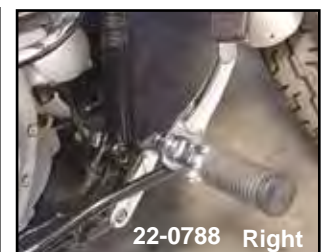

22-0788 Right



22-0788

**Forward Control Kit** fit 2006-up FXD. It uses existing master cylinder linkage and footpegs.

VT No.	Type
22-0788	Replica without soft pegs
22-0794	Replica with soft pegs and without gaskets

**22-1679\*** Short Reach Adapter Kit  
\*Note: Move stock FXDWG for controls 1" closer to rider and can be used on FXD models when 22-0788 or 22-0794 are installed for reduced reach.





# Billet Kit for FXD-FXDWG



22-0768 Right

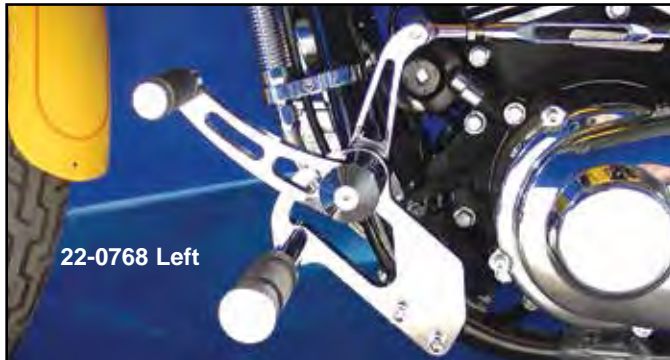

22-0768 Left



21-0220



21-0222

**Chrome Shift Shaft Cover** has 1/2" inner diameter to fit over unused shifter shaft in primary cover when installing forward controls, sold each.

VT No.	Type
37-8872	Acorn
44-0047	Dome



28-0607

Matching Grip Set



27-0615

Order matching grip and passenger set separately.

VT No.	Item
28-0607	Grips
27-0615	Peg Set



21-0766

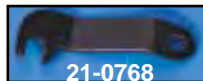

21-0768

**Mid Shift Lever Retainers** will secure inner primary shift lever when installing forward controls.

VT No.	Year
21-0766	1991-05
21-0768	2006-up



22-0756 Left



22-0756 Right

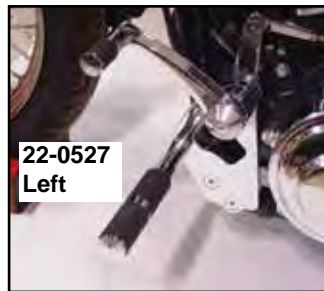

22-0527 Left



22-0527 Right

**Chrome Billet Forward Control Set** fits 1991-05 FXD includes rubber belted pegs as shown. Includes left and right sides complete with master cylinder. Order shift rod separately.

VT No.	Item	Style
22-0756	Control Set	Standard
22-0768	Control Set	+3"
22-0527	Control Set	+2"
21-0222	Shift Rod	Standard
21-0220	Shift Rod	+3"
23-3005	Master Cylinder	
23-0859	Rebuild Kit for 22-0756 and 22-0768	



**Replacement Chrome End Cap Set** fits brake and shift pivot ends.

VT No. 21-0543



**Smooth Oval Inspection Cover**

for primary covers features black satin finish. 1986-2006 FXDWG.

VT No. 42-1274



**Shift Shaft Primary Plug** for use when forward controls are installed on FXR-FXD models to seal the inner primary when eliminating the mid shift. Includes O-Rings and hardware.

VT No. 17-0650



**Oval Inspection Cover** fits FXD-FXST outer primary when forward controls are used. Does not have a hole for shift shaft for 1991-05. Chrome.

VT No. 42-9927



# Brake Control Kit

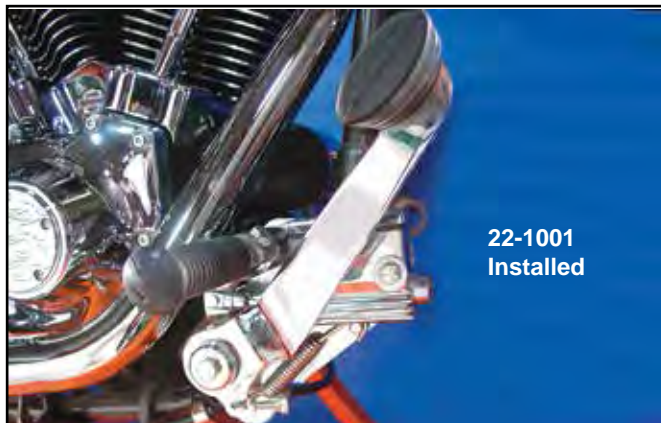

22-1001  
Installed

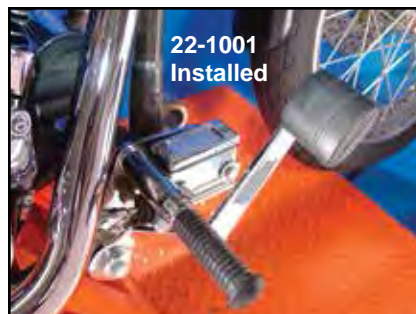

22-1001  
Installed



22-1054



22-1082  
Installed

**FXST Chrome Stock Style Brake Control Kits** includes mounting bracket, lever and linkage. The 1982-86 type uses two bolt master cylinder. 1987-89 type has tab with square hole that uses spark plug. The 1990-up type fits models with frame mounted master cylinder. Master cylinder not included.

VT No.	Fits
22-1054	1984-Early 87 FXWG-FXST
22-1064	1987-89 FXST
22-1082	1990-99 FXST

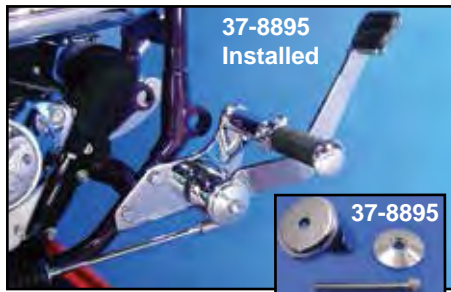

37-8895  
Installed

37-8895

**Chrome Brake Lever Pivot Cover Kit** fits 1984-99 FXST-FXWG. Includes cover, retainer washer and allen screw. Details this drab area.  
**VT No. 37-8895**



**Chrome Pedal** will allow full use of the foot board as the pedal pad is moved to the edge of the board. Rubber pad is included. Fits 2000-01 FLST.  
**VT No. 23-0360**



23-0244

**Chrome Extended Brake Pedal** constructed of chrome steel with 2 1/4" extension. Fits 1997-07 FLHT. Slotted.  
**VT No. 23-0244**

**FXST Replica Forward Brake Control** for use on all 1970-99 Big Twin with Shovelhead or Evolution engines equipped with hydraulic disc or drum brakes. Designed after the 1984-99 FXST which places the driver peg in back of the brake pedal, so the brake is easier to operate from this comfortable position. Redesigned to accept a Wagner or Kelsey-Hayes style master cylinder or GMA masters, also available with chrome KH or Wagner style masters. Hardware includes linkage pedal mount plate, rubber covered footpeg. This kit is the exact compliment to our shifter kits listed on opposite page and when used with one of these kits, places the pegs in forward and raised position.

- | VT No.   | Item  |
|----------|---|
| 22-1066  | Dual-use kit without Master Cylinder          |
| 22-1001* | Complete kit with Kelsey type Master Cylinder |
| 22-1018* | Complete kit with Wagner type Master Cylinder |
| 23-1743  | Brake Pedal for Above                         |
| 13-0181  | Brake Pedal Spring                            |
- Note:** Kits VT No. 22-1001 and 22-1018 use Russell stainless Lines VT No. 23-8809 front and 23-8802 from junction to rear caliper. Use tee VT No. 23-0707.

## Everything You Need To Convert Hydraulic Brakes To Forward Control Pedal Rubbers



28-0548



23-0466

**Brake Pedal Rubber** to fit 1980-up FXWG, 1981-up FXST.

VT No.	Type	Model	Style
28-0791	Slip on	FXDWG	
23-0466	Bolt	1984-up FXST	Flame



23-0823



Front

23-0823  
Back

Front

23-0824  
Back

**Skull Pedal Pad** is constructed of neoprene. Sold each.

VT No.	Type
23-0823	FXST
23-0824	FLST-FLH

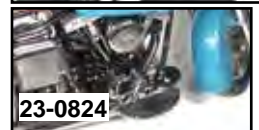

23-0824

**Extended Foot Brake Pedal.**

VT No.	Style
23-0241	Smooth, 2 1/4"
23-0243	3-Slot, 2 1/4"
23-0245	3-Slot





# FXD Pedal



23-0143



23-0921

FXD Rear Brake Pedals. Order rod separately.

VT No.	OEM	Fits	Finish
23-0143	42617-99	1990-up	Chrome
23-0921	42502-90A	1991-up	Rod 12" in length

## Rear Brake



23-0108



23-3025



23-3012



23-3013



23-3009



28-0505

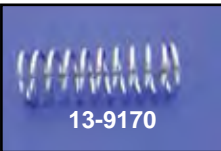

13-9170



12-0971



28-0548



13-9166

### 1984-99 FXST-FXWG Brake Pedal and Components.

VT No.	OEM	Years	Item
23-0108	42515-81	1983-99	Chrome Pedal
23-3025	42522-87	Late1987-99	Push Rod Plunger
23-3012	42507-86	1986-Early87	Chrome Pedal Mount Plate
23-3013	42507-82	1983-85	Chrome Pedal Mount Plate
23-3009	42507-89A	1990-99	Chrome Pedal Mount
28-0505	40922-79	1983-Early87	Boot
28-2005	40922-87	Late1987-up	Boot
13-9166	40920-82	1982-Early87	Spring



23-3010



23-3025



23-3017



23-9173



23-0850



23-9191



23-0421

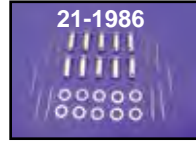

21-1986



23-0921

### Brake Plunger Assemblies.

VT No.	OEM	Finish	Fits
23-3010	42448-82A	Black	1983-Early87 FXST Plunger and Clevis
	42522-82		
23-3025	42522-87	Chrome	Late1987-99. FXST Clevis
23-3017	42448-82A	Zinc	1984-Early87 FXST-FXWG Plunger only
			1982-Early87 FXST-FXWG
23-9173	42437-87	Zinc	1987-94 FXR
23-0421	42269-30	Zinc	Clevis Pins, washer and cotter pin
21-1986	42269-70	Zinc	Clevis Pins washer and cotter pin
23-0850	41955-03	Chrome	2003-up Rod, FXDWG
23-9191	41955-93	Chrome	1992-02 Rod, FXDWG
23-0921	42502-90A	Chrome	1991-up Rod, FXD

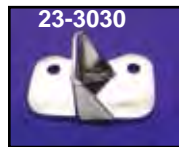

23-3030

Master Cylinder Mount Bracket bolts to 23-3012, 23-3013 plates.  
VT No. 23-3030

OEM Cross Reference Now Available online 24/7.

# Check at VTwinMfg.com



23-1720



23-1209

13-9170	40920-87	Late1987-up	Spring
12-0971	40918-82	1982-Early87	Boot Retainer Ring, 10 pack
12-0976	40918-87A	Late1987-up	Boot Retainer Ring, 10 pack
23-1758	44126-82	1983-Early87	Washer, Return, 5 pack
23-1720	42374-82A	1983-Early87	Master Cylinder Repair Kit
28-0548	42532-82	1983-up	Pedal Pad
23-1754	42531-87	1983-Early87	Washer, 5 pack
23-0405	All		Pin
23-1209		1990-99	Pedal Plate



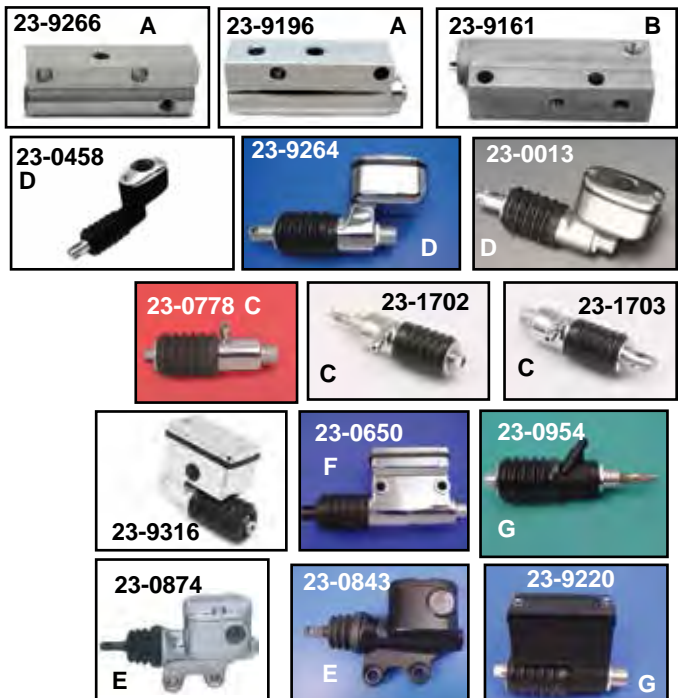

# Rear Master Cylinder

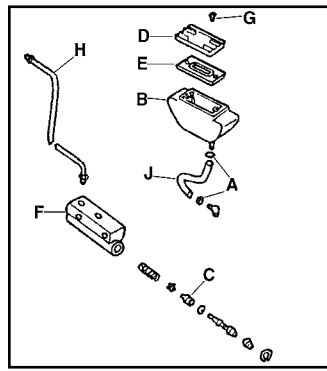

Remote Reservoir Body and Related Hardware for use with slave cylinders.



VT No.	#	OEM	Item
16-0063	A	10038A	Clamp
23-2009	B	41800-81A	Chrome Reservoir Body
23-1720	C	42374-82A	Master Cylinder Kit
24-0601	D	42376-77A	Cover, Chrome
15-0203	E	42455-80	Gasket, each
23-9196	F	42470-82B	Master Cylinder Complete
37-8821	G	42534-82	Screw
23-2303	H	45154-84	Brake Line, FXST
40-0119	J	63573-82	Hose, 25 feet, 5/16" inner diameter

## Complete Remote Mount Master Cylinders.

VT No.	#	OEM	Fits	Item
23-9196	A	42470-82B	1982-86	Complete, Chrome
23-9161	B	42446-82B	1982-86	Complete, Natural Finish
23-0778	C	42446-87A	1987-99	FXST, FXR Chrome
23-0650	F	42468-87D	1987-99	FLST-FLSTF Chrome
23-9266	A	41755-86	1986-91	FLT Chrome
23-0954	G	41755-92A	1992-94	FLT Black
23-0458	D	41755-99	2000-05	FXST & FLST 1999-04 FLT Black
23-0013	D	42454-99	As Above	Chrome
23-0874	E	41708-08	2008-up	FLT Chrome
23-0011	D	2000-05	Master Cylinder, Body and Top	Chrome
23-9264	D	41777-05A	2005-07	FLT, 2006-up FXST-FLST Chrome
23-0874	E	41708-08	2008-up	FLT, Chrome
23-9220	G	42474-90A	1991-05	FXDG Complete
23-9316		As Above		Chrome
23-0875	G		2006-07	FXDG, Chrome
23-1702	C	41755-95	1995-96	FLT Chrome
23-1703	C	41755-97	1997-98	FLT Chrome

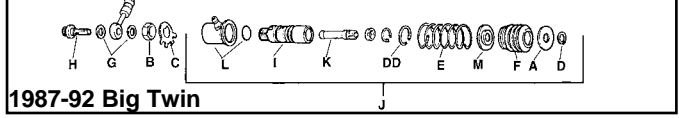

## 1987-92 Master Cylinder for Big Twins.

VT No.	#	OEM	Item
12-0418	A	6366	Washer
12-0417	B	7855	Nut
17-0904	C	37503-41	Lock Tab
12-0976	D	40903-87	Retaining Ring
12-0987	DD	40918-87	Retaining Ring, Large
13-9170	E	40920-87	Spring
28-2005	F	40922-87	Rubber Boot
14-0568	G	41731-88	Banjo Seal
23-0612	H	41747-82A	Banjo Bolt
23-9177	I	42382-87	Master Cylinder Repair Kit
23-0778	J	42446-87A	Master Cylinder Complete
23-9171	K	42448-87	Master Cylinder Pushrod
23-9201	L	42452-87	Body Repair Kit
23-3026	M	44126-87	Spring Washer

**23-3029 Chrome Billet Master Cylinder Reservoir** replaces original plastic unit on 1982-up replacing 41800-81A.  
**VT No. 23-3029**

**23-3003** **23-3004**

**23-3003** **23-3004** **23-0878**

**Chrome Billet Master Cylinders** feature Wagner or Kelsey Hayes style mount holes 5/8" bore.

VT No.	OEM	Type
23-3003	Kelsey Hayes	Inline
23-3004	Wagner	Offset

**23-0878** Rebuild Kit

**23-3005** **23-3028** **23-0860** **23-1988** **23-0859**

**Chrome Rear Master Cylinder Assembly.** Billet assembly is available in 5/8" or 3/4" bore sizes. Features 2 1/4" spacing between mounting bolts, 1/8" NPT brake line fitting, milled body design and measures 3 1/2" long x 1 1/4" wide and 3" tall.

VT No.	Size
23-3028	5/8" Complete Assembly
23-3005	3/4" Complete Assembly
23-0860	5/8" Rebuild Kit
23-0859	3/4" Rebuild Kit
23-1988	Fitting



# Master Cylinder Rebuild

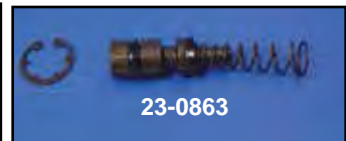
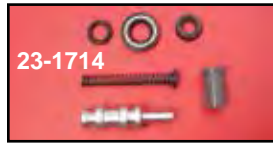
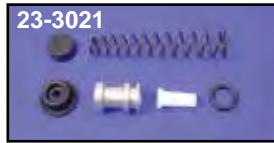
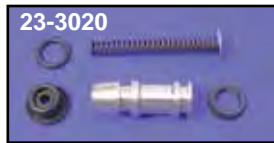

**Handlebar Master Cylinder Rebuild Kits.** Each kit contains parts necessary for complete rebuild.

VT No.	OEM	Years	Fits
23-3020	45006-87	1987-95	1 1/16" Bore
23-1716	45063-82	1982-85	3/4" Bore
23-3021	45072-87	1985-95	All 5/8" Bore
23-1714	45006-96	1996-2003	9/16" Bore
23-1715	45072-96	1996-2003	1 1/16" Bore
23-0857	42862-06A	2008-up	Touring
28-2002	45042-82	Fluid Level Window	1982-95

## Rear Master Cylinder Rebuilds

VT No.	OEM	Fits
23-1718	41762-58A	1958-79 Big Twin
23-1717	42374-77B	1979-84 FL, 80-85 FLT
23-1720	42374-82A	1983-85 FX 4-speed 1984-86 FXST-FLST
23-2010	42374-86A	1986-91 FLT
23-2011	42382-82A	1982-E87 All FXR
23-9177	42382-87A	Late1987-up FXR-FXST 1992-07 FLT
23-9201	42452-87	Late1987-99 FXST, Body Rebuild
23-0863	42932-08	2008-up Touring



**Late Plunger Springs** act as brake pedal return springs on rear mounted master cylinders, zinc.

VT No.	OEM	Model
13-9165	40920-79	1979-84 FLT
13-9166	40920-82	1982-86 FXWG-FXST
13-9170	40920-87	1987-up FXST-FLST-Sportster
37-9042	515	Cotter 1/16 x 3/4
37-9043	6220W	Washer 1/4 x 7/16 x 1/32

# Top Gasket



## Front Master Cylinder Top Gaskets

VT No.	OEM	Year
15-0188	45012-72	1972-81
15-0204	45012-82	1982-84
15-0242	45005-85	1985-95
15-0250	45005-96	1996-05



**Rear Master Cylinder Cover Gaskets** are sold each.

VT No.	OEM	Year	Type
15-0202	41766-58	1958-78	Master Cylinder
15-0203	42455-80	1980-up	Master Cylinder
15-0248	42455-82	1982-E87	Reservoir
15-0242	45005-85	1985-95	Master Cylinder
15-0540	42455-99	2000-up	Reservoir

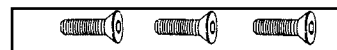

**Stainless Steel Master Cylinder Top Screws**, 25 pack.

VT No.	OEM	Years	Type
37-8947	2628	1972-81	Front Master Cylinder Top, Countersunk
37-8821	42534-82	1982-up	Reservoir Cover



# Master Cylinder Cover

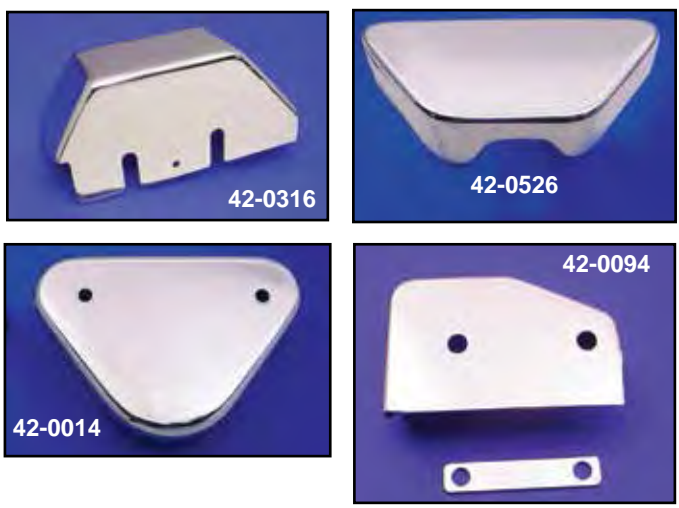

### Chrome Rear Master Cylinder Cover.

VT No.	Fits
42-0316	1979-84 FLH
42-0674	1986-99 FLST
42-0526*	1982-up FXR
42-0014*	1982-up FXR
42-0094	1982-86 FXR

\*Note: Remote reservoir cover.



Chrome Brake Caliper Inserts are easily installed with double face tape supplied. Sold each.

VT No.	Dia	Fits	Type
37-8968	1.80"	1987-99	Hayes Rear
37-8969	1.47"	1984-99	Front
37-8970	1.40"	1982-E87	Girling Rear
		1977-83	Dual Disc Front
		1972-84	Banana Rear
		1977-81	Rear



### Rear Master Cylinder Chrome Covers.

VT No.	Fits
23-0768	1999-04 FLT, 2000-05 FXST
23-0770	1999-up FLT
42-0973	2005-up FLT, 2006-up FXST
23-9190	1982-96
23-0968	2008-up Rear, FLT

**24-0632** Front Master Cylinder Covers are available in Eagle Spirit with chrome or gold inlay.  
**Chrome Gold OEM Years**  
**24-0629 24-0632** 45004-85 1985-95



### Front Master Cylinder Cover.

Smooth	OEM	Years
23-9189	45057-82	1982-84
24-0649	—	1985-95 With black inlay
23-9187	45004-85	1985-95
23-0794	VT	1985-95
23-0779*	45004-96	1996-05
23-0782	Billet Smooth	1996-05
24-0604	45004-96	1996-05
24-1279	45078-96	1996-05
23-0969	—	2008-up FLT Brake
26-0179	46424-05A	2005-07 FLT, 2006-14 FXST

\*Note: Includes top, gasket, view plug and screws.



### Milled

23-0781	Billet Milled With Gasket	1996-05
24-0927	1985-95	Front

\*Note: Includes top, gasket, view plug and screws.





# Chrome Rear Caliper Kit



**Rear Caliper Kit** includes complete chrome caliper, chrome caliper bracket, 11½" stainless drilled polished brake disc and chrome disc mount bolts.

VT No.	Year	Model
23-1089	1990-99	FXD
23-1090	1987-94	FXR



**1986-99 Dura Rear Caliper Kit** features chrome billet caliper and bracket. 11.5" razor disc included.  
**VT No. 23-0655**



**Chrome Billet Caliper Kit** for 1986-99 Softail includes chrome caliper and polished rear disc.

VT No.	Style
23-0261	18 Spoke
23-0281	Razor
23-0884	Caliper Seal Kit

**Wyatt Gatling Chrome Rear 4 Piston Caliper** features a 4 piston design. **VT No. 23-0024**



**2000-06 Caliper Kits** include integral bracket.



**Chrome Rear Caliper Kit** fits 1987-up Softail models and includes complete chrome replica 4-piston caliper assembly with one piece integral bracket, pads and polished stainless steel drilled disc with chrome mount bolts.

VT No.	Year	Model
23-1091	2000-05	Softail
23-1093	1987-99	Softail
23-1102	2000-05	FXD-WG
23-1103	2006-07	FXD-WG



**Colony Chrome Rear Caliper Bolts** for 2000-up.

VT No.	Year
2081-3	2000-07
2755-4	2008-up



**Billet Caliper Kit** features 4 piston design for 1987-99 Softail models. Order disc separately.

**VT No. 23-0853**



**Chrome Caliper Kit** includes caliper, bracket and polished stainless steel 11.5" disc with bolts. Fits 2000-05 FXST, FLST.  
**VT No. 23-0282**



# Rear Caliper



**22-0762**  
**Right Side Billet Rear Caliper Kit** fits 1986-99 Softail with integral side mount tail lamp/caliper bracket. Order curved tail lamp separately.  
**VT No. 22-0762**



23-0897



22-0373

**Edart Caliper-Disc Set** includes 2 piston chrome billet caliper, polished rotor/sprocket combination with 49 teeth for 1" or 3/4" axle. Order bolt kit separately.



VT No.	Item
22-0373	Kit
23-0785	Disc-Sprocket
23-0799	Rebuild



23-1711

**Edart Sprotor Kit** includes 48T stainless disc sprocket.

VT No.	Item
23-0897	Kit
23-1711	Disc/Sprocket
23-1704	Replacement Brake Pad Set

# Caliper Bracket



22-0764

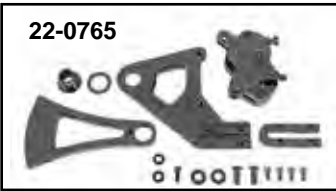

22-0765

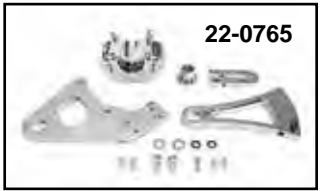

22-0765



23-0795



23-0787



23-0787



**Left Side Chrome Forged Billet Rear Caliper Bracket** fit 1" axles. Includes spacer for 3/4" axle applications. Fits 1986-99 Softail.  
**VT No. 23-0792**

**1986-99 Softail Rear Caliper Kit** includes curved license plate mount and spacer to fit 3/4" or 1" axle.

VT No.	Item	Side	Includes
22-0764	Kit	Right	4 Piston Caliper
22-0765	Kit	Left	4 Piston Caliper
23-0795	Bracket	Right	Bracket Only
23-0796	Bracket	Left	Bracket Only
23-0787	Bracket	Right Side	Bracket Only





# Rigid Rear Caliper Kit

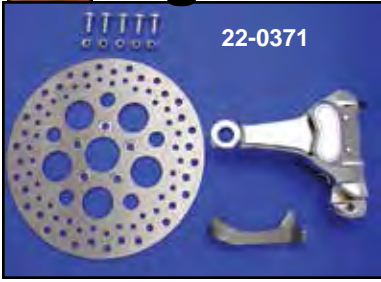

22-0371



22-0381



Rear Caliper Kits include GMA Caliper with bracket and either polished or standard 11½" stainless steel disc with mount bolts.

Polished	Standard	Year	Model
22-0357	22-0350	1984-86	FXST-FXWG
22-0358	22-0351	1987-99	FXST
22-0359	22-0352	1985-94	FXR
—	22-0353	1992-99	FXDG
22-0368	—	2000-05	FXST



22-0382

**11.5" Chrome Caliper Kit** fits Rigid frames. Kit includes polished 11.5" disc, bolts, chrome 4-piston caliper complete with integral bracket and weld on frame tab.

VT No.	Side	Fits	Axle
22-0371	Right	Big Twin	¾"
22-0381	Left	Big Twin	1"
22-0382	Right	Big Twin	1"



Rear GMA 11.5" Brake Discs are cast iron with aluminum center. **Note:** Disc should not be polished or cleaned. Rear discs are two piece design non-floating.

VT No.	Fits	Mt. Bolts
23-9937	1981-99 FXST-FXR	Stock 8791-10
23-9938	1992-99 FXST-FXR	4 Piston 37-9237



23-0153

## With 12½" Disc!!

**6-Piston Caliper/Disc Combo.** Chrome caliper features differential bore. Smaller in design, yet powerful. 12½" ductile iron floating disc is flash chromed with chrome plated center and features lightweight narrow band. All applications fit in stock location and accept stock brake lines.



23-0154

VT No.	Item	Year
23-0153	Front Brake Kit	1984-99
23-0154	Rear Brake Kit	1987-99



23-4502



23-4505



23-4506



23-4507



23-9255



23-4518



23-4524



Rear GMA Billet Aluminum Brake Calipers are machined from billet aluminum and clear anodized. Feature dual pistons which are internally connected, brake pads and brackets, when provided. Brake calipers include spacers and hardware necessary for installation. Hoses and discs not included.

VT No.	GMA	Fits
23-4502	R10	Rigid Frames to fit 10" disc. Use 5/8" bore master cylinder
23-1791	R10QC	As Above Chrome
23-4505	201ST	1984-86 FXST-FXWG Kit. Use stock type master cylinder
23-4506	202ST	1987-99 FXST Kit, 2 Piston. Use stock type master cylinder
23-4524	402ST	1987-99 FXST Kit, 4 Piston. Use stock type master cylinder, black
23-1792	402STC	As Above Chrome
23-4507	103SA	1984-99 FXR Kit 1987-up 2 Piston. Use 5/8" bore master cylinder
23-4518	400DG	1992-99 FXDG. Use stock type master cylinder
23-9255	402STM	2000-05 FXST 4 piston. Use stock type master cylinder

### Components

23-4521	PA4	GMA Caliper Piston, pair fits 23-4518, 23-9255
23-4509	PA1	Caliper Piston, pair, fits 23-4502, 23-4507
23-4520	PA2	GMA Caliper Piston, pair, fits 23-4506, 23-4505
23-4510	RB1	Caliper O-Ring Seal Kit fits 23-4502, 23-4507, 23-4506, 23-4505
23-4522	RB-4	Caliper O-Ring Seal Kit fits 23-4518, 23-9255
23-4512	A-Pad	SBS Brake Pad Set fits Calipers: 23-4502, 23-4507
23-4514	B-Pad	SBS Brake Pad Set fits Calipers: 23-4506, 23-4505
23-9169	F-Pad	SBS Brake Pad Set fits Calipers: 23-4518



# Big Twin Rear Caliper 1982-up



23-4533



23-9033



23-3055



23-9221



23-4531



23-9060



23-0582



23-0551



23-9063



23-9064



23-0552



23-0951

**Rear Caliper Bracket** replaces stock unit to accept stock caliper. Available in chrome or black.

Chrome	Black	OEM	Model	Year
23-4533	—	44205-87	FXR	1987-94
—	23-9033	44207-82	FXST FX	1982-Early87 1983-84
23-4531	—	44309-98	Dynaglide	1990-99
23-9060	—	42048-06	FXST	2006-07
23-9063	—	42048-08	FXST	2008-up
23-9064	—	42002-08	FXD	2008-up



23-3056

**Black Rear Calipers,**  
**23-3056** 44050-87 87-99 Softail  
**23-0125** 44039-86 Bolt Kit for Above  
**23-9038** 44076-86A 1986-99 FLT



23-9061



23-9062

**Chrome Rear Calipers** are completely assembled with piston and seals but less mount brackets for exact stock replacement.

Calipers	OEM	Model
23-3055	44050-82A	1982-86, FXWG, FLHS, FXR, FLST FXST
23-9221	44050-87	1987-99 FXST
23-0582	—	1987-99 Softail with integral bracket
23-0551	44016-00C	2000-05 FXST, 2000-07 FLST
23-0552	44017-00	2000-05 FXD
23-0951	44017-06	2006-07 FXD-FXDWG
23-9061	42047-06	2006-07 FXST
23-9062	42047-08	2008-up FXST-FXD-FXDWG

 **Rubber Bumper** for rear brake caliper, each.  
**VT No. 28-0718**



23-0865



23-0866

**Edart Billet Caliper** fits front and rear 1986-99 Softail. Order rear bracket separately.

VT No.	Item	Type
23-0865	Caliper	4 Piston
23-0866	Bracket	



**Chrome Rear Brake Disc Covers.** Bolts on for a secure installation. Fits 1986-99 FXST-FLST.  
**VT No. 42-0337**



# 2000-07 Chrome Front Caliper Kit



**Chrome Front Caliper and Brake Disc Kit** fits 2000-07 models. Kit includes a complete chrome replica 4-piston caliper assembly with pads, polished stainless steel drilled disc and chrome mounting bolts.

VT No.	Model
23-0561	FXST
23-0562	FXD



**2000-07 Front Caliper** are 4 piston type including all internal components. 23-0554 features smooth face.

VT No.	OEM	Side	Finish
23-0554	44046-00	Left	Chrome
23-0529	44046-00	Left	Black
23-0580	44025-00	Right	Chrome
23-0581	Set	Right and Left	Chrome

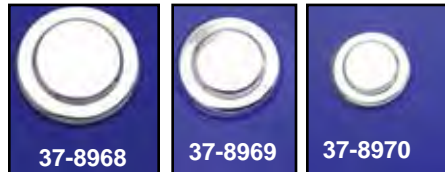

**Chrome Brake Caliper Inserts** are easily installed with double face tape supplied. Sold each.

VT No.	Dia	Fits	Type
37-8968	1.80"	1987-99	Hayes Rear
37-8969	1.47"	1984-99	Front
37-8970	1.40"	1982-Early87	Girling Rear



**Caliper fits 2008-up FXST-FLST**  
**VT No. Finish Fits Side**  
**23-0499** Chrome 2008-10 Left  
**23-1107** Black 2011-up Left  
**23-1108** Chrome 2011-up



**2000-07 Left Chrome Front Caliper Cover.**  
**VT No. Model**  
**42-0844** FXD  
**42-0848** FXST, FXDWG

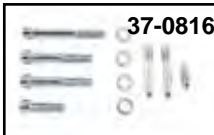

**Front Chrome Brake Disc Caliper Mount Bolt Kit** fits all 2000-up Big Twin models.  
**VT No. Brand**  
**37-0816** Dura  
**2080-4** Colony

**Dual Disc Caliper Set** fits 2008-up FLT Touring models. Right and left.  
**VT No. 23-1712**



**Edart Chrome Billet Front Brake Caliper** features a four piston differential bore. Includes brake pads. Fits 2000-07 FXST.  
**VT No. 23-1039**



**Polished Stainless Steel Front 11.53" Brake Disc** with 18-spoke design. For use with custom aftermarket calipers only.  
 \*Note: .030 oversize.  
**VT No. 23-1540**

Caliper Thread Chart	
<b>OEM Calipers</b>	
<b>Front:</b> All 1984-2002 Single Disc Calipers	3/8-24 banjo bolt
<b>Rear:</b> All Late 1987-2002 Big Twin, TC/B, XL	3/8-24 banjo bolt
<b>Front:</b> All 1984-2002 Dual Disc Calipers	3/8-24 banjo bolt
<b>Rear:</b> 1982-Early 87 FXR, XL; 84-Early 87 FXST; 83-86 FXWG	3/8-24 banjo bolt
<b>Front:</b> 1977-83 FX, FXWG, FXR, XL	3/8-24 Inverted Flare
<b>Banana Caliper</b> 1973-83 FL, FX, XL	1/8 NPT
<b>OEM-Handlebar Master Cylinders</b>	
<b>11/16" bore, 1985-95 Dual Disc Models</b>	7/16"-24 banjo bolt
<b>5/8" bore, 1985-95 Single Disc Models</b>	3/8-24 banjo bolt
<b>3/4" bore, 1982-84 Dual Disc Models</b>	3/8-24 banjo bolt
<b>11/16" Bore, 1982-2002 Dual Disc Models</b>	3/8-24 banjo bolt
	1972-81 FL, FX, XL
	1/8 NPT





# 1984-99 Front Caliper Kit



**1984-99 Chrome Billet Front Caliper Kit** includes billet chrome front caliper, bracket with pads and polished stainless steel spoke or razor brake disc with bolts. Kit includes hardware to fit 39 and 41 mm forks FXST, FXD and FLST models.

VT No.	Brake Disc
23-0238	Spoke
23-0240	Razor



**Edart Brake Kit** fits 1988-up FXST 4 piston design front spring forks.  
**VT No. 23-0786**



**Front Chrome Billet Calipers** feature 4-piston design with mount brackets included. Fits 1984-99 FXST.

VT No.	Item
23-0279	Caliper
23-0023	Caliper
23-0884	Rebuild



**Edart Billet Front Caliper** includes bracket for 1984-99 Softtail and XL models and is one piece design.

VT No.	Piston	Rebuild
23-1105	2	23-0864



**Front Chrome Disc Brake Caliper Mount Bolt Kit** fits all Big Twin models with allen bolts.

VT No.	Fits
37-0800	1993-99 All
37-8822	1983-92 All
37-0817	1988-96 FXSTS Springer
37-0818	1997-up FLSTS Springer

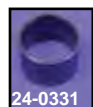

**Lower Leg Caliper Bushing** fits in lower leg where caliper attaches. Sold each. Fits 1984-up FXST. Replaces 46020-84. **VT No. 24-0331**



**11 1/2" 1984-99 Chrome Left Side Front Caliper Kit** includes polished stainless steel Dura brake disc with bolts and chrome caliper half with brake pads and hardware.

VT No.	Fits	Fork
23-0541	1984-99 FXST-FLST-FXDWG	41mm
23-0563	1984-99 FXD-FXR	39mm



**1984-99 Chrome Caliper Kit** features 4 piston chrome caliper and polished stainless steel Dura brake disc.

**VT No. 23-0649**



**1984-99 FX Chrome Front Disc Caliper** available as right or left assemblies or set for 11" brake discs. Includes all internal components and pads.

VT No.	Item	Fits
23-2226	Pair, Right and Left	FX
23-3085	Right only	FX-FL
23-3082	Left only	FX-FL



**1984-99 Front Caliper Piston and Seal Kit.**  
**VT No. 23-2279**



**Chrome 1984-99 Left Side 4 Piston Caliper** features 2000-up styling to retro fit 1984-99 models.  
**VT No. 23-0555**



**1984-06 Front Calipers** include all internal components.

VT No.	OEM	Side
23-3061	44046-84C	Left, Black
23-3082		Left, Chrome





# Front Caliper for FXSTS

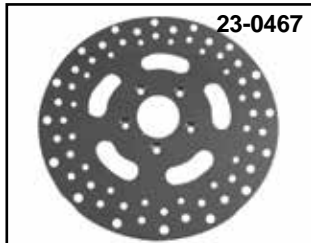

## Spring Fork Front Brake Caliper Kit.

VT No. Item Year  
 23-0940 Caliper Kit 1988-06 FXSTS

### Brake Disc.

- 1988-99
- 23-0334 Stainless Steel
- 23-0343 Polished SS
- 23-0368 Stainless Steel
- 23-9040 Polished SS
- 23-9206 Polished SS
- 23-0467 Polished

### 2000-06

23-0538 Polished Stainless Steel

## Front Chrome Disc Brake Caliper Mount

**Bolt Kit** fits all Big Twin models with allen bolts.



- | VT No.  | Fits                   |
|---------|------------------------|
| 37-0800 | 1993-99 All            |
| 37-8822 | 1983-92 All            |
| 37-0817 | 1988-96 FXSTS Springer |
| 37-0818 | 1997-up FLSTS Springer |

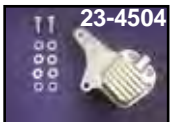

**GMA Billet Aluminum Brake Calipers** are machined from billet aluminum and clear anodized. Feature dual pistons which are internally connected, brake pads and brackets, when provided. Include spacers and hardware necessary for installation. Hoses and brake discs not included.

- | Front          | Fits  |
|----------------|---|
| 23-4504 200F   | 1984-99 Single Disc FX-FXST-FXR Kit, left only, 2 piston. Use 5/8" bore master cylinder |
| 23-4515 200S   | 1988-up FXSTS Spring Fork. Use 5/8" bore master cylinder                                |
| 23-4516 200P   | Paughco Wide Spring Fork. Use 5/8" bore master cylinder. Each.                          |
| 23-9257 400MDD | 2000-up FLT 4 piston dual disc  |



- Components**
- 23-4521 PA4 GMA Caliper Piston, pair, fits 23-9210, 23-1793
  - 23-4509 PA1 Caliper Piston, pair, fits 23-9257
  - 23-4520 PA2 GMA Caliper Piston, pair, fits 23-4504, 23-4515, 23-4516
  - 23-4510 RB1 Caliper O-Ring Seal Kit fits 23-4504, 23-4515, 23-4516
  - 23-4522 RB-4 Caliper O-Ring Seal Kit fits 23-9210, 23-9257
  - 23-4514 B-Pad SBS Brake Pad Set fits Calipers: 23-4504, 23-4515, 23-4516
  - 23-9169 F-Pad SBS Brake Pad Set fits Calipers: 23-9210



**Edart Brake Kit** fits 1988-06 FXST 4 piston design front springer forks.  
 VT No. 23-0786



**Edart Chrome Caliper Kit** fits 1988-06 FXSTS. Use with 5/8" master cylinder.  
 VT No. 23-0953



23-3083

23-3086

**Front Calipers** include all internal components.

- | VT No.  | OEM       | Fits                         |
|---------|-----------|------------------------------|
| 23-3083 | 44077-88D | Right, FXSTS 1988-06, Black  |
| 23-3086 |           | Right, FXSTS 1988-06, Chrome |



23-1567

23-1568

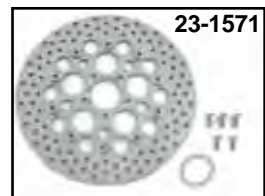
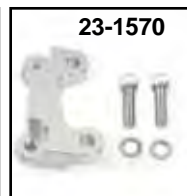

23-1569

23-1570

23-1571

**Front Caliper Adapter Brackets** allow the use of 13" floating brake disc on models listed by raising stock caliper. Brackets are a clear anodized finish.

- | VT No.  | Item             | Fits                            |
|---------|------------------|---------------------------------|
| 23-1567 | Bracket, Right   | 1986-99 FL                      |
| 23-1568 | Bracket, Left    | 1986-99 FXST, FL, 1991-99 FXDWG |
| 23-1569 | Bracket, Right   | 2000-up FLT                     |
| 23-1570 | Bracket, Left    | 2000-up FLT, FLST, FXDWG        |
| 23-1571 | Front Brake Disc | For Above Stainless             |



**GMA 11.5" Front Disc Brake Discs** are cast iron with aluminum center. **Note:** Brake disc should not be polished or cleaned. All front brake discs are floating type rear brake discs are two piece design non-floating.

- | VT No.  | Fits    | Disc   | Caliper  | Mt. Bolts |
|---------|---------|--------|----------|-----------|
| 23-9939 | 1984-99 | Dual   | 4 Piston | 8794-10   |
| 23-9941 | 1984-99 | Single | 4 Piston | 8794-10   |
| 23-9942 | 1984-99 | Single | Stock    | 8794-10   |
| 23-9259 | 2000-up | Single | 4 Piston | 8794-10   |

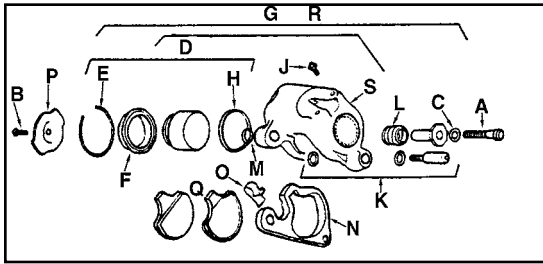

**1984-99 Front Calipers and Components.**

VT No.	#	OEM	Item
37-8822	A	855	Screw
Kit	B	3517	Screw
1983-92	C	6019	Washer
37-0800	As Above	1993-99	
23-2279	D	44020-83	Piston Rebuild Kit
12-0977	E	44021-83	Retainer
23-2275	F&H	44047-83	Dust Boot with Seal
23-3060	S,D	—	Caliper Right, Chrome Half
23-1982	—	—	Caliper Anchor, FXSTS, 1993-up
23-1981	—	—	Caliper Strap, FXSTS, 1993-up
23-3083	G	44077-88D	Right, 1988-99 FXSTS, Black Complete
23-1982	—	—	Caliper Anchor, FXSTS, 1993-up
23-1981	—	—	Caliper Strap, FXSTS, 1993-up
23-1572	—	—	Strap Kit
23-0455	—	44030-88	FXSTS 1988-up Caliper Brkt Bushing
23-3061	R	44046-84C	Left, 1984-99 FLT-FXR-FXRS-FXRT-FLSTF-FLSTN, 1991-99 FXDWG-FXDG (Black)
23-1731	J	44048-83	Bleeder, 10 pack
23-2274	K	44053-83	Guide Pin Kit for 1984-92 Big Twin, 1993-up FXSTS
23-9226	K	44053-92	Guide Pin Kit for 1993-99 All Big Twin except FXSTS
28-2133	L	44054-83	Boot, each
14-0563	M	44059-83	O-Ring
23-2308	N	44072-92A	Bracket, Left
23-2306	O	44061-83	Spring Clip
23-2307	P	44062-83	Retaining Pad
23-0512	Q	44063-83	Pad Set with B



# Caliper Rebuild



**1987-99 Complete Rear Caliper Rebuild Kit** includes all necessary hardware, piston and seal kit for a complete caliper overhaul. Fits FXST, FXR, FLT and FXD  
**VT No. 23-2012**



**1984-99 Front Caliper Piston and Seal Kit.**  
**VT No. 23-2279**

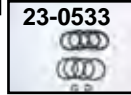

**Caliper Seal Kits** contain seal and dust boot for year listed.

VT No.	OEM	Front	Rear
23-2275	44047-83	1984-99 All FX-FLT	
	44022-83		
23-0533	44315-00	2000-07 All	
VT No.	OEM		Rear
23-2277	44208-82	1983-Early87 FX-FXWG-FXST-FXR	
23-0558	—	Piston Ring for Above	
23-9022	44045-87	Late1987-99 All FXST-FXR-XL	
	1986-99 All FLT		
23-0594	—	Piston Ring for Above	
23-0533	44315-00	2000-07 All	
23-0884	—	Seal Kit for V-Twin Billet 4 Piston Caliper	

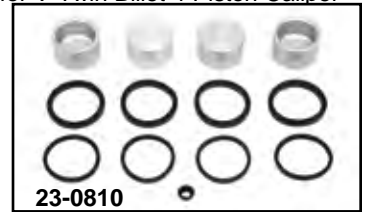

**Pistons Kits** include with seals and pistons.

VT No.	OEM	Front	Rear
23-0532	Kit	2000-07 Kit with seals	
23-0810		2008-up Kit with seals	
VT No.	OEM		Rear
23-2281	44208-82	1982-Early87 FXR, 1984-Early 87 FXST	
	1985-86 FXWG (Piston Only)		
23-1999	43946-86	Late87-99 FXST-FXR, 1987-99 FLT	
	Includes seal kit		
23-0532	44313-00	2000-07 Kit with seals	
23-0810		2008-up Kit with seals	
23-0838		Kit with seal All Billet (4 Piston Caliper)	

**\*Note:** 1980-85 FLT have Dual Piston Caliper.



**Chrome Caliper Mount Bolt Kits** mount through caliper to bracket.

VT No.	OEM	Type	Year
23-0140	44039-86	6 Point Rear	1987-99 FXST-FXR-FLT, Chrome
23-0125	44039-86	12 Point	Black, As Above
37-0266	Allen		2000-05 FXST-FXD Rear
23-0919		12 Point	2006-07 Softail



**1982-Early 87 Rear Brake Caliper Guide Pin Kit** for Big Twin models. Replaces 44212-82A.

VT No.	Type
23-0693	Chrome
37-0508	Screw Set

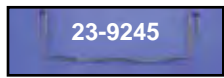
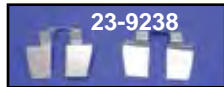

**Vibration Clips** fit as replacement to dampen pad rattles.

VT No.	OEM	Year	Type
23-9238	41665-82	1982-99	FXR
		1983-99	FLHS-FXSB-FXWG
23-9245	43960-86	1987-99	FXST-FXR
23-0137	43959-86	1987-99	FLT
23-0147	44337-00	2000-up	Front or Rear All Models



**Bleeder Screws** available in 10 pack.

VT No.	OEM	Size	Fits
23-1731	44146-77	3/8 - 24	1977-86, Late1987-89 Front or Rear Calipers
37-8265	Chrome	3/8 - 24	As Above, 5 pack
23-0110	Oversize		Repair Kit

**\*Note:** Fits bleeders and grease fittings



# Disc Brake Pad Set

**Disc Brake Pads** available in **Dura** or **SBS** brand. **Dura Brake Disc**, **Dura Brake Disc Kevlar** for excellent stopping on all types of disc brake discs. **Dura Brake Disc** replacement pads are a soft compound designed to be compatible to all types of brake discs. **SBS brand** is available in **Sintered**, **Ceramic** or **Carbon Tech** compounds. **Sintered Metal Pads** provides maximum stopping power but can never be used in calipers that were originally equipped with non-sintered pads. Works best with stainless steel disc brake discs. **Ceramic Pads** are for general purpose use on carbon steel brake discs and can be used on calipers originally equipped with sintered metal brake pads. **Carbon Tech Pads** for use in all stock or aftermarket calipers. Works well with stainless steel or cast iron brake discs. Order anti rattle clips separately.



## Rear Disc Pad Sets for Stock Type Calipers

Fits	OEM	Dura Soft	Dura Ceramic	Dura Semi	Dura Kevlar	Dura Sintered Metallic	SBS Sintered Tech	SBS Ceramic	SBS Tech	#
1986-99 FLT	43957-86A	23-2282	23-0991	—	23-0627	23-0956	23-1778	—	23-1777	D
1987-99 FXR, FXST, FLST, FXD	44213-87	23-9163	23-0992	23-0642	23-0620	23-0957	23-1780	—	23-1779	E
2000-05 FXST, FLST 2000-07 FLT, FXD	44082-00	23-0526	23-0993	23-0643	23-0546	23-0958	23-4559	23-1781	23-1782	F
2006-07 FXST, FLST	46721-06	23-1794	23-0917	—	—	23-0959	23-4562	—	—	W
2008-up FXST, FLST, FXD	42298-08	—	23-0994	23-0893	23-0886	23-1001	23-4563	—	—	A
2008-up FLT	41852-08	23-1015	23-0995	23-0894	23-0889	—	—	—	—	G
2009-13 Trike	83911-09B	—	—	—	23-0973	23-0980	—	—	—	

  

Front Disc Pad Sets for Stock Type Calipers										
1984-99 FLT, FXST, FLST, FXR, FXD	44063-83	23-0512	23-0996	23-0647	23-0625	23-0960	23-1784	23-1762	23-1785	J
2000-07 FLT, FXST, FLST, FXD	44082-00	23-0526	23-0993	23-0643	23-0546	23-0961	23-4561	23-4560	23-1782	F
2008-10 FXST, FLST, 2008-11 FXD	44082-08	23-0887	23-0997	—	23-0888	23-0862	23-4564	—	—	Y
2008-up FLT	41854-08	—	23-0998	23-0894	23-0890	23-0909	—	—	—	H
2011-14 FXST-FLST, 2012-up FXD	46363-11	—	23-1056	23-1057	23-1058	—	—	—	—	Y
2015-up FXST-FLST	41300102	—	23-1059	—	23-1060	—	—	—	—	



## Disc Pad Sets for Aftermarket Custom Calipers

Fits:	Dura Soft	SBS Ceramic	SBS Carbon Tech	Dura Ceramic	Photo
Edart	23-0879	—	—	—	X
Brembo Style	23-0788	—	—	—	V
GMA Model "A"	23-0591	23-4550	23-4512	—	L
GMA Model "B"	23-0592	23-4554	23-4514	—	M
GMA Model "F"	23-9174*	23-4553*	23-9169*	23-9878	N
GMA Model "M"	—	—	—	23-9874*	Q
GMA (Inside-Out)	—	—	—	23-0941	Z
Jaybrake Small 2-piston	23-9174*	23-4553	23-9169*	—	N
Jaybrake 2 piston ADC/ADCS	23-0592	23-4554	23-4514	—	M
Jaybrake 6 piston A6 L/R	—	23-4557	—	—	T
Performance Machine 162 x 2	23-9036	23-4552	—	—	P
Performance Machine 125 x 2	23-9174*	23-4553	—	—	N
Performance Machine 125 x4S	23-9174*	23-4553	—	23-9945	N
Performance Machine 125 x 4SL	23-9174*	23-4553	—	23-9945	N
Performance Machine 125 x 6	—	23-4558	—	23-9945	U
Performance Machine 137 x 6	—	23-4558	—	—	U
Performance Machine 124 x 4HR	—	23-4555	—	—	R
Performance Machine 137 x 4	—	23-4555	—	—	R
Performance Machine 125 x 4R	23-9037	23-4556	—	23-9946	S

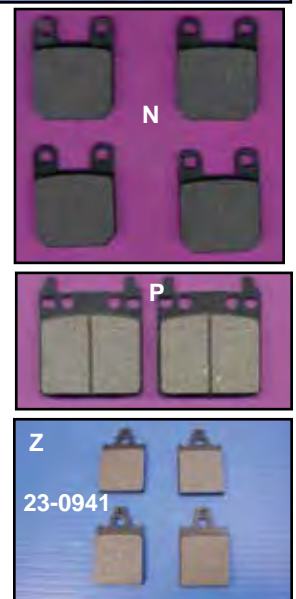



# Stainless Brake Disc



BIG TWIN

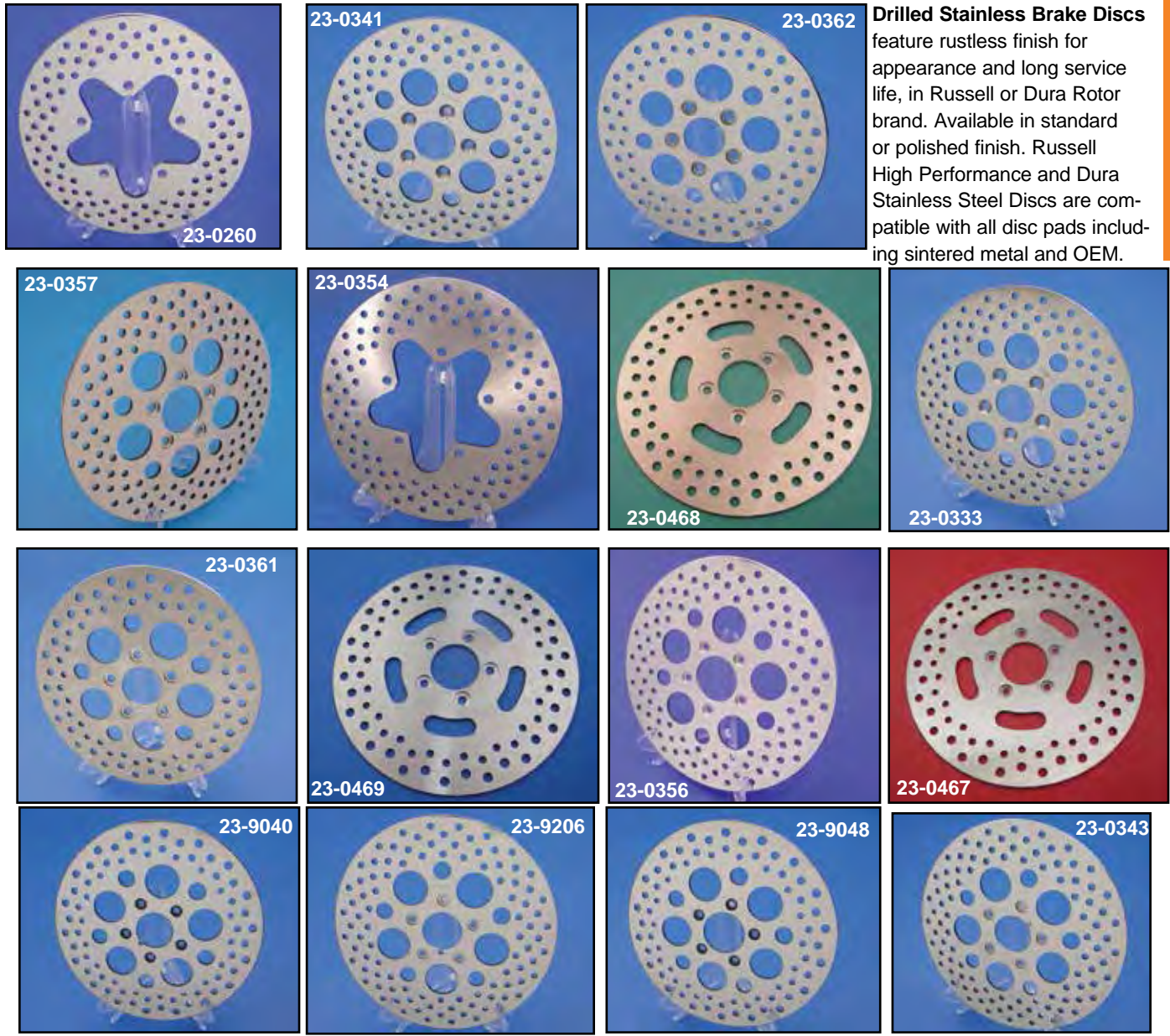

**Drilled Stainless Brake Discs** feature rustless finish for appearance and long service life, in Russell or Dura Rotor brand. Available in standard or polished finish. Russell High Performance and Dura Stainless Steel Discs are compatible with all disc pads including sintered metal and OEM.

Dura Rotor		Russell		OEM	Dia	Bolt Kit	Fits
Polished	Standard	Polished	Standard				
<b>REAR</b>							
23-0260	23-0354	—	—	40939-86A	11.5"	9807-10	1986-99 FLT
23-0341	23-0333	23-9044	23-0318	41791-79	11.5"	8791-10 Cast or Wire	1981-92 FXST-FXR Cast or Wire
23-0362	23-0361	23-9045	23-9926	41789-92	11.5"	9807-10 Cast or Wire	1993-99 FXST-FXR-FXDB Cast or Wire
23-0468	23-0469	—	—	41789-92	11.5"	9807-10 Cast or Wire	1993-99 FXST-FXR-FXD
23-0357	23-0387	23-9050	23-9051	41797-00	11.5"	9807-10 9818-5 Cast	2000-up FXST-FXD-FLT Cast or Wire
23-1043	—	—	—	41791-10	11.5"	9807-10 9818-5	2010-up FXST-FXD-FLT
<b>FRONT</b>							
23-0343	23-0334	23-9040	23-0319	44136-84	11.5"	8793-5 Cast 8794-10 Wire	1984-91 FX-FXST-FXSTS-FLST-FLT Cast or Wire Wheel
23-9206	23-0368	23-9040	23-0319	44136-92	11.5"	8793-5 Cast 8794-10 Wire	1992-99 FX-FXST-FXSTS-FLST-FLT Cast or Wire Wheel
23-0467	—	—	—	44136-92	11.5"	8793-5 Cast 8794-10 Wire	1992-99 FXST-FXSTS-FLST-FLT Cast or Wire Wheel
23-0356	23-0379	23-9048	23-9049	44156-00	11.5"	8793-5 Cast 8794-10 Wire	2000-up FXD-FXST-FLT Cast or Wire Wheel Left Side Brake Disc
—	23-0906	—	—	41500094	11.8"	—	2014-up FLT Dual Disc Set
23-6764	—	—	—	41500022	300M	—	2015-up FXST, 2014-up XL Left Side
—	23-6765	—	—	41500022	—	—	2015-up FXST, 2014-up XL Left Side
23-0907	—	—	—	44553-06A	—	—	2006-10 FXD for left side
23-0908	—	—	—	42040-06	—	—	2006-10 FXD for left side



# Floating Brake Disc



Floating Center Detail



11.5" Polished Stainless Steel Floating Brake Disc. Order bolt set separately.

Rear	
VT No.	Fits
23-0583	1979-99
23-0599	2000-up
Front	
23-0632	1984-95
23-0596	1996-99
23-0595	2000-up



# Stainless Brake Disc

Replica Brake Discs feature full stainless construction with precision ground finish and slot style pattern.

VT No.	Year	Fits	Finish
23-0467	1992-99	Front	Stainless
23-0468	1992-99	Rear	Polish
23-0584	2000-up	Front	Polish
23-0775	2000-up	Front	Stainless
23-0585	2000-up	Rear	Polish

Note: 2000-up discs have 2.25" inner diameter center hole, 1979-99 discs have 2.062" inner diameter center hole.



# Steel Brake Disc

Steel Brake Disc feature fine finish ground surface. Available with or without holes in steel with zinc finish unless noted as stainless. Exactly interchangeable with stock discs. Order bolt set separately.

Drilled	Plain	OEM	Dia	Bolt Kit	Fits	Type
<b>FRONT</b>						
23-0370	—	44210-79	10"	8792-5	1979-83 FLT	Steel
23-0371	—	44210-79	10"	8792-5	1979-83 FL	Stainless
23-0300	23-0301	44136-84 44136-92	11.5"	8793-5 Cast 8794-10 Wire	1984-99 FX FXST-FXSTS-FLST-FLT Cast or Wire Wheel	Zinc
23-0534	—	44136-00	11.5"	8793-5 Cast 8794-10 Wire	2000-up FXD, FLT Cast or wire wheel right side brake disc	Steel
23-0538	—	44260-00	11.5"	8793-5 Cast 8794-10 Wire	2000-up FXSTS-FLSTS Cast or wire wheel right side brake disc	Stainless Steel
23-0535	—	44156-00	11.5"	8793-5 Cast 8794-10 Wire	2000-up FXD-FXST-FLT Cast or wire wheel left side brake disc	Steel
<b>REAR</b>						
23-0307	23-0308	41791-79	11.5"	8791-10	1981-92 FXST-FXR Cast or Wire	Steel
—	23-0155	41791-79	11.5"	8791-10	1981-92 Softail-FXR	Stainless
23-0297	23-0313	40909-81A	12"	8791-10	1981-84 FLH Cast or Wire .390 thick.	Steel



# 11.5"



# Stainless Brake Disc



**Wyatt Gatling Polished Spoke Brake Disc.** Number of spokes as noted.

20 Spoke	18 Spoke	Type	Year
23-0149	23-0679	Front	1984-99
—	23-0678	Rear	1979-99
23-0151	23-1517	Front	2000-up
—	23-1518	Rear	2000-up
—	23-0895	Rear	1979-93



**Polished Stainless Steel Razor Brake Disc** features full stainless construction polished to high gloss. Order screw set separately.

**Rear, 11.5"**

VT No.	Year	Side	Wheel	Screw Set	Holes
23-0386	1993-99	Right	Wire	9807-10	Countersunk
23-0820	As Above				Unpolished
23-0388	1979-99	Right	Wire	8791-10	Tapered
23-0392	2000-up	Right	Wire	9807-10	Countersunk
			Cast	9818-5	Countersunk

**Front, 11.5"**

23-0376	1984-99	Left	Cast	8793-5	Countersunk
			Wire	8794-10	Countersunk
23-0391	2000-up	Left	Cast	8793-5	Countersunk
			Wire	8794-10	Countersunk

# 11.5"



**Dura 2000-up Stainless Brake Discs** with vented swirl slots.

**Polished**

VT No.	OEM	Type/Side	Model
23-0694	44156-00	Front, Left	FXD, FXST
23-3774	44136-00	Front, Right	FXD, FXST
23-0534	44156-00	Front, Left	FXD
23-0598	41797-00	Rear	All Polished
23-0534	41797-00	Rear	All Polished
23-0535	44156-00	Front	

**X Polished Stainless Brake Discs.**

VT No.	Year	Type
23-1519	1984-99	Front
23-1520	1984-99	Rear
23-1521	2000-up	Front
23-1522	2000-up	Rear
23-1535	2008-up	Front



**10" Polished Razor Brake Discs.**

VT No.	Fits	Style
23-0847	Rear, Left	1973-80
23-0848	Rear, Left, 23-0848 has chrome center.	1973-80

# 11.5"



# 11.5"



**Dura Polished Stainless Brake Discs.**

VT No.	Year	Type	Bolts	Wheel
23-1512	1984-99	Front	8791-10	Wire
			8793-5	Cast
23-1513	1984-99	Rear	9807-10	Wire
23-1514	2000-up	Front	8794-10	Wire
			8793-5	Cast
23-1515	2000-up	Rear	9807-10	Wire
			9818-5	Cast

**11.5" Dura Polished Brake Disc. \*Note:** Chrome center portion.

VT No.	Year	Type	Style	Bolts
23-1500*	1984-99	Front	Hole	8794-10
23-1502	1986-99	Rear	Hole	9807-10
23-1501	2000-up	Rear	Slot	9807-10
23-1516	1986-99	Rear	Razor	9807-10

**Order Bolts Separately.**

**Note:** 2000-up brake discs have 2.25" inner diameter center hole, 1979-99 brake discs have 2.062" inner diameter center hole.





# 11.5" Stainless Brake Disc

Fits front and rear!

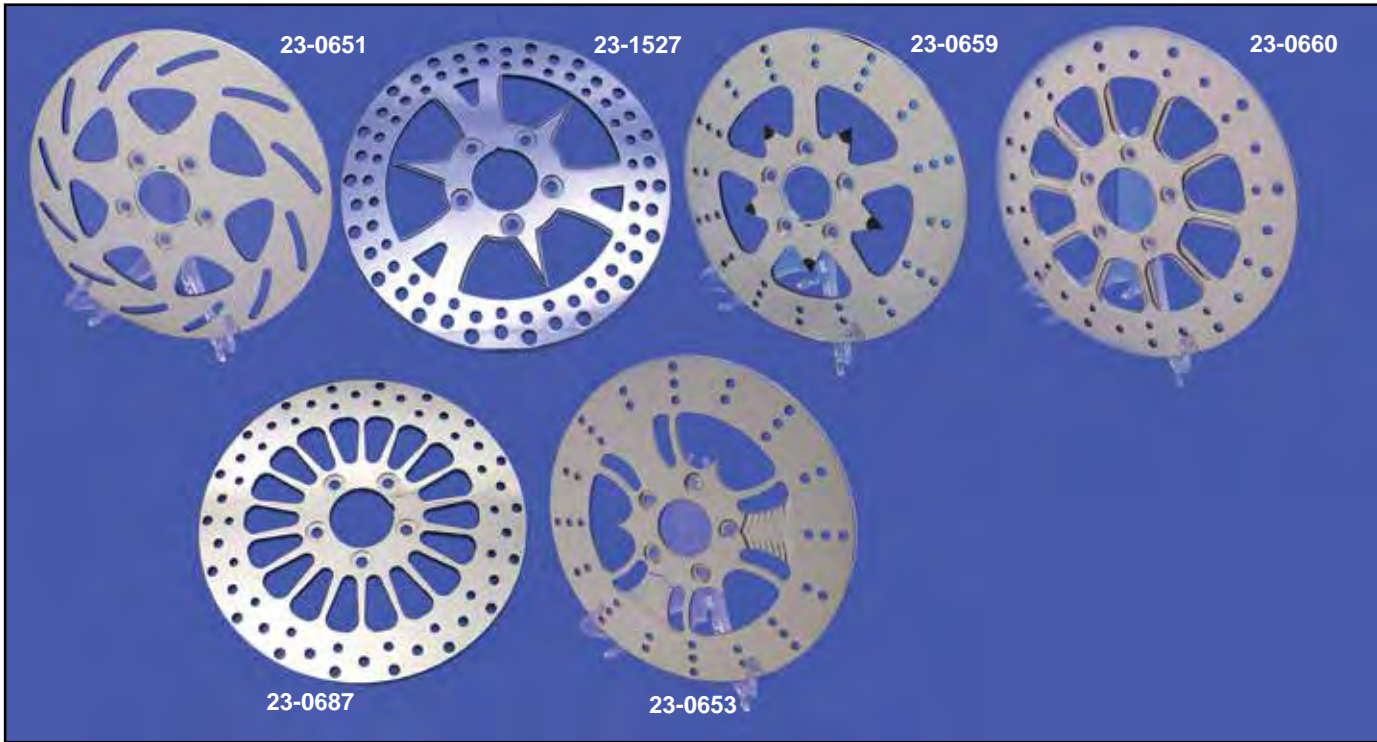

11.5" Edart Disc in polished stainless features universal design to fit 1984-up front and rear applications.

VT No.	Type	Qty	VT No.	Type	Qty
23-0651	Swirl	Each	23-0659	Spoke	Each
23-1527	Spike	Each	23-0660	10 Spoke	Each
23-0687	Spoked	Each	23-0687	Adapter Kit	
23-0653	Pirate	Each			

**Fits Right and Left!**

Edart Universal Brake Disc utilizes center ring and washers as noted.

Fits	Year	Ring	Washers
Front	1984-99	Yes	Yes
Front	2000-up	No	Yes
Rear	1984-99	Yes	No
Rear	2000-up	No	No

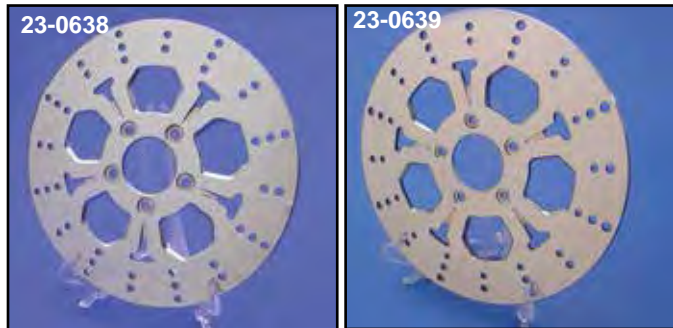

5-Spoke Polished Brake Disc.

VT No.	Year	Type
23-0638	2000-up	Rear
23-0639	2000-up	Front
23-0656	1984-99	Front

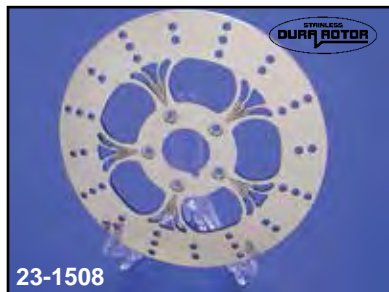

5-Spoke Polished Stainless Brake Disc by Dura Rotor.

VT No.	Year	Type
23-1508	1984-99	Front
23-1509	1984-99	Rear
23-1510	2000-up	Front
23-1511	2000-up	Rear

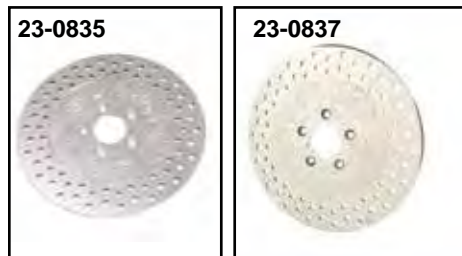

Stainless Brake Disc with skull engraving.

VT No.	Year	Type	Finish
23-0832	1984-99	Front	Stainless Steel
23-0833	1984-99	Front	Polished
23-0834	1984-99	Rear	Polished
23-0835	1984-99	Rear	Stainless Steel
23-0836	2000-up	Rear	Stainless Steel
23-0837	2000-up	Rear	Polished Stainless Steel



# Brake Disc Bolt

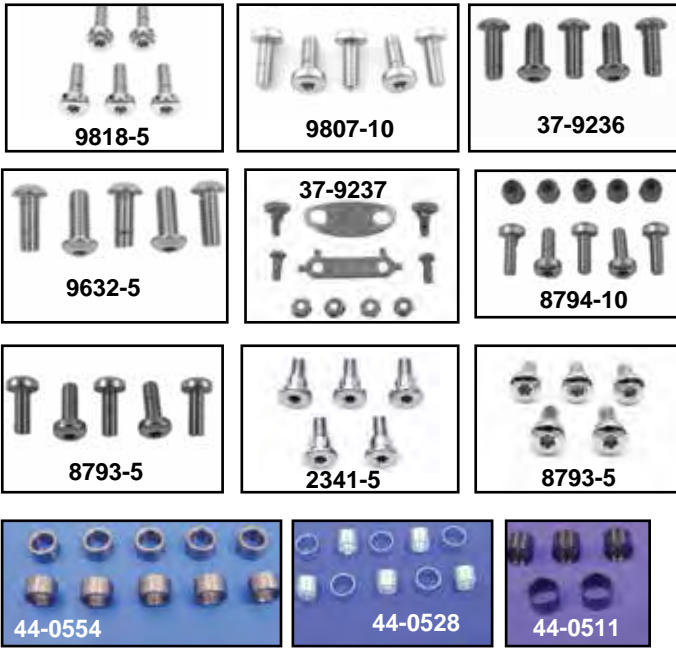

**Chrome Brake Disc Bolts.** See listing for applications.

#	Thread
A	3/8 x 16 x 1
B	5/16 x 18 x 7/8
C	5/16 x 18 x 7/8
D	3/8 x 16 x 1
E	3/8 x 16 x 1

**Chrome Rear Brake Disc Bolts.**

Wheel Type	Year	VT No.	#
<b>FXD</b>			
Cast	1997-up	<b>9818-5</b>	E
Spoke	1992-up	<b>9807-10</b>	D
<b>FXST-FLST-FXR</b>			
Cast	1979-91	<b>37-9236</b>	A
Cast	1979-91	<b>9632-5</b>	A
Spoke	1993-96	<b>9807-10</b>	D
Spoke	1993-up	<b>37-9237</b>	D
Spoke	1997-up	<b>9818-5</b>	E

**Chrome Front Disc Brake Disc Bolts.**

Wheel Type	Disc	Year	VT No.	#
<b>FXST-FXDWG</b>				
Spoke	Single	1984-up	<b>8794-10</b>	B
Cast	Single/Dual	1984-up	<b>8793-5</b>	C
<b>FXR-FXD</b>				
Spoke/Cast	Single/Dual	2006-up	<b>2341-5</b>	C
Spoke/Cast	Single/Dual	1984-up	<b>8793-5</b>	C

**Brake Disc Bolt Spacers** will adapt 1973-up FX-FL rear hubs to accept brake discs for front fork use. VT No. 44-0528 fits dual disc type 1980-83 FXWG type.

VT No.	Outer	Inner
<b>44-0528</b>	3/8	5/16
<b>44-0511</b>	7/16	3/8
<b>44-0554</b>	7/16	5/16

# Brake Disc-Pulley Spacers



**2000-up Rear Pulley-Disc Spacers**, sold as each.

VT No.	Thick	Type	VT No.	Thick	Type
<b>20-0346</b>	1/16"	Steel	<b>20-0143</b>	.750"	Alloy
<b>20-0347</b>	.125"	Steel	<b>20-0145</b>	1"	Alloy
<b>20-0343</b>	.200"	Steel	<b>20-0146</b>	1 3/8"	Alloy
<b>20-0344</b>	.250"	Steel	<b>20-0147</b>	1.5"	Alloy
<b>20-0345</b>	.300"	Steel			



**Brake Disc Spacers** provide offset when required, with 7/16" bolt holes. Each disc measures 2 1/16" inner diameter with 4 5/16" outside diameter.

**Fits 1980-99 with 2 1/16" I.D.**

VT No.	Thick	Material
<b>23-0320*</b>	1/16"	Steel
<b>19-0128</b>	3/16"	Steel
<b>19-0452</b>	3/16"	Billet
<b>19-0413</b>	1/4"	Steel

**\*Note:** Use when installing flat brake disc on 1973-75 Big Twin.

**Alloy Rear Pulley Rotor Spacer** is ideal to get belt pulleys or chain sprockets in line. These spacers can also be used as a disc spacer. Spacer can be machined down to the next size under without having to worry about the spigot alignment, when you machine the face of the spacer down to the desired thickness. Spacers are drilled for use with 7/16" bolts and designed to be used with 2000-up type wheel hubs.



**Aluminum Rear Pulley Spacer**  
Fits 2000-up with 2.25" I.D.

VT No.	Thick
<b>20-0149</b>	.200"
<b>20-0150</b>	.125"
<b>20-0151</b>	.3125"
<b>20-0136</b>	.250"
<b>20-0143</b>	.300"
<b>20-0144</b>	.940"
<b>20-3088</b>	1"
<b>20-0146</b>	1.250"
<b>20-3090</b>	1.370"
<b>20-0147</b>	1.5"



# Brake Hose



**Front Brake Hose** is of stock type rubber construction and D. O. T. approved. 45" length. Fits 1984-99 FXST. Replaces 45112-84A.  
**VT No. 23-0742**



**Rear Steel Brake Tubes** are zinc plated. Front fits between master cylinder and junction. Order rubber hose for final connection to rear cylinder or caliper separately. Fits 1984-Early 87 FXST and Late 1984-85 FXWG. Replaces OEM# 45154-84. **VT No. 23-2303**

# Banjo Bolt



**Brake Banjo Seal Washers** feature built in O-Rings.  
**14-0048**

VT No.	OEM	Type
14-0567	41733-88	7/8", 12mm fits handlebar cylinders 1984-00, single disc
14-0568	41731-88	3/8", 10mm fits 1982-00 Dual Disc Brake Calipers
14-0578	41731-01	Fits 2001-up Master Cylinder and Brake Calipers
14-0048	41751-06A	Fits 2006-up (Copper)



**Chrome Banjo Bolts** include seal washers.

VT No.	Size	MM	Style
2190-3	3/8" - 24	10	Dome
2191-3	3/8" - 24	10	Allen
2192-3	7/16" - 24	12	Dome
2193-3	7/16" - 24	12	Allen
23-0882	2004-up XL	10	Hex
23-0883	2004-up XL	12	Hex



**Allen Button Head Banjo Bolts** sold with washers.

VT No.	Size	MM
37-8517	3/8" - 24	10
37-8518	7/16" - 24	12



**Billet Aluminum Brake Tee.**

VT No.	Type
23-9227	Front 3/8"-24 inverted flare in all 3 holes
23-9228	Rear 3/8"-24 inverted flare in 2 holes and 1/8" NPT in center hole



**Universal Straight Chrome Union** with bracket.

VT No.	Thread
23-0635	1/8" NPT
23-0688	3/8"-24



**Hydraulic Brake Switch** features heavy duty contacts and quality brass terminals.

VT No.	Type	Years	Brand
32-0426	Flag	1971-94	Replica
32-0435	Flag	1971-94	Accel
32-0434	Screw	1971-94	Accel
32-0425	Screw	1971-94	Replica
32-0443	Flag	1995-03	Replica
32-0770	Flag	2004-up	Replica



**Chrome Banjo Bolt Kits** for use with universal or stock lines, front and rear, washers included. The VT No. 37-8979 is to be used when a master cylinder or caliper uses a 3/8"-24 banjo bolt and the line has a 12mm hole instead of 10mm.

VT No.	OEM	Line	Size/Item
23-0612	41747-82A	10mm	3/8"-24
23-0613	41731-82	10mm	Washers
23-0614	41739-84	12mm	7/16"-24
23-0615	45583-83	12mm	Washers
37-8979	Special Kit	12mm	3/8"-24
14-0568	41731-88	10mm	Washer with O-Ring
14-0567	41733-88	12mm	Washer with O-Ring
23-0842	41750-06A		2006-up



**Banjo Bolt** by Russell accepts brake light switch and eliminates the need for junction block. Replaces the standard 3/8" x 24 bolt. Sold each. **VT No. 23-0746**



**Chrome Billet Brake Line Tee** has 2 inverted flare 3/8" - 24 threaded holes, 1/8" National Pipe Thread center hole.  
**VT No. 23-3769**

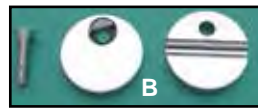

**Front Chrome Brake Line Clamp** fits under triple tree to secure stainless brake line. 1/4" - 20 mount hole.

VT No.	Type
23-0675	A
23-0686	B



**Chrome Steel Brake Line Tees** with 5/16" mounting hole.

VT No.	Type
23-0570	Center hole inverted flare 3/8"- 24 UNF, side tubes 3/8"- 24 UNF
23-0571	Center hole 1/8" - 27 NPT, side tubes 3/8" - 24 UNF
23-0572	Center hole and side tubes 1/8" - 27 NPT





# Universal Brake Fitting & Bolt



**10mm Russell Street Legal Universal Brake Lines.** Build it yourself line assemblies ready for adapter fittings.

Preassembled with high performance #3 stainless braided hose with rugged Teflon® inner and crimp-on chrome plated female swivel hose ends. Clear coated for abrasion resistance. Meets the guidelines of the D.O.T. MVSS-106 requirements and are 50-state legal. Compatible with all brake fluids.

VT No.	Length	VT No.	Length	VT No.	Length
23-8352	4"	23-8110	30"	23-8180	54"
23-8002	6"	23-8120	32"	23-8272	56"
23-8010	9"	23-8130	34"	23-8282	58"
23-8020	12"	23-8342	36"	23-8229	60"
23-8030	15"	23-8140	38"	23-8332	62"
23-8362	16"	23-8242	40"	23-8312	64"
23-8040	17"	23-8150	42"	23-8322	66"
23-8212	18"	23-8252	43"	23-5833	68"
23-8050	19"	23-8262	44"	23-5834	70"
23-8060	21"	23-8192	45"	23-5835	72"
23-8070	23"	23-8372	46"	23-5836	74"
23-8080	25"	23-8160	47"	23-5840	80"
23-8090	26"	23-8202	50"		
23-8100	28"	23-8170	52"		



**10mm Banjo End Dual Disc Upper Hose** fits 1982-up style master cylinders for single or dual disc application. Hose has nut with inverted flare at opposite end.

VT No.	Length
23-8926	24"
23-8928	28"



**Cable Clip** with 5/16" hole snaps on fork tubes to hold cables and brake hoses.

VT No.	MM
24-1023	39
24-0497	41
24-1024	49

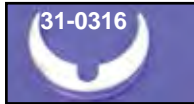
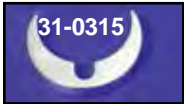

**41mm Push On Fork Tube Clamps.**

VT No.	Style
31-0315	Smooth
31-0316	Groove

**Russell ProSwivel™ Brake Hoses** are designed for single disc applications from stock to full custom rebuilds. Feature a unique design that allows the hose end to rotate 360° eliminating the hassle of aligning the connection at the caliper. Installation is easy, simply route the hose utilizing stock mounting locations, attach the banjo at the master cylinder, rotate the caliper banjo to correct angle requires. Tighten, bleed and your installation is complete. These hoses are factory assembled requiring no shop assembly in length from 40" to 54" , with various end configurations for master cylinders.

VT No.	Master Cylinder Description	Caliper	Overall
23-9300	Straight 7/16" ID Banjo x 90°		40"
23-9301	Straight 7/16" ID Banjo x 90°		42"
23-9302	Straight 7/16" ID Banjo x 90°		44"
23-9303	Straight 7/16" ID Banjo x 90°		46"
23-9304	Straight 7/16" ID Banjo x 90°		48"
23-9305	Straight 7/16" ID Banjo x 90°		40"
23-9306	35° 7/16" ID Banjo x 90°		44"
23-9307	35° 7/16" ID Banjo x 90°		46"
23-9308	35° 7/16" ID Banjo x 90°		48"
23-9309	90° 7/16" ID Banjo x 90°		50"
23-9310	90° 7/16" ID Banjo x 90°		52"
23-9311	90° 7/16" ID Banjo x 90°		54"
23-9312	90° 3/8" ID Banjo x 90°		48"
23-9313	90° 3/8" ID Banjo x 90°		50"
23-9314	90° 3/8" ID Banjo x 90°		52"



**Chrome Adapter Fittings** see listing for application. \*Note: Most Common Use.

**VT No. Fitting Type Adapts To:**

- 23-4047 10mm Banjo, straight
- 23-4050 10mm Banjo, 35°
- 23-4055 10mm Banjo, 45°
- 23-4051 10mm Banjo, 90°
- 23-4052 7/16" Banjo, straight
- 23-4053 7/16" Banjo, 35°
- 23-4056 7/16" Banjo, 45°
- 23-4054 7/16" Banjo, 90°
- 23-4057 12mm Banjo, Straight
- 23-4058 12mm Banjo, 35°
- 23-4059 12mm Banjo, 90°
- 23-4244 1/8" Male NPT, straight
- 23-4279 1/8" Male NPT, 90°
- 23-4293 1/8" Male NPT, 45°
- 23-4298 Male Tee
- 23-6033 Flare Union
- 23-6034 3/8" - 24 Banjo Bolt
- 23-6035 7/16" - 24 Banjo Bolt
- 23-6040 10mm x 1.25 Banjo Bolt
- 23-6041 12mm x 1.25 Banjo Bolt
- 23-6036 3/8" x 24 Double Banjo Bolt
- 23-6042 10mm x 1.25 Double Banjo Bolt
- 23-0746 3/8" x 24 Brake Switch Banjo Bolt
- 23-6037 35° Rear Banjo, 10mm
- 23-6038 90° Short Rear Banjo, 10mm
- 23-6039 90° Long Forward Control Banjo, 10mm
- 23-4396 3/8" -24 Male Inverted Flare, straight, 2 pack
- 23-4380 3/8" -24 Male Inverted Flare, 90° and 120°  
\*Junction block to master cylinder
- 23-4281 3/8" -24 Male Inverted Flare, 45°  
\*Rear Calipers
- 23-4282 3/8" -24 Male Inverted Flare, 90°, Short  
\*Junction Block to Front Caliper
- 23-4283 3/8" -24 Male Inverted Flare, 90°, Long  
\*Junction Block to Front Caliper
- 23-4284 3/8" -24 Male Inverted Flare, 150°  
\*Forward Controls
- 23-4306 Front Wide Glide Junction Block
- 23-4307 Front Narrow Glide Junction Block
- 23-4305 90° Long Forward Control Banjo, 10mm
- 23-4303 35° Short Rear Brake Banjo, 10mm
- 23-4304 90° Short Rear Brake Banjo, 10mm

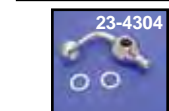
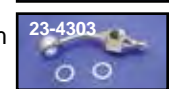
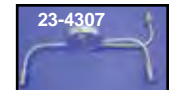
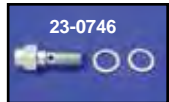



# Brake Line

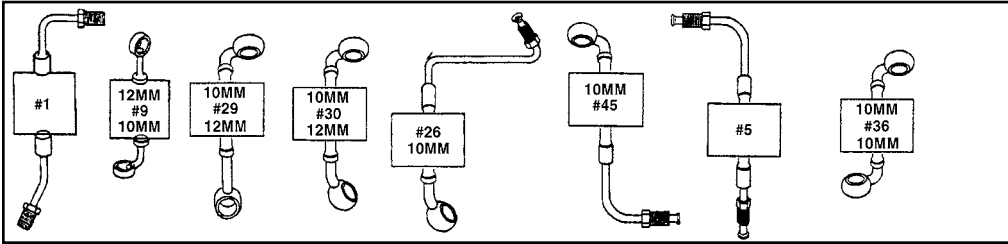

<b>Softails</b>						
*Note: DOT approved.						
Year	Model	Front	Type	Rear		Type
1986-87	FLST	—	9	23-8814		1
1987-up	FLST-FLSTC	23-8745*	9	23-8822 or 23-8839*		
As Above +2 Ext		23-8987	9	23-8822	or	
As Above +4 Ext		—	9	23-8822 or 23-8839*		
As Above +6 Ext		23-8989	9	23-8822 or		
2000-03	FLSTC Heritage Classic	23-8745*	9	23-8838		
1990-99	FLSTF-FLSTN	23-8745*	9	23-8839*		
2000-06	FLSTF Fat Boy	23-8745*	9	23-8838		
1997-99	FLSTS Heritage Springer	23-8757*		— 23-8839		5
2000-06	FLSTS	23-8757*		23-8838*		
1984-86	FXST Standard	23-8728*	9	23-8814		
1987	FXST-FXSTC	23-8728*	9	23-8814		
1987-98	FXST-FXSTC	23-8728*	9	— or		
	(manufactured after 2/1/87)	23-8837*				
As Above +2 Ext		23-8946	9	23-8837*		
As Above +4 Ext		23-8947	9	23-8825 or 23-8837*		
As Above +6 Ext		23-8948	9	23-8837*		
1999-2003	FXST Standard	23-8771		23-8837*		
1999-2003	FXST Standard	23-8771		23-8838*		
2000-up	FXSTC Custom	23-8728*	9	23-8838*		
1988-89	FXSTC Springer	23-8947	9	23-8830 or 23-8837*		
1996-99	FXSTS Springer	23-8760	29	23-8837*		
2000-03	FXSTS Springer	23-8760	29	23-8838*		
1995-97	FXSTSB Bad Boy	23-8761	30	23-8837*		
1999	FXSTB Night Train	23-8770		23-8837*		
1999-2003	FXSTB Night Train	23-8770		23-8838*		
1999-2003	FXSTD Deuce	23-8774		23-8838*		
<b>FL Touring/Dresser Series</b>						
Year	Model	Front	Type	Rear		Type
1984	FLT-FLHT	23-8731*	26, 45	—		5
1985	FLT-FLHT	23-8731*	26, 45	—		5
1986-91	FLT-FLHT	23-8731*	26, 45	23-8847*		36
1992-96	FLT-FLHT	23-8731*	26, 45	— 23-8842*		36
1997-03	FLT-FLHT	23-8731*	26, 45	23-8844*		5
1994-96	FLHR-FLHRI	23-8756*		23-8842*		
1997-2007	FLHR-FLHRI	23-8756*		23-8844*		
As Above +2 Ext		23-8997		23-8844*		
As Above +4 Ext		23-8998		23-8844*		
As Above +6 Ext		23-8999		23-8844*		
2008-11	FLHR-FLHT-FLHX	23-8778				
<b>Upper Lines Only</b>						
23-8986	1984-02 FLT-FLH	29" 10mm	25 Upper Line Only			





# Brake Line



BIG TWIN

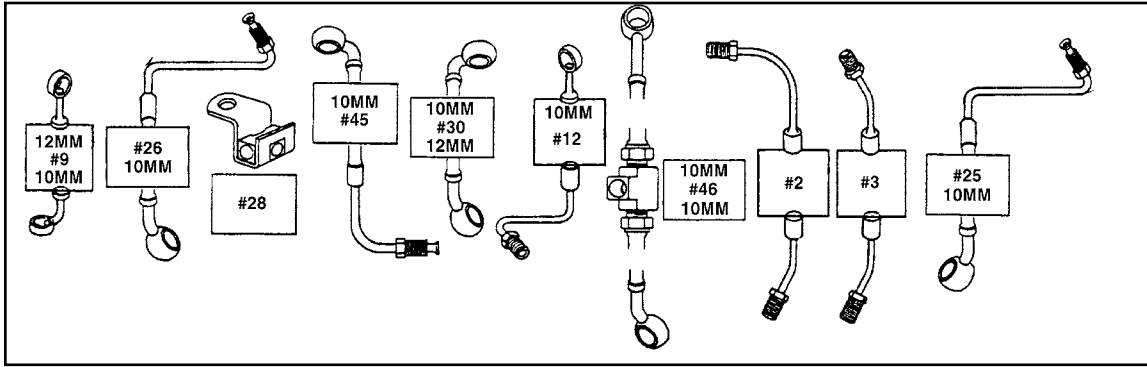

Fittings Shown  
for Reference  
Only



Dyna Series					
Year	Model	Front	Type	Rear	Type
1991	FXDB Sturgis	23-8751*	9	23-8826 or 23-8836*	46
1992	FXDB Daytona	23-8749*	26, 28, 45	23-8836*	46
1992	FXDC Custom	23-8749*	26, 28, 45	23-8836*	46
2005	FXDC Custom	23-8773		23-8833	
2006-07	FXDCI Custom	23-8769		—	
1992-99	FXDL Low Rider	23-8749*	26, 28, 45	23-8836*	46
2000-05	FXDL Low Rider	23-8744*	26, 28, 45	23-8833*	
2006-07	FXDL Low Rider	23-8768		—	
1993-99	FXDWG Wide Glide	23-8728*	9	23-8836*	46
2000-05	FXDWG Wide Glide	23-8728*	9	23-8833	
2006-07	FXDWG Wide Glide	23-8766			—
1994-99	FXDS Convertible	23-8749	26, 28, 45	23-8836*	
2000-03	FXDS Convertible	23-8749	26, 28, 45	23-8833*	
1995-99	FXD Super Glide			23-8836*	46
	As Above +4" Ext	23-8983	30	23-8836	46
2000-05	FXD Super Glide		23-8773*	23-8833*	
2006-07	FXDI Super Glide		23-8769		
1999-05	FXDX Super Glide Sport	23-8836*		23-8833*	
2000-06	FXSTD	23-8774			

Upper Line Only					
VT No.	Year/Model	Length	Type		
23-8980	1992-02 FXDL-FXDS	26 1/4" 10mm	25	Upper Line Only	

FX Series					
Year	Model	Front	Type	Rear	Type
1984-85	FXE-FXEF	23-8722*	9	23-8810	2
1984-87	FXS-FXRS-FXRDG-FXRC	23-8722*	9	23-8813*	3
1984-85	FXSB			23-8810	2
1984-86	FXWG			23-8810	2
	As Above +2" Ext	23-8953	9	23-8810	2
	As Above +4" Ext	23-8954	9	23-8810	2
	As Above +6" Ext	23-8955	9	23-8810	2
1985-86	FXRS Sport	23-8760*	12, 28, 45	23-8813	3
1987-93	FXRS Sport		26, 45	23-8846*	46
1987-94	FXLR		9	23-8846*	46
1988-92	FXRT Sport	23-8747*	26, 28, 45	23-8846*	46
1988-92	FXRT Sport Glide	23-8747*	9	23-8846*	46
1988-94	FXR, FXRS, FXRC	23-8746*	26, 28, 45	23-8846*	46
1989-93	FXRS Convertible	23-8749*	26, 28, 45	23-8846*	46
1999	FXR2, FXR3	23-8775*		23-8848*	
1999	FXR4	23-8776*		23-8848*	

Lower Lines Only					
Year	Model	Front	Type	Rear	Type
23-8956	1984-87 FXRT-FXRD	-3"	12	Lower Line Only	
23-8958	1984-87 FXRT-FXRD	-4"	45	Lower Line Only	

\*Note: D.O.T. approved.





# 49mm Fork



24-0925



24-0924

**49mm Fork Components** fit 2006-up FXD forks.

<b>VT No.</b>	<b>Item</b>	<b>VT No.</b>	<b>Item</b>
24-0924	Top Triple Tree	2339-5	Axle Spacer
24-0925	Chrome Lower Tree	24-0197	Top Nut Kit
24-0926	Bearing Adjuster Nut	44-0699	Axle
24-0953	Lower Dirt Guard	24-0818	Stem Cover
24-1080	Slide Bushing	2272-5	Clamp Screw



**Chrome Fork Boot Set** fits 49mm FXD-FXDWG models. Easy to install without disassembly of fork.  
**VT No. 24-1213**



**Chrome Fork Boots** fit 49mm FXD style forks.  
**VT No. 24-0499**



50-0266



50-0265



50-0267



50-0882

**Steel Front Fender** fits 2006-up with 49mm forks.

<b>VT No.</b>	<b>Model</b>	<b>Wheel</b>
50-0266	FXD	19"
50-0265	FXDWG	21"
50-0267	FXCW	19"
50-0882	FXDF	16"



**49mm Fork Brace** fits 2006-up FXD, will not fit FXDWG.  
**VT No. 24-0983**



**Kwik-Klip** attaches brake line or speedometer cable to fork leg inner diameter is 49 mm.

**VT No. 24-1024**



**49mm Fork Clamp** will hold clutch cable position.

**VT No. 31-1010**



**49 mm Grooved Billet Fork Clamps.**

**VT No. 31-0323**



**Fork Rebuild Kit.**

<b>VT No.</b>	<b>Model</b>
24-1083	FXD
24-1056	FLT



24-1153

**Complete 49mm Fork Assemblies** include assembled right and left fork slider assembly, top triple tree, bottom triple tree and axle. FXDWG assemblies are stock replacement for 2006-up but can be installed on 2001-05 models which will require use of 2006-up front fender, brake caliper and wheel.

**VT No. Sliders**

24-1153 Polish

24-1157 Chrome

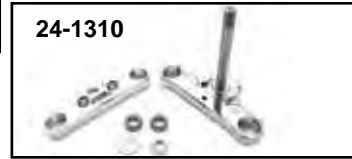

24-1310



24-1203



24-1049



24-1202

**49mm Fork Components** fit 2006-up FXDWG forks.

<b>VT No.</b>	<b>Item</b>	<b>VT No.</b>	<b>Item</b>
24-0948	Right Hand Slide Assembly	24-0953	Lower Dirt Guard
24-0949	Left Slide Assembly	44-0691	Axle
24-0970	Right and Left Set	24-1049	Chrome Tube Assembly
24-1202	Top Tree (chrome)	24-1059	Chrome Leg Set
24-1417	Top Tree, 2008-up	2337-5	Axle Spacer
24-1217	Lower Tree	24-0197	Top Nut Set
24-1310	Triple Tree Set (V-Twin)	24-0818	Stem Cover
24-0926	Bearing Adjuster Nut	2272-5	Clamp Screw
24-1080	Slider Bushing		



24-1231



24-1411



24-1235

**Billet Tree Sets** fit 49mm FXDWG forks.

<b>VT No.</b>	<b>Type</b>
24-1409	Ball Milled
24-1411	Smooth
24-1235	OE, 49MM



24-1232

**Chrome Triple Trees** fits FXCWC models.

<b>VT No.</b>	<b>Type</b>
24-1231	Lower
24-1232	Upper



**Chrome Triple Tree Set** fits 2008-up 49mm FXDF models or as a conversion for Early Model Softail 1984-up.

**VT No. 24-1154**

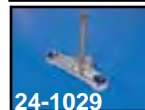

24-1029



24-1202

**49mm Fork Tube Sets** with hard chrome finish.  
**2006-up All Dyna models (except FXDF).**

<b>VT No.</b>	<b>Fits</b>
24-1185	Stock FXD 25 1/2"
24-1186	Stock FXDWG 27 1/2"
<b>2008-up FXDF</b>	
24-1187	Stock 25 1/2"
<b>2014-up FLT models</b>	
24-1188	Stock 22 3/4"

**Trees** to fit 1980-99 FXST-FXWG when using 49mm fork tubes.

<b>VT No.</b>	<b>Type</b>
24-1029	Lower
24-1202	Upper



# 41mm 11.5" Single Disc Fork Assembly

**FXST Style Single Disc Fork/Wheel and Caliper Assembly** features chrome trees with 1" stem. Available with polished or chrome lower sliders without reflector boss, and hard chrome fork tubes and internals installed. Legs to accept a left side single disc caliper, 11.5" brake disc and hard chrome fork tubes with internals assembled. Axle, neck, bearings, top cone, stem nut, pinch bolts, and bearing dust covers are included. Stock length is 31" overall. Kit also includes a 21" all chrome assembled wheel with bearings, drilled 11.5" brake disc with chrome screws and chrome disc caliper complete with mount hardware and pads. Fits 1948-99 FX-FL.

- VT No. Caliper**  
**24-2044** Polish  
**24-2006** Chrome

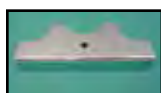

**Chrome Lower Tree Cover** covers area on lower tree below headlamp.

**VT No. 31-9991**

## Phatt Fork Assembly



**Chrome Billet Phatt Fork Kit** features smooth top tree, massive fork tube covers, hidden fork stops, smooth billet lower legs and hidden axle. Trees are stock FXST rake. Available in stock (31") to +12" extended length. Use 1 1/2" single disc and caliper assembly. Order tree set and leg set separate as two numbers. Tree set includes upper covers and leg set includes lower covers in correct length for tube application. Note: Parts listed on this page are not compatible with any other trees or legs in this catalog.

VT No.	Length		
<b>24-9000</b>	Trees Only	Stock Rake	
<b>24-9007</b>	Trees Only	0° Rake for Raked Legs	
For Stock Rake Trees Leg Assembly*		For Rake Trees Leg Assembly*	
<b>24-9008</b>	+8"	<b>24-9016</b>	+2"
<b>24-9010</b>	+10"	<b>24-9017</b>	+4"
<b>24-9012</b>	+12"	<b>24-9018</b>	+6"
		<b>24-9019</b>	+8"
		<b>24-9020</b>	+10"
		<b>24-9021</b>	+12"

\*Note: No Hidden Fork Stops.

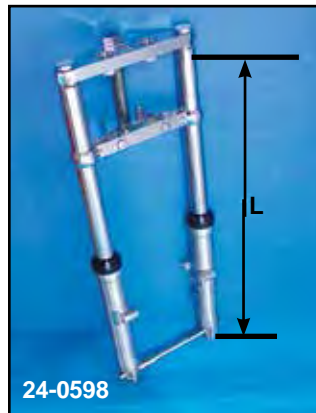

**FXST Style Single Disc Fork Assembly** features chrome trees with 1" stem, polished or chromed lower slider legs, to accept 11.5" caliper and brake disc, hard chrome fork tubes, axle, neck bearings, top cone and stem nut, pinch bolts and bearing dust covers. Fork is 31" overall length (L) and legs are assembled. Single disc unit accepts 11.5" brake disc and left side caliper.

VT No.	Fits	Year
<b>24-9950</b>	Big Twin Single Complete	1980-99
<b>24-2004</b>	As Above with Chrome Lower Sliders	1980-99
<b>24-0598</b>	Complete with Axle, Chrome Trees and Lower Legs	2000-06



### Chrome Billet Phantom 41mm Fork Assembly

- Features hidden top bolt and lower clamp assembly screws.
- Kits include billet lower legs and axle to fit 11.5" brake disc and caliper, 1984-99 type.

Stock	3° Rake	5° Rake	Length
<b>24-5550</b>	<b>24-5567</b>	<b>24-8500</b>	Stock (31")
<b>24-5556</b>	<b>24-5570</b>	<b>24-8507</b>	+6"

**The V-Twin™ Fork Assembly** is shipped complete with axle, axle nut, spacer, top nut, bearings, cone nut, dust cover, triple trees and fork tubes and sliders. Fork tubes and sliders are fully assembled with internals. Final assembly of the remaining components is done by the dealer. Every leg assembly is shipped dry. We recommend use of the appropriate fork oil such as Type B. The amount of fork oil to add varies by model. A FX will need about 6 oz per leg, a FL will need about 8.5 oz per leg and a FXWG needs about 10 oz per leg. Due to oil cling, dry for leg needs about 1 oz more to fill than a drained leg would require.

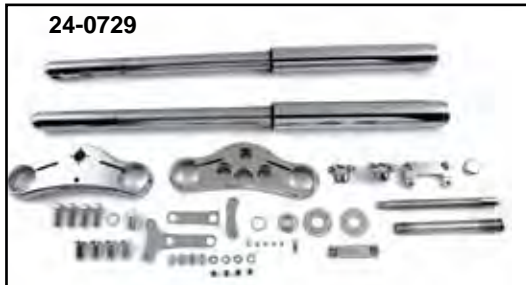

**Chrome Inverted Fork Assemblies** feature 45mm lower tubes with 63.5 mm upper tube assemblies with overall length from the top of the tree to axle center as noted. Adjustable fork stops permit installation on FXST or FXDWG models. Top nut, axle and fender mounts included. Use with 1984-99 caliper, wheel and 11.5" brake disc single disc.

VT No.	Length
<b>24-0729</b>	40.5"
<b>31-0351</b>	Brake Line Clamp





# Replica Fork Assembly

**41mm Glide Fork Assemblies** include forged chrome replica triple trees, hard chrome tubes on stock length forks, chrome tubes on overstock length and polished or chrome lower legs with all internals installed less hardware. Stock overall length is 31". Order installation kit separately.

	(A) FXWG, Dual 10"		(B) FXST, Single 11.5"		(C) FXST, Dual, 11.5"	
	Polish	Chrome	Polish	Chrome	Polish	Chrome
Stock	24-1500	24-1525		24-1532	24-1501	24-1546
2"	24-1503	24-1526	24-1509	24-1533	24-1515	24-1540
4"	24-1504	24-1527	24-1510	24-1534	24-1516	24-1541
6"	24-1505	24-1528	24-1511	24-1535	24-1517	24-1542
8"			24-1512	24-1537	24-1518	24-1543
10"			24-1513	24-1538	24-1519	24-1544
12"			24-1514	24-1539	24-1520	24-1545



**Fork Installation Kit** includes two bearings, dust covers, top nut axle and related hardware.

VT No.	Type	Year	Model
24-0774	2 Disc	1984-99	FXST
24-0833	1 Disc	1986-99	FLST
24-0772	2 Disc	1984-99	FLT
24-1158	2 Disc	2000-07	FLT
24-0773	2 Disc	1986-99	FLST



**41mm Billet Fork Assembly** with stock rake trees and 32" overall length. Fits 1984-99 calipers.

- VT No. Item**
- 24-1547** Fork
- 44-0891** Axle
- 24-1280** Legs



**16" FL Wheel Shown on Billet Fork Assembly.** Wheel has proper offset to fit all 41mm forks which accept 1984-99 single disc caliper. Order caliper, speedo drive and spacer separately.

- VT No. Item**
- 52-0696** 16" Wheel
- 36-0803** Speedometer Drive, Left Side
- 44-0254** Spacer, Right Side

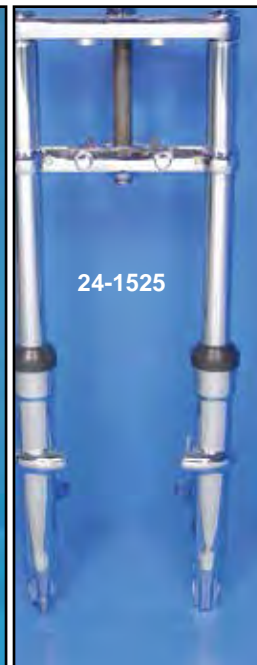

## 41mm Narrow Glide

**41mm Narrow Glide** will replace 39mm assembly on FXD models. Use with original wheel and brake assembly from 1984-03. Wheel not included.

VT No.	Item	Type
24-1275	Fork Assembly	Dual
24-1276	Fork Assembly	Single
24-1280	Fork Sliders	
52-0170	19" Wheel	Single/Dual
52-0171	21" Wheel	Single/Dual



# FXR 1982-94, FXD 1991-up 41mm Fork Assembly



Single Disc Style  
24-2005

**FXST 11.5" Single Disc Style Fork Assembly** fits FXR 1982-94 or 1991-up FXD Dynaglide models. Assembly is available with chrome triple trees, polished or chrome lower legs without reflector boss to accept a left side single disc 1984-99 type caliper and 11½" brake disc. Hard chrome fork tubes with internals assembled, axle, neck bearings, top cone, stem nut, pinch bolts and bearing dust covers are included. Stock unit is 31" overall length. FXR units do not include provision for fork lock.

### Complete Single 11.5" Disc Fork Assemblies.

VT No.	Year	Model	Slider
24-9971	1982-94	FXR	Polished
24-2005	1982-94	FXR	Chrome
24-2008	1991-05	FXD	Polished
24-2007	1991-05	FXD	Chrome
24-9997*	2000-05	FXDWG	Polished
24-2047	2000-05	FXDWG	Chrome

\*Note: Does not include axle

### Complete Dual 11.5" Disc Fork Assemblies.

24-9952	1982-94	FXR	Polished
24-9973	1982-94	FXR	Chrome
24-2009	1991-05	FXD	Polished
24-2010	1991-05	FXD	Chrome

### Complete Single 11.5" Disc Fork Assembly and 21" Wheel Kits.

Include a 21" all chrome assembled wheel with bearings, drilled 11.5" brake disc with chrome screws and a chrome single disc caliper complete with mount hardware and pads.

24-2017	1982-94	FXR	Polished
24-2018	1982-94	FXR	Chrome
24-2027	1991-05	FXD	Polished
24-2028	1991-05	FXD	Chrome



Dual Disc Style  
24-9975

**FXWG 10" Style Dual Disc Fork Assembly** fits 1982-94 FXR and is available with polished or chrome lower sliders which are smooth at the reflector boss area, accepts dual disc calipers, 10" brake disc, chrome trees, bearings, axle, spacer and top nut. Hard chrome tubes with internals are assembled. Stock is 31" overall length. Units do not include provision for fork lock

### Complete Dual 10" Disc FXR Fork Assembly

VT No.	Slider
24-9970	Polished
24-9975	Chrome

### Complete Dual 10" Disc Fork Assembly and 21" Wheel Kits

Include a 21" all chrome assembled wheel with bearings, two drilled 10" brake discs with chrome screws and chrome caliper set complete with mounting hardware and pads.

24-2015	10" Dual	FXR	Polished
24-2016	10" Dual	FXR	Chrome

# Billet Leg Assembly



24-1236



24-1237



24-1356



24-1032



24-1238



24-1277

**Billet Leg Assembly Kit** includes axle and bearings as noted.

VT No.	Item	Overall Length
24-1236	+6" Leg Assembly	38"
24-1237	Leg Assembly	32"
24-1356	Leg Assembly	38"
24-1562	Leg Assembly	38"
24-1239	Leg Assembly	38"
24-1032	Leg Assembly	32"
24-1238	Leg Assembly with ball mill	32"
24-1277	Leg Assembly with ball mill	38"



**49mm Fork Assembly** includes chrome upper and lower trees with stock tubes and chrome sliders. Fits 1971-99 FX.

VT No. 24-1319



# 41mm Fork Assembly 11.5" Dual Disc

**11.5" Dual Disc Fork/Wheel Assembly** includes complete fork assembly. Kit also includes a 21" all chrome assembled wheel with bearings, 2 drilled steel 11.5" brake disc with corn screws, chrome style disc caliper set, speedometer drive and adapter, complete with mount hardware and pads. Fits 1948-99 FX-FL.

<b>VT No.</b>	<b>Sliders</b>
24-2038	Polished
24-2039	Chrome



# 11.5" Dual Disc Fork Assembly

**11.5" Dual Disc Fork Assembly** features FXST style components. Assembly includes chrome triple trees and hard chrome fork tubes installed in polished or chrome, lower sliders with all internals installed, which accept dual 11.5" brake discs and calipers. Overall length is 31". Kit includes axle, spacer, neck bearings, top cone. Order stem nut and bearing dust covers separately. If a front wheel drive speedometer is not desired. Order axle kit VT No. 44-0570 separately.

<b>VT No.</b>	<b>Fits</b>	<b>Sliders</b>
24-9949	Big Twin Complete	Polish
24-9972	Big Twin Complete	Chrome
52-0127	21" Wheel with Chrome Spokes	—
52-0181	21" Wheel with Stainless Steel Spokes	—
24-9948	Right and Left Slider Assembly	Polish
24-0517	Right and Left Slider Assembly	Chrome
36-0547	Speedometer Drive Adapter Kit	
23-2226	Chrome Caliper Set	



# 41mm 10" Dual Disc Fork Assembly



**FXWG Style Dual Disc Fork/Wheel and Caliper Assemblies** to fit 1948-99 Big Twin FL-FX-FXWG features polished or chromed lower sliders without reflector boss. Hard chrome fork tubes and internals installed. Includes chrome trees with 1" diameter stem, neck bearings, axle spacer and top nut. Stock length is 31" overall. Kit also includes 21" all chrome assembled wheel with bearings, drilled 10" steel with chrome screws, and choice of black or chrome dual disc calipers complete with pads. 24-9947 has smooth lower legs.



**FXWG Dual Disc Fork Assembly Front Wheel Speedo Drive Kit** will allow use of 2:1 ratio speedo. Kit includes axle, speedo drive and adapter flange.  
**VT No. 36-0547**

<b>VT No.</b>	<b>Item</b>	<b>Caliper</b>	<b>Sliders</b>
24-2000	Kit	Chrome	Polished
24-2011	Kit	Chrome	Chrome
<b>Fork Assembly Only</b>			
24-0779	Fork Assembly		Polish
24-1525	Fork Assembly		Chrome
24-9947	Fork Assembly		Polish



**Fork Assembly Kit** fits 1973-84 FL, 1980-83 FXWG.  
**VT No. 24-0776**





# "D" Style Replica



24-9978 Installed

**Chrome Billet Style Fork Assembly** features chrome machined triple tree set with "hidden" top nut. Chrome leg assembly is smooth style to accept 2000-up left side caliper and a FXSTD style fender. One inch neck bearing and axle kit included.

**VT No. 24-9978**



24-9944  
24-9976



**Glide Fork, FXSTD Style** features all chrome components, including axles and nuts. Bearings included.

VT No	Year	Model
24-9944	1990-99	Softail
24-9976	2000-up	FXD
24-0512	Standard	Leg Assembly
24-0080	Standard	Tube Assembly



**Chrome "Fatty" Curved Riser Set** features pull back styling as on 2000-up models. Kit includes two piece cap set and risers with 5" rise and 2" pull back and 1/2" x 13 internal threads. Replaces 56033-00.

**VT No. 26-0539**



**2000-up Chrome Deuce Triple Tree Set** includes upper and lower tree.

**VT No. 24-0666**



**41 mm Chrome Wide Glide Billet Fork Assembly.**

**VT No. Fits**

**24-0688** 6"+ over stock length of 31"

**24-0689** 8"+ over stock length of 31"



**FXSTD Chrome Lower Triple Cover.** dresses up the unfinished underside of lower triple tree. Includes mounting hardware. Replaces 66021-00.

**VT No. 42-0080**



**Chrome Riser Adapter Kit** allows use of custom risers on the FXSTD Deuce.

**VT No. 26-0534**



50-0203



50-0199



50-0200



50-0201

**2000-up FXSTD Steel Front Fender** replaces 59876-00.

**VT No. Type**

**50-0203** Black Primer

**50-0199** Black Primer with chrome bracket

**50-0200** Chrome

**50-0201** OE, Black Primer





# Fork for FLST 41mm

**FLST Fork Assembly** is 1986-99 Replica style featuring a chrome top tree, black lower stem with chrome or polished lower sliders with hard chrome fork tubes and internals installed to accept 11.5" disc. Includes neck bearings, top nut and axle kit. Unit accepts 5 piece chrome tin fork cover set 24-9959 for the authentic look. Order fender, wheel, and tin set separately. Fits 1949-84 FLH, 1971-84 FXE and 1985-99 Softtail models. Units are 32 1/4" long overall length from top tree to axle position.



VT No.	Item	Sliders	Disc
24-9951	Fork Assembly	Polish	1
24-0515	Fork Assembly	Chrome	1
24-2120	Fork Assembly	Chrome	2
24-9959	Chrome Five Piece Cover Set		
52-0696	16" Wheel with chrome spokes		
50-1075	As Above without trim holes		
50-0764	Fat Kid Fender, pictured		
23-3061	Left side, black caliper		
23-3082	Left side, chrome caliper		
24-9995	Right and Left Slider Assembly	Polish	
24-0511	As Above	Chrome	

**Fork Assembly** for 2000-up FLSTF, FLSTC models, with 32° frame rake. Kit includes fork assembly, triple trees with bearings, dust shields and hardware. Available with finishes as noted.

VT No.	Lower Legs	Trees
24-0579	Chrome	Chrome

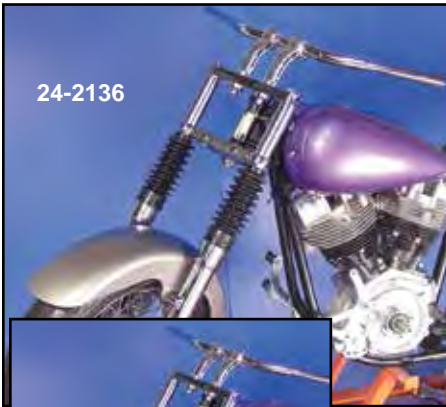

**Note: All related parts are available separately.**

Item	VT No.
• 16" x 3 Wheel	52-0131
• Fender	50-0764
• Brake Discs (2)	23-0300
• Discs Bolts (2)	8794-10
• Gator Boots	28-0439
• Caliper Set	23-2226
• Speed Drive	36-0547
• Inner Tube (SV)	46-0115

**Choice of Triple Trees:**

VT No.	Type	Fits
24-0000	Softtail	—
24-0719	"D"	—
24-0800	FLH	Cowl
24-0829	Early Big Twin	Stainless Steel Covers

**Dual Disc Fork Assembly** accepts right and left 1984-88 style calipers to fit 11.5" discs. This combination gives the ultimate in stopping power for 1948-84 FX-FL, 1986-99 FXST-FLST.

Overall length is 31". The basic kit includes

- FXST or FLH Tree Set
- 24-0518 DD Leg Assembly
- 24-0776 Fork Install Kit

**VT No. Tree Type**

24-2136 FXST

24-0514\* FLH

\*Note: Use wheels 52-0848/52-0849

## Fork Assembly for FLST



**FLST Style Complete Front End Assembly** includes the complete fork kit with the addition of the five piece chrome fork cover set, 7" headlamp and bracket, 16" chrome wheel, speedometer drive, chrome caliper, 11.5" drilled disc and fat kid style or FLST style fender.

VT No.	Type	Caliper	Slider
<b>Fat Kid Style</b>			
24-2019	Kit	Black	Polish
24-2020	Kit	Chrome	Chrome
<b>FLST Style</b>			
24-2021	Kit	Black	Polish
24-2022	Kit	Chrome	Chrome

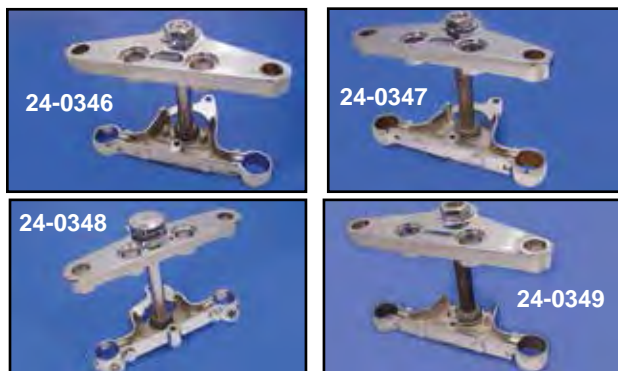

**Replica Chrome Forged Steel Triple Tree Sets** include lower bearing pressed on, dust shield set and upper bearing and cone nut.

VT No.	Year	Model
24-0346	1984-87	FXST
24-0347	1988-99	FXST
24-1335	2000-up	FXST
24-0350	2000-up	FLST
24-0348	1986-99	FLST
24-0349	1992-05	FXDWG
24-0350	2000-up	FLST



**Chrome FXST Lower Fork Stem** accepts 41mm fork tube and fits FXST or neck cups with built in stops.

VT No.	OEM	Years
24-9933	45640-88B	1984-85
24-0064	Without lock	1988-99
24-0235	45640-00	2000-up



**Chrome FXST Headlight Bracket** mounts bottom style mount head lamps on fork, also covers rough casting on lower tree.

VT No.	OEM	Years
31-0140	67773-80	1980-up
31-9991*	67773-80A	1986-93

\*Note: Does not have holes for front mounting. Mounts by headlight eye bolt only and acts as tree cover.

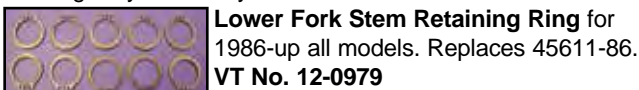

**Lower Fork Stem Retaining Ring** for 1986-up all models. Replaces 45611-86. VT No. 12-0979



**Fork Stem Die Holder.** Order die separately.

VT No.	Item
16-0272	Holder Only
16-0051	Set
16-0836	Die Only 1" x 24 TPI

# 41mm Glide Tree

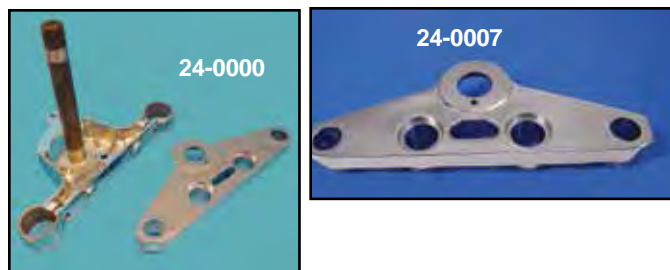

**FXST Triple Trees** accepts 41mm fork tubes. Bottom tree features built in rake and rounded edges. Trees use VT No. 28-2218 rubber bushing set and headlamp bracket VT No. 31-9991 which are not included.

VT No.	OEM	Years	Item
<b>TREE SETS</b>			
24-0000	—	1984-87	FXST
24-9930	—	1988-99	FXST
24-0993	—	2000-up	FXST
24-0540*	—	1992-05	FXDWG

<b>TOP TREE ONLY</b>			
24-0007	45672-80	1984-88	FXST
24-0062	45672-80A	1989-up	FXST

<b>LOWER TREE ONLY</b>			
24-0825	45665-80A	1984-87	FXST
24-0843*	45665-80A	1984-87	FXST
24-9933	45640-88B	1988-99	FXST
24-0006	45679-92	1992-05	FXDWG
24-1070	Tab	1984-87	FXST
24-1403	46386-08	2008-up	FXDWG



**Chrome Top Tree** for 1989-up FXST-FXDWG features updated design. Replaces 45672-80A.

VT No. 24-0062



**Chrome "D" Style Tree Set** features chrome steel construction to fit 1980-99 Softail models.

VT No. 24-0719

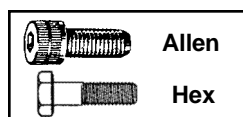

**Lower Stem Pinch Bolts** available in zinc hex or chrome allen. Chrome allen set for FXWG-FXST includes headlight bracket screws.

VT No.	Type	Fits	Finish
37-8835	Hexagon	1949-up FL-FXWG-FXST	Zinc
9803-4	Hexagon	1949-up FX-FXST	Chrome
9782-4	Allen	FL-FXWG-FXST	Chrome



**Black Adjustable Fork Tree Kit** is available for 1977-84 FLH, FXWG 41mm fork legs. Showa type is 1977-up. Kits feature swivel type plugs which are included. Lower tree has two positions for changing rake and fork lock tab. Kits use VT No. 28-0221 rubber bushing kit and VT No. 24-9910 top tree cover.

VT No.	Fits
24-0797	1977-84 FLH 80-86 FXWG Complete, Black
24-0004	As Above without Tabs





# 41mm Glide Tree fits FLST models



**FLST Fork Stem and Top** fits 1986-up models with 41mm fork tube use VT No. 24-9959 fork tin set. **Note** Sets 24-0304 and 24-0498 do not accept covers or cowls.

VT No.	OEM	Item	Year	Finish
24-0270	45605-88	Lower Stem	1986-99	Black
24-0273	W/o lock tab	Lower Stem	1986-99	Black
24-0271	45605-88	Lower Stem	1986-99	Chrome
24-0301*	45605-88	Lower Stem	1986-99	Chrome
24-0399	W/o lock tab	Lower Stem	1986-99	Chrome
24-0307	45605-00	Lower Stem	2000-up	Black
24-0306	45605-00	Lower Stem	2000-up	Chrome
24-0263	45456-86	Upper	1986-up	Chrome
24-0269	—	Set	1986-99	Chrome Top Black Lower Chrome
24-0284	—	Set	1986-99	
24-0304	W/o lock tab	Set	1986-99	Chrome
24-0498	Smooth W/o lock tab	Set	1986-99	Chrome
24-0341	—	Set	2000-up	Chrome
37-0505	4453	Top Nut with Chrome Cover		

\*Note: Includes lower bearing.

**Fork Stem Lock Tabs** replace broken, bent or missing on stock lower triple trees, to be welded on. Fits 1986-99 FLST. **VT No. 51-0104**



**1986-up FLST Complete Cover Kit** includes front panel, left and right panel, upper slider covers, side trim strips. Mounting hardware not included with chrome kit.

**VT No. Finish**

24-0838 Chrome

24-1039 Black

37-0571 Mounting Kit

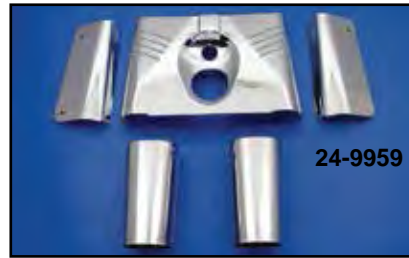

**Chrome Fork Cover Kits** fit 1986-99 FLST in 3 piece tin set or 5 piece which includes slider covers, stock length.

**VT No. Item/Style**

24-9958 3 Piece Set

24-9959 5 Piece Set

24-1266 7 Piece Set

31-0404 Rear Panel Mount Brackets, pair

37-0571 Complete Fork Cover Mount Kit

9981-8 Chrome Screw Kit only



**FLST Smooth Chrome Fork Cover Kit.** Three piece kit includes front panel and matching left and right panels. Fits all 2000-up FLST models.

**VT No. 24-9047**



**Slider Covers** fit 1986-up FLST model forks. Stock length is 6 $\frac{5}{8}$ " overall.

**VT No. Finish**

24-9960 Chrome

24-9986 Stainless

24-9048 Chrome



**Chrome Fork Cover Side Trim Strips** replace stock alloy type 67891-99 on 1986-up FLST models.

**VT No. 24-9911**



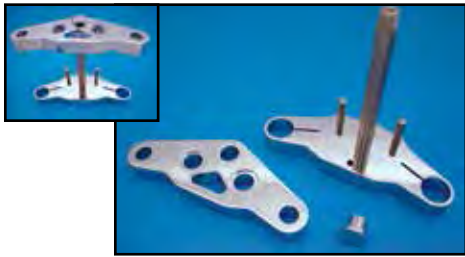

**Ball Milled Chrome Billet Triple Tree Sets** include top nut. Order bearings, cone nut and dust covers separately.  
**24-0069** Stock  
**24-3000** 3°



**Ball Milled Chrome Billet Triple Tree Sets** with turn signal mounting holes in lower tree. Includes top nut. Order bearings, cone nut and dust covers separately.  
**24-1030** Stock  
**24-0921\*** 5°



**5° Ball Milled Chrome Billet Inverted Triple Tree Set** with hidden top stem nut. Order bearings, cone nut and dust covers separately.  
**VT No. 24-1031**

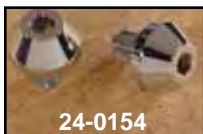

**Taper-Top Socket Fork Caps. 41mm Glide .**  
**VT No. Years/Model**  
**24-0154** 1948-76 FLH



**FXD Fork Stop Kit** is to adapt billet trees to FXD models.  
**VT No. 24-0749**



**Universal Fork Stop** mounts to triple tree.  
**VT No. 24-0492**



**Lower Fork Stem Retaining Ring** for 1986-up all models. Replaces 45611-86. **VT No. 12-0979**



**37-8137 Chrome Flat Top Stem Nut** replaces 45718-71 on 1978-86 FXE-FX-FXR.  
**VT No. Item**  
**37-8137** Nut  
**9963-1** Washer  
**37-0988** Washer



**Chrome Billet Forge Triple Tree Set** fits 41mm tubes. Includes 1" stem, hidden top fork tube caps, collet clamp at lower tree and head lamp mount.  
**VT No. Rake**  
**24-0746** Stock  
**24-0078** 3°  
**24-0077** 5°

# 41mm Tree



**Smoothie Triple Tree Set** features hidden stem nut tree for use with 41mm fork tubes. Kits include riser bushings and stem hardware.

VT No.	Item	Rake	Models	Year
<b>24-0061</b>	Tree Set	Stock	Big Twin	1949-99
<b>24-0366</b>	Tree Set	5°	Big Twin	1949-99
<b>24-0154</b>	Top Plugs			1949-76
<b>24-2053</b>	Stop Pins		All	Above



**Contour Chrome Billet Tree Set** with hidden top nut and pin stops. Order bearings and dust covers separately. Includes stem.

VT No.	Rake
<b>24-0068</b>	Stock
<b>24-0987</b>	3°
<b>24-0988</b>	4°
<b>24-0989</b>	5°
<b>24-1025</b>	5° As Above for use with internal fork stops
<b>24-0990</b>	6°
<b>24-1200</b>	Stop Pin Set for 24-0068
<b>24-1201</b>	Stop Pin Set for Above except 24-0068



**Raked Billet Tree Set** with or without 5° built in rake and hidden stem. Stop pins included. **\*Note:** Includes signal mounts on lower tree.

VT No.	Rake
<b>24-1030*</b>	0°
<b>24-1031*</b>	5°



# 41mm Lower Leg



**Chrome Lower Fork Slider.**  
VT No. Fits  
**24-0580** FXWG 1980-83  
**24-0583** FLHT 1984-99



**41 mm Billet Fork Slider Set.**  
includes caliper bracket for an axle and a 11½" brake disc.  
VT No. **24-0959**



**Extended Billet Fork Slider.**  
**24-6004** +4"  
**24-6006** +6"  
**24-6008** +8"

**Chrome 49mm Lower Leg Set** fits 2002-up V-Rod. Replaces 46526-02A.  
VT No. **24-1198**



**Lower Smooth Polished Legs** feature smooth design without reflector boss, for dual disc 10" applications. Internals not included. Fits 1980-83 FXWG.  
VT No. **24-9934**

**Chrome Lower Fork Slider Sets** replace stock polished sliders on stock 41mm fork assemblies.

- | VT No.                             | Year              |
|------------------------------------|-------------------|
| <b>For FXST-FXDWG-FXSTC (41mm)</b> |                   |
| <b>24-0684</b>                     | 1984-99           |
| <b>24-0584</b>                     | 2000-06           |
| <b>24-1775</b>                     | 2007-up           |
| <b>For FLST-FLSTC-FLSTF (41mm)</b> |                   |
| <b>24-0594</b>                     | 1986-99           |
| <b>24-1342</b>                     | 1986-99 Dual Disc |
| <b>24-0585</b>                     | 2000-06           |
| <b>24-1215</b>                     | 2007-up           |



**Big Twin Glide Lower Leg Cap.**  
VT No. Finish Fits  
**24-0328** Polish 1977-99  
**24-0336** Chrome 1977-99  
**24-0385** Chrome 2000-up

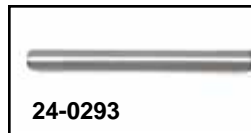

**1" Fork Stem in Raw Finish, 1988-up FXD**  
VT No. **24-0293**



**34.5" Chrome Fork Inverted Assembly.** Top nut, axle and fender mounts included.  
VT No. **24-0718**



**24-0958**  
**Narrow Glide Conversion Kit** to fit FXD-XL 39mm models. Includes upper and lower triple trees, stem, stem nut, fork stops, axle, axle spacers and fender spacers. Kit can be used with 1984-99 FXST/FXDWG 41mm fork leg assemblies and 1984-99 narrow glide 19" or 21" wheel assembly with aluminum hub and front fender. Accepts 11.5" disc and caliper (custom brakes may cause interference with laced wheels). Measures 4<sup>5/16</sup>" between fender mounts and is for front wheel speedometer operation, replace left side axle spacer with speedo drive unit.

- |                |                   |
|----------------|-------------------|
| <b>VT No.</b>  | <b>Item</b>       |
| <b>24-0958</b> | Kit               |
| <b>36-2450</b> | Speedometer Drive |



**39mm Chrome Fork Stem Nut Covers** fit over stock stem nut. 37-9073 includes 2 fork tube cap covers and 1 stem nut cover for 1987-up FXRS-SP, 1988-90 FXLR, 1988-90 FXR.

- |                |                                 |
|----------------|---------------------------------|
| <b>VT No.</b>  | <b>Fits</b>                     |
| <b>24-0637</b> | 1987-up FXR                     |
| <b>37-9073</b> | Three piece set as shown        |
| <b>37-9520</b> | Three piece set Flat Top Style  |
| <b>24-1278</b> | Three piece set, Dome Top Style |



**Top Triple Tree** for FXR-FX with 35mm tubes.  

<b>VT No.</b>	<b>FXR</b>	<b>FX</b>	<b>Finish</b>
<b>24-0802</b>	1982-87	1973-84	Cast
<b>24-0803</b>	1982-87	1973-84	Polished
<b>24-0826</b>	1982-87	1973-84	Chrome Alum.

# Replica 39mm Triple Tree



**Chrome Triple Tree Sets** include upper and lower trees to fit 39mm fork tubes as stock on 1990-05 FXD models.

- |                |             |
|----------------|-------------|
| <b>VT No.</b>  | <b>Item</b> |
| <b>24-0669</b> | Tee Set     |
| <b>37-0865</b> | Screw Set   |
| <b>12-0384</b> | Bearing Set |
| <b>24-0114</b> | Dust Covers |
| <b>24-0089</b> | Bearing Set |



**Chrome Top Triple Tree** for 1988-94 FXR and 1991-05 FXD-FXDL, replaces 45739-87.  

<b>VT No.</b>	<b>Item</b>
<b>24-0865</b>	Top Tree
<b>28-1503</b>	Top Bushing Set
<b>37-0865</b>	Screw Set

**Chrome Lower Triple Tree Cover** fits 39mm forks 1987-up. Designed for easy installation.  
**VT No. 42-0342**

**Upper Bracket Cover** fits 1988-up XL-FXD 39mm forked models, when using a custom bottom mount headlamp.  

<b>VT No.</b>	<b>Item</b>
<b>42-0861</b>	Cover
<b>2272-5</b>	Screw Set

**39mm Lower Tree Applications.**  

<b>VT No.</b>	<b>Fits</b>	<b>Finish</b>
<b>24-0856</b>	1988-94 FXR-FXRT	Aluminum
<b>24-1020</b>	1988-94 FXR-FXRT	Chrome
<b>24-0857</b>	1987-94 FXLR	Polished
<b>24-0665</b>	1987-94 FXLR	Chrome
<b>24-0859</b>	1990-05 FXD-FXDL	Polished
<b>24-0864</b>	1990-05 FXD-FXDL	Chrome

**Lower Fork Stem Retaining Ring** for 1986-up all models.  
**VT No. 12-0979**

**35mm Lower Tree** fits 1984-87 FXR.  

<b>VT No.</b>	<b>Finish</b>
<b>24-0806</b>	Black
<b>24-0855</b>	Chrome





# 39mm Fork Kit

**FX-FXR Fork Assembly with Polished Single Disc Lower Sliders.** Complete Narrow Glide Fork Assemblies for FXR and FXD models. 24-8563 include chrome lower sliders.

VT No.	Year	Model
24-8553	1988-94	FXR-FXLR
24-8554	1990-99	FXD-FXDL
24-8860	2000-03	FXD
24-8563	2004-05	FXD



**39mm Chrome Single Disc Lower Fork Sliders.**

VT No.	Fits	Model
24-0373	1988-99	FXR-FXD
24-0079	2000-2003	FXD
24-0353	2004-up	FXD



**39mm Fork Tube and Slider Assembly** available in right and left pairs, completely assembled. Units have hard chrome fork tubes, and either polished or chrome lower sliders, with springs and all internal components installed.

VT No.	Disc	Fits	Slider	Finish
24-1355	Single	1988-99	FXD	Polish
24-9985	Single	1988-99	FXD	Chrome
24-0984	Single	2000-03	FXD	Chrome



**Flush Mount Axle** fits 1988-04 FXD models, with 3/4" axle and 39mm forks.

**VT No. 44-0003**

## 35 and 39mm Fork Plugs



**39mm E-Z Fill Fork Tube Top Plugs** feature small oil fill cap built in to fork tube top plug which will allow fork oil change/fill without removing top fork cap. Pairs. 1988-up.

**VT No. 24-0863**



**Chrome Top Fork Plugs** fit 39mm FXR, 1987-up.

VT No.	Type	U/M
24-0335	Flat	Pair
9913-2	Flat	Each
9914-2	Dome	Each



**Chrome Domed Top Bolt** fits 35mm. Fits Late 1985-Mid 87 FXR.

**VT No. 8863-1**



**39mm Steering Stabilizer Kit** includes brackets and adjustable round body dampener piston. Fits 1991-05 FXD.

**VT No. 24-0198**



**41mm Narrow Glide** will replace 39mm assembly on XL models. Use with original wheel and brake assembly from 1984-03. Wheel not included.

VT No.	Item	Type
24-1275	Fork Assembly	Dual Disc
24-1276	Fork Assembly	Single Disc
52-0170	19" Wheel	Single Disc
		Dual Disc
52-0171	21" Wheel	Single Disc
		Dual Disc

# Fork Tube and Slider Assembly



**Fork Tube and Slider Assembly** available in right and left pairs, completely assembled. Units have hard chrome fork tubes, and either polished or chrome lower sliders, with springs and all internal components installed.\***Note:** OE as noted.

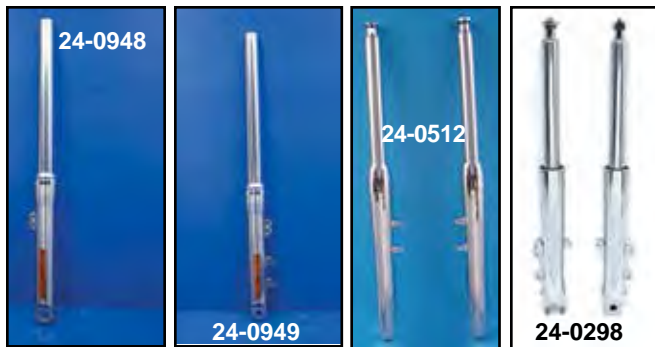

VT No.	Disc	Fits	Slider
<b>41mm</b>			
24-9917	Dual	1980-83 FXWG	Polish
24-0516	Dual	1980-83 FXWG	Chrome
24-0763	Dual	1980-83 FXWG, Smooth Legs	Polish
24-9995	Single	1986-99 FLST-FLSTF	Polish
24-0511	Single	1986-99 FLST-FLSTF	Chrome
24-0521	Dual	1986-99 FLST-FLSTF	Polish
24-0518	Dual	1986-99 FLST-FLSTF	Chrome
24-0298	Single	2000-06 FLST	Chrome
24-1521	Single	2007-up FLST	Chrome
24-9918	Single	1984-99 FXST	Polish
24-0510	Single	1984-99 FXST	Chrome
24-0560	Single +2"	1984-99 FXST	Chrome
24-0561	Single +4"	1984-99 FXST	Chrome
24-0562	Single +6"	1984-99 FXST	Chrome
24-9948	Dual	1984-99 FXST	Polish
24-0517	Dual	1984-99 FXST	Chrome
24-0512	Single	2000-06 FXSTD	Chrome
24-0539	Single	2000-06 FXST-FXDWG	Chrome
24-1052	Single +2"	2000-06 FXST-FXDWG	Chrome
24-1174		2006-07 FXST	Chrome
24-1175		2006-07 FXST	Polish
24-1176		2007 FXST	Chrome
24-1177		2007 FXST	Polish
24-1178		2008-up FXST	Polish
24-1179		2008-up FXST	Chrome
24-1074	Single	2007-up FXST	Polish
24-1077	Single	2007-up FXST	Chrome
24-0519	Single	1973-84 FLH	Chrome
24-9929	Dual	—	Chrome
<b>49mm</b>			
24-1283	Single	2008-up FXCWC(Right and Left)	Chrome
24-0948	Single	2006-up FXDWG (Right)	Polish
24-0949	Single	2006-up FXDWG (Left)	Polish
24-0970	Single	2006-up FXDWG Set	Chrome
24-1033	Single	2006-up FXDWG Set	Polish
24-1064	+2"	2006-up FXDWG	
24-1065	+4"	2006-up FXDWG	
24-1066	+6"	2006-up FXDWG	

**24-1236 Billet Leg Assembly Kit** includes axle and bearings as noted.

VT No.	Item	Overall	Length
24-1236	+6" Leg Assembly		38"
24-1237	Leg Assembly		32"
24-1356	Leg Assembly		38"
24-1562	Leg Assembly		38"
24-1239	Leg Assembly		38"
24-1032	Leg Assembly		32"
24-1238	Leg Assembly with ball mill		32"
24-1277	Leg Assembly with ball mill		38"





# 41mm Fork Tube Set

1997-13 FLT, FLHR, FLHT 2000-up FXST, FLST, 2000-05 FXDWG 41mm.

24-0045	20 <sup>7</sup> / <sub>8</sub> " Replaces 45890-97 Stock FLT Length	Chrome
24-0053	22 <sup>7</sup> / <sub>8</sub> " Replaces 45930-00 Stock FLST Length	Hard Chrome
24-0047	24 <sup>1</sup> / <sub>2</sub> " Replaces 45417-00 Stock FXST-FXDWG Length	Chrome
24-0048	As Above	Hard Chrome
24-0055	24 <sup>7</sup> / <sub>8</sub> " As Above	Chrome
24-0049	26 <sup>1</sup> / <sub>2</sub> " As Above	Hard Chrome
24-0056	26 <sup>7</sup> / <sub>8</sub> " As Above	Hard Chrome
24-0050	28 <sup>1</sup> / <sub>2</sub> " As Above	Hard Chrome
24-0058	30 <sup>7</sup> / <sub>8</sub> " As Above	Chrome
24-0052	32 <sup>1</sup> / <sub>2</sub> " As Above	Chrome
24-0072	36 <sup>1</sup> / <sub>2</sub> " As Above	Chrome
24-0073	38 <sup>1</sup> / <sub>2</sub> " As Above	Chrome
24-0074	40 <sup>1</sup> / <sub>2</sub> " As Above	Chrome

1984-1999 FXST, 1984-1986 FX, 1991-1999 FXDWG 41mm.

24-1352	Stock 20 <sup>7</sup> / <sub>8</sub> "	Hard Chrome
1984-96 FLT, FLHT; 1984-99 FXST-FXSTC, 1986-99 FLST-FLSTF, FLSTN, 1993-99 FXDWG, 1985-86 FXWG, 41mm.		
24-0411	20 <sup>7</sup> / <sub>8</sub> " Replaces 45824-84 Stock FLT length	Chrome
24-0027	As above	Hard Chrome
24-0461	22 <sup>7</sup> / <sub>8</sub> " Replaces 45930-86 Stock FLST Length	Chrome
24-1352	As Above	Hard Chrome
24-0412	24 <sup>1</sup> / <sub>4</sub> " Replaces 45417-00 Stock FXST, FXDWG Length	Chrome
24-0021	24 <sup>1</sup> / <sub>4</sub> "	Hard Chrome
24-1353	24 <sup>7</sup> / <sub>8</sub> " As Above	Hard Chrome
24-0413	26 <sup>1</sup> / <sub>4</sub> " As Above	Chrome
24-0463	26 <sup>7</sup> / <sub>8</sub> "	Chrome
24-1354	As Above	Hard Chrome
24-0414	28 <sup>1</sup> / <sub>4</sub> " As Above	Chrome
24-0433	30 <sup>1</sup> / <sub>4</sub> " As Above	Chrome
24-0472	32 <sup>1</sup> / <sub>4</sub> " As Above	Chrome
24-0485	34 <sup>1</sup> / <sub>4</sub> " As Above	Chrome
24-0487	36 <sup>1</sup> / <sub>4</sub> " As Above	Chrome
24-0493	38 <sup>1</sup> / <sub>4</sub> " As Above	Chrome
24-0494	40 <sup>1</sup> / <sub>4</sub> " As Above	Chrome

### Attention!!

These fork tubes have been manufactured and tested for exact fit and application per model. It can be difficult to identify the front end assemblies because they may not always be original equipment. Before installing, compare old and new tubes. Be sure the stock top plugs fit into the new fork tubes. To avoid scratching the chrome, we suggest that the tubes be lightly rubbed with oil before installing into fork legs. Be absolutely sure you have the right tubes before you install them. No fork tubes can be accepted for return that are scratched or damaged due to improper installation or handling.



**41MM Fork Tube Assemblies** are hard chrome finish. Include top plug, springs, spacers and internal pieces completely assembled. Order bushing set separately.

1984-99 FXST, 1984-96 FLT, 1986-99 FLST, 1993-99 FXDWG

AEE (Chrome)	Dura (Hard Chrome)	Length
24-0354	24-0960	24 <sup>1</sup> / <sub>4</sub> "
<b>Stock FXST, FXDWG Length</b>		
24-0356	24-0961	+2"
24-0357	24-0962	+4"
24-0358	24-0963	+6"
24-0359	24-0964	+8"
24-0509	24-0965	+10"
24-0551	24-0966	+12"
24-0577	24-0967	+14"
24-0578	24-0968	+16"
<b>Leg Sets</b>		
VT No.		<b>Length</b>
FL 1977-84	24-0028	20 <sup>1</sup> / <sub>2</sub> "
FLH 1949-76	24-0032	20"
FXWG 1980-83	24-0029	24 <sup>1</sup> / <sub>2</sub> "
FLST 1986-99	24-0070	22 <sup>7</sup> / <sub>8</sub> "
<b>Bushing Set</b>		
	24-0097	

## 35/39mm Fork Tubes



**39mm Fork Tube Assembly** includes internals with springs, assembled for 1987-99. Tube length is 24<sup>1</sup>/<sub>4</sub>".

VT No. 24-0107

1984-E86 XL, 1984-85 FXE-FXEF, 1984-86 FXR-XRS-FXRDG-FXRC, except sport package. 35mm.

24-0016	Stock 23 <sup>1</sup> / <sub>4</sub> "	Hard Chrome
24-0430	2" over stock,	Hard Chrome

1983-86 FXRT-FXRD, 1984-85 FXSB, 1985-86 FXRS with sport package. 35mm.

24-0430	Stock 25 <sup>1</sup> / <sub>2</sub> ",	Hard Chrome
---------	---	-------------

Late 1986-87 XL, 1987 FXR-FXRS models with showa fork except FXRT-FXRD. 35mm.

24-0434	Stock 23 <sup>1</sup> / <sub>4</sub> ",	Chrome
---------	---	--------

**39mm**

1988-94 FXRT, 1987-94 FXRS-SP. 39mm.

24-0019	Stock 25 <sup>3</sup> / <sub>8</sub> ",	Hard Chrome
24-0439	2" over stock,	Hard Chrome
24-0442	4" over stock,	Hard Chrome

1987-94 FXLR, 1988-94 FXR-FXRS 39mm, 1991-05 FXD, FXDL

24-0020	23 <sup>3</sup> / <sub>8</sub> ",	Hard Chrome, Stock
24-0437	23 <sup>3</sup> / <sub>8</sub> ",	Chrome, Stock
24-0019	25 <sup>3</sup> / <sub>8</sub> ",	Chrome, Stock
24-0439	27 <sup>3</sup> / <sub>8</sub> ", (+2")	Chrome
24-0442	29 <sup>3</sup> / <sub>8</sub> " (+4")	Chrome





# Fork Brace

BIG TWIN



**Chrome Fork Brace** is four piece design for easy installation on 39mm, 41mm or 49mm forks.

VT No.	Size	Fits
24-0983	49mm	2006-up FXD
24-0842	41mm	1984-up FXST, 1983-05 FXDWG
24-0841	39mm	1985-05 FXR, FXD
24-1839	39mm	Custom
24-1841	41mm	Custom



**Steel Fork Brace.**

Black	Chrome Fits	Model
24-1041	24-1042	41 mm FXST
24-1043	24-1043	39 mm FXD
24-1076	24-1075	49mm FXD
24-1044		FXD-FXR 1988-2005



**Tweek Bar Fork Brace** is a two piece design which clamps directly to fork tube. \*As noted clamps directly to fork tube. 24-0768 clamps to fork leg. Fits 41mm forks.

VT No.	Fits	Finish
24-9984*	1949-84 FLH, 1980-up FXWG-FXST	Polish
24-0840*	As Above	Chrome
24-0768	Three Piece	Chrome



**Chrome Billet Fork Brace Insert** that has a unique 3 piece design allows for easy installation on 41mm fork assemblies.  
VT No. 24-0768

# Steering Damper Kit



**Alloy Heavy Duty Steering Damper** is universal, multi-position, adjustable and can be secured between the frame and most forks. Fork tube and frame clamps sold separately.

VT No. 24-0168



**Steering Damper Fork Tube Clamp** in alloy finish available in two piece design for attaching damper end to fork tube.

VT No.	Size
24-0657	39mm
24-0658	41mm



**Chrome Steel Mount Clamp** with 3/8 mount hole. Use to mount damper body to frame tube. Sold pairs.

VT No.	Size (Inner Diameter)
27-0057	1"
27-0059	1 1/4"

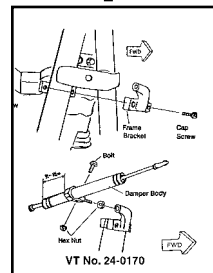

**Steering Stabilizer Kit** includes brackets and adjustable round body damper piston. Made in Japan.

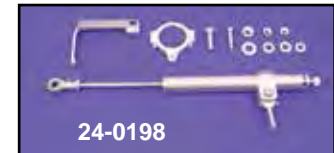
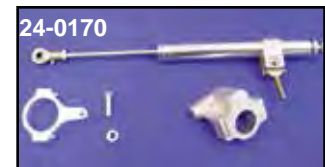

VT No.	Fits	Fork	Year
24-0170	FXST-FXWG Big Twin	41mm	1980-99
24-0196	FXST	41mm	2000-up
24-0198	FXD	39mm	1991-99
24-1027	FXDWG	41mm	1993-05
24-1243	FXD	49mm	2006-up



# Fork Spring Kit



24-0179



24-2100



24-1563

**20th Century Fork Spring Lowering Kits** have progressively wound springs that resist bottoming out. Installation requires minor disassembly to lower the front forks 1 1/4" or 2" depending on the spacer used. Kit includes springs, spacers and hardware. Easily converts back to stock by reinstalling stock fork springs.

**VT No. Size Year/Model**

24-1563 41 mm 1997-13 FLT

24-0160 39 mm 1987-94 FXR

24-0161 35 mm 1984-87 FX-FXR

24-2100 41 mm 2000-13 FLT

**Monotube Fork Cartridge Kits** by Progressive Suspension converts dual damper rod forks to high performance cartridge forks. Improves resistance to front brake drive, front end stability and cornering control.

**VT No. Fits**

24-2101 1984-96 FLT, FLHT, FLHT, FLHR, FLHX

24-2100 1997-13 FLT, FLHT, FLHR, FLHX

24-2102 2000-10 FXST

24-2103 2000-up FLST

24-2104 2004-10 XL



**Progressive Suspension Fork Springs** feature high quality, high performance replacement fork springs eliminate front end sag, reduce nose dive under braking, improve cornering stability, increase ride comfort and allow forks to utilize full travel. Sold in pairs.

**VT No. Size Fits**

24-2057 39 1987-93 FXRS-SP, 1988-93 FXRT, 1991-05 Dynaglide, not FXDWG

24-2056 39 1987-94 FXLR, 1988-95 FXR-FXRS,

24-2045 39 1995-05 FXD

24-2048 41 1984-up FXST-FLST-FLSTF-FXDWG, 1993-06 FXDWG, 1980-13 FLT-FLHT-FLHS, 1980-86 FXWG, 1948-84 FL

24-2040 35 1983-87 FXRT, 1982-87 FXR-FXRS, 1985-86 FXRD, 1973-86 FX-FXE-FXS-FXSB

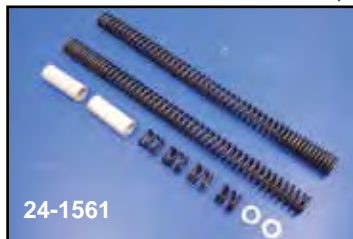

24-1561

**Progressive Suspension Fork Lowering Kits.**

Each kit comes with Progressive rate fork springs and spacers. Each kit can be installed at two different levels to lower fork 1" or 2".

**VT No. Fits**

24-1561 1984-13 FXST-FLST, 1993-05 FXDWG, 1980-13 FLH-FLT, 1978-86 FL-FXWG

24-1560 1991-92 FXD, 1993-99 FXDL-FXDS, 1988-94 FXR-FXLR

24-1559 1982-87 FXR-FXRS, 1983-87 FXRT, 1984-86 FX



## Fork Springs

**Fork Tube Spring Sets** feature high tensile strength wire construction with ground ends. Sold in pairs for OEM replacement per the factory number. For more fork spring applications check factory parts book.

**VT No. OEM Year/Model**

**39mm**

24-0913 45376-87 1988-94 FXR-FXRS

24-0914 45384-83 1984-90 FXRT

24-0364 45941-95 1995-up FXD

**41mm**

24-0907 46051-49A 1949-77 FL-FLH

24-0908 45837-77 1977-84 FLH, 1980-83 FLT

24-0911 46048-84 1984-99 FXST-FXSTC

24-0525 45931-00 2000-up FLST

24-0912 45853-83 1983-96 FLT

24-0915 45931-86 1986-99 FLST

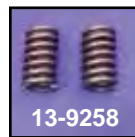

13-9258

**Lower Damper Tube Springs.**

**VT No. OEM Fits**

13-9258 45374-87 87-up FXR-FXD, pair

13-1946 45933-86 86-up FLST, 2000-up FXDWG



**39mm Street Tough Fork Springs** by 20th Century Suspension. Progressively wound springs are made using drawn spring wire. Eliminates front end sag, reduces nose dive under braking and improves stability. 1988-91 Showa FXR.

**VT No. 24-0164**

**Note:** When installing these kits, you must check ground clearance and tire to fender clearance.





**Fork Tube Assemblies** include chrome fork tube plug and caps, seals, springs and damper kit. Fits 1984-99 FXST.  
**VT No. 24-0742**

# Fork Damper Tube



**1984-99 Softail Internal Fork Hardware Kits** include springs, damper kits, seal kit, washer, inner cap tube plug and top taper fork cap.  
**VT No. 24-0767**

**Fork Damper Tubes** less hardware. Sold as pairs.



VT No.	Year	Model
<b>41mm</b>		
24-0455	1984-99	FXST
24-0678	1986-99	FLST
24-0180	1983-96	FLT
24-0148	1977-up	Big Twin Nylon Ring
24-0469	2000-up	FXST
24-0489	2000-up	FLST
24-0490	1997-08	FLT
<b>39mm</b>		
24-0647	1987-93	FXR
24-0476	1995-up	FXD
24-0676	1987-up	FXR Nylon Ring
24-0677	1990-up	Dynaglide Nylon Ring



24-0470



24-0468

**Fork Damper Tube Kit** includes for two sides, damper tubes with rings, screws and washers, lower stops, slider seal washers and retaining rings. For Showa forks.

VT No.	Fits	Size (mm)
24-0470	1984-99 FXST-FXWG	41
24-1270	2000-up FXST	41
24-0471	1986-99 FLST	41
24-0488	1983-96 FLT	41
24-0468	1987-93 FXR	39
24-0496	1995-up FXD	39
24-1333	2008-up FXD	49
24-1334	2006-up FXD	49



**Fork Damper Sets** will lower front forks on Softail models 2.5". Use with stock fork springs.

VT No.	Year
24-0528	1984-99
24-0529	2000-06



**Replica Fork Damper Rods** for all 39mm XL, except 1992-98 Hugger, all Dynaglides and 1987-94 FXRT-FXRS. Sold in pairs. **VT No. 24-0464**

## Fork Internals



**41mm Damper Valve Set** fits 2000-up FXST models. Allows accurate damping of oil flow.  
**VT No. 24-0361**

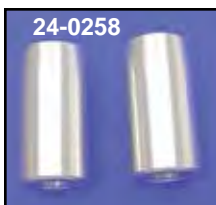

24-0258

**Lower Damper Tube Stop**, sold in pairs.  
**VT No. Fits**

24-0258	1984-99 FXST-FLT
	1995-96 FXDWG
24-0491	1997-up FXDWG
	2000-up FXST-FLT
24-0460	1984-87 FXR
24-0466	1988-94 FXR
24-0375	1990-up FXD



**Chrome Fork Slider Bottom Cap Stud and Nut Kit** includes locknuts and studs. Fits 1973-up Showa and Kayaba.  
**VT No. 8826-6**

**Fork Bushings.**

VT No.	Fits
24-0450	1984-87 FXR Upper
24-0451	1984-87 FXR Lower
24-0182	1988-up FXR Upper
24-0181	1988-up FXR Lower
24-0449	1984-up FXST-FLT Upper
24-0097	1984-up FXST-FLT Lower



24-0097

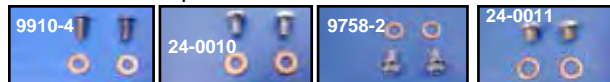

**Fork Drain Screws** are supplied with washers. Sold as pair.

VT No.	Use
9910-4	1973-up Showa
24-0010	1976-up Showa
9758-2	1977-up FLH, 1980-up FXWG
24-0011	As Above





# Fork Boots



24-0098



24-9049



24-0600



24-0606



24-0363



24-0499



24-9939



24-1218



24-1219

**Chrome Wiper Boot Covers** are fork boots die-cast for a snug-fit over the stock rubber fork wiper boot.

VT No.	Item	MM
24-9939	1987-94 FXR	39
24-0098	1980-86 FXWG, 1984-90 FXST	41
24-9049	1980-90 FXWG-FXST	41
24-0600	1991-up FXST	41
	1993-05 FXDWG	41
24-0606	1991-up FXST	41
	1993-05 FXDWG	41
24-0363	1991-up FXST	41
	1993-05 FXDWG	41
24-0937	Custom	41
24-0499	2006-up FXD	49
24-1218	2006-up FXD	49



14-0956



28-0901



28-0904



28-0909

**Rubber Fork Boots** are designed for a better fit and improved sealing and wiping action. Sold in pairs.

VT No.	Model	MM
14-0956	1987-94 FXR	39
28-0901	1949-early 77 FLH	41
28-0904	1984-up FXST, 80-83 FXWG	41
28-0909	1991-up FXST	41
	1993-05 FXDWG	41



24-9992

**39mm Fork Boot Cover Dust Shield Kit** fits 1987-94 FXR, 1991-05 FXD.

VT No.	Model
24-0090	Kit
14-0956	Seals only



24-9993

**2 Piece Chrome Fork Boot Cover Sets** install overstock rubber fork boot by the unique interlocking springs supplied with the kit to securely hold boot covers in place.

VT No.	MM	Model
24-9992	35	Pre 1987 FX-FXR
24-9993	41	1980-up FXWG-FXST, 1993-05 FXDWG



24-1213

**Chrome Fork Boot Covers.** Requires removal of front wheel for installation. Fits 2006-up FXD-FXDWG, 49mm.

**VT No. 24-1213**



28-0439



28-0439



28-0440

**"Gaiter" Fork Boots** are flexible type for FXST-FXDWG-FXWG 41mm forks or FXD 39mm forks. Rubber boots are 230mm long, black. Sold in pairs.

VT No.	Size
28-0440	39mm
28-0439	41mm



**V-Twin Deluxe Seal Kits** include seals, gaskets, snap rings, washers and o-rings. James Kits include seals and o-rings only.

James VT No.	MM	Year	Models
14-0038 14-0939	41	1984-08	FXST-FLST
		1987-08	FLT-FLST
14-0042 14-0943	39	1988-94	FXR-FXLR
14-0044	—	1984-92	FX-FXR
14-0047	49	2006-up	FXD



**Fork Seal Sets** are molded with factory part number, sold in pairs.

VT No.	OEM	Years	Type	Size
14-0016	45387-83	1982-87	FXR-FXS-FXRT	35 mm
14-0023	45875-84	1984-up	FXST-FLST	41 mm
		1985-up	FXWG	
		1987-up	FLT	
		1984-86	FLT	
14-0049	45875-84A	1999-up	FLST-FXST	41 mm
14-0021	45378-87	1987-08	FXLR	
		1988-08	FXRSE	39 mm
14-0956	45401-87	1988-up	Dust Seal	39 mm



**Air Control O-Ring Kit** for FLT and FXR models. Kit includes o-rings and seals needed to repair a leaking air control system. Fits 1984-up FLT and 1984-94 FXRT models with air control front forks.  
VT No. 14-0045

## Fork Seal



**GB Deluxe Fork Seal Rebuilding Kits** include all pieces illustrated as appropriate for each application. Complete kits include fork tube bushings, seal and related retaining rings.

Complete	VT No.	Fits	Size
24-1068	14-0700	1984-10 FXST	41 mm
24-1068	14-0701	1986-14 FLST	41 mm
24-1028	14-0704	1988-05 Showa	39 mm
	14-0705	1984-87 Showa	35 mm
24-1083		2006-up FXD	49 mm

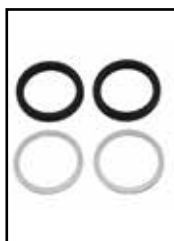

**Leak Proof Fork Seals** feature a Teflon coating to reduce drag and carry a manufacturer's lifetime guarantee. Sold in pairs.

VT No.	Size	Fits
14-0252	41mm	84-05 FL-FXST-FLT-FLST-FXWG
14-0024	39mm	1988-05 FXR
14-0254	49mm	2006-up FXST, FXD

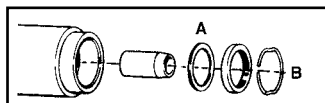

24-0620

**A-Slider Seal Washers** are zinc plated. Fit 1987-up FXST. Replaces 45865-84.

VT No. 24-0620

**B-Fork Seal Retaining Ring.**

VT No.	OEM	Year	Model
24-0614	45908-80	1980-87	FXS-FXSB-FXR, XL
24-0623	45905-87	1988-05	FXR-FXD, XLH

**Fork Seal Spacers.**

VT No	OEM	Fits
24-0626	45377-87	1987-up FXR
24-0627	45386-83	1986-87 XL

## Stem Nut Cover



**Chrome Stem Bolt** features dome shape stem bolt with chrome washer. Replaces 4453 bolt and cover on 1986-up FXST, FLST, FXR, FXD.  
VT No. 9978-2



**Chrome Fork Stem Nut Cover** to fit over stock stem nut and held in place by set screws. Cover is one piece.  
VT No. Fits  
24-0636 1971-87 35mm fork  
24-1336 1980-up 39mm fork



**Chrome Fork Stem Cap Cover** has stud to screw into 1980-up FXST-FXWG, 1986-up FXDWG Fork Stem.  
VT No. 24-0818



**39mm Chrome Fork Stem Nut Covers** fit over stock stem nut. 37-9073 includes two fork tube cap covers and one stem nut cover for 1987-up FXRS-SP, 1988-90 FXLR, 1988-90 FXR.

VT No.	Fits
24-0637	1987-up FXR, 48329-90
37-9073	Three Piece Set as shown
37-9520	Three Piece Set, Flattop Style



**Acorn Stud** for use on 1987-up FXR-FXST. Order nut separately.  
VT No. Item  
24-1209 Stud  
37-0443 Acorn Nut



# 41mm Fork Plug



**Glide Fork Plug Kit** includes fork tube plugs and matching top filler cap plugs, 1984-up FXST.

**VT No. Plug Style**

24-0625 Stock

24-0599 Tapered



**Chrome Inner Fork Tube Plugs** for 1984-up Big Twin glide model forks. Replaces 45838-77.

**VT No. U/M**

8716-1 Each

8716-1T Each

24-0187 Pair

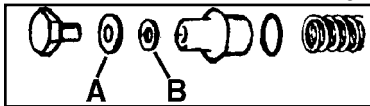

**Tube Cap Washer and Seal** for Showa and Kayaba fork legs, 10 pack.

T No.	OEM	# Fits	Finish
24-0616	45997-73 A	1973-up FX-XL-FXR	Zinc
24-0610	5710 A	1980-up FXWG fits Tube Plug	Zinc
9964-2	5710 A	1980-up FXWG fits Tube Plug	Chrome
24-0385	45835-00	2000-up Big Twin	Chrome
14-0132	45773-48 B	1948-up FLH-FXWG, Cap Seal	



**Domed Allen Caps** fit 1978-up Wide Glide 41mm forks.  
**VT No. 24-0981**



**Chrome Fork Tube Top Caps** are sold each unless noted as pair. Replaces 45419-80 for 1980-up FXST-FXWG, 41mm. Glide Fork

**VT No. U/M**

9912-2 Each

24-0186 Pair



**Chrome Fork Tube Plug** with 5710 washer. Fits FL, FXWG, Softail 1978-up.  
**VT No. 2311-2**

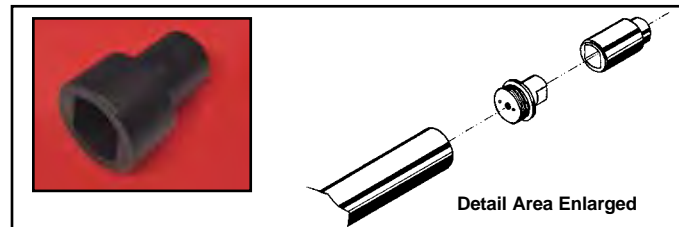

**Fork Tube Plug Tool.** Special socket fits 1948-up Glide Fork Plug, 1/2" drive.

**VT No. 16-0630**

## Fork Stop

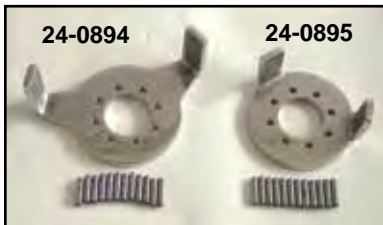

**Stainless Steel Fork Stops** mount to custom triple trees under lower bearing.

**VT No. Model Year**

24-0894 FXD 1991-up

24-0895 Big Twin 1948-99



**Fork Stop Pins.** Lower trees may be drilled and tapped to accept the stop pins.

**VT No. Type Note**

24-2053 Long 1 7/8" Long, not including threaded portion

24-1201 Tapered



**Fork Lock Pins** include two barrel keys.

**VT No. Year/Model**

24-1081 1990-99 FXST, 2001-2005 FXD

24-1082 1993-00 FXD, 2000 FXST



**Fork Stop Kit** is to adapt billet trees to FXD and Big Twin models.

**VT No. Type**

24-0749 FXD, 3" center to center

24-1208 Big Twin, 2 5/16" center to center



**Universal Fork Stop** mounts to triple tree.

**VT No. 24-0492**





24-0283  
Installed

# “Raked” Neck Kit



**Note:** Rake Neck Kits are for **Show Applications** only and **Require** longer Fork Tubes to be installed.



**Chrome “Raked” Fork Neck Cup Set** replaces existing removable cups to provide 3° rake when installed. Kit includes chrome cup set, bearing set and dust covers. Kits 24-0292 and 24-0294 include longer fork stem and adapter to fit neck, but will not accept stock fork stem lock. 24-0292 and 24-0294 feature built in external fork



24-0292



24-0294

stop tab.

VT No.	Year	Model
24-0283	1960-87	FXST-FXWG
24-0295	1960-87	FXST-FXWG
24-0292	1988-up	FXST, 1990-up FXDWG
24-0294	1991-05	FXD



24-0378

**Raked Neck Kits** include chrome cups, bearings, dust cover, stop tab and longer stem. Longer fork tubes required for installation. Fit 1991-05 FXD.

VT No.	Rake
24-0378	3°
24-1286	5°



24-0377



24-1268

**Chrome Raked Neck Cups Only** include bearings and races. A longer fork stem and longer fork tubes are required for installation on 1987-up Big Twin frames.

VT No.	Rake
24-0377	3°
24-1287	5°
24-1268	7°

## Neck Cups with Stops



**Chrome Big Twin Neck Cup Kit** features built in fork stop on lower cup to accept 1988-99 FXST lower fork stem with integral stop. Kit includes chrome upper and lower cups with races, bearings and dust shields.

VT No.	Item
24-0231	Cup Kit
12-0384	Bearings



**Chrome Mega-Neck Cup Set** features 1” inner diameter bearing set with large outer diameter on the outer race which will provide 1.68 times the radial capacity and 1.57 times the axial capacity of a conventional bearing. Kit includes chrome cups, bearings and races and two dust covers.

VT No. 24-0300



24-0296



24-0671

**Chrome Internal Fork Stop Kit** includes pieces for complete installation on Big Twins, and custom frames which accept press in neck cups. Kit allows choice of turning radius of 35 or 45 degrees.

VT No.	Year	Model	Degrees
24-0296	1936-87	Big Twin	35° and 45°
24-0671	1988-up	Softail-FXDWG	45°

\*Note: Does not include races, bearings, neck cups.



**Smooth Neck Cup Set** features built in stop and includes races and bearings.  
VT No. 24-0874



# Big Twin Neck Kit



**Chrome Smoothie Neck Cup Kit** includes races, 1" bearings and dust cover set for Big Twins.

VT No.	Item
24-0322	Kit
24-1156	Upper Dust Cover
24-0112	Lower Dust Cover



**Hex Neck Cup Kit** includes 1" neck bearing set.  
VT No. 24-0305

**Big Twin Neck Cup Assembly** available as a complete kit which includes chrome neck cups with races installed and a chrome top nut.

VT No.	Item
24-0122	Complete Kit
24-0253	Cup Kit
24-0119	Cup Set, chrome
24-0121	Cup Set, zinc
24-1282	Bearing Kit



**Fork Stem Bearings and Races.** Order separately as noted. Sold as each.

VT No.	Type	Fits
12-0335	Timken Bearing	1960-up Big Twin
12-0384	Peer Bearing	1960-up Big Twin
12-0348	Timken Race	1960-up Big Twin
12-0383	Peer Race	1960-up Big Twin



**Fork Bearing Kit** includes two tapered bearings and two seals. Fits 1949-up FL and 1970-up FX  
VT No. 24-0089



**Dust Shield Sets** include upper and lower for 1982-up.

VT No.	Finish
24-0117	Zinc
24-0114	Chrome



**Bearing Seal Set** fits 1982-up XL models.  
VT No. 14-0174

## Stem Nuts



**Chrome Glide Acorn Nut** is 1" x 24" available with shoulder for alignment in top tee. Fits 1948-up FL-FLH.

**Shoulder Without Shoulder**

37-0442	37-0443
7802-1	7009-1T
24-1460	Kit



**Triple Tree Top Bearing Adjusting Nut** for Big Twins.

VT No.	Years	Model	Finish
24-0278	1980-99	Softail	Zinc
24-0667	2000-up	FXSTD	
24-0279	1980-up	FLT	Zinc
24-0926	2006-up	FXD	



**Top Stem Nut and Cover Kit** fits 1986-up FXST-FLST, 1988-up FXR, FXD. Includes chrome cover bolt and washer.

VT No.	Item	Fits
37-0505	Kit	FXST-FXDWG
9976-2	Bolt and Washer Set	FLST-FXD-FXR
9977-1	Chrome Cover	FLST-FXD-FXR



**Stem Nut and Lockwasher Kit** fits 1980-up FXWG-FXST. Includes lock washer.

VT No.	Finish	Item
8808-2	Black	Kit
8808-2T	Black	Kit
37-8138	Chrome	Kit
24-0197	Zinc	Kit
37-0597	Chrome	Nut
24-0185	Zinc	Nut
17-0924	Zinc	Lock tab, 10 pack
17-0954	Chrome	Lock tab, 10 pack



**Cone Nut Spanner** is used for removing and installing crenulated nuts and dust covers with internal thread. Fits 1948-59 FL.  
VT No. 16-1344





**Custom Kickstand Assembly** features full forged construction with chrome smooth contour design, including recessed mount screws for 1936-99 Big Twin, 4-Speed, 1984-up Softail models. Stock length.  
**VT No. 27-0253**



**Wyatt Gatling Big Twin Kickstand Assembly** features adjustable leg and hidden spring. Mounting is by 3 bolts on left front frame boss. Fits 1984-99 FXST. **VT No. 27-0670**

## Weld On Stands



**Weld On Kickstand Assemblies** feature chrome stand with hidden spring. Units fit tube size as noted.

VT No.	Size
27-0133	1 1/8"
27-0134	1 1/4"
27-1785	1 3/8"
27-0135	1 1/2"
27-0136	2"
27-0140	Stand Only
27-0683	Spring Kit

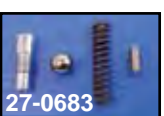

**Weld On Kickstand Assembly** includes weld on type heavy duty mount, chrome spring and chrome kick stand with forged flat end.  
**VT No. 27-0257**

## Custom Kickstand



**1980-99 WG-FXST Kickstand Assembly** features chrome steel construction with hidden spring mechanism.  
**VT No. 27-0254**

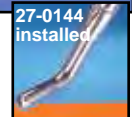
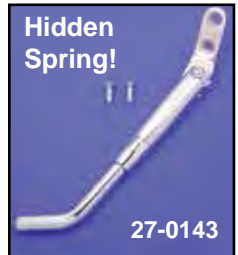

**Chrome Adjustable Hidden Spring Kickstands** mount to years listed with twos bolts.

VT No.	Years	Model
27-0143	1988-99	Softail
27-0144	2000-up	Softail
27-0145	1982-94	FXR



**Chrome Custom Kickstand Kit** fits 2-bolt mounting. Unit includes stand, spring, mount and tapered bolts. 27-0552 features hidden spring.

VT No.	Years	Models
27-0515	1986-99	Softail
27-0557	1986-99	Softail
27-0552	1986-99	Softail

## FXR

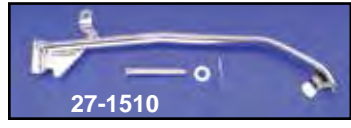

**Chrome Kickstands and Components** for FXR-FXR-S-FXLR

VT No.	Year	Item
27-1510	1982-90	Kickstand
37-9118	1982-90	Kickstand Pin
27-1718	1991-94	Kickstand
37-0575	1991-94	Kickstand Pin
13-0154	1982-90	Kickstand Spring, Chrome
13-9162	1991-94	Kickstand Spring, Chrome





# Big Twin Kickstand

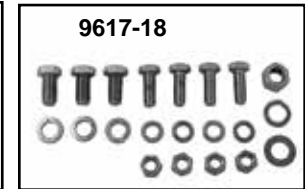
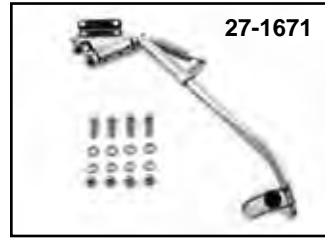

**Forged Big Twin Kickstand** for FXST is made of heat treated steel and chrome featuring flattened base as original.

VT No.	Type	Year
27-0523	Stock	1986-06
27-0538	1" Lower	1986-06
27-0707	2" Lower	1989-06
27-0074	Stock Kit	2007-up, Chrome
27-0024	Bushing	2007-up
27-0376	Stock	2007-up, Black
27-0377	Stock	2007-up, Chrome
27-0794	Stock	2007-up, Chrome
27-0835	1" Lower	2007-up
27-0024	Bushing	2007-up



**Kickstand Assembly** chrome as shown for 1936-85 Big Twin-FL-FX-FXWG and for 1984-99 FXST.

VT No.	Years/Type
27-1620	1984-99 FXST Stock
27-1671	1984-99 FXST 1" Under
27-0743	1984-99 FXST 2" Under
27-1723	1986-99 FLST Stock
9617-18	1936-99 Chrome Mount Kit

**Chrome Contour Kickstand Legs** include lock tab. Fits 1989-99 FXST models.  
**VT No. 27-0255**



**Chrome Stock Length Kickstand** features a ball tipped built in extension arm that makes the stand easier to use. Fits all 1989-06 FXST models.

**VT No. 27-3562**

## For FXD

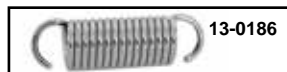

**1990-up Chrome Kickstand** to fit FXD, FXDWG and FXDL.

VT No.	Item	Type	Year
27-0535	Stand	Stock	1990-2005
27-0378	Kit	Stock	1990-2005
27-0593	Stand	1" Under	1991-2005
27-1818	Stand	1" Under	2006-2016
27-0008	Stand	Stock	2006-2016
27-1819	Stand	Stock Black	2006-2016
27-0404	Kit	Stock	2006-2016
13-0176	Spring		1991-01
13-0186	Spring		2002-up
28-0435	Bumper Stop		1991-2000
28-0438	Bumper		2001-up
27-0836	Kit		1991-1997
27-0839	Kit		1998-up
27-2102	Extension		1993-up



**Big Twin Complete Chrome Kickstand Mounting Kit** includes kickstand mount, spring, leg stop and spring plate.  
**VT No. Year Model**  
**27-0550** 84-99 FXST  
**27-0551** 86-99 FLST



**Chrome Smooth Kickstand Bracket** for 1980-99 FXST is one-piece forged design with recessed mount hardware.  
**VT No. 27-0250**



**Jiffy Stand and Shift Mounting Plate Bolt Kit** to attach assembly to left side of frame for 1936-99.  
**VT No. Type Finish**  
**7803-11** Acorn Chrome  
**9617-18** Hex Chrome  
**9619-18** Hex Parkerized

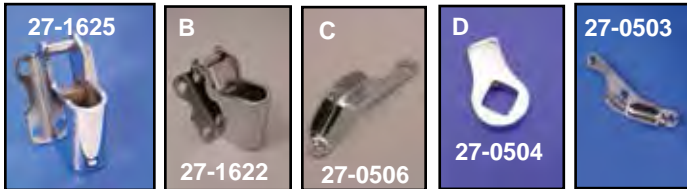

**Chrome Big Twin Kickstand Hardware.**

VT No.	Year	Model
<b>Mount Brackets</b>		
27-1622	1986-99	FLST (B)
27-1625	1986-99	FXST (B)
<b>Spring Plates (C)</b>		
27-0506	1984-90	FXST
27-0503	1991-06	FXST, FLST
<b>Leg Stop (D)</b>		
27-0504	1984-06	FXST



**Kickstand Lowering Wedge** fits under the mount bracket to change the angle of the bracket and assembly when using shock or fork lowering kits. **VT No. 31-0215**



**Kickstand Bumper Stops.**

VT No.	Fits	U/M
28-0704	1970-84 FL, FX	10 pk
28-0617	1993-up Big Twin, fits in VT No. 27-0523	10 pk
28-0448	2007-13 FLST	Each
28-0449	2007-13 FLT	Each
27-1786	2007-up FXST	Kit



**Kickstand Extensions**

**27-0090** Extension Kit, 2000-06 FXST, FLST  
**27-0092** Extension Kit, 1999-up FXD  
**27-0301** Extension, Black, 1993-up FXD

# Big Twin Kickstand Hardware

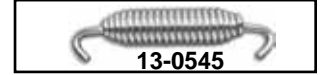
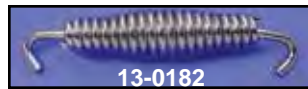

**Chrome Kickstand Springs.**

Chrome	Black	OEM	Model
13-9162	—	50005-85A	1986-06 FXST 1991-up FXR
13-0588	—	5 pack	1986-06 FXST
13-0185	—	Heavy	1986-06 FXST
13-0176	—	50057-91	1991-01 FXD
13-0182	13-0351	50112-99	1999-06 FLT
13-0545	13-0350	49725-07	2007-up FLT, FLST



**Kickstand Tab Kit** includes chrome tab, spring, washer and acorn nut. Fits 1989-2006 FXST and FLST.  
**VT No. 27-0545**



**Chrome Adjustable Kickstand Locktab Kit** includes chrome lock tab, flat washer, acorn nut and spring. Prevents stand from hitting primary cover.

VT No.	Item
27-0514	Tab
27-0779	Kit, 1986-2006 FXST, FLST



**Kickstand Extensions** allow rider to more readily access side stand.

VT No.	Model
27-1644	1986-06 FXST, FLST
27-0536	1986-06 FXST, FLST
27-1786	2007-up FXST
27-0521	1991-up FXD



# Detachables

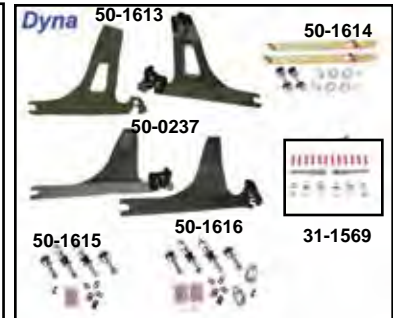

## Sissy Bar Tops for both Rigid and Detachable Side Plates

11" Sissy Bar Min Low 50-1121	Shorty Hand Rail 50-1122	16" Sissy Bar 50-0811	Fitment
-------------------------------------	--------------------------------	-----------------------------	---------

50-0815	50-0819	50-0811	2006-up FXST, FXSTB, FXSTS, FLSTFSE2, 07-later FXSTC, FLSTF, FLSTFB, FXSTSSE/2, FLSTSE/2/3 and FLSTSB. 2007-later FXSTC, require separate purchase of Fender Mounted Seat. 2004-up XL models with detachable side plates, 2006- later Dyna (except FXDF, FXDFSE/2, & 2010 FXDWG, 1984 -05 Softail models (except FXSTD) & 2006 later FL Softail models (except '06 FLSTFSE2, 2007-up FLSTF, FLSTFB, FLSTSE & FLSTSB) 1982-2003 XL Models, 1991-01 FXD models, 1982 -94 FXR models. 2006-later FXST, FXSTB, FXSTS, FLSTFSE2, 2007-later FXSTC, FLSTF, FLSTFB, FXSTSSE/2, FLSTSE/2/3 and FLSTSB models with appropriate sideplates. 2007-later FXSTC models require separate purchase of fender mounted seat. 2002-05 FXD models equipped with either rigid or detachable side plates. Also fits 2004-later XL models with rigid sideplates.
---------	---------	---------	---

50-0816		50-0812	1982-2003 XL Models, 1991-01 FXD models, 1982 -94 FXR models. 2006-later FXST, FXSTB, FXSTS, FLSTFSE2, 2007-later FXSTC, FLSTF, FLSTFB, FXSTSSE/2, FLSTSE/2/3 and FLSTSB models with appropriate sideplates. 2007-later FXSTC models require separate purchase of fender mounted seat.
50-0818			

50-0842	50-0843	50-0841	2002-05 FXD models equipped with either rigid or detachable side plates. Also fits 2004-later XL models with rigid sideplates.
---------	---------	---------	---

## Rigid Mount Side Straps

50-0844			<b>Fitment</b> 2006-later FXST, FXSTB, FXSTS, FLSTFSE2, 2007-later FXSTC, FLSTF, FLSTFB, FXSTSSE/2, FLSTSE/2/3 and FLSTSB models with appropriate sideplates. '07-later FXSTC models require separate purchase of fender mounted seat. 1997-99 FLSTs, 1984-99 FXSTC, FXSTS and 1998-99 FXSTB models. 1986-99 FLSTC, FLSTF, FLSTN models (except FLSTS). 1991-95 FXD Models. 1982-94 FXR 1996-05 FXD, and FXDL models (standard on 96-00 FXDS-CONV). Also fits 1999 and 2002-05 FXDX and 2001-05 FXDXT models. 2008-13 FXDF and FXDFSE/2, 2006-08 FXDWG models. 2009-up FXDWG 2006-up FXD models (except FLD, FXDWG, FXDF and FXDFSE/2). 1997-2008 FLHR, FLTR AND FLHX 2009-13 FLHR, FLTR,FLHX
---------	--	--	--

50-0857			<b>Fitment</b> 1995-2005 FXD 2010-up FXDWG 2006-up FXD 2006-up FXD, FXDC, FXDL, FXDSE2, 2006-2008 FXDB 1993-2001FXD with Luggage Rack 1993-2001 FXDWG 2001 FXDWG 2, FXDWG3, 2002-2005 1984-1999 Softail (except FLSTS) 1984-1999 FLSTC, FXSTB, FXSTS, FXSTC,FLSTF. 1993-1999 FLSTN (and Bad Boy) 1984-199 FXSTB, FXSTS, FXSTC,FLSTF, 1987-1999 FXST, FXSTS 1984-1999 FXST, FXSTC, FXSTS, FLSTF, FXSTSB 2000-2001 FXST, FXSTB, FXSTS, FLSTF, 2002 FXST, FXSTB, FXSTS, FLSTF, 2003-up FXST, FXSTB, FXSTS, FXSTSSE/2/3, FXSTC, FLSTF, FLSTFB, FLSTFSE2, FLSTSB, 2005-up FLSTN, FLST 2002 FXST, FXSTB, FXSTS, FLSTF 2003-up FXST, FXSTB, FXSTS, FXSTSSE/2/3, FXSTC, FLSTF, FLSTFB, FLSTFSE2, FLSTSB 2005-up FLSTN, FLST 2005-2007 FLSTSC 2000-2002 FLSTC, 2002-2003 FLSTS, 2005-2007 FLSTSC, FLST with Heritage Saddlebags 2003-up FLSTC, 2003 FLSTS, 2005-2007 FLSTSC, FLST with Heritage Saddlebags 2000-2001 FLSTS 2003 FLSTS, 2005-2007 FLSTSC, FLST with Heritage Saddlebags
---------	--	--	---

Detachable side plates	Docking Hardware Kit	Turn Signal Relocation Kit	Fitment
50-0271	—	—	<b>Fitment</b> 1995-2005 FXD 2010-up FXDWG 2006-up FXD 2006-up FXD, FXDC, FXDL, FXDSE2, 2006-2008 FXDB 1993-2001FXD with Luggage Rack 1993-2001 FXDWG 2001 FXDWG 2, FXDWG3, 2002-2005 1984-1999 Softail (except FLSTS) 1984-1999 FLSTC, FXSTB, FXSTS, FXSTC,FLSTF. 1993-1999 FLSTN (and Bad Boy) 1984-199 FXSTB, FXSTS, FXSTC,FLSTF, 1987-1999 FXST, FXSTS 1984-1999 FXST, FXSTC, FXSTS, FLSTF, FXSTSB 2000-2001 FXST, FXSTB, FXSTS, FLSTF, 2002 FXST, FXSTB, FXSTS, FLSTF, 2003-up FXST, FXSTB, FXSTS, FXSTSSE/2/3, FXSTC, FLSTF, FLSTFB, FLSTFSE2, FLSTSB, 2005-up FLSTN, FLST 2002 FXST, FXSTB, FXSTS, FLSTF 2003-up FXST, FXSTB, FXSTS, FXSTSSE/2/3, FXSTC, FLSTF, FLSTFB, FLSTFSE2, FLSTSB 2005-up FLSTN, FLST 2005-2007 FLSTSC 2000-2002 FLSTC, 2002-2003 FLSTS, 2005-2007 FLSTSC, FLST with Heritage Saddlebags 2003-up FLSTC, 2003 FLSTS, 2005-2007 FLSTSC, FLST with Heritage Saddlebags 2000-2001 FLSTS 2003 FLSTS, 2005-2007 FLSTSC, FLST with Heritage Saddlebags
—	31-1352	—	
50-1613	—	31-1569	
—	50-1614	31-1569	
50-0237	—	—	
—	50-1615	—	
—	50-1616	—	
50-1617	50-1618	—	
—	50-1619	—	
—	50-1620	—	
50-1608	50-1610	31-1570	
—	—	31-1565	
—	—	31-1566	
—	50-1611	31-1567	
—	50-1611	—	
50-1609	31-1568	31-1569	
—	50-1612	—	
—	—	31-1565	
—	—	31-1567	

# Luggage Rack



**Chrome Sissy Bar Luggage Rack** of solid steel fits all 16" tall sissy bars and has a unique design for easy installation or removal. Mount holes are 2 5/8" center to center. May require drilling for some applications.  
**VT No. 50-1011**

**Bolt On Luggage Racks** mount to side straps of sissy bar as noted, A= Rigid Side Plate B= Detachable Side Plate. Rack area measures 8.5" x 7.75".

VT No.	Model	Type
50-0588	2006-up FXD 2000-up FXST	A and B
50-0589	2002-05 FXD	A





# Sissy Bar



**Sissy Bar Side Strap and Backs. Order top and straps separately. \*Note: 20"**

Fitment	Side Straps	16" Back	11" Back	Sissy Bar	Round	Width
2006-up FXST, FXSTB, FXSTS, FLSTFSE	50-0844	50-1122	50-1121	—	50-0322	11 1/16"
1984-99 FXST, 1988-99 FXSTS	50-0800	50-0811	50-0815	50-0819	—	8 3/4"
1980-86 FXWG, 1997-99 FLSTS	—	50-0322	—	—	—	8 3/4"
1984-99 FXST Round Style	—	50-0322	—	—	—	8 3/4"
2000-02 FXST-FXSTS-FLSTF-FXSTB*	50-0844	50-0811	50-0815	50-0819	—	8 3/4"
2003-05 FXST-FXSTS-FLSTF-FXSTB	50-0844	50-0811	50-0815	50-0819	—	8 3/4"
2000-up FLSTS-FLSTC, 8 3/4"	—	50-0811	50-0815	50-0819	—	8 3/4"
2005-up FLSTSC, FLSTN	—	—	—	—	—	—
1986-99 FLST	50-0801	50-0811	50-0815	50-0819	—	8 3/4"
1991-95 Dyna FXD	50-0802	50-0812	50-0816	—	50-0893	6 3/4"
1996-01 Dyna, FXD	50-0826	50-0812	50-0816	—	—	6 3/4"
2006-08 Dyna WG	50-0857	50-0814	50-0818	—	—	7 3/8"
2009-up Dyna WG	50-0867	50-0811	50-0815	—	—	8 3/4"
2002-05 Dyna FXD	50-0826	50-0841	50-0842	50-0843	50-1192	7 1/2"
2006-up Dyna FXD	50-0858	50-0814	50-0818	—	—	7 3/8"
1982-94 FXR	50-0806	50-0812	50-0816	—	50-0893	6 3/4"
1986-99 FLST	50-0801	50-0642*	50-0815	—	50-0322	8 3/4"



**Button Sissy Bar Pads**  
mount to square stock sissy bars, Mini fits 12" bar, 2 button fits 16" bar. Chrome mount clamps included, black only.



**Mini Back Rest**  
in black features a stainless steel insert with chrome frame mounting system for short sissy bars.  
VT No. 47-0753

- VT No. Type
- 47-1963 Mini
  - 47-1964 2-Button
  - 47-1972 Smooth
  - 47-0457 Buttoned
  - 47-0478 Buttoned
  - 31-1987 Brackets for Above



**Sissy Bar Inserts** mount with screws to cross bar.

VT No. Type

- 50-0820 Chrome Maltese
- 42-0045 Brass Live to Ride, Skull
- 42-0156 Brass Live to Ride, Eagle



**Fender Mount Sissy Bar Kit** includes mount bracket and 8 1/2" grab rail, measured from top of fender, with chrome finish.  
VT No. 50-0503



# FXST-FLST Belt Guard

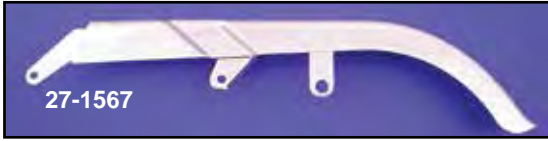

27-1567



27-0242



27-1571



20-0241



20-0249



27-0480

### Chrome Rear Belt Guards for FXST-FLST.

VT No.	OEM	Fits	Teeth
27-1567	60533-86	1986-99	70
27-0242	60571-98	1990-99	65 Wide Tire
27-1571	60537-89	1990-99	65
20-0241	60533-00	2000-05	70
20-0249	60576-06	2006-up	70
27-0480	60550-08	2008-up	FXWC



Chain Guard fits 1984-85 FXST models with rear chain.  
VT No. 27-1575



27-1706



27-0122

Short Chrome Belt Guard fits 1986-99 FXST-FLST models.

VT No. 27-1706

FXST Nerf Guard 1986-99.

VT No. 27-0122

## ST Full Belt Guard



VT No. 27-1588 Shown Installed

Full Chrome Rear Belt Guard fits 1985-99 FXST-FLST.

VT No. 27-1588

288



Chrome Belt Guard Kits include pulley cover with upper and lower belt guard for Softail models.

VT No.	Fits	Teeth
27-0157	1986-99	70
27-0158	1990-99	65
27-0159	2000-06 FLST Only	70
27-0161	2006 FXST Only	70
27-0160	2007-up FXST and FLST	66

### FXST-FLST Upper and Lower Belt Guard Mount Kit.

VT No.	Item
27-0519	Kit 1986-99
27-0544	Kit 2000-up
28-0154	Rubber Grommet
12-0549	"Tee" Nut
37-0546	Acorn

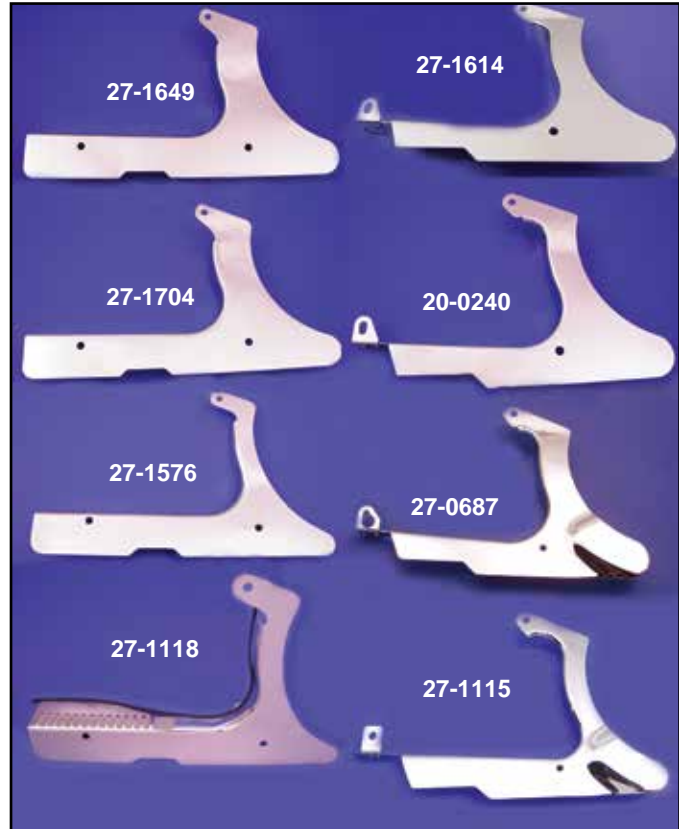

Chrome Lower Belt Guards for belt drive 1986-up FLST-FXST models. Note: Pulley tooth size.

VT No.	OEM	Year	Teeth	Belt
27-1649	60394-90	1990-99	61	1.5"
27-1704	60389-97A	1989-99	65	1.5"
27-1576	60366-89A	1986-99	70	1.5"
27-1614	Louvered	1986-99	70	1.5"
20-0240	60316-00	2000-05	70	1.5"
27-0687	60317-06	2006	70	1"
27-1115	60655-07	2007-up	66	20mm
27-1118	60654-07	2007-up	70	1"





# Softail Custom Belt Guard

BIG TWIN



27-0185 Installed



27-1116 Installed



27-1119



27-1120

**Shorty Chrome Upper Belt Guard** for Softail models. Includes mounting hardware.

VT No.	Year	Belt	Model
27-0185	1986-06	1.25", 1.5"	FX-FLST
27-1116	2007-up	20 mm	FXST-FLST
27-1119	2007-up	1"	FLST
27-1120	2008-up	20 mm	FXST

# Belt Guard FXR-FXB-FXD



27-0859

27-1568

27-1565

27-0534

**Chrome Rear Belt Guards** for models listed.

VT No.	Fits
27-1568	1987-94 FXR-FXRS-FXLR
27-1565	1985-86 FXR-FXRS-FXSB
27-0527	1992-99 FXD-FXDL-FXDWG
27-0534	2000-05 All FXD models
27-0859	2007-up All FXD models
31-0946	2006-up FXD Bracket

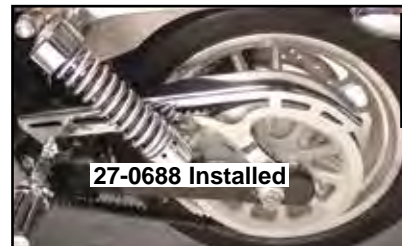

27-0688 Installed



**2006-up Shorty Upper Belt Guard** for FXD-FXDWG models.  
VT No. 27-0688



27-1650



27-1651



27-0686

**Chrome Lower Belt Guard Covers** for belt drive FXR-FXD-FLT models. **Note:** Pulley Tooth size.

VT No.	Teeth	Model
27-1650	70/65	1991-05 FXD
27-1651	61	1991-05 FXD
27-0686	70	2007-up FXD



27-0679

**Chrome Dress Up Kits** fit FXD models. Kits include upper and lower belt guard with a chrome pulley cover.

VT No.	Teeth	Year
27-0679	70	1991-99
27-0680	61	1991-99
27-0681	70	2000-05
27-0790	70	2007-up



27-1541

**Chrome Lower Belt Guard.**  
**Fits** 1985-92 FXR with 70 tooth pulley. **\*Note:** Designed to match 27-1568 upper belt guard.  
VT No. 27-1541\*





# Front Fender

50-6062



**Raw Steel Fender** fit 41mm FXST models, 4" wide for 21" wheels.  
VT No. 50-6062

50-0125  
Installed  
and  
Painted

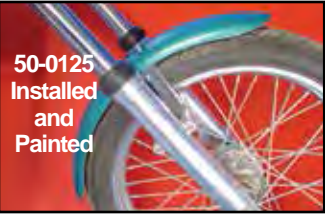

50-0125



**All Fenders are Steel!**

50-0126



50-0114



50-0114



**Glide Type Fenders** are plain unfinished where noted. Fenders include chrome or raw braces riveted on. Fit 19" and 21" tires only.

**1980-up Wide Glide and Softail**

VT No.	Fender	Bracket
50-0125	Plain	Chrome
50-0126	Chrome	Chrome
50-0114	Spring Type Raw	Chrome

**Chrome Fender Mounts** are .750 thick to mount custom fenders to Wide Glide forks.

VT No. 50-0579



50-0133



50-0195

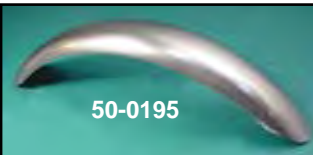

50-0196



50-0281



**Universal Sport Style Front Fender** is rolled on edge and in front. The brackets are not included.

VT No.	Type
50-0133	Chrome (drilled)
50-0195	Plain
50-0196	Chrome
50-0281	Rib



50-0266



50-0265

**Steel Front Fender** fits 2006-up FXDWG-FXD with 49 mm forks.

VT No. Model  
50-0266 FXD  
50-0265 FXWG



50-0199



50-0200



50-0201

**2000-up FXSTD Steel Front Fender** replaces 59876-00.

VT No. Type  
50-0199 Black Steel with chrome bracket  
50-0200 Chrome  
50-0201 OE, Primer



50-0764



50-0878

Smooth Sides



50-0172



50-0876



50-0882

**Fat Kid Steel Front Fenders** fit 16" wheels on Glide Forks.

VT No. Fits  
50-0764 1986-99 FLSTF, 1980-99 FXWG-FXST  
50-0878 1986-99 FLSTF, 1980-99 FXWG-FXST, Smooth  
50-0172 1980-99 FXWG-FXST  
50-0876 2000-up FLSTF  
50-0882 2008-up FXDF

**Note: All Items Shipped with a Raw Finish may have some oxidation (rust on surface)!**

# Glide and Springer Front Fender

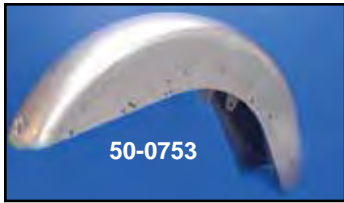

50-0753



50-1075



50-0358



50-1074



50-0473

Glide Front Fork Fenders for FLST, FLSTN. Replica except where noted\*.

VT No.	Fits
50-0753	1986-up FLST, 1986-99 FLSTN
50-1075	Without trim holes
50-0358	2003-up FLSTC
50-1074	1980-up FXST-FXWG
50-0473	1986-up FLST Slim Only

ALL FENDERS ARE SHIPPED BARE METAL AND ARE FACTORY RIVETED TOGETHER EXCEPT WHERE NOTED.



50-0794

Spring Fork Style Front Fender fits 18", 19" and 21" wheels. Brackets must be fabricated.

VT No.	Style
50-0780	Stock Width
50-0794	Narrow Width

**Note: All Items Shipped with a Raw Finish may have some oxidation (rust on surface)!**



50-0176  
50-0268



50-1568



50-0570



50-2011



50-0794

Fenders for FXSTS models for use with 21" wheels. Fenders are raw with raw brackets unless noted.

1989-92	1993-up
50-0268	50-0570
50-1568*	50-2011*
50-0176*	50-2012
50-0794	*Note: Chrome brackets
50-1204**	**Note: Chrome Fender w/ chrome brackets



50-0910



50-0909

Fender Bracket Sets mount stock or universal fenders to Wide Glide or FX type forks, pair, chrome.

VT No.	Model
50-0910	1948-84 FLH
50-0909	1980-up FXST-FXWG, 1973-up FX-FXR



50-0868

Front Fender and Bracket for 2008-up FLST SB. Sold separately.

VT No.	Item
50-0868	Fender
50-0864	Bracket



50-0769



50-0883

Plain Front Fender is 6" wide, to use with 16" wheels less brackets.

VT No.	Type
50-0769	Flat
50-0883	Round



Front Fender Mount Kit attaches fender to original style assembly.

VT No.	Year	Model	Finish
50-1087	1986-up	FLST	Chrome
50-1085	1984-93	FXST	Chrome
50-1088	1994-up	FXST	Chrome with acorn nuts
37-0895	1980-up	FXST	Zinc
37-1011	1988-92	FLT	Zinc
50-0688	1993-up	FXSTS	

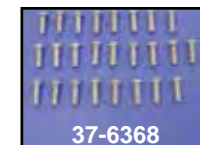

37-6368

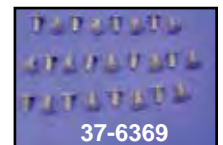

37-6369

Replacement Fender Rivets fit all FL front and rear fenders, 25 pack.

VT No.	Fits
37-6368	Fender Brace
37-6369	Fender Top



Stock Skirted Front Fender to fit 1997-up FLSTS models. Replaces 59164-97.

VT No.	Item
50-1213	VT
50-0680	Bushings



# Front Fender fits 35 & 39 mm Fork



**Narrow Type Front Fenders** for 35 or 39mm forks feature a raw or chrome steel fender with brackets riveted on to fit 19" wheels. 50-0122 fits 19" wheels on 1973-90 XLX models, 50-0164 fits 1973-up models with 21" wheel and 1991-up with 19" or 21" wheel.

VT No.	Finish	Brackets	VT No.	Finish	Brackets
50-0122	Plain	Chrome	50-0165	Raw	Raw
50-0136	Plain	Raw	50-0191	Chrome	Chrome
50-0123	Chrome	Chrome	50-0889	Raw	Raw
50-0164	Raw	Chrome	50-1140	Raw	Rear



**LTD Style Fender** is designed with slotted mounting holes enabling it to fit most narrow forks. Features a raw finish with chrome brackets  
**VT No. 50-0130**



**Springer Style Fender** fits 1973-up 35 and 39 mm models. with 19" or 21" wheels.  
**VT No. 50-0116**



**Chrome Stock Type Front Fender Braces** are tubular style. Use on all stock front fenders 1973-up.

VT No.	Item
50-0932	Bracket
37-6370	Stainless Rivets, 25 pk



**Fender Rivets** fit 1973-up FX-XL models, stainless, 25 pack.  
**VT No. 37-6370**

## All Fenders are Steel!



**Front Fender** stock type for 1970-up FX-FXR, in raw steel, has chrome tubular type brackets riveted in place.

VT No.	Years
50-0789	1984-91
2531-12	Mount Bolts
37-6370	Stainless Steel rivets, 25 pieces



50-1055



50-1050



50-1049

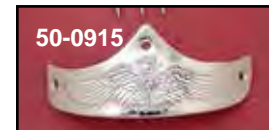

50-0915

**Chrome Fender Tips** in stamped, includes screws. Fits fender width as noted.

VT No.	Style	Width	Type
50-1055	Eagle	4"	XLS
50-1050	Smooth	4"	As Above
50-1049	Smooth	5"	FX
50-0915	Eagle	5"	FX



28-0701



28-0702

**Plain Rubber Mud Flaps.** Stock type for front and rear fenders for Big Twin.

VT No.	Color
28-0701	Black
28-0702	White



**Stainless Steel Fender Medallion** with skull.

**VT No. 50-1137**



**Chrome Front Fender Allen Head**

**Screw Kit** contains all the necessary screws for mounting front fender brackets to fender replacing the bracket to fork legs. Use on all 1973-up FX stock type front fenders.

**VT No. 37-6367**

**Note: All Items Shipped with a Raw Finish may have some oxidation (rust on surface)!**



**FXDWG**



50-0547



50-0587



50-0585

**Bobbed Rear Fender** for FXDWG models.

VT No.	Year
50-0547	1996-01
50-0587	2002-05
50-0585	2006-09

**Bobbed Rear Fender for FXST**



**FXST Style Rear Fender Kit** includes steel fender, chrome struts, chrome license plate bracket and tail lamp with hardware. Fits 1984-99.  
**VT No. 50-0564**

**All Fenders are Steel!**

**FXR**



31-0160



31-4012



33-2018

**Tail Lamp Bracket Kit**

VT No.	Item
31-0160	Stock Tail Lamp Bracket
31-4012	Cateye Tail Lamp Bracket
33-2018	Slice Tail Lamp Bracket Kit



**FXR Stock Type Rear Fender** fits 1981-94 FXR-FXRS models.

**VT No. 50-0768**



50-0783



50-0746



50-0516



50-0205



50-0849



50-0859

**Rear Fender** fits stock struts, does not have reflector indents.

VT No.	Item	Year	Finish
50-0783	Fender	1984-99	FXST
50-0746	Fender	1986-99	FXST
50-0516	Fender	1997-99	FXST
50-0205	Fender	2000-05	FXSTC
50-0849	Fender	2006-up	FXST
50-0859	Fender	2006-up	FXST



**9" Wide Steel Rear Fender Bobbed Style** fits FXST struts when used on 1986-99 wide style frames for 200 series tire. Sold without holes.  
**VT No. 50-0112**



50-0517



50-0518

**Rear Fender Extension for FXST-FLST** to replace stock plastic extension. Flat panel design for 2000-07.  
**VT No. Finish**  
**50-0517** Stainless  
**50-0518** Chrome



50-0515



50-0737

**Rear Fender Extension** replaces stock plastic extension. Fits 1986-99 FXST-FLST.

VT No.	Finish	Type
50-0515	Chrome	Curved
50-0737	Stainless	Flat Panel

**Note: All Items Shipped with a Raw Finish may have some oxidation (rust on surface)!**



# FLST Rear Fender

# All Fenders are Steel!



**FLST Replacement Rear Fenders.** Can also be used on all 1986-up Softtail models uses 33-0301 tail lamp and includes indent for turn signal bar. 50-0767 does not have tail lamp cut or indents for signal, for use with custom tail lamp.

VT No.	Year	Type
50-0767	1986-99	Smooth
50-1021	1986-99	Replica
50-0586	2006-up	Replica

**FLSTF Style Replacement** fits FLST-FXST models. Accepts 33-0301 tail lamp. One piece design.

VT No.	Years	Type
50-0782	1986-95	Replica
50-0593	2007-up	Replica
50-0594	2007-up	Plain



**Note: All Items Shipped with a Raw Finish may have some oxidation (rust on surface)!**

**FXST-FLST Rear Fender Extension** to replace stock plastic extension.

VT No.	Years	Finish	Type
50-0515	1986-99	Chrome	Curved
50-0737	1986-99	Stainless	Flat Panel
50-0517	2000-up	Stainless	Flat Panel
50-0518	2000-up	Chrome	Flat Panel

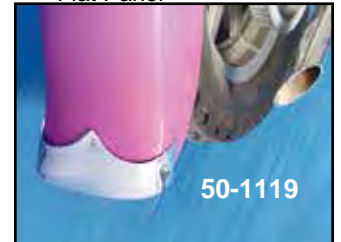

**Chrome Smooth Fender Tips** fit FLSTF models.

VT No.	Type	Size
50-1118	Front	6½"
50-1119	Rear	7"



# Strut for FLST models



50-1070



50-1069



50-1071



50-2042



50-2040

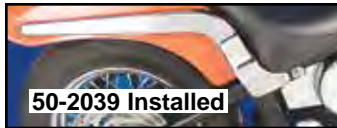

50-2039 Installed

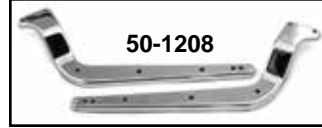

50-1208

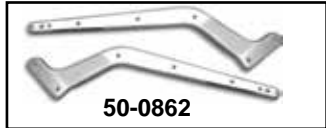

50-0862



50-0649

### FXST Models

50-1070	Replica	1986-99
—	Smooth	
50-2040	Replica	2000-05
50-1208	Replica	2003-05
50-2039	Smooth	2000-05
50-0649	Replica	2006-07
50-0651	Smooth	2006-07
50-0862	Replica	2008-up
50-0861	Inner Strut	2008-up



50-0865



50-0863



50-0861

### FLSTF

50-1071	Replica	1986-99
50-2042	Replica	2000-02
50-1208	Replica	2003-07
50-0862	Replica	2008-up
50-0863	Smooth	2008-up
50-0861	Inner Strut	2008-up



Rear Fender Strut Cover Trim fits 2006-up FXST, 2007-up FXSTC. VT No. 50-0110

# FXD-FXR



50-1071



50-1211



50-1064



50-1106



50-1212



50-0649



50-1115



50-1123



50-0852



50-0865

### Chrome Fender Strut Sets with signal and mount holes.

VT No.	Fits	Type
50-1064	1982-86 FXR	Strut
	1983-91 FXRT-FXRP	Strut
50-1106	1987-94 FXR except FXRT-FXRP	Strut
50-1115	1997-06 FXDWG	Cover
50-1123	2006-up FXD	Cover

### FLST Models

50-1071	Replica	1986-99
50-1211	Replica	2000-02
50-1212	Replica	2003-up
50-0649	Replica	2007
50-0652	Replica	2008-up
50-0865	Inner Strut	2008-up
31-0652	Rear Fender Nut Inserts, 4 pack	



50-0865

61-0228 Chrome Struts, 1986-99 Three Holes



61-0228

# Strut Bolt Set



9920-46

Chrome Allen Fender Strut Bolt Kits include necessary allen head bolts, washers and nuts for fender mounting.

VT No.	Year	Model
37-8978	1986-99	FXST
9920-46	1986-99	Softtail (Four hole strut)
9921-56	1986-99	(6 hole Strut)
2044-26	2000-up	Softtail models
2043-26	2000-up	Softtail models (Low Profile)

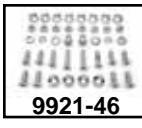

9921-46

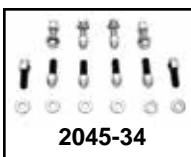

2045-34

Chrome Rear Fender Support Mount Kit to replace original hardware.

VT No.	Year/Model	Style
37-8978	1986-99 FXST	Allen
2045-34	2000-06 FXST	Acorn



9920-46

Fender Strut Mount Kit includes chrome socket bolts, special nuts, washers and pasties chrome covers to match cylinder head bolt dome covers. Fits 1986-99 FXST. VT No. 37-8907

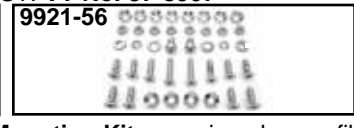

9921-56

Rear Fender Strut Chrome Mounting Kit are unique low profile allen hardware kits to mount struts to fender.

VT No.	Item
9920-46	Mount 4 hole struts on 1986-99 5-speed Heritage Softtail and Fat Boy, pictured.
9921-56	Mounts 6 hole struts on 1986-99 FXST, FXSTC, FXSTS and Bad Boy.
2043-26	FX and FL Softtail 2000-up except FX Deuce





# Fender

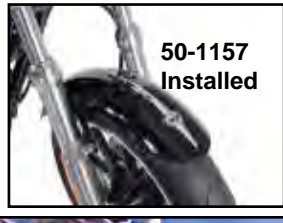

**Chrome Front Fender Strip** with skull design fits FL models.  
VT No. 50-1157

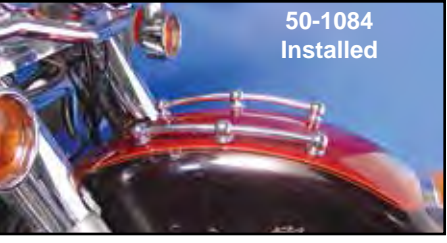

**Fender Ornaments.** Fender must be drilled for installation.  
VT No. Type

- 50-1537 Flying Skeleton
- 50-1536 Skeleton
- 48-0135 Reaper
- 48-0136 Bat
- 48-0246 Hand
- 48-1538 Wheel Devil
- 48-1546 Skull
- 49-1790 Bronze Patina Eagle



**Chrome Front Fender Rails** fit 1984-up FL style front fenders. Includes mount stanchions and template.  
VT No. 50-1084



**Chrome Rear Fender Rail** fits 1986-up FLST models. Features three point mounting.

- VT No. Years
- 50-1016 1986-99
- 50-2016 2000-up



**Chrome Front Fender Trim Rail** fits 1986-up FLST, FLSTC & 1993-1996 FLSTN.  
VT No. 50-1051



**Front Fender Chrome Trim Rail Set** mounts on top of Glide style fenders.  
VT No. 50-1534

# Emblems

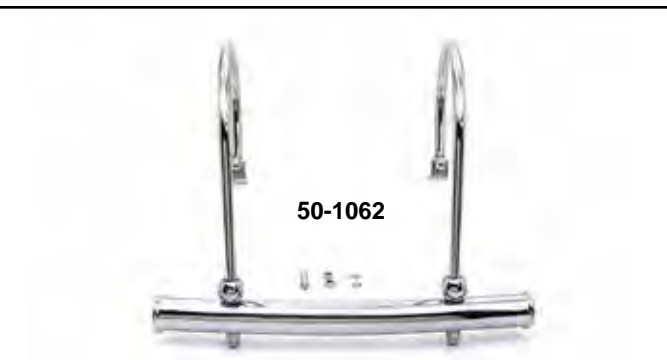

**Chrome Fender Name Plate** for *Ultra Classic*. Sold as pair  
VT No. 38-6711

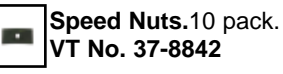

**Speed Nuts.** 10 pack.  
VT No. 37-8842



**Front Fender Decal Gold "Classic"** pair.  
VT No. 38-6713



**Fender Trim Bumper Mount Bracket** fits 1997-2003 FLSTs and 2005-2007 FLSTC. U-shaped.  
VT No. 31-1231

**FLST Rear Bumpers** with original cabbage cutter design grill.  
VT No Grill  
50-1041 With  
50-1062 Without



**Chrome Die Cast Fender Tips** fit 1997-up FLSTS.

**VT No. Fits**

**50-0681** Front

**50-0682** Rear

**50-1214** Set (Front and Rear)



**Lower Front Fender Trim** includes screws except 50-1133 and 50-1015. Fits 1986-up FLST and 1980-13 FLT.

Chrome	Black	Type
50-1015		Smooth
50-1066		Ribbed
50-1220	50-1221	Ribbed, <b>Note:</b> 2014-up FLT
50-1132		Flamed
50-1133		Plain
37-1508		Screw Kit



Chrome Eagle with Chrome Tip	Gold Eagle with Chrome Tip	Chrome Eagle with Black Tip	Gold Eagle with Black Tip	Style
50-1587	50-1588	50-1589	50-1590	Front
50-1591	50-1592	50-1593	50-1594	Rear

Chrome Tip with Black Skull	Black Tip with Chrome Skull	Style
50-1569	50-1570	Front
50-1571	50-1572	Rear



**Replica Fender Side Trim Set** fits 1982-up FLT, 1986-up FLST.

VT No.	Item	Finish
50-0957	Side Strips	Stainless
50-0531	Side Strips	Chrome
37-8784	T-Bolts	

# Fender Tip

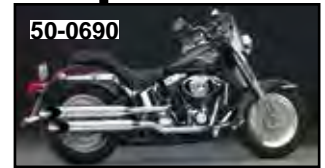

**Chrome National Tips.** \***Note:** All are chrome cast excepted where noted.

**VT No. Fits**

**50-0690** Front front 2002-13 XL, 1980-85 FXWG, and front back 1984-13 FXST, 1983 FXDG

**50-0693** Rear 2001-06 FLST

**50-0696** Rear 2007-13 FLST

**50-0697** Rear 2004-07 FLH

**50-0698** Rear 2006-12 FXST

**50-0711\*** Rear 1990-97 FLSTF, 1997-05 FLSTS



**Chrome Smooth Fender Tips** fit FLSTF models.

**VT No. Type Size**

**50-1118** Front 6½"

**50-1119** Rear 8"

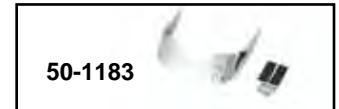

**Rear Fender Tips** fit 2007-up FLSTF.

**VT No. Type**

**50-1182** Smooth

**50-1183** Ribbed

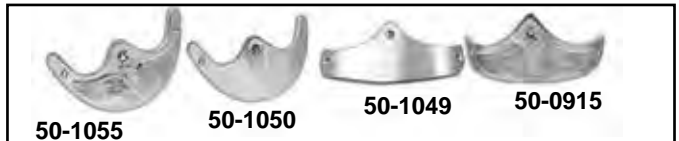

**Chrome Front Fender Tips** is stamped or smooth. Includes screws. Fits fender width as noted.

**VT No. Style Width Type**

**50-1055** Eagle 4" FXWG-FXST

**50-1050** Smooth 4" FXWG-FXST

**50-1049** Smooth 5" FX

**50-0915** Eagle 5" FX



**Front Fender Lower Trim** fits 2014-up FLH.

**Chrome Black Type**

**50-1545 50-1548** Smooth

**50-1546 50-1549** Flame



# 1 1/4" Engine Bar

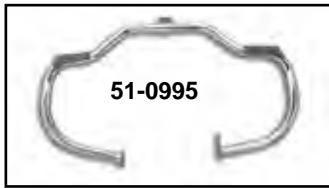

51-0995



51-2080



51-0897



51-0999



51-0990



50-2070

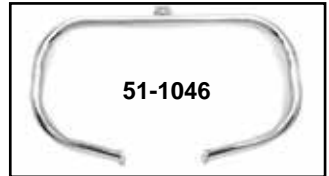

51-1046

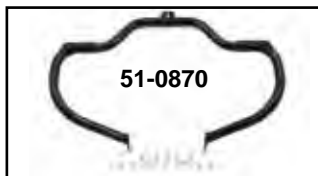

51-0870

### FLST

- 51-0995 1986-99 Front with footpeg pads
- 51-2080 1986-99 Front with footpeg pads
- 51-0897 1986-99 Front, no pads
- 51-0999 1986-99 Front, Black with footpeg pads
- 51-1246 1995-13 Front, no pads
- 51-0990 2000-up Front with footpeg pads
- 50-2070 2000-up Front **Note:** Lindby
- 51-1046 2000-up Front, no pads
- 51-0861 2001-up Front
- 51-0870 2000-up Front with footpeg pads



51-0882



51-0879

### FXD/FXWG

- 51-0882 1991-05 without forward controls, no pads
- 50-2062 1991-up built in O-Rings **Note:** Lindby
- 51-2081 1991-up with footpeg pads
- 51-0879 1993-05 FXDWG Dynaglide, no pads



51-0891

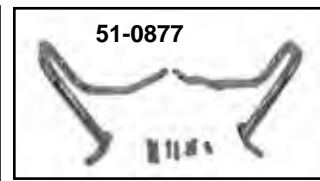

51-0877

### FXST

- 51-0891 1984-99 Front, no pads
- 50-2065 1996-up Rear, pads **Note:** Lindby
- 50-2058 2000-up Front **Note:** Lindby
- 51-0877 2000-up Rear, no pads
- 31-9888 Engine Cross Bar



31-9888



51-2083

### FXSTC/FXTS/FXSTD

- 51-2083 2000-up Front, built in foot rest

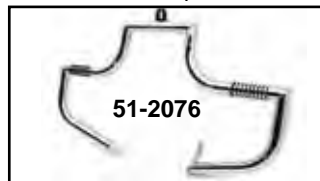

51-2076

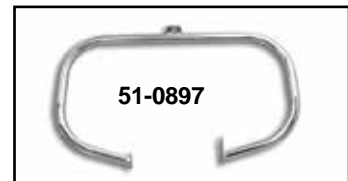

51-0897

### FLSTC/FLSTF/FLSTN

- 50-2060 1986-99 Front **Note:** Lindby
- 51-2076 1986-99 Front, footpeg pads
- 51-0897 1986-99 Front, no pads



51-0887

### FXR

- 51-0887 1982-94 Front, no pads

### Replacement Parts

- 28-0852 Rubber Pads
- 31-9988 Lower Mount with clamps FX-FXST
- 14-0977 Replacement O-Ring for Above Front or Rear Highway Bars



51-0872



51-0997



51-0987



50-2077

### FXD/FXWG Continued

- 51-0872 2006-up FXD-FXDWG, rubber pads with mid or forward controls, **Note:** black finish
- 51-0987 2006-up FXD-FXDWG, no pads with mid or forward controls
- 51-0997 2006-up FXD-FXDWG, rubber pads with mid or forward controls
- 50-2077 2012-up FLD (Switchback), rubber pads **Note:** Lindby

FOR ENGINE BARS LISTED ON THIS PAGE  
 WARNING: THESE ENGINE/FXWG BARS MAY PROVIDE LIMITED LEG AND COSMETIC VEHICLE PROTECTION UNDER UNIQUE CIRCUMSTANCES (FALL OVER WHILE STOPPED, VERY LOW SPEED SLIDE). THEY ARE NOT MADE NOR INTENDED TO PROVIDE PROTECTION FROM BODILY INJURY IN A COLLISION WITH AN AUTOMOBILE OR ANY OTHER OBJECT.





**AEE Series Shock Sets** are nitrogen charged with multi stage dampening and adjustable spring load. All shocks are measured eyelet to eyelet and feature chrome springs and caps with black body. \*Note: Denotes stock length.

Fits	11"	11.5"	13	13.5"	14.25
1983-94 FXRT	54-0020	54-0021	54-0023*	54-0024	54-0025
1984-94 FXRD	54-0020	54-0021	54-0023	54-0024	54-0025
1987-94 FXRS-FXLR	54-0020	54-0021	54-0023*	54-0024	54-0025
1991-08 FXD	54-0135	—	—	—	—

# FXD Shock Set

## 1" Lower Shock



**Chrome FXD-FXDWG Shock Set** will lower bike 1". Center to center distance noted.

VT No.	Year	Length
54-0164	1993-05	11.5"
54-0168	2008-up	12"

# Shock Lowering Kit



**Black Rear Shock Lowering Kits** lowers rear frame area. Includes instructions, hardware and black brackets.

VT No.	Fits	Lowere
54-0513	1991-99 FXD	1"
54-0533	2000-05 FXD	1"
54-0537	2006-up FXD	1"

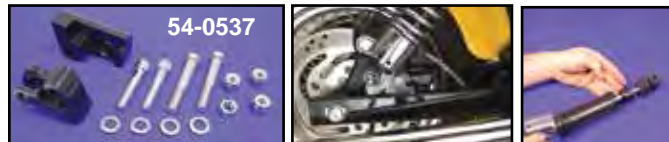

54-0537 Installed



**Lower Shock Stud Kit** includes two nugget nuts and two studs.

VT No.	Year	Model	OEM
54-0431	1982-94	FXR-FXRS	1614
9986-8	1991-up	FXD	3958
28-0231	1982-94	FXR	Bushing, pair

**Upper**  
54-0208 2008-up FXDF



**Shock Tools.**

VT No.	Model
16-0409	1979-96 FXR
16-0100	1990-up FXD



**Chrome Upper Shock Stud Covers.**

VT No.	OEM	Fits
54-0514	57408-88T	1982-94 FXR
54-0519	54341-96	1991-99 FXD

Mount Studs not included with shock sets.

**Warning:** Installing a lowering kit or shorter shocks will decrease initial ground clearance. The motorcycle will be lower to the ground and care should be taken to avoid bottoming, especially over bumps or in turns.



# Shock for FXST-FLST



**Chrome Billet Shock Sets** fit 1989-99 Softail models. Smaller diameter allows more clearance for custom installation.  
**VT No. 54-0131**



37-0572



37-0475

**FLST-FXST Shock Stud Kit** includes 4 bolts and 4 washers.

VT No.	Finish	Year	Mount Studs not included with shock sets.
37-9090	Zinc	1989-99	
37-0572	Chrome	1989-99	
37-0475	Chrome	2000-up	

## Shock Tool



**Dual Shock Tool** fits 1989-up FXST and 79-up FX-XL.  
**VT No. 16-0954**



**1989-up Softail Shock Tool** for use with 3/8" ratchet drive.  
**VT No. 16-0917**



**AEE Chrome Adjustable Shock Assemblies** feature full chrome finish with up to 1 1/2" lowering capability.

VT No.	Years
54-0161	1989-99
54-0162*	2000-up

\*Note: These do not lower the motorcycle, these are standard Softail shocks.



54-0105

**Adjustable Chrome Shock Sets** for Softail models. Order bolt kit separately.

VT No.	Year	Item	Finish
54-0105	2000-up	Shock Set	Chrome
37-0476	1989-99	Bolt Set	
37-0475	2000-up	Bolt Set	



**Softail Shock Spanner** replaces 94555-89.  
**VT No. 16-0748**

## Lowering Kit for Softail



54-0433



54-0434

**E-Z Adjustable** is fully adjustable shock link for Softails. Left hand threaded design allows adjustments in small increments from stock to the drop of your choice. Adjustment is accomplished with open end wrench. Shock must be disassembled. Fits OEM and aftermarket shocks.

VT No.	Year
54-0433	1984-88
54-0434	1989-99



**Adjustable Softail Shock Mount** is for all 2000-up models. Installs on the stock shock and offers easy adjustment from stock ride height to two inches lower.  
**VT No. 54-0535**



54-0520

**Lowering Kit** allows 1.5" lowering. Fits 2000-up Softail.

VT No.	Brand
54-0520	AEE
54-0538	ET

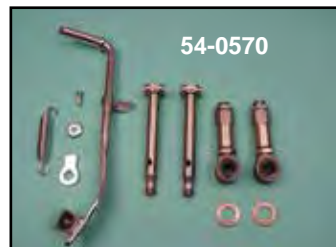

54-0570

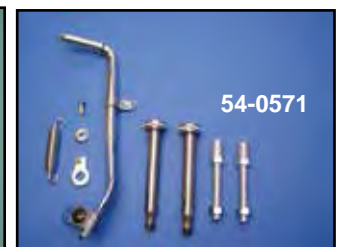

54-0571

**"Full" Lowering Kits** include components to lower the front and rear of Softail models. Each kit includes shorter damper rods, 1" shorter kickstand and adjustable rear shock lowering set. The front of the FXST is lowered 2.5" and 2" on FLST models. Rear is adjustable up to 1.5" on 2000-06 models and up to 2" lower on 1989-99 models, using stock shocks.

VT No.	Year
54-0570	1989-99
54-0571	2000-06

Mount Studs not included with shock sets.

# Rear Shock



All shocks are measured eyelet to center of eyelet.

Mount Studs not included with shock sets.



**Progressive Suspension 440 Series Chrome Shocks** feature two rebound damping circuits and are available in standard for the average single rider, heavy duty for touring or carrying passengers.

Model/Year	11.0"		11.5"		12.0"		12.5"		13.0"		13.5"	
	Standard	Standard	Heavy Duty	Standard	Heavy Duty	Standard	Heavy Duty	Standard	Heavy Duty	Standard	Heavy Duty	
FXR-FXRS-FXLR 1982-94	54-4005	54-4006	54-4011	—	54-4050	54-4007	54-4001	—	—	54-4009	54-4003	
FXD-FXDWG 1991-up	—	54-4052	54-4053	54-4036	54-4044	54-4038	54-4048	54-4039	54-4051	—	—	

**Warning:** Installing a lowering kit or shorter shocks will decrease initial ground clearance. The motorcycle will be lower to the ground and care should be taken to avoid bottoming, especially over bumps or in turns.



**Progressive Suspension 412 Series Chrome Shocks** are manufactured from the finest material available. Magnum 412 Series shocks are nitrogen charged with six-stage automatic damping and an adjustable spring preload. Available with chrome spring and end caps, shock cartridge is not chrome. **All shocks are measured eyelet to center of eyelet.**

#	Year/Model	11.0"	11.5"	12.0"	12.5"	13.0"	13.5"
B	91-up Dynaglide <b>Note: A</b>	54-0061**		54-0060**	54-0038*		
A	83-94 FXRT	54-0093	54-0033		54-2000	54-2001*	54-2002
A	85-94 FXRD	54-0093	54-0033		54-2000*	54-2001	54-2002
A	87-94 FXRS, FXLR	54-0093	54-0033		54-2000	54-2001*	54-2002

\*Note: Denotes stock length shock. When installing other than stock length shocks, tire to fender clearances must be checked.  
 \*\*Note: Fender on FXDWG must be modified. Per instructions.  
 Note A: 1991-92 Dynaglide have 12" stock shock length; 1993-04 except FXDS-CON have 12 5/8" stock shock length.



**Chrome Adjustable Display Center Stands** show your bike with single lever on left side and allows bikes to be lifted up on stand. Very little effort required. Entire assembly fits neatly under frame rails. Two bolt installation.



Bagger Products



**Caution: Not intended for use as a ride off stand.**

**VT No. Fits**  
 16-1521\* 1992-07 Softail  
 16-1522\* 2008-up Softail  
 \*Note: With adjustable height

16-1521 Installed





# Swingarm Components for FXR



**Swingarm Mounting Kit** includes two bushing assemblies, two spacers, two plastic retainer rings, two rubber isolators and pivot shaft with locknut and all parts required to mount transmission and swingarm to pivot block. Will work with stock or aftermarket rubber mount swingarm frames for 1982-94 FXR models.

**VT No. 44-2044**

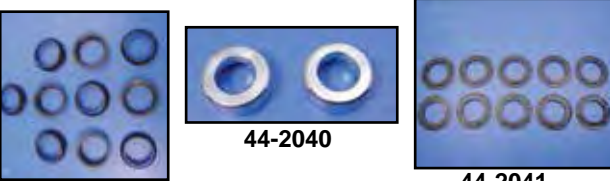

44-2039

44-2040

44-2041



31-0444

31-0452

31-0443



44-1991



44-1984

## FXR Swingarm Rebuild Parts

VT No.	OEM	Year	Item
44-2044	Kit	1982-94	FXR
44-2039	47510-80	1987-97	Plastic Retaining Ring
44-2040	47511-80	1987-94	Spacer
44-2041	47513-80	1987-94	Nylon Washer
31-0444	47538-79	1982-94	Bushing Ring
31-0452	47556-81	1982-94	Bushing Assembly
31-0443	47564-86A	1987-94	Mount Bushing, each
44-2042	47491-89	1989-94	Cupwasher, 5 pack
44-1991	47492-89A	1989-94	Shaft
44-1984	47515-82A	1982-88	Shaft



**Nylatron Swingarm Bushing Kit** is a four piece bushing set replaces swingarm bearings and stabilizes swingarm rubber mounts. Order pin separately. Order (31-3986 or 31-0443) frame mount bushings separately.

**VT No. 44-0671**



**1982-94 FXR Kit.** All are pieces included for ease of installation. Updated Design. Rubbers included. Controls lateral and torsional movement at pivot point. Close tolerance updated spherical bearings included

**VT No. Item**

**44-0941 Kit**

**44-0960 Spacer Set**



**Iso-Mount Swingarm Pin Kit** includes Iso sleeves, pin and side bushings for 1993-2010.

**VT No. 44-2063**



44-0583

42-0030

**FXR Rear Axle Adjusters** include heavy axle pull blocks and chrome end caps with allen screws, for 1982-94. Chrome pivot covers also available.

**VT No. Item**

**44-0583 Adjusters**

**42-0030 1982-89 Pivot Cover Set**



# V-Twin™ Replica Frame

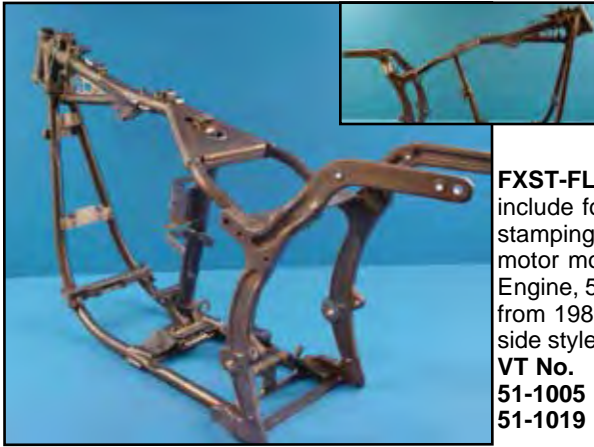

**FXST-FLST Replica Frame** is an authentic reproduction of 1987-99 model. Details include forged parts in neck, front/rear motor mounts and rear strut bars. Formed stampings which have been accurately blanked and pressed are used in the top motor mount and seat area. This frame accepts the 1340 Evolution or TC-88 "A" Engine, 5-Speed rigid mount transmission and all primary related drive components from 1987-99 Softail models. VT No. 51-0964 rear frame section and 1984-99 flat side style gas tanks. Neck includes tab for pad lock and 17 sequence number boss.

VT No.	Type
51-1005	Evolution 1340
51-1019	TC-88

## The Construction of the V-Twin™ Frame



**Rear Strut Arms** are of forged construction with all holes machined to accept stock components.



**Seat Detail** includes formed plates on the seat mount clip.



**Front Motor Mount Bar** is of forged construction connecting the radius front formed down tubes



**Right Side** shows forged rear motor/front transmission mount and front shock mount pivot.

**Forged Neck** gives the authentic look and strength to this replica. Neck includes raised number boss and fork lock tab.



**Softail Frame Brackets** to be welded on.

VT No.	Item
51-0587	Signal Module (A)
51-0583	Circuit Breaker (B)

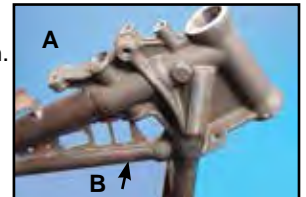

**Chrome Center Frame Post** fits 2007-up Softails.  
VT No. 51-0785



**Neck Lock Tab** welded on 1965-84 Big Twin frames.  
VT No. 51-0517



**FXST Front and Rear Frames.** Accepts flat side gas tank. Order neck cups, rear frame (includes bearings), shocks and hardware separately.



VT No.	Item
51-0965	1987-99 Front Frame, Evolution 5-Speed use stock transmission plate or 17-9999
51-0529	Clutch Cable Bracket
37-9090	Shock Bolt Kit
24-0253	Neck Cup Kit for Above

## Frame Covers for Softail



**Chrome Rear Frame Covers** contoured to fully cover rear castings on 1986-99 FXST-FLST Softail frames. Covers are securely fastened by bolting under rear strut arms, foot peg bolts, swingarm pivot bolts and fastens on lower right under muffler bracket.  
VT No. 42-0001



**Chrome FXST-FLST Full Frame Covers** fit frames 1986-06 to cover frame casting and pivot bolt head. Top fits under strut and is held on by the footpeg mount bolt.  
VT No. 42-0727



**Chrome Softail Rear Frame Covers** bolt on to cover axle adjuster area on all 1986-99 Softail frames. Hardware and instructions included.  
VT No. 42-0034



**Smooth Frame Trim Set** fits FXST-FLST. Easy to install chrome plated trim plates fit into recesses on rear of frame near swingarm pivot. Comes with double-sided adhesive on back.

VT No.	Year
42-0038	1987-06
42-1531	2007-up
42-1534	2000-06 FXST



**Chrome Frame Insert Set** covers area on neck of Big Twin frames 1948-Early 88 with key lock. Easily attached with adhesive pads provided. Available in pairs.  
VT No. 42-0056



**Chrome Tail Spurs** dress up rear castings on 1986-99 FXST-FLST models. Contour steel covers fit behind adjusters to protect paint when axle is removed. Adjuster nuts supplied.

VT No.	Item
42-0676	Spurs
44-0545	Adjuster Kit



# 200 Wide Swingarm Kit for Softail



**200 Series Rear Tire Kit** fits 1987-99 Softails. Includes all parts pictured using a rear chain drive system to install the 200 x 18 Avon Tire. Requires removal of

**Wide Drive Swingarm Kit** maintains the engine center line with a 1" offset given to the transmission and primary drive. Requires use of 9" wide rear fender after cutting off stock strut bars on frame. Fits 2007-up Softail. Kit includes the following swingarm, splash guard, rear axle/spacers, fender strut bars, motor sprocket, transmission plate, pivot bolt, pivot bearings, primary spacer ring and hub spacers. **VT No. 51-2057**

rear frame strut bars to install fender. Includes: 5.50 x 18 rear wheel, chain guard, front sprocket, rear sprocket, splash guard, gasket kit, front sprocket nut kit, rear sprocket bolts and axle spacers. Order 9" wide strutless fender separately.

VT No.	Item	Item
51-0658	1987-99	Kit
50-0216		Fender
50-0251		Fender



Radius Struts

51-2055



51-2169



**Wyatt Gatling Customizer Wide Drive FXST Frame** manufactured from 1/4" diameter tubing with a 34° neck rake, 2" stretch in downtubes and 1 1/2" stretch in backbone. Frame accepts a 200 series tire with belt by use of 1/2" offset kit, FXST oil tank and FXST flatside gas tanks. Frames include rear swingarm, radius style fender struts for 9" fender, front oil tank mount and rear axle.

**VT No. 51-2055**

**Replica Swingarm Frame** features low seat area to be used stock type seats and wrap around style oil tank or stock type square oil tank. Low seat are frames use oil tank 40-0412 for kick start or 40-0408 for electric start. Chain drive frames use 51-0907 swingarm, belt drive type use 51-2149. 51-2169 uses flat side 1984-99 type tank set.

**VT No. 51-2169**



**Wyatt Gatling Wide Wrap Around Oil Tank** are 14" wide for custom wide rigid. Available raw finish. Feature top Iso mount design. Mounting hardware included.

**VT No. 40-0677**

## Offset Components

					<b>Offset</b>
24T Sprocket	25T Sprocket	Nut Set	Trans Plate	Motor Spacer	
—	—	—	—	19-0568	.25"
—	—	—	17-6661	—	.437"
—	—	—	19-0560	19-0561	.5"
19-0104	—	—	—	19-0569	.75"
19-0105	19-0161	—	—	19-0570	1.0"
19-0106	19-0162	19-0576	—	19-0600	1.125"
—	—	19-0577	—	19-0601	1.5"
—	—	—	—	—	1.175"
Solid Mount	—	—	—	19-0603	2"
Sprocket without compensator	—	For use with compensator components	—	—	—





**Rear Frame Chrome Section.** Order pivot kit separately.  
For 2000-05 FXST and 2000-07 FLST

VT No.	OEM	Finish	Brand
51-0978	48442-00	Chrome	V-Twin
For 2006-07 FXST			
44-0588	Pivot Kit	Chrome	V-Twin
For 2008-up FLSTF			
51-0848	47573-08	Black	OE

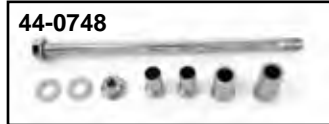

**Chrome Softail Pivot Assembly** includes shaft, nut and spacers.

VT No.	Item	Year
44-0739	Flush Mount Shaft	2000-06
44-0588	Complete Kit	2000-06
44-0726	Shaft Kit	2000-06
44-0748	Shaft Kit	2008-up



**Chrome Plated Rear Fender Strut Mounting Kit** is a unique low profile allen hardware kits used to mount struts to fender. Fits FX and FL Softail 2000-up except FX Deuce.  
VT No. 2043-26

## Chrome Rear Swingarm & Shock Assembly



**Chrome Rear Swingarm and Shock Assembly** fits Softail models. Includes chrome tail section, adjustable shocks with 1" lowering capability, chrome axis tube with tapered allen screws and chrome shock mount bolts.

VT No.	Year
51-0651	1986-99
51-0652	2000-05

## 2000-up Softail Rear Swingarm

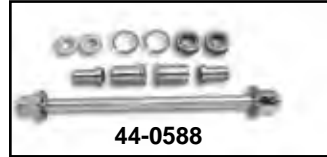

**2000-up Swingarm Hardware.**

VT No.	OEM	Item
44-0608	47610-00	Chrome Pivot Shaft
44-0623	45048-00	Bushing, pair
44-0624	48049-00	Spacer, pair, 2000-06
44-0625	9270	Bearing Only, 2000-up
44-0588	—	Rear Pivot Kit
44-0663	47119-02	Pivot Kit
44-0626	11282	Retaining Ring
44-0627	6535	Left Side Pivot Washer
44-0629	6534	Right Side Pivot Washer
42-0686	43462-00	Dome Cover Set
37-0960	7479	Nut Only



**Softail Rubber Bumper** for 2000-up replaces 11514.  
VT No. 28-0587



**Pivot Spacer Sets** fit Softail models (4 piece).  
VT No. Year Finish  
44-0710 2000-06 Zinc  
44-0712 2007 Zinc  
44-0711 2008-up Zinc



**FXST-FLST Rear Fender Extension** to replace stock plastic extension. Flat panel design for 2000-10.  
VT No. Finish Year  
50-0517 Stainless 2000-07  
50-0518 Chrome 2000-07  
50-0522 Stainless 2008-10



**Upper Swingarm Covers** fit 2001-07 Softail models. Bolt on to cover welded area.  
VT No. 42-0378

## Skid Plate



**Steel Skid Plates** replace 24490-36. Fit 1936-99 Big Twins.

VT No	Finish
42-0101	Chrome
42-0098	Stainless
42-0117	Black
42-0777	Chrome



# 1987-99 Softail Rear Swingarm

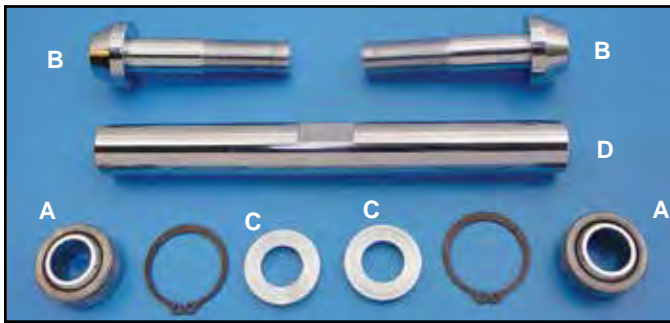

**Chrome Rear Pivot Kit.** Fits 1987-99 FXST-FLST. Order hardware separately.

VT No.	#	OEM	Item
44-0585	A, B, C, D	Kit	Kit
44-0584	A	9076	Bearing Kit, two pieces
12-9910		11156	Snap Rings, 10 pack
37-8824	B	4961	Tapered Allens, pair
54-0438		7142	Lockwasher for Above
37-8896	C	43283	Washers, pair
44-2000	D	48031-89A	Axis Tube, Chrome



**FXST Pivot Bolts and Covers** fit 1986-99 Softail. Covers are available in chrome dome or reflectorized. Allen cap screws replace existing bolt. Pairs.

VT No.	Type	Item
37-8824	Chrome Tapered	Allen Bolts
51-0971	Chrome Stock	Hex Bolts
54-0438	Lockwasher for Above	
42-9926	1986-99 Chrome Dome	Cover
8940-2	1986-99 Red Reflector	Cover
8939-2	1986-99 Amber Reflector	Cover



**1991-99 Softail Wide Right Side Drive Swingarm** in conjunction with parts listed allows use of 280-300 rear tire with a 1.5" belt. Swing arm is 2" longer than stock Softail tail section includes adjuster and 1" axle.

VT No.	Item
51-0705	Wide Swing Arm
20-0375	70 T Pulley
50-0242	Strutless Fender
31-0879	Fender Tabs
20-4010	Belt, 1.5 x 136T
51-0633	Weld On Caliper Mount
50-0583	Strut Set

Fit and space curved strut set, 50-0583, to stock Softail style frame. Allows use of 11" fender, swing arm, 51-0705 swing arm, 280 x 18 Metzler tire and GMA brake pulley combo, 23-4537, and 1.5" belt.



**Chrome Rear Frame Section** for Softail models. Includes the pivot bearings installed.

VT No.	OEM	Years
51-0969	49231-97	1989-99
44-0585	Pivot Kit	1987-99



**FXST-FLST Frame Rubber Bumper** with 1/4" x 20 thread. Replaces 11451, pair.

VT No. 28-0550



**1989-99 FLST-FXST Shock Stud Kit** includes 4 bolts replacing 4074 and 4 washers replacing 6724W.

VT No.	Finish
37-9090	Zinc
37-0572	Chrome



**Rear Fender Extension** to replace stock plastic extension. Fits 1986-99 FXST-FLST.

VT No.	Finish	Type
50-0515	Chrome	Curved
50-0737	Stainless	Flat Panel



**Pike Swingarm Pivot Bolt Set** includes chrome pike nuts and studs for 1989-99 Softail models. VT No. 37-0330



**Chrome Steel Strut Bars** will allow use of a 11" wide fender on Softail frames.

VT No. 50-0583







# For FXD-FXDWG Swingarm

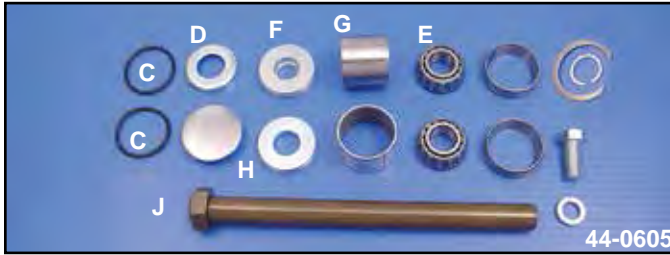
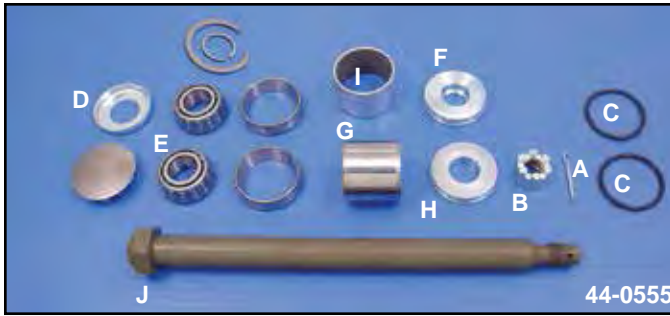

FXD Swingarm Rebuild Parts. Fit all 1991-up Dynaglide.

VT No.	#	OEM	Item
44-0555	A-J		1991-99 Complete Kit
44-0605	A-J		2000-05 Complete Kit
44-0790			2006-up Complete Kit
37-8661	A	534	1991-99 Cotter Pin
37-0564	B	7734W	1991-99 Nut
14-0515	C	11139	1991-up O-ring
44-0590	D	41585-90	1991-up Dust Shield
12-0360	E	47082-81	1991-up Bearing Assembly
44-0591	F	47496-90	1991-up Spacer Left Hand
44-0592	G	47499-90	1991-up Spacer Right Hand
44-0593	H	47565-90	1991-99 Washer
44-0594	I	47624-90A	1991-up Bushing
44-0595	J	47817-90	1991-99 Pivot Bolt
44-0606	J	47817-00	2000-up Pivot Bolt
44-0758	J	47641-06	2006-up Pivot Bolt



**2006-up Chrome Peg Mount Set** fits FXD-FXDWG models. Order male pegs separately.

VT No.	Item
27-0858	Mounts Stock Height
27-0861	Mounts, Raised Height
27-1232	Peg Set

## Hard Tail for FXD

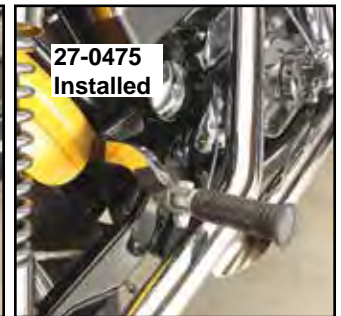

**1994-05 Rear Footpeg Mount Kit** includes right and left bracket. Order pegs separately.

VT No.	Item
27-0475	Mount Kit Only
27-0439	Mount Kit with pegs



**1990-up FXD Driver Footpeg Mounts Set**  
VT No. 27-0804

**Bolt On Hard Tail Units** to 1990-98 FXD-FXDWG models. Use stock rear wheel or fit up to 200mm width. Order battery box separately. Bottom attaches to swingarm pivot point to aid in alignment.

VT No. 51-0786

**Note:** Attachment points, we recommend installation be completed by a qualified technician.





# Exhaust

**Maxx-shot Softtail Exhaust Set** features 1 3/4" headers with full coverage 2 1/4" form fit chrome heat shields. Fits 1986-06 FXST and FLST with or without footboards. Includes mounting bracket and removable baffles. **VT No. 30-0318**

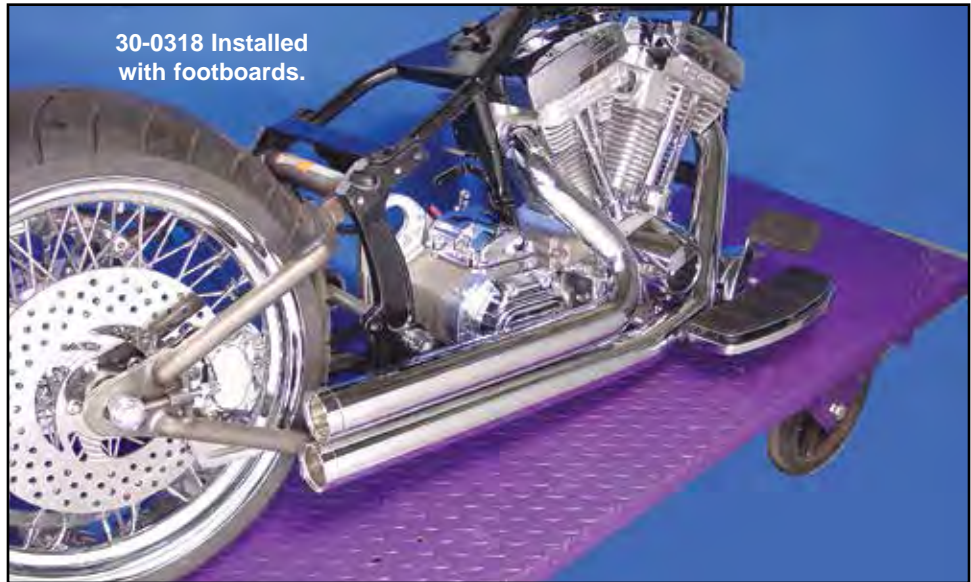

30-0318 Installed with footboards.



30-0318

**Radii Exhaust Sets** feature "Quad Finishing" which includes triple dura nickel and chrome as the final finish. After chrome plating, pipes are normalized and dried @ 572° F for the final finish process.

**Full Coverage Formed Heat Shields Included!**



30-0318 shown with full coverage heat shields.

Includes full coverage heat shields and chrome end caps



**Softtail Short Stuff Pipe Set** features 1 3/4" headers with full coverage 2 1/4" heat shield set. Fits 1986-06. **VT No. 30-0517**

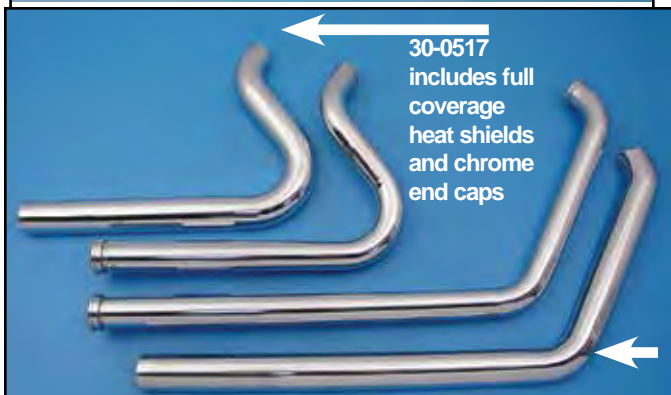

30-0517 includes full coverage heat shields and chrome end caps



**Six-Gun Pipe End Set.** Wyatt Gatling's end tips fit pipes with 2 1/4" full coverage heat shields over 1 3/4" pipes. **VT No. 30-0576**



**Important Note:** Some items on this page may be emission-related parts subject to California or other emission control laws. Please see note on page 71 for important information regarding emission control regulatory compliance and warranty information.



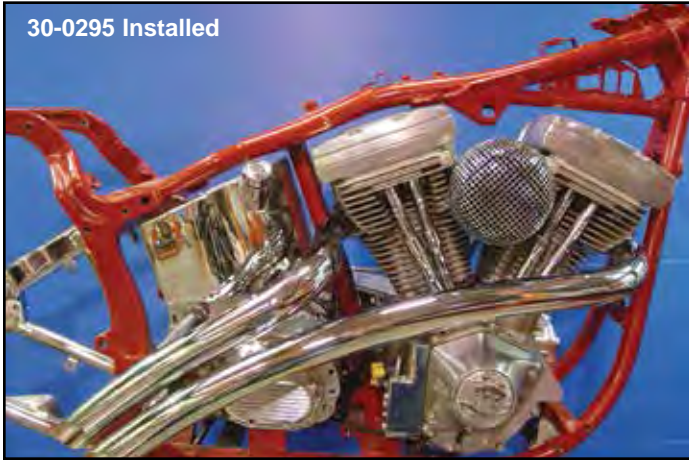

30-0295 Installed

**Note: Radii Exhaust Set** features "Quad Finishing" which includes triple dura nickel and chrome as the final finish. After chrome plating, pipes are normalized and dried @572°F for the final finish process.



## 2" Exhaust

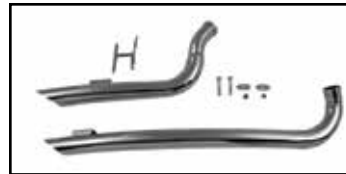

**Chrome Radii Pipe Set** features full curve with 2" outside diameter for Softail models in Rigid or Softail frame. Bracket included. Fits 1984-06. **VT No. 30-0295**



**Vance & Hines 3" Round Twin Slash Slip-On Mufflers** feature muffler bodies shielded by full-coverage heat shields for a blue look. Increase performance with a throaty growl. Include louvered core baffles. Sold in pairs. Fits 2007-10 FXST, FLST.

**VT No. 30-1582**



**Pirate 2" Curve Pipe Set** fits 1986-06 Softail/Evolution and TC-88.

**VT No. 30-0320**



30-3370

**2" Drag Pipes** are 40" long.

**VT No. Mt. Bkt Fits**

**30-3370** Included 2000-06 FXST-FLST

**\*Note:** Mount bracket required for 1991-94 models only.

1995-up bolts to stock mount.



**Important Note:** Some items on this page may be emission-related parts subject to California or other emission control laws. Please see note on page 71 for important information regarding emission control regulatory compliance and warranty information.







# Exhaust



30-0722 Installed

Before Starting Engine wipe all fingerprints off exhaust pipes after installation. Oil from hands will leave permanent marks on chrome finish.



Pipe Set fits left and right side drive.

VT No.	Type	Year	OD	Finish	Brand
30-0460	Down	1986-up	2"	Chrome	Wyatt Gatling
30-0464	Down	1986-up	2"	Black	Wyatt Gatling
30-0469	Down	1986-up	1 3/4"	Chrome	Radian
30-0722	Down	2004-up	1 3/4"	Chrome	Wyatt Gatling

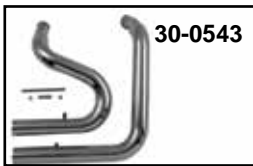

**30-0543 Installed**  
Chrome Stack Radian Pipe Set fits left and right side drive, 1985-2006, 2 1/4".

VT No. 30-0543

30-2000  
2000 FLST Softail



Double D Kickers.  
VT No. Fits  
30-2002 1986-99 FLST/FXST  
30-2003 1999-05 FXD

Double D Slip-on Mufflers bolt to stock head pipes and feature doublewall performance, 1 1/2" baffles and have the same diameter as stock. Sold in head pipe for smooth look.

VT No. Fits  
30-2024 1986-99 FLST

Double D S-Bends feature S-bend rear pipe and parallel slash cut ends.

VT No. Fits  
30-2015 2000-06 FXST

Wyatt Gatling Drag Pipe Set Down Type fits 1986-up FXST.

Chrome	Black	O.D.
30-0722	30-0735	1 3/4"
30-0460	30-0464	2"
30-0544		2 1/4"



Pipe Bracket mounts to cam cover on Evolution and TC-88 models for 30-0544. Hardware not included.

VT No. 31-0894

Model	Hardware
Evolution	(2) None
TC-88	(2) 1/4 2 20 x 2 1/2 (2) 37-0404 3/4



Oxygen Sensor Sealing Washer

VT No.	Year	Size
15-0081	2006-10	18 mm
15-0012	2011-up	12 mm

**Important Note:** Some items on this page may be emission-related parts subject to California or other emission control laws. Please see note on page 71 for important information regarding emission control regulatory compliance and warranty information.







# Exhaust



30-0792

**2" Side Sweeper Exhaust Pipes** fit 5 and 6-Speed 1986-up FXST models without foot-boards. Pipes have oxygen sensor ports with plugs which can be removed for 2007-up models to install sensors.  
**VT No. 30-0792**

*Radii Exhaust Sets* feature "Quad Finishing" which includes triple dura nickel and chrome as the final finish. After chrome plating, pipes are normalized and dried @572° F for the final finish process.

# Upsweep Exhaust



29-0500  
Installed



29-0086 with Megaphone



29-1131



29-0089 Installed

Bracket Set

**FXST Fish Tails** are chromed with upsweep in 1 3/4" diameter for Evolution and TC-88 models. Baffles not included

- VT No. Year**  
**29-1131** 1986-99  
**29-0500** 2000-06

**Chrome Up Sweep 1 3/4" Header Sets** will accept straight fishtail extensions or mufflers which must be purchased and mounted separately for Softail or Rigid frames.

VT No.	Model	Year
29-0086	Evolution	1984-94
29-0089	Evolution	1995-99
30-0589	TC-88	2000-06



**Important Note:** Some items on this page may be emission-related parts subject to California or other emission control laws. Please see note on page 71 for important information regarding emission control regulatory compliance and warranty information.







# Monster Drag Pipe 2 1/4"

**Radii Monster Drag Pipes** feature 2 1/4" outside diameter and mount to stock brackets. Fits 1986-06 Softtail models. Order baffles separately. Black end cap fits straight cut end pipes, by drilling 1/4" mount hole. Order 30-0452 end caps separately.

- | VT No.   | Fits                  |
|----------|-----------------------|
| 30-0550  | Down Slash Stretchers |
| 30-0551* | Straight Cut          |
| 30-0552  | Down Slash, Shorty    |
| 30-0578  | Down Slash, Longs     |
| 30-3336  | Drags                 |
| 30-0556  | Side Cut              |
| 30-0953  | Shotgun               |
| 30-0579  | Side Slash, Shorty    |
| 31-0016  | Bracket               |

\*Note: Does not include mounting hardware.



31-0016



30-0550

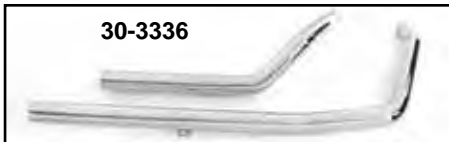

30-3336



30-0551



30-0552



30-0551 Installed

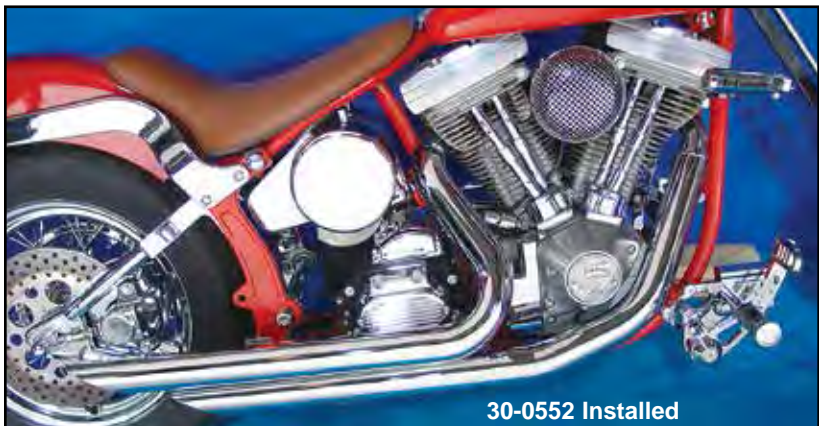

30-0552 Installed



30-0799



30-0801

**Black Billet Tips** for 2 1/4" pipes.

- | VT No.  | Type        |
|---------|-------------|
| 30-0799 | Tapered     |
| 30-0801 | Ball Milled |



30-0556 Installed

30-0461 TIP CAP SET, BLACK



**Important Note:** Some items on this page may be emission-related parts subject to California or other emission control laws. Please see note on page 71 for important information regarding emission control regulatory compliance and warranty information.



# 1985-94 FXR Exhaust



30-0768



30-0769

**2:1 Side Exhaust Lake Side Pipes** with a 5" turn out end fits 1986-94 FXD-FXR-FXST with forward controls.

**VT No. Style**  
**30-0768** Chrome  
**30-0769** Black



**Chrome 2 into 1 Exhaust Pipe Head.** Single type fits 1984-94 FXR-FXRS.  
**VT No. 29-1145**



**Clamp Set** for 1982-94 FXR, 1991-up FXD pipe.  
**VT No. 31-0556**



30-3395



30-3144

**Chrome Exhaust Pipes** fit Evolution engine FXR-FXRS-FXLR, except Dynaglide. Feature a true one piece construction. Designed to be used with stock flange rings, gasket, clamps and hardware. Mounts to stock bracket with concealed mounts.

**VT No. Style**  
**30-3395** 2 1/4" Drags  
**30-3144\*** 1 3/4" Goose Drags  
**\*Note:** Use 31-2101 Mount Clamp



**Exhaust Bracket Mounting Block** fits all 1982-86 FXR models and replaces 65780-82, Sold each. **VT No. 28-0229**



**T-Bolt Set** is a replacement for all of our muffler pipes which have channel type mounting. Supplied with nut.

**VT No. U/M**  
**31-2116** Pair  
**31-0223** 10 pack

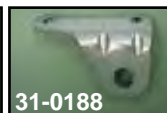

**Exhaust Pipe Brackets**, zinc plated.  

VT No.	OEM	Type
<b>31-0189</b>	65670-82	Front
<b>31-0188</b>	65671-82	Rear

## Emissions and Noise Regulations Important Information:

**Disclaimer:** The California Air Resources Board (CARB does not permit the use of aftermarket emission-related parts) that alter the performance of OEM emission-related devices unless CARB has issued an executive order, other than on racing vehicles on closed course. Check your local laws and manufacturer's information.

**Disclaimer:** Emission related parts for OEM Non-emission control system equipped motorcycles as well as slip on mufflers that mount downstream of and which do not alter the performance of OEM emission-related devices, are considered legal replacement parts by CARB. More California exhaust information is available a [www.arb.ca.gov](http://www.arb.ca.gov).

**Disclaimer:** Aftermarket products, including but not limited to exhausts, fuel, air controllers, air filter kits, camshafts and carburetors and jet kits which alter, modify, or replace emission control devices or systems of an originally compliant highway motorcycle, are not legal for sale or street use in California unless they have been issued a CARB Executive Order. Aftermarket emissions related products which have not been issued an Executive Order or which are not aftermarket Replacement Parts, as defined in Title 13, California Code of Regulations, Section 1900 (b)(2), are authorized for closed circuit race use only. Products shown may be designed, manufactured, intended and sold for closed circuit race use only and use of the same on public roads or lands may be a violation of local, state and/or federal laws. See manufacturer's information and state and local laws to determine what is authorized for your use on your vehicle.

**Disclaimer:** Products shown may not conform to federal, state or local noise regulations.

### Warranty

**Disclaimer:** There is no warranty on exhaust pipes and mufflers with regard to any discoloration. Discoloration (blueing) is caused by tuning characteristics, i.e. cam timing, carburetor, etc. and is not caused by defective manufacturing.

**Disclaimer:** Check your applicable laws and manufacturer's publication(s) and/or website(s) for manufacturer's warranty, maintenance, safety, mounting and any regulatory compliance/non-compliance information.



**Important Note:** Some items on this page may be emission-related parts subject to California or other emission control laws. Please see note on page 71 for important information regarding emission control regulatory compliance and warranty information.







# Big Twin Drag Pipe



30-3015 Installed on 1984-99 FXST



30-3004

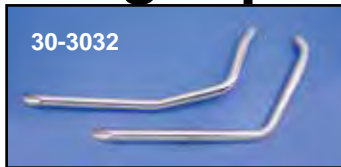

30-3032



30-2166



30-3003 with shields



30-3015



30-3015



30-3102

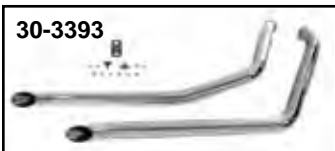

30-3393

Radll Drag Pipe Sets are 1 3/4" slash cut style 38" length. Pipes mount by stock brackets.

VT No.	Year	Model
30-3032	1986-06	FXST
30-3050	As Above	3 Sets
30-3051	As Above	6 Sets
30-3003	1984-99	FXST
30-3015	1984-06	FXST
30-3102	1984-86	FXST
30-3004	1984-99	FXST Shotgun
30-3394	2007-up	FXST Goose
30-3393	2007-up	FXST Drag
30-2166	1984-99	FXST Goose



## 1 3/4" Drag Pipes Big Twin

1 3/4" Drag Pipes by Cycle Shack are 40" long.

Pipes Bracket Type

### FXST-FXCW-FLST

30-3369 Included 2000-06

### FLSTF

30-3368\* Stock 1990-06, 1990-99 use OE bracket

30-3374 Stock 2007-up

### FXCW

30-3379 Stock 2008-up

\*Note: Order mounting bracket for 1990-99 replacement applications.



30-3369

Drag Pipes Competition or Drag Pipes are not approved for highway use in any state. They are meant for show or race competition. Stock: Indicates no additional brackets required. Brackets must be ordered separately when required.



Caution: These exhaust products are not legal for sale or use in California on pollution controlled vehicles. These products are intended for non-highway only.





# 1984-06 Softail 2 1/4"



30-0054



30-0056

**Samson Extreme Series Exhaust Pipe Sets** for 1984-06 Softail models. Feature 2 1/4" diameter and include mounting hardware when required.

**VT No. Style**

**30-0054** Slash

**30-0056** Back Slash

**30-0050** Baffle and Ring for Above



**Performance Rings** fit into 2.25" drag pipes to create back pressure.

**VT No. 30-0050**

### Exhaust

**VT No. Item**

**30-0439** 2:1 EXHAUST HEADER KIT, CHROME RADI SLIP-ON MUFFLER SET, DOWN SLASH

**30-3347** SLIP-ON MUFFLER SET, TURN OUT, CHROME

**30-3363** SAMSON BIG GUNS Staggered

**30-3410** SAMSON BIG GUNS DRAG PIPE



**Chrome Exhaust Pipe Set** with dumper style mufflers for FXST and FLST models. Sold in a quantity of 2. Baffles are not removable. Includes brackets.

**VT No. 30-0558**



**Chrome Down Slash Slip-On Muffler Set** has removable baffles. One bolt for a quick removal. Sold in a quantity of 2. Fits 1995-2005 FXD & 1995-2005 FXDWG. OEM # 80366-99.

**VT No. 30-2040**

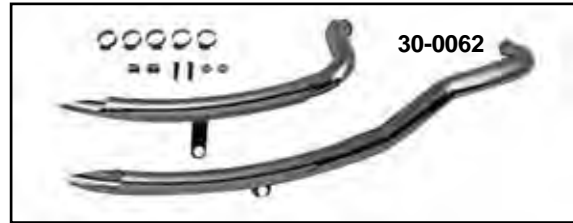

30-0062

**Samson Hell Raiser Series Exhaust Pipe Sets** for 1984-06 Softail model. Feature 220° heat shields, 1 3/4" head pipes, 2 1/4" diameter body and includes mount hardware when required.

**VT No. Style**

**30-0062** Dagger

**30-0057** Sinners Piranha

**30-0059** Hell bound Piranha



**Oxygen Sensor Sealing Washer.**

**VT No. Year**

**15-0081** 2006-10

**15-0012** 2011-up

**MM**

18

12

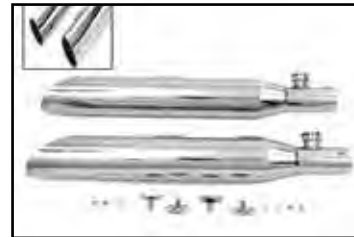

**Chrome Slip On Muffler Set. Slash Style.** Fits 2007-up FXST.

**VT No. 30-0997**



**Caution:** These exhaust products are not legal for sale or use in California on pollution controlled vehicles. These products are intended for non-highway only.



29-1150



29-1151



29-1153

**Chrome Cycle Shack Exhaust Pipe Set** features 1 3/4" outer diameter header pipes, and has one piece construction.

**VT No. Style**

**29-1150** Turnout

**29-1151** Super Slash

**29-1153** Tapered

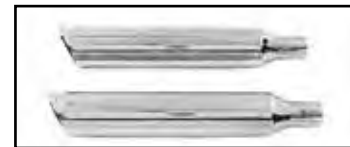

**Radii Side Slash Slip-On Muffler Set** has an outer diameter of 3 1/4" with an inner diameter of 3".

**VT No. 30-0861**



**Caution:** These exhaust products are not legal for sale or use in California on pollution controlled vehicles. These products are intended for non-highway only.







# Exhaust for 85-86 FXE-FXWG, 84-up FXST-FLST



**Slip On Chrome Muffler Set** for stock OE headers. Fit 2007-up FXST.

**VT No. Type**

30-1282 Black Tip

30-1281 Chrome Tip

30-1283 Chrome Ball Milled

30-1284 Chrome Tapered Cone



**Muffler Pipe Set** fits 1986-99 FXST-FLST.

**VT No. Type**

30-0549 Tapered

31-3980 Bracket

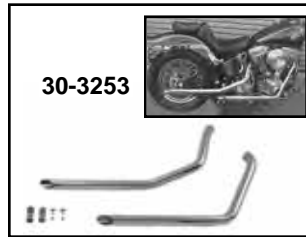

**FXST-FLST Pipes.** Muffler pipe sets for all 1984-up FLST-FXST and all 1985-86 FXE 4-Speed. Features include 1<sup>3</sup>/<sub>4</sub>" head pipes, 2<sup>1</sup>/<sub>2</sub>" diameter mufflers with true one piece construction. Uses stock flange rings, gaskets, hardware and mounts to the factory bracket.

**2000-06 Muffler**

29-1196 Turn-Out

29-1197 Super Slash

30-3369 1<sup>3</sup>/<sub>4</sub>" Drag Pipes

30-0097 Heat Shield Set



**Chrome FLSTNI Drag Pipe Sets** for 2005-06 FLSTNI Softail Deluxe models available in 40" length. Front pipe mounting bracket is included and rear pipe mounts to factory bracket. The 1<sup>3</sup>/<sub>4</sub>" type uses stock heat shields the 2" type includes rear heatshield and uses stock front heat shield.

**VT No. Type**

30-0078 1<sup>3</sup>/<sub>4</sub>"

30-0079 2"

## Slip On Muffler

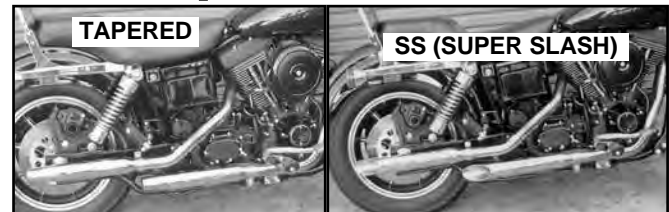

**Replacement Slip On Muffler.** Choice tapered or super slash, styles, which offer low restriction, and ease of installation to factory support and head pipes. Sold as pair.

**Tapered Super Slash**

2000-06 FXST-FLST

30-3342 —

2000-up FXST-FLST

— 30-0985

1980-85 FX-FXE-FXS-FXWG, 1984-94 FXST-FLST-FLSTF

30-0235 —

\*Note: 1991-94 models require mounting bracket



**Important Note:** Some items on this page may be emission-related parts subject to California or other emission control laws. Please see note on page 71 for important information regarding emission control regulatory compliance and warranty information.







# Fishtail Style for FLSTS



See them on the web! [www.vtwinmfg.com](http://www.vtwinmfg.com)

29" Fishtails for FLSTS Heritage models available in straight or muffer fishtail.

VT No.	Type
30-0049	Straight
30-0846	Straight
30-0604	Muffer Set
30-0798	Muffer Set
31-0815	Bracket (each)

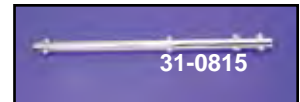

# Pipes for FLSTF

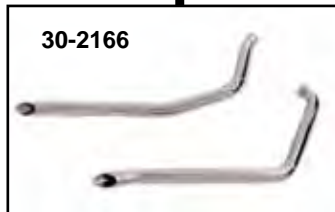

**Goose Style Drags.** Retro chopper styling in 1 3/4" diameter and slash cut ends. Use with existing brackets.

VT No.	Year	Model	Length
30-3144	1984-94	FXR	34"
30-2166	1986-99	FXST	40"



**Chrome FLSTN/ Deluxe Pipe Set** fits 2005-06 models. Features 1 3/4" head pipes, 2 1/2" diameter mufflers and one piece construction. Uses stock flange rings, gaskets heat shields and mounts to stock bracket.

VT No.	Muffler
29-0189	Taper
29-0191	Turnout
30-0078	1 3/4" Drag Pipe
30-0079	2" Drag Pipe



**Pipes For FLSTF-FXSTD** in 1 3/4" header pipe size for 1990-up.

2007-up	2000-06	1990-99	Style
—	29-1193	—	Super Slash
—	29-1194	—	Tapered
30-3374	30-3368	30-3368	1 3/4" Drag Pipe

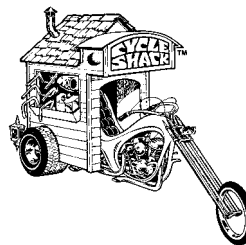

**Sadly after 40 years in business, Cycle Shack closed in 2015.**

Cycle Shack Patch.  
VT No. 48-1432

Note: Modification to original equipment exhaust systems may not be permitted under local or Federal noise limitation and/or emission laws. Check your local regulation before ordering. The high performance exhaust components offered in our catalog are legal for off road use only on 1979 and later models.



**Important Note:** Some items on this page may be emission-related parts subject to California or other emission control laws. Please see note on page 71 for important information regarding emission control regulatory compliance and warranty information.





# 2 1/4" Exhaust Pipe Set



30-0541



30-0542

**X Series Pipe Sets** in 2 1/4" diameter fit right or left side drive applications.

VT No.	Style	Bracket
30-0541	X	31-1576
30-0542	Venom	

Before Starting Engine wipe all fingerprints off exhaust pipes after installation. Oil from hands will leave permanent marks on chrome finish.

## Billet Exhaust End



**Baffle and End Caps available separately.**



30-0791 Installed



30-0791

**Chrome Billet Exhaust Ends.**

VT No.	Fits
30-0791	1 3/4"
30-0790	2 1/4"



**Chrome Billet Aluminum Custom End Caps** fit all 2 1/4" outer diameter pipes.  
VT No. 30-0354



30-0453



30-0453 Installed

**Chrome Billet Ends** fit 2 1/4" outer diameter straight pipes.

VT No. 30-0453



30-0789



30-0788

**Six Gun Pipe Ends.**

VT No.	Fits (Outer Diameter)
30-0789	2 1/4"
30-0788	1 3/4"



**Chrome Billet Scalloped Pipe Ends** fit 2 1/4" outer diameter straight pipes. Sold as a pair.

VT No. 30-0313



**Important Note:** Some items on this page may be emission-related parts subject to California or other emission control laws. Please see note on page 71 for important information regarding emission control regulatory compliance and warranty information.







# Tru Dual Exhaust Header for Softail models



29-1169 Crossover Set (left)

**FLST-FXST Fishtail Dual Exhaust Kit** by Paughco fits all 1995-up models. Available with Fishtail ends only with or without mufflers. Complete with clamps and mounting hardware. Includes shift rod where required. 1 3/4" outside diameter use with 30-0293 heat shield set.

VT No.	Type	Year
29-1143	With Straight thru Fishtails, shown	1995-99
29-1144	With Fishtail Mufflers	1995-99
29-1154	Pipe Set Only	1987-99
29-0501	Pipe Set Only	2000-06
30-0293	Heatshield Set	1987-99



30-1589

**Chrome Vance and Hines Dual Exhaust System.**

Fits 1997-2011 FXST, FLST.

VT No. 30-1589

**True Dual Chrome Exhaust Systems** feature a single pipe for each side. Each pipe is independent and has 1 3/4" outside diameter. The rear pipe is for the left, and the front pipe is for the right without intersection.

VT No.	Fits
29-1169	1995-99 FXST-FLST
29-1190	2000-06 FXST-FLST
31-0815	Bracket, Each

**\*Note:** Heat shield set is for rear pipe only. Use factory heat shield on front pipe.

## 2 into 1 Exhaust

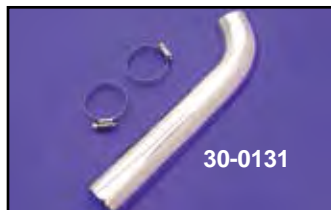

30-0131



**Chrome 2 into 1 Heat Shield Set.** Fits 1986-99 FLST when an early FL look is desired.  
VT No. 30-0334

**Heat Shields by Paughco**

Front	Fits
30-0131	30-3158
30-0131	30-3210
30-0131	29-0088
—	30-3163
—	30-3164



**Important Note:** Some items on this page may be emission-related parts subject to California or other emission control laws. Please see note on page 71 for important information regarding emission control regulatory compliance and warranty information.







# 2 1/4" Exhaust for Dynaglide



30-0371,  
30-0475



30-0786 Installed on 2006 FXD

**Sweeper Exhaust** fits FXD models including 2006-up models with oxygen sensors. Pipes are 1 1/4" to 2 1/4" at end portion. Bracket included. Order baffle separately.

- | VT No.  | Item               |
|---------|--------------------|
| 30-0786 | 1991-up Pipe Set   |
| 30-0423 | Oxygen Sensor Plug |



30-0423

**Radii Exhaust Sets** feature "Quad Finishing" which includes triple dura nickel and chrome as the final finish. After chrome plating, pipes are normalized and dried @572° F for the final finish process.



**FXD Header Pipes** include cross over as original for 2008-up. VT No. 30-0419

**2 1/4" Drag Pipes** fit FXD-FXDWG. Brackets are included. Order baffle rings separately.

VT No.	Item	Year
30-0371	Pipes	1995-05 FXD
30-0475	Pipes	2006-up FXD
31-0811	Replacement Bracket	1995-up
30-0050	Baffle Rings	—



30-0050



**Oxygen Sensor Tool** will remove and install oxygen sensors on fuel injected models. Can be used with 7/8" wrench or 3/8" drive.

VT No.	Fits
16-1131	18mm
16-1132	14mm

## 2:2 Crossback Exhaust



**The Best Muffer Clamp!**  
VT No. 31-1007

**Rinehart Racing Chrome Crossback 2 into 2 Exhaust System.** The Crossover three step header design with 2 1/2" chrome integrated mufflers significantly boosts torque and horsepower across the RPM range. Crossback systems are available in flush cut or staggered versions, and include 2 1/2" 220° full coverage heat shields that merge flush to the muffler bodies with custom billet end caps and two sets of baffles. The system has a 2" outer diameter for engines up to 96 cubic inch and 2 1/4" outer diameter for large high performance engines. All systems include two oxygen sensor ports.

### Flash Cut Style

VT No.	Fits
30-1547	2006-up Dynaglide

### Staggered Style

30-1549	1986-up FXST
30-1550	2006-up Dynaglide
30-1551	1999-05 Dynaglide



**Namz O2 Enrichment Device** Recommended for bikes with high flow air cleaners and performance exhaust systems. The reduces engine operating temperature between 20-30 degrees. Just simply plug this in between oxygen sensors and wiring harness. Fits 2007-2008 FLT, 2007-2011 FXST-FLST.

VT No. 32-6553



**Important Note:** Some items on this page may be emission-related parts subject to California or other emission control laws. Please see note on page 71 for important information regarding emission control regulatory compliance and warranty information.





# Vance & Hines Exhaust



BIG TWIN

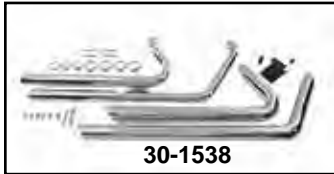

30-1538



30-1539



30-1598



30-1590



30-1557

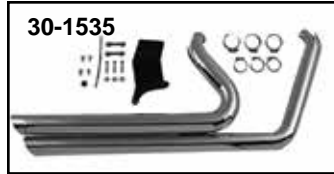

30-1535



30-1599

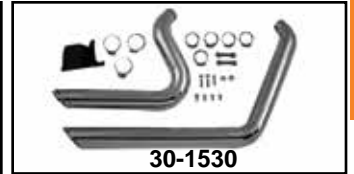

30-1530



30-1558



30-1602



30-1542

**Vance & Hines Big Shots** feature 2½" header pipes. The unique crossover power chamber design increases horsepower and torque, and includes full coverage heat shields, billet end caps, removable baffles and mounting hardware. Available in chrome or black finish.

### 1986-up Softail

Chrome	Black	Style	End Type
30-1538*		Staggered	
30-1539*		Long	

### 2012-up Softail

30-1557		Staggered	Slash Cut
---------	--	-----------	-----------

### 2006-11 FXD/FXDWG

30-1535		Staggered	
---------	--	-----------	--

### 2012-up FXD/FXDWG

30-1558		Staggered	Slash Cut
	30-1602	Staggered	Straight Cut

\*Note: Pre 2007 models will require O<sup>2</sup> port plug kit 30-0423



30-1571

### Vance & Hines Chrome Big Radius 2 Into 1

- Traditionally viewed as the kind of pipe merely designed for performance. Big Radius 2-into-1 breaks the mold, delivering white-knuckle performance with the style that has won over the motorcycle public.
- Incorporating blue-proof technology across the entire length of the pipe, Big Radius 2-into-1 will keep its showroom finish whether at the dragstrip or on the boulevard
- Includes mounts for the O<sub>2</sub> sensors as required

#### VT No. Fits

30-1586\* 1986-10 FXST

30-1571\* 2006-10 Dynaglide

\*Note: Require O<sub>2</sub> sensor plug VT No. 30-0423 on pre07 models

**Vance & Hines Short Shots** feature 1¾" header pipes with full coverage 220° heat shields that run all the way back to the end caps. Includes removable baffles and mounting hardware. Available in chrome or black.

Note: Will not fit models with kickstart.

#### Chrome Black Fits/End Type

30-1598*	1986-11 Softail Slash Cut
30-1590	30-1599 2012-up Softail Slash cut
30-1530	— 1991-05 Dynaglide Slash Cut
30-1542	2006-11 Dynaglide Slash Cut

\*Note: Pre2007 models will require O<sub>2</sub> sensor port plug kit 30-0423.



30-1517



30-1519



30-1519

**Vance & Hines Long Shots** with removable baffles.

VT No.	Style	Item/Fits
30-1517	HS	Large 2½" Full Coverage Header and Muffler, Heat Shield Scalloped Slash Ends, Hot Rod Sound, Virtually Blue Proof Fits 1986-06 Softail
30-1519	LS	1¾" Head pipe with 2¼" Muffler, 220° Full Length Heatshield, Straight Cut Ends Fits 1991-05 FXD



**Important Note:** Some items on this page may be emission-related parts subject to California or other emission control laws. Please see note on page 71 for important information regarding emission control regulatory compliance and warranty information.







# Vance & Hines Exhaust

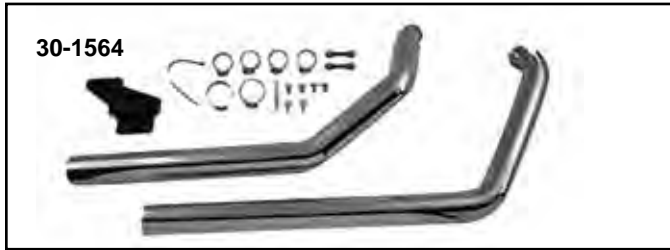

**Vance & Hines Straight Shots HS** features 2½" full coverage header and muffler heat shields. Removable baffles and mounting hardware. Fits 1986-10 FXST.

**VT No. 30-1564\***

\*Note: Pre2007 model require purchase of sensor plugs VT No. 30-0423.



**30-1566**

**Vance & Hines Side Shots** feature power chamber technology, 2½" header pipe and muffler heat shield, slash cut billet caps that have scalloped cut, and removable baffles and mounting hardware. Fit 2006-10 Dynaglide models. \*Note: Pre-2007 Models require O2 sensor plugs VT No. 30-0423.

**VT No. 30-1566**



**30-1567**

**Vance & Hines Straight Shots** feature full length/full coverage heat shields, 1¾" header pipes with 2¼" bodies, removable baffles and mounting hardware. Available in dual stagger or high/low styles. Note: Will not fit with kickstart and when mounting high/low system on FXST, FLST models use 31-0555 mounting bracket.

**Dual Stagger Style**

**VT No. Fits**

**30-1511** 1991-05 FXD

**30-1567** 2006-10 Dynaglide



**Chrome Vance and Hines Big Radius 2 into 1 Header** breaks the mold. Fits 1986-2010 FXST.

**VT No. 30-1586**



**Big Radius Exhaust**

**30-1526**



**30-1556**



**1991-05 Dynaglide**

**Vance & Hines Big Radius Exhaust** features 2½" full header and muffler heat shield system, slash cut end caps, removable baffles and mounting hardware. Include mounts for factory O2 sensors where required. Available in chrome or black finish.

**Chrome Black Fits**

**30-1534 30-1594** 2006-11 Dynaglide Models

**30-1559 30-1595** 2012-up Dynaglide Models

**30-1540\*** 1986-11 FXST, FLST Models

**30-1597** 2012-up FXST, FLST Models

**30-1556** 2007-08 FLT

**30-1572** 2010-13 FLT

**30-1573** 1999-06 FLT

\*Note: Pre 2007 models require purchase of O2 sensor plugs VT No. 30-0423.

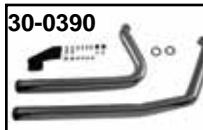

**30-0390**

**Rinehart Exhaust Systems** feature a three step header pipe that starts at 1¾" at the head, increases to 1⅞" and finishes at 2". The system has permanently mounted 2½" full length heat shields, removable

performance baffle and polished black anodized billet aluminum end caps.

**1986-06 1991-05 Style**

**FXST Dynaglide**

**30-0390** — Flush Cut

**30-0391 30-0393** Staggered



**30-1650**



**30-1651**

**Vance & Hines Super Radius 2 into 2 Pipe Set.** Super radius brings a deeper richer tone to the custom styled exhaust and is engineered for today's larger capacity engine to get solid performance and just the right sound. Features include deeper tone, full coverage heat shields and available in chrome or matte black.

**Chrome Black Fits**

**30-1642 30-1643** 2007-up FLT

**30-1644** 1986-up FXST, FLST

**30-1650 30-1651** 2000-up FXD



**Important Note:** Some items on this page may be emission-related parts subject to California or other emission control laws. Please see note on page 71 for important information regarding emission control regulatory compliance and warranty information.







# Exhaust Taper Valve

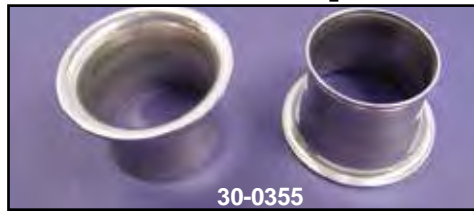

**Stainless Exhaust Taper Valves** fit into exhaust between pipe and head to put back the low end torque which is lost when large diameter or straight pipes are used. Fit Evolution models with factory or aftermarket pipes and are sold in pairs.

VT No.	Type	Material
30-0113	Machined	Stainless
30-0355	Extruded	Stainless
30-0329	Extruded	Steel



**Stainless Steel Taper Valve Kit** includes 2 pure stainless extruded sleeves to fit between pipe and exhaust port, to aid in back pressure when range outside diameter or drag pipes are used. Kit includes solid copper machined exhaust seals which will not restrict gas flow. VT No. 30-0119

## Heat Shield

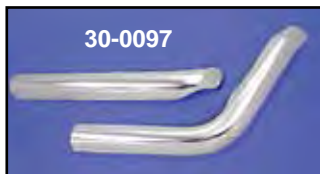

**Chrome Heat Shield Sets** fit 1986-99 FXST, 1<sup>3</sup>/<sub>4</sub>" Drag style or one piece muffler pipes, no cut out for cross tube, clamps included.

VT No.	Type	Style
30-0097	Front and Rear	Smooth
30-0337	Front	Smooth



**Chrome Crossover Heat Shield** includes two worm clamps. Fits 1980-84 FXWG. VT No. 30-0096



**Front Chrome Heat Shield** for 1986-95 FXST-FXR. VT No. 30-0134

### Heat Shields by Paughco

Front	Rear	Fits
—	30-0128	29-1165
—	30-0128	29-1108
—	30-0128	29-1107
—	30-0129	29-1106
—	30-0130	29-1100
—	30-0130	29-1101
—	30-0130	29-1102
—	30-0130	29-1164
30-0131	—	30-3158
30-0131	—	30-3210
30-0131	—	29-0088
—	30-0132	30-3163
—	30-0132	30-3164
—	30-0132	30-3155



## Exhaust Wrap

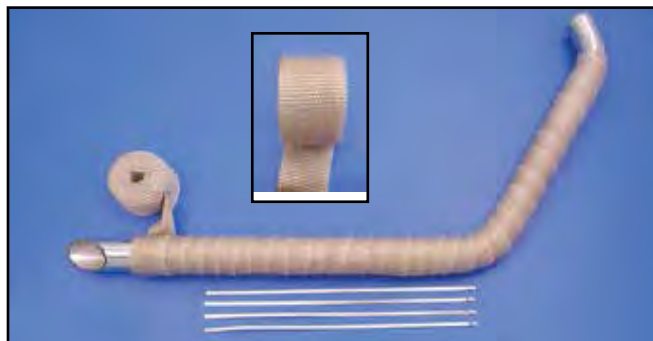

### Fiber Glass Wrap.

VT No.	Size/Color
48-0137	2" W, 25' L, Light Brown
48-0139	2" W, 25' L, Copper



**High Temperature Exhaust Wrap** reduce radiated exhaust heat. Wrap that will withstand up to 2000 degrees. Tie wraps sold available separately.

VT No.	Size	Item
48-0125	14"	Stainless Tie Wraps, 4 pack
48-0157		Stainless Wraps, 10 pack
48-0126	25' x 2"	Black Wrap
48-0127	25' x 2"	Tan Wrap
48-0131	25' x 1.5mm	White Wrap
48-0132	25' x 1.5mm	Black Wrap



**Important Note:** Some items on this page may be emission-related parts subject to California or other emission control laws. Please see note on page 71 for important information regarding emission control regulatory compliance and warranty information.





# Universal Heat Shield



Chrome Universal Heat Shields with groove or flame.

VT No.	Style	VT No.	Style
30-0321	4" Groove	30-0364	4" Flame
30-0362	6" Groove	30-0365	6" Flame

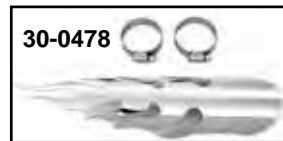
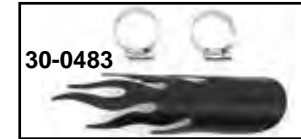
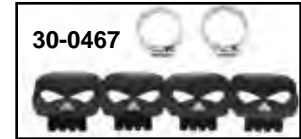
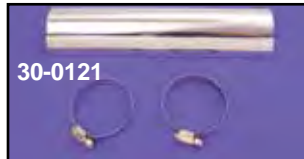

Chrome Universal Heat Shields are available for 1 3/4" or 2 1/4" straight pipes and includes mounting clamps. Sold individually.

For 2 1/4" Pipes		For 1 3/4" Pipes	
30-0120	4"	30-0122	10"
30-0474	6"	30-0123	12"
30-0121	10"	30-0124	18"

Universal Heat Shields include clamps for installation.

VT No.	#	Type	Dia.	Length
30-0109	A	Perforated	1 3/4"	9"
30-0106	B	Smooth	1 3/4"	7"

**Skull**

Chrome Black	Dia.	Length
30-3385 30-0466	2 1/4"	9"
30-3386 30-0467	2 1/4"	12"
30-0468 30-0471	1 3/4"	9"
30-0470 30-0472	1 3/4"	12"

**Flame**

Chrome Black	Dia.	Length
30-0118	1 3/4"	8"
30-0117	1 3/4"	11"
30-0481 30-0483	1 3/4"	9"
30-0482 30-0484	1 3/4"	12"
30-0473 30-0479	2 1/4"	9"
30-0478 30-0480	2 1/4"	12"



Chrome Replica 'Spoon' Style Heat Shield.

VT No.	Length
30-0221	5 1/2"
30-0245	9"
30-0834	Replica

# Exhaust Clamp

Exhaust Mount Clamps (2" and under).

VT No.	I.D.	Size Style	Length
31-3947	1"	"P" shape	Long
31-2100	1 1/2"	Hanger	Long
31-2101	1 3/4"	Hanger	Long
31-2146	1 3/4"	"P" shape	Short
31-1011	1 3/4"	"P" shape	Long
31-0816	1 7/8"	"P" shape	Short
31-2105	1 7/8"	Hanger	Long
31-2102	2"	"P" shape	Short

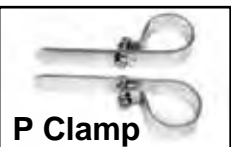
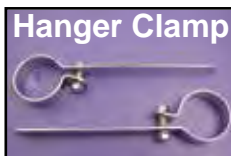

**Muffler Mount Clamps**

VT No.	I.D.	Size Style	Length
31-2120	2 1/2"	Hanger	Long
31-2106	2 1/2"	"P" shape	Short
31-2119	2 1/4"	"P" shape	Short
31-2108	3"	Hanger	Short
31-1977	3 1/2"	Hanger	Short
31-2107	2 3/4"	Hanger	Short

Chrome Muffler End Clamps. 1 5/8" for use when attaching muffler to 1 1/2" tubing.

VT No.	I.D. Size
31-0270	1 5/8"
31-2132	1 3/4"
31-2103	1 7/8"
31-2144	1 7/8" Heavy
31-1007	1 7/8" Super
31-9914	2"
31-0283	2 1/4" Narrow
31-2099	2 7/8"
31-2141	3"
31-1977	3 1/2"
31-2109	3 1/4"
31-4016*	3 1/4"
37-8683	Bolt Set

\*Note: Stainless steel sold each





Note: Baffle size denotes size of pipe into which it fits.

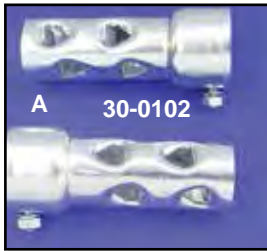

A 30-0102

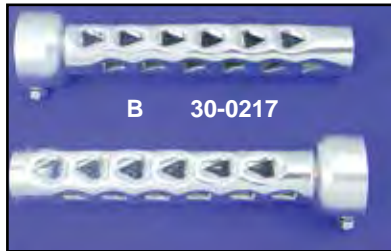

B 30-0217



A 30-0103

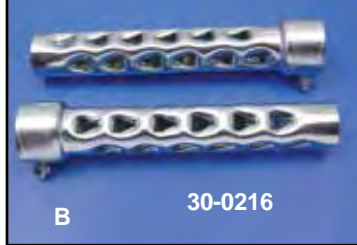

B 30-0216

Pipe Baffles fit inside straight pipes. Sold in pairs. Note: Baffle size denotes size of pipe into which it fits.

VT No.	#	Size	Length
30-0102	A	1 3/4"	4"
30-0103	A	2"	4"
30-0216	B	1 3/4"	8"
30-0217	B	2"	8"



1 3/4" Baffle Set.  
12" Long.  
VT No. 30-1403



Performance Rings fit into 2 1/4" drag pipes to create back pressure.  
VT No. 30-0050

**Features**

- Easy Installation
- Forward Mount Ring
- Burn Out Proof
- No Rattles

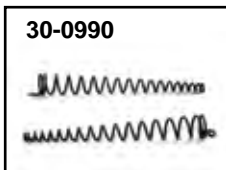
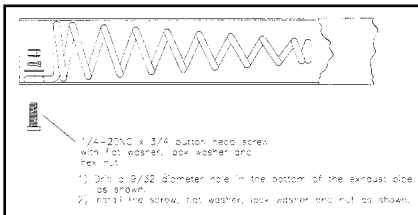

30-0990

**Power Spiral Baffles** feature the latest designs in exhaust baffle concepts. The minimum restrictive properties of the inverted cone allow for more power and yet reduce decibel number to acceptable levels. Forward mount ring at tip allow mounting of various size discs to produce required back pressure on specific applications. Flexible design allows installation into turn out ends.

Fits:	8"	12"
	1 3/4"	30-0990
	2"	30-0991
	2 1/4"	30-0988 30-0989



**Pipe Baffle** fits inside straight pipe. Baffles are like the original Snuff-or-Not, which is a washer that can be turned to baffle position. Fits 2 1/4" drag pipes.  
VT No. 30-0317

# Baffle



30-0618



30-0372

**Torque Tube Set** will fit into 2 1/4" inner diameter of straight pipe, unique shape will compress exhaust gases for more sound and less noise with added power. One 1/4" hole is required for mounting. The 4.5" long baffle.

VT No. Type  
 30-0618 Plain  
 30-0372 V-Slots



**Blunder Buss Pipe Baffle** is full 12" long steel. Sold in pairs. Note: Baffle size denotes size of pipe into which it fits.

VT No.	Size	Type
30-3180	1 3/4"	Steel
30-3181	2"	Steel
30-1405	1 3/4"	Fiberglass
30-1406	2 1/4"	Fiberglass



**Pipe Baffles** sold each. Note: Fits Cycle Shack Super Slash pipes, size 2 3/8".



30-0617

VT No. 30-0104  
**Torque Tube Set** allows variation of air flow for 2 1/4" pipes. Four Piece Set.  
 VT No. 30-0617



30-0623



30-0619



30-0624



30-0620

**Torque Tube Set** features improved baffling and back pressure for FX, XL and FXD Screamin' Eagle muffler sets, 30-0861, 30-2040

HD Type	Wyatt Pipes	Type
30-0623	30-0619	Smooth
30-0624	30-0620	V-Slots



30-0454



30-0980

**Snuff or Not** for 2 1/4" tube style baffles for added back pressure. Mount with 1/4" - 20 UNC screw.  
 VT No. Type  
 30-0454 Ring  
 30-0980 Screw





# Exhaust Gasket for Evo & TC-88



**Exhaust Port Gasket** of knitted stainless steel.

VT No.	Type	Qty
15-0227	Tapered	2
15-0267	Mesh Gasket	5
15-0712	Tapered, James	5
15-0732	Tapered	10
15-1236	James, 1999-up	2



**Crossover Tube Gasket** fits 1982-up FXR and 1991-up FXD models. Each.

**GB No. James Type**

15-1530	15-1069	FXR
15-1531	15-1076	FXD
15-1291		2003-up FXD

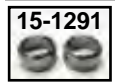

**Solid Copper Exhaust Gaskets** fit Evo models. VT No. 15-0777



**Exhaust Stud Kit** includes 4 studs and 4 flanged nuts. Fits 1984-96 Big Twin.

VT No.	Item
12-2125	Kit
12-2527	Kit
12-1187	Studs Only



**Exhaust Port Lock Kits.** Special fasteners and lock tabs secure pipes for good. Fits 1984-99 Evolution. VT No. 37-0251



**Drilled Style Exhaust Flange Clamp Set.** VT No. 30-0724



**Exhaust Flange Kit** fit Evolution 1985-up 1340 Big Twin replacing 65328-83. Kit includes snap rings and mesh gaskets.

VT No.	Item	U/M
30-0205	Kit	Each
12-0942	Snap Ring	10
15-0227	Gasket	2
15-0451	Gasket & Snap Ring Kit	Kit
15-0732	Gasket	10
12-1187	Exhaust Stud	5
30-0257	Chrome Flange Only	2
30-0563	Flange Set, Polished	2



**Exhaust Port Flange Kit** includes 2 flanges, 2 gaskets, 2 snap rings, 4 nuts, and 4 studs. VT No. 30-0420



**Chrome Exhaust Finned Flange Set.** VT No. 30-0857



**Exhaust Port Gasket Kit** includes two stainless steel knitted gaskets, two snap rings and four heavy duty flange nuts. Fits all 1985-up Twins.

VT No	Brand
15-1285	Radii
15-1274	James



**Exhaust Kit** includes four chrome cap nuts, four washers & two mesh gaskets. For 1984-99 1340 Evo model.

VT No.	Type
37-8900	V-Twin
15-0726	James



**Jims Exhaust Gasket Installer Tool** will correctly install exhaust port gaskets into cylinder heads, minimizes gasket distortion and helps heads flow better. VT No. 16-2112

## Exhaust Bracket



**FXST-FLST Exhaust Support** mounts stock or custom drag pipes to frame. Stock on FXST models, but used on Fat Boy to mount lower drag pipes. The VT No. 31-4030 can be used on 1995-up models to mount early style Porkster or Cycle Shack drag pipes.

VT No.	Type	Fits
31-3980	Chrome	1984-94 FX-FLST
31-4046	Chrome	1995-99 FX-FLST
31-4047	Chrome	1995-up FXSTF-N
31-0815	Chrome	1997-up FLSTS
31-0597	Black	2000-up Softail TC88
31-4030	Black	1984-84 FXST



**FXR Exhaust Pipe Brackets** zinc plated.

VT No.	OEM	Type
31-0189	65670-82	Front
31-0188	65671-82	Rear





# Billet Engine Mount



**Chrome Billet Top Engine Mount** fits 1948-99 Big Twin motors.

VT No.	Type
31-0709	Smooth
31-1275	With holes

## Engine Mount Bolt

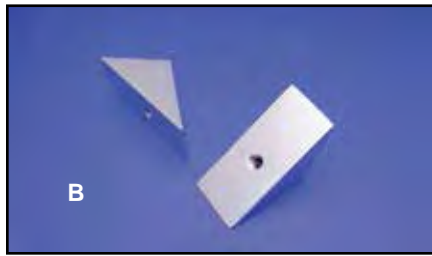
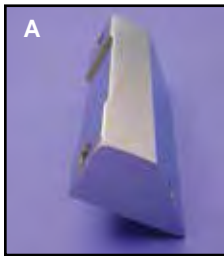

**Chrome Front Engine Mount Bolt Mount Block.** Front motor mount bolts thread into this regulator mount block.

VT No.	Type
31-0635	A
31-0739	B



**Chrome Top Motor Mount Spacer Set** for spacing out top mount or wide tire conversions. Spacers have  $\frac{7}{16}$ " inner with  $1\frac{1}{8}$ " outer diameter.

VT No.	Thickness
37-0438	$\frac{5}{8}$ "
37-0419	$\frac{3}{4}$ "
37-0419T*	$\frac{3}{4}$ " *Note: Zinc
37-0437	$\frac{1}{2}$ "

### Upper and Lower

VT No.	Years	Model	Type
9854-28	1984-99	FXST	Chrome
9855-28	1984-99	FXST	Zinc
9927-28	1984-99	FXST	Allen
9927-28-P	1984-99	FXST	Polished Allen

### Lower Only

9859-20	1989-99	FXR	Chrome
9928-20	1989-99	FXR	Allen
9928-20-P	1989-99	FXR	Polished Allen

### 1999-up Front Only

9937-20	1999-up	FXD	Chrome Allen
9936-28	1999-up	FXD	Acorn

### Lower Front

2116-15	2000-up	Softail	Chrome Allen
2117-15	2000-up	Softail	Chrome Hex
2118-15	2000-up	Softail	Zinc Hex

### Trans to Motor Mount TC-88, FXD

9934-8	1999-up	FXD	Acorn
9935-8-P	1999-up	FXD	Polished Allen



**Chrome Top Engine Mount Spacer & Bolt Kit** for offset motors.

VT No.	Thickness
37-1012	.50"
37-1013	.75"



**Chrome Allen Screw Kit** connects motor mounts, front, top and rear to frame on models listed below. Knurled.

VT No.	Fits
37-9180	1991-up Dynaglide
37-9185	1987-90 FXR
37-9186	1991-up FXR
37-9187	1984-99 Softail, 1985 FXWG-FXE
9937-20-P	1991-up FXD Front Mount



# Billet Engine Mount



31-0664



31-0667



31-0728



32-0161



32-0869



32-0867



31-0665



31-0689



31-0669  
Installed



31-0669



31-0812

**Chrome Billet Top Engine Mount Kit** includes key switch/push-button housing fits 1984-99. Order push button switches separately and tap existing holes to 8mm x 1 for button installation.

VT No.	Item
32-0867	Button Switch (2 Wire)
32-0869	Button Switch (1 Wire)
32-0161	Key Switch
31-0812	Switch Bracket

**Chrome Billet Top Engine Mount** fits 1984-99 ST models. Order related brackets separately. Coil mounts accept 2-single fire Crane or Dyna coils.

VT No.	Item	Year	Type
31-0664	Top Mount	1984-99	Evolution
31-0667	Top Mount	2000-05 Carb Only	TC-88
31-0665	Coil Mount	Without key switch hole	
31-0669	Coil Mount	With key switch hole	
31-0689	Coil Mount	With key switch hole	



**Chrome Billet Key Switch Mount** bolts to top motor mounts with 2 holes.  
VT No. 31-0726



**Billet Jockey Shifter Kit** includes top motor mount to fit 1986-99 Big Twins.  
VT No. 21-0180



**Billet Alloy Coil Mount** will attach to three bolt on 1992-up Big Twin stock motor mount to mount coil.  
VT No. 31-0699



31-0901



31-0903



31-0902

**Chrome Top Mount Kit** includes choke mount.

VT No.	Year	Model
31-0678	2000-05	Softail
31-0901	2006-up	Softail
31-0903	2006-up	Softail
31-0902	2008-up	FXWG



31-0119



31-0118

**Chrome Big Twin Top Motor Mounts** replace the stock type.

VT No.	Year	Type
31-0119	1984-89	FXR
31-0118	1984-90	FXST
12-1188	1984-99	Studs



31-0468



31-1024

**Top Motor Mount**

VT No.	Item
31-0468	80" - 100" motor
31-1024	1991-98 FXD



31-0453



31-0119

**Chrome Top Engine Mount** replaces 16216-83A. Fits 1984-89 FXR.

VT No.	Type
31-0119	Stock
31-0453	With horn and choke mount





# Steel Top Engine Mount

BIG TWIN

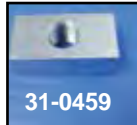

## 1984-99 FXST-FLST Chrome Mounts.

- | VT No.  | Item        |
|---------|-------------|
| 31-0219 | Mount Kit   |
| 31-0628 | Cross Strap |
| 31-1052 | Mount Set   |
| 31-0459 | Mount Block |
| 2853-6  | Mount Kit   |



**Chrome Engine Mount Set** fits 1984-99 Big Twin Evolution is a two piece design and features tab to mount coil.

### VT No. Type

- |         |       |
|---------|-------|
| 31-0657 | 2 pc  |
| 31-1265 | *2 pc |

**\*Note:** With choke switch bracket.



**Chrome Three Piece Top Mount Kit** for 1992-99 FXST-FLST, 2000-05 Softail and FLT includes choke mount.

VT No. 31-0560

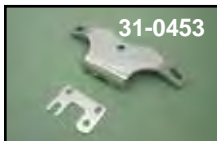

**Chrome Heavy Duty Two Piece Top Engine Mounts** are constructed of 1/4" thick steel. FXST-FXR models include horn and choke mount. Mounts have provision to direct mount two bolt ignition coils. **Note:** Fits Shovelhead or Panhead motor in Evolution Style Frame

VT No.	Year	Model
31-0212	1984-99	FXST-FLST
31-0453	1984-94	FXR



**Chrome Rectifier-Regulator Bracket Mount** fits 1976-86 FX-FL. Replaces 74533-75B.

VT No. 31-0168



## Billet Top Mount

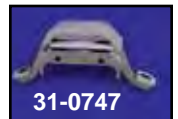

Coil not included.

**Chrome Top Motor Mount with Integral Coil Mount** provides a coil mounting that is up and behind the normal top motor mount. Mounts coil between cylinders for use with coils with central terminals such as VT No. 32-0747 spacing required for proper installation. Mounts a style of coil as shown. For Twin Cam and most Evolution coil applications, spacing maybe be required. Use cover 42-0962.

### VT No. For Motors

- |         |             |
|---------|-------------|
| 31-0747 | 80-100"     |
| 31-0746 | 101" and up |
| 32-0747 | Coil        |



# Mounts for Dynaglide



31-0574



31-0607



31-0679



31-0294



31-1050



**Chrome Teardrop Coil Cover** fits top motor mounts with two holes such as 31-0664. Matches teardrop air cleaners.  
**VT No. 42-0926**



**Chrome Finned Coil Cover** fits coil mounted on top motor mount.  
**VT No. 42-0962**

Front Mount fits 1990-up FXD.

VT No.	OEM	Item	Fits	Type	Type
31-0574	47583-90B	Mount	Front	Black	1991-2011
31-0607	47564-90B	Mount	Rear	Chrome	1991-98
31-0679	47564-99	Mount	Rear	Black	1999-up
31-0294	16258-95B	Stabilizer	Steel		1995-up
31-1050		Mount	Top	Chrome	1995-up

## Top Mount for FXR



31-0121



31-0155

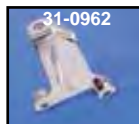

31-0962



31-0682



31-1975



31-0240



31-4065



31-4081



31-0900

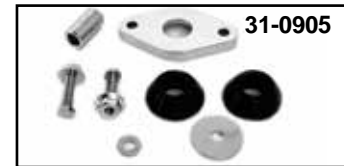

31-0905



31-0258

### 9859-20 Engine Mount Components

VT No.	OEM	Item	Finish	Fits
31-0121	16207-79B	Front Mount	Black	1979-08 FLT 1984-94 FXR
31-0155	16207-79B	As Above	Chrome	
31-0258	96210-80	Washers for Above	Zinc	
31-0240	16219-79B	Stabilizer Link	Chrome	1979-08 FLT, 1984-94 FXR
31-4065	47159-79A	Front Bracket	Chrome	As Above
31-4081	47159-08	Lower Front Brkt	Black	2009-up FLT
31-0962	16321-08	Upper Front Mt	Chrome	2009-up FLT
31-0054	16219-09	Lower Mount	Stabilizer	2009-up FLT
31-0055	16213-10	Upper Mount	Stabilizer Link, chrome	2009-up FLT

**Urethane Engine Mount** replaces the stock mount in all Big Twin with rubber mounted engines. It uses urethane formulated compounds with enhanced compression and rebound dampening properties for a 20% reduction in transmitted vibration. Fits 1982-94 FXR.

VT No.	Finish	Brand
31-1975	Black	Velva-Ride
31-0900	Black	Sifton
31-0682	Chrome	Sifton
31-0905	Chrome	Sifton



31-1983

**Chrome Engine Stabilizers** feature a steel body with a plunger with a urethane dampening which together acts as a mini-shock absorber. Fits 1979-up FL.



VT No.	Year
31-1983	1970-08
31-1274	2009-up



**Chrome Front Engine Mount Assembly** includes bracket, link and iso mount with hardware. Fits 1982-06 FLT.  
**VT No. 31-0625**



9859-20



37-0952

**Lower Engine Mount Kit** for 1989-99 FLT-FLHT-FXR-FXRS with rubber mounted engines.  
**VT No. Finish**  
**9859-20** Colony  
**37-0952** V-Twin





# Coil Cover

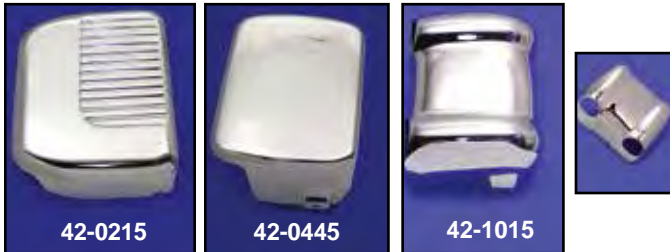

**Chrome Coil Covers.**

VT No.	Style	Year
42-0415	Smooth	1965-99 Big Twin
42-0417	Louvered	1965-99 Big Twin
42-5523	Skull	1965-99 Big Twin
42-1030	Flame	1965-99 Big Twin
42-1528	Skull	1965-99 Big Twin
42-1529	Flame	1965-99 Big Twin
42-0215	Finned	1965-99 Big Twin
42-0445	Smooth	2000-06 Softail
42-1015	Smooth	2007-up Softail
42-1076	Skull	2000-up Softail
42-1541	Flame	2000-up Softail
42-0416	Smooth	1983-94 FXR
42-0446	Smooth	1999-up FXD
42-1539	Skull	2000-05 FXD
42-1077	Smooth	2008-up FXCW
42-1080	Skull	2008-up FXCW
42-1520	Smooth	2017-up FLT



**Full Chrome Coil Cover** fits 1983-99 XL-FL.  
VT No. 42-0839

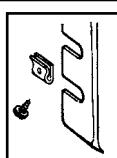

**Coil Cover and Speed Nut for Big Twins.**  
VT No. 37-1956 1985-99, Screw only  
12-0555 Nut only, 8115B



**Chrome Teardrop Coil Cover** fits top motor mounts with 2 holes such as 31-0664. Includes key switch hole.  
VT No. 42-0926

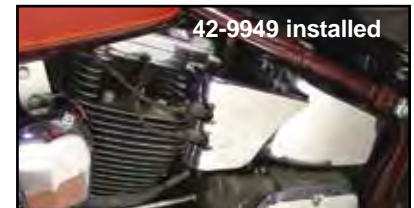

**Chrome Teardrop Coil Covers** for FXST with late molded coils. Fits 1984-99 FXST-FLST.  
VT No. 42-9949



**Chrome Coil Covers** fit single fire coils, in stock location.  
VT No. Year Model  
42-0486 1984-98 FXD  
42-0487 1984-99 Evolution Softail



**Stainless Coil Side Panels** attach to 1985-99 coils.  
VT No. 42-0039



**Chrome Fined Coil Cover** fits coil mounted on top engine mount.  
VT No. 42-0962





# Replica Dual Fire Ignition Coil



**Chrome Stock Coil** bolts original brackets. Fits 1984-89. Replaces 31614-83.  
VT No. 32-0512



**Volt Tech Molded Coil** features black late shape with bobbin type windings. Fits 1983-99. Replaces 31614-83  
VT No. 32-0511



**Blue Streak 45,000 Volt Coil** provides more spark and energy than stock coil

and the higher voltage eliminates spark deterioration at peak RPM.



**Volt Tech Dual Fire 80 KV Coil** mounts to stock locations.  
VT No. 32-0095



**Andrews Coils** for electronic ignition systems. The coil produce more voltage than stock coils. 1985-99, 2.8 ohms.

VT No.	Years	Type	Ohms
32-0171	1980-99	Electronic	2.7
32-0769	2000-06	Electronic	2.7

**Single Fire:** Just the spark plug for the piston that is in its compression stroke will be fired. The other piston, being in its overlap position will not be ignited.  
**Dual Fire:** Both spark plugs are fired simultaneously at the time only one piston is in its compression stroke.  
 This is the way the stock motor works on pre TC-88 engine.  
**Single Plug:** One spark plug in each head. Total of 2 spark plugs in one engine.  
**Dual Plug:** Two spark plugs in each head. Total of 4 spark plugs in one engine.

VT No. 32-0712

## Single Fire Coil



**Volt Tech Molded Coil** features black late shape with bobbin type windings. 2000-up replacement coil with OE style connectors.

VT No.	OEM	Year	Type
32-1233	31639-95	1995-98	EFI
32-1234	31639-99	1999-01	EFI
32-0743	31655-99	2002-06	(VT) Carb
32-1065	As Above	Dynatek	
32-0812	31743-01	2002-06	(VT) EFI
32-1066	As Above	Dynatek	
32-0585	31696-07A	2007-up	(VT) EFI
32-1085	As Above	2007-up	EFI
32-0978	31684-08	2008-up	FXCW
12-0586	7638	Coil Stud Nut	

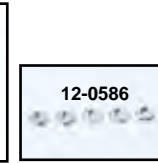

## ACCEL Ignition Coils



**Accel Dual Fire H.V. Super Coil.** High performance bolt on for electronic ignition systems. High-tech molding for exact fit on 1965-99. 2.3 ohms.

VT No. Type  
32-7772 Yellow  
32-7801 Chrome



**Relocation Bracket** is constructed of stainless steel.  
VT No. 31-0725



**Accel Single Fire Super Coil** features ultra fast coil rise time with voltage output 45% higher than stock and 3.0 ohms of primary resistance. Mounts to stock coil bracket and fits under stock coil covers on 1980-99 Twins.

VT No. Type  
32-0090 Yellow  
32-7802 Chrome



**Coil Bracket** fits touring model, 2002-up.  
VT No. 31-0841



**Accel High Energy Dual Fire Coil** is a very high KV energy output requires that it be used with our



extreme service 8.8mm silicone racing wires. Each coil is complete with two 8.8mm wire

leads and appropriate chrome brackets.

VT No.	Item
32-0132	Kit 1965-87
32-7536	Wires only



**The Accel Stealth Coil** eliminates the need for ignition wires forever by mounting the coils directly to the spark plugs for maximum spark energy to the plugs. An aluminum finned cover holds the coil in place and acts as a functional heat sink to pull heat away from the cylinder heads. All wiring is hidden in the fins of the head for a clean, custom look. Available with nature or black finned heat sink.

**Natural Black Fits**

- 32-1141 32-1140 2002-08 All FLT models with EFI
- 32-1142 32-1143 2001-up All FXST models with EFI, 2009-up All FLT models with EFI
- 2004-up All FXD models with EFI



Accel Floor Mat  
VT No. 48-0201



**Important Note:** Some items on this page may be emission-related parts subject to California or other emission control laws. Please see note on page 71 for important information regarding emission control regulatory compliance and warranty information.





32-0484

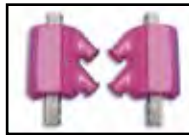

32-0589

V-T Angle Coil Sets are 3 Ohm Type.

VT No.	Fire	Ohm
32-0484	Single	3
32-0589	Dual	3

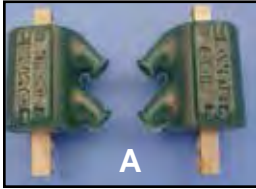

A



32-8055



32-7792

**DYNA**

**Dyna**  
DC6-5 All FXR-FXST and Dynaglide models  
DC6-4 Dual Spark Plug Head Application

**Dyna Coils.** 35,000 volt! Works with all points ignitions, aftermarket or factory electronic ignitions. Note: 32-7792 is electronic, 32-7793 is for points ignition.

VT No.	#	Volt	Ohm	Dyna	Type	U/M
32-7789	A	12V	3	DC-1	Angle, Dual	Pair
32-7790	A	6V	1½	DC-2	Angle, Dual	Pair

Use 2 for dual plug heads

32-7792	C	12V	3	DC-6	Stock, Dual	Each
32-7793*	C	12V	5	DC-7	Stock, Dual	Each
32-8055	B	12V	3	DC-3	Angle, Single	Pair
32-8086	A	12V	5	DC-8	Angle, Dual	Pair
32-9035	B	12V	5	DC-10-1	Angle, Single	Pair

\*Note: Use 2 for single fire ignition.



**Twin Tec 3 Ohm Single Fire Mini Coil Kit** features compact design 2.4" x 2.3" x 1.6" (not including terminals and tower) and is compatible with most single fire ignition systems. Kit includes two coils, universal wire set and terminal ends.

VT No. 32-1015

**Single Fire:** Just the spark plug for the piston that is in its compression stroke will be fired. The other piston, being in its overlap position will not be ignited.  
**Dual Fire:** Both spark plugs are fired simultaneously at the time only one piston is in its compression stroke. This is the way the stock motor works on pre TC-88 engines.  
**Single Plug:** One spark plug in each head. Total of 2 spark plugs in one engine.  
**Dual Plug:** Two spark plugs in each head. Total of 4 spark plugs in one engine.



# Ignition Coil



32-0467



32-0474



32-0484

**V-Tech™ Single Fire Coils** features 45 kv with 1 spark for each cylinder as fired and will mount to stock bracket and accept stock type coil covers. Works with most aftermarket single fire ignition systems. Volt wire from ignition switch is connected to center post along with red wire from ignition.

VT No. Finish

32-0467 Black

32-0474 Chrome

32-0484 Orange

2. Connect the black wire to outer post from front cylinder.
3. Connect the white wire to other outer post for rear cylinder.



**45 KV Coil Kit** includes coil and cover. To mount on stock 1984-99 Softail.

VT No. 32-0749



32-9285



32-9264

**Dyna Twin Fire Ignition Coils**

are designed to work with Dyna 2000 HD-I ignition modules. Twin

fire coils are slightly larger than stock coils and fit the stock mounting bracket. Twin fire coils can be used with any electric advance ignition system that incorporates dwell control, except Dyna DS6-2 or similar type ignitions.

VT No. Dyna Ohms/Type

32-9285 DC6-5 3 (A) Twin Fire II Miniature Dual Output Towers, Replaces DC6-3

32-9264 DC6-4 3 (B) Four output towers Fits Dual Spark Plug



32-9341



32-9342



32-9343



32-9344

**Dyna 0.5 Ohms Miniature Coils for TC-88.** These coils are designed for use with Dynaglide TC-88 series ignitions and should not be used with Dyna S Ignition Systems. TC-88 mini-coils feature dual or single output towers, .5 ohms primary resistance, measure 4.2" x 2.3" x 1.6", mounting centers of 2.9" minimum to 3.5" max and black housing.

VT No.	Output Type	U/M	Dyna#
32-9341	Dual	Pair	DC11-1
32-9342	Dual	Each	DC11-2
32-9343	Single	Pair	DC12-1
32-9344	Single	Each	DC12-2



**Important Note:** Some items on this page may be emission-related parts subject to California or other emission control laws. Please see note on page 71 for important information regarding emission control regulatory compliance and warranty information.







# Spark Plug



**V-Twin Performance Spark Plugs** features a copper core electrode for a longer service life, nickel plated housing, 95% pure alumina insulator and a heat crimping process to ensure a leak free seal.

**VT No. Fits**

- 32-6691** 1999-up Twin Cam
- 32-1395** As Above Nickel
- 32-6692** 1984-98 Evolution
- 32-6693** As Above One Heat Range Hotter
- 32-6694** As Above One Heat Range Colder

**OEM#**

- 6R12
- RGHCC
- 5R6A



**Accel Spark Plug Set** is U-Groove features a U-shaped electrode, sintered alumina insulator and a copper/nickel alloy electrode. Gap is .040. Fits 1975-81 FL-FX Evo.

**VT No. 32-0144**



**Champion Copper Plus.** Sold in 4 pack unless noted. Spark Plug gap measures .040.

VT No.	Engine	Fits	HD#	Copper Plus Champion
<b>32-7547</b>	TC-88	1999-up FL-FX	6R12	.RA8HC
<b>32-7540</b>	Evo	1984-up FL Evo 1340 1985-up FX Evo 1984 FXR	5R6A	.RN12YC
<b>32-0160</b>	Shop Pack of 24			RN12YC



**Autolite Platinum Plugs.**

VT No.	Autolite#	Fits
<b>32-9231</b>	AP4265DP2	1984-up 1340cc V-2 Evolution
<b>32-9232</b>	AP4164DP2	1999-up TC-88

**Autolite Standard Spark Plugs**

10 Pack Pair	Autolite#	H-D#	Fits
<b>32-9295</b> —	4164	6R12	1999-up TC-88
<b>32-9297 32-9298</b>	4265	5RL, 5R6 5A6A	1984-up All V-2 Evolution

# Spark Plug Cover

## Chrome Covers



**Chrome Head and Spark Plug Cover** fits 1986-99 Evolution models. Covers are held in place by rubber inserts supplied.

**VT No. 42-0929**



**Sparkies** are chrome die cast covers to fit perfectly on a spark hex for Big Twin 14mm, pair.

VT No.	Years
<b>37-8952</b>	1948-1999
<b>32-1670</b>	1999-2012



**Blue Lightning Bug Spark Plugs** are neon gas filled and glow as strobe lights. Fit plugs with screw terminal fittings only, sold in pair.  
**VT No. 32-1552**



**Chrome Big Twin Case Trim** fits Evolution 1985-99 1340 Big Twin by mounting to center case stud. To install adjust stud length for more length on left side, then press emblem over nut and attach by chrome acorn nut which is supplied.

**VT No. 42-0746**

**Single Fire:** Just the spark plug for the piston that is in its compression stroke will be fired.  
**Single Plug:** One spark plug in each head. Total of 2 spark plugs in one engine.  
**Dual Plug:** Two spark plugs in each head. Total of 4 spark plugs in one engine.





# Ignition Points Cover

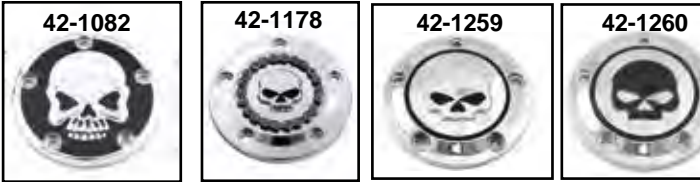
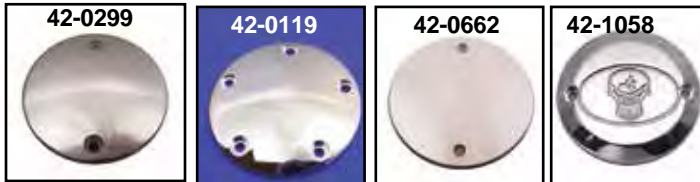

42-0956

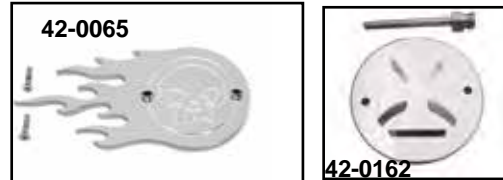

2-Hole	5-Hole	Style
42-0748	42-0969	Flame, chrome
42-0106	42-0889	Live to Ride, chrome
42-0088	42-0836	Live to Ride, gold inlay
42-0177	42-0178	Baron, chrome
42-0035	—	V-Tech
42-0299	42-0119	Dome
42-0662	42-0146	Flat
42-1058	42-1059	Skull
42-1078	42-1079	Skull
42-0065	—	Flame
42-0155	42-0125	Smooth
42-0960	42-0044	Maltese, flat
—	42-0961	Maltese, raised
42-6100	42-6055	Maltese, raised
42-0081	42-0075	3D Skull face
42-0560	42-0562	3D Skull, black
—	42-1082	Skull, chrome, black highlights
42-1176	42-1178	Skull, chrome
42-1116	42-1259	Chrome w/chrome skull
42-1125	42-1260	Chrome w/black skull
42-1095	—	Black smooth
42-0581	42-1119	Black, perforated
42-0474	42-1122	Black, flames, natural aluminum
42-0475	42-1123	Black, ball milled
42-0189	42-1093	Chrome, perforated
42-0198	42-1094	Chrome, contour
42-1145	42-1096	Chrome, ball milled
42-1166	—	Skull with chrome skull
42-6055	42-0472	Chrome, flame
42-1384	42-0473	Black, flame
42-1383	42-0197	Smooth, black
42-1385	42-0196	Smooth, chrome
42-1381	42-1144	Grooved, chrome
42-0956	42-1145	Grooved, black
—	—	Grooved, chrome
—	—	Grooved, black
—	—	Iron cross spinner
—	42-0957	Hidden mounting
—	42-0461	Chrome with black mesh flame
—	42-0462	Chrome with black mesh skull
—	42-1381	Chrome air flow
—	42-1382	Black air flow
—	—	Chrome air flow
—	42-1389	Chrome domed nostalgic
—	42-1390	Black domed nostalgic
8765-2	—	Screws, 1978-up allen
8402-2	—	Screws, chrome acorn



# Spark Plug Wire



**Accel 8.8mm Custom-Fit Ignition Wire Sets** are available in 300+ or custom fit.

**8.8 mm**

300+ Black	Custom Yellow	Black	Type/Fits
32-9101	32-0656	32-8044	1984-90 all FXST, 1985-86 FX, 1991-99 Dynaglide
32-9103	32-0658	32-8048	1982-94 FXR-FXRS-FXRT
32-9107	—	—	1985-90 FLT-FLHT
32-9106	32-9021	32-9022	1991-99 all FXST
32-9107	32-9023	32-9024	1985-99 all FLT
32-9109	—	—	2000-up all Dynaglide
32-9111	—	—	2000-up all FXST
32-9110	—	—	2000-up all FLT
32-9108	—	—	1994-98 FLHR



**8 mm Blue Streak XXX Silicone Wire Sets** features quality construction of silicone throughout the jacket, insulation and core. This assures high temperature resistance and high durability. Silicone wire sets also offer maximum RFI suppression.

Copper core wire sets are for point type ignition systems only and feature a copper core wire to allow for special improved electrical conductivity and mechanical strength. All wire sets are supplied with electrical boots and OEM style terminals that lock onto the spark plug.

VT No.	XXX Silicone Sets	8 mm
32-0253	Universal Application	Self Make Kit
32-0254	1980-84 FLH, 1985-99 FXST, 1991-98 FXD	
32-0255	1985-96 FLT, FLHT, FLHR	
32-0256	1982-99 FXR	
32-0258	1997-98 FLHT, FLHR	
32-0259	1999-up FLT, FLHT, FLHR	
32-0260	1999-up Dynaglide	
32-0262	2000-up FXST	



**42" Accel 8.8 Wire Sets** have the ends terminated with a 90° or a variangle boot and come with a hardware kit which includes terminals, boots and instructions.

VT No.	Color	Type
32-9248	Black Variangle	Suppression
32-9250	Black 90°	Suppression
32-9252	Yellow Variangle	Suppression
32-9253	Yellow Variangle	Copper
32-9254	Yellow 90°	Suppression
32-7536	Yellow 90°	Copper



**Accel Thundersport 5mm Ignition Wire** features half the diameter of stock wire and is extremely flexible. Easy to run through cylinder heads, rocker covers and frame tubes for a hidden look. Packaged with two 5 foot leads, coil ends and 90° spark plug end. Coil end must be terminated. These wires are a 5 mm high gloss silicone wire that is rated for over 550° F and 150 ohms per foot.

VT No.	Color
32-9360	Black
32-9361	Yellow
32-9362	Red
32-9363	Blue



**Accel Floor Mat**  
VT No. 48-0201



**Spark Plug Wire Clamps** available in pairs for 7mm or 8mm.

Chrome Size
37-9062 7mm
37-2911 8mm

## Timing Plug



**Timing Plugs** are available in stock size 5/8"-18 thread unless noted as oversize which is 1 1/16" - 16 thread.

**A.** Acorn style plug fits all Big Twin timing plug holes and oil tanks.

VT No.	Finish
7106-1	Chrome

**B.** Acorn style plug with oversize thread & one tap for rethreading stripped out timing hole.

VT No.	Type
7500-2	Plug and Tap (Oversize)
7501-1	Plug Only (Oversize)
9407-1	1 1/16"-16 Tap (Oversize)

**C.** Stock timing plug.

VT No.	Finish
8114-1	Chrome
8115-1	Cadmium
9404-1	Cadmium (Oversize)
9304-1	Chrome (Oversize)
9714-1	Parkerized (Oversize)
9502-1	Chrome 1939-51
9504-1	Parkerized as above, 7/8" Hex
9503-1	As above Cadmium

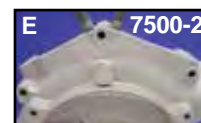
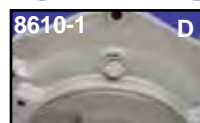

**D.** Functional and custom design plug fits all Big Twin models and Sportster timing plug holes and oil tanks.

8610-1	Chrome
8611-1	Cadmium
E.	Allen style plug for use on all 1970-up. Replaces 720.
9402-1	Chrome
9403-1	Cadmium
37-9206	Chrome by Gardner Wescott
9960-1	Chrome (Oversize)



**Clear Timing Plugs** available as a long optically clear type or a short standard version with or without the internal hex.

VT No.	Type	U/M
16-1731	Long Type	Each
16-0829	Hex Type	Each
16-0099	Standard	10 pack
16-0160	Standard	Each





# Spark Plug Wire Set

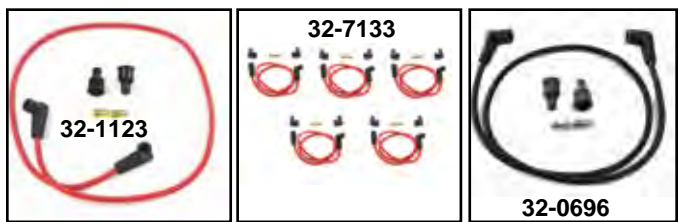

**Universal Wire Sets** are 40" long with double 90° spark boots. Simply cut to the desired length and install coil terminal clips supplied. Available in copper or suppression core.

- |               |              |                |
|---------------|--------------|----------------|
| <b>VT No.</b> | <b>Color</b> | <b>Type</b>    |
| 32-0647       | Yellow       | Suppression    |
| 32-0648       | Yellow       | Copper         |
| 32-0650       | Orange       | Copper         |
| 32-0651       | Black        | Suppression    |
| 32-1123       | Red          | Suppression    |
| 32-7133       | Red          | Copper, 5 pack |
| 32-0696       | Black        | Copper         |

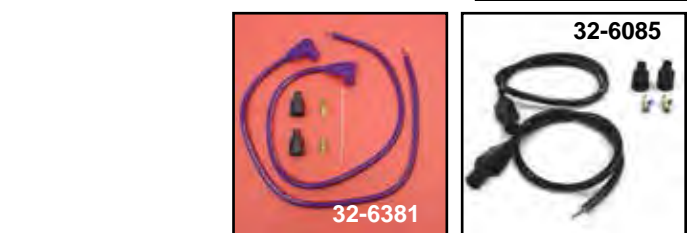

**Universal 8mm Pro Spark Plug Kits** feature 24" wire leads with either 90° or 180° molded plug boots and straight coil boots with brass terminals. Wires feature the Spiro-Pro design which provides 10 times the firepower of carbon core wires and heat protection to 600°F. Works with electronic or points style ignition. All wires have a resistance factor of 350 ohms/ft. Great for magnetos, distributors or dual plug heads.

- |                 |                  |
|-----------------|------------------|
| <b>90° Kits</b> | <b>Color</b>     |
| 32-6081         | Black            |
| 32-6281         | Red              |
| 32-6481         | Yellow           |
| 32-6681         | Blue             |
| 32-6381         | Purple           |
| 32-6085         | Black (180° Kit) |



**Sifton 8mm Universal Wire Set** features carbonite suppression core cut to 2 24" lengths.

- |               |              |
|---------------|--------------|
| <b>VT No.</b> | <b>Color</b> |
| 32-1041       | Red          |
| 32-1042       | Black        |



**Sumax Colored 8mm Plug Wires by Taylor** are pre-cut and have the plug/coil boots and terminals already installed. Designed for electronic ignition, but work great on point types.

Color	1984-99 FXST FXD	1982-94 FXR	1980-98 FLT	2000-up FXST- FLST- FXD	1999-06 FL with Carb Only	1999- 08 FLT with EFI	2009-16 FLT
Red	32-7231*		32-7233	32-2023	32-2024	32-2015	32-2017
Purple				32-2033			
Blue	32-7631*			32-2063	32-2064		
Black	32-7031*	32-7035	32-7033	32-2003	32-2004	32-2016	32-2018
Yellow	32-7431*			32-2043	32-2044		

\*Note: with coil adjacent to oil tank Dynaglide.



**Sumax Thunder Volt 50 Black Wire Sets** feature a ferrite spiral wound coated core that is a blend of copper/nickel alloy bonded by a conductive acrylic latex cover. This process is designed to reinforce and assist in holding core resistance to 50 ohms. The fat 10.4 mm (.409") wires also feature three layers of pure zimplex silicone, 600 degrees of heat protection, 102,000 volts dielectric strength with a tightly woven heat treated fiberglass braid and black pro boots bonded to the black with gold lettering wires.

- |              |               |                                     |
|--------------|---------------|-------------------------------------|
| <b>8.2mm</b> | <b>10.4mm</b> | <b>Fits</b>                         |
| 32-5202      | 32-0031       | 1984-99 FXST, 1991-98 Dynaglide     |
| 32-5206      | 32-0033       | 1980-98 FLT                         |
| 32-5207      | 32-0035       | 1984-94 FXR                         |
| 32-5208      | 32-5608       | 24" Universal 2 Piece with 90° boot |
| 32-5204      | 32-2032       | 1999-08 FLT with carburetor         |
|              | 32-2031       | 2000-up FXST, 1999-up Dynaglide     |
| 32-5209      | 32-5200       | 2009-16 FLT                         |
| 32-5205      | 32-5203       | 1999-08 FLT with Fuel Injection     |
| 32-5210      |               | 12" Universal                       |



**Important Note:** Some items on this page may be emission-related parts subject to California or other emission control laws. Please see note on page 71 for important information regarding emission control regulatory compliance and warranty information.







# Carb Ignition Advance Unit



**Blue Streak Sifton "Tuneable" Ignition Advance Assembly** includes stainless advance base, points plate with "Blue Streak" points and condenser with hardware and 3 pairs of color coated springs which allow full advance at 1400, 2000 and 2600 RPM depending on which spring is selected.

**VT No. 32-0713**



**32-9037**

**Competition Advance Unit** by Rivera Competition features machined stainless steel shaft and plate, metallic coated weights and special wound springs for exact advance. For 1970-84, mechanical advance applications. Center screw included.

**VT No. 32-9037**



**32-9220**



**32-9261**

**Tuneable Advance Unit** features stainless base, heat treated weights cam bolt and 3 different color coded spring sets which allows full advance at 1400, 2000, and 2600 RPM depending on which springs are selected. Can be used with all ignitions, points, single or dual fire types which utilize an advance unit. Springs also available separately.

VT No.	Type
32-9220	Stock
32-9261	Needle Bearing
13-0121	Stock Springs, Black
13-9246	Heavy
13-9247	Severe

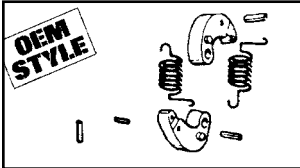

**OEM STYLE**

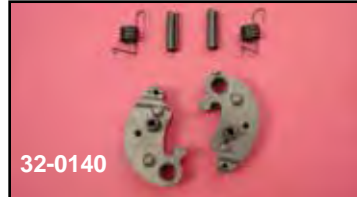

**32-0140**

**Automatic Advance Rebuild Kit** includes two springs, two weights, and roll pins. For all 1970-78 Twins.

**VT No. 32-0140**



**Battery Eliminator** allows operation of Magneto models without battery and boosts spark voltage when starting and prevents light flickering at low engine speed.

**VT No. 32-0548**

### Warranty

All Electrical Components sold as individual pieces or in kits are covered under our warranty "Replacement Only" Provision. All electrical related item part numbers begin with a 32 prefix. No credit will be issued for these items as they are exchange only.



**32-7773**



**32-0136**



**32-0150**

**Points Conversion Kit.** Both brands include everything necessary for direct replacement on 1970-78 Big Twin, 1971-78 Sportsters or for converting late model electronic-type back to points. Accel type available with microchip points, which will require a domed shaped points cover such as VT No. 42-0299 to accommodate taller points. The V-Twin unit includes stock style points and condenser. 32-0150 available with needle bearing weights.

VT No.	Item	Type
32-7773	Accel with Microchip	Stock
32-0136	V-Twin with Points	Stock
32-0150	V-Twin/Points	Needle



### Points Plate Screws.

VT No.	Type
32-0760	Stainless
32-0049	Zinc



**Stainless Advance Unit** features stainless base, heat treated weights and cam center screw for 1970-up mechanical advance ignition.

VT No.	Item	Brand
32-0178	With Bolt	Sifton
32-0168	Without Bolt	V-Twin



**32-7510**

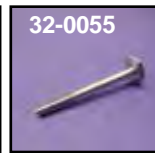

**32-0055**

**Advance Units** feature heat treated weights and steelbase. Order center bolt separately.

VT No.	Type
32-7510	Advance
32-0055	Center bolt



**32-0156**



**32-0157**

**Blue Streak Premium Parts** for 1970-78 Twins.

VT No.	Item
32-0156	Points
32-0157	Condenser



**13-9247**

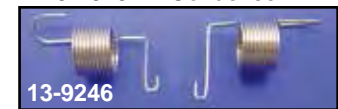

**13-9246**

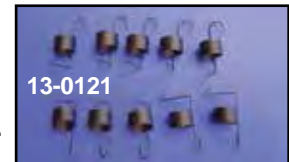

**13-0121**

### 1970-up Advance Weight Springs.

VT No.	Fits
13-9247	Severe Duty Advance Weight Springs are for all high compression and heavily modified engines. Also useful for applications experiencing detonation (pinging) or very erratic idle, sold as a pair
13-9246	Heavy Advance Weight Springs for slightly modified stock, low compression or mild stroker application, helps cure minor idle problems, sold as pair
13-0121	Original type replacement. Uses premium grade spring steel, 10 pack



# Daytona Twin Tec Carb Ignition

BIG TWIN



**Daytona Twin Tec Internal Ignition Kit** for 1984-99 Evolution Big Twin, 1970-84 Shovelhead Big Twin and 1971-97 Sportster models. Kit includes ignition, coil and spark plug wire set.  
**VT No. 32-3015**



**Daytona Twin Tec External Ignition Kits** for 1990-98 Evolution Big Twin and 1990-97 Sportster models. Kits include module, coil and spark plug wire set.

VT No.	Fits
32-3017	1990-94 Evolution
32-3018	1995-98 Evolution
32-1036	1984-99 Evolution



**Twin Tec Internal Ignition** for 1970-97 models. Two advance curve families with adjustable advance slope accommodate stock to highly modified engines. Features digitally set RPM Limit (100 RPM Steps) and selectable single or dual fire mode. Coil outputs protected against short circuits.

VT No.	Item
32-1005	Ignition
32-2013	3 Ohm Single Fire Coil



**Crane H1-4N Multi Function Performance Ignition** features one piece machined aluminum housing, BCD switches with solid detent and legible markings, which allows easy adjustments of mode. Advance rate and rev limit, single or dual fire operation and initial timing marks that allows precise adjustment. Fits 1970-99 XL. Also available as an ignition kit which includes HI-4N ignition, single fire coil and 8.5 mm plug wire set.

VT No.	Item
32-1731	HI-4N Ignition
32-1732	HI-4N Kit

**Daytona Twin Tec TC-88 Ignition Kits** for all 1999-up TC-88 carbureted Big Twins include module, coil and spark plug wire set.

VT No.	Fits
32-3088	1999-02 (Does not include software and cable)
32-3089	2003-up (Includes software and USB cable)

**Unilite Breakerless Ignition System** for all 1970-99 Twins. Dual fire unilite module features integrated photo coupler, signal processor and power switch. Requires mechanical advance assembly and ignition coil with 3.0 to 4.0 ohms.

VT No.	Item
32-5119	Ignition System
32-7510	Mechanical Advance

**45 KV Single Fire Coil Kit** includes coil and cover to fit 1984-99 Softtail models.  
**VT No. 32-0749**



**Daytona Twin Tec External Single Fire Ignition Conversion Kit** includes 50 state street legal selectable ignition module, sensor plate, rotor cup and adapter harness that allows use of tachometer and single fire coil. Allows use of external ignition on all 1970-1999 carbureted only Big Twins and 1971-2003 XL models. Helps prevent heat related ignition failures by replacing heat sensitive internal nose-cone style ignitions. Also available as complete kit with correct 3.0 ohm single fire coil and plug wire set.

VT No.	Item
32-3047	Conversion Kit
32-3048	Complete Conversion Kit with Coil and Wires



**Important Note:** Some items on this page may be emission-related parts subject to California or other emission control laws. Please see note on page 71 for important information regarding emission control regulatory compliance and warranty information.







# Ignition Kit and Advance Unit



**Self Learning Module** from Accel helps regain control of fuel injected bike. Improves mileage while increasing power and torque, while reducing emissions. It works on all stock and mildly modified. Automatic recalibration-optimizing modifications gains expected from performance exhausts, air cleaners and camshafts. Easy installation-direct plug-in connections to factory throttle position, crank shaft position and oxygen sensors. Self learning-module seamlessly compensates for changing loads, weather conditions and altitude while you ride; no need for costly dyno tuning sessions or downloading new calibration maps to a laptop computer. Smoother running engine-eliminates pop and bang associated with a mis-programmed ECU due to intake or exhaust modifications, the need to re-flash the factory ECU has been eliminated, truly a plug and play proposition.

VT No.	Accel No.	Fits
32-1700	SLM01	95-04 Touring*, 01-04 Softail* 02-04 Dynaglide*, 02-07 V-Rod

Kit includes one O2 sensor and one O2 sensor bung to be welded in.

32-1702	SLM03	08-11 V-Rod
32-1703	SLM04	06-11 Dynaglide 07-11 Softail 07 Touring

Kit utilizes factory installed O2 sensors

32-1704	SLM05	08-09 Touring with "throttle by wire"
---------	-------	---------------------------------------



**Accel Late Model Super Coil** for late model Twins with carburetor. Features faster rise time, higher voltage, maximum spark and energy to spark plugs for quicker starting, improved idle and crisper throttle response. Fits in OEM loca-

tion and is available in black finish. Fits 2000-02 FXST-FLST, 2000-05 FXD, 2002-06 FLT with carburetor.

VT No. 32-1810



**V-Tech Ignition Kits** are available in **dual fire** where there are two sparks at the same time and **single fire** where there is one spark for each cylinder when it is fired, separately. Each kit includes a mechanical advance unit and all hardware. Order coil separately VT No. 32-0467 coil has two separate coils inside to fire independently.

VT No.	Type	Coil
32-0468	Dual Fire	32-0511
32-0469	Single Fire	32-0467

**Ignition Wire Chrome Clamps.**

VT No.	Type
37-9014	Points
37-9015	Electronic



**V-Tech™ Single Fire Coil** gives one spark for each cylinder as fired and will mount to stock bracket and accept stock coil cover.

VT No.	Finish
32-0467	Black
32-0474	Chrome



**Ignition Sensor Plate Assembly.**

VT No.	OEM	Fits
32-9020	32400-80A	1980-93 FLT, 1980-94 FXR 1984-95 FXST
32-0518	32404-90	1991-95 FXD
32-0519	32400-94	1994-95 FLT

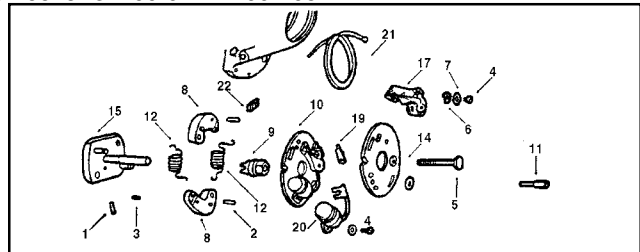

**Advance Unit Rebuild Parts.**

VT No.	OEM	#	Item
32-7510	32505-78A		Rotor and Weight Assembly
12-1163	615	1	Roll Pin Breaker Plate
12-1164	620	2	Roll Pin Breaker Weight
12-1162	623	3	Roll Pin, Breaker Plate
12-1152	8699		Pop Rivet for Cover
37-8809	1047,7115 6189W	4	Point Mount Plate Washer and Screw Assortment
32-0055	3570	5	Timing Screw
32-0138	32522-70	8	Weight Set
32-0053	32542-70A	9	Cam only
32-0549	32577-70	10	Breaker Base Assembly
32-0051	32601-78	11	Plate Mount Stud 1970-81 Colony, Zinc
2745-2	As Above		
32-0049	32606-82	11	Plate Mount Stud 1982-up
32-0054	As Above	11	Oversize with 12/24 threads for Stripped out Covers
13-0121	32605-70	12	Springs
32-0042	32618-70A	14	Mount Plate only
32-0118	32661-70	17	Ignition Point
32-0411	32670-70	19	Terminal Kit
32-0121	32726-30A	20	Condenser and Bracket
32-1557	70456-73	21	Point Lead Wire
37-8971	10046	22	Point Lead Wire Clamp



**Important Note:** Some items on this page may be emission-related parts subject to California or other emission control laws. Please see note on page 71 for important information regarding emission control regulatory compliance and warranty information.







**Unilite Breakerless Ignition System** for all 1970-99 Twins. Dual fire unilite module features integrated photo coupler, signal processor and power switch. Requires mechanical advance assembly and ignition coil with 3.0 to 4.0 ohms.

- VT No. Item**  
**32-5119** Ignition System  
**32-7510** Mechanical Advance



**Crane Hi-4** fits all 1970-98 carbureted models and requires sensor cup for 1982 and earlier applications. Order tachometer interface, sensor cup and screw separately if required. **Note: Order Coils Listed Below**

- VT No. Fits**  
**32-0588** 8.5 mm Wire Set  
**32-9087** Sensor Cup, replaces 32402-83  
**32-9052** Cup Screw, replaces 2611C

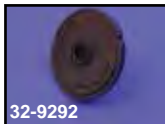

**Crane Cams Hi-Intensity Ignition System** converts early, points type 1970-79 Big Twin to electronic ignition. On 1980 and later models it will replace stock electronic ignition, external module and rev limiter. Kit includes Hi module stand off screws and hardware. Order VT No. 32-7510 advance weight unit separately.

- VT No. Item**  
 Single module/dual fire/single coil for a dual fire ignition system that replaces the stock point and condenser type ignition. Can be used with stock coil.  
**32-9291** Rotor for above  
 Dual module/single fire/single or dual coil when being used as single fire/single plug requires a coil. When used as dual plug applications VT No. 32-9225 coil must be used.  
**32-9292** Rotor for above  
**32-7510** Advance unit



**Crane Coils** are available in high intensity for dual fire and mount to stock brackets.  
**VT No. 32-9225**

**Single Fire:** Just the spark plug for the piston that is in its compression stroke will be fired. The other piston, being in its overlap position will not be ignited.  
**Dual Fire:** Both spark plugs are fired simultaneously at the time only one piston is in its compression stroke.  
 This is the way the stock engine works on preTC-88 motors.  
**Single Plug:** One spark plug in each head. Total of 2 spark plugs in one engine.  
**Dual Plug:** Two spark plugs in each head. Total of 4 spark plugs in one engine.

# Carb Models Ignition Module



**Accel Single/Dual Fire Ignition Module.** Fits all carbureted 1970-2000(except TC-88) and all 1971-up Sportster models, works in both single or dual fire applications and features 14 tuneable advance curves from stock to full performance, adjustable rev limiter, VOES input, tachometer output and front cylinder static time LED. Requires sensor cup for installation.

- VT No. Item**  
**32-0091** Accel Single/Dual Fire Ignition Module  
**32-9087** Sensor Cup



## S&S Spark Technology Ignition System

features an ECU module that will automatically adjust ignition timing. When detonation is detected by knock sensor, the ECU retards the ignition timing to prevent engine damage. When detonation is not present, ignition timing is advanced for maximum power and economy. Additional features include: Simple installation--plugs into stock harness. No timing adjustments, 7000 RPM rev limiter, single fire operation, automatic dwell adjust, short circuit and reverse polarity protected.

### Installation Kit for carbureted models

- 32-7805** 2004-2006 TC-88  
**32-1012** 1999-2003 TC-88  
**32-1049** 1995-1999 Evolution Big Twins



### Crane HI4TC Ignition for TC88

**Carbureted Engine Modes** offers multi-spark performance, variable advance curves, and a digital rev limiter. It is a plug-in replacement of the stock module and is compatible with the factory security system. A crankshaft position sensor is employed to establish accurate firing. Rear cylinder timing can be offset from -5° to +4°; the same for initial timing. Both are easily adjusted by means of rotary switch on the unit. An additional rotary switch is used to select the advance curve, with choice of ten families. This enables the ignition to optimize the performance potential of the Twin-Cam 88® in any stage, from stock to wildly modified. Rotary switches also control the built-in Sequential Rev Limiter, which is adjustable from 1,500 to 9,900 RPM, and won't cause "popping and banging" like conventional rev limiters. Benefits of multiple spark system include easier starting (hot or cold), better low speed driveability and off-idle response. It pulses up to nine sparks per cycle at idle and three sparks up to 6,000 RPM, which also stops spark plug fouling and lean-surge. Fits 2004-up.

**VT No. 32-3180**

**Note:** When using HI-4 Single Fire Ignition with "Dual Plug Cylinder Heads", two dual fire coils must be used (Crane Cams #8-3002 or 8-3006). Both the spark plug wires from one coil will go to the front cylinder, while both plug wire from the other coil will go to the rear cylinder.



**Important Note:** Some items on this page may be emission-related parts subject to California or other emission control laws. Please see note on page 71 for important information regarding emission control regulatory compliance and warranty information.





# Ignition



**Dyna 2000 Digital Ignition Systems.** Systems include Dyna 2000 HD-1 Ignition Module and a matched Dyna Twin Fire Coil for each application.

VT No.	#	Fits
32-0802	SFK-3	1995-up FXR, FLT, FXST, FXD
32-0804	SFK-1	Pre1995 FXR, FLT, FXST, FXD
32-9118		Programming Software for 32-0802
32-9117		Programming Software for 32-0804

**V-Tech Ignition Systems** fit all 1970-98 carbureted models and requires sensor cup for 1982 and earlier applications. Order tach interface, sensor cup and screw separately if required. **Note: Order Coils As Required.**

**VT No. Fits**

**32-9501** Dual Fire Ignition fits Evolution, Shovelhead and Sportster through 1997. It can be set for Street or Race-Electric Start or Kick Starter. Includes 4000 to 8000 adjustable RPM limiter and adjustment for rate of advance. This unit is compatible with stock dual fire coils.

**32-9500** Single Fire Ignition fits Evolution, Shovel and Sportster through 1997. It can be set for Street or Race-Electric or Kick Starter includes rear cylinder timing adjustment for rate of advance. Compatible with single fire coils.

**32-9503** Single Fire Ignition Kit fits As Above Includes coil and 8.5mm wires.

**32-0588** 8.5mm Wire Set

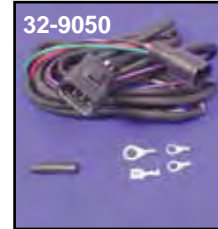

**Dyna 2000 Ignition Modules Replacement** can be used with stock electronic ignition.

**Note:** The stock ignition consist of a sensor plate and rotating cup. The 2000 will work on all 1970-up models but requires the 1983-up type ignition cup and sensor plate. The 2000 Advance curves will not work properly if installed with the pre1983 ignition cup and sensor. Dyna 2000 HD-1 can be used with both single fire (separate coils) or Dual fire (Single Coil). The Dyna 2000 HD-2 can be used as dual fire only.

**Both units** feature programmable advance curves, rev limiter and LED diagnostic lamp for easy static timing and plugs into stock harness and bolts to stock module location. Also available with USB port that will allow mechanics or tuners more advanced programming but requires separate purchase of Dyna Programming kit. **Note:** Can only be used with suppression spark plug wires. On 1984-90 models Dyna extension harness must also be used.

**Notes for installation:**  
**32-9501**  
 Red = Positive (coil)  
 Black = Negative (coil)  
 Brown = Tach  
 White = Topped Up (not used)  
 Green = Voës (vacuum switch)

**Notes for installation:**  
**32-9500**  
 Red = Positive (coil)  
 Black = Negative (front cylinder coil)  
 White = Negative (rear cylinder coil)  
 Green = Voës (vacuum switch)  
 Brown = Tach



Dyna	Application
DC6-5	All FXR-FXST and Dynaglide models
DC6-4	Dual Spark Plug Head Application



**Dyna Twin Fire Ignition Coils** are designed to work with Dyna 2000 HD-1 ignition modules. Twin fire coils are slightly larger than stock coils and fit the stock mounting bracket. Twin fire coils can be used with any electric advance ignition system that incorporates dwell control except Dyna DS6-2 or similar type ignitions.

VT No.	Dyna	OHms/Type
32-9285	DC6-5	3 (A)Twin Fire II Miniature Dual Output Towers, Replaces DC6-3
32-9264	DC6-4	3 (B) Four output towers Fits Dual Spark Plug

VT No.	Item/Plug	Years
32-9112	Dyna 2000 HD-1E 7 Pin With USB Port	1984-95
32-9113	Dyna 2000 HD-2E 7 Pin with USB Port	1984-95
32-9114	As Above with USB Port	
32-9115	As Above with USB Port	
32-1074	DD2000-HD7EFI 2010-16 FLT with EFI	
32-1075	DD2000-HD8EFI 2007-11 FXST, FLST with EFI	
32-1076	DD2000-HD9EFI 2012-up FXST, FLST with EFI	
32-9050	Extension Cable	
32-9085	7-8 Pin Conversion Harness	
32-9087	Ignition Cup Only	
32-9020	Sensor Assembly	
32-9052	Cup Screw, 10 pack	
32-9117	Programming Software for 32-9112, 32-9113	
32-9118	Programming Software for 32-9114, 32-9115	
32-9119	Programming Software for TC 88-2P	

**Dynatek Fusion EFI Ignition Module**

VT No.	Years	Model
32-1166	2002-06	FLT
32-1167	2007	FLT
32-1168	2008-13	FLT
32-1169	2014-16	FLT
32-1170	2001-06	FLST, FXST
32-1171	2007-11	FLST, FXST
32-1174	2012-up	FLST, FXST
32-1175	2004-05	FXD
32-1176	2006-11	FXD
32-1177	2012-up	FXD



**Sensor Cup Kit** includes special screw to fit all "Sensor" type ignition kits. Fits 1995-up. **VT No. 32-9124**



**Important Note:** Some items on this page may be emission-related parts subject to California or other emission control laws. Please see note on page 71 for important information regarding emission control regulatory compliance and warranty information.







# DYNA Ignition

BIG TWIN



**Dyna 'S' Hi-Performance Ignition System** is self contained, fits behind ignition cover, uses magnetic rotor with the original spark advancer, so factory advance curve is

maintained. Improves performance, extends spark plug life, eliminates points and condensers.

**Note:** For dual plugged heads, on 1980-up use advance mechanism, VT No. 32-7510

**VT No. 32-7778** (DS6-1)



**Dyna 'S' Single Fire Ignition** has the features of the Dyna 'S', but fires front and rear cylinders independently of

each other which allows accurate timing of each cylinder. Stock ignition systems fire both cylinders at the same time which has the wasted sparks on the exhaust stroke. This eliminates this inherent problem. For use with either dual or single plug heads. On 1980-up models, use VT No. 32-7510 Advance assembly.

**VT No. 32-7777** (DS6-2)



**32-9151**



**32-9151**



**32-9152**



**32-9153**

**Dyna 2000i Digital Ignition** available as a module only or complete kits that include correct coil. Features include single or dual fire operation, 8 advance curves, built in tach driver, adjustable RPM limit from 6000 to 7500 and easy static timing with built in timing indicator. Fits all 1970-98 carbureted models and requires 1983-up sensor cup for 1982 and earlier applications. Advanced Programming Software allows the mechanic or tuner the ability to fine tune 2000i Ignition but requires adapter.

VT No.	Item	Plug	Fire	Coil
<b>32-9151</b>	Kit	Single	Single	DC3-1
<b>32-9152</b>	Kit	Dual	Single	DC1-1
<b>32-9153</b>	Kit	Dual	Dual	DC2-1
<b>32-9155</b>	Kit	Single	Single	DC6-5 DC6-5

**32-9159** Miniature coil

**32-9087** Module Only

**32-9052** Sensor Cup

**32-9052** Cup Screw, 10 pack

**32-9120** Advanced Programming Software for

Above Ignitions

**32-9121** Software Adapter Harness



## Dyna S Performance Ignition Systems.

Available in dual or single fire for street applications only. Each kit includes sensor plate assembly and correct coil for each application. Single plug only. 1980-up applications require 32-7510 advance mechanism.

VT No.	#	Type
<b>32-0800</b>	DSK-6-2	Single Fire
<b>32-0801</b>	SDK-6-1	Dual Fire



### Replacement Rotor for Dyna Ignitions.

VT No.	Fits
<b>32-9300</b>	DS-6-1
<b>32-9301</b>	DS-6-2



**A 32-7789**



**32-7790**

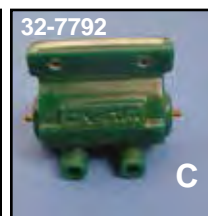

**32-7792**



**32-7793**

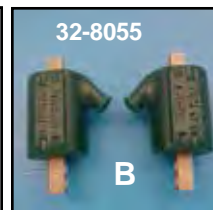

**32-8055**



**32-8086**

**K.V. Recommends the following coils for Dyna Ignitions:**  
**DS6-1 Ignition VT No. 32-7778**  
 Street, Single plugs use DC-7 or DC-8  
 Race, Single plugs use DC-1 or DC-6  
 Street/Race Dual plugs use 2 DC-2 or DC-5, wired in series  
**DS6-2 Ignition VT No. 32-7777**  
 Race, Single plugs use 2 DC-3  
 Street, Dual plugs use 2 DC-7 or DC-8  
 Race, Dual plugs use 2 DC-1 or 2 DC-6  
 Street, Single plug uses 2 DC10-1



**32-9035**

**Dyna Coils** generate 35,000 volts and work with all points ignitions as well as aftermarket or factory electronic ignitions. Note: 32-7792 is electronic, 32-7793 is for points ignition.

VT No.	#	Volt	Ohm	Dyna	Type	U/M
<b>32-7789</b>	A	12V	3	DC-1	Angle, Dual	Pair
<b>32-7790</b>	A	6V	1 1/2	DC-2	Angle, Dual	Pair
Use 2 for dual plug heads						
<b>32-7792</b>	C	12V	3	DC-6	Stock, Dual	Each
<b>32-7793*</b>	C	12V	5	DC-7	Stock, Dual	Each
<b>32-8055</b>	B	12V	3	DC-3	Angle, Single	Pair
<b>32-8086</b>	A	12V	5	DC-8	Angle, Dual	Pair
<b>32-9035</b>	B	12V	5	DC-10-1	Angle, Single	Pair

Use 2 for dual plug heads

**\*Note:** Use two for single fire ignition.



**Dyna Ignition Booster** is for single points systems only. It transforms inconsistent electrical surges into controlled bursts of energy so that the coil power is not wasted.

**VT No. 32-7787**



**Dyna Electric Tachometer Adapter Kit** must be used with Dyna 'S' single fire ignition is installed on any twins when electric tachometer is used.

**VT No. 32-7799**





# EFI Components



**Power Commander V Fuel and Ignition Timing Control** for each cylinder in a new smaller enclosure. Rev Xtend feature increases stock rev limiter. Switch between two maps "sent on the fly" can be adjusted on a "per gear" basis and allows for one map per cylinder per gear if required. Adjustment of fuel and timing is based on engine temperature provided by the cold start feature. Will power up with USB cable only for programming. **Note:** Not legal for use on pollution controlled vehicles.

VT No.	Fits
32-0842	2007-11 FXST-FXCWC-FLSTF
32-0843	2009-11 FLSTC/FLSTN (plastic mount tray included)
32-1960	2009 FLT
32-1961	2009 Dynaglide
32-1962	2010-13 FLT
32-1039	2012 FXST, FLST
32-1043	2012 Dynaglide
32-1048	2013-up Dynaglide

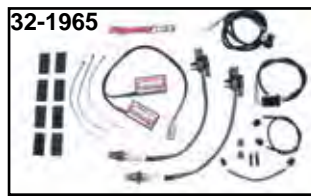

**Automatic Tune Kit** for all HD PC-V Power Commanders plugs

directly into the PC-V with a single cable. It includes power connector that plugs into a bike's harness. Rider can specify what air/fuel ratio to make each RPM and throttle position combination. Base settings are included and fully adjustable. Fits 1996-99 FLT. **VT No. 32-1965**

### Emissions and Noise Regulations

#### Important Information:

**Disclaimer:** The California Air Resources Board (CARB does not permit the use of aftermarket emission-related parts) that alter the performance of OEM emission-related devices unless CARB has issued an executive order, other than on racing vehicles on closed course. Check your local laws and manufacturer's information.

**Disclaimer:** Emission related parts for OEM Non-emission control system equipped motorcycles as well as slip on mufflers that mount downstream of and which do not alter the performance of OEM emission-related devices, are considered legal replacement parts by CARB. More California exhaust information is available a [www.arb.ca.gov](http://www.arb.ca.gov).

**Disclaimer:** Aftermarket products, including but not limited to exhausts, fuel, air controllers, air filter kits, camshafts and carburetors and jet kits which alter, modify, or replace emission control devices or systems of an originally compliant highway motorcycle, are not legal for sale or street use in California unless they have been issued a CARB Executive Order. Aftermarket emissions related products which have not been issued an Executive Order or which are not aftermarket Replacement Parts, as defined in Title 13, California Code of Regulations, Section 1900 (b)(2), are authorized for closed circuit race use only. Products shown may be designed, manufactured, intended and sold for closed circuit race use only and use of the same on public roads or lands may be a violation of local, state and/or federal laws. See manufacturer's information and state and local laws to determine what is authorized for your use on your vehicle.

**Disclaimer:** Products shown may not conform to federal, state or local noise regulations.

**Warranty Disclaimer:** There is no warranty on exhaust pipes and mufflers with regard to any discoloration. Discoloration (blueing) is caused by tuning characteristics, i.e. cam timing, carburetor, etc. and is not caused by defective manufacturing.

**Disclaimer:** Check your applicable laws and manufacturer's publication(s) and/or website(s) for manufacturer's warranty, maintenance, safety, mounting and any regulatory compliance/non-compliance information.



**Power Commander III USB Engine Management Systems** are for fuel injected models and allow for both fuel and ignition adjustments. Each unit includes a specific map, designed to improve performance over stock. The Power Commander includes IBM compatible link cable and software package which allows you to fully map the fuel ignition curves on IBM compatible computers. If a computer is not available, the fuel curves can be adjusted by using three touch buttons on the face plate.

VT No.	Year	Model	VT No.	Year	Model
32-3001	1997-98	Evolution Big Twins	32-3011*	2006	TC-88 Dynaglide
32-3005	2002-06	V-Rod	32-3012*	2007	FLT
32-3008	2004-05	TC-88 Dynaglide	32-3013*	2007-up	FXST
			32-3014*	2007-up	Dynaglide
			32-3037	2008	FLT

\*Note: Includes O<sub>2</sub> eliminators.



**Vance & Hines Fuel Pak** is a throttle position sensor based system that simplifies the process of fuel injection tuning. It enables you to fine tune the fuel mixture throughout

the entire RPM range. No computer or software is required. Simply punch in the values supplied with the fuel pak. Requires use of high performance air cleaner. Order parts for Softail.

VT No.	Fits
32-0293	2007-up FXST/B/C SSE, 2007-08 FLSTF
32-0292	2002-07 FLT, FLHT, FLHR
32-0294	2008-10 FLT, FLHT, FLHR
32-0295	2011-16 FLT, FLHT, FLHR



**DynoJet Power Vision Flash Tuner** offers the latest flash tuning technology and data logging. Includes a full color touch screen flash device, vehicle interface cable, and winPV. Types of tunes that are deliverable to your bike are pre-configured, which are loaded on the device from DynoJet. When using the pre-configured tunes, this device will identify the ECM strategy, stock calibration, and sort the tune files. Custom tunes option can be loaded or emailed to you by a custom tuner, or a copy of your stock tune can be used. The tuner holds any combination of the three types, but up to six tunes. Fits 2001-10 FLST, 2004-11 FXD, 2001-10 FLST, 2002-13 FLT.

**VT No. 32-1056**



**Caution:** These products are not legal for sale or use in California on pollution controlled vehicles. These products are intended for non-highway only.





**Twin Tec TCFI Fuel Injection Kit** for 2001-11 TC-88 with Delphi Fuel Injection System includes plug in fuel injection controller, PC link, interface cable, Wego wide band exhaust gas oxygen sensor and weld nut for exhaust pipe. The TCFI solves tuning problems with highly modified engines. Features a fully programmable plug in replacement for Delphi Controller which allows programming of advance curves, idle air control including idle RPM and cold start characteristics. The TCFI communicates diagnostic information by blinking codes on the check engine LED. The unit also has built in data logging that stores data for the last 15 minutes of operation. Fits all 2001-up.

**\*Note** Oxygen sensor must be installed in rear exhaust pipe.

VT No.	Item
32-1004	TCFI2D-Kit
32-1016	TCFI3D-Kit
32-1017*	TCFI3D-Kit

**\*Note:** Same features as 32-1016 with the addition of extended data logging and diagnostics.



**Vacuum Switch Assembly**

VT No.	OEM	Fits
32-9079	26557-83	1984-90 All FXR
32-9080	26558-84	1984-90 FXST 1986-89 All FLT
32-9083	26566-91	1991-95 All FXST-FLST, Dynaglide and FXR



**Ignition Module Adapters** allow use of seven pin module (1991-93) going to eight-pin Deutsch (1994-99) wiring harness or an eight pin module going to a seven pin harness. Cannot be used on electronic fuel injected models.

VT No.	Fits
32-0085	7 Pin Adapter to 8 Pin Module
32-0086	8 Pin Adapter to 7 Pin Module

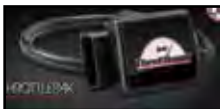

**Vance & Hines Throttle Pack** designed for throttle by wire, the throttle pak improves the responsiveness of your engine by eliminating the factory programmed electronic lag. Compatible with any exhaust system or fuel tuner. Easy plug-in installation into the throttle body. This throttle pak modifies the speed and degree of the throttle body opening the throttle plate. Fuel curve and timing curve are not affected.

**VT No. 32-1035**

# Ignition Modules



**Twin Tuner II** features all the same function as the original Twin Tuner and includes ignition timing control capability. Easily adjust the OEM fuel injection controller and ignition to math the requirements of performance parts. Allows the use of the up and down buttons to make fuel trim adjustment and the valve is displayed on LED board also has advanced mode that will allow the tuner to make precise adjustment to each cylinder. Requires optional USB interface cable VT No. 32-3045 Compatible with Twin Scan II Turning Aid. VT No. 16-0378

VT No.	Fits
32-3042	2001-2011 FXST, FLST, FXD with 36 pin Delphi
32-3043	2012-up FXST, FLST, FXE with can data bus
32-3044	2008-16 FLT with 73 pin Delphi
32-3045	Optional USB Interface Cable



**Twin Tec External Ignition for 1999-06 Carbureted Twin Cam Models.** Wide timing advance adjustment range accommodates stock to highly modified engines. Features digitally set RPM Limit (100 RPM Steps). Selectable multi-spark mode for quick starting and smooth cruise. Coil outputs protected against short circuits. Billet aluminum housing with black anodized finish. Easy plug-in installation supports all sensors including theft/security module.

VT No.	Years
32-1008	1999-03 TC-88 Carburetor Only
32-1014	2003-06 TC-88 and XL Carburetor Only



**Twin Tec External Plug In Ignition for 1990-99 Evolution Big Twins** features 4 rotary switches used to set the operating modes such as single or dual fire, adjust the timing, advance and select RPM limit. Two diagnostic LED's indicate status and start of the VOES switch. The status LED is also used for static timing as it will flash when the engine reaches top dead center.

VT No.	Item
32-1006	1990-94 with 7 pin Connector
32-1007	1995-99 with 8 pin Connector



**Caution:** These products are not legal for sale or use in California on pollution controlled vehicles. These products are intended for non-highway only.







# EFI Replacements



**Dyna Tek FI Controller** is a plug module that offers 3 user selectable base fuel curves that are designed to improve engine operation and can be modified to suit a wide variety of modifications. Fuel mixture can be enriched or leaned as required. The Dyna FI controller uses the factory connectors for easy installation and there is no PC required for tuning or adjusting the fuel curves. There are no modifications required to the stock ECU and removing the Dynaglide FI controller returns the vehicle to the factory configuration.

- | VT No.  | Fits                  |
|---------|-----------------------|
| 32-3021 | 1997-98 FLT Evolution |
| 32-3022 | 1999-01 FLT TC-88     |
| 32-3023 | 2002-05 FLT TC-88     |
| 32-3025 | 2006 FLT              |
| 32-3026 | 2006-FXST             |
| 32-3027 | 2006 FXD              |
| 32-3032 | 2007 FLT              |
| 32-3033 | 2007-09 FXST          |
| 32-3034 | 2007-09 FXD           |
| 32-3138 | 2008 FLT              |
| 32-3139 | 2009 FLT              |
| 32-3046 | 2001-08 FXST          |



**EFI Replacement and High Flow Fuel Injectors.** Sold in flow matched sets of two injectors and includes detailed test report of injectors performance. \*Note: Not legal for sale or use in California or on any pollution controlled vehicles.

VT No.	Flow Rating (gm/sec at 58 psi)	Max HP for E10 at 60% Duty Cycle	Max HP for E85 at 80% Duty Cycle	Spray Angle (Degrees)
<b>Injectors for 2001-2005 FLT, FXST, FLST, FXD w/Delphi EFI</b>				
32-1365	4.5	95		25
32-1366	5.4	115		25
32-1367	6.2	130	95	25
32-1368	7.1	150	110	25
<b>Injectors for 2006-15 FXST, FLST, 2006-07 FLT, 2006-16 FXD (Except V-Rod™ and Sportster®)</b>				
32-1369*	3.9	85		25
32-1370	5.4	115		25
32-1371	6.2	130	95	25
32-1372	7.1	150	110	25
32-1373	7.8	165	120	25
*Note: Replacement for OE 277709-06A				
<b>Injectors for 2008-up FLT, 2016-up FXST, FLST, 2017-up FXD electronic throttle control models</b>				
32-1374	5.4	115		18
32-1375	6.2	130	95	18
32-1376	7.1	150	110	18
32-1377	7.8	165	120	18

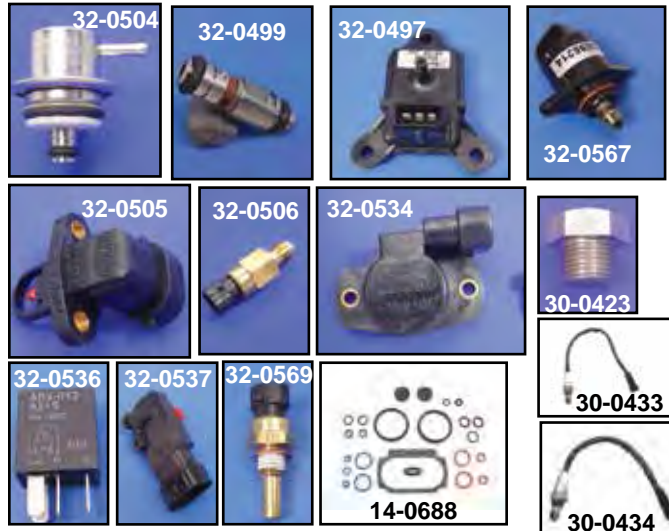

**Fuel Injection Replacement Parts** for 1995-up EFI (Electronic Fuel Injection) systems.

- | VT No.  | OEM       | Item  |
|---------|-----------|---|
| 32-0504 | 27219-95  | Fuel Pressure Regulator 300 KPA                   |
| 32-0495 | As Above  | 350 KPA   |
| 32-0499 | 27609-01  | Fuel Injector                                     |
| 32-0498 | As Above  | High Flow   |
| 32-0497 | 32424-95  | Barometric Pressure Sensor 100 KPA                |
| 32-0496 | As Above  | 250 KPA   |
| 32-0494 | 27628-01  | Idle Air Control Motor                            |
| 32-0567 | 27658-06  | Idle Air Control                                  |
| 32-0505 | 27270-95  | Air Temperature Sensor                            |
| 32-0506 | 32446-99  | Engine Temperature Sensor                         |
| 32-0534 | 27629-01  | Throttle Position Sensor                          |
| 32-0568 | 27659-06  | Throttle Position Sensor                          |
| 32-0535 | 27135-97  | Fuel Injector                                     |
| 32-0536 | 31511-01A | Relay with Diode                                  |
| 32-0537 | 32316-99  | Map Sensor  |
| 32-0569 | 32315-01  | Coolant Temperature Sensor                        |
| 14-0688 | —         | Gasket and Seal Kit                               |
| 30-0423 | 66054-06  | Oxygen Sensor Plug                                |
| 30-0434 | 27719-07  | Oxygen Sensor XL                                  |
| 30-0433 | 27683-07  | Oxygen Sensor 2007-12 FXD, 2007-11 FXST, 2009 FLT |
| 30-0487 | 27703-08  | Oxygen Sensor 2009-up V-Rod                       |
| 30-0431 | 27729-10  | Oxygen Sensor 2010-up FLT Front                   |
| 30-0489 | 32700005  | Oxygen Sensor 2012-up FXD, FXST, FLST Front       |
| 30-0490 | 32700006  | Oxygen Sensor 2012-up FXD, FXST, FLST Front       |
| 30-0432 | 27809-10  | Oxygen Sensor 2010-up FLT rear                    |



**Fuel Valve Pressure Regulator Housing** fits 2002-07 FLT, 2001-2007 FLST, FXST. Replaces OEM # 62373-01.  
VT No. 35-0017



**Oxygen Sensor Sealing Washer**  
VT No. Year Size  
15-0081 2006-10 18 mm  
15-0012 2011-up 12 mm

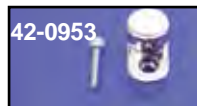

**Chrome Crank Sensor Cover** includes mount screw. 1999-up FXD-FLT.  
VT No. 42-0953



**Caution:** These products are not legal for sale or use in California on pollution controlled vehicles. These products are intended for non-highway only.







**Daytona Twin Tec TCFI Gen 5 Auto Tune Fuel Injection controller** is fully programmable plug in replacement for the 36 pin controller with CAN data bus used.

- Continuously auto-tunes fuel curves for front and rear cylinders under actual riding conditions with WEGO IIID dual channel wide-band oxygen sensor interface.
- Robust alpha-N (throttle position and RPM based fuel control eliminates problems with long duration/high overlap camshafts.
- Extended data logging and diagnostics. DataFLASH memory stores full 60 minutes of operating data at 10 samples/second.
- Powerful Windows software for custom programming and extending data logging and diagnostics.
- The TCFI solves tuning problems with highly modified engines. High-end automotive racing application use ALPHA-N (throttle position and RPM based) fuel control. ALPHA-N eliminates any dependence on manifold pressure and if unaffected by long duration/high overlap camshafts. The TCFI bring this prove technology to the market places.
- Idle air control including idle RPM and cold start characteristics are fully programmable. This facilitates the use of aftermarket throttle bodies with higher air flow.
- Includes TCFI Gen 5 fuel injection controller, USB interface for PC link, WEGO IIId dual channel wide-band exhaust gas oxygen sensor interface, two Bosch LSU 4.2 wide-band exhaust gas oxygen sensors, and two 18 x 1.5mm weld nuts for the exhaust pipe.

Fits 2012-up FXST, FLST, FXD.

**VT No. 32-7402**



**Daytona Twin Tec TCFI Gen 4 Auto Tune Fuel Injection Controller** is fully programmable plug in replacement for the 36 pin Delphi controller with J1850 data bus.

- Quickly auto-tune fuel curves for front and rear cylinder on a dyno or on-road with new WEGO IID dual channel wide band oxygen sensor interface.
  - Fully programmable plug-in for 36 pin Delphi® controller with J1850 data bus.
  - Powerful Windows software for custom programming and data analysis
  - Full support J1850 data bus used for communications with turn signal/security module (TSM/TSSM) and instrument cluster
  - Support for new 6th gear indicator.
  - Extended data logging and diagnostics. DataFLASH memory stores full 60 minutes of operating data at 10 samples/second.
  - Programmable user input and output.
  - Billet aluminum housing with black anodized finish
  - Easy plug-in installation
  - Supports all sensors including theft/security module
- Includes TCFI Gen 4 plug-in fuel injection controller with billet aluminum housing with black finish, dual channel wide band exhaust gas oxygen sensor interface, two Bosch LSU 4.2 wide band exhaust gas oxygen sensors, and two 18 x 1.5mm weld nuts for exhaust pipes. Quickly auto-tune fuel curves for front and rear cylinders on a dyno or on-road. The robust alpha-N fuel control eliminates problems with long duration/high overlap camshafts. Windows software provides custom programming and data analysis. Its full support for J1850 data bus used for communications with turn signal/security module and instrument cluster.

\*NOTE: Not legal for sale or use on pollution controlled vehicles.

**VT No. Fits**

- 32-7400** 2001-11 FXST, FLST, FXD; 2001-07 FLT
- 32-7401** 2007-up Sportster

# Daytona Twin Tec Ignition Controller



**Twin Tuner Fuel Injection Controller** for 2008-11 FLT models. Features include increased horsepower, improved throttle response, easy plug-in installation and setup; can be used with Dynojet Power Commander Maps and is compatible with Twin Scan II service tool VT No. 16-0378. The Twin Tuner allows you to easily adjust your fuel injection to match the requirements of performance parts. You can add or subtract fuel by using the mode and up/down push button switches.

**VT No. Fits**

- 32-3038** 2008-11 FLT with 73 pin Delphi EFI
- 32-3039** 2001-10 FXST, FLST, FXD with 36 pin Delphi EFI
- 32-3040** 2012-up FXST, FLST, FXD
- 32-3041** 2011 FXST



## V-Thunder Products for Evolution Electronic Fuel Injected models

VT No.	Description	Year
<b>32-0718</b>	Injection Overdrive™ (A)	1995-96
<b>32-0719</b>	Injection Overdrive™ (A)	1997-98
<b>32-0730</b>	Includes VTE 2700P and V-Thunder Fuel Injected Cam	1997-98

### Important Information:

#### Emissions and Noise Regulations

**Disclaimer:** The California Air Resources Board (CARB does not permit the use of aftermarket emission-related parts) that alter the performance of OEM emission-related devices unless CARB has issued an executive order, other than on racing vehicles on closed course. Check your local laws and manufacturer's information.

**Disclaimer:** Emission related parts for OEM Non-emission control system equipped motorcycles as well as slip on mufflers that mount downstream of and which do not alter the performance of OEM emission-related devices, are considered legal replacement parts by CARB. More California exhaust information is available a [www.arb.ca.gov](http://www.arb.ca.gov).

**Disclaimer:** Aftermarket products, including but not limited to exhausts, fuel, air controllers, air filter kits, camshafts and carburetors and jet kits which alter, modify, or replace emission control devices or systems of an originally compliant highway motorcycle, are not legal for sale or street use in California unless they have been issued a CARB Executive Order. Aftermarket emissions related products which have not been issued an Executive Order or which are not aftermarket Replacement Parts, as defined in Title 13, California Code of Regulations, Section 1900 (b)(2), are authorized for closed circuit race use only. Products shown may be designed, manufactured, intended and sold for closed circuit race use only and use of the same on public roads or lands may be a violation of local, state and/or federal laws. See manufacturer's information and state and local laws to determine what is authorized for your use on your vehicle.

**Disclaimer:** Products shown may not conform to federal, state or local noise regulations.



**Caution: These products are not legal for sale or use in California on pollution controlled vehicles. These products are intended for non-highway only.**



# Regulator Cover



**Chrome Voltage Regulator Cover** features open center grill to allow for cooling of regulator.

**VT No. Fits**

**42-0927** 1989-99 Softtail models (VT)

**42-0079** 2001-09 Softtail Models (VT)

**42-0685** 1991-03 FXD (VT)



**Chrome Regulator Mount Hardware Kits.**

**VT No. Fits**

**37-9257** 1976-84 FX-FL, 1984-95 Softtails, 1991-95 Dynaglide, Allen

**37-9258** 80-95 FXR-FLHT, Allen

**2046-8** 2000-up Softtail, Allen

**2046-8-P** 2000-up Softtail, Polished Allen

**2047-4** 2000-up Softtail, Acorn



**Chrome Volt Pack Cover** bolts on 1987-2000 Softtail models with stock hardware.

**VT No. 42-0093**



**Chrome Regulator Covers** for module. Fits 1980-99.

**VT No. 42-0399**



**Chrome Ignition Module Cover** is a replacement for 1991-up Dynaglides.

**VT No. Year**

**42-0781** 1991-98

**42-0803** 1999-03

**42-1043** 1999-03

**42-1001** 2004-11

**42-1044** 2004-11

**42-1109** 2004-up



**Chrome Die-Cast Volt Pack Cover** fits all stock rectifiers. Fits 1970-99.

Engineered to improve cooling for extended regulator life. Chrome finish reflects engine and exhaust heat Grooved to interlock with regulator 20% more fin area than stock

**VT No. 42-0405**

# Bracket



**Regulator Mount Brackets** attach to engine mount.

**VT No. Type**

**31-0172** Zinc

**31-0784** Chrome

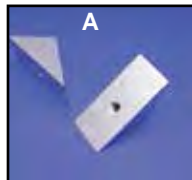

**Front Engine Mount Blocks** act as nuts for front bolts and will mount regulator.

**VT No. Type**

**31-0739** A

**31-0635** B



**Chrome Regulator Bracket** fits 1980-99 Big Twin

**VT No. 31-1261**



**FXST Regulator Relocation Mounting Bracket** allows regulator to be mounted in higher location to allow for increased front fender to frame clearance.

**VT No. 31-0725**



**Alloy Regular Bracket** fits TC-88B models with oval shape regulator. Allows mounting of regulator directly below oil filter.

**VT No. 31-0806**



**Stainless Regulator Mount** bolts to front engine mount on Big Twin models.

**VT No. 31-0951**





# Regulator

BIG TWIN



Accel Black	Accel Chrome	Volt Tech Black	Volt Tech Chrome	Replace OEM	Fits Charging System Type
32-8067	32-0852	32-0667	32-0780	74516-86	1981-88 FLT-FLHT Classic, 1986-88 FXST-Softail
32-8069	32-0856	32-9098	32-0781	74519-88A	1340 1989-99 FLT, FLHT Carburetor, 1991-98 FXD, 1989-99 FLST
—	—	32-9154	—	74505-95A	1340 95-98 FLHT EFI with 38 Amp Alternator Kit
32-0864	32-0865	32-7531	32-0950	74505-97	1997-01 FLHT carburetor, 1999-up FLHR EFI
32-0860	32-0861	32-7533	32-7538	74518-99A	1999-2003 Dynaglide models
32-0858	32-0859	32-7534	32-7562	74512-00	2000 Softail models
32-0862	32-0863	32-7561	32-0784	74640-01	TC-88 2001-06 Softail
—	32-5635	32-7548	32-7503	74505-02	TC-88 2002-2003 FLT
—	32-5630	32-7506	32-7501	74631-04	2004-05 FXD
—	32-5636	32-7505	32-7502	74505-04	2004-05 FLT
—	32-5632	32-7507	32-7512	74631-06	2006-07 FXD (45/60 amp)
—	—	32-1520	32-0979	74631-08	2008-up FXD
—	32-5640	32-0949	32-1107	74505-06	2006-08 FLT (45/60 amp)
—	—	32-1096	32-0966	74505-09	2009-16 FLT
—	32-5620	—	32-0379	74540-07	2007 Softail
—	32-0981	—	—	74546-07A	2007-up XL
—	—	—	32-0381	74540-08	2008-2010 FXST, FLST
—	—	32-0611	—	74540-11	2011-up FLST

## Volt Tech™ and Accel Solid State Regulators

- Feature rugged aluminum alloy construction.
  - Provide more accurately regulated voltage under all electrical loads.
  - All units listed carry the full replacement warranty by Accel or Volt Tech.
- Accel brand is available in chrome, alloy or black stock finish with polished top fins. Volt Tech comes in black or chrome finish.

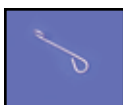

**Plug Retainer** replaces 45095-85 on all 1970-1988 Big Twin. Secures connector plug to alternator plug in case, prevents faulty contact.

**VT No. 13-0219**



31-0857

**Chrome Alternator Plug Retainer** bolts to the front left motor mount bolt for 1970-88 Big Twin.

**VT No. 31-0857**

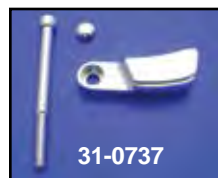

31-0737

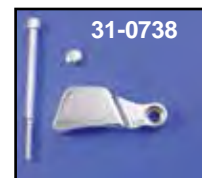

31-0738

**Chrome Die-Cast Regulator Plug Retainer** for Big Twin.

**VT No. Year**  
31-0737 1970-88  
31-0738 1989-up

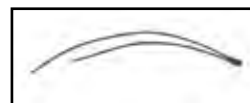

**Wire Harness** for regulator with female end and is 2 pin connecting from the main wiring harness to the voltage regulator.

**VT No. 32-1122**





# Alternator Stator



32-0602



32-8083



32-8038



32-0470



32-0464



32-0529



32-0868



32-0948



32-0463



32-0489

## Deutsch Connector Sets

### VT No. Fit

32-1854 Stator (32-0529)

32-1855 Regulator (32-0898)

32-1875 Deutsch Connector Assembly 32-1207

### Warranty

All Electrical Components sold as individual pieces or in kits are covered under our warranty "Replacement Only" Provision. All electrical related item part numbers begin with a 32 prefix. No credit will be issued for these items as they are exchange only.



32-0952



32-0941

Stators replace stock units for models listed in molded (M) or unmolded (U) type.

VT No.	Brand	Type
<b>1981-88 Big Twin, Replaces 29965-81, 22 Amp</b>		
32-0602	Volt Tech	M
32-8081	Volt Tech	U
32-9042	Accel	U
32-9041	Accel	M
<b>1989-99 FXST, FLST; 1989-94 FLT, 1989-94 FXR, 1991-98 Dynaglide, Replaces 29970-88C, 32 Amp</b>		
32-8083	V-Twin	U
32-8038	V-Twin	U
32-9045	Accel	U
32-0952	Plug Only	
<b>1997-98 FLT, Replaces 29987-97</b>		
32-0489	Volt Tech	U
32-9148	Accel	U
<b>1999-01 FLT, FLHR Replaces 29987-99A</b>		
32-0463	Volt Tech	U
32-9149	Accel	U
<b>2002-05 FLT, EFI, Carburetor, Replaces 29987-02</b>		
32-0872	Volt Tech	U (Racing Stator)
32-0873	Volt Tech	U
32-9350	Accel	U
<b>2000 FXST/FLST, 1999-03 Dynaglide, Replaces 29951-99</b>		
32-0464	Volt Tech	U
32-9145	Accel	U
<b>2001-06 FXST/FLST, 2004-06 Dynaglide, Replaces 30017-01</b>		
32-0529	Volt Tech	U
32-9146	Accel	U
<b>2007 FLST-FXST, 2007 Dynaglide, Replaces 30017-07</b>		
32-0868	Volt Tech	U
32-9147	Accel	U
<b>2008-up FXST, Replaces 30017-08</b>		
32-0968	Volt Tech	U
<b>2006-up FLT, Replaces 29987-06</b>		
32-0948	Volt Tech	U
32-9351	Accel	U

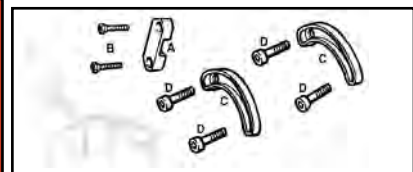

Stator Assembly Kit for Big Twins 1970-86 includes (2) 29988-73 locks, (1) 29954-71 retainer, (4) 2653 screws, (2) 2216W screws.

VT No.	#	OEM	Item
32-0598		Kit	Complete, all
32-0604	A	29954-71	Nylon Retainer, 10 pack
32-0603	B	2216W	Screw, 10 pack
37-8812	C	29988-73	Lock Plate, 10 pack
37-8811	D	2653	Screw, Fillister, 7/8"
37-9003	D	2712	Screw, with Lock Patch, 7/8"
37-9126		2720	Screw, with Lock Patch, 1"

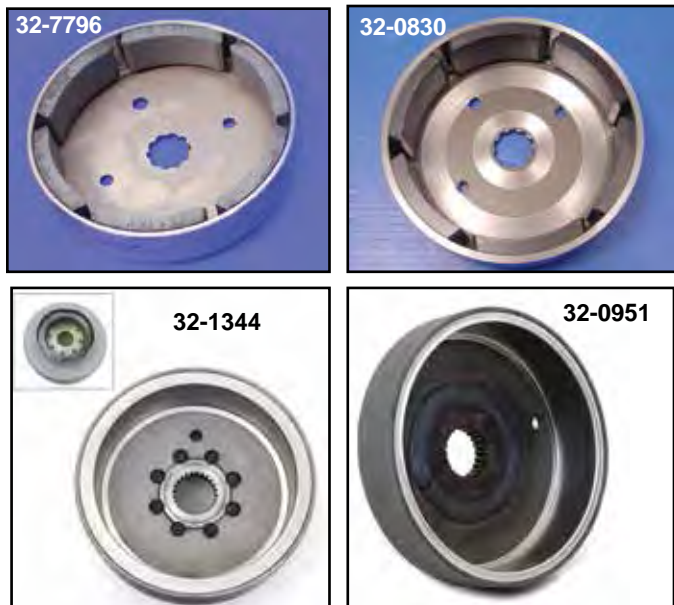

**Big Twin Alternator Rotor** features OE type with magnetic inserts installed.

VT No.	OEM	Amp	Item/Fits
<b>32-7796</b>	29957-81B	32	Rotor, 1982-2000 FXST-FLST, 1982-94 FLT, 1982-up FXR, FXD
<b>32-0830</b>	29981-95	38	1995-05 FLT, 2001-06 FXST, FLST, 2004-05 FXD
<b>32-1344</b>	40356-06B		2006 FXD
<b>32-0951</b>	40356-07	50	2007-up FXD, Rotor 2007-11 FXST-FLST, 2007-11 FX 2007-10 FLT



**Rotor Shims.**

VT No.	OEM	Type	Year
<b>10-6121</b>	Special	Large Spacer	—
<b>10-6122</b>	Special	Large/Small Spacer Kit	—
<b>32-0899</b>	29923-01A	Small Spacer	2001-up
<b>10-2558</b>	29961-85	Small Spacer	1985-90
<b>10-2550</b>	29960-85	Large Spacer	1985-up 1985-90
<b>10-2549</b>	29960-91	Small Spacer	1991-up 1991-up
<b>12-1160</b>	603	Alt Roll Pin	



**Order Spacer and Shims separately.**

VT No.	OEM	Year	Size	Item
<b>10-0427</b>	24002-70	1970-up		Spacer
<b>10-0428</b>	24032-70	1970-up	.060"	Shim
	24033-70	1970-up	.090"	Shim
	24034-70	1970-up	.120"	Shim
	24035-70	1970-up	.150"	Shim
	24036-70	1970-up	.180"	Shim
	24037-70	1970-up	.210"	Shim
<b>10-2549</b>	Special	1970-up	.250"	Shim

# Alternator Rotor

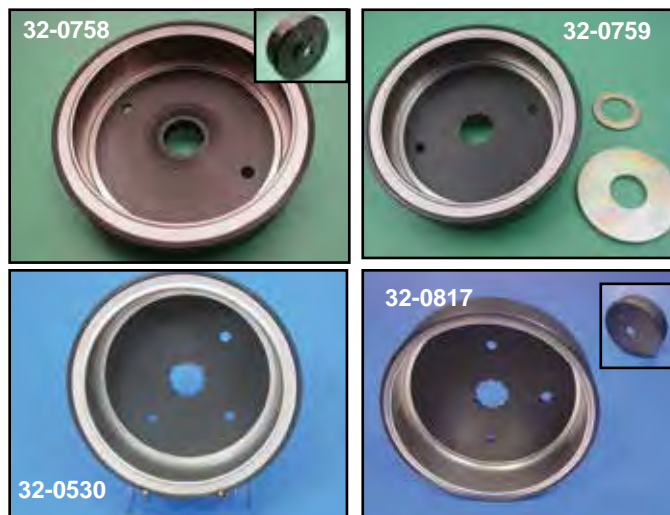

**Volt Tech Big Twin Alternator Rotors** feature vibration proof construction. Magnets are held in place by stainless steel non-magnetic insert for durability. **\*Note:** Built-in spacer in spline area.

VT No.	Year	Model	AMP
<b>32-0758*</b>	1970-90	ST-FX	22/32
<b>32-0759</b>	1981-00	ST-FX	32
<b>32-0530</b>	1995-05	FLT	38
	2001-06	ST	
	2004-05	FXD	
<b>32-0817</b>	2006 only	FLT	50
<b>32-0870</b>	2012-up	FXST-FLST	
	2012-up	FXD	
	2011-16	FLT	
	2008-up	FXCW	



**45 Amp Rotor Only** will convert system to 45 amp using stock stator. The V-Tech rotor features sealed magnets by a stainless insert. Replaces 29999-97. The 1.5" wide rotors fit 1999-05 Big Twins.

VT No.	Type
<b>32-8926</b>	V-Twin
<b>32-0746</b>	V-Tech



**Engine Shaft Spacer** features built in seal flange to give added support for alternator rotor.  
**VT No. 10-0948**



**Big Twin Alternator Rotor Puller** uses the two threaded holes in rotor to allow removal of rotor.  
**VT No. 16-0693**





# Alternator Kit



“Volt Tech” Alternator Kit fits 1984-up Big Twins includes stator, rotor with stainless liner “to seal magnets in place” chrome regulator and mount kit. **\*Note:** Does not fit FXD models.

VT No.	Regulator	Fits	Amp
32-0775*	32-0781	1984-88 FLT-FXR 1989-99 All Big Twin	32
32-7807	32-0781	As Above with reinforced rotor splines (A)	

**Big Twin Alternator Charging System** features all components including stator, rotor, black solid state regulator, plug retainer and mount kit.

VT No.	Regulator	AMP	Fits
32-7500	32-0667	22	1984-88
32-8927*	32-9098	32	1984-88 FLT-FXR & 1989-99 All Big Twins

**\*Note:** Features unmolded stator.

## Alternator Sealing Ring Service



**Motor Shop Alternator Sealing Ring Replacement Service.** Ship in 1970-up left hand case with damaged O-Ring lip and we will machine out and replace with new steel sealing ring.  
**VT No. 60-0164**



**Big Twin Alternator Rotor Puller** uses the two threaded holes in rotor to allow removal of rotor.

**VT No. 16-0693**



**Big Twin Alternator Rotor Puller** uses the sprocket shaft end to center and the two threaded holes in rotor to allow removal of rotor.

**VT No. 16-1054**



**Alternator Repair Ring Only.**  
**VT No. 16-0692**

# Charging Systems for Touring



Alternator Kit for FLT-FXR models include rotor stator and hardware. Use 32-8926 rotor only with 32-7780 kit, to produce 45 amp output.

VT No.	Regulator	Amp	Year/Model	Type
32-7776	32-0667	22	1983-88	Carburetor
32-0775	32-0781	32	1984-88	Carburetor
			1989-99	
32-7775	32-0781	32	1983-98	Carburetor
32-7780	32-9154	38	1995-96	EFI
32-8975		45	1997-98	EFI/Carburetor
32-8943		38	1991-96	Carburetor
32-0373*	32-0784	38	1995-05	Carburetor 3 Phase
32-8944		45	1991-96	Carburetor
32-0994		45	1991-96	Carburetor
32-0871	32-7548	45	1999-05	EFI/Carburetor
32-0764		50	1989-98	FLH, FLT, FXR 3 Phase
32-0835		50	1999-03	FLH, FLT 3 Phase
32-1281		50	2002-03	FLT, FLHT 3 Phase
32-0836		50	2004-05	FLH, FLT upgrade 3 Phase
32-0837		50	2006	FLH, FLT 3 Phase
32-0838		50	2007-08	FLH, FLT 3 Phase
32-1278	32-0966	50	2009-10	FLH, FLT 3 Phase
32-1279	32-0966	50	2010	FLH, FLT 3 Phase

\*Note: For 1995-2005 FLT models, use with 31-0166 zinc recifier regulator bracket mount.







# Alternator Kit



45 Amp Rotor fits 1999-05 Big Twins for upgrade.

VT No. Brand  
32-8926 V-Twin  
32-0746 V-Tech

\*Note: Rotor can only be used with VT No. 32-7780 kit to upgrade kit to 45 amps.

Alternator Kit features sealed rotor, stator, regulator and bracket. All feature Deutsch connectors.

## 38 Amp Softail 3 Phase

Kit	Regulator	Year	Model
32-0388	32-0378	1999-03	FXD
		2000	FXST
32-0939		2006-08	FXD (Alternator Stator& Rotor)
32-0373*	32-0784	2001-06	FLST-FXST, 1995-05 FLT
32-0375	32-0378	1984-99	FLST-FXST, 1991-98 FXD

## 50 Amp, 3 Phase

32-0773	32-7512	2006-07	FXD stock, 2006 FXD upgrade
32-0839	32-0979	2008-10	FXD, 3 Phase
32-1280		2008-11	FXD, 3 Phase
32-0774	32-0979	2007	FXST, 3 Phase
32-0840	32-0381	2008-10	FXST, 3 Phase
32-0544		2011-16	FLT; Note: 54 Amp
		2009-16	FLHX

\*Note: For 1995-2005 FLT models, use with 31-0166 zinc recifier regulator bracket mount.

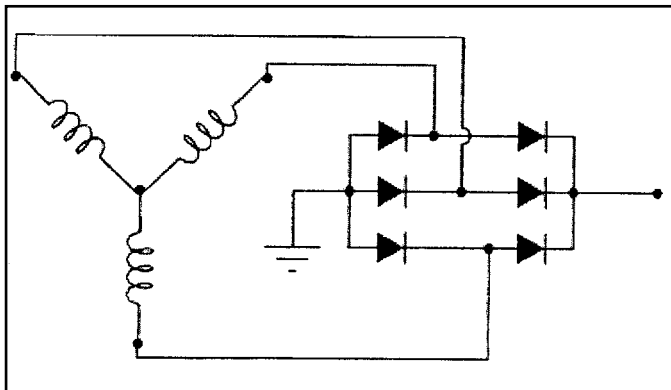

Some basic facts about 3 Phase...Most of the electric power in the world is 3 Phase. The concept was originally conceived by Nikola Tesla and was proven that 3 Phase was far superior to single phase power. 3 Phase power is typically 150% more efficient than single phase in the same power range. In a single phase unit the power falls to zero three times during each cycle in 3 Phase it never drops to zero. The power deliver to the load is the same at any instant. Also, in 3 Phase the conductors need only be 75% the size of conductors for single phase for the same power output. Therefore, a 3 Phase system provides more current delivery for EFI and other electrical accessories and provides more charging power for increased battery life and easier starting. Not really much more complicated than single phase but much more efficient!



# Starter Motor 1989-up Big Twin



32-0242



32-0243



32-9266



32-0998



32-0248



**Stock Starter Motors and Parts** for all 1989-06 Big Twin except 2006-up Dynaglide models.

VT No.	OEM	Fits	Item	Finish
32-0242		1989-93	Motor	Black
32-0243*		1989-93	Motor	Chrome
32-9266	31604-91	1991-up	Solenoid Repair Kit	

\*Note: Provides 15% greater torque over stock starter motor.



12-9994



12-9996



12-9995

### Big Twin Starter Motor Replacement Bearings.

VT No.	OEM	Fits
12-9994	8882	1989-90 Commutator End
12-9996	8883	1991-up Commutator End
12-9995	8871	1991-up Gear End

**Chrome Starter Motor** is fully chrome plated including the aluminum parts. For all 1989-05 Big Twins except 2006-up Dynaglide models. 32-0998 includes remote starter button.

VT No.	Kw
32-0998	2.4
32-0248	1.4

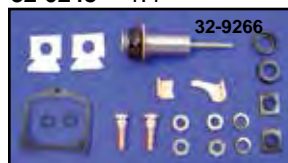

32-9266

**Solenoid Repair Kit** for 1991-up Big Twin.

VT No.	Fits
32-9266	1991-05 FXD, 1991-06 FXST, FLST, FLT
32-9345	2006-up FXD, 2007-up FXST, FLST, FLT
32-1427	1989-06 Big Twin

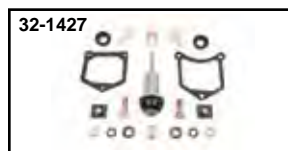

32-1427



32-0742  
installed on  
32-5115

**Remote Starter Button** replaces end cover on 1991-06 Big Twin. Allows starter to operate directly at the solenoid.

VT No.	Item
32-0742	Chrome
32-1195	Black

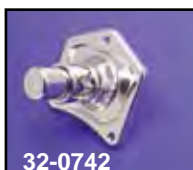

32-0742



32-1195



**Start Boost Relay** provides full battery voltage to coil during cranking, eliminating the 1-2 volt drop through the wiring harness in single fire applications.

VT No. 32-3000



42-1167



42-11

### Starter Motor End Cover

• Dresses the end of the starter motor for a clean look on all 2017-up FLT models. Available with chrome or gloss black.

Black	Chrome
42-1167	42-1168

## Cover



**Starter Motor Chrome End Cover** for 1991-06 Big Twin.  
VT No. 42-0992



**Chrome Starter Cover** fits 1991-05 FXD and 1991-94 FXR. VT No. 42-0152



**Chrome Starter Solenoid Plate** replaces 31688-90, 1990-up Big Twin.  
VT No. 32-7798





# Starter Motor



32-1150



32-1151



32-1152



32-5115



32-5116



32-5117



32-5118



32-1153



32-0765

**High Torque Starter Motors** by Volt Tech are available in black or polished/chrome finish and in either 1.4 kw field wound or 1.7 kw permanent magnet types. Stock starter motor is 1.2 kw field wound type. Polished/chrome units have all aluminum parts polished and all steel parts are chrome plated. Black units are black powder coated.

VT No.	Finish	KW
<b>1989-93</b>		
32-1150	Black	1.4
32-1151	Chrome	1.4
32-1152	Chrome	1.8
<b>1994-06 FXST, FLST, FLT; 1994-05 FXD</b>		
32-5115	Black	1.4
32-5116	Polish/Chrome	1.4
32-5117	Black	1.7
32-5118	Polish/Chrome	1.7
32-1153	Chrome	1.8
<b>2006-up Dynaglide, 2007-up Softail, 2007-up FLT</b>		
32-0765	Chrome	1.4
32-0999	Black	1.4
32-1000	Chrome	1.4



32-0999



32-1000



**Starter Drive Gear Set** includes 9T pinion gear and 66T or 84T ring gear with mounting hardware. This ratio allows more RPM for easier starting and the heavier teeth configuration is less susceptible to wear by converting the 102 tooth ring gear to 66 or 84T.



32-9202

**2.4 KW Starter Kit** includes chrome starter and full jack shaft kit to fit 1989-06 models except 2006-up Dynaglide.  
**VT No. 32-9202**

66T	9T Replacement	84T	9T Replacement	Year
—	—	18-0335	18-0445	1990-93 All Big Twin
18-0360	32-9201	18-0365	18-0446*	1994-97 All Big Twin
18-0361	32-9201	18-0366	18-0446*	1998-05 Dynaglide 2006 Softail/FLT

**Hardware 37-0018** —  
**\*Note:** 10 Tooth

Replacement Bolts for Above



# Starter Shaft 1989-up



32-9201

**Easy Starter Kits** for Big Twin models improves starting on high compression big inch engines through an improved starter-to-clutch basket gear ratio. Complete kits include a clutch basket with bearing for Big Twin models with 66-tooth starter ring gear and a 9-tooth starter pinion gear.

VT No.	Year
18-1220	1994-97
18-1221	1998-06
32-9201	9T Gear

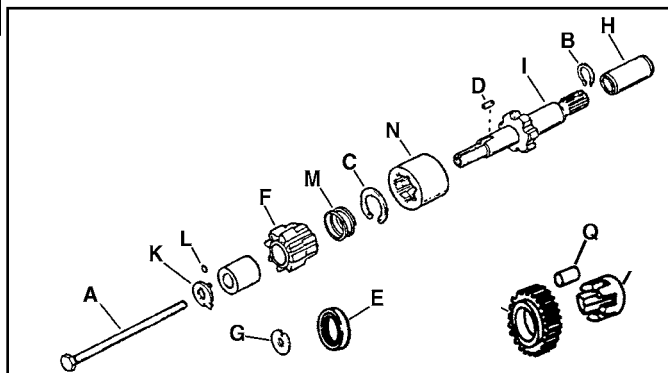

## Ring Gears



18-8319

**Big Twin Starter Ring Gears** for replacement on stock clutch drums only bolt on type. **Note:** Bolt on types include screws.

VT No.	Year	Teeth
18-8307	1991-93	66T
18-8308	1994-97	102T
18-8319	1998-06	102T
37-0018	Bolt Set	



32-9238

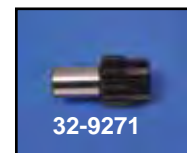

32-9271

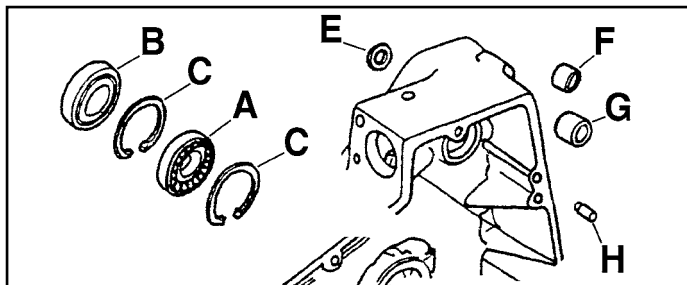

**Inner Primary Hardware** fits Big Twin 5 Speed 1989-up FXST-FLST.

VT No.	#	OEM	Item
12-0357	A	9135	Bearing
14-0159	B	12052	Seal, 1985-up, 5pack
12-0969	C	60678-85	Retaining Ring
10-8527	F	33445-89	Starter Shaft Inner Bushing, 1989-93
10-8548	F	33445-94	Starter Shaft Inner Bushing, 1994-up
14-0920	E	12053A	Seals, 1989-93, 5 pack
14-0961	E	12066	Seal 1994-up
12-1198	H	221	Pin, Dowel
10-8528	G	33446-89	Starter Shaft Outer Bushing
10-8549	G	33446-93	Starter Shaft Outer Bushing, 1994-up
10-1312	Custom		Starter Outer Shaft Bushing, raw
12-1253	H	—	Transmission Dowel Pin

## 1989-up Big Twin Starter Coupler and Related Parts

VT No.	OEM	#	Item
37-9243	4325	A	1989-93 Bolt
37-9244	4358	A	1994-up Bolt
12-0981	11182	B	1989-up Retaining Ring
12-0978	11183	C	1989-93 Retaining Ring
12-0985	11248	C	1994-up Retaining Ring
12-0216	11220	D	1989 Key
14-0920	12053A	E	1989-up Seal
32-9270	31342-93	F	1993 Pinion Gear
32-9271	31342-94	F	1994-up Pinion Gear
32-9227	31430-90	G	1993 Thrust Washer
32-9273	31430-94	G	1994-up Thrust Washer
32-9238	As Above		1989-93 Shaft and Gear Kit, Sifton
32-9228	31548-90	H	1990-up Coupling
32-9275	33120-89	I	1989 Shaft
32-9277	33127-93	I	1993 Shaft
32-9278	33127-94	I	1994-up Shaft
17-0930	33125-89	K	1989 Lock Plate
32-9229	33126-90	K	1990-92 Lock Plate
32-9280	33126-93	K	1993 Lock Plate
32-9281	33126-94	K	1994-up Lock Plate
14-0569	33345-89	L	1989 O-Ring
14-0960	33340-90	L	1990-91 O-Ring
13-9203	33447-89	M	1989 Spring Pinion Gear
13-9221	33449-90	M	1990-93 Spring Pinion Gear
13-9255	33449-94	M	1994-up Spring Pinion Gear
17-9162	60647-90	N	1990-93 Coupling
17-9164	60647-94	N	1994-up Coupling



12-0589



12-0591



15-0779

**Inner Primary Bearing Kit** for Late 1985-up Big Twins includes bearing, seal, two snap rings and one inner race.

1985-93	1994-05
12-0589	12-0591
Kits with gaskets.	
15-0779	1994-06
15-0781	1986-89
15-0782	1990-93



15-0781



15-0782





# Starter Drive

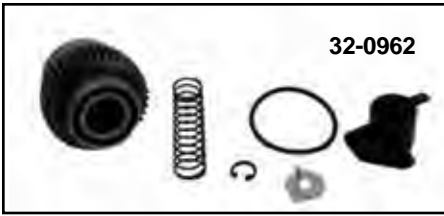

**Starter Clutch Drive Kits** for Big Twin include clutch drive, O-ring, lock tab, seals, spring and cable boot.

VT No.	Year
32-0962	1991-92
32-0963	1993
32-0961	1994-up



**Starter Shaft Kit** includes parts shown, drive included. Fits 1994-up FXST.  
VT No. 32-9203



**Starter Shaft Kit** includes parts pictured for Big Twins.

VT No.	Type	Year
32-9238	V-Twin	1989-93
32-9288	Kit	1989-93
32-9200	Kit	1994-up



**Starter Drive** for Big Twin features high strength five roller clutch, stainless steel springs, hardened ramped clutch receivers, premium internal bronze bushing and factory pre-lubing.

VT No.	Item	Fits	Brand
32-0638	31443-65A	1965-88	Accel
32-0639	31443-65A	1965-88	Volt Tech
32-2506	31443-65A	1965-88	Volt Tech
32-1561*	31544-90	1989-90	V-Twin
32-9031*	31663-90	1991-up	V-Twin
32-9122*	31663-90	1991-06	
32-0943		2007-up	

\*Note: Drive Assemblies

# Starter Shaft



**Starter Shafts and Spacers.**

VT No.	OEM	Fits
17-9944	33120-85	1986-88 FLT-FXR
17-9939	31482-86	1986-89 FXST
17-9985	31311-80	Spacer, FLT
17-9984	33121-79	Spacer, FLT
17-0081	31493-67	Nut, FLT
12-0569	31312-80	Nut, FLH Classic

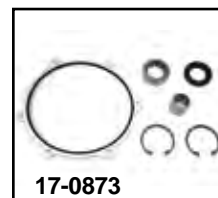
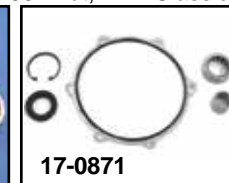
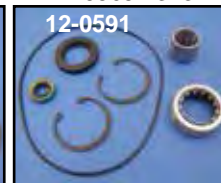

**Inner Primary Bearing Kit** for Late 1985-up Big Twins includes bearing, seal, two snap rings and one inner race.

1985-93	1994-05	2006-07	2008-up
12-0589	12-0591	17-0871	17-0873
17-0870	1985-05	Bearing/Sleeve	



**Chrome Solenoid Body Cover.**

VT No.	Years/Models
28-0117*	1965-88 Big Twin, Black
28-2019	1965-88 Big Twin, Grey
42-0089	1986-88 FXST-FLST 5-Speed
42-9928	1980-88 FLT-FLHT-FXR 5-Speed
42-0400	1965-88 FL-FXE-FXR-FLT End Cover
32-7798	1991-up Big Twin End Cover
42-0025	1979-88 5 Speed FXR-FLT



**Starter Relay.**

VT No.	OEM	Fits
32-0642	31506-79	1980-90 All
32-0738	—	As Above with Weather Proof Skirt
32-9076	31504-91A	1991-06 All FLT, 1991-99 FXD, FXST
32-0737	31522-00	2000-10 Softail, 2000-10 FXD
32-1160	31586-07	2007-up FLT

**Start Boost Relay** will boost voltage drop to allow full battery voltage to the module and coil during cranking for single fire ignition applications.  
**VT No. 32-3000**

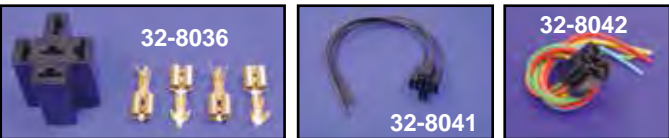
**Starter Relay Connector.**

VT No.	Fits
32-8036	1979-up All Twins
32-8041	1973-78 All Twins when using 1979-90 type starter relay, 4-lug
32-8042	As Above, 5-lug

**Note:** 32-8036 includes crimp style connector ends and 32-8041 and 32-8042 includes pigtail harness.

# Solenoid



**Starter Solenoid** replaces 71469-65 used on 1984-88 FXST models.

VT No.	Finish	Brand
32-0699	Zinc	V-Twin
32-0633	Zinc	Accel
32-1063	Black	Accel
32-0632	Chrome	Accel
32-1021	Chrome	V-Twin



**5-Speed Starter Solenoid** replaces 31489-79. Fits 1979-88 FLT's and 1982-88 FXR's. **Note:** 1984-88 5-Speed FXST use 4-Speed style solenoid.

VT No.	Finish	Brand
32-0636	Zinc	Accel
32-1062	Black	Accel
32-0637	Chrome	Accel
32-0986	Zinc	VT
32-1055	Chrome	VT



**Starter Solenoid Kit** fits 1984-88 FXST models. Kit includes chrome or zinc solenoid, outer and inner rubber boot, foam gasket, bolts and spacer.

VT No.	Finish
32-0697	Zinc
32-0698	Chrome

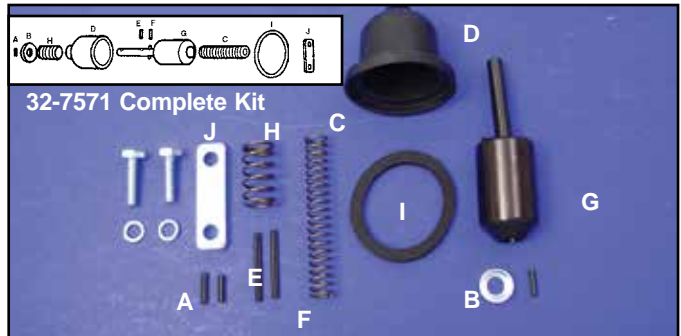

**Solenoid Plunger Hardware** fits 1965-88 solenoids.

VT No.	#	OEM	Item
32-7571		Kit	All Listed
12-1176	A	257	Roll Pins
12-1177	F	600	Roll Pins
12-1178	E	601	Roll Pins
12-1180	E	614	Roll Pins
32-0590	G	31435-65A	Plunger
13-0118	H	31438-65A	Over-Run Spring
32-0591	B	31439-65	Retainer, 1965-84
17-9157		31439-84	Retainer, 1985-90
13-0119	C	31440-65	Return Spring
28-1997	D	31441-65A	Plunger Boot
32-0318	J	31452-65	Spacer, each
15-0181	I	60645-65	Gasket



**Solenoid Rebuild Kit.** Complete overhaul for 71469-65 and 31489-70 solenoids, stock and aftermarket.  
**VT No. 32-0634**





# Hitachi Type Starter Motor

1.4 kw  
32-7761



**Hitachi Type High Torque Starter Motor** features 1.4 kw design that generates more power and shaft speed than original type .8 kw starter.

**32-5122** Black  
**32-5123** Chrome

**Hitachi Type Starter Motors** are replicas for 1974-88 FXE, 1982-84 FL, 1983-88 FXR-FLT and 1984-88 FXST. Parts interchange with original, 5" overall body length.

VT No.	OEM	Item
<b>32-1307</b>	31570-73	Complete, Black
<b>32-7760</b>	31570-73	Complete, Black
<b>32-7761</b>	31570-73	Complete, Chrome
<b>32-0306</b>	31580-73	Armature
<b>32-0307</b>	31582-73	Brush Set
<b>32-0308</b>	31579-73	Field Coils
<b>32-0059</b>	31576-73	Thru Bolts
<b>12-0347</b>	31583-73	Bearing, Drive End



**Hitachi Starter Hardware Kit** includes brushes, holder, springs, thru bolts and insulator commutator end bushing for 1973-88 Big Twin.

**VT No. 32-0553**



**Springs** for Hitachi Starter Motors. Replace 31600-90. 1991-up starter clutch assembly. **VT No. 13-9220**

## Starter Motor Housing, Shafts and Gears

1984-85 FXST

1984-88 FLT, 84-88 FXR, 1986-88 FXST

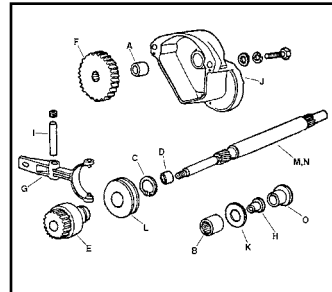
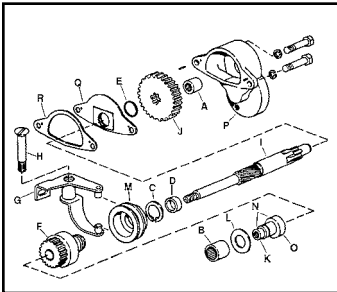

### Starter Related Hardware.

VT No.	OEM	#	Item
<b>43-9160</b>	Kit	1	Complete
<b>12-0317</b>	9062	A	1984-85 Housing Needle Bearing Housing
<b>12-0318</b>	9063	B	Needle Bearing Cover
<b>12-0934</b>	11039	C	1984-88 Retaining Ring Collar
<b>17-0088</b>	11041	D	1984-85 Starter Shaft Spacer
<b>14-0501</b>	11101	E	1984-85 O-Ring Deflector Plate
<b>32-0639</b>	31443-65A	F	1984-88 Starter Drive Gear
<b>17-1507</b>	31445-65	G	1984-E85 Shift Lever Starter Gear
<b>17-1506</b>	31478-65A	H	1984-85 Pivot Bolt Shifter Lever
<b>17-0085</b>	31482-70	I	1984-85 Starter Shaft
<b>17-1508</b>	31485-65	J	1984-85 Starter Shaft Gear
<b>17-0081</b>	31485-65	K	1984-85 Starter Shaft Nut
<b>17-1504</b>	31502-65	L	1984-88 Thrust Washer Chain Cover
<b>17-1505</b>	31503-70	M	1984-85 Shifter Collar
<b>17-1502</b>	31503-65	M	1965-69 Shifter Collar
<b>17-0084</b>	31530-65A	N	1984-85 Starter Shaft Nut and Spacer
<b>17-9936</b>	31531-69	O	1984-85 Starter Shaft Spacer
<b>43-9122</b>	31572-79	P	1984-85 Housin
<b>17-0509</b>	60516-65A	Q	1984-85 Deflector Plate
<b>s15-1064</b>	60559-80	R	1984-85 Plate Gasket



**Starter Related Hardware.** Kits includes A, B, C, D, E, F, G, H, I, J, K, L, and M.

VT No.	OEM	Item
<b>43-9161</b>	Kit	FXST 1986-88
<b>43-9166*</b>	Kit	FXST 1985-88
<b>17-0240*</b>	Kit	FXR 1984-88
<b>12-0317</b>	9062	A Needle Bearing Housing
<b>12-0318</b>	9063	B Needle Bearing Cover
<b>12-0934</b>	11039	C Retaining Ring, Collar
<b>32-0638</b>	31443-65A	E Bendix Drive
<b>17-1508</b>	31485-65	F Gear 1980-85
<b>17-9938</b>	31340-80	F Gear 1985-88
<b>17-0965</b>	31491-79	G Shift Lever, FLT, Steel
<b>17-9773</b>	31300-84	G Shift Lever, Starter FXST
<b>17-0081</b>	31493-67	H Nut for Shaft
<b>17-9987</b>	31495-79	I Pivot Pin FLT-FXR
<b>17-9875</b>	31473-86	I Pivot Pin FXST
<b>17-9990</b>	31497-83	J Housing, 1983-85 FLT/FXR
<b>17-9995</b>	31572-86	J Housing, 1986-88 FLT/FXR
<b>17-1504</b>	31502-65	K Thrust Washer
<b>17-1502</b>	31503-65	L Shift Collar
<b>17-9983</b>	33120-79	M Starter Shaft, 1980-84 FLT-FXR
<b>17-9944</b>	33120-85	M Starter Shaft, 1985-88 FLT-FXR
<b>17-9939</b>	31482-86	M Starter Shaft, FXST
<b>17-9984</b>	33121-79	O Spacer, Shaft, FLT-FXR
<b>17-9985</b>	31311-80	O Spacer FXST

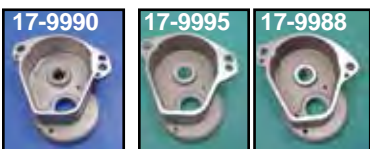

**FLT/FXR Starter Housings.**  
Order bearing separately.

VT No.	Year
<b>17-9990</b>	1983-85
<b>17-9995</b>	1986-88
<b>17-9988</b>	1980 only

\*Note: Order appropriate housing to complete assembly.

# Circuit Breaker

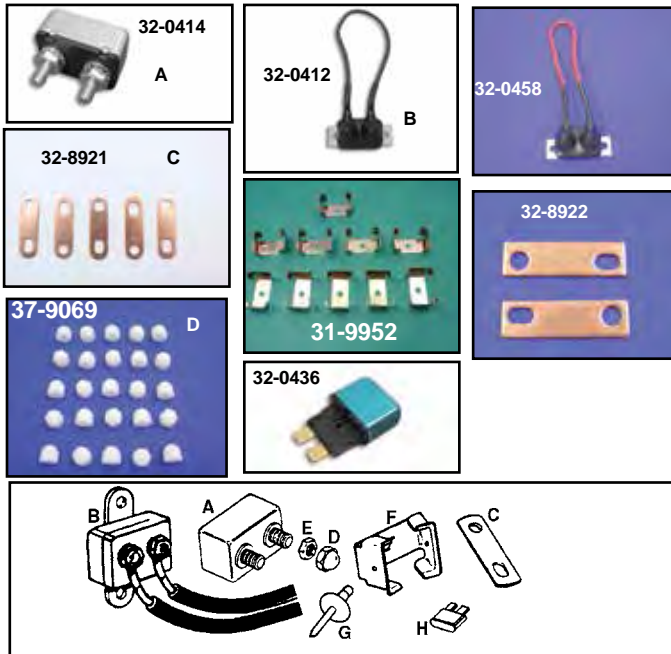

Circuit Breaker are stock replacements.

VT No.	#	OEM	Amp	Fits
32-0414	A	74589-73	15	1973-up FL, FX
32-1537		74589-73	15	10 pack
32-0413	A	74559-77	30	1978-up FL, FX
32-1536		74559-77	30	10 pack
32-0412	B	74594-71	20	1970-up Big Twin
32-0458	B	74586-30	30	1970-up Big Twin
32-0436	H	74587-94	15	1994-96 FL, FX
32-9207	A	74600-94	50	1994-up FL, FX
32-0460	A	74600-97A	40	1999-up FLT
32-8921	C	74598-73		Connector Bar, each
32-8922		69999-77		Connector Bar, each
32-8945		7/8" C/C		Connector Bar, pair
37-9069	D	7602		Nylon Nut, 1/32", 25 pack
12-0581	E	7629		Nut, 25 pack
31-9952	F	9952		Mount Clip, 10 pack secures breaker or flasher to fender
31-9964	G	8672		Rivet for Above

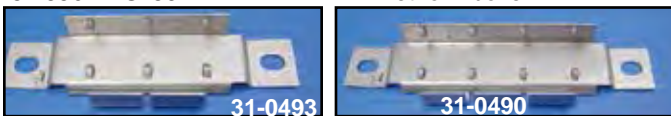

**Circuit Breaker Bracket** available for two or three circuit breakers, allows standard 15 or 30 amp breakers to snap firmly in place. Bracket has 1/4" holes, 5" apart and can be mounted to oil tank bracket or fender.

### VT No. Breakers

31-0493	2
31-0490	3



**Circuit Breaker Mount Rubbers** hold breaker in place on FXST-FLST models. Replaces 70939-84A, 5 pack.

### VT No. 28-0403 Terminal Boards

**Terminal Blocks** with terminal studs. 10-24 thread.

VT No.	Terminal
32-0502	4
32-0880	8
32-0879	12
32-0878	16



# Ignition Switch

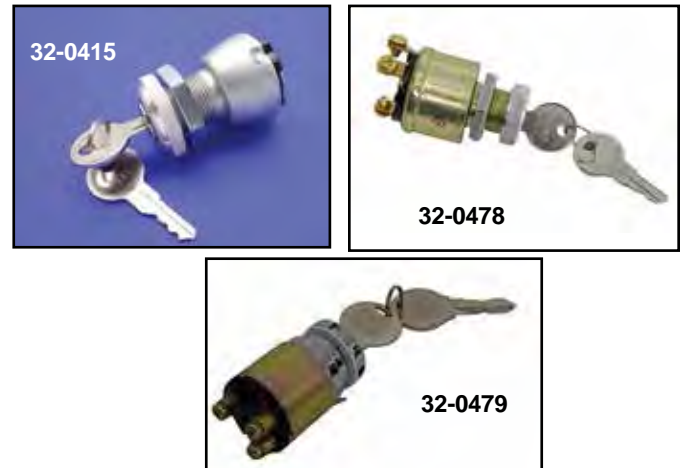

**Universal Key Switch** includes mounting ring and two keys.

VT No.	Type
32-0415	On-Off-On
32-0478	Off-On-Start
32-0479	Off-On-On



### Ignition Switch.

VT No.	Type
32-8065	Mini
32-8114	Universal Ignition Switch
32-8111	On-Off Mini



### Chrome Switch Bracket.

VT No.	Years	Type
42-0525	1982-90	FXR
31-0262	—	Universal

**Weld On Ignition Mount** accepts 32-0161 switch.

VT No.	Item
32-0180	Each
32-0820	Collar





# Ignition Switch



32-9038



32-9053

## Barrel

**Barrel Key Ignition Switch** features round style keys, featuring 2-position activation with positive detent to retain key in the off position.

VT No.	OEM	Year	Model
32-9038	71428-90A, Stock	1982-94	FX-FXR
32-9053*	Early Type	1973-84	FX

\*Note: Features run position with lights off



32-0161



32-1099



32-0175



32-1100

**Chrome Stock Key Switch** for ignition and light switch for Super Glide, replaces 71425-77 and 70124-75. Used on all FX-FXS, 1982-94 all FXR. Includes two keys and mounting ring.

VT No.	Type	Year
32-0161	Replica	1977-98
32-0416	Stock Type	1977-98
32-1099	As Above Cam Lock	
32-0175	Replica	1973-76
32-1100	As Above Cam Lock	
32-1267	Off/On Start	



32-8070



32-9267



32-8109

**Chrome Electronic Ignition Switch** for 1985-95 Softail models has smooth action and dependability of electronic switching. It eliminates original pole to bar contacts found in original equipment switch. This 6 pole switch withstands vibration and corrosion and it replaces 71501-73. Includes two keys and early chrome style switch cover. **VT No. 32-9267** features stainless internal construction.

VT No.	Feature
32-8070	Smooth
32-9267	Stainless
32-8109	Silent



32-0419



32-8078



32-0480



32-0482

**6 Post FLH Cast Ignition Switches** include cast cover and two keys. Replaces 71501-73, for 1985-95. Cover installed as noted.

VT No.	Brand	Top	Key
32-0419	V-Twin	Cast	Stock
32-8078	Replica	Cast	Stock
32-0480	Contact	Cast	Round
32-0482	Rear Hinge	Cast	Round

### Hardware

37-8916	2589 Terminal wire screw and washer, 24 pack
37-8917	2625 Mount screw, 7015 washer, 24 pack



**Key Switch Spacers** allow switch height to be adjusted when installing dash cover on FL type dash assemblies. Spacers are .040" thick.

**VT No. 39-0118**



**Switch Covers** fit 1967-up FLH diecast dash switch, chrome finish.

**VT No. 32-0399**



# Ignition Switch for Fat Bob



32-1192



32-0480



32-1199



32-8109



32-9267



32-1193



32-0482



32-1194

**6 Post Mechanical Ignition Switch.**

Skull Smooth Key

*Fits 1973-84 FLH, 1984-95 FXST, 1986-95 FLST, 1980-84 FXWG*

32-0480 32-1192 Flat/Round

32-1531 Electronic Switch Round

*1973-84 FL, 1984-95 FXST, FXWG*

32-8109 32-1199 Flat

**Electronic 6 Post Ignition Switch.**

*Fits 1973-84 FLH, 1984-95 FXST, 1986-95 FLST, 1980-84 FXWG*

Smooth Skull

32-9267 32-1193 Flat

32-0482 32-1194 Round



32-1689



32-1690



32-1691



32-1692

**Gloss Black Ignition Switch**

VT No.	Key	Terminal	Fits
32-1689	Round		1996-13 FXST, FLST
32-1690	Round		2003-13 FXDWG-FLHR
32-1691	Flat	5 Post	1986-1995 FLST
32-1692	Round	5 Post	1947-1972 FL
32-1693	Flat	6 Post	1986-1995 FLST
32-1694	Round	6 Post	1984-1995 FXST, 1986-95 FLST
32-1695	Flat	6 Post	1984-1995 FXST, 1986-1995 FLST
32-1696	Round	6 Post	1986-95 FXST
32-1697	Round		2011-up FLST-FXST
32-1698	Round		2011-up FLST-FXST



32-0439



32-1197



32-0987



32-0241



32-1198



32-1084



32-1088

**Side Hinge Electronic Ignition Switch.**

*Fits 1994-02 FLR, 1993-02 WG, 1996-02 ST*

Smooth Skull Type Key

32-0439 32-1197 3 way Round

*Fits 1996-10 ST*

Skull Type

32-0987 3 way Round

*Fits 2003-13 FLHR, 2003-08 WG, 2003-10 ST*

Smooth Skull Type

32-0241 32-1198 Packard Round/Fan

32-1084 71419-11, 2011-up FXST, FLST

32-1088 As Above, 2011-up with fork lock



32-1693

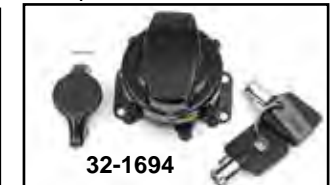

32-1694

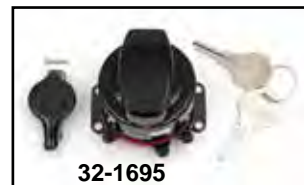

32-1695



32-1696



32-1697



32-1698





# Switch



32-0429



32-0457

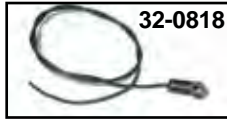

32-0818

Oil Pressure Switches are precision calibrated.

VT No.	OEM	Year	Model
32-0429	26561-84	1984-99	Evolution
32-0457	26561-99	2000-up	TC-88
32-0818	Wire		



Crank Sensor fits 1999-up TC-88.  
VT No. 32-0988

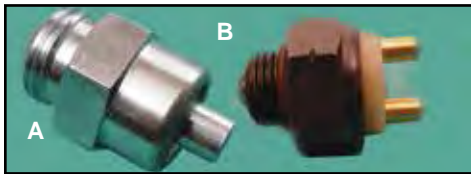

A

B

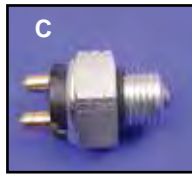

C

Neutral Switches are replica type, replaces the following FLH-FX models.

VT No.	#	OEM	Year	Speed
32-0417	A	33900-59	Late1973-Early79 1979-98	4 5
32-9065	A	As Above	Replica	5
32-0069	B	33902-98	1998-99 Big Twin	5
32-0522	B	33904-00	2000-05 Big Twin	5
32-0955	C	33926-06A	2006-up Big Twin	6
32-1090			1999-up XL	5



32-0426



32-0435



32-0443



32-0770

Hydraulic Brake Switch features heavy duty contacts and quality brass terminals.

VT No.	Type	Years	Brand
32-0426	Flag	1971-92	Replica
32-0435	Screw	1971-92	Accel
32-0443	Flag	1995-up	Replica
32-0770	Flag	2004-up	Replica



42-0675

Chrome Oil Pressure Cover fits 1984-99 Big Twin with 32-0429 sending unit.  
VT No. 42-0675

# Flasher

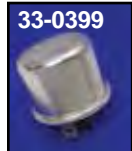

33-0399



33-2198



33-2173



33-0398



33-0938

Flashers for turn indicator lights on 74" 6 or 12 volt.

VT No.	OEM	Item	U/M
33-0399	68543-64A	12 volt, Round	Each
33-0848		12 volt, Round	10 pk
33-0916	68543-64C	12 volt, Round Solid State	
33-2198	As Above	Rectangle, Replica	Each
33-2173	As Above	Rectangle, Plastic	Each
33-0938		LED Type	Each
33-0398	68543-61A	6 volt	Each



33-0848



33-0397

Flasher for hazard or four flashing lights.

33-0397 68541-64 12 volt

12 Volt 2 Pin Flasher Units with built in bulb failure indicator.

33-2350 10 Watts

33-2351 21-23 Watts



Flasher Connector and Mount.  
VT No. 32-8925



Hi-Low Beam Switch Relay will allow the Hi-Low beam to be switched from one beam to another using one wire momentary horn type button.  
VT No. 32-0448



Oil Pressure Switch Wrench installs and removes oil pressure switches without damaging the switch itself. Used on 1340cc Evolution, and late 1983-84 Sportster. Replaces 34816.

VT No. 16-0990



16-9723



16-9724

Oil Pressure Gauge and Indicator Lamp Sending Unit Wrenches. These reversible ratcheting wrenches are used to install and remove oil pressure indicator lamp or gauge sending unit on all 1984-up Big Twin.

VT No.	Item	Year
16-9723	Sending Unit	1999-up
16-9724	Sending Unit	1984-98



42-0687

Chrome Oil Pressure Switch Cover includes chrome mount hardware. Replaces 66232-97. Fits 1984-99 FXST.  
VT No. 42-0687



32-9083

Vacuum Switch Assembly

VT No.	OEM	Fits
32-9079	26557-83	1984-90 All FXR
32-9080	26558-84	1984-90 FXST 1986-89 All FLT
32-9083	26566-91	1991-95 All FXST-FLST, Dynaglide and FXR



# Button Switches



32-1025



32-8115

**Direct Starter Button** fits 7/8" hole.  
VT No. Button  
32-1025  
32-8115 Red



**20 Amp Toggle Switch** features red cap closure.  
VT No. 32-0188



**Pingel® Button Switch** fits 1" bar activated by momentary contact.  
VT No. 32-0866



32-0867



32-0869

**Mini Chrome Push Button Switch** for starter. Two wire type requires a starter relay.

VT No. Wire

32-0867 2

32-0869 1



**Hi-Low Beam Switch Relay** will allow the Hi-Low beam to be switched from one beam to another using one wire momentary horn type button.

VT No. 32-0448



**Bat Handle Toggle Switch Set** comes in a set of 4 featuring a black finish.  
VT No. 32-1812



32-0263

32-0264



32-1360



32-1364



32-1378



32-1380



35-0856



35-0857

## Button Switches.

VT No.	Finish	#
32-0263	Chrome	2
32-0264	Black	2
32-1360	Black Switch	1
32-1364	Black Switch	2
32-1378	Chrome Switch	1
32-1380	Chrome Switch	2
35-0856	Black Throttle Housing	
35-0857	Chrome Throttle Housing	

# Diagnostic Wiring



32-0475

**Wire Plus Chopper System Chromed Billet Housing** with an automotive style start switch and three (hidden) switches for right-left turn, high-low and horn. It includes a pre-assembled harness and bolts to stock style top engine mount (or mounts that do not have threaded mounting holes). It is designed to be used with 31-0747 or 31-0746 engine mount with integral coil bracket as listed below.

VT No. Type

32-0475 Chopper Style

32-0477 With Auto Turn Signal

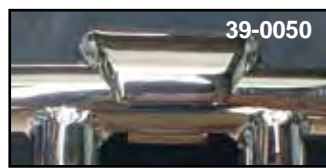

39-0050



32-4750

**Wire Plus Chopper Motor Mount Wiring Kit** mount between cylinder to FXR style top engine mount. Chrome billet construction with built in ignition switch.

VT No. 32-4750



**Wire Plus Anodized Billet Lid for Mid Frame Mounted Wiring Kit** for FX-FL-FXST models. Optional anodized billet lid sold separately.

VT No. 32-4151

**Wire Plus Digital Instrument Panel** features chrome billet construction, digital speedometer, digital bar graph tachometer, charging system monitor, trip meter, odometer and light sensor for auto dimming at night. Requires a digital signal from the transmission sensor and an ignition module with a tach output. Requires correct bracket for handlebar mounting.

VT No. Item

39-0050 Clamps for 1" Bar

39-0051 Clamps for 1 1/4" Bar

39-0052 Clamps for 1 1/2" Bar







# Wire Harness/Dash Base Assembly

Note: Order the appropriate factory service manual to facilitate wire harness installation.

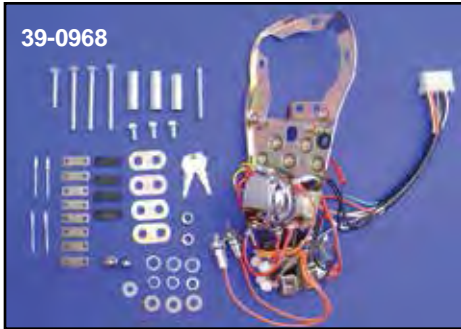

**FXST Builders Harness/Dash Base Assembly.** Builder Harness includes all correct color coded high tension wires, handlebar wires and tail lamp wires for years listed. Dash base assembly includes wired base, six post switch, circuit breakers and flashers. Allows use of either the turn signal canceler VT No. 32-7508 (not included) or flasher VT No. 33-0399.

VT No.	Item	Year
39-0968	Dash Base Assembly	1987-95
32-0675	Builder Harness	1987-88
32-0456	Builder Harness	1989-90
32-0726	Builder Harness	1991-95



**1984-up Wiring Kits** feature plastic wire in original factory color codes with all terminals applied in vinyl loom. Complete "Builder's Kits" include handlebar, taillight, coil and regulator wires, denoted by an \*.

All other harnesses are main harness only. Handlebar and tail lamp must be purchased separately for these kits. Main harness include the main turn signal wires.

VT No.	OEM	Application
<b>FXST-FLST-FXR</b>		
32-9213	70216-87A	1987-88 FXST
32-9214	70216-89	1989-90 FXST
32-9215	70216-91A	1991-92 FXST
32-9216	70216-93B	1993-95 FXST-FLST
32-0675*	Builder's Kit	1987-88 FXST-FLST
32-0456*	Builder's Kit	1989-90 FXST-FLST
32-0726*	Builder's Kit	1991-95 FXST-FLST
32-0674	—	1989-95 Ignition Switch Harness
32-0753	70216-96	1996-97 FXST-FLST
32-0754	70216-98	1998-99 FXST-FLST
32-0723	69545-84	Late1984-Early85 FXR-FXRS-RT
32-0724	69551-85	1986-88 FXR-FXRS
32-0725	69551-89	1989-90 FXR-FXRS
32-0727	69551-91A	1991-93 FXR-FXRS
32-0960	69555-89	1989-90 FXLR

**Wiring Harness/Dash Base Assemblies** include complete harness pre-wired to dash base, 6 post key switch, terminal box, headlamp connection, speedo lamp socket and front

terminal board when required. VT No. 39-0193 uses 39-0399 flasher included; 39-0191 requires use of 32-7508 turn signal canceler available separately. 1987-95 assemblies require purchase of handlebar switch wiring with six switches.

VT No.	Type	Year/Model
<b>Big Twin Electric Start Models</b>		
39-0193	5-Light	1987-88 FXST-FLST
39-0194	5-Light	1989-90 FXST-FLST
39-0191	5-Light	1991-95 FXST-FLST



**Builder's Wire Harness Kits** for Softail models, include main harness, handlebar, ignition switch and tail lamp wires with all necessary junctions and fittings.

VT No.	Year
32-0675	1987-88
32-0456	1989-90
32-0726	1991-95

<b>PVC Covered Tail Lamp Wires</b> fit 1987-up.	
32-9331	1987-90 Softail
32-9336	1991-95 Softail
32-0486	1996-up Softail



**Wire Mount Clips.**  
VT No. Fits  
32-1172 Fender (10)  
32-1173 Tank (10)



**Handlebar Wiring Harness Kits** are color coded.  
VT No. Years  
Type  
32-8009 1982-90  
Extended  
32-8108 1996-up  
48"



**Speedometer Connector Kit** is used to modify 1996-1999 OEM harness to the newer type Deutsch connectors. Wiring harness can be used with the newer 2000-2003 electronic speedometers VT No. 39-0449 and 39-0651. Replaces 67418-99.  
VT No. 32-0587



# Battery Cable



**Extreme Duty Battery Cable Sets.** These #2 gauge wires are very fat and flexible. The battery cables will transfer more cranking power with the very least amount of voltage drop. Over 2000 bare strands of copper are covered with special vinyl insulation that is covered by a synthetic thermo-rubber jacket. Sealed and insulated with black heat shrink tubing means no moisture will get in these cables.

VT No.	Fits	Cable Lengths
32-2007	1989-up FXST	10" and 12"
32-2008	1991-up Dynaglide	10" and 15"
32-2009	1989-94 FXR	12" and 16"
32-2006	1993-up FLT	13" and 14"
<b>For XL</b>		
32-2011	1981-2003	11" and 16"
32-2012	2004-up	12" and 13"

**Volt Tech Flexible Battery Cables** features a 4 gauge cable manufactured with pure electrolytic-grade 36 gauge tinned copper strands for maximum current transfer and flexibility and a specially rated 125° C, oil and gas resistant, ultra-flexible translucent jacket in either black or clear.

Clear	Black	Length
32-1418	32-1419	7"
32-1400	32-1409	8"
32-1401	32-1410	10"
32-1420	32-1421	11"
32-1402	32-1411	12"
32-1403	32-1412	14"
32-1422	32-1423	15"
32-1404	32-1413	16"
32-1405	32-1414	19"
32-1406	32-1415	25"
32-1407	32-1416	30"
32-1408	32-1417	33"

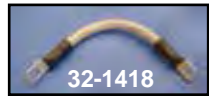

**Battery Cable Boot** to fit cable end at battery terminal.

VT No.	OEM	Fits
32-0354	70595-96	1995-05 FXD
32-0369	70584-94	1994-07 FXST
32-0360	70578-89	1991-93 FXST

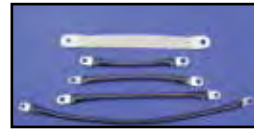

**Battery Cable Assortment.** Ground cable assortment is heavy duty replacement type and includes five pieces of the popular numbers.  
VT No. 32-0317

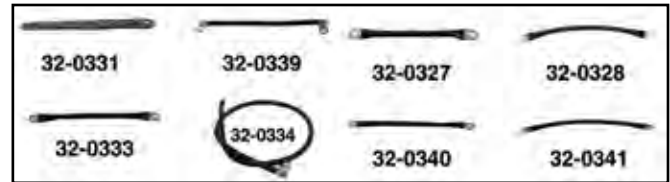

**Replacement Battery Cables** are replacements of the originals with heat shielded terminal ends.

VT No.	OEM	Length	Fits
<b>Ground</b>			
32-0327	70011-84C	7¾"	1984-88 FXST
32-0328	70062-85	11½"	1985-86 FXR
32-0331	70186-82	8½"	1982-92 FLT 1987-94 FXR
32-0339	70103-95	9¾"	1991-95 Dynaglide
32-0340	70060-92A	9½"	1989-07 All FXST, FLST
32-0341	70267-93A	13"	1993-96 FLT
<b>Positive</b>			
32-0333	70064-89	9"	1989-90 FXST
32-0334	70033-89	31¾"	1989-92 FLT
32-0335	70083-89	11¾"	1989-90 FXR 1993-94 FXR
32-0338	70102-90A	14½"	1991-95 Dynaglide
32-0340	70060-92A	9½"	1993-94 FXR,
32-0342	70377-93B	14"	1993-96 FLT
32-0310	70069-65B	15½"	Solenoid to Battery and Starter 1971-85 All FX, 1984-85 FXST 65-85 FLH Positive to Solenoid 1982-88 FXR
32-0316	70069-83	15¾"	Solenoid to Starter 1983-84 all FX, 1984 FXST, 83-85 FLH
32-0330	70100-79A	8½"	Solenoid to Starter 1982-88 FLT

## Wiring



**Primary Wire** is 100% multistranded copper wire with PVC insulation. Ideal for replacing or rewiring part or all of the system. Brightly color coded for installation ease

#10 Gauge 10' Roll	#16 Gauge 35' Roll		
VT No.	Color	VT No.	Color
32-2130	Black		
32-2131	Green	32-2137	Green
32-2132	Red		
#14 Gauge 25' Roll	#18 Gauge 45' Roll		
32-2133	Black		
32-2134	Green	32-2140	Green
		32-2141	Red

**SHRINK TUBING**

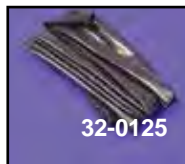

VT No.	Inner Diameter	Length
32-0124	¼"	4'
32-0125	⅜"	4'
32-8039	⅝"	4'



**Shrink Wrap Tubing** is easy to use. Cut to length, thread the wires, carefully apply heat and watch the insulation shrink to fit around the wires.

**Flex Chrome Hose Covering** features heavy gauge mylar construction with chrome finish, 25' length.

VT No.	Size
36-0552	¼"
36-0553	⅜"
36-0554	½"

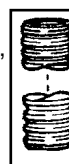

**Insulator Wrap** is made of black nylon which is fully flexible which covers wiring and fuel line. Replaces 63505-84 with ½" inner diameter, 10 feet.

VT No. 40-0364

VT No.	Inner Diameter	Length
40-0364	½"	10'







# AGM Battery

- Lock Bonded Plates
- Stainless Steel Terminal Bolts
- Maintenance Free



**AGM Battery.** The "Absorbed Glass Mat" Technology provides higher cold cranking amps, better rechargeability with longer over-all life. Batteries are fully sealed for trouble free service in a black case. **Note: 1998 and earlier FX models,** require battery side cover, VT No. 42-0770 and a top cover, VT No. 42-0785 for FXD models.

VT No.	OEM	Year/Model
53-0547	65991-82B	1973-94 FX-FXR
53-0585	65991-75C	1984-90 FXST-FLST 1999-2000 FXR
53-0536	65991-75V	1973-84 FXE
53-0536	66010-82B	1980-96 FLHR-FLHT-FLT
53-0550	66010-97A	1997-up FLHR-FLHT-FLTR 1998-2009 FL, FLH
53-0545	65989-90B	1991-96 FXD-FXST-FLST
53-0545	65989-90B	1991-96 FXD-FXST-FLST
53-0789	65989-97A	1997-up FXD, FXST, XL, FLST (Dry)

**Note:** AGM Batteries will require charging before installation.

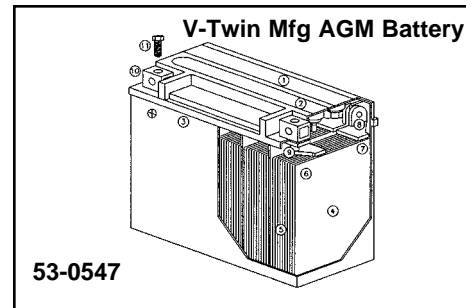

1. Unique vent system minimizes leakage.
2. Completely sealed maintenance free design eliminates acid spills and corrosion damage.
3. Bonded cover prevents electrolyte leakage and improves dependability.
4. Precise volume of demineralized electrolyte means no excess acid and improved life.
5. Positive AGM plate separators ensure long life and improved performance.
6. Durable AGM plates direct maximum cranking amps to terminals for quick starts.
7. Heavy top lead lugs provide improved adhesion to the plates for vibration resistance and long life.
8. Large diameter partition connections direct more power to the terminals.
9. Sturdy diameter bushings resist vibration damage and acid leakage which causes terminal corrosion.
10. Durable two position terminals.
11. Stainless steel terminal screws.



**"Activator" Battery Filler** attaches to any standard acid pack tube. Positive thumb release valve absolutely controls acid flow. No acid spills, burns or holes in clothing.  
VT No. 16-0037



**Battery Acid Catch Tank** attaches to battery vent tube to collect excess acid to protect the frame and lower rear fender parts.  
VT No. 16-1739



**Brass Terminal Kit.**  
VT No. 32-1024



**Battery Terminal Hardware Kit** includes pieces to simplify battery installations on FXE and late XL models.  
VT No. 32-0235

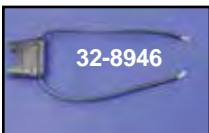

**In-Line Fuse Holder** has 6" long wire leads.  
VT No. Type  
32-0410 Fuse  
32-8946 ATC Type

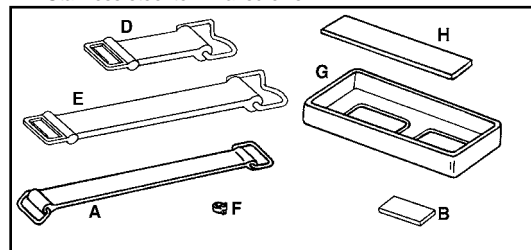

**FXST Battery Hardware** for 1984-99 Softail models.

VT No.	#	OEM	Item	Year
28-2217	A	66105-77	Strap	1984-92
28-0138	B	66004-93	Clamp Pad	1993-99
28-0136	D	66109-93	Front Strap	1993-99
28-0137	E	66111-93	Rear Strap	1993-99
37-8933	F	10067	Vent Clamp	50 pack
28-0423	G	66210-85B	Tray Insert	1986-97
28-0218	G	66210-97	Tray Insert	1998-99
28-0539	H	66309-84 66103-74	Pad	Pair



**Dynaglide Battery Tray and Cushions** for Dynaglide Models

VT No.	OEM#	Fits	Item
31-0671	47132-90	1992-99	Tray
31-0672	47132-93	1993-94	Tray
31-0675	47132-97A	1997-up	Tray
28-0878	66017-01	2001-up	Strap



# 12 Volt Dry Battery

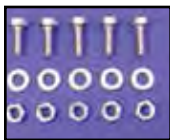

**Battery Hardware**, bolt kit replaces 66000-80 bolt, nut, and spacer for 1973-up FXE-FXR.  
**VT No. Item**  
**37-8867** Nut, Bolt, and Spacer, 5 pack  
**37-8933** Vent Clamp, 50 pack, 10067  
**32-0517** Vent Tube with Clamp

**All Batteries are dry charged and do not include electrolyte. Electrolyte (battery acid) is available at Tractor Supply stores, nationwide.**

**Battery Warranty Information.** The battery is unconditionally guaranteed up to 30 days and pro-rated up to 90 days. No guarantee for cracked or physically damaged cases or terminals at any time. Damage caused in shipping must be reported to us and carrier 24 hours after receipt of shipping. All batteries shipped dry charged.

**Warranty and Adjustment Policy**  
 This battery will be replaced without charge if found to be defective in materials or workmanship 6 months from date of over-the counter purchase. After 6 months but within 12 months of over-the counter purchase, the battery will be replaced and the purchaser charged only for the period of ownership based on the regular price at the time of return prorated over the number of months of warranty. This warranty is available through the dealer to the original retail customer and is not transferrable and is voided by the use of rejuvenators, improper electrolyte, neglect or abuse.



1973-91 FXE-FXR, 1984-90 FXST-FXWG measures 7" x 4" x 6 1/4".

VT No.	OEM	#	Type
53-0502	65991-75C	12N16-4B	V-Twin, 16 amp
53-0554	65991-75B		V-Twin, 16 amp
53-0517	65991-82		Yuasa, Yumicron
53-0518	65991-82		Yuasa CX 19 amp

1991-96 All FXST-FLST-FXD, 7" x 4" x 6 1/4".

53-0519	65989-90A	YB16HL-ACX	Yuasa CX
53-0526	65989-90A	YTX20L-BS	Yuasa GRT

1980-96 All FLT.

53-0525	66010-82A	Y50-N18-ACX	Yuasa CX, 8" x 3 1/2" x 6 1/2"
53-0553	66010-82A		V-Twin

1997-up FXST

53-0789	65989-97A		V-Twin
---------	-----------	--	--------

1997-up All FLT-FLHR

53-0556	66010-97A		V-Twin
---------	-----------	--	--------

Panhead custom application 4 1/16" x 3 19/32" x 4 1/2".

53-0505		12N5.5A-3B	V-Twin
53-0527		12N5.5A-3B	Yuasa

# Big Boar Battery



**Big Boar Batteries** have high cold cranking amps, and a replacement warranty. The 53-0700 battery is a totally sealed, maintenance free battery measuring 6 7/8 long x 6 1/16 high x 3 3/16 wide, and has been tested and proven on big inch and high compression motors.

VT No.	OEM	Fits	AMP
53-0700	65991-82	FX 1973-86, FXR 1982-94, Softail 1994	350
53-0701	65989-90A	Softail and Dynaglide 1991-up, XL 1997-up 65989-97	350
53-0702		"Mini" 6" L x 5 1/8" H x 3 1/4" W	230
53-0703		For custom application that have limited space. Starts larger engines but does not have a lot of reserve. Multi-positional. Dresser/Road King® 1997-up 6 1/8" L x 6 3/4" H x 5" W	1000





# Battery Hardware

## Battery Cover



### Battery Side Cover.

Chrome	Black	Fits	Style
42-0502		1990-96 all FXD	Square View Holes
42-0501		1990-96 all FXD	Single Slot View Hole
42-0500		1990-96 all FXD	Louvered
42-0097		1990-96 all FXD	Louvered w/Square View Hole
42-0714		1990-96 FXD	Embossed
42-0882		1997-05 FXD	Embossed
42-1164		1997-2005 FXD	Embossed



**Chrome Battery Cover** fits FXD models, covers top and side in one piece. Features black lower accent.

### VT No. Year

42-0701 1991-05  
42-1002 2006-up

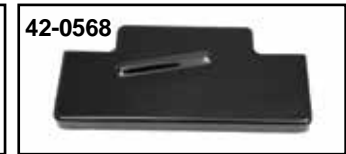
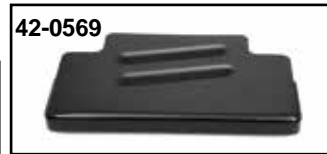

### Battery Top Covers.

Chrome	Black	Fits
42-0753	42-0569	1991-95 FXD
42-0785	42-0568	1997-05 FXD

Chrome	Black	OEM	Fitment
42-0510	42-0570	66370-65	1965-84FL
42-0512	42-0571	66369-70	1971-78 FX (kickstart); 1970-78 XLCH (kickstart)
42-0511	42-0566	66367-73	1973-86 FX (excl. FXR, FXST); 1982-96 XL
42-0753	42-0569	66368-90	1991-95 Dyna
42-0785	42-0568	66368-97	1997-05 Dyna
42-0513	42-0572	66369-67	1967-78 XL
42-0786	42-0567	66367-97	1997-03 XL
42-0573	42-0574	66718-01	1997-05 FXD/ FXDWG, 97-03 XL
42-0882	42-1164	66375-97	1997-05 FXD/ FXDWG, 1999-04 FXDX, 2001-03 FXDXT
42-0714	42-0585	66347-91	1991-96 FXD/ FXDWG, 85 FXE, 1982-99 XL

42-0010 66383-65 FL Battery Cover, Ribbed  
42-0508 66378-70 Battery Side Cover

**Replacement Battery Top Foam Pads, 10 pack.**  
VT No. 28-0626

**Rubber Battery Pad Set** fits 12N16 sized batteries on FXE and XL models.  
VT No. 28-0539

**Chrome FXST-FLST Battery Cover** slips over the top of the battery on 1984-99 models.  
VT No. 42-0427



**Battery Tray Rubbers.**  
VT No. Type  
28-0746 Small, 6.4" x 7.15"  
28-0748 Large, 4" x 8"

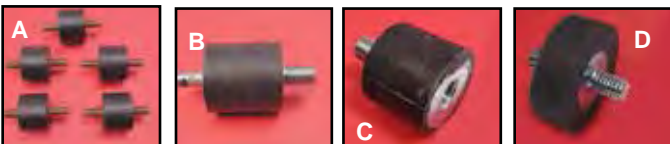

**Iso Mounting Rubber Studs.** All types UNC threads 1/4" used on XL battery box and oil tank, 28-0619 used on FX dash.

VT No.	OEM	#	Size	Type	Qty
28-0546	62563-65	A	1/4"	Male-Male	5
28-0549	62563-65T	A	1/4"	Male-Male	2
28-0418	w/Spring	A	1/4"	Male-Male	5
28-0547	62563-66	B	5/16"	Male-Male	Each
28-0402	62569-94	B	5/16" x 1/4"	XL Oil Tank	Each
28-0619	50235-63	C	5/16"	Male-Female	Each
28-2247	69125-65	D	5/16"	Male-Male, horn	Each

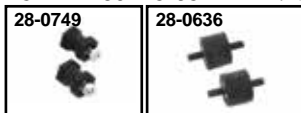

**Rubber Iso Mount** has 1/4" x 20 threads on each end.

VT No.	Type	Qty
28-0749	Hex	2
28-0636	Lord (Round)	2

**FXR Battery Tie Down Screws.**  
VT No. 37-0560



# Air Cleaner

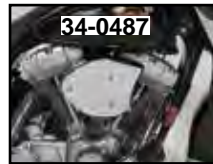
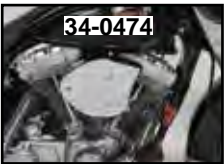

**V-Charger Air Cleaner Units Only** include element. Order brackets and breather kits as required.

Chrome	Black	Style
34-1070	34-1070	Filter
34-0638	34-1430	Smooth
34-1429	34-1456	Raised Skull
34-0620		Smooth
34-1303		Engraved Skull
34-0087		Smooth



**Velo High Flow Air Cleaner Assembly** features cast mount bracket with built in breather and filter. Includes breather bolts and hardware to mount to 1993-07 Evolution and TC-88. Cover not included.

**V-Charger™ Chrome Air Cleaner** for Big Twin features air scoop "blower" design and includes a built-in chrome screen and filter element. Kits include brackets and/or integral bracket, breather system except where noted.

VT No.	Type	Year
34-0467*	S&S	1984-91
34-0625	S&S	1992-99

**Wyatts Air Cleaner Assemblies** include intergrater breather bracket and related hardware.

34-0471	1993-07 Carb
34-0483	1993-07 Carb
34-0484	1993-07 Carb
34-0485	1993-07 Carb
34-0474	2007-up EFI
34-0487	1993-06 Carb
34-0596	CV 1993-07
34-0584*	Keihin 1984-89
34-1241	EFI 2000-07
34-1361	Flame 1993-07
34-1070	Filter

\*Note: Does not have integral breather bracket

- 34-1367 Chrome V-Charger
- 34-1368 Chrome V-Charger
- 34-0639 Chrome fits 1990-1992 FXST, FLST, FXR, V-Charger
- 34-0648 Black fits 1993-2007 FXST, FXD, V-Charger

VT No.	Type	Year
34-0617	CV	1993-07
34-1163	CV Backing Plate	1993-07
34-0700	S&S	1993-05
34-0623	Electronic Fuel Injection (EFI)	2002-07



**Billet Scoop CV Air Cleaner** includes filter and mount brackets. Fits 1991-99 Big Twin with carburetor.

VT No.	Style
34-0703	Flame
34-0702	Smooth





# Electronic Fuel Injected Air Cleaner Assembly



**34-1738**  
Sifton Air Cleaner Kits include a hi-flow "Cycovator" element, skull cover with an integral metal backing plate for a direct bolt on application for carburetor and electronic fuel injected models. Reuse of some original hardware required. Fits 2008-up Touring. VT No. **34-1738**



**34-1841**



**34-0406 Installed**



**34-0054**



**34-0059**



**34-1084**



**34-1236**

## 7" Round Bobber Air Cleaners.

VT No. Fits

**34-1841** Black, Keihin

**34-0406** Black, CV

**34-0054** CV Black with integral breather

**34-0059** CV Chrome with integral breather



**34-2122**



**34-1457**



**34-0943**

**High Flow Air Cleaner Kit** includes backing plate and elements. Fits electronic fuel injection 1999-01. VT No. **34-0943**



**34-1458**



**34-1459**



**34-1460**

**Performance Air Cleaner and Breather Kit** includes backing plate, air filter, breather manifold and hardware.

VT No. Fits

**34-1084** 1993-07 Ev-TC-88

**34-0042** 1999-15 FXST- FLST, 1999-07 FXD, 2002-07 FLT

**34-0920** 1999-07 FXST

**34-1236** 2002-07 FLT, 1999-15 FXST-FLST, 1999-07 FXD

**34-2122** 2008-13 FLT

**34-2124** 2000-07 FXST-FLST, 1999-07 FXD, 2002-07 FLT

**34-2126** 2008-13 FLT 90°

**34-0948** Replacement filter only for 34-1236

**34-1040** Replacement filter only for 34-1092 and 34-1093

**34-1238** Replacement filter only for 34-1243

**34-1239** Replacement filter only for 34-1242

**34-1512** Rubber Tube Inserts

**34-1457** Billet Outer Cover Only Black w/Swiss Cheese Design

**34-0810** As Above Chrome Dish Style

**34-1458** As Above Chrome Ball Milled

**34-1459** As Above Black with Ball Milled Flames

**34-1460** As Above Black with Ball Milled Slots



**34-1113**

**Sifton Air Power™** includes die cast backing plate, filter and breather canisters. Hardware included allows installation on 1992-99 Evolution and TC-88 models with carburetor. Order cover separately as listed below. Breather bolts also available separately.

VT No. Item

**34-1113** Air Cleaner Kit for 1993-07 CV and EFI with Delphi

**34-0655** Teardrop Cover

**34-1084** Backing Plate Kit



**34-0655**



**34-2000**



**34-2001**

**RK-Series Intake Assembly** fits behind the stock air cleaner cover. Provides smoother air delivery to engine and boosts performance and filtration. Average dyno test results confirm 8 additional horsepower. Features K&N High-Flow air filter, pleated design, perfect seal lip design and built in Dyno tested velocity stack. Powder coated billet aluminum backing plate eliminates external breathers. Air filter comes pre-oiled. Fuel management modifications are not necessary to obtain increased performance. All hardware included.

VT No. Fits

**34-2000** 2008-09 FXD

**34-2001** 2008-09 FLT



# Velo Air Cleaner Assembly



**Teardrop Air Cleaner Assembly** features hi-flow element with billet mount bracket and plate. Kit include all hardware to mount on Evolution and TC-88, 1993-2007 models.  
**VT No. 34-0672**



**Skull Air Cleaner** fits 1999-07 FXST, FLST, FXD, FLT, 1993-94 FXR. **VT No. 34-1506**

**Velo High Flow Air Cleaner Backing Plate Kit** by Sifton. Includes one piece alloy backing plate, washable element, stainless steel breather kit with fittings, chrome breather filter and necessary hardware to mount 1992-07 Big Twin Evolution and TC-88 models VT No. 34-1076 accepts 8" round covers with 52" of surface, measuring 7" x 2<sup>3</sup>/<sub>4</sub>" deep. Cover not included.

VT No.	Size	Cover
34-1105	Small	6"
34-1076	Large	8"
34-0804	Velo Air Cleaner Assembly	

## Billet Air Cleaners

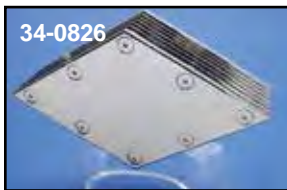

34-9159 Installed

**Chrome Billet Air Cleaner Assemblies** to fit CV carburetors. Order bracket kit as required.

VT No.	Type
34-0826	Diamond
34-0827	Spade
34-9159	Rotar



**Chrome Maltese Billet Air Cleaner** features layered construction to fit CV carburetors.  
**VT No. 34-0799**





# Air Cleaner 1984-up

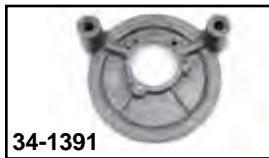

**Performance Air Cleaner and Breather Kit** fits carbureted or electronic fuel injection models and includes backing plate, air filter, breather manifold and hardware.

VT No.	Fits	Type
34-0920	1999-07 TC-88	Carburetor/Electronic Fuel Injection
34-1084	1993-07 Ev & TC-88	Carburetor Only
34-0948		Filter Only
34-1391		Backing Plate



**7" Evolution Type Air Cleaners** include cover, foam, backing plate. Order brackets separately.

VT No.	Type	Item
34-0406	CV	Black
34-0566		Chrome Cover Only



**20% More Air!**



**TC-88 Filter Upgrade Kit** includes washable filter and longer stud set to replace Screamin' Eagle elements. There is 20% more air flow with this filter. Order cover separately.

VT No.	Item
34-0115	TC-88 Filter Upgrade Kit
34-0548	Evolution 8" Chrome Cover



**Stainless Steel 7" Air Cleaner Cover** has a center mounting hole.  
**VT No. 34-0461**

### Miscellaneous Air Cleaners.

- 34-0048 Etched Raw Air Cleaner Cover Etched (have stock)
- 34-0061 Chrome Wyatt Air Cleaner Kit (have stock)
- 34-0278 Air Cleaner Adapter Flange
- 34-0463 7" J-Slot Air Cleaner Cover
- 34-0469 EFI Air Cleaner Mount Bracket
- 34-0482 Zinc Air Cleaner Bracker
- 34-0780 6" Raw Air Cleaner
- 34-0840 Round Air Cleaner Assembly (have stock)
- 34-0851 Bracket Breather Kit (have stock)
- 34-0961 Retro Oval Air Cleaner (have stock)
- 34-1299 Hi Flow Air Cleaner Assembly
- 34-1300 Chrome Skull Air Cleaner Assembly
- 34-1398 Air Cleaner Breather Snoot
- 34-1363 Chrome Round Air Cleaner Assembly
- 34-1385 Sifton Carb Cover
- 34-1386 Sifton Carb Cover
- 34-1387 Sifton Carb Cover
- 34-1533 CV Carb Backing Plate



# Air Cleaner Kit



**Sifton Performance Air Cleaner Kits** include filter, breather tube, chrome mini breather bracket and mount hardware for carbureted models listed. Order cover separately.



**8" Air Cleaner Assemblies** include cover, backing plate and element.

Chrome	Black	Style
<b>Bendix-Keihin</b>		
34-0946	—	Smooth
<b>CV</b>		
34-1053	—	V
34-1256	—	American Motorcycles
<b>8" Center Screw Cover Only</b>		
34-1028		V
34-1064		American Motorcycles
34-0548	34-0407	Smooth
34-0562		Gold Inlay

**8"**

**Notes:** For 1993-up models order 31-0430 breather kit, Pre 1993 models use 31-3941 bracket.

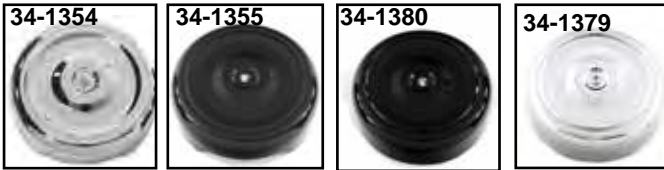

Chrome	Black	Size	Item
<b>Complete Air Cleaner Kits</b>			
34-1362	34-0407	8"	Complete, CV
34-0409		7"	Complete, CV
<b>Air Cleaner Covers.</b>			
34-1354	34-1355	8"	Cover Only
34-1379	34-1380	7"	Bobber Style Cover
34-0533		8"	Round Cover
34-0948	—		Air Filter
34-0947	—	8"	Air Filter
34-0744	34-0781	8"	Round Stripes



**34-0809 Installed**



**34-0807 Installed**

**Velo Dish Air Cleaners** feature chrome dish and full flow filter with bracket with integral breather passages and hardware. Fits 1992-up FXST carburetor and 2002-up FXST and FLT Fuel Injected models.

VT No.	Size	Filter
34-0809	6"	34-0948
34-0807	8"	34-1067



**Wyatt Gatling Air Cleaner** includes brackets, filter element, breather bolts and hardware. Can be used for 50mm fuel injected units and CV carb models.  
**VT No. 34-0491**



**34-0941**



**34-0940**



**34-0944**



**34-1390**

VT No.	Year	Model
<b>34-0940</b>	1993-99	Evolution
<b>34-0941</b>	1999-07	TC-88
<b>34-0944</b>	1999-07	TC-88
<b>34-2122</b>	2008-up	EFI
<b>34-0566</b>	All	7" Cover
<b>34-1390</b>		Backing Plate



**34-0566 Installed on 34-0940**



**34-0655**



**34-0948**

**Chrome Teardrop Air Cleaner Cover Kit** fits Velo or Screamin' Eagle Air Cleaner Kits with filter as shown. Filter available separately.

VT No.	Item
<b>34-0655</b>	Teardrop Cover
<b>34-0948</b>	Filter Only



**34-1289**



**34-1290**

**Sifton Air Cleaner Kits** include a hi-flow "Cycovator" element with an integral metal backing plate for a direct bolt on application for carburetor and electronic fuel injected models. Reuse of some original hardware required.

VT No.	Item	Model	Skull
<b>34-1289</b>	2008-13	Touring	<b>34-1738</b>
<b>34-1290</b>	1993-07 CV-Delphi EFI	Big Twin	





# Air Cleaner



34-1255



34-0098

34-1334  
Installed



**Hi-Flow Air Cleaner** includes integral bracket with breather bolts.  
**VT No. Item**  
 34-1255 1993-07  
 34-1334 Cylovator Inverted  
 34-0098 Bolts  
 34-0464 Bolt Kit

34-1095  
Installed



34-1095



34-0802

**7" Air Cleaner Assemblies** include backing plate, cover and foam element. Center screw type Bendix-Keihin.

Chrome	Black	Style
34-0505	—	V-Logo
34-0547	34-0408*	Smooth
<b>CV</b>		
34-1032	34-0406	Smooth

**CV and Delphi EFI**, measures 5 1/2" outside.

34-0802	—	1993-99 Big Twin
34-1306	—	1993-99 Black, CV & EFI
34-0937	—	Screen, Chrome

\*Note: Features Bobber Style Cover

**Wyatt Gatling Assembly** includes round deco air cleaner with chrome cover, integral breather system with bracket and mounting kit.

**VT No. 34-0840**



34-1277

34-0905

34-0916

**7" Filters.**

VT No.	Type
34-1277	Washable
34-0905	Unifilter Foam
34-0916	V-Twin Foam



A

34-0524

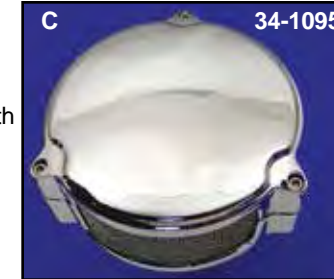

C

34-1095



34-1318



34-1318



34-1292

**Chrome Air Cleaners.** New Era, B, C, and Round A styles. Includes chrome cover, element and backing plate. Round type is 7" with center screw. Order the brackets separately.

**VT No. Style**  
**Bendix Keihin Type Pre 1989 Big Twin**

34-1292 Chrome, Smooth

34-0977 Element only

**CV Type 1989-up Big Twin**

34-1095 Chrome smooth

34-1318 Black smooth

34-0977 Element only fits C

34-0905 Element only fits A

34-1395 Screen Only



34-0977



34-0905



V-Logo Smooth

7"



34-0408



34-1373

**7" Air Cleaner.**

Chrome	Black	
34-0505	—	V-Logo Bendix-Keihin 3 bolt
—	34-0406	Bobber
34-0553	—	Smooth with mount brackets
34-1032	—	Smooth without mount brackets
34-1373	—	Shield, Chrome round w/brackets
34-1044	—	Backing Plate Only
34-1041	—	Smooth Air Cleaner Cover Only
34-1042	—	V-Logo Air Cleaner Cover Only
34-0550	—	Eagle Spirit
34-1246	—	V-Logo Assembly
34-1392	—	Smooth Assembl
34-0555	—	Eagle cover only
34-1561	—	Smooth Cover Only
—	34-1562	Cover Only Black Powder
—	34-1842	Air Cleaner Complete
34-1044	—	Backing Plate CV
34-1428	—	Backing Plate EFI



# Air Cleaner

**Performance Air Cleaner and Backing Plate** fits 1999-15 FXST, FLST, 1999-07 FXD and 2002-07 FLT. Includes washable element and backing plate only. Requires 8" stock type cover and mounting hardware

**VT No. Backing Finish**

- 34-0425 Natural
- 34-1462 Chrome
- 34-1463 Black



# High Flow Air Cleaner Assembly



Stage I  
**8"**

Stage II  
**7"**

**"Big Sucker" Air Filter Kits** for carbureted or electronic fuel injected Twin Cam and EV2 Big Twin models. The all-in-one backing plate features a built-in carburetor support and built-in breather tunnels at each head to decrease crankcase pressure. Each tunnel exits at the mouth of the carburetor to create a virtually closed loop system. No oil hoses, no oil fittings, and no leaking! Stage I kit features a High-Flow filter that accepts all 1993-up oval or round outer covers. Stage II kit features a 20% larger High Flow filter that requires an 8" 34-0548 or OEM outer cover. Both kits include a "Big Sucker" aluminum backing plate, high-flow air filter, chrome banjo bolts for TC88 and 1993-up EV2 Big Twin, simple instructions and all the necessary hardware.

**Stage I Stage II**

- 34-0112 34-0113 1993-99 Carburetor
- 34-0178 34-0114 1999-2013 TC models
- Will not fit 2008-13 FLT
- Will not fit 1999-01 EFI FLT
- 34-0184 34-0185 2008-13 FLT
- 34-1128 34-0105 1999-01 FLT EFI, does not fit 1997-98
- 34-0192 2014-16 FLT

**Filter Only**

- 34-0948 Stage I Kits 34-0112, 34-0178
- 34-0622 34-1128 Only
- 34-1067 Stage II Kits 34-0113, 34-0114
- 34-0098 Bolt Set

**Hardware Listing**

- 34-1136 Hardware Set
- 14-0507 O-Ring
- 34-0186 Stage I Kit 34-0184
- 34-0187 Stage II Kit 34-0185



34-0548 cover fits Stage II. 34-0566 cover fits Stage I.







# Air Cleaner

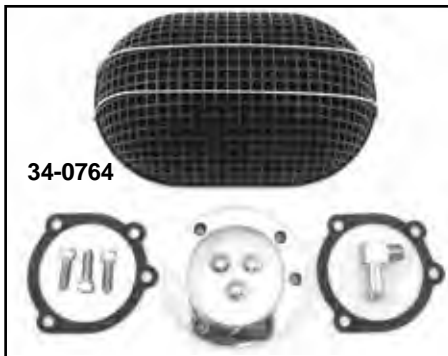

Air Cleaners include elements.

Chrome	Black	Element	Fits
34-0501	34-1325	34-0079	Bendix-Keihin
34-0733	—	34-0079	S&S "E"
34-0040	34-1370	34-0078	Bendix-Keihin
34-0506	—	34-0079	Bendix-Keihin with Chrome Mesh
34-0906	Foam Element for VT No. 34-0506 type		
34-0711	Foam Element for VT No. 34-0501, 34-0733 type		
<b>For CV</b>			
34-0732	—	34-0079	Round
34-0746	34-0764		Turbo



**Air Snoot** is polished aluminum. Fits S&S "E" carbs. Does not include provision for filter.  
**VT No. 34-0470**



**Wyatt Gatling Skull Air Cleaners** fit CV models.  
**VT No. Finish**  
**34-0843** Chrome  
**34-0844** Black



**Velo High Flow Air Cleaner Assembly** features cast mount bracket with built in breather and filter. Includes breather bolts and hardware to mount to 1993-07 Evolution and TC-88. Cover not included.

VT No.	Type	Year
34-0617	CV	1993-07
34-1163	CV Backing Plate	1993-07
34-0700	S&S	1993-05
34-0623	Electronic Fuel Injection (EFI)	2002-07

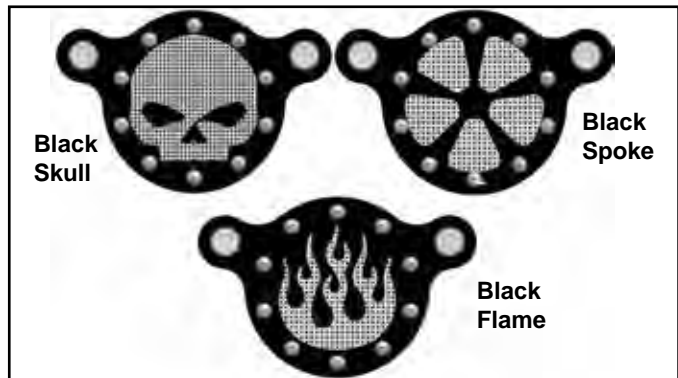

**Wyatt Gatling Air Cleaner Kits** include backing plate and hardware to connect breather fittings in head.

Black	Chrome Style	Fits
34-0233	34-0242	Spoke 2008-16 FLT
—	34-0243	Skull 2008-16 FLT
—	34-0244	Flame 2008-16 FLT
34-0236	34-0245	Spoke 2000-16 FLST, FXST, 2000-07 FLT
34-0237	34-0246	Skull As Above
34-0238	34-0247	Flame As Above



**Chrome Smooth Teardrop Air Cleaner** fits 1990-90.  
**VT No. Style**  
**34-1501** Teardrop  
**34-0560** Mount Kit





# Air Cleaner

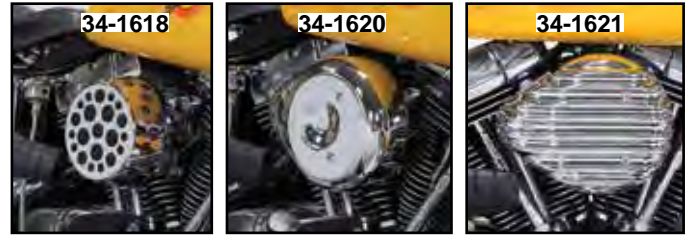
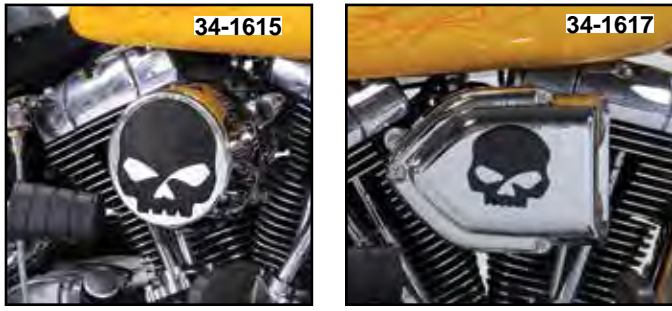
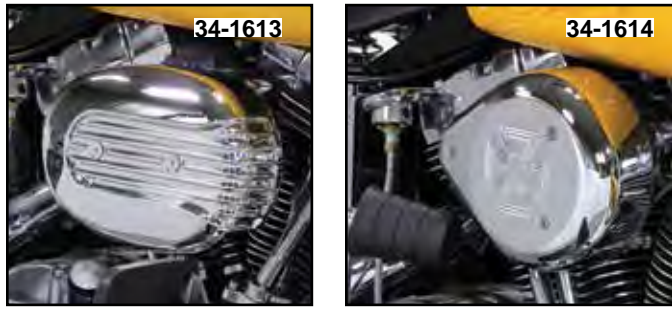
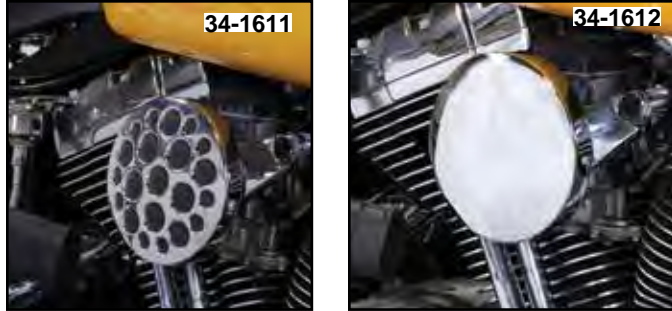
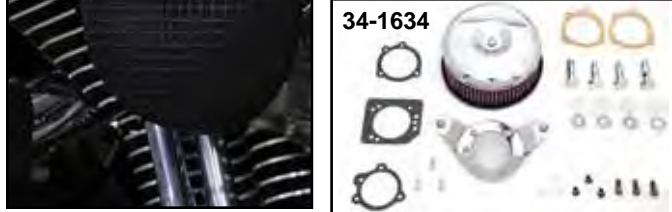
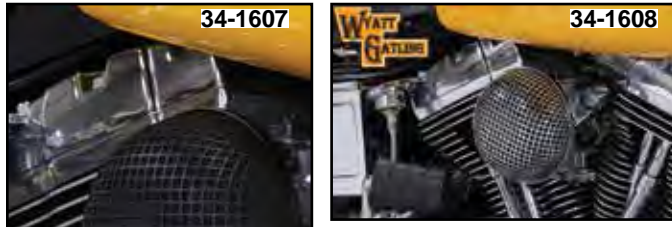
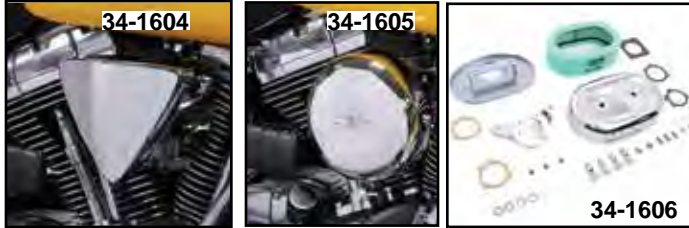
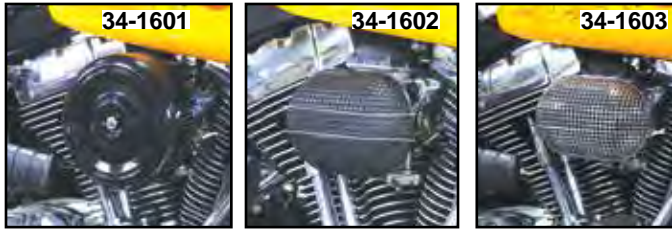

### Wyatt Gatling Air Cleaner Assemblies.

- Include integral breather system with bracket, mounting kit and air cleaner.
- Include air filter element.

DIY easy install bolt-on assembly has no hoses to connect!

BT Assemblies fit 1993-2007 FXST, FXD.

Assembly	Air Cleaner	Shape	Style
34-1601	34-0406	Round	Black, 7"
34-1427	34-0407	Round	Black, 8"
34-1602	34-0764	Oval	Black, Mesh
34-1603	34-0746	Oval	Chrome, Mesh
34-1604	34-1206	Diamond	Billet
34-1605	34-1373	Round	Chrome, 7" Motorcycle Logo
34-1626		Round	Chrome, 7" Smooth
34-1606	34-0475	Oval	Chrome
34-1607	34-0742	Round	Black, Mesh
34-1608	34-0732	Round	Chrome, Mesh
34-1609*	34-1119	Velocity Stack	Chrome
34-1636		Velocity Stack	Chrome
34-1611	34-0762	Round	Chrome, Drilled
34-1612	34-0763	Round	Chrome, Baby Moon
34-1637		Round	Chrome, 8" Smooth
34-1638		Round	Chrome, 8" V Logo
34-1639		Round	Chrome, 8" American Cycle
34-1641		Round	Black, Deco
34-1613	34-1374	Oval	Chrome, Late Style
34-1614	34-0628	Teardrop	Chrome, Maltese
34-1615	34-1735	Round	Chrome, Skull Mesh
34-1617	34-1429	V-Charger	Chrome, Skull, Black Skull
34-1644		V-Charger	Chrome, Skull
34-1618	34-1742	Round	Chrome, Hole Pattern
34-1619*	34-1081	Breather Snoot	Chrome
34-1620	34-1022	Teardrop	Chrome, Smooth
34-1621	34-0530	Teardrop	Chrome, Finned
34-1622	34-0511	Teardrop	Chrome, Flame
34-1623	34-0630	Teardrop	Chrome, Slotted
34-1624	34-0629	Teardrop	Chrome, Skull
34-1625	34-1020	Teardrop	Chrome, Live to Ride
34-1632		Teardrop	Chrome
34-1633		Teardrop	Chrome
34-1851		Teardrop	Chrome
34-1852		Teardrop	Chrome
34-1854		Teardrop	Chrome
34-1862		Teardrop	Chrome
34-1361		V-Charger	Chrome, Flame
34-1365	34-1334	Inverted	
34-1627		Skull	Chrome
34-1628		Skull	Black
34-1630		Diamond	Chrome, skull
34-1631		Diamond	Chrome, skull
34-1629		Sweeper	Chrome
34-1635		Scoop	Chrome
34-1634		Dish	Chrome
34-1640		High Flow, Exposed	

\*Note: Does not include filter element





# Air Cleaner

34-0510



34-0512



**5 3/4" Chrome Air Cleaners** are for 3 bolt carburetors. Includes foam washable element, 2 1/4" thick.

Bendix-Keihin CV Type	Element	Item
34-0510	34-0762	34-0079 Drilled
34-0512	34-0763	34-0079 Smooth
34-0915	34-0915	Element Only
34-0560	34-0560	Mount Kit



**Skull Mesh Air Cleaner** fits 1993-97. VT No. 34-1735

34-1345



34-1347



34-1346



34-1345



34-1346

**Black Hi Lighter Air Cleaners.** Order bracket kit separately.

VT No.	Style
34-1345	Torque
34-1346	Heathen
34-1347	Luxe



34-0475



34-0924



34-1350

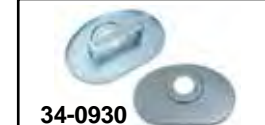

34-0930



34-0432

**Oval Air Cleaner Assemblies.**

CV	Keihin	Item
34-0475	34-0924	Assembly
34-1350	34-0930	Backing Plate
34-0432	—	Black Oval Insert



34-0831



34-0821



34-1284

**Axel's Chrome Billet Air Cleaners** fit to CV carburetors. Order mount kits separately. Bracket listed features built in breather passage and includes bolts for Evolution and TC-88 models.

VT No.	Style	Model
34-0821	Diamond	CV
34-0831	Skull	CV
34-1284	Skull	CV
34-0837	Diamond	S&S
34-0661	Bracket	Evolution and TC-88



34-0642



34-0643



34-0644



34-0645

**Rodan Billet Air Cleaners** available with hidden or external screws on cover to fit CV models.

External	Hidden Screws	Type
34-0644	34-0642	Flame
34-0645	34-0643	Smooth



**Caution:** These products are not legal for sale or use in California on pollution controlled vehicles. These products are intended for non-highway only.





**Chrome Maltese Carburetor Cover** includes backing plate and filter. Available as kit or carburetor cover and backing plate only. Kits include brackets and or breather kits as

required to fit stock original carburetor. Center portion of cross is matte chrome finish.

VT No.	Year	Model
34-1145	2000-07	TC-88
34-1146	1993-99	Big Twin
34-1147	1990-92	Big Twin
34-1148	1984-89	Big Twin



**Maltese Carburetor Cover and Backing Plate.** Center portion of cross has a matte finish. Order filter and brackets separately.

Chrome	Polish	Carburetor Type
34-0609	—	CV
34-0610	—	S&S "E"
34-0608	—	Bendix
34-1168	34-1168	Filter Only
34-1130	34-1112	Cover Only



**Chrome Velocity Stack Kits** include 2.5" chrome stack, chrome support bracket and breather kit with black or stainless hose kit as listed for stock Keihin or Bendix carburetors.

**With breather**

Black Hose	SS Hose	Year	Model
34-1115	34-1122	1993-99	Big Twin Evolution
34-1116	34-1123	2000-07	TC-88

**Without breather kit**

34-1117	—	1990-92	Big Twin Evolution
34-1118	—	1984-89	Big Twin Evolution
34-1126	—	S&S E & G	All
34-1127	—	4" S&S E & G All	



**Chrome Velocity Stack Kits** include chrome support bracket, breather nipples and 2.5" chrome stack.

VT No.	Model
34-1161	1992-99 Evolution
34-1151	1999-2007 TC-88
34-1150	Bracket

# Air Cleaner



**Turbo-Fan Velocity Stack** includes billet stack with inverted cone filter installed. Turbo fan turns on precision ball bearings up to 10000 RPM.  
**VT No. 34-1204**



**Early Style Carburetor Breather Snoots** feature chrome cover without filter. Bendix Keihin and CV is 3 bolt pattern. CV requires use of 35-0125 for 2000-up Big Twin or 35-0122 for 1993-99 Big Twin.

VT No.	Type	Year
34-1046	Bendix-Keihin	1971-87
34-1081	CV	1988-up
34-1253	S&S	1984-92
34-1254	S&S	1993-up
34-0659	Cover Only	
34-0273	Backing Plate	Bendix



**Turbo Funnel Fan** for use with velocity stack air cleaner.  
**VT No. 34-1199**



**Chrome Alloy Velocity Stacks.**

VT No.	Fits	Length
34-1102	S&S "E/G"	4"
34-1107	S&S "D"	4"
34-1108	S&S "E&G"	2.5"
34-1103	Bendix Keihin	2.5"
34-1104	CV Keihin	2.5"
34-1156	CV Keihin	4"
15-0884	CV Gasket	
15-0885	Bendix Gasket	
34-1159	Screen	



**Caution:** These products are not legal for sale or use in California on pollution controlled vehicles. These products are intended for non-highway only.







# Teardrop Air Cleaner

34-2123



**Chrome Sweep Air Cleaner Assembly** includes filter and backing plate to fit CV and electronic fuel injection applications. Order breather and brackets separately.

**VT No. Item**  
**34-2123** Assembly  
**34-2125** Cover Only

34-2125



34-0453



34-0455



**Chrome Scoop Air Cleaner Cover** mounts with 3-screws.

VT No.	Model	Item
34-0453	S&S "E"	Cover
34-0455	CV	Complete



34-0668  
Installed

34-0668



**Axel's Chrome Billet Sweeper Air Cleaners** fit to CV carbs. Order mount kit separately. Bracket listed features built in bolts for Evolution and TC-88 models.

VT No.	Style	Model
34-0668	Sweeper	CV
34-0661	Bracket	1992-94

34-3909



**K&N Chrome Billet Air Cleaner Assemblies** for Evolution Big Twin models with CV carburetor. Available in flamed, ball grooved or mirror finish and are complete with mounting hardware.

VT No.	Type	Style
34-3909	Ball Grooved	Teardrop
34-3333	Filter Only	Teardrop



**Chrome Eagle Spirit** is a 3 1/2" universal medallion, adhesive backed. Each.

**VT No. 42-0532**



SLOTTED



FINNED



SMOOTH WITH FLAMES



SMOOTH



EAGLE SPIRIT, GOLD



EAGLE SPIRIT



34-0629



34-0527  
Installed



34-0532



34-0916

**Teardrop Air Cleaners.** Order appropriate bracket set separately.

**Pre 1987**

**VT No.**

**Style**

34-0532	Eagle Spirit, Chrome, Bendix Keihin type
34-0544	Eagle Spirit Gold
34-0516	Smooth Chrome
34-0515	Smooth Polished
34-0520	Smooth Chrome Steel
34-0527	Smooth Chrome with Flames
34-0528	Finned Chrome
34-0631	Slotted Chrome

**1988-up CV Type**

34-1020	Live to Ride, A Way of Life Chrome
34-1022	Smooth Chrome
34-0511	Smooth Chrome with Flames
34-0530	Finned Chrome
34-0630	Slotted Chrome
34-0628	Maltese Chrome
34-0629	Skull Chrome

**Individual Parts For Above Units**

34-0518	Chrome Cover only
34-1560	Finned Cover only
34-0519	Bendix Keihin Backing Plate
34-1054	CV Backing Plate only, Alloy
37-8556	Chrome Three Piece Screw Kit
34-0545	Eagle Spirit Chrome Cover only
34-0905	Uni-filter Element only
34-0916	Foam Filter Element
34-0251	VT Element

**Brackets For Tear Drop Air Cleaners.**

**VT No.**

**Fits**

31-0430 1993-up Big Twin Evolution except Dynaglide

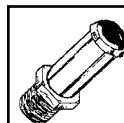

**Carburetor Vent Fitting** chrome steel nipple is 1/8" NPT for air cleaner back plates.

VT No.	Hose Size	Angle
40-0581	5/16"	Straight
40-0532	5/16"	90°

34-3905 Chrome Teardrop Air Cleaner  
 34-1343 Chrome Teardrop Assembly  
 34-0284 S&S Teardrop Air Cleaner



# Air Cleaner Insert



Inserts for Stock Round Air Cleaner to fit original covers.

Chrome/ Chrome	Chrome/ Gold	Black Gold	Chrome/ Black	Style
34-1431	34-1432	34-1433	34-1434	Eagle
34-1435	34-1436	34-1437	34-1438	Skull
34-1439	34-1440	34-1441		Flame



34-0050



34-0051

**Raised Skull Air Cleaner Inserts** features a chrome insert with raised black skull design. Available for 7" and 8" air cleaner assemblies.

VT No.	Model
34-0050	7" TC
34-0051	8" Evolution

**Air Cleaner Insert.**  
VT No. 34-1677



34-0590



34-0594

**Eagle Spirit Round Air Cleaner Insert** for 1999-up TC-88 models.

VT No.	Type
34-0590	Chrome
34-0594	Gold Inlay



34-0557



34-0558



34-0986



34-0987

**Air Cleaner Inserts** fit recessed area.

VT No.	Fits	Type
34-0557	Evolution 8"	Chrome
34-0558	Evolution 8"	Gold Inlay
34-0986	Oval	Chrome
34-0987	Oval	Gold Inlay



34-0060



34-0088

**Air Flow Air Cleaner Insert** available in chrome or black finish. Includes mounting hardware. Fits 1999-15 Big Twin except 2008-15 FXD models. For use with stock type air cleaner cover.

VT No.	Finish
34-0060	Black
34-0088	Chrome

# Air Cover Screws



**Air Cleaner Cover Allen Mounting Kit.**

VT No. 9916-2



**Air Cleaner Cover Mounting Screws.** Chrome custom button head countersunk allen screws mount cover on S&S air cleaners. Three screws per kit.

VT No. 9980-3

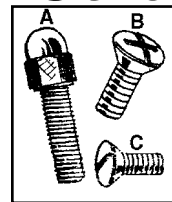

**Chrome Air Cleaner Screws.**

VT No.	#	Size	Style, U/M
37-8556	B	1/4 — 20	S&S, 3 pack
8212-3	C	5/16 — 24	Early Stock
7206-2	A	5/16 — 24	1957-77 Acorn, 2 pack
8461-2			As Above Cap
9916-2	B	5/16 — 18	Chrome Flat Allen
37-2096	C	5/16 — 24	Early Stock, 4 pack

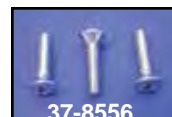

37-8556



**Caution:** These exhaust products are not legal for sale or use in California on pollution controlled vehicles. These products are intended for non-highway only.







# Teardrop Air Cleaner



2000-up TC-88 Oval Chrome Steel Air Cleaner Covers.

VT No.	Model
34-0400	Electronic Fuel Injection
34-0401	Carburetor
34-0444	Smooth Insert



**Teardrop Air Cleaner Kits** include chrome air cleaner assembly with smooth, finned or flame teardrop cover, chrome mount bracket and a breather kit with a black hose and breather unit.

Finned	Smooth	Flame	Year/Model
34-0663	34-0656	34-0650	1992-99 Big Twin
34-0664	34-0657	34-0651	1999-07 TC-88



**Chrome Slotted Air Cleaner Assembly** fits CV only. Order bracket and breather kit separately.

VT No.	Year	Bracket Kit
34-0630	1993-99	35-0122
—	2000-up	35-0125



**Siren Air Cleaner Assemblies** include cover, backing plate and mount hardware for Big Twin.

VT No.	Year
34-1527	1992-99
34-1528	2000-up



**Chrome Air Cleaner Cover** is a teardrop shape. Fits 2008-up FXD, Softail electronic fuel injected models.

VT No. 34-1291



**Air Cleaner Cover** fits 34-0948 tapered filter units.

Cover	Complete	Style
34-0276	34-1742	Holes
34-0280	—	Skull



**Flow Swept Air Cleaner Assembly** fits 1993-up Evolution and TC-88 models. Order VT No. 34-0823 bracket kit separately. VT No. 34-0824 backing plate accepts 8" type air clear cover.

VT No.	Item
34-0822	Air Cleaner
34-0824	Backing Plate
34-0823	Bracket Kit 1993-up Evolution and 1999-07 TC-88
34-0948	Filter Only
34-0548	8" Cover



**5" Mini-Teardrop Air Cover** fits CV carburetors. Order backing plate separately.

VT No.	Style	Backing Plates
34-1263	Maltese	34-1269 Keihin
34-1264	Skull	34-1271 S&S
34-1262	Smooth	34-1267 Bendix
34-1501	Smooth	34-1294 Linkert
		34-1268 CV



**Chrome Scoop Air Cleaner Cover** mounts with three screws.  
**VT No. Model Item**  
**34-0453** S&S "E" Cover  
**34-0455** CV Complete



**Chrome Steel Air Scoop** fits S&S E & G carburetors.  
**VT No. 34-0985**



**Billet Carburetor Support** on S&S "E" installations. Order banjo bolts and brackets separately for Evolution or TC-88. Bracket only drilled for S&S. No holes for CV air cleaner.  
**VT No. Finish**  
**34-1139** Chrome  
**34-1190** Alloy

## Velo-Dome™



**Velo-dome™** is Wyatt's velocity stack with built in cover for Super "E".  
**VT No. 34-1189**



## S&S Air Cleaner



**34-1174 Installed**

**Velocity Stacks** with built in mount brackets. Breather set included. For S&S "E" TC-88/Evolution 1992-up.

**VT No. Style**  
**34-1110** Standard Kit  
**34-1174** Billet Kit

**VT No. Fits**  
**15-0354** Mounting Gasket



**Chrome Air Cleaner Covers** fit S&S carburetors stock backing plate and filter, "bolt on."

Super E	Super B	Style
—	<b>34-0545</b>	Eagle Spirit Chrome
<b>34-0707</b>	—	Skull
<b>34-0709</b>	—	Maltese
<b>34-0710</b>	—	Flame



**Replica Air Filter Elements** fit S&S models and are washable.

VT No.	Model
<b>34-1176</b>	E&G
<b>34-0935</b>	B



**Chrome S&S Super E & G Air Cleaners** are available as complete units, or replacement covers only. Complete assemblies include backing plate which have built-in brackets to mount to Evolution heads. Fits 1986-91 Evolution XL with Super E & G carburetors and 1984-91 Evolution Big Twins with Super E & G carburetors.

VT No.	Item/Fits
<b>34-1015</b>	Complete Assembly 1993-99 V2 Big Twin
<b>34-0981</b>	Chrome Cover All Super 'E'
<b>34-1063</b>	As Above with Notched Cover for 5 Gallon Tanks
<b>34-0984</b>	Uni Filter Foam Air Filter Super 'E' Foam Type
<b>9980-3</b>	Chrome Allen Screw Set for S&S Covers
<b>34-1097</b>	Backing Plate 1984-92
<b>34-1098</b>	Backing Plate 1993-up
<b>15-0354</b>	Mounting Gasket



**Caution:** These products are not legal for sale or use in California on pollution controlled vehicles. These products are intended for non-highway only.







# Air Cones



34-0772



**Chrome Panzer Air Cone** can be installed on C.V. or S&S Super E carburetors. Order routing bracket separately. Can be mounted in either vertical or horizontal position. Includes air filter.

**VT No. Type**

34-0772 Spike with slots

34-1880 Spikes with holes

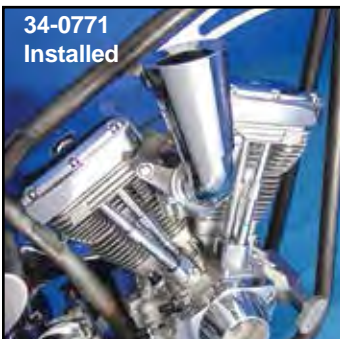

34-0771  
Installed



34-0771



34-0770

**Air Cleaner Breather Only** includes cone, element and elbow as shown. Fits 1993-2007 CV in the horizontal position.

**VT No. Type**

34-0770 Spike

34-0274

Filter Only

34-0771 Funnel



34-0773  
Installed



34-0773



**Cycovator Taper Forward Mount Air Cleaner Only** fits 1993-up Big Twin models. Brackets sold separately.

**VT No. Item**

34-0773 1933-07 CV-Electronic Fuel Injected Only



34-0670



34-0670



34-0670 installed with  
34-0693 adapter



34-0451 with  
34-0693 adapter



34-0775



34-1211

**CV Air Cleaner Cone System** features cone and integral breather mount bracket for vertical or forward mounting. Order adapter plates for vertical applications.

**VT No. Carburetor Type**

34-0775 S&S "E"

34-1211 1993-07 CV, Delphi EFI



34-0488  
Installed

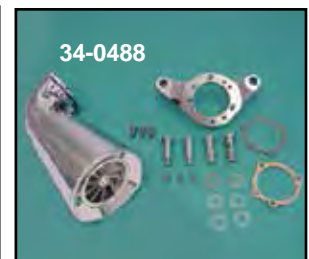

34-0488

**Wind Funnel Air Filter Kit** includes bracket with integral breather which will mount the funnel in a forward horizontal position. Order with or without turbo fan.

**VT No. Type**

34-0488 Fan (1993-2007) with CV carburetor

34-1207 Without

- Super Spiral runs up to 10,000 RPM to match your high revving engine.
- Help provide a better fuel mixture and combustion

34-1197



**Turbo Funnel** will mount on CV carburetor bolt pattern in a forward horizontal position. Order adapter plate 34-0693 to place in upright vertical position. Fits 1993-2007 Big Twin CV-Delphi-EFI

**VT No. 34-1197**



34-0451



34-0451 Installed

**Air Cleaner Breather** includes steel bracket with breather bolts and tapered filter element with chrome 90° intake tube to face forward on CV carburetors. Order adapter to face forward or upward on S&S models. Use 34-0670 with 34-0693 adapter. For 1993-07 models.

**VT No. Item**

34-0670 Spike

34-0451 Funnel

34-0673 S&S Adapter

34-0693 CV Vertical Adapter

34-0671 Filter Only (Spike)

34-0274 Filter Only (Funnel)

**Style**

Forward

Forward



34-0671



**Oval Air Cleaner Assembly.**  
 VT No. Fits  
**34-1374** CV  
**34-1382** Keihin

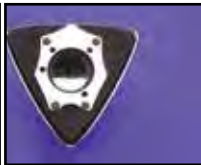

**Diamond Billet Air Cleaner** fits CV models.  
**VT No. 34-1206**

**Maltese Velocity Stack** fits CV and S&S carburetors with unique fluted design. Order S&S adapter to fit "E" carburetors. This Quaductive™ design increases air flow. Screen included. Order screws separately.

VT No.	Item	Finish
34-1160	CV Stack	Natural
34-3915	CV Stack	Chrome
34-0673	S&S "E" Adapter	Alloy
34-0661	Bracket Only CV	Chrome
34-0662	Bracket Only S&S E	Chrome
34-1111	Screen	Stainless Steel
37-0894	Screw Set	(3 Pieces)

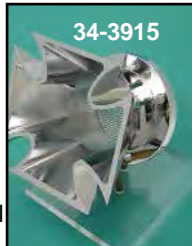

**Cycovator Air Cleaner Kit** fits 1999-up Big Twin with carburetor. High filtration element included with all parts as pictured. Order 34-1186 adapter sleeve to fit 1993-98 Evolution models.

**VT No.**  
**34-1340** Backing Plate  
**34-0062** Kit with cover



## Cone Air Cleaners



**Filters** fit as noted are attached by worm drive clamp. Inner diameter of 65 mm.

VT No.	Length (mm)
34-0892	140 mm
34-1504	133 mm
34-0891	175 mm

**K&N RK Series Air Cleaner Assembly** for 1999-07 Twin Cam Big Twins with a carburetor. Complete assembly provides significant increase in air flow to the engine while boosting performance and filtration. Features a built in Dyno tuned velocity stack, powder coated aluminum backing plate and internal breathers. Uses stock type air cleaner cover.

**VT No. Height**  
**34-0107** 1 5/8"  
**34-0116** 2 1/4"



**V-Force Air Cleaner** fits CV and electronic fuel injection models. Order breather bracket separately. (1993-07 CV-Delphi-EFI)  
**VT No. 34-1882**



**K&N AirCharger® Intake Kit** features a mandrel bent mirror polished intake tube and a chrome top conical shaped K&N High flow air filter.\***Note:** Fits fuel injected models only. Fits 2001-up FXST, FLST, FXD.  
**VT No. 34-0076\***





# Replica Air Filter



**Replica Paper Air Filters** feature original shape and styling for exact fit. Washable construction.

**For Aftermarket Air Cleaner**

VT No. Fits

- 34-0935 S&S Super "B"
- 34-1176 S&S Super "E" & "G"
- 34-0251 S&S Super "E" & "G" Teardrop
- 34-0948 Tapered, Velo, Ness & Screamin' Eagle Stage 1 Multfit Kits; Pre-Oiled
- 34-1348 Tapered, Velo, Ness & Screamin' Eagle Stage 1 Multfit Kits; Pre-Oiled
- 34-1334 Inverted Cone Type, Velo, Ness & Screamin' Eagle Stage 1 Multfit Kits; Pre-Oiled
- 34-1324 Screamin' Eagle Stage 1 Touring Kits
- 34-0066 Burst Collection

**For Big Twin models with Stock Air Cleaner**

- 34-0933 1991-95 Evolution 1340 Dyna, FXR, FXST, FLST, FLT
- 34-0962 1991-06 TC-88, carburetor, 2002-07 carburetor and electronic fuel injection
- 34-1171 1999-01 Twin Cam FXST, FLST, FLT, FXD with electronic fuel injection
- 34-0737 2008-up FXD-FXDWG
- 34-0737 2008-up FXD
- 34-0740 2008-up FXD
- 34-1208 2008-13 FLT, FLHT
- 34-0063 2014-16 FLT, 2016-up FXST, FLST
- 34-1067 Sifton Air Power™
- 34-1066 Screamin' Eagle



**Air Filters** are available in 3 types, K&N paper, Uni Filter foam and Accel 2-stage foam. All have screen insert.

**K&N Accel Uni Foam Fits**

**For Aftermarket Models**

K&N	Accel	Uni Foam Fits	
34-0960	34-0975	34-0905	S&S Super B
34-1010	—	34-0984	S&S Super E & G
34-1009	—	—	Mikuni HSR-40 smoothbore
34-1078	—	—	Mikuni HSR 42/45 smoothbore
34-1195	—	—	Screamin' Eagle Tapered
34-1040	—	34-1298	Screamin' Eagle Round
34-1066*	—	—	As Above, Oblong
34-1238	—	—	Screamin' Eagle
34-1239	—	—	Screamin' Eagle
34-1070	—	—	Hyper Charger

**For Big Twin Models**

VT No.	Size	Item
34-1328	—	—
34-0737	—	—
34-0736	—	—
34-0576	—	—
34-0579	—	—
34-0917	—	—
34-1047	—	34-1068
—	34-0973	34-0976
34-0958	—	34-0911
34-0955	34-0971	—
2014-16 FLT, 2016-up FXST, FLST		
2008-up Dynaglide		
2008-13 FLT, FLHR		
1999-06 TC-88 w/carb all models		
2002-07 FLT-FXD, TC-88 w/EFI		
2002-15 FXST w/EFI		
1999-2001 TC-88 FLT, FXST, FLST, FXD with EFI		
1995-99 80" Evo with EFI		
1993-99 80" Evo		
1991-95 80" Evo		
1990-92 80" Evo		
1986-89 80" Evo		
1984-85 80" Evo, not FLT		

\*Note: OE Brand



**K&N Aerosol Recharger Service Kit** is a six step maintenance system designed to recharge any K&N air filter. Restores air flow efficiency. Includes 6.5 oz spray oil and 12 oz filter cleaner.  
VT No. 41-5000



**Air Filter Oils and Cleaners.** K&N type is for paper elements. Unifilter type for foam elements.

VT No.	Size	Item
41-0171	12oz	K&N Cleaner
41-0172	6.5oz	K&N Oil
41-0173	16oz	Unifilter Cleaner
41-0174	5.5oz	Unifilter Oil

# Air Cleaner Mount



BIG TWIN



**Sifton  
Carburetor  
Bracket  
No Hoses  
Needed!**

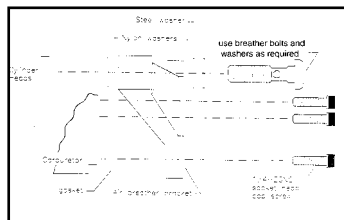
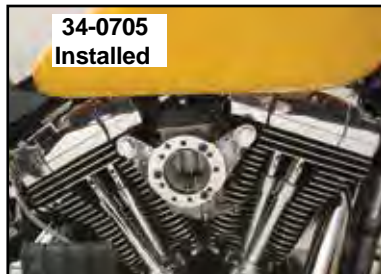

**Chrome Billet Support Brackets** allow crankcase to breathe back into the carb or throttle body so no external hoses are required.

For use on 1993-98 Evolution and 1999-up Twin Cam models. Allow use of CV on S&S "E" bolt pattern air cleaners or velocity stacks to be installed on models listed.

**1993-15 FXST, FLST with carb or EFI, 1993-07 FLT w/carb or EFI and 1993-up FXD with carb or EFI. For use w/CV on S & S "E" type air cleaner or velocity stacks.**

**34-0661**

**1993-15 FXST-FLST with carb or EFI, 1993-07 FLT with carb or EFI, 1993-up FXD with carb or EFI for use with CV or S&S "E" type air cleaners or velocity stack to be installed in horizontal or vertical position.**

**34-1519** 1993-up includes Evo & TC bolts

**34-0713** 1999-up includes TC breather bolts only

**1999-15 FXST-FLST with carb or EFI, 1999-07 FLT with carb or EFI, 1999-up FXD with carb or EFI, Allows the installation of CV type air cleaners.**

**34-0705**

**2008-16 FLT, 2016-up FXST-FLST with 50 mm throttle body.**

**34-1369** Mounting Bracket

**1993-06 Big Twin with S&S Super "E" or "G" carb and air cleaner.**

**34-1179**

**1993-06 Big Twin with S&S Super "E" or "G" carb allows installation of CV.**

**34-0662**

**1993-06 Big Twin with S&S Super "E" or "G" carb allows installation of CV type. Air cleaners or velocity stacks to be installed in vertical or horizontal position**

**34-1510**

**34-1185**

**1993-06 Big Twin with Mikuni HSR42/45/48 carbs with Mikuni or CV air cleaner or velocity stack**

**34-0445**

**Replacement Bolts for Above Brackets.**

**35-0791** Bolt Set

Evolution

**35-0792** Bolt Set

TC-88

## Air Cleaner Adapters

- Will mount any CV carburetor air cleaner to performance aftermarket carburetor kits.
- Simply order any CV air cleaner and appropriate adapter flange for bolt on installation.

## Adapter Flange

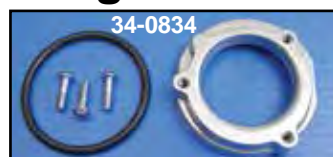
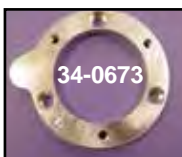

**Air Cleaner Adapter Plate** will adapt any CV style 3-bolt air cleaner to the Mikuni, Keihin or S&S E&G as noted.

VT No.	To:	Size
<b>34-0673</b>	S&S	E&G
<b>34-0619</b>	Keihin	38mm
<b>34-0834</b>	CV to Mikuni	42 and 45mm



**Air Cleaner Spacer** is .560" thick and will allow installation of stock S&S air cleaner on 34-1185 integral mount bracket.

**VT No. 34-1526**

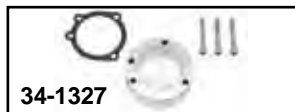

**Air Cleaner Adapters** allow installation of Dragton II air cleaner to models listed. Plain machine finish.

VT No.	Fits
<b>34-1326</b>	2008-14 FLHT, FLHX, FLR FLTR and FL Trike
<b>34-1327</b>	2001-14 w/Delphi EFI except 2008-14 Dressers and FL Trike





# Breather Kit



**Sifton Braided Hose Crankcase Breather Kit** features 3/8" inner diameter, stainless steel braided hose attached. Includes breather filter (with mounting stud), 24" hose and hardware. Air cleaner and carburetor support bracket must be purchased separately. Fits 1993-up Big Twin custom applications only.

VT No.	Item
35-0123	Kit
40-0570	Breather
35-0126	Bolt Kit

**"Y" Breather Kit** includes fittings to fit TC-88 with breather. Drill and tap frame to connect.  
VT No. 35-0578

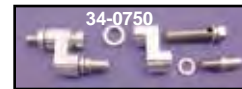

**Air Cleaner Breather Manifold Kits** to fit custom air cleaners to engines with the internal breathing system. Kit includes chrome breather manifold, chrome banjo bolts, chrome air cleaner support brackets, gaskets and instructions.

VT No.	Item	Year/Fits
35-9254	Kit	1993-99 Big Twin Round
31-0430	Kit	1993-15 FXST, FLST, 1993-07 FLT, 1993-up FXD
35-0670	Tube Only	1993-15 FXST, FLST, 1993-07 FLT, 1993-up FXD
35-0731	Pair	Banjo Bolt only, 1992-99 Evolution
35-0732	Pair	Banjo Bolt only, 1999-07 TC-88
14-0975	For Above	O-Ring

**Billet Air Cleaner Mount Set** will mount air cleaners with flat backing plates to Evolution and TC-88 models. Offset billet mounts feature built in breather passage that feeds inside air cleaner housing. Brackets can be rotated to proper position, then backing plate must be drilled to match. Threaded breather nipples will fasten back plate to brackets.

VT No.	Year	Type
34-0750	1991-99	Evolution
34-0751	2000-up	TC-88

**Breather Washer Set** fits 1993-up Big Twin, 1991-up XL models.  
VT No. 35-0755



**Chrome Air Cleaner Support Brackets** are for installing the custom round or teardrop air cleaners. Fits 1984-92 Evolution Big Twin.  
VT No. 31-3941



**Chrome Air Cleaner Bracket** for Evolution Big Twin mounts to boss on engine heads to support custom air cleaners.

VT No.	Year
31-4041	1984-89
31-4191	1984-89 with choke bracket
31-3962	1990-92 CV
31-0750*	1993-15 FXST, FLST, 1983-07 FLT, 1993-up FXD

\*Note: To be used with breather kit.

**Breather Bolts** fit 1993-up Big Twin models. 35-0578 has thru vent holes.

VT No.	Year	Type
35-0731	1992-up Evolution	Hex
35-0732	1999-07 TC-88	Hex
34-0578	1999-07 TC-88	Nipple
34-1509	2008-up TC-88	Nipple
35-1706	1992-up Evolution	NPT
34-1507	1999-07	Rubber
34-1508	2008-up	Rubber
34-0098	Bolt Set	Studs

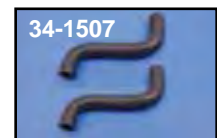
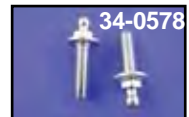

**Sifton Mini-Breather Bolt Kit.** Chrome breather cups have built in mount bolt for Big Twin models.  
VT No. Year  
40-0453 1992-99 Big Twin  
40-0454 TC-88



**Extended Breather Bolts** allow mounting of air cleaner to breather bolt stand. Use with banjo set or cross line for breather connection.



VT No.	Type
35-0136	TC-88
35-0129	Evolution/XL
35-0144	Banjo Set
34-1186	Adapter



**Breather Bolt and Banjo Kit** includes bolts for both Evolution and TC-88 applications and two banjos to accept 3/16" hose.

VT No.	Item
34-0500	Without tee
34-0808	With tee
37-0985	Evolution Nylon Washers
37-0986	TC-88 Nylon Washers
37-0989	TC-88 Alloy Washers



**Chrome Mini Breather Set** includes tie wraps.  
VT No. 40-0588



40-0346 installed on 34-1174



**Chrome Billet Canister Set** includes bolts for Evolution and TC-88 applications.  
VT No. 40-0346



40-0446



40-0449



40-0450

**Sifton Breather Canister** features enclosed breather filter and tube for attaching to breather cross over lines, which is held in place by set screws. Bottom cover is removable for cleaning.

VT No.	Item
40-0446	Canister
40-0449	Breather Tube Kit
40-0450	Tube Only

**Chrome Billet Single Breather Canister** fits cross over metal tubes. Grind down ferrule on end of cross tube to install.

VT No. 40-0345



35-0441

**Sifton Dual Vent Kit** includes two vent canisters and banjo bolts for 1992-up Evolution and TC-88 models with necessary fittings.

VT No. 35-0441



**Sifton Dual Breather Kit** includes two canisters and banjo tubes with hardware for Evolution and TC-88.

VT No. 40-0451

**V-Twin Mfg. supplied components for every aftermarket motorcycle company who sprang up due to the shortage of Harley-Davidson motorcycles. Startups included:**

- Big Dog (1994-2011)
- Excelsior-Henderson
- Ultra
- American Iron Horse (1995-2008)
- Confederate
- Gilroy Indian Co. (1999-2003)
- Orange County Choppers
- California AMC (1993-97)

# Breather Canister Breather and Bracket Kit



35-0122



35-0125

**Crankcase Breather and Bracket Kit** allows installation of aftermarket CV type air cleaner on models with CV carb or EFI system. Includes bracket, filter, hose and mounting hardware.

VT No. Fits

**35-0122** 1993-98 FXST, FLST  
1993-98 FXD (Includes Evo bolts)

**35-0125** 1999-2015 FXST, FLST

1999-up FXD (Includes Twin Cam breather bolts only)

**40-0350** Filter for Above



**Sifton Dual Breather Kit** includes two canisters, banjo tubes and bolts for Evolution and TC-88 applications.

VT No. 40-0436



**Sifton Dual Canister Set** includes hardware for both Evolution and TC-88 models.

VT No. 40-0452



**Breather Canister Kit for TC-88 models.**  
Fits 1999-up FX-FL.  
VT No. 40-0892





# Breather



**Chrome Crankcase Breathers** available to accept hose or 1/8" NPT fitting.

VT No.	Type
40-0434	3/8"
40-0447	1/8" NPT

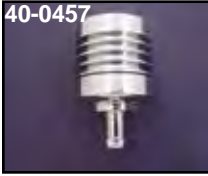

**Chrome Vented Breather Canister** accepts 1/8" NPT fittings, not included.

VT No.	Item
40-0457	Breather
40-0449	Banjo Tube Kit
40-0450	Straight Tube Only



**Uni Filter Crankcase Breather** is plastic construction with a zip tie loop for attachment and is washable for reuse.

VT No.	Size	VT No.	Size
40-0355	5/16"	40-0353	1/2"
40-0354	3/8"	40-0352	5/8"



**Engine Breather Oil Collector** designed to collect the oil mist from breather hose which eliminates engine oil from collecting in air cleaner. Available in chrome plated finish. Features a high flow air filter which acts as a internal oil baffle allowing the oil and air to separate more efficiently by promoting unrestricted breathing. The air filter can easily be cleaned. A 90° barbed fitting fits breather hoses perfectly. On the bottom is a drain plug to allow drainage on a regular basis. Measures 5 3/8" x 1 1/2" and includes chrome mounting clamp.

VT No.	Finish
40-0595	Chrome
40-0582	Replacement Filter



**Chrome Billet Crank Case Breather** includes 1/8" NPT fittings.  
VT No. 40-0003



**Chrome Crankcase Vent** clamps direct to 3/8" breather hose. Unit comes with a 5/16" stud and nut or 1/4" x 20 threaded insert to mount from bracket. Measures 2" diameter x 1 1/2" high.

VT No.	Type
40-0381	Stud, K&N
40-0570	Threaded



**Crankcase Breathers** connect to breather hose when stock air cleaner has been replaced. Filters feature chrome tops with washable elements. Bracket can be mounted to transmission case. VT No. 40-0246 includes chrome bracket fastened to body by allen screws, hose fitting is 1/8" NPT threaded into body and can be changed to 90° for special applications.

VT No.	Type
40-0356	With bracket
40-0357	Without bracket
40-0246	With bracket



**Sifton Universal Breather Vent Canister** is a one way check valve; includes line and clamps. Non serviceable unit.  
VT No. 40-0445

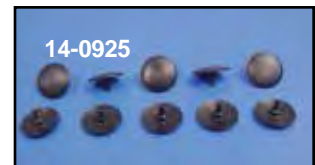

**Crank Vent** features replaceable umbrella valve available separately.

VT No.	Item
40-0875	Canister
14-0925	Umbrella Valve (10)



**Breather Oil Collector Can** includes chrome clamp. Order filter separately.  
VT No. 40-0652



# Intake Manifold 1984-up



**Manifold Kit** for Evolution Big Twin converts stock rubber compliance fittings to a more rigid mount system. Order flange seal kit separately for S&S.

VT No.	Item	Brand
35-8018*	Manifold	S&S
35-8035	Manifold Kit	V-Twin
35-0427	Flange Set, Chrome	
35-0428	Flange Set, Natural	

\*Note: Use flange kit 35-0427 or 35-0428



**Intake Manifold Coupler Kit** includes one each of 27008-83A and 27012-83A compliance fittings with clamps. Fits Evolution.

VT No.	OEM	Item	U/M
35-8012	Kit	Coupler	Pair
35-9137	9991A	Clamps	Pair
15-0263	29242-83	Gaskets	10
15-1018	29242-03	Gaskets (James)	10
37-8962	3494	Stainless Steel Allen Screws	



**James Manifold Seal Kit** to reseal late model manifolds 1988-up.

VT No.	Item
14-0976	1989-up with CV carb
14-0690	2000-up with 44mm carb
14-0691	1999-up TC-88 with EFI



**Tru Seal Manifold** with two machined manifold halves which bolt together with stainless allen screws. Does not require the use of existing stock style O-rings or seals. Evolution type also includes front and rear head spigots, gaskets, sealing compound and instructions included. Fits 1985-98 Evolution Big Twin "G" models.

VT No. 35-0075

**Stock Intake Manifolds** are of cast alloy spigot type as original.

VT No.	OEM	Fits
35-9169	27019-89	1990-99 Evolution
35-0652	27613-99	1999-up TC-88
35-0161	Flange Kit	

**Manifold Flange Kits** replace 27009-86A and 27010-86A for Big Twin 1340 1986-up.

VT No.	Type
35-0427	Chrome with Seal and Screw
35-0428	Natural with Seal and Screw
35-8027	Chrome Flange Set Only
35-8028	Natural Flange Set Only
14-0165	Seal
14-0573	Blue Seal

**44 mm CV Intake Manifold Flange Kit.**  
VT No. 35-0161

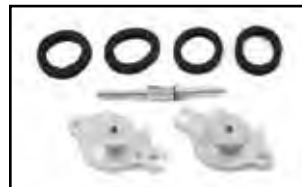

**Intake Manifold Width Gauge** allows accurate measurements to be taken between cylinder heads to establish intake manifold width requirements.

VT No. 16-0250

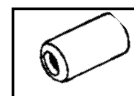

**1995-up Vacuum Line Plugs** available in packs of 5. VT No. 35-0384



**Intake Manifold Chrome Allen Mount Screws.**

VT No.	Year	Model
9930-14	1986-89	Big Twin
9930-14-P	As Above	Polished

### Air Cleaner Mount Gaskets.

James	VT No.	OEM	Years
15-1146	15-0148	29058-77	1977-89
15-1016	—	As Above	.062 thick
15-1017	15-0285	29059-88	1988-up CV type
15-1147	—	As Above	Steel Core
15-1148	—	As Above	Adhesive Coated
15-0596	—	29095-95	1995-00 Electronic Fuel Injection
15-1199	—	29062-95B	1995-06 Carburetor
—	15-1527	28583-01A	2001-up Carburetor
—	15-1568	29645-08	2008-up Electronic Fuel Injection







# Intake Adapters & Seals



**CV Carburetor Adapter Flange** is 2 bolt early style type without seal.  
VT No. 35-9150



**Manifold Spacer** replaces 29250-78 on 1971-88 models. 3/8" thick.

VT No.	Item
15-0141	Stock Spacer, each
15-1019	As Above, James
15-0142	Gaskets, Non-beaded
15-1144	Gaskets, Beaded
15-1019	Spacer Kit, James (1 3/4" inner diameter) Stock
15-1162	Spacer Kit, James (1 3/8" inner diameter) Custom



**Carburetor Spacers** for S&S are available in 1" or 3/8" thickness for spacing out 1 7/8" carburetors on models with 5 gallon tanks.

VT No.	Size
35-0105	1"
35-0086	3/8"

## Bendix 40 mm



**Zenith 40mm Performance Spigot Mount Carburetors Kit** for all 1984-up Evolution and Twin Cam models with dual cable operation. Features adjustable main jet, butterfly type choke, spigot mounting and acceleration pump. Use stock type cables and air cleaner. Comes complete with all fittings, adapters and instructions. Kits sold as shown.

VT No.	Finish
35-0023	Standard
35-0024	Chrome



### Carburetor Adapters.

VT No.	Carb Size	Type
35-9136	36-45 mm	Spigot Rubber
35-0117	42 mm	Spigot Rubber
35-0194	40-44 mm	Spigot Rubber
35-4574	36-38 mm	Flange Adapter
35-9162	42 mm	Flange Adapter
35-9340	42 mm	Flange Adapter
35-9341	46 mm	Flange Adapter
35-0098	38 mm	2 Bolt Adapter with rubber
35-0088	38 mm	2 Bolt Adapter



### Intake Manifold O-Rings and Seals.

James	VT No.	OEM	Type
14-0624	14-0165	26995-86A	1986-up
14-0573	—	As Above	Blue silicone
14-0678	—	As Above	Oversize
14-0689	—	As Above	Rubber with metal element Standard Size
14-0708	—	As Above	Rubber with extra thick metal insert standard size
14-0625*	14-0180*	27002-89	1990-up Big Twin
—	14-0690	—	2000-up with electronic fuel injection, 44mm
—	14-0691	—	1999-up TC-88

\*Note: Seal for carburetor to intake manifold.

## DELL'ORTO

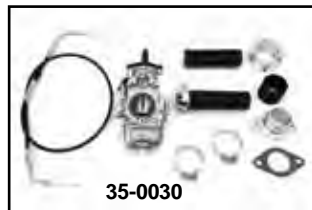

**Dell'Orto Pumper** features adjustable accelerator pump and choke. Kit includes throttle assembly, cable, grips, air cleaner adapter and carburetor adapter to fit stock 2 bolt or Shovelhead manifolds on pre 1985 models.

VT No.	Item	Model
35-0030	38mm Complete Kit	Shovelhead
35-0031	40mm Complete Kit	Shovelhead
35-0053	38mm Complete Kit	Panhead
35-0238	38mm	Carburetor Only
36-2550	Throttle Cable	

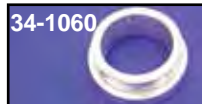

**Dell'Orto Pumper Air Cleaner Flat Adapter** allows use of Bendix air cleaners.  
VT No. 34-1060



**Dell'Orto Spigot Carburetor Adapters.** O-Ring seal with steel flange.  
VT No. 35-9076

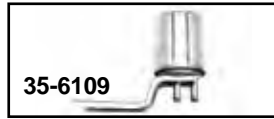
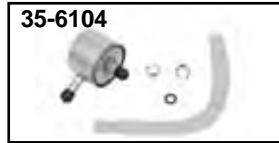

**Fuel Filter and Parts.**

**VT No. Models**

- 35-6105** 2007-08 FXST, FLT, FLHT, FLHR, FLST
- 35-6106** 1995-01 FLT, FLHT, FLHR
- 35-6104** 2002-07 FXST, FLST, FLHT, FLT, FLHR
- 35-6108** Replacement Fuel Line, FXST, FLST, FLHT, FLHR
- 35-6109** Replacement fuel filter kit is OEM style and fits Evolution Touring models.



**Billet Flange Set** for use when installing larger throttle bodies for electronic fuel injection.

**VT No. 35-0787**



**Induction Flange Set** will adapt 34-0181 to 34-0705 Sifton breather bracket.

**VT No. 34-1523**



**Magneti Marelli Fuel Injection to Carburetor Petcock Conversion Fitting Set.** Converts all 1995-01 Big Twins equipped with Magneti Marelli Fuel Injection System to carburetor system. Can be used with any 22mm petcock. Fits 1995-up FLT models.

**VT No. 35-0751**

## ThunderJet®



**ThunderJet® Electronic Fuel Injection Throttle Body, Manifold and High Flow Air Cleaner** available in 50mm and 54mm) CNC-machined castings replace the 44mm factory designs used on Delphi®-equipped 2001 and later models, are designed to accept the factory electronic components, including injectors, so assembly is a snap. Matching manifolds (required) are available for most popular engine kits from 95" up to 124".

**VT No. Description**

- 35-0137** 50mm EFI Throttle Body with cruise control
- 35-0138** 54mm EFI Throttle Body with cruise control
- 35-0153** EFI Manifold w/ 5.013"-5.016" Long Cylinders fit S&S 124" Kit and Jims 116" Kit
- 35-0154** EFI Manifold w/4.975-4.980" Long Cylinders fits 117" Kit
- 35-0155** EFI Manifold with 5.037" Long Cylinders fits 120" Kit
- 15-1200** Induction Module Gasket
- 15-1201** EFI Filter Gasket

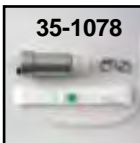

**EFI Replacement Fuel Pump Kit** is a direct replacement for the OEM pump and includes pump hose and hardware.

**VT No. Fits**

- 35-1075** 1998-99 FLT
- 35-1076** 2000-01 FLT
- 35-1077** 2008-15 FLT
- 35-1078** 2004-up FXST, FLST, FLST, FXD

# EFI Components



**Chrome Manifold Cover** fits 2004-up FXD, 2001-up Softail and 2002-16 FLT replaces 27483-07.

- VT No. Item**
- 34-0100** Kit
- 15-1527** Gasket



**Chrome Fuel Fitting** fits 2006-up FLT.

**VT No. 35-0950**



**Electronic Fuel Injection Induction Bracket** fits 2008-16 Touring.

**VT No. 31-4195**



**Chrome Induction Module Cover.**

**VT No. 42-1161**



**Intake Flange Set** fits electronic fuel injection models 2007-up.

**VT No. 34-1188**



**S&S Fuel Pump** for fuel injected custom bikes. Hollow mounting bolts secures the pump flange to the bottom of nearly any fuel tank and provides an outlet for wiring and pressurized fuel. A fiber media filter placed at the lowest point in the tank prevents contaminants from damaging the pump or clogging fuel injectors. Pump has a samp draw, 58 PSI and a 45L per hour rating.

**VT No. 35-5089**

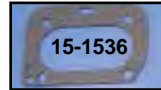

**Electronic Fuel Injection Gaskets.**

VT No.	OEM	Type	Year
<b>15-1536</b>	29368-99	Induction	1999-07
<b>15-1537</b>	29465-99	Air Filter	1999-07
<b>15-1297</b>	29718-08	As Above	James
<b>15-1568</b>	29645-08	Air Filter	2008-up



**Jims Ellipse 53mm EFI Throttle Body** with electronics have an impressive performance when used on all EFI throttle cable motorcycles. Compatible with OEM and aftermarket throttle position sensors, air control motors, fuel injector assemblies, and most ignition systems. **Do not use on models that are equipped with throttle by wire controls.** Manifold is sold separately. The manifold is also wider to fit most taller engines and is available in two sizes. Use on all 95" to 131" Twin Cam motorcycles. Use on 2006-up FXD and FXST and 2006-07 FL.

**VT No. Item**

- 35-5209** 53mm throttle body with electronics (manifold sold separately).
- 35-5210** 53mm throttle body without electronics (manifold sold separately)
- 35-5211** Manifold with electronics for engines with stock
- 35-5212** Manifold without electronics for engines with stock





# CV Keihin Carburetor



**Keihin Carburetor Rebuilds** contain needle, proper o-rings and diaphragm.

VT No.	Year	Brand
35-0200	1976-78	GB
35-0240	1976-86	Keihin
35-0196	1983-89	GB
35-0219	1976-86	James
35-0416	1989-up CV	GB
35-0422	1988-up CV	James

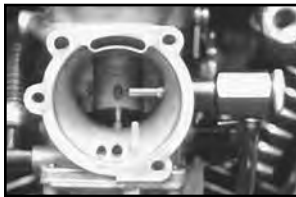

**ThunderJet Accelerator Jet & Accessories** mounts in all Bendix-Keihin, S&S, flowmaster, Tillotson, and CV carburetors. Choke must be deleted for use. Works on Venturi vacuum principle as third jet. Extra jets included.

VT No.	Type
35-1972	ThunderJet Bendix Keihin, S&S E series
35-1976	ThunderJet for CV. Carburetor
35-0179	ThunderJet for S&S G & D Carburetor
35-9244	Replacement Jet Tube



**Deluxe Carburetor Kits** include all pieces shown for 1976-89 Keihin carburetors.

VT No.	Type
35-9172	Stock
35-9176	Viton
35-9279	Replica

**Keihin Low Speed Jets** fit 1976-89 Keihin carburetors, except CV.

VT No.	OEM	MM
35-0297	27896-79	.65
35-0294	27894-78	.68
35-0296	27897-78	.72
35-0295	27382-77	.75
35-0299	27348-77	.88
35-0298	27348-76	1.00



**Keihin Carburetor Fitting** replaces 27371-76, 90°, plastic, each.  
VT No. 40-0534



**Adjustable Idle Mixture Needles** provide adjustment for Keihin carburetors. Fits CV type.  
VT No. 35-0130

**Keihin Main Jets.**

VT No.	OEM	MM
35-0357	27419-76	1.65
35-0358	27418-76	1.70
35-0359	27417-76	1.75
35-0361	27416-76	1.80



**Accelerator Pump Kit** improves throttle response on 1979-88 type Keihin carburetor models with a greater volume of fuel from the pump circuit.  
VT No. 35-9050



**Slow Jet Screw Driver** facilitates removal of Keihin slow jets with no damage to jet.  
VT No. 16-0546



**Keihin Adjustable Main Jet.** Full adjustability for maximum tuning efficiency.  
VT No. 35-0369



35-0230

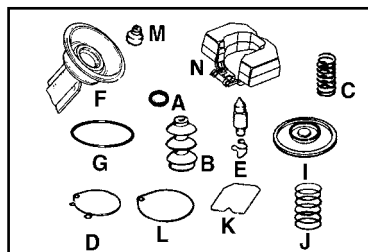

**High Flow Fuel Inlet** replaces broken fuel inlet to the carburetor bowl for modified engines. Fits all Keihin carburetors (Butterfly and CV) 1976-up Shovelhead, Evolution, TC-88.  
VT No. 35-0134

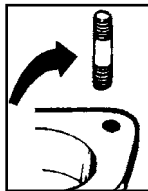

**Carburetor Mount Stud Set** replaces 29254-78. Fits 1978-89. Length is 1 1/4"  
VT No. 12-2110

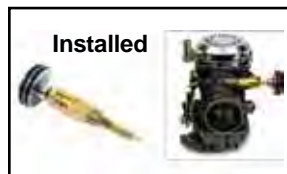

**Enricher for CV Carburetors** will eliminate choke cable. Unit has three positions.  
VT No. 35-0447



**Needle Jet Seat Cutter** eliminates gasoline seepage from around the needle jet. Creates a smooth and concentric seat  
VT No. 16-0095

## Keihin Carburetor Parts and Accessories

VT No.	#	OEM	Item
14-0921	A	27121-89	Float Valve O-ring 1989-up CV
35-0110	B	27311-76	Pump cap, 10 pack
14-0566		27312-76	Float Bowl Screw O-ring, 1976-77
13-9234	C	27314-76	Throttle Stop Screw Spring
14-0560	D	27324-83	Float bowl O-ring 1983-91 CV, 5 pk
35-9067	E	27337-76	Float valve with clip
		27338-76	
35-0230	F	27585-88	Vacuum Piston
14-0559	G	27358-76	Float bowl O-ring 1976-78
35-9066	I	27361-76	Pump diaphragm
35-0852	I	27361-76	Pump diaphragm (5 pack)
13-9168		27362-76	Diaphragm spring
14-0564	K	27577-88	Float bowl O-ring 1989-91 CV
14-0937	K	27577-92	Float bowl O-ring 1992-up CV
14-0557	L	27889-78	Float bowl O-ring 1978-82
14-0679	M	27385-76	Low Speed Jet Plug 1976-up
13-9212		27123-89	Accelerator Rod Spring 1989-up
13-9169		27136-81	Throttle and Idle Adj. Screw Spring, 1981-up
		27136-90	Idle Screw Spring 1990-up
13-9213		27162-89	Vacuum Piston Spring, 1989-up
13-9179		27315-88	Primary Starter Spring, 1988-up
13-9181		27319-76	Low Speed Adjuster Screw Spring, 1981-up
13-9183		27322-76	Throttle Lever Spring, 1981-up
13-9178		27584-88	Primary Vacuum Spring, 1988-up
35-9111		27886-78A	Needle for Screamin' Eagle
35-9196	N	27576-92	Float 40 mm CV 1992-up



# EZ Tuner Kits

**EZ Quick Tuner Kits** for CV carburetors. Kit includes brass jets and instructions designed for specifically for each model listed. These kits feature no drilling installation and will work on stock to heavily modified engines.

**35-0766** 1989-98 Big Twins

**35-0763** 1999-up Big Twins

**CV Carb Tuner Kits**

**35-6100** 1995-06 FXST

**35-6101** 1999-06 FXST



**CV Carburetor Rebuild Kit** includes seals, O-Rings, diaphragm and vacuum piston.  
**VT No. 35-0465**



**Chrome Float Bowl Speed Screws** for all CV carburetors 40 and 44 mm carburetors. Set of four machined screws.  
**VT No. 35-0259**



**Keihin Screw Kit** includes chrome screws where required.

VT No.	Years	Type
<b>35-0206</b>	1976-89	Allen
<b>37-9116</b>	CV	Allen
<b>35-0259</b>		Hex



**CV Carburetor Rebuild Kit.**

**VT No. Year**

**35-0416** 1988-91

**35-0444** 1988-up

**CV Main Jets** for Keihin available in packs of 5.

VT No.	Size M/M
<b>35-0451</b>	1.40
<b>35-0452</b>	1.45
<b>35-0453</b>	1.50
<b>35-0454</b>	1.55
<b>35-0375</b>	1.60
<b>35-0376</b>	1.65
<b>35-0377</b>	1.70
<b>35-0378</b>	1.75
<b>35-0334</b>	1.80
<b>35-0379</b>	1.85
<b>35-0335</b>	1.90
<b>35-0336</b>	1.95
<b>35-0337</b>	2.00
<b>35-0455</b>	2.05

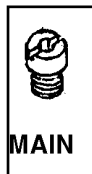

**MAIN**

VT No.	Size M/M
<b>35-0380</b>	.040
<b>35-0381</b>	.042
<b>35-0338</b>	.044
<b>35-0382</b>	.045
<b>35-0339</b>	.046
<b>35-0383</b>	.048
<b>35-0456</b>	.050
<b>35-0457</b>	.052
<b>35-0458</b>	.054



**SLOW**



**CV Choke Cable Bracket** will mount the knob assembly on top of carburetor for use with air cleaners. **VT No. 35-0681**

# CV Keihin Carb



**CV Carburetor Top** without choke cable mount built in.  
**VT No. 35-0163**



**35-8025**



**35-8029**



**35-8032**

**Chrome CV Carburetor Top** replaces black plastic cover on 1990-up Big Twin models.

VT No.	Type
<b>35-8025</b>	Smooth
<b>35-8029</b>	Eagle Spirit
<b>35-8032</b>	Ball Mill

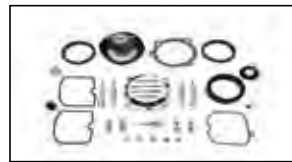

**CV Carb Rebuild and Hardware Kit.**  
**VT No. 35-0612**



**Keihin and CV Idle Screw** allows for easier adjustment by hand.  
**VT No. 35-0220**



**42mm Flatside Carburetor Kit** features smooth air/fuel flow for low and mid range power. Installs with stock cable but requires performance intake manifold. Fits 1990-up Evolution and Twin Cam Big Twin models. OEM# 29641-99.  
**VT No. 35-0027**



**Keihin FCR Carburetor Kit** for 1990-99 Big Twin feature a smoothbore venturi accelerator pump air filter adapter which allows the use of an air cleaner designed for stock CV carburetors, and mounting hardware. Uses stock type CV cables.

VT No.	Type
<b>35-9330</b>	Without air cleaner



**Yost Carburetor Power Tubes** atomize the fuel to its finest form as it enters the cylinders. The CV-44 kit includes (1) power tube, (1) drill bit, (2) washers, (2) flow control needles and (4) main jets. Detailed instructions are included with each kit.

VT No.	Fits
<b>35-9232</b>	Scream'n' Eagle CV44
<b>35-9236</b>	44mm CV 1988-up REV1





# Keihin Rebuild Kits



**CV Tuners Kit by Kinetic-Karb** is for 1989-99 Keihin constant velocity carburetors to permit easy tuning after installation of custom air cleaners, cams and exhaust. Includes instructions, three main jets, needle jet, adjustable needle with spacers and circlips, a spring and drill bits. This dual purpose kit fits 1989 models without accelerator pump and 1990-99 with accelerator pump. Jet assortment includes #140-205, 70 piece main jet assortment.

- |               |                |
|---------------|----------------|
| <b>VT No.</b> | <b>Item</b>    |
| 35-9075       | Kit            |
| 35-9099       | Jet Assortment |

**35-0363 CV Carburetor Upgrade** use when installing 35-9075 CV tuners kit. **VT No. 35-0363**



**CV Carburetor Upgrade Kit** includes rebuild kit, vacuum piston, screws and tuner kit, fits 1988-up Keihin CV carburetors. **VT No. 35-0459**



**Extended Float Bowl Kit** fits CV carburetors for extra capacity, includes hi-flow inlet fitting. **VT No. 35-0135**



35-0169



35-0793

**Idle Adjustment Screws** fit CV carburetor cables include housing as shown.  
**VT No. Type**  
**35-0169** Polish  
**35-0793** Skull Type



# CV Jet Kits



35-0535

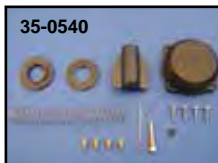

35-0540

**Dynojet** for stock carburetors work with mild cams, stock or aftermarket exhaust and stock or aftermarket air cleaner.

- |               |             |                               |
|---------------|-------------|-------------------------------|
| <b>VT No.</b> | <b>D-J#</b> | <b>Fits</b>                   |
| 35-0535       | 8120        | 1999 Twin Cam 88              |
| 35-0540       | 8132        | Screamin' Eagle 44mm CV TC-88 |



35-0903



35-0904



35-0906

**Boyesen Power X-Wing The Power X-Wing** is a cost effective, bolt on upgrade that will eliminate sluggish throttle response. Dyno test shows up to 4 hp and 5 ft lbs of torque gained compliments air filter system upgrades and requires no re-jetting.

- |               |             |                               |
|---------------|-------------|-------------------------------|
| <b>VT No.</b> | <b>Type</b> | <b>Fits</b>                   |
| 35-0903       | EFI         | 2008-up FLT                   |
| 35-0904       | HSR-42/45   | 1 3/4" Inner Diameter Adapter |
| 35-0906       | HSR 48      | 2" Inner Diameter Adapter     |



35-9264



35-0859

**Turbulator** turns the intake manifold into a violent mixing chamber. The heavier fuel particles are directed away from the sides of the intake manifold back to the center of air flow. The fixed valve turbulator then tumbles the mixture resulting in higher horsepower.

- |               |              |
|---------------|--------------|
| <b>VT No.</b> | <b>Model</b> |
| 35-9264       | 44mm 2 Bolt  |
| 35-0859       | S&S G        |



# Super 'E' & 'G'



S&S 1 7/8" & 2 1/16" Super 'G' feature adjustable volume pump, enrichment device for ease of starting and a throttle spool assembly designed for late 2 cable operation. Supplied with tear drop air cleaner, mounting bracket and black fuel line. Super 'E' carburetor is approximately 1 7/16" shorter than the Super 'B' carb, making installation length of the Super 'E' the same as stock. Can be used with 3.5 or 5.0 gallon Fatbob tanks. The 1 7/8" is for street stock applications, 2 1/16" for big bore and race use. Intake manifold clamps or flanges must be purchased separately when they are required.



35-0471



35-1050

1 7/8" 'E'	2 1/16" 'G'	Fits
35-0004	—	1984-92 Big Twin Evolution
35-9229	—	1993-98 Big Twin Evolution
35-9230	—	1999-up TC-88 for use with stock cables
35-0471	35-0470	Carburetor Only, Natural
35-1050	—	Carburetor Only, Black
2596-13	—	Allen Screw Kit



34-1179



34-0853



34-0854



34-1197 Installed

**Billet Velocity Stack** fits 34-0662 bracket. Stack includes inverted cone filter element.

VT No.	Item
34-0853	Stack
34-1197	Stack with fan
34-1179	Bracket
34-0854	Replacement Filter
34-0593	Kit



35-0992

"R" Carburetor has 1 7/8" bore.  
VT No. 35-0992



34-1166



34-1394

**Chrome Velocity Stack Kit** includes bracket with integral breather passages. Enricher knob included. Fits S&S E.

VT No.	Model
34-1166	Evolution and TC-88
34-1179	Bracket Only
34-1394	Spacer Ring



**S&S Air Cleaner Adapter** includes provision for venting, chrome.  
VT No. 35-0985



**Black Thunderjet** fits S&S G and D carburetors for larger volume.  
VT No. 35-0179



**Hi-Flow Air Cleaner Element** fits S&S E air cleaners. Kit includes washable 3.5" high filter and mount studs.  
VT No. 34-0653

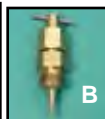
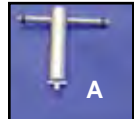

**Adjustable Main Jets** for S&S (C) fits in float bowl drain plug below main metering jet. The recommended main jet is 100 to 104. Fits Super 'B' only.

VT No.	#	Item
35-9168	A	Jet Tool Install/Remove Jet on B & E carburetors
35-0370	B	Main Jet



**Accelerator Pump Adjusting Screw Set** allows adjustment of idle and accelerator pump by these tee bar style screws for ease of adjustment.  
VT No. 35-0217

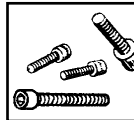

**Super Allen Screw Sets** include bowl air cleaner and cover screws in chrome.  
VT No. Type  
37-9105 Super B  
37-9106 Super E & G





# Jets for S&S



35-0995



35-0287

**Jet Assortment** for S&S Super 'E', 'G' and 'B' carburetors. Complete kit includes 7 intermediate jets from .025" to .033" and a main jet kit only which includes 14 main jets from .062" to .084".

**VT No. Kit**  
35-0995 Complete  
35-0287 Main Only



**Main Jets** for S&S. Use when installing new exhaust system or just tuning for better performance and mileage. Sizes available in increments of .002 and ranges in sizes from .040 to .104. Sold each.

VT No.	Size	VT No.	Size	VT No.	Size
35-0300	.040	35-0312	.062	35-0323	.084
35-0301	.042	35-0313	.064	35-0324	.086
35-0302	.044	35-0314	.066	35-0325	.088
35-0304	.046	35-0315	.068	35-0326	.090
35-0305	.048	35-0316	.070	35-0327	.092
35-0306	.050	35-0317	.072	35-0328	.094
35-0307	.052	35-0318	.074	35-0329	.096
35-0308	.054	35-0319	.076	35-0330	.098
35-0309	.056	35-0320	.078	35-0331	.100
35-0310	.058	35-0321	.080	35-0332	.102
35-0311	.060	35-0322	.082	35-0333	.104

**Intermediate Jets** fits all S&S carburetors.

VT No.	Size/No.	VT No.	Size/No.
35-0350	025 #1	35-9174	.032
35-9173	.0265	35-0354	.033 #4
35-0351	.028 #2	35-0355	.036 #5
35-0352	.0295 #2 1/2	35-0356	.040 #6
35-0353	.031 #3		

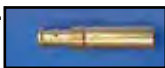

35-0850

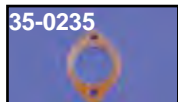

35-0235

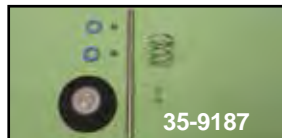

35-9187

**S&S Super 'E' & 'G' Rebuild Kits & Replacement Parts.** Rebuild kits contain all the parts necessary for a complete overhaul.

VT No.	Fits
35-0850	Super 'E' Body Kit VT
35-9185	Super 'E' Body Rebuild S&S
35-9186	Super 'G' Body Rebuild
35-0966	Accelerator Rebuild Only, Super 'E' & 'G' V-Twin
35-9187	Accelerator Rebuild Only, Super 'E' & 'G' S&S
35-9240	Super 'E' Master Rebuild
35-9355	Sifton Super 'E' Rebuild
35-9241	Super 'G' Master Rebuild
35-9183	Super 'E' Float for Above
35-9189	Super 'E' Float VT
35-0849	360° Carburetor Fuel Inlet
15-0319	Float Bowl Gasket Only, Super 'E' & 'G' each
35-0234	Needle and Seat Super 'E' & 'G'
35-0970	Needle and Seat Super 'E'
35-0978	Needle Only
35-0924	Needle Seat with elbow
35-0235	1/4" Insulator Block, 1 7/8" Carburetors
35-0258	1/4" Insulator Block, 2 1/8" Carburetors
35-0236	Choke Lever
35-2388	Replacement Float Bowl Super 'E' & 'G'



35-9355



35-0170

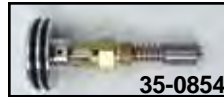

35-0854

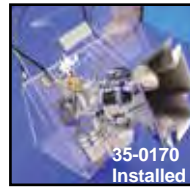

35-0170 Installed

**Enricher** for S&S Super E & G features 3 positions.  
**VT No. Type**  
35-0170 Pike  
35-0854 O-Ring



**Sifton Enricher** for S&S, fits Super 'E' & 'G' and 'B' carburetors, includes chrome knob.  
**VT No. 35-0466**



**Enricher Assembly** for S&S can be used on S&S Super 'E' & 'G' carburetors when a aftermarket air cleaner or velocity stack is used. Does not require lever assembly. Features full on or full off operation only. **VT No. 35-0152**



**Long Float Bowl Screws** fit S&S 'E' carburetors, to facilitate easy removal of bowl.  
**VT No. Finish**  
35-0025 Brass  
35-0029 Chrome



**Fuel Line** has a preformed bend which is kink resistant. Line has 90° formed bend.

VT No.	Type	Size
35-0561	Clear	20" x 5/16"
35-0562	Black	20" x 5/16"



**S&S Super "E" Cruise Control Adapter Kit** make any Super "E" carburetor compatible with the stock cruise control. Fits 1998-up.  
**VT No. 31-2927**



**Breather Bolt Set** fits 1993-up.  
**VT No. 35-1704**



**Throttle Cable Brackets** for S&S. These brackets allow the use of stock type cable on S&S "E" & "G" carburetors.

VT No.	Type	Years
35-0150	Short	1981-89
35-0151	Long	1990-up



**Pingel® Power Flow Valve** has a single outlet with reserve. Manufactured as a one piece billet brass unit featuring a 6AN threaded fitting for fuel line hook up using stainless steel hose and fittings, carburetor fitting for Super 'E' & 'G' sold separately.

VT No.	Item
35-0420	Petcock
35-0421	S&S Carburetor Fitting

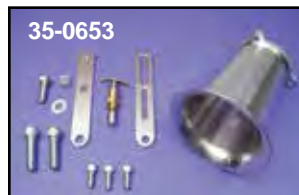

35-0653



34-1165

**Chrome Velocity Stack Kit** includes stack, bracket and enricher knob to fit S&S.

VT No.	Type	Finish	Type	Size
35-0653	S&S	Natural	E & G	4"
34-1165	V-Twin	Chrome	E & G	4"
34-1177	V-Twin	Chrome	B	2"-5"



# Mikuni Carburetor

BIG TWIN



**Carburetor Rebuild Kit** for Mikuni carburetor includes flow fuel hose, throttle valve seal, float bowl seal o-ring, and carburetor top gasket. Custom application for HSR-42/HSR-45 carburetors.  
VT No. 35-0821

35-0821



35-9315



35-9319

**Mikuni HSR 42 Carburetor Easy Kits** for all Evolution and Twin Cam Big Twins. Partial kit includes carburetor, air box adapter and instructions.

**VT No. Fits**

35-9315 1996-99 Evolution Big Twin

**Note**

Uses stock choke cable, manifold and air cleaner. Comes with chrome cover

35-9319 1999-06 Twin Cam

Uses stock air cleaner, choke cable and manifold.



**HSR-42 Velocity Stack Kit** includes chrome bracket, stack and adapter ring.  
VT No. 34-1101



**Sifton HSR42/45 Idle Speed Knob** features stainless construction with knurls for hand adjustment.  
VT No. 35-0543



**HS42 To S&S 'E' Manifold Adapter** allows installation on S&S 'E' manifolds.  
VT No. 35-9155



34-0445



34-0460

**Chrome Billet Carburetor Bracket** features integral breather, includes flange ring, and accepts CV style air cleaners.

**VT No. Item**

34-0445 Kit

34-1261 Flange Ring

34-0460 Kit



**Chrome Float Bowl Speed Screws** fit all Mikuni HSR 42, 45 and 48mm carburetors. Set of four machined stainless screws.  
VT No. 35-0259

## Mikuni HS and HSR Jets.

### Pilot Jets

VT No.	Size
35-0800	22.5
35-0801	25.0
35-0802	27.5
35-0803	30.0
—	
35-0805	35.0

### Main Jets

VT No.	Size
35-0806	150.0
35-0807	152.5
35-0808	155.0
35-0809	157.5
35-0810	160.0
35-0811	162.5
35-0812	165.0
35-0814	170.0

## Jets



35-0800



35-0806



35-0815



35-0818

## HSR-42

### Jet Needles

VT No.	Size
35-0815	95
35-0816	96
35-0817	97

## HSR-45

### Jet Needles

VT No.	Size
35-0818	95
35-0819	96
35-0820	97



34-0834

**Air Cleaner Adapter Plate** will adapt any CV style 3-bolt air cleaner to the Mikuni as noted. Fits 42 and 45 mm CV.

VT No. 34-0834



31-0686

**Chrome Carburetor Support Bracket** fits HS 40/42 for 1984-99 Evolution Big Twin.

**VT No. Item**

31-0686 Bracket Only

34-0852 Bracket with Breather Unit 92-99



34-0852





# Mikuni Carburetor



**Mikuni HSR42/45 Total Kit** for Big Twins. These kits are complete with all required parts for installation. Kits include HSR 42mm or 45 mm carburetor, intake manifold, rubber flange, K&N filter, chrome cover, breather kit and mounting hardware. Models from 1990-up use stock throttle/idle cables and 1984-89 models require 1990-up cables.

### HSR42mm

**35-9321** 1984-99 Evolution Big Twins

**35-9327** 1999-up TC-88

### HSR45mm

**35-9222** 1984-99 Evolution Big Twin

**35-9328** As Above Kit w/o Intake Manifold

**35-9324** 1999-up TC-88

**35-9322** Rebuild Kit (42 and 45 mm)

**35-0430** Breather Kit 1993-up

## Internal Throttle



36-0570



Refer to H in installation instructions

36-0595

**VT No. 36-0570 Internal Throttle Sleeve.** Custom design allows pull action of throttle cable for use with billet grips.

**VT No. Item**

**36-0570** Throttle

**36-0595** Ball Bearing 9mm x 4mm x 4mm

1. Cut 2 3/8" off end of handlebar. Remove end of throttle handle that would attach to throttle cables.

2. Mark handlebar for inner throttle sleeve. Drill a hole for the set screw, this will hold throttle on the handlebar.

3. Remove set screw from the outer sleeve of spiral. Slide grip on and mark end of grip on the handlebar. Measure from this mark back to set screw in outer sleeve. This measurement will be used to mark and drill the throttle grip. Once drilled install grip. Use a small amount of Loctite® on set screw for final installation.

4. **Note:** Set Screw (A) should not be tightened so as to make contact with handlebar as it will prevent throttle from turning.



36-0789

**Internal Throttle/Clutch Unit** features ball and needle bearing construction with built in return spring.

**VT No. Type Item**

**36-0789** Clutch Assembly

**36-0590** Bearing 5/8 x 1 3/16 x 5/8

**36-0591** Bearing 3/8 x 7/8 x 9/32

**Throttle by Wire Extension Harness Kits** "TBW" extension harness will plug in to the existing 6 position Molex connector. These wire extensions will not cause interference to motorcycles computer when installing taller handlebars.

**VT No. Extension**

**32-1205** +4"

**32-1206** +12"

**32-1204** +16"



32-1204

# SU Eliminator II Carburetor Parts



35-4551

### SU Carburetor Replacement Parts

**VT No.**

**35-4551**

**35-4554**

**35-4555**

**35-4556**

**35-4557**

**35-4558**

### Application

Rebuild kit for Eliminator SU carburetor

4 1/2" oz piston return spring (red)

8 oz piston return spring (silver)

12 oz piston return spring (green)

Standard (BBX) tapered needle

Slightly leaner (BBT) tapered needle



## Carburetor Kits



35-1100

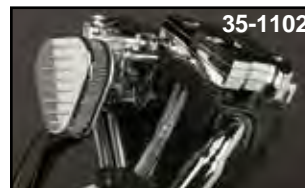

35-1102

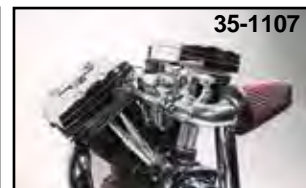

35-1107



35-1105

**Weber 45MCHH Single Barrel Carburetor** features a chrome carburetor and a unique intake manifold and breather kit that fits both Evolution and Twin Cam Big Twin engine 1992-up. Kits are available with a chrome billet air cleaner and "shorty" type manifold which fits in the stock location between the cylinders. (kits 35-1100 and 35-1102)

For an aggressive look the 45MCHH can be ordered with a highly polished forward swept manifold and cone shaped air filter. (Kits 35-1105 & 35-1106) Additionally, the 45MCHH is available in a kit which features a forward swept air filter elbow which can be used either in the forward or upswept position. The elbow and mounting brackets are polished billet aluminum. (Kits 35-1107 & 35-1108) All 45MCHH kits include carburetor, manifold, air filter, choke cable, installation instructions and jet kit. Carburetor kits are available for both Evolution 80 and TC-88 carbureted motors.

**VT No. Type**

**35-1100** Evolution 80 with shorty manifold and chrome billet air filter

**35-1102** As above for TC-88 engines

**35-1105** Evolution 80 with swept forward and cone shaped air filter

**35-1106** As above for TC-88 engines.

**35-1107** Evolution 80 with swept forward/swept up air filter.

**35-1108** As above for TC-88 motors.



**Throttle and Cable Kits** include grips, throttle idle and Barnett throttle cable with ends attached as pictured for S&S 'E' and 'G' carburetors.

VT No.	Item
35-9246	38" Complete Kit
35-0212	Handle and Grips only

**S&S Super 'E' & 'G' and Cables for Dual Stock Type Throttle Handles.**

Stainless	Black	Length	Type	Years
—	36-2464	33"	Throttle	1981-95
36-0635	36-2466	33"	Idle	1981-95
—	36-0744	33"	Throttle	1996-up
36-0745	36-0746	33"	Idle	1996-up
—	36-2545	38"	Throttle	1981-95
—	36-2544	38"	Idle	1981-95
—	36-0732	38"	Throttle	1996-up
36-0733	36-0734	38"	Idle	1996-up



**Chrome Throttle Clamps and Tube Set** feature smooth design, upper and lower pieces with screws and nylon throttle tube, for single or dual cable applications. For use with 1982-up type cables.

VT No.	Type
35-0253	Single
35-0254	Dual

**Radii Billet Throttle** accepts single 1982-95 throttle cable.

VT No. 35-0255

**Dual Billet Throttle Housing** for use with idle and throttle cable.

VT No. 36-0564

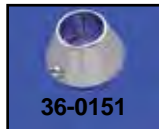

**Throttle Housing** custom design for single cable operation.

VT No.	Finish
36-0151	Chrome
35-0856	Black Vintage
35-0857	Chrome Vintage
35-0858	Copper Vintage

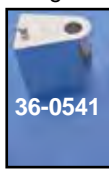

**Throttle Cable Adapter Block** allows use of stock 1996-up throttle cables on S&S E carburetors. VT No. 36-0541

36-0541 Installed

# Throttle Cable Kit



**Dual 1981-up (Push-Pull)**

VT No.	Item
35-0237	Kit with grips
35-0212**	Kit with grips
35-9352**	Kit with Barnett cables
35-9350	Kit with Barnett cables
35-9149*	56324-81A Throttle only
35-9218	56396-74 All Friction Spring

\*Note: Includes nylon tube with chrome clamps.

\*\*Note: Includes chrome end plugs.



**Universal Throttle Sets** feature chrome housing with adjuster and metal twist tube. All use universal single cable.

VT No.	#	Item
35-0071	A	1" with Anderson Rubber Grips
35-0232		As Above without Grips
28-0116		Grips for Above
35-0213	B	1" with Plastic Grips and Cable
28-0215		Barnett Left Side Grip
35-0214	C	7/8" with Plastic Grips and Cable
36-0104		Cable only, Barrel end only, 48"
36-0112		Cable only, Barrel End, 60"
36-2538		Handle Ferrule with nut



**Nylon Throttle Tubes.**

VT No.	Type	Year
35-9073	Single	1976-81
28-1981	Dual	1982-95
35-9870	Dual	1996-up

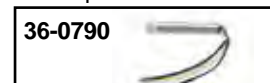

**Throttle By Wire**

35-9871	Throttle by Wire	2009-up Tube Only
36-0790	Throttle Assembly	2008-up





# Throttle Cable



**Barnett Carburetor Conversion Throttle/Idle Cables.** Order by carburetor and throttle type. For use with stock type Push-Pull Throttle handles except as noted.

**Mikuni Carb, 38 and 40mm**

Clear Coat	Stainless	Stainless	Black	Length	Cable
—	36-1542	36-2493	38"	Throttle	Unv., Single
—	36-1543	36-2494	46"	Throttle	Unv., Single
—	36-1545	36-2541	43"	Throttle	1981-95 Single

**Mikuni HS40**

—	36-1546	36-2543	41"	Throttle	1981-95
—	36-1547	36-2542	41"	Idle	1981-95
—	36-1548	36-0728	41"	Throttle	1996-up
—	36-1549	36-0730	41"	Idle	1996-up

**Mikuni HS 42/45**

—	36-1550	36-2585	36"	Throttle	1981-95
36-0667	36-1551	36-2586	37"	Idle	1981-95
—	36-1552	—	36"	Throttle	1996-up
—	36-1553	36-0751	37"	Idle	1996-up

**Keihin**

—	36-1554	36-2477	38"	Throttle	Unv., Single
—	36-1555	—	46"	Throttle	Unv., Single

**S&S Super 'B' or Bendix**

—	36-1556	—	37"	Throttle	1976-80
—	36-1557	36-2475	38"	Throttle	1981-95
—	36-1558	36-2498	38"	Idle	1981-95
36-0723	36-1559	36-0724	38"	Throttle	1996-up
36-0725	36-1560	36-0726	38"	Idle	1996-up

**S&S Super 'E' & 'G' and Screamin' Eagle**

—	36-1563	36-2545	44"	Throttle	1981-95
—	36-1564	36-2544	44"	Idle	1981-95
—	36-1565	36-0732	44"	Throttle	1996-up
36-0733	36-1566	36-0734	44"	Idle	1996-up

**Dell'Orto Pumper**

36-0670	—	36-2550	40"	Throttle	Unv, Single
---------	---	---------	-----	----------	-------------

**Dell'Orto Dual Throat**

—	—	36-2581	39"	Throttle	1981-95
—	—	36-2582	39"	Idle	1981-95
36-0735	—	36-0736	39"	Throttle	1996-up
36-0737	—	36-0738	39"	Idle	1996-up

**Qwiksilver**

36-0673	—	36-0740	39"	Throttle	1996-up
36-0674	—	36-0742	39"	Idle	1996-up

**Universal Throttle Cables by V-Twin**

36-0905	—	—	41½"	Ball and Barrel	Ends
—	—	36-0104	43"	Barrel	End
—	—	36-0112	60"	Barrel	End
—	—	36-0105	38"	38mm Mikuni	Ball End



**Throttle Adjuster Knob** fits between idle and throttle cable on 1984-up.

**VT No. 35-0684**

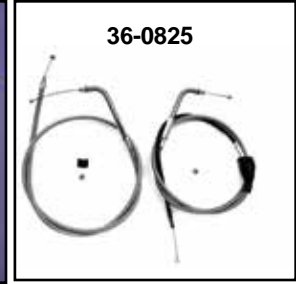

**Stainless Steel Braided Cable Set** by M&M features clear coating for throttle and idle applications.

VT No.	Year	Model	Length
36-0857	1996-up	Softail-FXD	34.25"
36-0128	1996-up	Softail-FXD	42.5"
36-0119	1996-up	Softail-FXD	46"
36-0131	1996-up	Softail-FXD	52"
36-0856	1990-95	FXST-FLST-FXR	Stock
36-0866	1990-95	FXST-FLST-FXR	+8"
36-0855	1981-89	FX-FLST	Stock
36-0114	1982-95	S&S	42"
36-0115	1982-95	S&S	54"
36-0129	1996-up	S&S	38"
36-0135	1996-up	S&S	44"



**Clear Coated**

**Barnett Clear Coat Braided Stainless Throttle Cable Sets** include throttle and idle cable.

VT No.	Year	Model	Length
36-0823	1996-99	FXST, FLST, FXD	Stock
36-0847	+8"	As Above	+8"
36-0832	1981-95	S&S Super E,G, Screamin' Eagle	38"
36-0829	1996-up	S&S Super E,G, Screamin' Eagle	38"
36-0830	1981-95	S&S Super E,G, Screamin' Eagle	42"
36-0831	1996-up	S&S Super E,G, Screamin' Eagle	42"
36-0832	1981-89	FX, FLH, FXST, FLST	Stock
36-0833	—	As Above	+ 8"
36-0839	1996-up	FXSTS (38" casing)	Stock
36-0841	1990-95	FXLR, FXRS,FXRT, FLST, FXR, FXST, FXSTC, FLST, FLSTC	Stock
36-0842	—	As Above	+8"



**Chrome Dual Throttle Cable Separator** is two clamp piece design. 2-holes.  
**VT No. Style**  
**31-9942** Oval  
**36-0588** Maltese



**Chrome Billet Clutch Cable Mount** fits Softail models. **VT No. 31-0945**



**Chrome Stock Billet Brake Clip.** Replaces 91336-03. Fits FXST.  
**VT No. 36-0351**



**Chrome Billet Cable Clamps** sold each.

VT No.	Size	Type
37-0883	1"	Throttle, Single
37-0887	41mm	Clutch
37-0897	39mm	Clutch

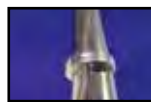
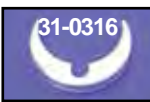
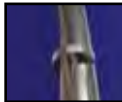
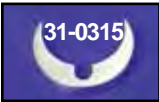

**41mm Push On Fork Tube Clamps** to secure speedometer cables and brake lines.

**VT No. Style**  
**31-0315** Smooth  
**31-0316** Groove



**Cable Clip** with 5/16" hole snaps on fork tubes to hold cables and brake hoses.

**VT No. Fork Tubes**  
**24-0497** 41mm  
**24-1024** 49mm



**Chrome Handlebar Wiring Clips** snap into late model stock bars with holes at bends. 10 pack.

**VT No. Size, Inner Diameter**  
**36-0613** 3/8"  
**36-0614** 1/2"



**Black Cable Clamps** fits 1 1/8" to 1 1/4" bars.

**VT No. Type**  
**37-1511** Throttle  
**37-1512** Clutch



**FXST-FLT Complete Choke Cable Assembly** for 1993-2006 models. Includes cable, cable guide, sealing cap, starter valve, starter cap and enrichment spring. **VT No. 36-0597**

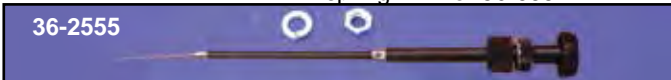

**FXD-FXR Choke Cable Assembly** for 1993-94 FXR, 1991-05 Dynaglide, replaces 29229-88C.

**VT No. 36-2555**



**Chrome Choke Knob** fits 1989-up CV Big Twin model carburetors.

**VT No. 36-0551**

# Chrome and Billet Clamp

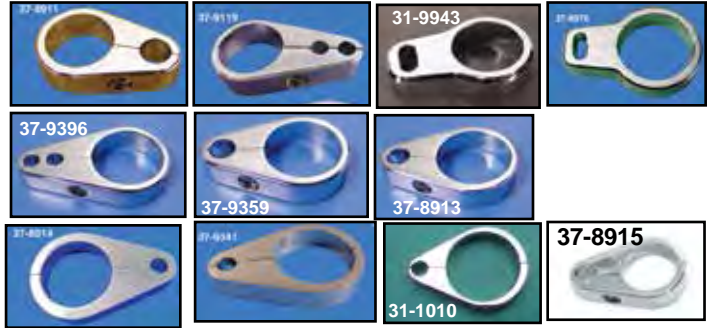

**Chrome Cable Clamps** are 2-piece design for securing cables or wires to frame and forks. Sold each. As noted for cable type.

VT No.	Size	Holes	Type
37-9119	1"	2	Throttle
31-9943	1"	Slot	Throttle (2)
37-8976	1 1/4"	Slot	Throttle (2)
37-9501	1 1/2"	Slot	Throttle (2)
37-9502	1 3/4"	Slot	Throttle (2)
37-9503	2"	Slot	Throttle (2)
37-9396	1 1/4"	2	Throttle (2)
37-9398	1 1/4"	1	Throttle
37-8911	1"	1	Clutch
37-8915	1 1/8"	1	Clutch
37-9359	1 1/4"	1	Clutch
37-8913	35mm (1 3/8")	1	Clutch
37-8914	39mm	1	Speedometer
37-9341	41mm	1	Speedometer
31-1010	49mm	1	Clutch



**Chrome Cable Clamps.** Unique two piece design allows easy installation. Swivel head design allows more natural cable routing without excessive bending. Rubber sleeves protect painted surfaces and cable housing. Clamps fit handlebars and aftermarket frames.

VT No.	Size	Holes	Type
31-0296	1 1/4 - 1 1/4"	Dual	Throttle/Clutch
31-0336	1 - 1 1/8"	Dual	Throttle/Clutch
31-0337*		Single	Cable Holder Only for 1 5/64" (7mm) 3/32" (8mm) and 1 1/32" (9mm cables)

**31-0338\*** As Above Dual Cable Holder Only  
**\*Note:** Cable holders only are for use with **31-0296, 31-0297 and 31-0336.**

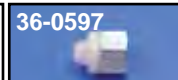
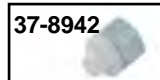

**FLH-FXST-FLT Choke Cable.** Assemblies include knob casing and inner wire.

VT No.	OEM	Item	Fits
36-0523	29213-79 29211-86	Assembly	1984-89 FXST 1985-86 FXWG
36-2555	29229-88C	Assembly	1993-06 FLT-FXST
36-0995	29214-71	Chrome Knob	1971-89 FLH-FXST
28-2117	27451-82	Rubber Grommet	1982-89 FLH-FXST
12-0576	27450-82	Nut	1982-89 FLH-FXST
37-8942	Kit	Nut	1984-99 FXST
12-1190	11013	Retaining Ring	1979-89 FLH-FXST-FLT





# Throttle Cable

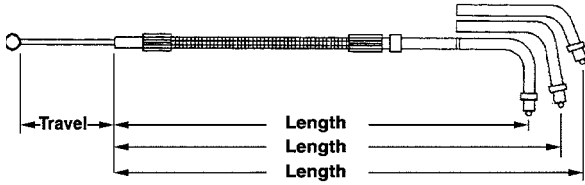

Throttle/Idle Cables

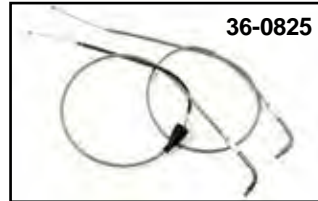
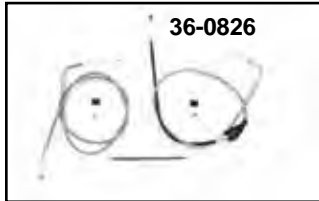
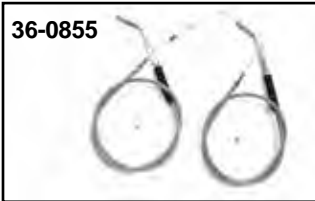
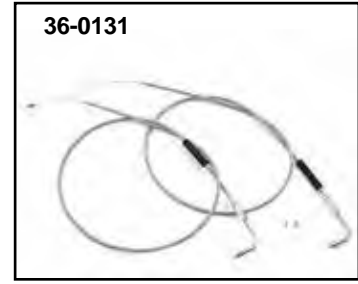
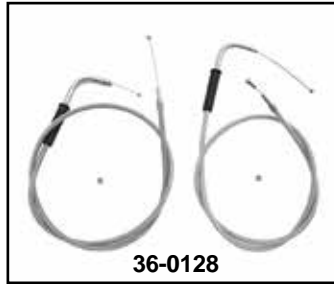

## Clear Coated Throttle/Idle Cable Set

VT No.	Length	Over	Application
36-0855	38"	Stock	1981-99 FX-XL-FL
36-0868	46"	+8"	1981-99 FX-XL-FL
36-0856	34"	Stock	1990-95 90 FXST/FLST, 90-95 FXSTC/FLSTC/FLSTF, 1995 FXSTSB, 93-95 FLSTN, 91 FXDB, 90-94 FXLR/FXR, 90-92 FXRS/FXRT, 90-93 FXRS-Conv. FXRS S.E.
36-0773	43"		1994-95 FLHR, 1990-95 FLHT
36-0866	36"	+8"	1990-95 90 FXST/FLST, 90-95 FXSTC/FLSTC/FLSTF, 1995 FXSTSB, 93-95 FLSTN, 91 FXDB, 90-94 FXLR/FXR, 90-92 FXRS/FXRT, 90-93 FXRS-Conv. FXRS S.E.
36-0857	34.25"	Stock	1996-05 FXD, 02-05 FXDI, 99-05 FXDX, 02-05 FXDXI, 01-03 FXDXT, 96-05 FXDL, 01-05 FXDLI, 96-00 FXDS Conv., 96-05 FXDWG, 01-05 FXDWGI
36-0128	42.25"	+8"	1996-05 FXD, 02-05 FXDI, 99-05 FXDX, 02-05 FXDXI, 01-03 FXDXT, 96-05 FXDL, 01-05 FXDLI, 96-00 FXDS Conv., 96-05 FXDWG, 01-05 FXDWGI
36-0119	47"		1996-up ST-FXD
36-0131	52"	+12"	1996-05 FXD, 02-05 FXDI, 99-05 FXDX, 02-05 FXDXI, 01-03 FXDXT, 96-05 FXDL, 01-05 FXDLI, 96-00 FXDS Conv., 96-05 FXDWG, 01-05 FXDWGI
36-0825	46"		1996-01 FLHTCUI, 98-01 FLTRI
36-0826	40"		2002-07 FLHRI, FLHRCI



## Full Stainless Braid Covering with Clear Coat

M&M Cables are constructed with the Supra™ stainless steel braid which is tightly woven for a bright, quality consistent finish. The clear coat is UV resistant, heat bonded, non-yellowing grade for a long service life. All applications include the correct fittings, adjuster and inner lengths for an exact installation and fit.



# Clutch Cable

Stainless Steel Braided  
TWO-PIECE CLUTCH CABLES



BIG TWIN

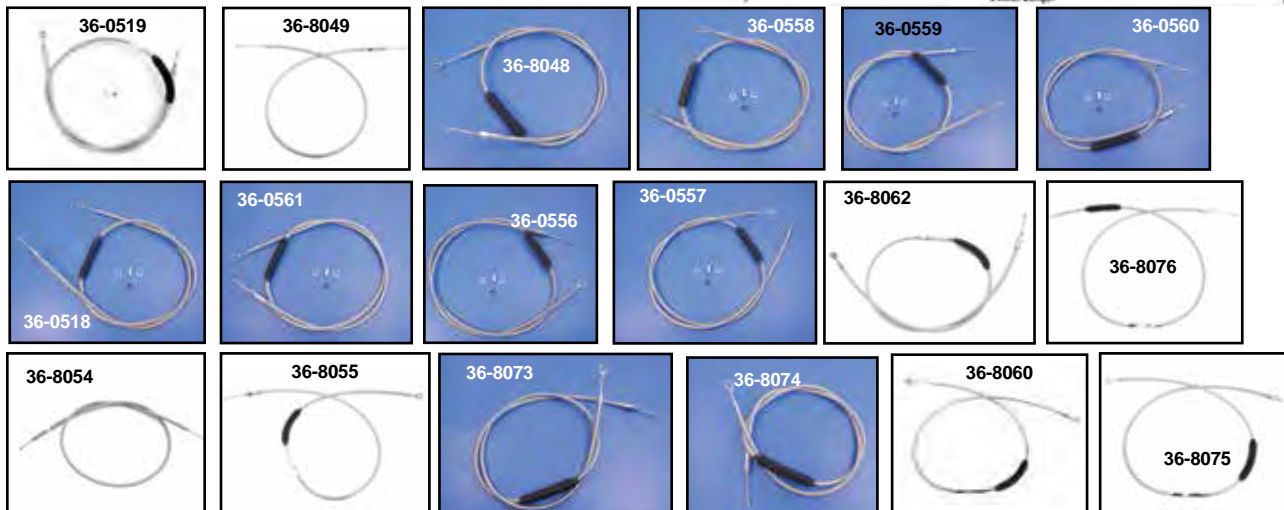

### Stainless Steel Braided Clutch Cables.

VT No.	Length Over	OEM#	Application
36-0519	63"		1987-06 FXST-FXSTC-FLST
36-8049	52.56"	38618-68C	1970-84 FL/FLH, 84-85 FXST, 1977-82 FXS, 83-85 FXSB, 1973-84 FXE, 79-81/84-85 FXEF, 1980-86 FXWG, 80-82 FXB, 71-78 FX
36-8048	62.69"	38607-87A 38664-00	1987-90/99 FXST, 87-99 FXSTC, 2000-04 FXSTD/FXSTDI, FXST, 87-99 FXSTC, 00-04 FXSTD/FXSTDI, 87-99 FXSTS/FLSTC, 87-90 FLST, 90-99 FLSTF, 93-96/2005 FLSTN, 97-99 FLSTS
36-0558	65.25"	+2"	38607-87 Stock 1987-06 FXST-FXSTC-FLST
36-0559	66.50"	+4"	38607-87 Stock 1987-06 FXST-FXSTC-FLST
36-0560	69.25"	+6"	38607-87 Stock 1987-06 FXST-FXSTC-FLST
36-0518	75 5/8"	+8"	38607-87 Stock 1987-06 FXST-FXSTC-FLST
36-0561	74.50"	+10"	38607-87 Stock 1987-06 FXST-FXSTC-FLST
36-0556	75.25"	+12"	38607-87 Stock 1987-06 FXST-FXSTC-FLST
36-0557	79"	+16"	38607-87 Stock 1987-06 FXST-FXSTC-FLST
36-8062	64.69"	Stock	38666-00 2000-05 FXST/FXSTI/FXSTS/FXSTSI/FLSTC/FLSTCI/FLSTF/FLSTFI/FLSTS/FLSTSI/FXD/FXD/FXDX, 01-03 FXDWG2/3, 01-05 FXDL
36-8076	70.69"	+6"	38666-00 00-05 FXST/FXSTI/FXSTS/FXSTSI/FLSTC/FLSTCI/FLSTF/FLSTFI/FLSTS/FLSTSI/FXD/FXD/FXDX, 2001-03 FXDWG2/3, 01-05 FXDL
36-8063	57.69"		38665-00 1999-05 FXSTB/FXSTBI
36-0867	72.8"	+6"	38789-06A 2006-up FXDWG, ST
36-0864	68.81"		38789-06A Stock 2006-up FXDWG
36-0865	64.75"		38666-07 Stock 2007-up FXST
36-1156	62.66"		38664-07 Stock 2007-up FXSTD
36-1158	64.57"		38787-06A Stock 2006-up FXD
36-1159	65.66"		38788-06A Stock 2006-up FXDL
36-8051	63.69"		38606-87A 1987-94 FXR, 87-92 FXRS/FXRT, 89-93 FXRS-Conv., 87 FXRC
36-2514	64.75"	Stock	38606-87 1987-94 FXR-FXRS-FXRT
36-8051	63.69"		38606-87A 87-94 FXR, 87-92 FXRS/FXRT, 89-93 FXRS-Conv., 87 FXRC
36-8054	53.31"		38599-83A 1983-86 FLHT/FLHTC/FLTC/FLT/FXR/FXRS/FXRT, 85-86 FXRS S.E., 85 FXRC, 86 FXRD, 84 FXRDG
36-8055	60.63"		36753-87A 1987-94 FXLR
36-8056	57.63"		36755-87A 1987-93 FXRS S.R.
36-8057	68.69"	Stock	38602-92 1995-99 FXD, 93-05 FXDL, 94-00 FXDS Conv., 93-99/00-05 FXDWG 38661-00 1992-05 FXDB/FXDC
36-8067	72.69"	+4"	38602-92 1995-99 FXD, 93-05 FXDL, 94-00 FXDS Conv., 93-99/00-05 FXDWG 38661-00 1992-05 FXDB/FXDC
36-8068	74.69"	+6"	38602-92 1995-99 FXD, 93-05 FXDL, 94-00 FXDS Conv., 93-99/00-05 FXDWG 38661-00 1992-05 FXDB/FXDC
36-8069	76.69"	+8"	38602-92 1995-99 FXD, 93-05 FXDL, 94-00 FXDS Conv., 93-99/00-05 FXDWG 38661-00 1992-05 FXDB/FXDC
36-8070	78.69"	+10"	38602-92 1995-99 FXD, 93-05 FXDL, 94-00 FXDS Conv., 93-99/00-05 FXDWG 38661-00 1992-05 FXDB/FXDC
36-8058	55.44"		38599-80B 1982 FXR/FXRS
36-8059	62.69"	Stock	38601-89 1994-05 FLHR, 96-97/00-05 FLHRI, 1998-05 FLHRCI, 38667-00 2002-04 FLHRSEI, 95-05 FLHT, 1989-05 FLHTC/FLHTC/FLHTCU/FLHTCUI, 89-96 FLTCU/FLTCUI, 1999-05 FLTR/FLTRI, 00-01 FLTRSEI, 1989-93 FLHS, 89-91 FLTC
36-8071	64.69"	+2"	38602-92 1995-99 FXD, 93-05 FXDL, 94-00 FXDS Conv., 93-99/00-05 FXDWG 1992-05 FXDB/FXDC
36-8072	66.69"	+4"	38602-92 1995-99 FXD, 1993-05 FXDL, 94-00 FXDS Conv., 93-99/00-05 FXDWG 38661-00 1992-05 FXDB/FXDC
36-8073	68.69"	+6"	38602-92 1995-99 FXD, 93-05 FXDL, 94-00 FXDS Conv., 93-99/00-05 FXDWG 38661-00
36-8074	70.69"	+8"	38602-92 1995-99 FXD, 93-05 FXDL, 94-00 FXDS Conv., 93-99/00-05 FXDWG 38661-00
36-8060	60.69"	Stock	38617-95 1995-97 FXSTSB
36-8075	66.69"	+6"	38617-95 1995-97 FXSTSB





# Clutch Cable

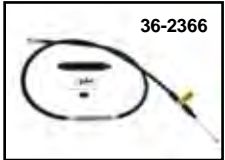
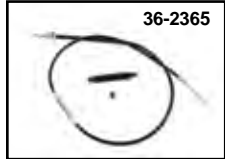
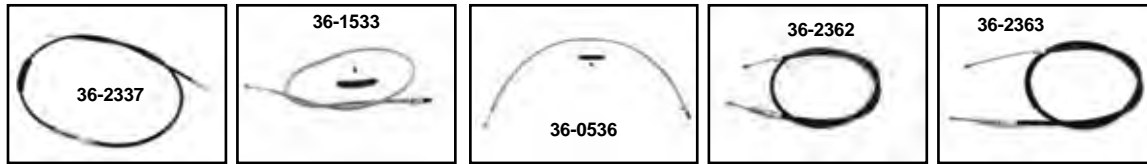
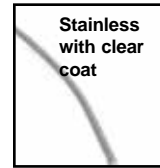

**Clutch Cables** feature heavy duty construction designed for reliability and longer service. By V-Twin or Barnett in black vinyl or braided stainless covering. **\*Note:** Uses eyelet style end. Hand lever pin is supplied.

## Big Twin Clutch Cable Assemblies

V-Twin Black	Barnett Stainless	Barnett Stainless with Clear Coat	Barnett Black	OEM	Fits	Casing Length
—	—	36-1530	36-2362	38599-83A	Stock 1984-86 FXRS-FXRT-FXR	54"
—	—	36-0694	36-2363	38605-86A	Stock 1986 FXST 5 Speed	54.25"
—	—	—	36-2364	38611-86	Stock 1986 FLST 5 Speed	48.75"
—	—	36-0696	36-2365	38606-87	Stock 1987-94 FXR-FXRS-FXRT	64.75"
—	—	36-1531	36-2366	38607-87	Stock 1987-06 FLT-FXST-FXSTC-FLST	63"
—	—	—	—	—	2" Extension, As Above	65.25"
—	—	—	—	—	4" Extension, As Above	66.50"
—	—	—	—	—	6" Extension, As Above	69.25"
—	—	36-1532	36-2369	—	8 Extension, As Above	71.375"
—	—	—	—	—	10" Extension, As Above	74.50"
36-2537	—	—	—	—	12" Extension As Above	75.25"
—	—	—	—	—	16" Extension, As Above	79"
—	—	36-0699*	36-2479*	36753-87	Stock 1988-94 FXLR	61.875
—	—	—	36-2488*	36755-87A	Stock 1987-94 FXRSE	57.75
—	—	36-1533	36-2509	38601-89	Stock 1989-06 FLT	63"
—	—	36-0536	36-0535	38602-92	Stock 1992-05 FXDL-FXDWG-FXDB	69"
—	—	—	36-0538	38617-95	Stock 1995-97 FXSTSB	60.75"
—	36-0758	—	36-0759	38647-98	Stock 1998-06 FXSTSB	57"
36-1150	—	—	—	38667-07	Stock 2007-up FLT	62.51"
36-1151	—	—	—	38789-06A	Stock 2006-up FXDWG	68.81"
36-1152	—	—	—	38666-07	Stock 2007-up FXST	64.75"
36-1153	—	—	—	38664-07	Stock 2007-up FXSTD	62.66"
36-1154	—	—	—	38787-06A	Stock 2006-up FXD	64.57"
36-1155	—	—	—	38788-06A	Stock 2006-up FXDL	65.66"



**Chrome Clutch Cable Adjuster Cover** fits 1987-up Big Twin. Installs over adjuster at clutch adjustment cover. Locks in place with stainless steel set screw. Will retro fit Barnett or stock cables.

VT No.	Type	Style
36-0578	1982-up	Upper
36-0579	1987-06	Lower

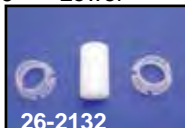
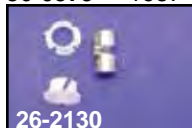

## Lever Pins/Bushings

VT No.	OEM	Item	U/M
26-2130	45032-82	Pin 1982-84	10
26-2132*	45036-88	1988-up with Bushings	Each
36-2559	45423-92	Lever Bushings	10

**\*Note:** Teflon pin fits 1988-up eyelet clutch cables



## Braided Cable Heat Shrink Tubing.

Clear heat shrink tubing for use on all braided stainless steel cables to prevent cable from scratching painted or chromed surfaces while still keeping that braided steel look. Kit contains 4-16" long heat shrink tubes to cover 2 throttle cables, 1 clutch and 1 speedometer cable. Bulk tubing is in a 10 foot roll.

VT No.	Item
40-0015	Cable Sleeve Kit
40-0019	3/8" x 10' Roll
40-0020	1/2" x 10' Roll
40-0021	3/4" x 10' Roll



**Cable Clamp** is fitted to hand lever for emergency or permanent use. Easy to install .460" diameter, pair.

**VT No. 26-0509**



**Black Matched Stock and Idle Cable Sets** for Big Twin include correct throttle and idle cable assembly.

# Throttle Cable



Stock	+8"	+12"	Years	Model
36-0858	36-0861	—	1996-up	Softail/FXD
36-0859	36-0862	—	1990-95	Softail/FXR
36-0860	36-0863	36-2561	1981-89	Softail/FLH

**Big Twin Throttle/Idle Cables** are available in black vinyl or braided stainless covering with correct end fitting for each application, also available in over stock length. Assemblies unless noted.

V-Twin Stainless	V-Twin Black	Barnett Stainless Clear Coat	Barnett Stainless	Barnett Black	OEM	Fits
36-0903	36-0101	—	36-1504	36-2464	56324-81	Stock 1981-89 FX-FLH-FXST-FLST Throttle
—	—	—	36-1505	36-2465	—	+8" Extension As Above
—	36-2558	—	—	—	—	+12" Extension As Above
36-0902	36-0100	36-0635	36-1506	36-2466	56323-81	As Above, Stock Idle
—	—	—	36-1507	36-2467	—	+8" Extension As Above
—	36-2557	—	—	—	—	+12" Extension As Above
—	—	—	—	36-2468	56328-81	Stock 1981-89 FLT-FLHT Throttle
—	—	—	—	36-2469	56327-81	As Above, Stock Idle Cable
—	—	—	36-0639	36-2470	56336-83	Stock 1983-87 FXRT-FXLR-FXRSE, Throttle
—	—	—	36-0640	36-2471	56337-83	As Above, Stock Idle
—	—	—	—	36-2546	56343-88	Stock, 1988-89 FXLR Throttle
—	—	—	—	36-2547	56342-88	As Above, Stock Idle
—	—	—	—	36-2499	56306-88	Stock 1988-89 FXSTS Throttle
—	—	—	—	36-2500	56305-88	As Above, Stock Idle
—	—	—	36-1508	36-2501	56306-90	Stock 1990-95 FXSTS Throttle
—	—	—	36-1509	36-2502	56305-90	As Above, Stock Idle
—	—	—	36-1510	36-0756	56306-96	Stock 1996-up FXSTS Throttle
—	—	36-0755	36-1511	36-0757	56305-96	As Above Stock Idle
—	—	—	—	36-2503	56327-90	Stock 1990-95 FLT-FLHT-FLHS Throttle
—	—	—	36-0650	36-2504	56328-90	As Above, Stock Idle Cable
—	—	36-0651	36-1512	36-2505	56343-90	Stock 1990-95 FXLR-FXRS-FXRT-FLST-FXR-FXST
—	—	—	—	—	—	FXSTC-FLST-FLSTC Throttle
—	—	—	36-1513	36-2507	—	+8" Extension As Above
—	—	—	36-1514	36-2506	56342-90	As Above, Stock Idle
—	—	—	36-1515	36-2508	—	+8" Extension As Above
—	—	—	—	36-0707	56327-96	Stock 1996-2001 FLHR-FLHT Throttle
—	—	36-0708	—	36-0709	56328-96	As Above, Stock Idle
—	—	—	—	36-0764	56357-02	Stock 2002-up FLHR, FLHT Throttle
—	—	—	—	36-0765	56362-02	Stock As Above Idle
—	—	—	—	36-0711	56379-96	Stock 1996-up FLHR-I Throttle
—	—	—	—	36-0760	56368-96	As Above, Stock Idle
—	—	—	—	36-0715	56357-96	Stock 1996-up FLHTC-I Throttle
—	—	—	—	36-0760	56368-96	As Above Idle
—	—	—	36-1516	36-0717	56343-96	Stock 1996-up FLST-FXD-FXDWG-FXST Throttle
—	—	—	36-1517	36-0718	—	+8" Extension As Above
—	—	—	36-1518	36-0720	56342-96	As Above Stock Idle
—	—	—	36-1519	36-0722	—	+8" Extension As Above
—	—	—	36-1570	36-0766	56343-01	Stock 2001-up FLST, FXD, FXST Throttle
—	—	—	36-1571	36-0767	—	+8" Extension As Above
—	—	—	36-1572	36-0768	56342-01	Stock As Above Idle
—	—	—	36-1573	36-0769	—	+8" Extension As Above

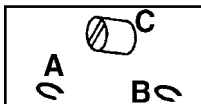

**Throttle Idle Clips, Cable Retaining Clips & Ferrules.** Sold in 10 pack.



**Throttle Cable Adapter Kit** is used when fitting pre1990 Edelbrock Qwiksilver carburetor on 1990-98 Big Twin with stock throttle cables. Use on 1996-up S&S series carburetor to allow use of stock cables.

VT No.	#	OEM	Item	Year
36-0527	A	11272	Throttle Cable Clip	1996-up
36-0528	B	11271	Idle Cable Clip	1996-up
36-2480	C	56508-76	Throttle/Idle Ferrules	1976-up

**VT No. 36-0542**





# Speedometer Cable

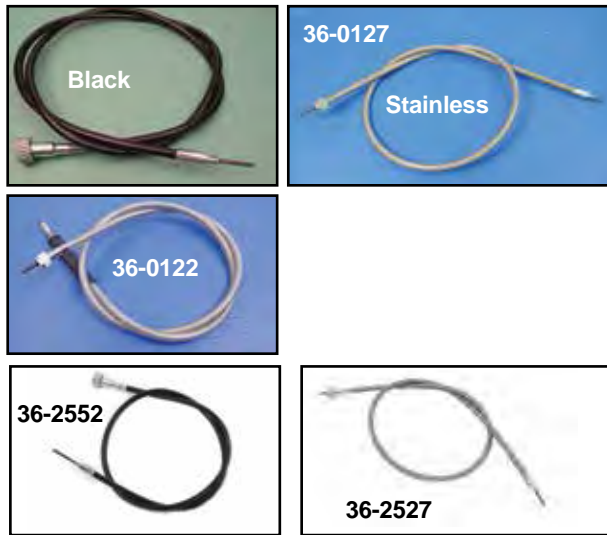

**Front Wheel Drive Speedometer Cables.**  
Choose by application or by length and top nut size.  
Available in black vinyl, stainless or clear coated stainless.

Black Vinyl	Stainless	OEM	Length	Top Nut
<b>L1984-87 FXE 1985 FXEF Models.</b>				
36-2552	36-2527	67077-85	36"	16mm
<b>1987-94 FXR-FLXR, 1984-86 FXRS, 1984-86 FXSB, Replaces OEM 67078-85A, 67051-73 and 67052-78A.</b>				
36-0606	36-2528	See Text	40"	16mm
36-0813	—	Barnett	40"	16mm
—	36-0120	Coated	40"	16mm
<b>1987-93 FXRS/SP, Con.</b>				
36-2414	36-2529	67048-83A	43"	16mm
—	36-0121	Coated	43"	16mm
36-0815	—	Barnett	42"	16mm
36-0608	67052-78B	—	49"	16mm
<b>1987-92 FXRT.</b>				
36-2410	36-2530	67054-83A	46.5"	16mm
<b>1984-95 FXST-FXSTC-FXSTS, 1984-95 FXWG, 1993-94 FXDWG, 1991-94 DG. Replaces OEM 67038-84, 67024-84A, 67186-88C.</b>				
36-2416	36-2532	See Text	38.5"	12mm
—	36-0122	Coated	38.5"	12mm
36-0603	36-0819	67051-74	39"	12mm
—	36-0123	Coated	39"	12mm
36-0814	—	Barnett	39"	12mm
36-0604	—	+4"	43"	
36-0605	36-2534	+6"	44.5"	12mm
—	36-0124	Coated	44.5"	12mm
36-2411	36-2533	67060-79A	38"	12mm
<b>1987-95 FLST Models.</b>				
36-2417	36-2428	67079-86A	34"	12mm



**60" Chrome Cable Wrap** is a classic 1950's style dresser trim item. Inner diameter size noted. Sold each.

<b>VT No.</b>	<b>Size</b>
36-0520	5mm
36-0521	6-7mm
36-0525	10-11mm

# Speedometer Drive Kit



**1986-95 Rear Wheel 2.1 Ratio Speedometer Drive Kit** fits FXST-FLST models left side. Use on applications when front wheel drive unit cannot be installed. Accepts speedometer

with 12mm fitting.

**VT No. Item**

36-0615 Kit

36-0417 Cable Only



**Bob Dash Speedometer Cable** adapts to speedometer with 5/8" outer diameter male thread, and front wheel drive.

**VT No. Length Housing**

36-0607 39 1/2" Black

36-2444 39 1/2" Stainless

36-0126 39 1/2" Clear Coated Stainless

36-0610 42 1/2" Black

36-2548 42 1/2" Stainless

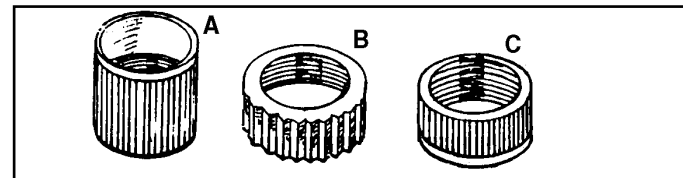

**Replacement Speedometer Cable Nuts** for front wheel drive cables and available in 5 packs.

**VT No. # Type**

36-0397 A 12mm

**Model**

1981-94 FXR

36-0396 B 16mm Fine

1973-77 FXE

36-0515 C 16mm Course 5/8" NPT

Fat Bob

**Cable Adapter** allows use of 5/8" cable on 12mm threaded speedometers.

**VT No. 36-0507**



**Speedometer Cable and Cable Mount** for front wheel drive models 1973-up in 5 pack.

**VT No. OEM Item**

31-0149 38623-68 Chrome Bracket

28-1998 66996-85 Cable Boot



**The Rubber Cable Boot** helps secure cable screw in threads by reducing vibration at cable end on all front wheel drive cables. Drive not included.

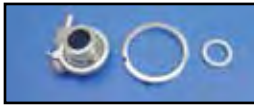

**21" Wheel Speedometer Drive Kit**  
includes drive and adapter ring to utilize a 2240:60 speedometer on 1973-80 FXWG dual disc and FLH, single disc.

VT No. 36-0565

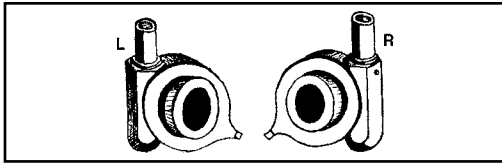

# Electronic Speedometer Sensor



**Programmable Transmission Speedometer Sensor** is a fully adjustable sensor assembly for all 5 and 6 Speed transmissions with electronic drive speedometer. It allows fast and accurate adjustments for any tire size, pulley size on gear ratio change.

VT No. 36-0150



**Speedometer Calibrator Corrects** readings of stock electronic speedometers when using oversized rear tires or when other drive train modifications have been done that effect final drive ratio. Use on all Big Twins.

VT No. Brand  
36-0250 S&S  
36-0422 V-Twin



**Speedometer Drive Unit** fits front wheel only with .750 axle hole. Use for right and left side as noted.

VT No.	OEM	Side	Spacer Length	Overall Length	Fits
36-0802	67127-84A	Left	.361"	.940"	1984-94 FX-FXR
36-0803	67120-84B	Left	.574"	1.410"	1984-95 FXST 1984-86 FXWG
36-2539	Chrome	Left	.574"	1.410"	As Above
36-0804	67073-81	Right	Flat	.532"	1981-84 FLH 1984-86 FLT
36-2450	67073-87A	Left	.421"	1.245"	1987-95 FLT
36-2453	67101-96	Left	.442"	1.248"	1996-99 FLT
36-2451	67132-85A	Left	.321"	.938"	1987-95 FXLR
36-2452	67125-86A	Left	.608"	1.426"	1986-95 FLST
36-2553	67166-88	Left	.461"	1.277"	1988-95 FXSTS
36-0807	Chrome	Left	.461"	1.277"	1988-95 FXSTS



**Electronic Speedometer Sensor Unit.**

VT No. Fits  
17-0561 1996-99 FXST  
17-0582 2004-2006 FLT, 2000-2006 FXST-FLST  
17-0585 1995-2005 FXD  
17-0595 1995-2003 FLT  
39-0581 Harness



**Speedometer Sending Unit Wrench** features a shortened 3/16" ball end hex bit for removal or installation of hex screws used on all Big Twin models equipped with electronic sending units.

VT No. 16-6738



**Chrome Speedometer Drive Cover** fits over the existing drive units.

VT No.	Year	Model	Fork
42-0432	1984-95	FXST-FLST-FXWG,	41
	1987-95	FLT-FLHS	
42-5044	—	As Above	41
42-0434	1987-94	FX-FXR	39

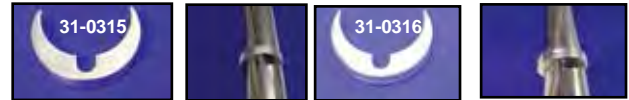

**41mm Push On Fork Tube Clamps** to secure speedometer cables and brake lines.

VT No. Style  
31-0315 Smooth  
31-0316 Groove

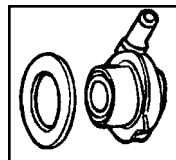

**Speedometer Drive Seal.**  
VT No. OEM Model  
14-0944 67098-87 1987-94 FXR  
14-0947 67118-87 1987-95 FXST



**Speedometer Drive Spacer** replaces drive units. Fits 1984-95 FXST.  
VT No. 44-2008





# Snap Cap™

37-9537



These bolt cover kits will make any bike look great and are also for custom builders use. Easy to install these kits have beautifully designed pieces to cover the raw OE bolt heads on engine, transmission, primary and more, each kit includes detailed instruction for installation on each model as listed, all covers in each kit are individually packed and numbered for identification.

## Chrome Bolt Cap Cover Kit

VT No.	Year	Kit Quantity
<b>Dynaglide</b>		
37-9541	1999-up	156
37-9528	2006-up	76
37-9529	1999-05	86
<b>Softail</b>		
37-9543	1999-up	175
37-9530	2007-up	81
37-9531	2000-06	87
37-9536	2009-up	125
<b>FXCW</b>		
37-9537	2009-up	105
<b>FLSTSB</b>		
37-9538	2009-up	116
<b>Engine</b>		
37-9535	TC-88	79

*Wescott Fastening*

- Snap On
- Tight Fit
- Easy Installation

# Chrome Dome Cap

37-1505



## 300 Pc Assortment (37-1505)!



Snap Caps™ snap on knurled allen screws for ease of installation. Packs of 25 or 100.

100 pack	25 pack	Fits
37-1502	37-1526	1/4"
37-1503	37-1527	5/16"
37-1504	37-1528	3/8"
300 Pieces		
37-1505	—	Assortment

# Allen Screw Kit

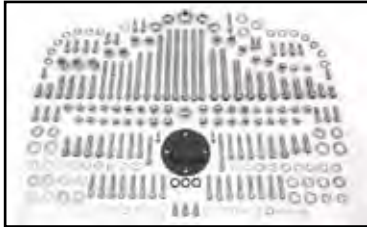

**Gardner-Wescott Fasteners** are the perfect combination of allen screws and acorn nuts. Contains timing plug, oil pump, left and right side covers, clutch and chain cover, top front and rear engine mount with stabilizing link fasteners and regulator bracket mount on FXR-FLT lifter base, point cover, header mount, casing and inner primary to casing, rocker box, cylinder base, motor case. Transmission cover and washers supplied where needed. Where there is a bolt you get an allen screw. Where there is a nut you get an acorn. All heads polished chrome, smooth without knurls.

## Builders Chrome Fastener Sets

VT No.	Fits
37-8100	2000-06 TC-88B FXST-FLST
37-8099	1999-05 TC-88 FXD
37-8097	1996-99 Evolution FXST-FLST
37-8096	1996-99 Evolution FXST-FLST
37-8096	1996-98 Evolution FXD
37-8090	1991-95 Evolution FXR
37-8091	Late 1991-95 Evolution FXDG
37-0086	1987-90 Evolution FXR
37-0084	1984 Evolution All 5 Speed, except FXST
37-0083	1985-86 Evolution 4 Speed and 1984-85 FXST



**Cam and Primary Cover Chrome Screw Sets** include transmission, chain, clutch or derby provided where applicable. By Gardner-Wescott.

VT No.	Fits
37-8500	1991-05 Dynaglide
37-8501	1987-06 FXST-FLST Softail
37-8502	1987-06 FXR 5-Speed
37-8503	1985-86 FXR 5-Speed



## Chrome Polished Allen Head Show Bike Kits.

Model	VT No.	Year
VRSC	1021-P	2002-up
Softail	1018-P	2000-06
	1004-P	1992-99
	1005-P	1989-91
	1006-P	1987-88
Dynaglide (FXD)	1000-P	1999-05
	1003-P	1991-92
Evolution 4-Speed	1007-P	1984-86



**Big Twin Polished Chrome Engine Sets** include all side covers, lifter base, timing plug, inner primary mount, top, front, and rear motor mounts with stabilizing link fasteners on FXR and FLT models. Sets also include rocker box covers, header mount and points cover or generator mount where applicable with washers and nuts where needed.

## Big Twin

VT No.	Fits
37-8101	2000-06 TC-88B FXST-FLST
37-8102	1999-05 TC-88 FXD
37-8088	1991-99 Evolution FXR
37-8089	L1991-99 Evolution FXDG
37-8087	1987-95 Evolution FXST-FLST Softail
37-9300	1987-90 Evolution Big Twin FXR
37-8085	1986 Evolution FXST-FLST
37-8084	1984-86 Evolution 5 Speed, except FXST



**COLONY**

# Show Bike Kit

BIG TWIN

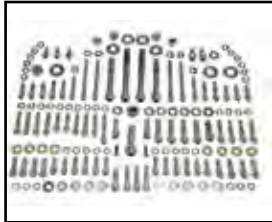

**Chrome Allen Show Bike Kits**  
by Colony for 1999-up TC-88 models.

VT No.	Model
1000	1999-05 FXD
1000-P	1999-05 FXD Polish
1018	1999-06 Softail
1018-P	1999-06 Softail Polish

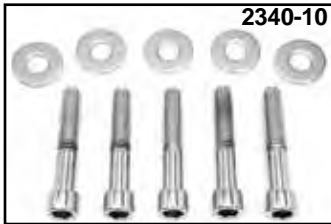
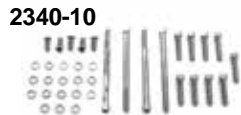

## 2006-up FXD-FXDWDG Screw Kits.

VT No.	Fits
2344-10	Oil Pan
2345-6	Shift Cover
2340-10	Pulley Bolts
2341-5	Front Rotor
2346-3	Dash Panel
2342-18	Primary Cover
2342-18T	Primary Cover



## Show Bike Cap Kits in chrome finish.

VT No.	Fits
8520	1987-88 Evolution Softail
8521	1989-91 Evolution Softail
8517	1984-86 Evolution 4 Speed
8518	1985-86 Evolution 5 Speed



Show Bike Kits are original chrome detailing by Colony for models listed. Includes acorn or cap nuts for engine and transmission area.



Cap Acorn

## Acorn

Chrome	Gold	Year	Model
7929	—	1987-91	FXR
7930	—	1992-95	FXR
7931	—	1996-98	FXR
7917	7917-G	1984-86	Evolution 4-Speed Big Twin
7918	7918-G	1985-86	Evolution 5-Speed Big Twin
7920	—	1987-88	Evolution Softail 5-Speed
7921	7921-G	1989-91	Evolution Softail and Dynaglide
7923	—	1992-95	Evolution Softail and Dynaglide
7924	—	1996-98	Evolution and Dynaglide
7925	—	1999-05	Twin Cam 88 Dynaglide
7928	—	2000-06	Twin Cam 88 FXST-FLST





# Bobbed Tank for Dynaglide



2" Stretch Tanks fit FXDWG models with stock dash. Tanks accept right and left side bung cap set.  
**VT No. Year Gallons**  
**38-0257** 1991-95 4.0  
**38-0271** 1996-05 3.7



**Bobbed Gas Tanks** for FXD and right side FXDWG or screw on bung for carburetor and EFI models are replacement type. Available with left side stock fuel gauge or right and left screw bung.

VT No.	Type	Left Cap	Year	Gallons	Fits
38-0374	WG	Screw	1996-05	4.2	Carb
38-0829	WG	Screw	1996-05	5.1	Carb
38-0822	WG	Fuel Gauge	1996-05	5.1	Carb
38-0545	WG	Fuel Gauge	2006-up	5.1	EFI only
38-0547	WG	Fuel Gauge	2010-up	5.1	EFI
38-0548	WG	Fuel Gauge	2004-up	5.1	EFI
38-0549	FXD	Fuel Gauge	2010	5.1	EFI



**2" Stretch One Piece Tank** fits 1991-2005 FXD-FXDWG carburetor models. 38-0580 includes aircraft cap installed. VT No. 38-0174 accepts vented bung cap.

VT No.	Type
38-0580	Aircraft
38-0174	Bung
38-0426	Cap with key

**FXDWG Dash Bracket** will accept 2000-up electronic dash and speedometer plus FXDWG OEM electronic dash 71246-95 and 71246-99. **VT No. 31-0803**

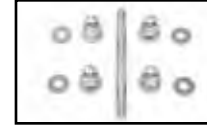

**Gas Tank Mounting Kit** includes chrome custom acorn nuts, washers and studs. Mounts gas tank on 1991-05 Dynaglide. **VT No. 2076-10**



**Bobbed Gas Tank Kit** for Dynaglide and FXR models. Features one piece 4 gallon design, which includes chrome bung style late caps, and all necessary mount hardware for installation. Kit also includes a complete 3 light dash kit which includes a plain dash base without wiring, Bob style speedometer, a 43" speedometer cable for front wheel drive application and a late Bob type 6 post chrome key switch. Units for 1995-up do not include speedometer or cable, but include bracket to mount stock electronic speedometer.

VT No.	Years	Ratio	Model
38-0189	1990-94	2240:1	FXD
38-0190	1995-05		FXD
38-0126	1982-94	2:1	FXR

# Bobbed Tank for 2000-up Softail

Note: 2004-up Softail models use electronic fuel injected tank.

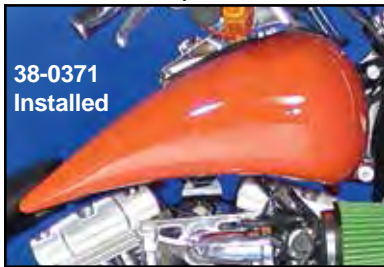

38-0371  
Installed



38-0371



38-0376

2000-06 Stock Type Bobbed for carburetor models features right side cap and left side fuel gauge. Accepts fuel gauge 38-0332.

VT No. 38-0376

2000-up One Piece Bobbed Gas Tank for Softails. 5.1 gallon capacity tanks use stock mount hardware. Stretch tanks have 2" stretch welded seam on extensions. See notes:



38-0370



38-0379



Bobbed Stretch Tanks fit Softail models will accept left side fuel gauge.

VT No. Type

38-0379 Carburetor models

38-0380 EFI models

Carburetor models

Year

2000-03

2000-06

2004-06



38-0373 Installed

Note: All Softail models 2007-up are Electronic Fuel Injection



38-0373



38-0372



38-0798



38-0387



38-0261

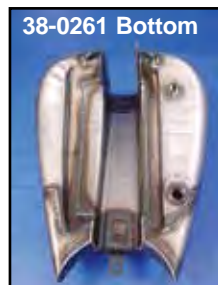

38-0261 Bottom



38-0388



38-0389

2000-06 Softail 2" Stretch Tanks are 4.2 gallon tanks.

VT No. Model

38-0387 Carburetor

38-0388 EFI

38-0389 EFI

Note: 2004-up carburetor models use electronic fuel injected tanks.

Bung

Single

Right and Left Bung

Right Bung, Left Gauge

VT No.	Type	Model	Year
38-0370*	Stock	Carburetor	2000-06
38-0371*	Stretch	Carburetor	2000-06
38-0372*	Stock	EFI	2000-07
38-0373*	Stretch	EFI	2000-07
38-0798**	Stock	EFI	2008-10
38-0261**	Stretch	EFI	2008-10

\*Note: Utilizes right and left bung caps, does not have provision for installing OE fuel gauge.

\*\*Note: Has provision to fit OE fuel gauge in left hand bung hole.



2000-up Tank Mount Kit includes all hardware bushings and front bolt with chrome cap nuts.

VT No. 37-9367



Block Off Plate fits 38-0261.

VT No. 38-0878







# Bobbed Tank for Softail's 1984-99

38-0152



**Bobbed Gallon Flat Side Mount Tanks** fit 1984-99 FXST-FLST or other flat side mount systems. Updated shape has taper from front to rear. Available to accept stock bung caps.

VT No.	Gallon
38-0152	5
38-0129	6

38-0120



38-0121



**Bobbed Gas Tank Set** fits 1984-99 FXST-FLST models, features screw bung.

VT No.	Size	Item
38-0120	3.5	Tank Set
38-0566	3.5	Tank Set
38-0121	5.0	Tank Set
38-0122	6.0	Tank Set
38-0321	Pair	Chrome Capst

**Note:** 38-0122 tanks require leather pressed steel or the flexible tank dividers as the tanks have slightly different shape than stock.



38-0144



A



38-0348

B



38-0337

A

**Air Craft Cap Style Bobbed Gas Tank Sets** fit 1984-99 FXST-FLST or other flat side tank mount systems. Updated shape is tapered from front to rear. Filler neck available as **"Bolt In"** with insert held in place by 6 chrome allen screws or **"Weld In"** where insert is welded in place. Order appropriate caps separately.

VT No.	VT No.	Gallon
(B) Bolt In	(A) Aircraft	
38-0144	38-0157	5
—	38-0146	7
38-0348	38-0337	Cap Set

## Stretched



38-0566

**Fat Bob 3.5 Flatside Bobbed Tank Set** features handshift gate provisions to fit early style gates for 1936-46. These flat side tanks feature screw type bungs. Order caps separately. Petcock fitting should be masked or plugged during painting for easy installation. The side tank features side shift tank mounts. For use with cateye 1936-1946 type shifter gates or the conversion gate for 5 and 6 speed models, smooth type.

VT No. 38-0566



Stock Bung



38-0280 Installed

**38-0280** features smooth one piece side panels in 5.2 gallon capacity

**Stretch Bobbed Tank Set** includes flat side style tank. The "stretched" rear section of the tanks does not hold gas. Fits 1984-99 Softail models. VT No. 38-0280 features seamless stretched portion. 5.2 gallons.

VT No. 38-0280



38-0637



38-0638

**Bobber Tanks** for Softails brackets included. Order cap separately.

VT No.	Year
38-0637	1984-99
38-0638	2000-05

**For Measurements of Our Gas Tanks**

see our website [www.vtwinmfg.com](http://www.vtwinmfg.com)

**Important Gas Tank Information:** All tanks are shipped unpainted unless otherwise noted. Caps and petcocks are not included. Carefully check the new tank for flaws and fit before painting. Do not grind or sand the seams or joints. Clean the inside of the tank and it is suggested to pressure test and use a tank sealer. Check petcock openings, making sure the petcock can be easily installed. Use proper hardware to mount tank, including the bushings, brackets and spacers required for assembly. Tedd Cycle, Inc. is not liable for paint work or labor claims of any kind. Tedd Cycle, Inc. is not the manufacturer of the gas tanks.

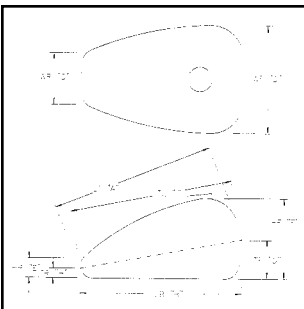

- A Length Top
- B Length Bottom
- C Width Rear
- D Width Front
- E Height Rear
- F Height Front
- G Height Tunnel, Front
- H Height Tunnel, Rear
- I Tunnel Length



Indented Side Panel Styles



# Bobbed Tanks for Softails



38-0123



38-0259



38-0193



38-0116



38-0081



38-0273



38-0194



**Smooth One-Piece Tanks** fit 1984-99 Softail models are 4.2 gallon, stretched and includes hardware for mounting. Order stock bung caps separately. Some seats may not match up. VT No. 38-0155 is a 2" stretch 1 piece tank with a 2" extension welded on. 38-0273 does not have seat cut out.

VT No.	Cap	Stretch	Sides
38-0193	Dual	2"	Smooth
38-0273	Single	2"	Smooth
38-0194	Single	3"	Smooth, Aircraft

**Bobbed Gas Tank** for 1990-05 Dynaglide and 1982-94 FXR are a one piece, 4 gallon unpainted tank with dash cut out which includes a chrome dash panel. It bolts on with no additional hardware. Tank with dash cut out requires purchase of complete dash kit. 1996-05 FXD models require purchase of VT No. 39-0124 Speedometer Adapter to reuse existing speedometer in a bobbed dash. Tank will accept stock dash from 1991-96 FXDWG. Smooth tank fits 1991-05 all FXD-FXDWG.

VT No.	Dash Cut	Model	Years
38-0123	With	FXD	1990-05
38-0259	Without	FXD	1990-05
38-0116	With	FXR	1982-94
38-0081	Without	FXR	1982-94

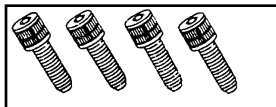

Fuel Tank Chrome Allen Screws.

VT No.	Year	Model
37-9294	1988-94	FXRS



38-0180



38-0181

**Bobbed Tank Kits** for FXD and FXR models are 4 gallon available with chrome cast dash assemblies which include a Bob type 6 post key switch and a plain dash base. Pre 1995 units include a Bob speedometer. 38-0178 kits include an adapter ring to allow reuse of the existing electronic speedometer. Chrome caps included.

VT No.	Years	Ratio	Model
38-0180	1990-94	2240:1	FXD
38-0178	1995-05		FXD
38-0181	1982-94	2:1	FXR

Tank Assemblies sold with "Plain Dash Base" are not designed to be wired for instrument lighting. Dash bases VT No. 39-0959 for 3-light and VT No. 39-0960 for cast dash are available separately for builder requiring dash lighting.





# Tank Mount Kit



38-0855



38-0856



38-0858



38-0859

**Tank Lifter Kits** will raise the front of the stock gas tank.

VT No.	Year	Model	Lift
38-0855	1997-05	FXDWG	2"
38-0856	1997-05	FXDWG	3"
38-0858	2000-10	FXST	2"
38-0859	2000-10	FXST	3"

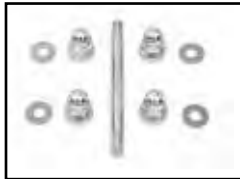

**Gas Tank Mounting Kit** includes chrome custom acorn nuts, washers and studs to mount gas tank on 1991-up Dynaglides.  
**VT No. 2076-10**



**Gas Tank Mounting Kit** includes chrome custom acorn nuts, washers and stud.  
**VT No. Fits**  
**2077-5** 2000-up Softail  
**2128-5** 1984-89 Softail  
**2528-10** 1990-95 Softail



**Chrome Tank Mount Kit** includes all hardware and front bolt with chrome cap nuts. Fits 2000-up Softail.  
**VT No. 37-9367**

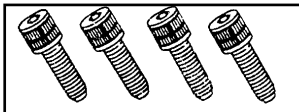

## Fuel Tank Chrome Allen Mounting Hardware Kits.

VT No.	Fits
37-9250	1984-89 Softail Models
37-9294	1988-up FXRS Models
37-9252	1990-99 Softail Models
2072-4	1990-99 Softail Models
37-9253	1991-up Dynaglide Models
2076-10	1991-up Dynaglide Models
2077-5	2000-up Softail Models

## Custom Tank Mount Bolt Sets.

37-9330	2000-up Softail Lower
---------	-----------------------



**2000-up Softail Tank Mount Adapter Kit** allows 1984-99 two piece Bobs to be mounted to 2000-up models and utilize original dash panel.  
**VT No. 51-0519**



**Weld-On Rear Tank Dowels** are tapped for  $\frac{5}{16}$  — 24 thread.  
**VT No. 51-0858**



**FXST Allen Tank Mount Kit** includes two brackets, chrome allens and chrome washers for 1984-99 FXST-FLST.  
**VT No. 38-7021**

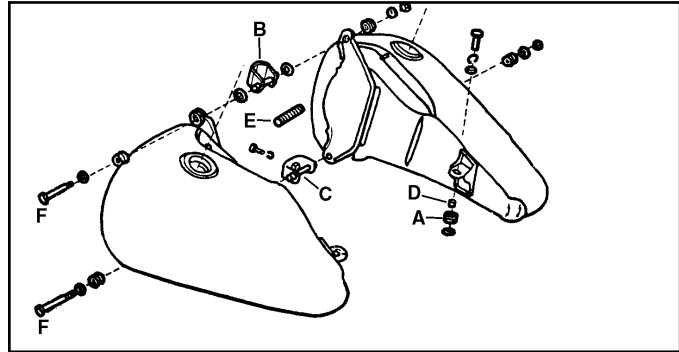

VT No.	#	OEM	Item
28-2006	A	11447	Rubber Grommet
31-0236	B	61660-85	Upper Bracket with threads
31-0234	B	61660-84	Upper Bracket without threads
31-0235	C	61667-84	Lower Bracket
31-0455	C	61667-90A	Lower Bracket 1991-99 with threads
37-9094	D	5775	Spacer
40-0364	E	63505-84	Hose, 10 ft.
38-0222	F	Kit	Chrome Bolt Kit 1984-90
38-0229	F	Kit	Chrome Bolt Kit 1991-99
37-1427		7965	"T" Nut



**FXST Lower Gas Tank Mount Kit** for 1984-99 style flat side tanks includes chrome acorn nuts, thread stud and two beveled washers.

VT No.	Style
37-9012	Acorn
2072-4	Flat Allen
28-2006	Rubber Grommet



**Gas Tank Mounting Kit** includes chrome countersunk washers and flat head allen bolts. Mounts lower front gas tank. Fits 1991-99 Softail.  
**VT No. 2072-4**

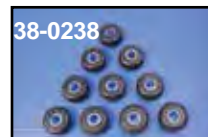

**Rubber Grommets and Spacers Kit** includes rubber grommets and spacers, used on all 1984-1999 Softail. Pack of 10.  
**VT No. 38-0238**

# Wire Harness/Dash Base Assembly



**Wiring Harness /Dash Base Assemblies** include complete harness pre-wired to 5-light dash base, 6 post key switch, terminal box, horn button, dimmer switch, headlamp connection, speedo lamp socket and front terminal board when required. VT No. 39-0193 uses 39-0399 flasher (included). 39-0191 requires use of 32-7508 turn signal canceler available separately. The 1987-95 assemblies require purchase of handlebar switch wiring.

VT No.	Year/Model
39-0193	1987-88 FXST-FLST
39-0194	1989-90 FXST-FLST
39-0191	1991-95 FXST-FLST

**Note: Order the appropriate factory service manual to facilitate wire harness installation.**



Relax...We've done your homework on this one!

**FXST Builders Harness/Dash Base Assembly.** Builders Harness includes all correct color coded high tension wires, handlebar wires and tail lamp wires for years listed. Dash base assembly includes wired base, 6 post switch, circuit breakers and flashers. Allows use of either the turn signal canceler VT No. 32-7508 (not included) or flasher VT No. 33-0399.

VT No.	Item	Year
39-0968	Dash Base Assembly	1987-95
32-0675	Builder Harness	1987-88
32-0456	Builder Harness	1989-90
32-0726	Builder Harness	1991-95



**Assembled Dash Bases** are wired with all sockets.

VT No.	Item	Year
39-0960	Cast	1968-95
33-0133	Bulb	1965-up 12 Volt

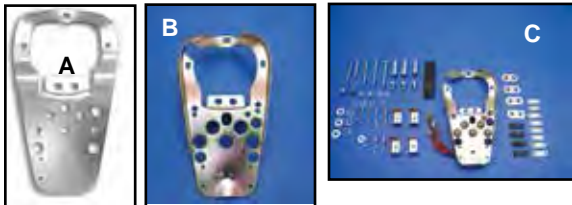

**Dash Mounting Plates** available plain, less wiring and sockets, or complete with sockets and hardware.

VT No.	#	Type	Dash	Year
39-0138	A	Plain only	2 and 3	1948-up
39-0944	B	Base only	Cast	1973-up
39-0960	C	Assembled	Cast	1968-95

**Dash Plate Ignition Switch Spacers** are for spacing dash base and switch in relation to tanks, packs of 10.

VT No.	Size	Type
39-0420	.030"	Dash
39-0421	.060"	Dash
39-0422	.120"	Dash
39-0118	.040"	Switch

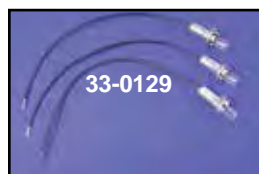

**Light Sockets** available with steel or plastic body. Bulbs are included.

VT No.	Item
33-0129	1 wire, 3 pack, steel
33-1983	2 wire, 3 pack, plastic
33-2007	2 wire, 3 pack, steel
	Socket has ground wire
33-0534	2 Wire, Insulated type, pair
33-0531	Speedo socket 12V
33-0537	1986-95
33-0138	12v bulb, 10 pack



**Dash Mount Hardware** includes bolts, spacers and hardware to install 1948-98 type dash mount bases on 1984-98 FXST-FLST models with flat side tanks.

VT No.	Item
39-0209	Kit
39-0210	Spacer, Front
39-0214	Spacer, Rear





# Tank Divider



39-0926  
Installed

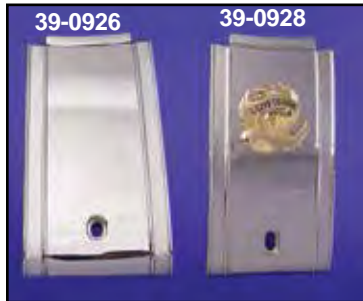

39-0926

39-0928

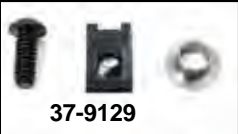

37-9129

**Chrome Die Cast Tank Trim Panels** replace existing rubber divider on 1984-99 FXST-FLST with die cast dash.

VT No.	Years/Model	Type
39-0926	1984-99 FXST	Chrome
39-0927	1984-99 FXST	Eagle Spirit
39-0928	1984-99 FXST	Gold Inlay Eagle Spirit
28-0433		Rubber Pad fits B, C, D
37-9129	FXST	Screw Kit



**Tank Panel Black Rubber Divider** for 1984-99 FXST models.  
VT No. 28-0714



**Chrome Long Rider Dash Panel** is constructed of ABS plastic. Fits bobbed tanks on 1968-95 FLH-FXWG-FXST models. Rubber strip included.  
VT No. 39-0450



39-0973



39-0974

**Long Rider Dash Complete Kit** with speedometer and switch for 1948-95 Big Twins.

VT No.	Ratio
39-0973	2:1
39-0974	2240:1



**Chrome Dash Panel Extension** extends the look of the dash on 2000-up Softail models. Replacing 71283-01.  
VT No. 39-0429



**Chrome Panel Edging** slips on sheet metal dash panels and hub cap edges for decorative use. Sold in a 10 foot roll.  
VT No. 37-8943



37-9129

**FXST Tank Panel Mount Nuts and Screws.**

VT No.	OEM	Item
37-9128	61641-84	Bushings, 5 pack
37-8700	Screw	Chrome Button, 10 pack
37-9129	Kit	As above



**Speedometer Adapter Ring** fits 1995-up FXD. It includes mount bracket and adapter ring to fit cast dash.  
VT No. 39-0192



39-0100

**Chrome Dash Cover** fits 1982-92 FXR, 1984-87 FXRS, FXRT, 1986 FXRD, 1987-92 FXR, FXRT, FXRS-SP and FXRS-CON. Replaces 61411-82. The two holes accept a fuel gauge and gas cap.

VT No.	Item
39-0100	Chrome Cover
9014-3	Acorn Bolt Set
9016-3	Button Bolt Set
28-2238	Rubber Trim Strip

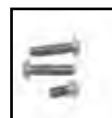

**Chrome Dash Panel Screws** for 2005-up FXDWG.  
VT No. 2346-3



**1996-up Softtail Bobbed Dash Components.**

VT No.	OEM	Item
39-0101	71254-96	1996-99 Dash Only
39-0896	Kit	1996-99 Chrome Dash Panel with Switch
39-0987	71250-00	Chrome Dash Panel, 2000-10
<b>Component Listing</b>		
37-0555	7497	Acorn Lock Nut, 1996-up
33-0134	53439-79	Bulb Back Light, 1996-up
39-0453		MPH Speedometer, 1996-03
39-0449	67033-99	MPH Speedometer, 1999-03
28-0139	67190-89	Speedometer Seal, 1989-up
39-0179	67880-94	Reset Switch Boot, 1994-up
33-0137	68024-94	Indicator Lamp Bulbs, 1994-98
39-0180	71302-93	Switch Name Plate, 1994-up
32-0439	71313-96	Ignition Switch, 1996-up
32-0931	72191-94	Terminal, Socket
32-0936	73191-96	Socket Contact



**Dash Board Rubber Strip** closes the gap between dash and tanks.

VT No.	Fits	Type	Model
28-0543	1968-94	Dash	Big Twin
28-0554	1988-92	FXRS	FXR
28-0540	1977-84	FXS Type	FX

# Dash

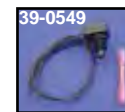
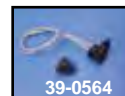
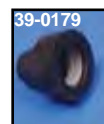
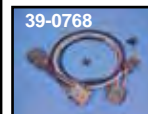

**Speedometer Reset Knob** fits 1998-up models. Replaces 67854-98.

VT No.	Item	Model
39-0767	Harness	1995-98 FXST, FLST 1996-97 FXDWG
39-0768	Harness	1995-98 FL
39-0787	Harness	1998-99 FXDWG
39-0549	Reset Knob	All
39-0179	Reset Knob Boot	All
39-0564	Reset Knob Kit	

# Speedometer Sensor



**Programmable Transmission Speedometer Sensor** is a fully adjustable sensor assembly for all 5 and 6 Speed transmissions with electronic drive speedometer. It allows fast and accurate adjustments for any tire size, pulley size on gear ratio change. **VT No. 36-0150**



**Speedometer Calibrator** **Corrects** readings of stock electronic speedometers when using oversized rear tires or when other drive train modifications have been done that effect final drive ratio. Use on all Big Twins.

VT No.	Brand
36-0250	S&S
36-0422	V-Twin



**Electronic Speedometer Sensor Unit.**

VT No.	Years	Model
17-0561	1996-99	FXST
17-0582	2000-up	FXST
17-0585	1995-up	FXD

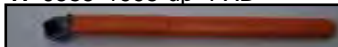

**Speedometer Sending Unit Wrench** features a shortened 3/16" ball end hex bit for removal or installation of hex screws used on all Big Twin models equipped with electronic sending units.

**VT No. 16-6738**



**Chrome Speedometer Sensor Block-Off Plate Kit** includes plate, gasket and mounting screw for 1996-up Softtail.

**VT No. 17-0234**





# Cast Dash Kit



39-0914



39-0913  
Installed

37-9121  
Installed

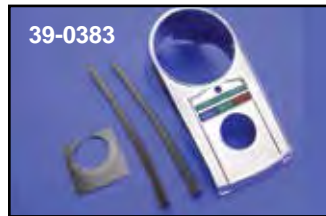

39-0383



39-0413



39-0940

**FLH-FXST Dash Kit** features chrome cast dash with lens and hardware, 6-post switch, choke cable and knob, all mounting hardware and trim strips. Stock on 1968-84 FLH- FXWG, 1984-95 FXST-FXWG is 2240:60 ratio. Can be adapted to all 3½ and 5 gallon tanks. Dash base has wiring and sockets. Spacer kit VT No. 39-0209 is included to mount on 1984-99 Flat side tanks. Choose the proper cable for each application.

VT No.	Type
39-0913	1:1 Ratio
39-0914	2:1 Ratio
39-0972	As Above without Speedometer
39-0967*	As Above without Speedometer
39-0962	2240:60 Ratio
39-0919	1:1 Ratio with Tach
39-0920	2:1 Ratio with Tach

\*Note: Includes plain unwired dash base.



**Dash Panel Decal** fits 1979-93 FL-FLH-FXWG It has a black matte finish, adhesive back, pack of 5.  
VT No. 48-0423



**Choke Cable Nut Kit** includes nut and seal for dash mounted choke on FL-FXWG-FXST models.  
VT No. 37-8942

### How to choose the right Speedometer: For Stock Application

**2240:60  
Ratio**

Fits all Softtail and 4-Speed FXWG, 1984-90 and 4-Speed FL, 1981-84 models with front wheel speedometer drives with 16" and 21" front wheel applications, and 1996-2007 electronic speedometers. The 2240:60 may also be used in conjunction with 1991-95 speedometers with reed for self-canceling turn signals if specified.

**Dash Panels** include lens & rubber strips except where noted.

VT No.	Finish	Model
39-0383	Chrome	1968-90 Big Twin-FLH FXST-FXWG
39-0352	Raw for painting	1968-90 Big Twin-FLH FXST-FXWG Less hardware lens and strips
39-0413	Gold	1968-90 Big Twin-FLH-FXST-FXWG
39-0940	Chrome	1991-95 Big Twin FXST



37-9121

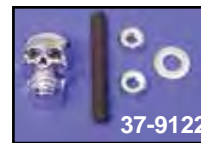

37-9122

VT No.	Type
37-9121	Acorn
37-9122	Skull
37-0573	Stud only

**Chrome Dash Mount Stud Kits** include stud, nuts, nylon washer and either skull or acorn nut, Fits 1968-up cast dash panel on FXST-FL-FXWG when choke cable is not used.



**1975-95 Dash Hardware Kit** includes parts pictured to fit the FLH-FXWG-FXST cast type dash, stock or 39-0383.

VT No. 39-0382



**Late Dash Parts** fit late cast dash panel 1968-95 FLH-FXWG-FXST.

VT No.	Year/Item
39-0345	Support
39-0347	Retainer
39-0348	Lens clip

## Dash Panel



**Chrome Dash Dress Up Kits** include dash, panel, rubber strip and chrome allen screws. Fits 1988-92 FXRS.  
VT No. 39-0923



**Chrome Center Tank Panel** for the split tanks of 1977-84 FXS-FXSB-FXEF-FXB. VT No. 39-0104

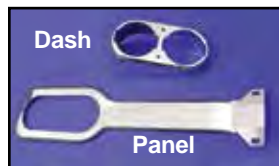

Dash

Panel



39-0424



39-0412

**Chrome Dash and Panel.** Order bolt kit separately.

VT No.	Item	Fits
39-0424	Dash	1995-03 FXDL
39-0412	Dash	1988-92 FXRS, 1991-94 FXDL
39-0411	Panel	1988-92 FXRS
28-0554	Rubber Trim	Dash All
28-0200	Rubber Trim	Panel All
37-8706	Screw	¼ x 20 x 1½ Dash Mount Screw

**28-0200**





# 2 or 3 Lite Dash Kit



### Dash Panels

VT No.	OEM	Type	Finish
39-0111	71271-56	2	Chrome
39-0953	71271-56	2	Raw
39-0110	71272-62	3	Chrome
39-0144	Without key switch hole		Chrome
39-0893*	Smooth	3	Chrome
39-0892*	Smooth	—	Chrome

\*Note: Fits XL gauge. 91.5 mm opening for 95-00 XL-FXD Speedo



**Cateye Dash Kit** is complete as illustrated. Packaged on 18" x 24" board for point of purchase display. Can be ordered with either plain 39-0129 base, or wired 39-0126 base with sockets and bulbs. Includes either 1:1 or 2:1 ratio speedometer and the correct five post key switch with two keys. Order plain base dash kit 39-0129 when it is not desired to rewire harness for lighting base included is 39-0129. Order cable separately. Can be mounted on 1984-91 FXST and requires 39-0209 spacer kit.

VT No.	Type
39-0921	2:1 With Tachometer, includes wire base
39-0922	1:1 With Tachometer, includes wire base
39-0112	Dash Panel
39-0129	Plain Dash Base



**V-Twin Dash Kits** are available with the popular tach-speedo combination included. Can be wired to 1978-up FX-FL models with a tach that is triggered by coil impulse. See instructions for tach wiring. Wired base includes light sockets and all hardware for installation.

VT No.	Type	Ratio
39-0915	2 Light	2:1
39-0916	3 Light	2:1
39-0917	2 Light	1:1
39-0918	3 Light	1:1

**2 or 3 Light Dash Kit.** Can be ordered with plain base VT No. 39-0138, or wired two light VT No. 39-0958, or three light base with sockets and bulbs 39-0959. Includes either 1:1 or 2:1 ratio speedometer and the correct 5 post key switch with 2 keys. Order plainbase dash kit when it is not desired to rewire harness for dash lighting. Choose proper cable for each application. Nothing else to buy! 3 light dash kit pictured. Can be mounted on 1984-95 FXST-FXWG models.

VT No.	Type
39-0904	3 Light Plain Base 1:1
39-0951	3 Light Plain Base without Speedometer
39-0897	2 Light Wired Base without Speedometer
39-0905	2 Light Plain Base 1:1
39-0906	3 Light Plain Base 2:1
39-0907	2 Light Plain Base 2:1
39-0908	3 Light Wired Base 1:1
39-0909	2 Light Wired Base 1:1
39-0910	3 Light Wired Base 2:1
39-0911	2 Light Wired Base 2:1
39-0964	3 Light Wired Base 2240:60
39-0965	2 Light Wired Base 2240:60



**Speedometer Adapter Ring** adapts to late model speedometer into FLH style steel dash cover. FLH Dash is shown with 39-0130 adapter ring installed, adapter ring must be affixed with an industrial adhesive for a leak proof seal. VT No's 39-0124 and 39-0192 include chrome ring and bracket to mount electronic speedometer in FLH style dashes.

VT No.	Fits
39-0130	FLH type, chrome
39-0124	1995-up XL and FXD includes mount bracket and adapter ring to fit 2 or 3 light dash.

**Warranty-** All Instruments sold as individual pieces or in kits are covered under our warranty "Replacement Only" Provision. Gauge related item part numbers begin with a 39 prefix. No credit will be issued for these items as they are exchange only.





# Electronic Speedometer



**Electronic Speedometers** fits 1996-up Softail, FXWG models.

**VT No. Year**

**39-0453** 1996

**39-0449\*** 1999-03

**39-0581** 2000-up Speedometer sensor harness used with the new speedometers that use an electronic speed sensor.

**32-0587** 1996-98 Harness

**\*Note:** Can also be used to update 1996-98 models but requires separate purchase of wiring harness 32-0587

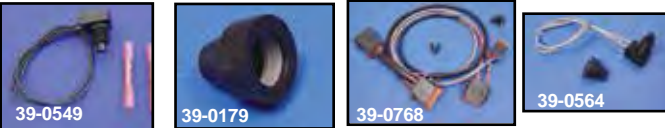

**Speedometer Reset Knob** fits 1998-up models.

**VT No. Item**

**39-0549** Reset Knob

**39-0564** Reset Knob

**39-0768** Pre wired harness, plugs directly to 95-98 FLHR/I OEM harness when upgrading to a new electronic speedometer. VT No. 39-0449 or 39-0651 Speedometer sold separately.

**39-0179** Reset Boot

# FX-FXRS Gauge

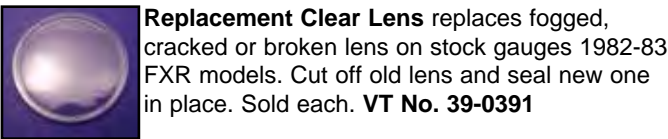

**Replacement Clear Lens** replaces fogged, cracked or broken lens on stock gauges 1982-83 FXR models. Cut off old lens and seal new one in place. Sold each. **VT No. 39-0391**



**Speedometers** have full black plastic case and include brackets. Brackets, replacement plastic lens, and fork tube plugs for mounting brackets and 12 volt bulbs are sold separately.

**VT No. Fits/Item**

**39-0372** 10-150 MPH

1982-83 FXR-FXRS

**31-3964** Speedometer bracket, chrome

**39-0391** Lens only, each

**33-0133** 12V Bulb

**39-0651**  
Installed



**39-0610**



**Electric Speedometer Assembly** with digital odometer.

**VT No. Year Model**

**39-0651** 1996-98 requires 32-0587 Softail

Will not fit 1999 Softail

2000-03

Softail

1996-03

FXDWG

**39-0610** As Above

Digital LED

**39-0795** 2004-07

Softail

**39-0597** 2004-06

Softail-FXDWG

**39-0085** 2004-up

With stock



**Speedometer Head** with 2240:60 ratio for front wheel drive. Features readings of 10-120 MPH. Fits 1986-93 FXR.

**VT No. 39-0934\***

**\*Note:** With auto turn signal switch



**Tachometer Replacement Type**, 0-8000 RPM. Order lamp separately. Fits 1983-87 FXRS, Electric, 1987-93 FXRS-SP, FXRS-CON, 1983-85 FXRT, Electric.

**VT No. 39-0935**



**Speedometer Gauge Bezel.** Chrome plated two piece design bezel clamps around any large style FLH, FXST, FLST or FXDWG Fatbob type 5" speedometer.

**VT No. 42-1049**



# Speedometer Cable Drive Type



**FLH-FXST-FLST Speedometer with Tachometer** is available in 1:1 or 2:1 ratio. It features built in electric tachometer which operates from coil impulse.

VT No.	Ratio	Year
39-0387*	2:1	1981-90
39-0380	2240-60	1991-95

\*Note: Use % speedo nut.



**Multi-Ratio Speedos** are programmable for 1:1, 2:1 or 2240:1 ratio and feature a LED odometer readout or full digital readout. Will accept 12 or 16mm (5/8") cable ends.

VT No.	Item	Type
39-0731	Speedometer	LED
39-0730	Tach/Speedometer	LED
39-0609	Tach/Speedometer	Full Digital
39-0979	Speedometer	Full Digital



**Speedometer-Iso-Support** is a molded rubber support to increase speedo rigidity and reduce vibration for FL-FXST-FXWG-FLST. Use in conjunction with speedometer-iso mount pin kit VT No. 28-1952. Kit includes 28-1952 and 28-0419.

VT No.	Item
28-0419	Support
28-0155	Kit

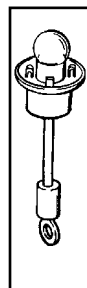

**Speedometer and Tachometer Lamp Sockets** fit FX-XL models or FL as noted.\*Note: Cloth covered wired. All other numbers are vinyl covered

VT No.	OEM	Fits	Model
33-1959	67327-78	1979-85	FX-XL
33-1960	92045-76	1976-77	FX-XL
33-0537	71158-86A	1986-95	FLST
33-2171	67034-83	1983-86	FX-XL
33-1933	67202-86	1986-90	FX-XL
33-1934	67107-83	1983-90	FX-XL
39-0135	71151-67B	1967-73	FX-XL
33-2008	Mini Gauge	48mm	—
33-2039	Mini Gauge	60mm	—
33-0531	71151-48	1948-85	FLH
33-0529*	—	1948-85	FLH
33-0537	71158-86B	1986-94	FL

**Speedometer** fits FXST-FLST in Fat Bob dashes. Accepts 39-0403 reset knob. VT No. 39-0929 features signal cancel switch and one wire lamp socket.

VT No.	Ratio	Year
39-0396	1:1	1968-81
39-0385	2:1	1981-90
39-0384*	2240:60	1981-90
39-0929	2240:60	1991-95
39-0377	2240:60	1991-95
39-0378	2240:60	1991-95
39-0374	2240:60	1991-95
39-0379	2240:60	1991-95
39-0376	2240:60	1991-95
39-0737	2240:60	1981-95
39-0930	2:1	1981-95 KM/H

Note: 39-0384, 39-0929, 39-0930, use 36-2416 or cables with 12mm nut. 39-0396, 39-0385 use 36-0607 or cables with 5/8" nut.

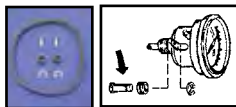

**FLH Speedometer Isolation and Mount Kit** mounts speedometers with 5/8" holes replaces 67066-76. Kit includes two pins, clips, bushings and molded outer ring.

28-1952	Kit
12-0594	Snap Ring Only
28-0139	Seal, 1989-up Softail



**Reset Knobs.** Order for proper applications.

VT No.	OEM	Years/Type
39-0403	67215-89	1981-95 FXST
37-0519	67117-85	Screw for Above, 10 pack
39-0406	—	1981-95 FXST
39-0338	Alloy	All Female
39-0945	67108-83	1987-94 FXLR

**Speedometer Adapter Stud** will allow the use of 39-0134 later knob in speedometer with alloy knob.

VT No. 39-0173





# Mini Gauge Kit

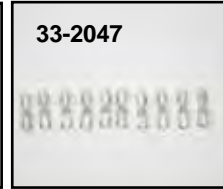

**48mm Deco or 60mm Mini Speedometer Kits** include gauge, chrome bracket, rubber handlebar clamp, and proper cable which can be installed without any adapters or modifications.

48mm Deco	60mm Mini	Ratio	Model/Years
39-0368	39-0315	2:1	1973-95 FX, 1981-84 FL
39-0370	39-0371	2240:60	1981-96 FXST-FLST
39-0598	39-0575	Electric	1995-up FXD 1996-up FXST

## 48mm Deco or 60mm Mini Tachometer Kits

48mm Deco	60mm Mini	Ratio	Model/Years
39-0367	39-0392*		Electric 3-wire type
31-9997	Fits All		Chrome Y mount
33-2008	Fits All		Light socket with bulb
33-2047	Fits All		12 Volt bulb, 10 pack

**Note:** For use on 1978-up models with coil triggered tachometer. Green Negative wire goes to negative side of coil. Red wire goes to ignition side of key switch. Tachometer head must be grounded by black wire.

# Gauge Billet Housing Kit



**Chrome Billet Housing** will accept 48 mm electronic tachometer or speedometer.  
VT No. 39-0116



## Chrome Handlebar Gauge/Clock.

VT No.	Description
39-0785	Clock with White Face
39-0786	Temperature Gauge
53-0871	Battery



**Handlebar Clamps** allow mounting of all types of necessary items with easy installation, fits 1.25" and 1" diameter handlebars. Available in black or chrome finish. Kits include mounting hardware and reducer for 1" bar applications.



VT No.	Finish
31-0026	Chrome
31-0027	Black

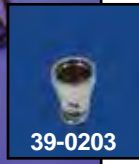
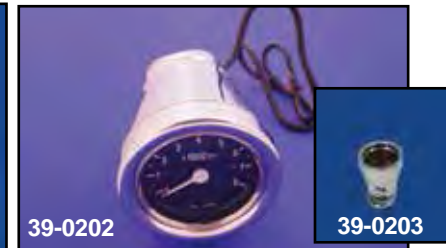
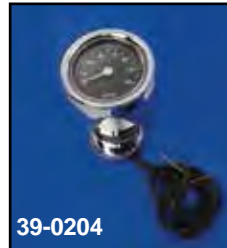

**Chrome 60mm Tachometer Housing Kit** includes bracket to mount to Softail and FXDWG fork stem bolt, 60 mm electric tachometer, or electric speedometer to fit 1995-up models. Housing which is available separately may be fitted with any 60mm electric speedometer or gauge.

VT No.	Item
39-0202	Tachometer Kit
39-0204	Speedometer Kit
39-0203	Housing Only

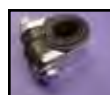

**Chrome Clamp** includes molded rubber insert to attach mini gauges to handlebars for less vibration.  
VT No. 28-0325



# Digital Speedometer and Tachometer



Front Views of 39-0599 and 39-0685



39-0599 Installed with 31-2145



31-0984

B



31-2145



39-0685

A



39-0599

Digital Speedo/Tachometer has the following functions:

- Bar Graph Tach
- High Beam
- Neutral
- Oil Pressure
- Turn Signals
- Digital Odometer
- Trip Meter
- MPH Only
- Unit measures

110mm (L) x 57mm (H) x 38mm (W).

VT No.	Item
39-0599	Gauge (B) Requires an installation bracket
39-0685	Gauge (A) No bracket necessary for installation
31-0984	Bracket
31-2145	Bracket



39-0439

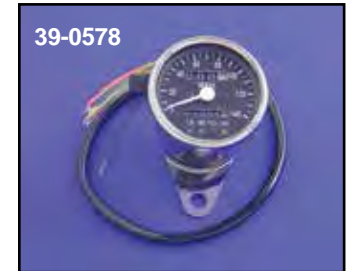

39-0578



39-0440



39-0579



39-0441



39-0580

48mm	60mm	Ratio	Item	Year
White	Black			
Face	Face			
3-LED	4-LED			
39-0439	39-0578	2:1	Speedometer	1973-94
39-0440	39-0579	2240:60	Speedometer	1981-94 Softail



39-0436



39-0438

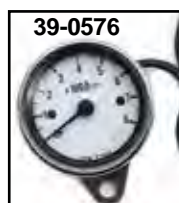

39-0576

Mini Gauges include cable and mount clamp. Note: 39-0556 and 39-0437 includes left side speedometer drive. 39-0436, 39-0550 and 39-0561 feature indicator lights.

- Blue-High Beam
- Green-Neutral
- Red-Oil
- Yellow-Turn Signals

### White Face

48 mm	60 mm	Ratio	Item	Year
39-0435*	39-0550	2:1	Speedometer	1973-94
39-0436	39-0561	2240:60	Speedometer	1981-94 Softail
39-0437**	39-0556**	2:1	Speedometer	1995-99
39-0438*	39-0576*	1978-up	Tachometer	Custom
39-0456	39-0456	Knob	Speedometer	
33-2043	—	—	Light Socket	

\*Note: Does not have LED indicators.

39-0436, 39-0550, 39-0561 have turn signal lights,

Pre-90 models tap into orange wire exiting turn signal flasher  
1991-up models signal indicator light can not be used.

\*\*Note: Does not have LED indicators and includes 2:1 ratio left side speedo drive unit.



39-0550



39-0437



39-0456



39-0550



39-0561





# Mini-Gauges



**2" Mini Electronic Speedometer** fits 1997-up FX.  
VT No. 39-0464



39-0417



39-0433

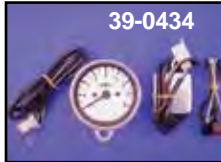

39-0434

**Multi-Colored Mini Gauges.** The 60 mm gauge features a 2.4" polished stainless body and a white face with a total length of 2.7". Units include a chrome bezel with choice of red, orange, blue, yellow, white, green or purple by the push of a button,

works on a 12 volt system. Tachometer adapter required for use with single fire ignition. Speedometer accepts 12 mm drive cable. Order clamp separately.

VT No.	Gauge	Ratio
39-0417	Speedo	2:1
39-0433	Speedo	2240:60
39-0434	Tach	Electric



39-0575



39-0392

**60mm Electric Tachometer and Speedometer** fit models 1978-up for tachometer and 1995-up for speedometer applications.

VT No.	Item	Year
39-0575	Speedometer	1995-up
39-0392	Tachometer	1978-up



39-0563



39-0789

**80mm Electronic Gauge** features stainless housing and Y bracket.

VT No.	Type	Year
39-0563	Tachometer	1978-up
39-0789	Speedometer	1995-up



39-0858



39-0859



39-0593



39-0860

## 60mm Mini Electronic Speedometer/Tachometer.

Speedometer features easy push button recalibration and re-settable trip meter, with LED lighting. The 8000 RPM tachometer has LED lamp. All units have a black face and include clamp. Order 12mm speedometer cable separately on mechanical device speedometer only.

Three functions are (1) accumulated mileage (this can not be reset), (2) Trip 1 (can check total mileage for 1 full gas tank, can be reset to zero), (3) Trip 2 (calculate

mileage from A to B destination, can be reset to zero).

VT No.	Ratio	Type	Item
39-0858	2:1	Mechanical Drive	Speedometer
39-0859	2240:60	Mechanical Drive	Speedometer
39-0593		Electronic Drive	Speedometer
39-0860	0-8000 RPM	Electronic	Tachometer

# Digital Speedo & Tach



**Chrome Billet Speedometer and Tachometer Assembly** clamps to 1" or 1 1/4" bars and includes speed, rpm and temperature functions.  
VT No. 39-0758

## Specifications

Housing Size	120 mm x 42 mm x 28.5 mm 4.72" x 1.69" x 1.12"
LCD	Blue LCD with LED backlit
Speedometer	0-299 mph, 0-399km/h
Odometer	0-99,999.9 miles/km
Trip Odometer	0-999.9 miles/km
Engine Speed	0-20,000 rpm



**60mm Electronic Speedometer** fits electronic equipped sensor 1995-up models. Features blue-backlit LCD display. Bracket and cable included.

Speedometer	0-140 mph or 0-140km/h (selectable)
Odometer	0-99999.9 miles/km
Trip Odometer	0-99999.9 miles/km
Clock (12 hours)	

VT No. 39-0540



# Gauge Mount

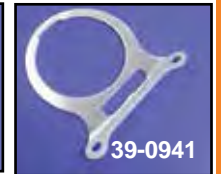
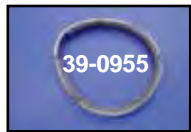

Chrome Gauge Covers fit FXR models.

VT No.	OEM	Year	Type
39-0162	Set	1984-90	Tachometer and Speedometer
39-0395	67092-85	1984-94	Tachometer
39-0394	67090-85	1984-90	Speedometer
39-0943	67091-91	1991-94	Speedometer
39-0955	92061-83	1983-up	FXR Rubber Cushion
39-0956	67104-83	1984-91	XL Rubber Cushion
		1987-up	FXLR



Chrome Billet Fork Tube Gauge Bracket permits quick and easy installation of mini 48 mm gauges to exposed 41 mm or 39 mm fork tubes. Gauges are sold separately.

VT No. Fork Size

31-0876	39mm
31-0877	41mm



Chrome Billet Gauge Holder fits 48mm or 60mm gauges for T-type bars 1" or 1 1/4" with 3/2" center.

48mm	60mm	Holes	Type
39-0602		None	Single
39-0603		2	Single
39-0604	39-0613	None	Dual
39-0605	39-0614	2	Dual

Speedometer and Tachometer Brackets in chrome fit FXR models. VT No. 39-0397 includes visor.

VT No.	OEM	Light	Years	Type
39-0142	67053-83	3	1983-91	Single
39-0397	67053-86	4	1986-91	Single
39-0941	67083-92	Slot	1992-94	Single
39-0212	67293-95		1995-05	Single
39-0141	67110-83	3	1983-91	Dual
39-0400	67036-86	4	1983-91	Dual
39-0942	67167-92	Slot	1992-94	Dual
39-0213	67294-95A		1995-05	Dual



Indicator Lamps for 1986-up FX-FXR-FXD for A & E mounts.

VT No.	OEM	Color	Type
33-2022	68489-86	Red	Oil P.
33-2023	68574-86	Green	Neutral
33-2024	68023-92	Blue	Hi-Beam
33-2025	68695-91	Green	Turn Signal 1991-up



Motor Plaques measure 18" x 24" and are made of metal. Motor Plaque Set includes 9 plaques. VT No. 48-1811





# Oil Tank for Softail and Rigid



**6" Diameter Round Oil Tank** fits FXST style rigid and stock Softail frames. Utilizes stock front and rear Softail mount. Top brackets must be fabricated for installation to use with custom frames. Order bracket set separately.

VT No.	Finish
40-0468	Raw
31-0221	Brackets
37-8961	Drain Plug

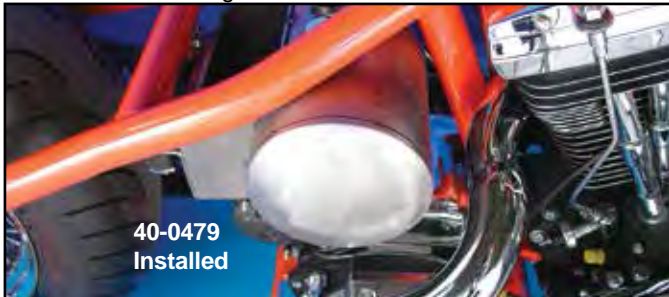

**Domed Round Tank** fits Softail models, center fill.

VT No.	OD	Finish
40-0479	5.5"	Raw
37-8961		Drain Plug



**Chrome Oil Tanks** fit 1986-99 Softail frames.

VT No.	Oil Fill	Shape	Finish
40-0005	Center	Keg	Chrome
31-1259		Bracket	Side



**Rocket Oil Tanks** is 5" diameter to fit Rigid or Softail models.

VT No.	Finish	Lines
40-0477	Chrome	Left
40-0476	Raw	Left
40-0486	Chrome	Right
40-0487	Raw	Right
37-8961		Drain Plug



**Oval Oil Tanks** will mount to stock or custom Softail frames right or left side belt drive applications. Tanks accept stock battery. Order bracket set separately. Fits special application for 200/300 left and right side drives

VT No.	Finish
40-0186	Chrome
40-0187	Raw
31-0221	Brackets
37-8961	Drain Plug



40-0189



40-0189



40-0191



40-0191 Back



40-0191 Installed

**Round Oil Tanks** fit 2000-up TC-88-Softail models with side fill. Tank is 6.5" diameter, 11.75" long and requires removal of coil bracket and relocation of coil. Order mount kit separately.

**Note:** Will not fit rocker models.

VT No.	Finish
40-0191	Chrome
40-0189	Raw
37-8961	Drain Plug
31-0685	Mount Kit
28-0219	Cap

# Oil Tank for 2000- up Softail

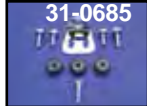

31-0685



**2000-up Chrome Oil Tank** fits Softail models. Replaces 62498-00A.

VT No.	Item
40-0014	Tank
31-0771	Chrome Top Mount
31-0685	Mount Kit



**Oil Line Fitting** features push in release button for installation 2000-up.

VT No. 40-0497



40-0496



40-0498

**Oil Drain Plug** for 1990-up Softails to seal oil hose.

VT No.	OEM	Year
40-0496	62725-90	1990-00
40-0498	60328-98A	2001-up



40-0830 40-0831

**Hose Retainer** fits 2000-up FXST.

VT No.	Year
40-0830	2000-03
40-0831	2004-up



**Billet Oil Drain Block** allows remote mounting with drain plug.

VT No. 40-0485

## Mounting Hardware

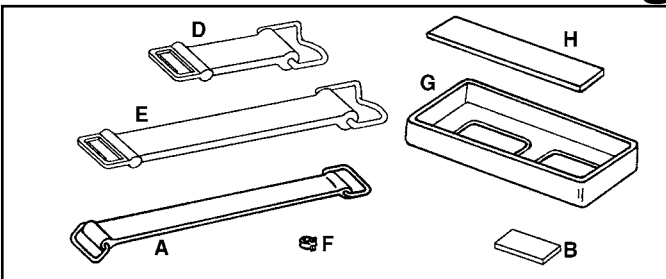

**FXST Battery Hardware** for 1984-99 Softail models.

VT No.	#	OEM	Item	Year
28-2217	A	66105-77	Strap	1984-92
28-0138	B	66004-93	Clamp Pad	1993-99
28-0136	D	66109-93	Front Strap	1993-99
28-0137	E	66111-93	Rear Strap	1993-99
28-0878	—	—	Strap	2001-up
37-8933	F	10067	Vent Clamp	50 pack
28-0423	G	66210-85B	Tray Insert	1986-97
28-0218	G	66210-97	Tray Insert	1998-99
28-0539	H	66309-84 66103-74	Pad	Pair

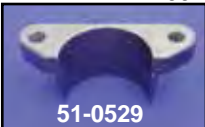

51-0529

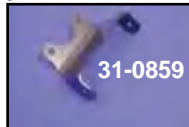

31-0859

**Oil Tank Mounts** for use as center post mount when installing Softail style oil tanks.

VT No.	Item
51-0529	Tube Mount
31-0859	Tank Mount

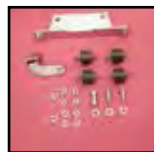

**FXST-FLST Oil Tank Mount Kit** includes two (2) chrome brackets, four (4) Iso mounts and bolts for 1984-99 mounting.

VT No. 31-0221



**Chrome Oil Tank Mount Set** features contour design. Fits stock and custom Softail frames 1986-99.

VT No.	Item
31-0754	Set
31-0757	Rear Mount Only

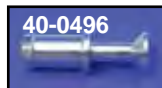

40-0496

**Oil Drain Plug** for 1990-00 Softails to seal oil hose. Replaces 62725-90.

VT No. 40-0496



**Billet Oil Drain Block** allows remote mounting with drain plug.

VT No. 40-0485



**Chrome Iso Mount Kit** includes two (2) 1/4" — 20 UNC thread Iso mounts and two (2) chrome billet covers.

VT No. 28-0565



**Iso-Mount Chrome Cover** for black 1/4" Iso studs. Pair.

VT No. 37-0877



**Oil Tank Mount Kit** includes two weld on tabs and Iso bushing and sleeve set for top mount oil tanks.

VT No. 51-0631





# Oil Tank for 1989-99 Softail



**FXST Oil Tanks** replace 62498-89A. Tanks are 4 spigot type for 1989-99 Softail, FXST-FLST. Features factory welded seams and 3 quart capacity.

**VT No. Finish**  
**40-0393** Primer  
**40-0394** Chrome  
**40-0945** Drain Hose



**Chrome Softail Oil Tank** features center fill and side wings, four spigot type for 1989-99 Softail models, with three quart capacity with stock mounts.

**VT No. 40-0490**



**Chrome Oil Tank** fits 1982-94 FXR models. Includes mounting hardware and hose. Replaces 62406-81.  
**VT No. 40-0094**



**Chrome FXST Oil Tank** is three quart with bottom exit hose fittings, battery box dimensions of 7<sup>7</sup>/<sub>8</sub> L x 4 W for 1989-99. Some years may require "T" fitting for oil drain. Order bracket kit separately.  
**VT No. 40-0396**



**Center Fill Tank** fits 1989-99 Softail models and features threaded inserts on top for custom or stock mounting.

**VT No. Finish**  
**40-0025** Chrome  
**40-0026** Black

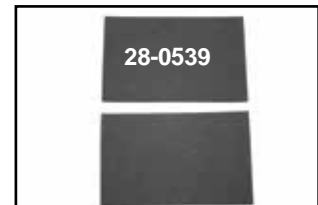

**FXST Battery Hardware** for 2000-up Softail models.

VT No.	OEM	Item	Year
<b>28-0878</b>	—	Strap	2001-up
<b>28-0539</b>	66309-84 66103-74	Pad	Pair



**Raw Oil Tank** for Rigid frames.  
**VT No. 40-0484**



**Oil Tank Dipstick and Temperature Gauge Plugs.** Stock dip sticks also available, replaces rubber plug-in caps.

VT No.	Type	Fits
40-0503	Temperature Gauge	1970-84 FX-FL
40-0361	Temperature Gauge	1984-99 FXST-FLST
40-0674	Temperature Gauge White	1984-99 FXST-FLST
40-0470	Maltese Cap	1984-99 FXST-FLST
40-0556	Temperature Gauge, White	2000-up FXST-FLST
40-0810	Temp Gauge, Black	2010-up FXST-FLST
28-0219	Oil Tank Cap, Plug	All models
40-0227	Maltese Oil Tank Cap	All models
40-0495	Dipstick	1970-84 FL-FX
40-0196	Maltese Dipstick	1965-84 FX-FL
7354-2	1 1/4" - 20 Thread, Hex	Custom Application

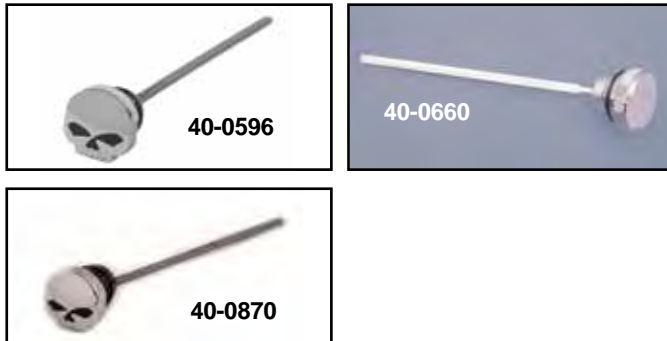

**Chrome Dipsticks for FXD-FXDWG**

VT No.	OEM	Years
40-0596	Skull	1999-2005
40-0660	Plain	1991-1998
40-0870	Skull	2006-up
40-0932	Allen	2006-up

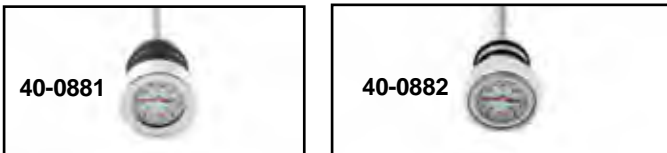

**Liquid Filled for Softail.**

VT No.	Year
40-0881	2000-up
40-0882	1984-99

# Oil Tank Plug and Dipstick



**Oil Temperature Dipstick**

- Feature LCD read out for Softails.
- Push button for 5 second readout.
- Red light indicates extreme temperature! over 275 degrees.

VT No.	Year
40-0659	1984-99
40-0668	2000-up



**Hex**

VT No.	Year	Model
40-0887	2000-up	Softail
40-0888	2006-up	FXD



**Chrome Oil Fill Dipsticks and Plugs for Softail.**

VT No.	Type	Year
40-1279	Flame	1985-99, plug
40-1275	Dome	2000-up
40-1276	Skull	1985-99, plug
40-1277	Skull	2000-up
40-1280	Flame	2000-up

**Plain Chrome Oil Tank Plug** fits 1985-90. Features knurled edge.  
VT No. 40-1283



**Push In Oil Tank Plug** is constructed of rubber with chrome cap for tanks which accept a push in plug. Plug does not have a dipstick.

VT No.	Type
28-0219	Stock, Flat
40-1279	Flame
40-1276	Skull



**Oil Temperature Gauge** fits pre-99 Softail tank.

VT No.	Type
40-0685	Digital
40-0895	Analog





# Oil Related



**Oil Line/Wire Guide** holds (3)  $\frac{3}{8}$ " lines. Tie wraps may be used in conjunction with hose guide for installation.  
**VT No. Finish**  
**40-0221** Chrome, each  
**40-0611** Alloy Set, 2



**Chrome Oil Line To Frame Clamps** available in sizes to fit frame tubes and  $\frac{5}{8}$ " outside diameter oil lines.  
**VT No. Size**  
**37-9262** 1"  
**37-9263** 1 $\frac{1}{8}$ "  
**37-9264** 1 $\frac{1}{4}$ "



**Oil Line Clamp** fits 2000-up Softail models, replaces 91333-06. **VT No. 40-0795**



**Hose Retainer** fits 2000-up FXST.  
**VT No. Year Qty**  
**40-0830** 2000-03 2  
**40-0831** 2004-up 5

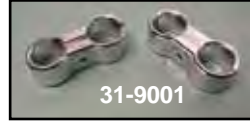

**Oil Line Separators** are a neat clean way to separate and route any  $\frac{3}{8}$ " or  $\frac{5}{16}$ " braided or rubber oil line.

VT No.	Finish	Hole	U/M
31-9000	Polished	2	2
31-9001	Chrome	2	2
31-9008	Chrome	2	2
31-9007	Chrome	3	1

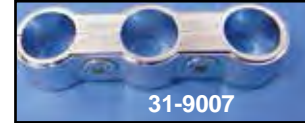

# Fitting

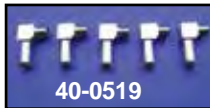

**Oil Line Fittings** for  $\frac{3}{8}$ " hose, chrome plated in five pack. Thread is  $\frac{1}{8}$ " NPT.

VT No.	OEM	Type	U/M
40-0566	63533-41	Straight, Replica	5
2070-1	63533-41	Straight, Replica	Each
40-0519	26496-75B	90° angle	5
40-0521	Barbed	Straight	5

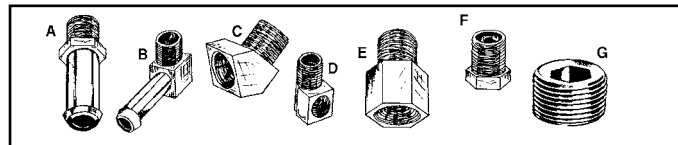

**Chrome Male Fittings** for gas and oil measured in NPT thread and inner diameter of line.

A-Straight	B-90°	Size
40-0525	40-0532	$\frac{1}{8}$ " NPT x $\frac{5}{16}$ " Hose
40-0526	40-0529	$\frac{1}{8}$ " NPT x $\frac{1}{4}$ " Hose
40-0566	40-0519	$\frac{1}{8}$ " NPT x $\frac{3}{8}$ " Hose
40-0608	—	$\frac{1}{4}$ " NPT x $\frac{1}{4}$ " Hose
40-0527	40-0530	$\frac{1}{4}$ " NPT x $\frac{5}{16}$ " Hose

**Chrome Male Female Fittings.**

VT No.	#	Type/Size
40-9990	C	45° $\frac{1}{8}$ " x $\frac{1}{8}$ " NPT, Street Elbow
12-1416	D	90° $\frac{1}{8}$ " x $\frac{1}{8}$ " NPT
12-1419	E	Straight $\frac{1}{8}$ " x $\frac{1}{8}$ " NPT

**Male Plugs.**

VT No.	#	Size
23-0611	F	$\frac{1}{8}$ " NPT, Chrome
23-0933	F	$\frac{1}{8}$ " NPT, Zinc
40-0531	F	$\frac{1}{4}$ " NPT, Chrome
37-8777	G	$\frac{1}{8}$ " NPT Hex Socket Plug, Plain

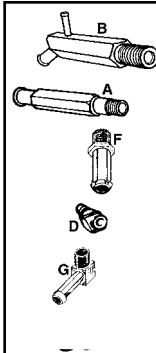

**Oil Fittings for Big Twin.**

VT No.	#	OEM	Item
40-0566	F	63533-41	Straight
12-1412	A	63533-65	Oiler Return
40-9982	B	63541-70	Oiler T, Rear Chain
40-0579	G	Chrome	Crankcase 90°
40-0549	G	16305-99	Elbow, 1999-up
40-0552	F	26314-99	Straight 1999-up
17-0519	G	62375-57	Elbow
40-0553	G	63554-90	Elbow



# Drain Plug



**Magnetic Drain Plugs** prevent metal particles from circulating through engine and transmission cases, oil tank, etc.

VT No.	OEM	Size	Use
37-0096	707	$\frac{1}{2}$ "- 13	74 Transmission
37-0097	700	$\frac{3}{8}$ "- 24	Big Twin Case Plug 74 and 80
37-0095	60348-65A	$\frac{1}{2}$ "- 20	74 and 80 Inner Primary
37-0098	720, 706A	$\frac{5}{8}$ "- 18	Oil Tank and Time Hole
37-8934	734-739	$\frac{1}{8}$ "- 27	NPT 1987-89 Big Twin Primary Transmission, FXST-FXR
37-0099	739A	$\frac{1}{8}$ "- 27	NPT 1990-03 Big Twin Primary
37-9242		$\frac{1}{8}$ "- 27	NPT 1990-up Big Twin Primary with Hex
37-8961	718	$\frac{1}{4}$ "- 18	NPT Chain Cover
37-9217	722	$\frac{5}{8}$ "- 18	FXR Drain

VT No.	OEM	Size	Use
40-0498	60328-98A		2001-up BT Oil Drain Plug
37-0005	60391-04		2007-up Primary Drain Plug 1999-06 FX-FXD 2004-06 FXD, FLT FLST Primary Drain Plug

**A-Drain Plug** fits oil tank drain with  $\frac{5}{8}$ "-18.

VT No.	Finish
8610-1	Chrome
8611-1	Cadmium
37-9067	Washer 6700B

**B-Chrome Plug** with gasket fits all 1981-up Big Twins with  $\frac{1}{2}$ "- 20 UNC thread.

8493-2	Plug with gasket
15-0685	Gasket only

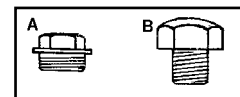



# Oil and Fuel Line



**Compression Fitting and Hose Kit** includes (6) reusable compression fittings with 1/8" NPT for oil pumps and tanks, and 10 feet of 3/8" stainless steel braided hose. Non-reinforced.  
**VT No. 40-0459**



**Fuel-Oil Line** in 25 feet shop rolls in black or clear for fuel use.

Black	Clear	Size
40-9999	—	1/8"
40-0117	40-1250	3/16"
40-0118	—	1/4"
40-0119	40-1252	5/16"
40-0254	—	5/16" (6 feet)
40-0120	—	3/8"
40-0253	—	3/8" (6 feet)
40-0126	—	1/2"



**Stainless Hose Clamps** are available in Worm Gear type.  
**VT No. Size Type**  
**35-0413** 7/32"-5/8" Fuel  
**35-8031** 3/8" Oil

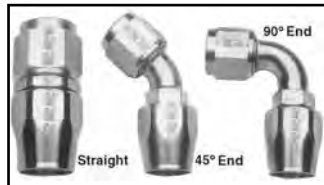

**Russell Endura Fittings** feature compression end and tapered internal nut. For 3/8" inner diameter braided oil hose.  
**VT No. Angle**  
**40-0537** Straight  
**40-0538** 45°  
**40-0539** 90°  
**40-0541** Adapter Fitting



**Stainless Oil Line Kit** includes 10 feet of braided hose with 3/8" inner diameter and six chrome econo-seal hose ends.  
**VT No. 40-0418**



**Chrome Econo-Seal Hose Ends** act as a clamp and finished end when the stainless jacket rubber hose is cut. Micro clamp is hidden under chrome end.

Smooth	Hex	Fits	Qty
40-0222	40-0213	1/4"	6
40-0248	—	5/16"	6
40-0223	40-0214	3/8"	6
40-0224	40-0218	1/4"	2
40-0249	—	5/16"	2
40-0225	40-0219	3/8"	2
—	40-0220	13/16" Inner Diameter	1
—	40-0591	15 mm	2
—	40-0592	17 mm	2

## Fitting



**Chrome Oil Line Fitting Set** allows use of 3/8" braided steel lines. The built in compression fitting alleviates the need for clamps. Reusable three piece set.

VT No.	Thread	Fits
40-0575	1/2" NPT	TC-88
40-0583	1/8" NPT	Early
40-0584	1/4" NPT	TC-88



**Braided Stainless Hose** in bulk lengths to be cut to length as needed. Use econo-seal ends or hose clamps to attach to fitting. **Warning:** Not for use in brake systems.

VT No.	Size	Length (Ft)	Type	Brand
40-0202	1/4" x 1/4"	10	Non-reinforced	VT
40-0200	5/16"	5	Non-reinforced	VT
40-0245	5/16"	25	Non-reinforced	VT
40-0276	5/16"	25	Reinforced	Sifton
40-0210	3/8"	10	Non reinforced	VT
40-0876	3/8"	10	Non-reinforced	VT
40-0244	3/8"	25	Reinforced	VT



**Russell Universal Pro System Oil Lines** feature a unique compression fit sealing system which ensures a positive seal on 3/8" barbed type oil pump or oil tank fittings. Constructed with stainless braided hose and crimped on chrome ends. Sold each.

VT No.	Length	40-5018	16"
40-5010	8"	40-5019	17"
40-5011	9"	40-5020	18"
40-5015	13"	40-5021	20"
40-5016	14"	40-5022	22"
40-5017	15"	40-5024	26"



**Oil Pump/Tank Fitting.**  
**VT No. 40-0566**



**Radii Polished Stainless Steel Hose Lock** is a compression fitting that replaces conventional hose clamps. It features a cleaner appearance and superior sealing performance.

Pair	Each	Size
35-0180	35-0175	1/4"
35-0181	—	5/16"
35-0183*	—	5/16"
35-0182	—	3/8"

\*Note: Fits S&S Super "E" carburetor fitting





# Oil Filter



40-0178 Kit



9821-4

**Chrome Oil Filter Housing** fits 1992-99 Big Twin models, when the filter bolts to right front side of engine.

VT No.	OEM	Item
40-0178	Kit	Chrome Housing with lines
40-9958	26415-98	Chrome Housing Only
40-9901	—	Housing Only Smooth Style
40-9831	33519-92A	Tube, Return
40-9832	33520-92	Tube, Feed
40-9942	Set	Above Tubes
40-9959	63523-92	Tube Connector
37-0825	10112	Tube Clamp
40-9957	Chrome Filter	1992-up FXDG
40-0709	Chrome Filter	1982-up FXST
9821-4	—	Mount Kit, allen
9822-4	—	Mount Kit, acorn
40-9834	63530-92	Nut



**Contour Oil Filter Bracket** is 1/2" thick with external fittings for 1992-99 Evolution engines. Includes filter.  
**VT No. 40-0653**



**Chrome Housing and Filter Kit** fits 1999-06 FLT and 1999-05 Dynaglide models. Replaces 26321-99A.

- | VT No.   | Item                  |
|----------|-----------------------|
| 40-0177  | Kit                   |
| 9938-6   | Acorn Mt Kit          |
| 9939-6   | Allen Mt Kit          |
| 9939-6-P | Polished Allen Mt Kit |

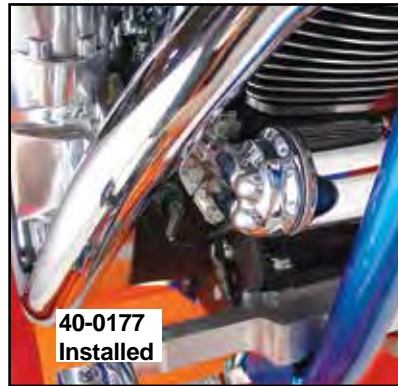

40-0177 Installed

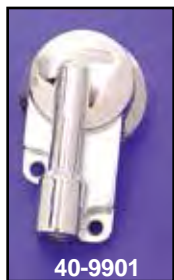

40-9901

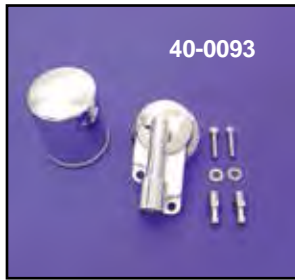

40-0093



40-0792

- | VT No.  | Item              |
|---------|-------------------|
| 40-9901 | Housing           |
| 40-0093 | Housing with hose |
| 40-0792 | Fittings          |



**V-Twin Customizer Dress Up Kit** includes chrome covers for oil filter housing, tappet blocks and oil pump on 1992-99 Big Twin 1340 models. **VT No. 42-0654**

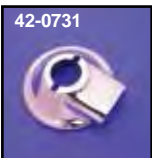

42-0731



42-0745

**FXST Chrome Oil Filter Housing Kit** fits with frame mount unit.

- | VT No.  | Fits    |
|---------|---------|
| 42-0731 | 1989-91 |
| 42-0745 | 1992-99 |



**Oil Filter Adapter** fits 1995-up.  
**VT No. 40-0942**



40-0177

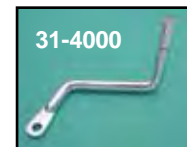

31-4000



40-0095

**Big Twin Chrome Oil Canister and Mount Brackets.** Oil lines must be fabricated and routed for installation. Fits 1984-99 FXST, FLST.

- | VT No.  | Item        |
|---------|-------------|
| 31-4000 | Bracket     |
| 40-0095 | Filter Unit |



40-0751

**5.5" Chrome OE Spin-On Oil Filter** features a cured black resin impregnated paper that will remove foreign particles from oil. Replaces 63813-90, fits 1991-98 FXD. **VT No. 40-0751**



40-0431

**Perf-form Spin-On Oil Filter Element** for custom application.  
**VT No. 40-0431**



40-5001

**Sifton Oil Filter Kit** includes canister housing, mount plate, seals, with wrench and cleanable element.

- | VT No.  | Item   |
|---------|--------|
| 40-5001 | Kit    |
| 40-5000 | Insert |



**Chrome Billet Oil Filter Bracket** fits 1992-99 Evolution models. VT No. 40-0594



**Billet Oil Filter Mount** fits 1992-99 Softail. VT No. 40-0607



**40-0315 Installed**



**40-0315**

Filter sold separately



**40-0316**



**Alloy Generator Oil-Filter Adapter** bolts in place of two brush generator or alternator Big Twin case conversions. Use 40-0709 filter.

**VT No. Item/Finish**  
**40-0315** Adapter, Alloy  
**40-0316** Adapter, Chrome  
**40-0709** Chrome Filter



**Billet Oil Drain Block** allows remote mounting. Includes drain plug. VT No. 40-0485

## Oil Filter Kit



**40-9911 Installed**



**Radii Contour Oil Filter Bracket** features a long design covers oil lines and connections. It fits 1992-99 Evolution models and S&S cases and engines with similar mount holes. Filter included. VT No. 40-9911



**40-0098**



**40-0952**

**Universal Oil Cooler-Filter Kit** includes chrome spin on filter, finned aluminum mount flange, with hose and clamps.

VT No.	Item	Finish
<b>40-0098</b>	Filter Kit	Alloy
<b>40-0952</b>	Filter Kit	Chrome
<b>40-0709</b>	Filter only	Chrome
<b>31-2131</b>	1" Frame Clamps	



**Pura-Flo Universal Clamp on Oil Filter Kit** includes filter and hose.

VT No.	Item
<b>40-0850</b>	Kit
<b>40-0709</b>	Filter

## Oil Line



**Custom Stainless Steel Oil Line Kit** fits TC-88 for custom applications. Includes three compression fittings and three seal ends. Hose must be cut for installation. VT No. 40-0467



**Flex Chrome Hose Covering** features heavy gauge mylar construction with chrome finish and 25 feet in length.

VT No.	Size
<b>36-0552</b>	1/4"
<b>36-0553</b>	3/8"
<b>36-0554</b>	1/2"



**Sifton 1992-99 Braided Oil Line Kit** fits Softail models and includes stainless lines, seals and hardware as shown. Replaces 63705-97. VT No. 40-0651





# Oil Filter

Motorshop™ Brand Filter Packs include 6 pc of individually wrapped and numbered chrome filters with 3" outside diameter and length as listed.

Chrome	Black	OEM	Type	Length
40-0198	40-0836	63782-80T	82-84 FL-FX	2.5"
40-0199	40-0838	63796-77T	84-99 Softail	3.75"
40-0233	40-0839	63798-99	TC-88	3.25"
40-0234	40-0840	63813-90	FXD	5.5"



Stock



Hex Nut



40-0855

## Spin-On Oil Filters

- Replaces stock units in chrome or black, Perf-form or V-Twin Brand in stock or with hex nut.
- Perf-form Tall Chrome Filter is 3/4" longer than stock and will not fit fuel injected models. All filters listed are low restriction type.

Perf-form	Hex	VT No.	OEM	Finish	Length	Fits
40-0378	40-0860	40-0708	63805-80T	Black	3.75"	1980-98 FLT, 1982-94 FXR, 1984-98 FXST
—	40-0872	40-0709	63796-77T	Chrome	3.75"	As Above
40-0603	—	—	—	Chrome	4.1"	As Above
40-0706	40-0863	40-9956	63812-90	Black	5.5"	1991-98 Dynaglide
40-0707	40-0862	40-9957	63813-90	Chrome	5.5"	1991-98 Dynaglide
40-0724	40-0855	40-0722	63798-99	Chrome	3.25"	1999-up TC-88
—	40-0854	40-0723	63731-99	Black	3.25"	1999-up TC-88
—	40-0867	40-0654	63793-01K	Black	3.38"	2002-up VRSC
—	40-0868	40-0655	63793-01K	Chrome	3.38"	2002-up VRSC



40-0722

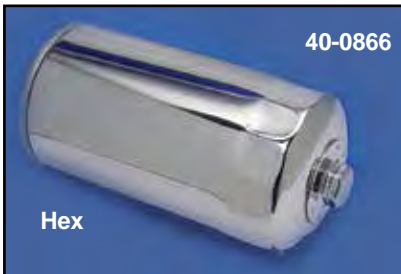

Hex

40-0866



Stock

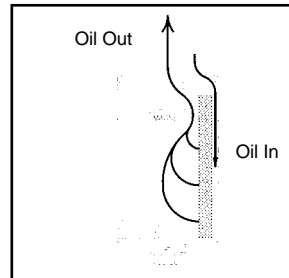

Oil flows in around the outer diameter, through the filter media and out passing by the magnet. The magnet captures particles less than 10 microns which could have escaped through the filter wall.

Magnetek™ Oil Filters feature a magnetic ring in center tower to trap particles less than 10 microns which could have escaped thru the filter wall. Available in stock style or with built in hex nut.

Hex	VT No.	OEM	Fits
40-0864	40-0852	63796-77	1980-up 5-Speed Softail-FLT
40-0866	40-0853	63813-90	1991-up Dynaglide
—	40-0656	63793-01	2002-up VRSC
40-0856	40-0657	63798-99	1999-up TC-88



**Chrome 5.5" Fram Oil Filters.**  
Fits 1991-98 Dynaglide  
VT No. 40-0727



40-1730



40-1732

Length
3.75"
5.5"
3.38"
3.25"

K&N Spin-On Oil Filters are available in chrome or black finish. Feature hex nut end for easy removal and installation, improved pressure relief valve, anti-drain back valve and heavy duty base plate with improved rolled seal.

Chrome	Black	Fits	Length
40-1710	40-1711	1980-98 FLT 1982-94 FXR, 1984-98 FXST	3.75"
40-1730	—	1996-98 Dyna	5.5"
40-1732	40-1733	1999-up All TC-88	3.25"

# Oil Filter Kit



40-0100  
Installed



40-0100

**FXST Style Oil Filter Kit** features bolt on mounting behind shift plate. Fits Big Twin frames with 1970-up Shovel or Evolution engines. Can be used as an easy access auxiliary unit in addition to filter in tank. Bracket is replica of 1984-99 FXST type replacing 63802-84. Oil spigots are copper and brazed in a vacuum for lasting durability. Includes chrome filter and 6 feet of rubber hose with clamps.

VT No.	Item
40-0100	Complete Kit
40-0709	Chrome filter
40-0708	Black filter



**Oil Change Service Kit** includes chrome filter and 4 bottles of superior Spectro Heavy Duty Lubricant.

VT No.	Fits
41-0050	1984-88 FXST, 1980-98 FLT, 1982-94 FXR, 1984-up XL
41-0051	1991-98 Dynaglide
41-0052	1999-up All TC-88 Big Twins



**Sifton Oil Pre-Filters** are constructed of machined alloy with a #40 mesh screen installed to trap large debris and a circular magnetic collar to collect the ultra fine ferrous particles before they reach the engine. Unit can be installed in the following locations for 3/8" inner diameter oil line:

- Supply line before the engine on all models
- Primary scavenger return line on Early FLH and FX models
- Return line to oil tank on FL-EL-UL and models without a factory filter
- External oil return on high performance heads.
- Any pressure supply or return (use the prefilter with the 1/8" NPT body).

The 1/2" unit recommended for Softail TC-88 models on the path between the cam bearing housing and oil pump.

VT No.	Type	Hose
40-0388	1/8" NPT Body	3/8"
40-0387	Barbed end	3/8"



**Oil Line Filter Kit** includes filter and compression fittings for 3/8" stainless steel hose.

VT No. 40-0462

# Oil Filter



40-1257 Installed



40-1257



40-0798

**Front Mount Filter Unit** incorporates filter and regulator mount for 1975-99 Big Twins and 1986-99 FXST-FLST models. Includes filter, chrome billet base and hose fittings.

VT No.	Item
40-1257	Complete Kit
40-0711	Chrome Filter
40-1270	Center Thread Fitting
40-0798	Base with Hardware As Pictured
40-0679	Base Only



**Oil Filter Nipple** with raw finish for 40-1257 fits 40-0711 filter.

VT No. 40-1270



40-0096

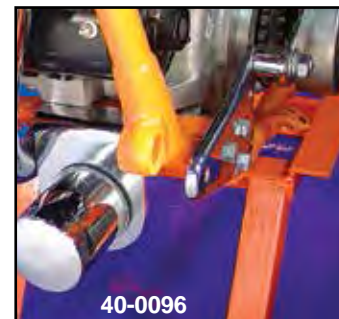

40-0096

**Pura-Flow Chrome Oil Filter Kit** for 1936-99 Big Twins.

VT No.	Fits
40-0096	Kit
40-0709	Replacement Filter



40-0091

Housing

**Oil Filter Kit** features 1992-up style location, to fit 1970-84 Big Twins nose cone engines when using an outside frame front pipe. Mounts under front engine mount.

VT No.	Item
40-0091	Chrome Housing and Bracket Kit
40-0093	Chrome Housing





# Oil Gauge

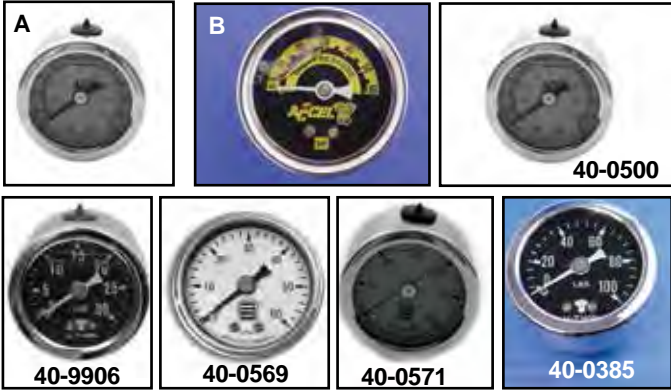

**Liquid Filled 1½" Oil Pressure Gauges** feature a weather resistant sealed lens, stainless steel case, chrome rim and extra heavy mechanism. The liquid filled face eliminates needle bounce giving a constant reading. All gauges have ½" NPT male rear fitting.

VT No.	#	Pounds	Face	Brand
40-9906		0-30	Black	V-Twin
40-0500	A	0-60	White	AEE
40-0569		0-60	Silver	Sifton
40-0571		0-60	Blue	Sifton
40-0382	B	0-60	Black	Accel
40-0386		0-60	Black	V-Twin
40-9907	B	0-100	Black	Accel
40-0385		0-100	Black	V-Twin

**Sifton Big Twin Oil Pressure Gauge Kit** for 1984-99 Evolution models includes a 1½" liquid filled 0-60 lbs gauge and chrome fitting. Kit is available with or without oil pressure switch sender provision.

VT No.	Type
40-0585	With oil pressure switch fitting hole
40-0586	Without oil pressure switch fitting hole



**Chrome Oil Gauge Cover** is machined of alloy, with square hole in bottom.  
VT No. 40-0448

# Adapter



**Adapter Kit** includes fittings for both feed and return lines. Fits special application.  
VT No. 40-0540



**Chrome Oil Filter Adapter** fits 1999-up FXD, FXST, FLT, FLST.  
VT No. 40-4602



40-0315 Installed

**Oil Filter Adapter** installed in the generator position.  
VT No. 40-0315

**Sifton Oil Filter Adapters.**  
VT No. Fits  
40-0709 Chrome Filter  
15-1520 Rubber Seal Set  
15-1521 Gasket (40-4600)

# Oil Filter Wrenches



**Oil Filter Wrench** with ¾" drive fits all spin-on filters ¾" drive. Fits all models including TC-88.  
VT No. 16-0743



**Combination Oil Filter Wrench** includes drain plug hex at opposite end.  
VT No. 16-0451



**Swivel-Flex Oil Filter Wrenches** feature gripper teeth and a durable treated band with a vinyl covered flex handle which swivels to clear frame and exhaust obstructions. Replaces 96221-80.  
VT No. 16-0903



**Filter Wrench.**  
VT No. 16-1941



# Oil Gauge Kit

BIG TWIN

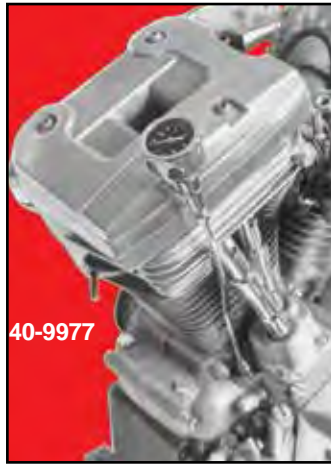

40-9977



40-0791 Installed



40-4004



40-0791

**Rocker Box Mounted Oil Gauge** fits 1984-99 1340 Evolution Big Twin models. Kit includes a complete liquid filled gauge, chrome steel line and hardware for installation. The kit is also available with lower fitting allowing stock oil pressure sender unit to be retained in conjunction with oil pressure gauge.

VT No.	Item
40-0791	Mini Kit
40-9977	Complete Kit
40-9985	Line and Bracket Kit
40-4004	Complete Kit with Sender Adapter



37-8963



37-8964



37-9008

**Chrome Oil Gauge Fitting** allows use of oil gauge or combining of a gauge and stock light switch unit.

VT No.	Item
37-8963	Oil Gauge Fitting
37-8964	Gauge Switch Fitting Chrome
37-9008	Gauge Switch Fitting Polished



**TC-88 Oil Pressure Gauge Kit** features oil filled gauge, chrome mounting bracket and all necessary mounting hardware. Fits all 1999-05 Dynaglide and 2000-up Softail models. Replaces 75133-99.

VT No. 40-0558



39-0785



39-0786



39-0788

**Chrome Billet Handlebar Assemblies** fit 7/8" or 1" handlebars.

VT No.	Item
39-0785	Clock, 7/8" or 1"
39-0786	Outside Temperature Gauge, 1"
39-0788	Clock with glow in dark hands, 7/8" or 1"
53-0871	Replacement Battery



40-9970



40-9971



40-9905

**Sifton™ Rocker Box Oil Pressure Gauge Kits** feature a 0-60 lb liquid filled pressure gauge and a case fitting which allows retention of oil pressure switch for indicator lamp. Chrome bracket, screw to mount to head and stainless steel line included.

VT No.	Fits
40-9970	1984-99 Evolution
40-9971	2000-08 TC-88
40-9905	Bracket



40-0879



40-0589

**Mini Oil Gauge Kit** for 1984-99 Evolution Big Twin. Includes a 1" mini gauge and chrome fitting.

VT No.	Year	Type
40-0879	1984-99	Evolution
40-0589	1/8" NPT	Gauge Only

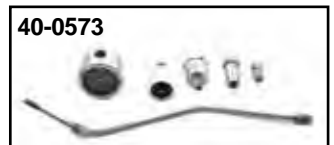

40-0573



40-0576 Shown

**Rocker Box Mounted Oil Gauge Kit** fits 1984-99 1340 Evolution Big Twin models. Kit includes a complete liquid filled gauge, chrome steel line and hardware for installation. Kit is available with lower fitting allowing stock oil pressure sender unit to be retained in conjunction with oil pressure gauge.

VT No.	Fitting Type
40-0573	Without Oil Pressure Sender
40-0576	With Oil Pressure Sender
32-0429	Sender Only





# Oil Cooler

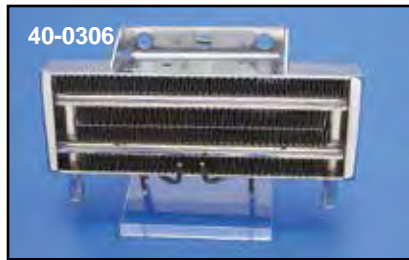

40-0306 Installed

Sifton Oil Cooler replica style in black or chrome. Order bracket separately.

VT No.	Finish
40-0305	Black
40-0306	Chrome



Brackets fit Sifton and Lockhart oil coolers.

VT No.	Year	Model
31-0154	1960-84	FX-FL
31-0420	1986-99	FXST
31-3976	1982-94	FXR
31-1253	1997-08	FLT



Jagg Low Mount Assisted Oil Cooler Kits feature a 10 row oil cooler with sealed motor fan. Fan turns on automatically at 205°F and pulls a full 150 cfm of air across cooler. Kit includes cooler, fan, oil hose, mounting hardware, automatic thermal fan switch and wiring harness.

VT No.	Fits
40-1528*	2006-08 FLHT, FLHX, FLHR, FLTR
40-4602	Offset Filter Adapter

\*Note: VT No. 40-4602 Required for Installation

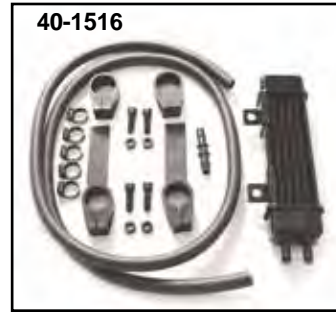

Sifton Slim Line Oil Cooler. *Note: Deluxe Style			
Chrome	Black	Fits	Type
40-1518	40-1516	1982-84 FXR 1991-up FXD, 1984-13 FLT 1984-up Softail	Vertical
—	40-1523	1955-83 Big Twin	Horizontal
40-1524	—	1982-94 FXR, 1984-up FXST, 1984-2013 FLT	
40-1525*	—	1955-83 Big Twin 1984-99 Softail	Vertical



# Sifon Dual-Cool Kit

BIG TWIN



**Jagg Oil Coolers** feature multipass oil flow configuration, specially designed turbulators in each oil passage way, highly concentrated mini-louvered air fins and are available in deluxe, black on chrome. Order adapters for TC-88 models separately.

### Vertical Mount

Deluxe	Slim Line	Chrome	Fits
40-1510	40-1500	—	1982-94 FXR, 1984-up FXST 1991-up FXD includes adapter

### Horizontal Mount

Black	Chrome	Fits
40-2530	40-1520	1984-up FLT, 1982-94 FXR
40-1501	—	As Above Includes Adapter 2000-up FXST without ABS Includes Adapter



**Chrome Billet V-Cooler** will mount to front frame tubes as shown. Unit is 4 1/8" wide at the top. Each tube 10.5" long and 1 1/8" in diameter.

**VT No. 40-0340**



**Billet Clamp Sets** will mount 1 1/8" diameter oil coolers to frames.

**VT No. Frame Size**

40-0341	1 1/4"
40-0342	1 1/8"
40-0590	1"



**Combo Oil Cooler** includes a 0-60lb built in gauge. Chrome unit features two billet clamps to fit 1" through 1.25" frame tubes.

### VT No. Item

40-0880	Combo Kit
40-0504	Adapter Fitting for Stainless Hose



**Sifon Oil Cooler Kit** includes billet dual tube vertical oil cooler with billet mount clamps. It measures 10" long and 4 1/8" wide at the top. Also included are stainless steel braided lines with four chrome seal ends. VT No. 40-0347 does not include or require an adapter.

VT No.	Model
40-0343	2000-up FXST
40-0344	2000-06 FXD
40-0347	1970-84 FX-FLH
40-0348	1986-99 FXST
40-0471	1998-up FLT
40-0211	Hose (pair)



**Billet Twin Cooler Set** features two independent 1 1/8" diameter cooler canisters with four billet clamps for mounting to 1" front frame tubes.

**VT No. 40-0349**



**Billet Twin-Cooler Set** feature two independent 1 1/8" diameter cooler canisters.

VT No.	Length	Finish
40-0339	9"	Chrome
40-0805	7"	Black





# Outer Primary Cover

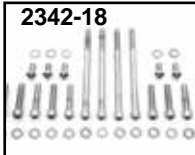
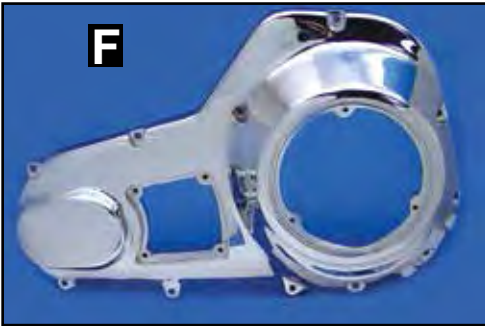

Die Cast Primary Covers are manufactured from a casting process. It is the nature of parts produced from this process to have small random subsurface imperfections that can be uncovered during the polishing process. These may appear as very small cosmetic imperfections after chrome plating. We also do not polish in areas that are not readily visible once assembled on the motorcycle or by polishing machines such as small depressions or tight corners. As these conditions are common in polished and chrome-plated castings, a reasonable standard of acceptability has been established to bring you the highest quality product at an affordable price. This part meets Perma Chrome™ cosmetic standard. The aforementioned cosmetic conditions are considered reasonable for this part and are not considered warrantable.

**Chrome Big Twin Outer Primary Covers** are from new die cast tooling to replace stock parts. Kits include chrome primary cover, chrome allen screws, outer cover starter bearing and gaskets for derby, inspection and outer covers. All other covers are sold as cover only. Part number for screw kit given for reference only.

#	VT No.	OEM	Fits/Type	Chrome Allen Screw Kit	Chrome Allen Screw Kit
<b>5 Speed FXR-FLT</b>					
F	43-0209	60665-85B	1985-88 FXR	8916-17	8916-17T
	43-0340	Kit	1985-88 FXR		
G	43-0232	60665-89	1989-93 FXR	8916-17	8916-17T
	43-0341	Kit	1989-93 FXR		
H	43-0222	OE	1994 FXR, 1994-98 FLT	8916-17	8916-17T
	43-0560	60665-94	1994 FXR, 1994-98 FLT	8916-17	8916-17T
	43-0342	Kit	1994 FXR, 1994-98 FLT		
I	43-0248	60665-99	1999-06 FLT, Replica	9959-38	9959-38T
	43-0276	60665-99	1999-06 FLT (V-Twin)	9959-38	9959-38T
	43-0241	OE	1999-06 FLT	9959-38	9959-38T
	43-0249	Kit	1999-06 FLT		
	43-0782	VT	2007-up FLT	2402-18	2402-18T
	43-0883	ET	2007-up FLT	2402-18	2402-18T
	43-0374	Black	2007-up FLT, Black		
<b>5-Speed FXST-FLST-FXD</b>					
J	43-0199	60543-86A	1986-88 FXST-FLST	8916-17	8916-17T
	43-0343	Kit	1986-88 FXST-FLST		
K	43-0198	60543-89	1989-93 FXST-FLST-FXD	8919-19	8919-19T
	43-0344	Kit	1989-93 FXST-FLST-FXD		
	43-0224		1994 FXST-FLST-FXD	8919-19	8919-19T
M	43-0345	Kit	1994 FXST-FLST-FXD		
	43-0211	60543-95	1995-98 FXST-FLST-FXD V-Twin	8919-19	8919-19T
	43-0370	Black	1995-98 FXST, Black		
	43-0346	Kit	1995-98 FXST-FLST-FXD		
N	43-0239	OE	1999-06 FXST-FLST-FXD	8919-19	8919-19T
P	43-0240	60543-99	1999-06 FXST-FLST-FXD V-Twin	8919-19	8919-19T
	43-0280	60543-99	1999-06 FXST-FLST-FXD	8919-19	8919-19T
	43-0347	Kit	1999-06 FXST-FLST, 99-05 FXD-FXWG		
	43-0359	60764-06	2006-up FXD	2342-18	2342-18T
	43-0360	60782-06	2006-up FXDWG, 2007-up FXST	2342-18	2342-18T
	43-0882	ET	2006-up FXD, 2007-up FXST		
	43-0369	Black	2007-up FXST, Black		
	43-0373	Black	2007-up FXD, Black		



# Outer Primary

BIG TWIN



**Note:**  
**Big Twin Outer Primary Covers** are from new die cast tooling to replace stock parts. Kits include chrome primary cover, chrome allen screws, outer cover starter bearing and gas-kets for derby, inspection and outer covers. All other covers are sold as cover only.

Die Cast Primary Covers are manufactured from a casting process. It is the nature of parts produced from this process to have small random subsurface imperfections that can be uncovered during the polishing process. These may appear as very small cosmetic imperfections after chrome plating. We also do not polish in areas that are not readily visible once assembled on the motorcycle or by polishing machines such as small depressions or tight corners. As these conditions are common in polished and chrome-plated castings, a reasonable standard of acceptability has been established to bring you the highest quality product at an affordable price. This part meets Perma Chrome™ cosmetic standard. The aforementioned cosmetic conditions are considered reasonable for this part and are not considered warrantable.





# Primary Cover Kit



**Chrome Primary Cover Sets** are for Softtail models. Set includes die cast and chrome inner and outer primary cover.

VT No.	Fits	Hardware
43-0250	1990-93	15-0782
43-0251	1994-99	15-0779



VT No.	VT No.	Year	Model
With Derby	Without Derby		
43-0264	43-0347	1995-06	Softtail
		1994-05	FXD-FXDWG
43-0288		2006-up	FXD
43-0289		2006-up	FXDWG
		2007-up	FXST
43-0265	43-0249	1994-06	FLT
43-0294		2007-up	FLT
43-0267	43-0341	1989-93	FLT-FXR
43-0272	43-0340	1985-88	FLT-FXR
42-0740		Inspection	FLT
42-9943		Inspection	FXR

# Outer Vented Primary Kit

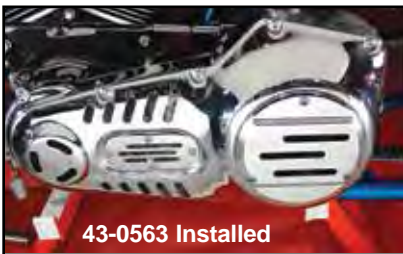

**Vented Primary Cover Kits** include vented inspection and derby covers with screws for Softtail models.

VT No.	Year
43-0562	1989-93
43-0563	1994-05 Dynaglide 1994-06 FXST



**Chrome Vented Primary Covers** fit Softtail and FXD models. All parts sold separately.

VT No.	Year
43-0110	1994-06
43-0113	1989-93
43-0126	Derby
43-0179	Oval

**Chrome Vented Outer Primary Covers** are without bearing installed.

VT No.	Year	Model
43-0252	1989-93	FXST
43-0257	1994-06	FXST-FXD
43-0290	1995-06	FXST (3 Hole)



# Chrome Inner Primary

BIG TWIN

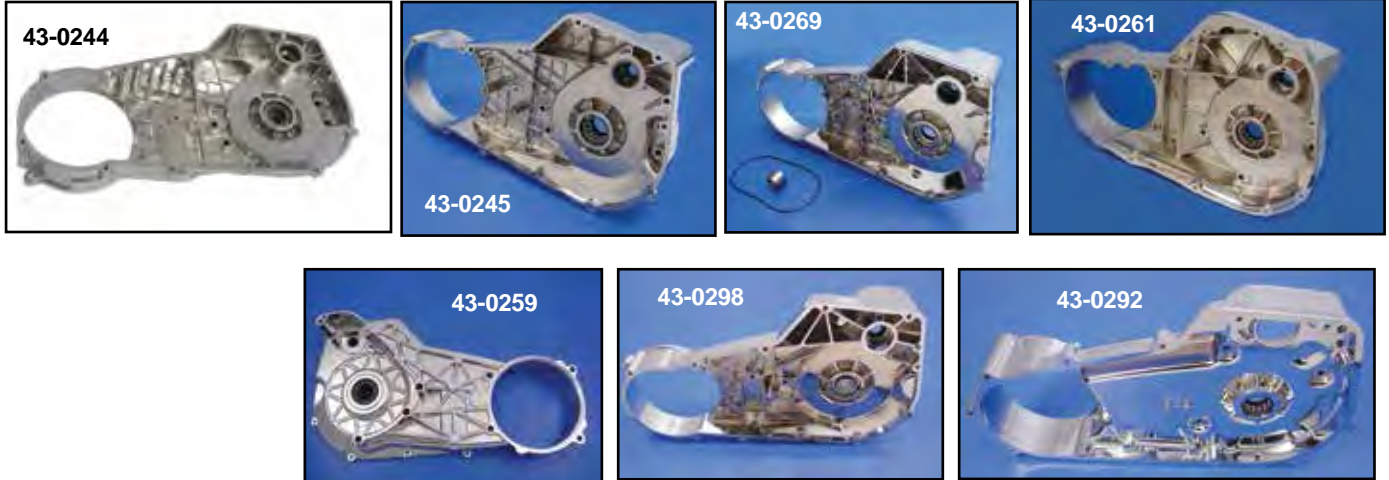

**Chrome Inner Primary Cover Assemblies** include bearings, bushings and seals. Installed.

VT No.	Year/Model		
43-0244	1990-93 FXST-FLST	43-0259	2001-2005 FXDWG (OE)
43-0245	1994-2006 FXST-FLST	43-0298	2001-2005 FXDWG
43-0268	1994-2000 FXDWG	43-0292	2008-up FXCW (OE)
43-0269	1994-2000 FXD		

## For FXD-FXDWG

Does not include bearings, bushings or seals.

### FXD 5-Speed

- 43-0279 1994-00 FXDWG
- 43-0286 1994-00 FXD

### FXD 5-Speed

- 43-0258 2001-05 FXD
- 43-1050 2001-05 FXD
- 43-1055 2001-05 FXDWG
- 43-0690 Bushing



## Offset Inner Primary Cover

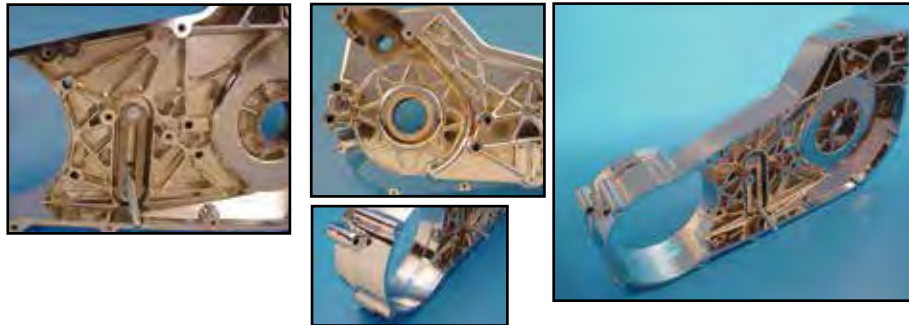

**V-Twin™ Offset Inner Primary Covers** for 1994-2003 Softtail feature chrome finish with reinforcing webs for added strength. Available in offsets for fat tire and wide frame applications. Uses 1994-2003 primary component, sold separately.

VT No.	Offset
43-0452	.500"
43-0453	.750"
43-0454	1.00"
43-0455	1.25"

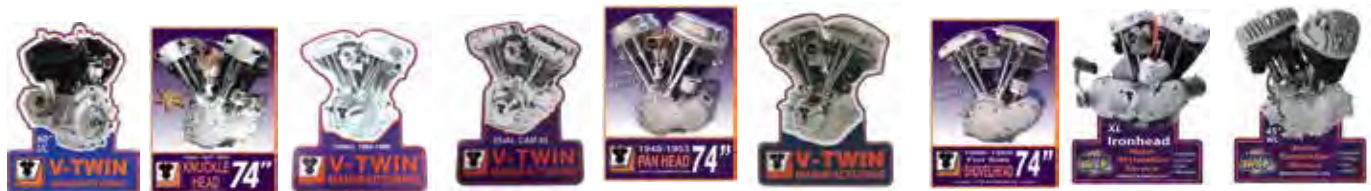

- 48-0498 80" UL
- 48-0470 Knucklehead
- 48-0030 1340 cc
- 48-0033 Dual Cam
- 48-0025 Panhead
- 48-0044 Shovelhead
- 48-0048 Shovelhead
- 48-0372 XLCH 1971
- 48-1824 45"

**Motor Plaques** measure 18" x 24" and are made of metal.  
**Motor Plaque Set** includes 9 plaques. VT No. 48-1811





# Inner Primary Trim

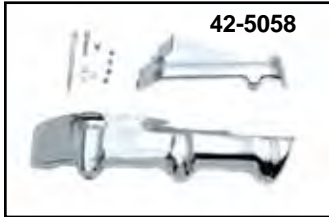
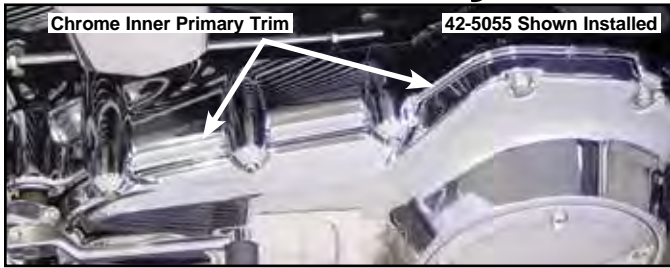

**Chrome Inner Primary Trim** easily adapts to stock cast inner primary without complicated disassembly.

VT No.	Year	Model
42-5058	2006-up	FXDWG
42-5057	2007-up	Softail
42-0729	1986-88	FXST-FLST

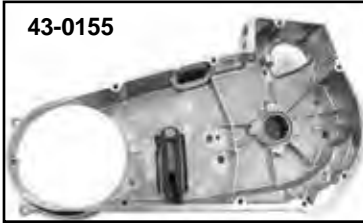

**Inner Primary Cover** with chain drive. Fits 1984-85.  
VT No. 43-0155



**Chrome Inner Primary Cover** fits 1994-2000 FXDWG.  
VT No. 43-0279

# Inner Primary

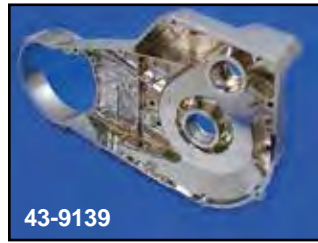

**Cast Inner Primary Covers** available in chrome, cast, polished or OE black finish.

VT No.	OEM	Finish	Fits
<b>FXR 5-Speed</b>			
43-0233	60222-90	Cast	1990-93 FXR
<b>FXST-FLST 5-Speed</b>			
43-9139	60630-90	Chrome	1990-93 FXST
43-9143	60630-90	Polished	1990-93 FXST
43-0162	As Above	Chrome	1990-93 FXST Heavy Duty
43-0174	As Above	Polished	As Above Heavy Duty
43-9145	As Above	Chrome	1994-99 FXST
43-0229	As Above	Polished	1994-99 FXST
43-0175	As Above	Chrome	1994-06 FXST Heavy Duty
			1994-06 FLST
43-0176	As Above	Polished	As Above Heavy Duty



**FLST-FXST Heavy Duty Inner Primary Cover** features waffle reinforced design.

VT No.	Finish	Year
43-0162	Chrome	1990-93
43-0174	Polish	1990-93
43-0175	Chrome	1994-06
43-0205	Chrome	1994-06
43-9179	Chrome	1994-06
43-0176	Polish	1994-06

**Note:** 43-0205 include all hardware except bearing.



# Primary Derby Cover

BIG TWIN

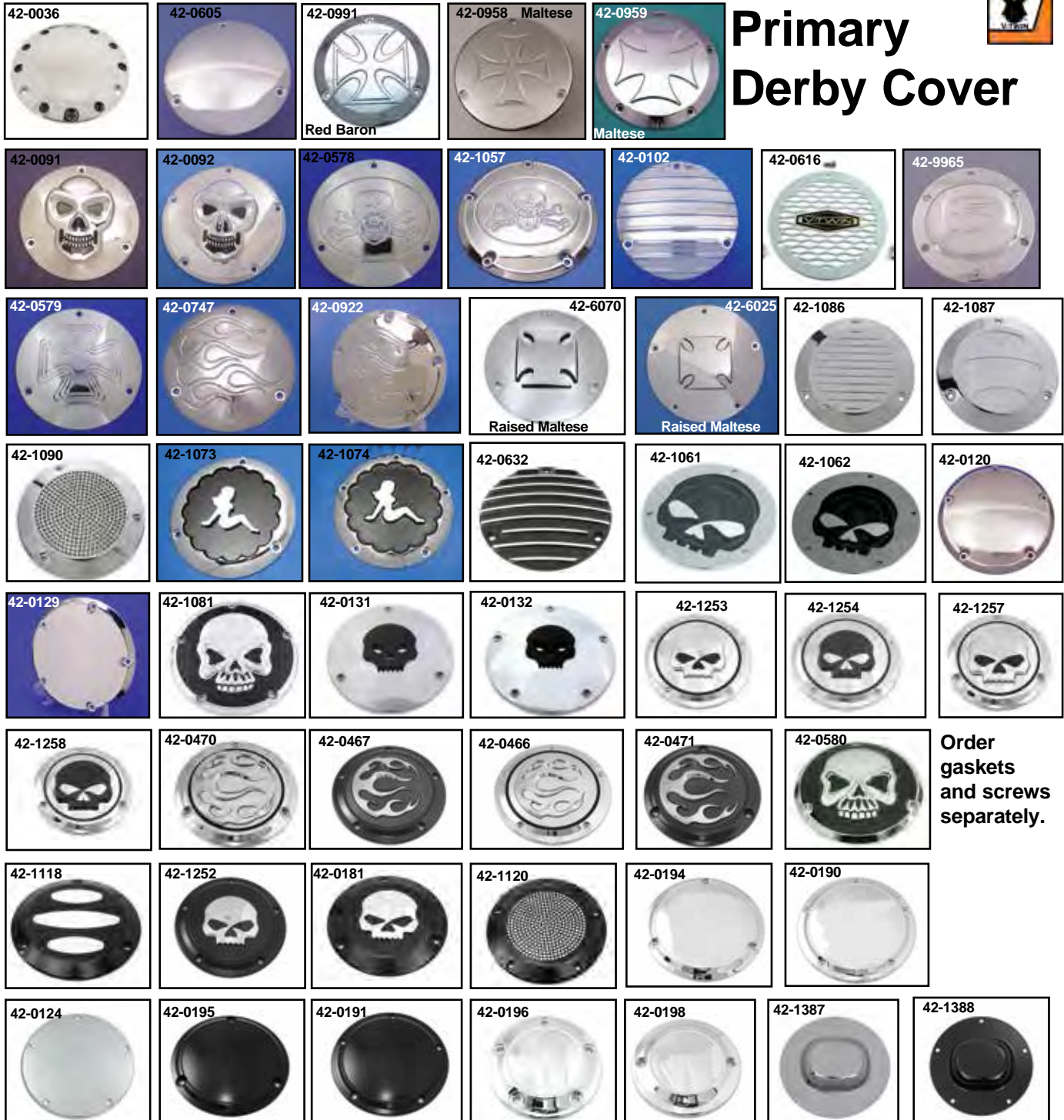

Order gaskets and screws separately.

3-Hole	5-Hole	Style	Finish	—	42-0124	Smooth	Chrome	42-0108	—	3-D Spinner	Chrome
42-0036	—	V-Tech	Chrome	42-0131	42-0132	Raised Skull	Black	42-1118	—	Contour	Black
42-0605	—	Dome	Chrome	42-0580	42-1081	Skull	Black	42-1140	42-0120	Smooth	Chrome
—	42-0990	Red Baron	Chrome	42-1086	42-1088	Ball Milled	Chrome	42-0102	—	Finned	Polished
42-0991	42-0975	Iron Cross	Chrome	42-1150	—	Ball Milled	Black	42-0091	—	Skull	Chrome
42-0958	42-0959	Maltese	Chrome	42-1087	42-1091	Contour	Black	42-1075	—	Flame	Chrome
42-0579	42-6026	Iron Cross	Chrome	42-1090	42-1089	Perforated	Chrome	42-1265	—	Skull	Black
42-0091	42-0092	Skull	Chrome	42-0470	42-0466	Flame	Chrome	—	42-1269	Skull	Black
42-0558	42-0559	Skull	Black	42-0471	42-0467	Flame	Black	—	42-1140	Ball Milled	Black
42-0578	42-1057	Bonehead	Chrome	—	42-0222	Raised Skull	Chrome	—	42-1144	Grooved	Chrome
42-0107	42-0950	Eagle Spirit	Chrome	—	42-1543	Contrast	Black	—	42-1145	Grooved	Black
42-9944	42-0849	Eagle Spirit	Gold Inlay	42-1118	—	Contour	Black	42-1142	—	Grooved	Chrome
42-0102	—	Finned	Polished	—	42-1120	Perforated	Black	42-1379	42-1392	Air Flow	Chrome
42-0616	—	Ventilated	Chrome	42-0194	42-0190	Smooth	Chrome	42-1380	42-1373	Air Flow	Black
42-9965	—	Retro Bird Logo	Chrome	42-0191	42-0191	Smooth	Black	42-1029	—	Smooth Dome	Chrome
42-6070	42-6025	Maltese Raised	Chrome	42-0181	42-1252	Chrome Skull	Black	—	42-1387	Nostalgic	Chrome
42-0747	42-0922	Flame	Chrome	42-1257	42-1253	Chrome Skull	Chrome	—	42-1388	Nostalgic	Black
42-1073	42-1074	Lady Luck	Chrome	42-1258	42-1254	Black Skull	Chrome	15-0125	14-0809	Gasket	Chrome
42-0632	—	Finned	Black	42-1257	42-1253	Chrome Skull	Chrome	—	37-0831	Screws	Chrome
42-1061	42-1062	Mesh Skull	Chrome	42-1258	42-1254	Black Skull	Chrome	37-8868	—	Nylon Washer	Black
—	42-0120	Smooth	Chrome	42-7100	—	Domed Skull	Black				
—	42-0129	Smooth	Chrome	42-7101	—	Domed Skull	Chrome				





# Inspection



Chrome 5-Speed Inspection Covers are available with or without shifter hole.

Without Shift Hole	Years	Model
42-0740	1985-up, 1985-94	FLT, FXR
42-0944	Flame	FLT, FXR
With Shift Hole		
42-9943	1985-94	FXR
42-0049	1985-94	FXR
10-2488	1985-94	Bushing

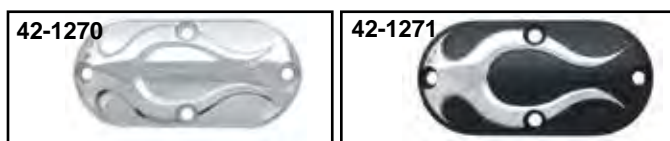
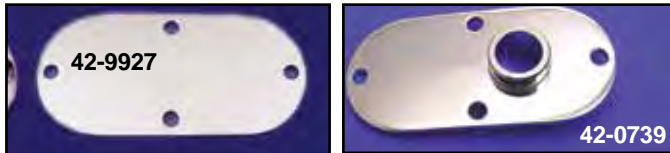

Inspection Ovals for alloy primary covers.

Chrome	Black	Type
42-9927	—	1986-06 FXST, 1993-05 FXDWG, Smooth
42-0739	—	1990-05 FXD
42-0610	—	1986-06 Softtail, Smooth
42-0826	—	1986-06 Softtail, Flywheel
42-1008	—	1970-86 Softtail, Bonehead
42-1263	42-1267	1984-06 FX-FL-FXST-FLST, Chrome Skull
—	42-1264	1984-06 -FL-FXST-FLST, Black Skull
—	42-1274	1991-2005 FXDWG
42-0476	42-0477	1999-up FL, 1999-up FX
42-0188	42-0187	1999-up FL, FX
42-1270	42-1271	1984-2006 FXST, FLST, FXD



V-Tech Covers feature allen screw styling in deluxe chrome die cast metal.

VT No.	Item
42-0002	Oval
42-0040	Oval with FXE shift hole



Eagle Spirit Derby have matching pieces available separately. The derby fits Big Twins. Finishes are chrome or chrome with gold inlay.

3-Hole	5-Hole	Years	Finish
42-0107	42-0950	1970-98	Chrome
42-9944	42-0849	1970-98	Chrome with gold inlay



Chrome Flame Derby and Inspection Oval Set. Screws included.

VT No.	Year	Model
42-0817	1965-98	FL and Softail
42-0816	1999-up	Softail
	1999-05	FXD



Chrome Flame Cover Set fits 1986-99 Softail. The set contains three pieces. VT No. 42-0743

## Vented Covered Sets

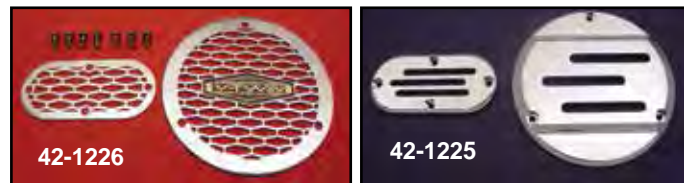

Chrome Oval and Derby Kit

VT No.	Item
42-1226	V-Twin Vented
42-1225	Billet Vented



Primary Derby Gasket Kit used to replace gaskets and seals after clutch and primary chain adjustment on Big Twins.

VT No.	Derby	Year	Holes
15-1507	15-0562	1999-up	5-Hole
15-1506	15-0563	1970-98	3-Hole



Chrome 3-D Derby Cover features concealed mounting by use of plate which installs like a derby cover. The 3-D spinner cover mounts to stud on plate and held firmly in place by O-ring. The red backing plate can be painted to match color scheme. VT No. 42-0108



**James Primary Kits** include beaded outer gasket.

Paper	Foamet®	Fits
15-0865	—	1984-88 FXST No Seals
15-0866	15-1335	1984-88 FXST, FLST
15-0869	—	1980-84 FXR-FLT (.062" Thickness)
15-0870	—	1985-93 FXR-FLT (.062" Thickness)
15-0868	15-1332	1989-93 FXST, FLST, 1991-93 FXD
15-0875	15-1331	1994-06 FXR-FLT
15-0876	15-1333	1994-06 FXST, FLST 1994-05 FXD
—	15-1430	2007-up FLT
15-0876	—	1994-06 FXST-FLST-FXD
15-1264	—	2006-up FXD
15-1264	—	2007-up FXST, FLST
—	15-1426	As Above With Silicone Beading
—	15-1334	2006-up FLT

**Oil Change O-Ring Kit** includes primary cover and drain plug O-rings for 2006-up models.  
VT No. 15-1511



**GB Big Twin Primary O-Rings. Inner Case to Engine**

VT No.	OEM	Year
14-0531	11147	1983-99

**Derby Cover to Outer Primary**

VT No.	OEM	Year
14-0535	25416-84	1985-98
14-0809	25416-99	1999-up
15-1511	17369-06	2006-up FXD
15-1286	25416-99	1999-up Beaded
15-1277	5 Holes	Molded Rubber



**GB™ Inner Primary Repair Gasket Kit** includes gasket to replace O-ring seal when the lip of the engine is partially or entirely broken off. To avoid machining and welding, grind the partially broken lip smooth and install the gasket. Special lock and bolts included. VT 15-1525 is a metal gasket only.

VT No.	Years	Models
15-0223	1970-90	FX-FL
15-0381	1990-05	FX-FL
15-1525	2006-up	FXD-FLT
	2007-up	FLST-FXST

**James Inner Primary O-Ring Saver Kit** replaces stock type O-ring with a gasket. Used for repairing damaged crankcase O-sealing lip. Available with a silicone beaded metal gasket or a foam rubber coated gasket. Includes lock tab.

**1984-up Evolution and Twin Cams**

VT No.	Item
15-1282	Metal Beaded
15-1283	Metal Foam Rubber

**Primary Bolt Sealing Washers**

VT No.	OEM	Type
37-8868	31433-84A	Nylon washer
37-8931	31433-84A	Washer with O-ring

# Primary Gasket Kit

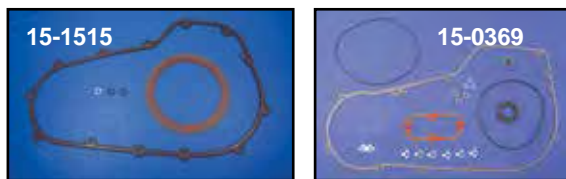
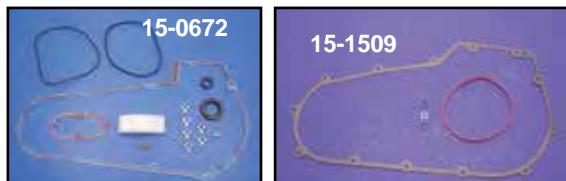
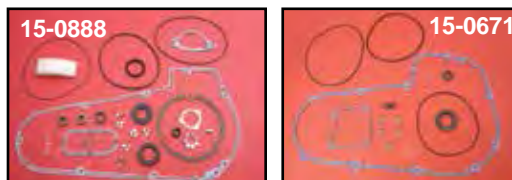

**GB Primary Cover Gasket Kit** contains all the necessary gaskets and hardware when making inner primary repairs, primary chain, clutch hub, clutch or left side transmission repairs. One part number covers all necessary parts.

GB No.	Year	Spd	Model
15-0888	1984-88	4-5	FXST
15-0671	1985-93	5	FLT-FXR
15-0672	1986-89	5	FXST
15-0673	1990-93	5	FXST (10 pieces)
15-0768	1990-93		FXST (15 pieces)
15-0368	1994-00	5	FXR-FLT
15-1513	2007-up	6	FLT
15-1515	2007-up	6	FLT As Above, Outer Gasket Kit Only
15-0369	1994-00	5	Softail
	1994-00	5	FXD
15-1509	2006-up	6	FXD
	2007-up	6	Softail

**Primary Derby Gasket Kit** used to replace gaskets and seals after clutch and primary chain adjustment on Big Twins.

VT No.	Year	Derby
15-1507	1999-up	5-Hole
15-1506	1970-98	3-Hole

## Screw



**Chrome Screw Kits** for Big Twin primary covers.

Acorn	Cap	Allen	Fits
7350-15	—	8762-17	1984-85 FXST 5-Speed
—	—	8762-17T	1984-85 FXST 5-Speed
8914-17	8915-17	8916-17	1985-99 All 5-Speed FXR-FLT
8917-19	8918-19	8919-19	1989-06 FXST, 1991-05 Dynaglide
—	—	2342-18	2006-up FXD, 2007-up Softail
—	—	8919-19P	As Above Polished
9958-19	—	9959-38	1999-06 FLT
—	—	2402-18	2007-up FLT





# Primary Hardware



**Aluminum Inner Primary Mounting Kits** contain all stock type hardware for mounting aluminum inner chain housing on all Big Twin.

VT No.	Years/Models
37-8668	1985-88 FXST
9904-17	1986-up FXR-FLT
37-9120	1989-up FXST
9870-16	1986-93 Softail and Dynaglide, Colony
9873-16	1994-up As Above
17-0946	1987-90 Lock Tab Only
37-8803	1971-up Bolt with Wire Hole
17-0928	1985-up Big Twin, Lock Tab



**Shift Shaft Primary Plug** for use when forward controls are installed on FXR-FXD models to seal the inner primary when eliminating the mid shift. Includes O-Rings and hardware.

VT No. 17-0650

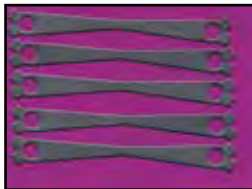

**1970-up Big Twin Inner Primary Lock Tab.** One piece design eliminates need for safety wire. Sold as a 5 pack.

VT No. 17-0937



17-0870



17-0871



12-0589



12-0591



17-0870

**Inner Primary Bearing Kit** for Late 1985-up Big Twins includes bearing, seal, two snap rings and one inner race.

1985-93	1994-05	2006-07	2008-up
12-0589	12-0591	17-0871	17-0873
17-0870	1985-05	Bearing/Sleeve	



12-0318

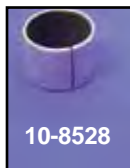

10-8528

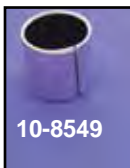

10-8549



10-2488

**Outer Primary Cover Bushing/Bearing** presses in outer primary cover to secure end of starter shaft.

VT No.	OEM	Years	Type
12-0318	9063	1965-88	Needle Bearing
10-8528	33446-89	1989-93	Bushing
10-8549	33446-94	1994-up	Bushing
10-2488	34632-84B	1984-94	Bushing (FXR)



15-0781

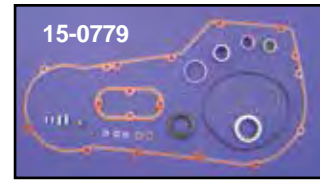

15-0779



15-0782

**1994-up Inner Primary Hardware and Gasket Set** for Softail models. Set includes all parts shown including bearing and inner sleeve.

VT No.	Year
15-0781	1986-89
15-0782	1990-93

VT No. Year

15-0779 1994-06

15-0784 2007-up



12-9935



12-0357



17-9941

**Late 1984-up Big Twin Inner Primary Bearing** supports transmission mainshaft at inner primary area. Available in OEM floating style roller bearing **Type (B)** which requires purchase of the inner sleeve, 17-9941. **Type (A)** is the double sealed ball bearing style which does not require the sleeve.

VT No.	Type
12-9935	Sealed Ball Bearing (A)
12-0357	Stock Roller Bearing (B)
12-1279	Bearing Only, 2007-up
17-9941	1984-05 Sleeve
12-9935	As Above Sleeve Not Required
14-0104	1970-84 Seal, 5 pack

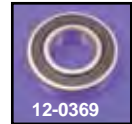

12-0369

**Bearings Only, Number of Shields Noted.**

12-0369 1984-up 5-Speed FXR-FLT, two shields



**Stepped Inner Primary Bearing Race** for all 1991-05 Big Twins features an extra step on the inside diameter that acts as a stop on the transmission mainshaft. When the race is pressed on the shaft the step will not allow the race to move inward toward mainshaft seal.

VT No. 17-0465

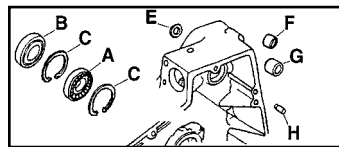

12-9755



12-1198

**Late 1984-up Inner Primary Hardware** fits Big Twin 5 Speed FXST-FLST.

VT No.	#	OEM	Item
12-9755	A	9135	Bearing
14-0159	B	12052	Seal, 1985-up, 5 pack
12-0969	C	60678-85	Retaining Ring
10-8527	F	33445-89	Bushing Starter Shaft Inner, 1989-93
10-8548	F	33445-94	As Above, 1994-up
14-0920	E	12053A	Seals, 1989-93, 5 pack
14-0961	E	12066	Seal 1994-up
12-1198	H	221	Pin, Dowel, FLT, FXR, 1984-up
10-8528	G	33446-89	Bushing Starter Outer
10-8549	G	33446-93	As Above, 1994-up
12-1253	H	—	Transmission Dowel Pin
12-1172	H	—	1986-up FXST-FLST



# Front Axle

BIG TWIN



### Chrome Flush Mount Front Axle Kits.

VT No.	Year	Model
44-0003	1988-99	FXR-FXD (39mm)
44-0004	1984-99	FXST-FXDWG
44-0005	1986-06	FLST



**Front Axle Nut** replaces 7734W, 1/2 x 20 threads, zinc.

VT No.	Type
44-0307	Each
44-2013	5 pack



**Speedo Drive Spacers** replace drive units. Fits 1984-95 FXST.

VT No. 44-2008



**Pike Front Axle Nut Kit** fits 1972-up WG, 1984-up Softail models and 39mm FXR and FXD.

VT No. 2263-2

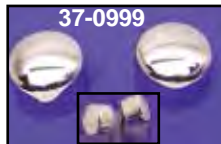
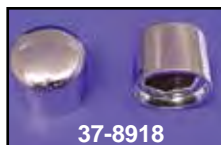
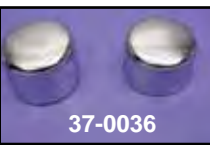

**Big Twin Front Axle Cap Cover Sets** include right and left caps with set screws for glide type forks. Chrome.

VT No.	Year/Model
37-0036	1972-84 FXWG-FXST FLH and XL-FX with 39mm tubes
37-8918	1988-up FXSTS
37-0991	1984-06 FXST
37-0999	2007-up FXST



**Axles** have chrome plated ends, except as noted. Axles only.

VT No.	OEM	Fits
44-0084	41584-86	1987-06 FLST-FLSTF
44-0695	41545-07	2007-up FLST
44-0208	43346-83B	1993-05 FXDWG
44-0793	41547-07	2007-up FXST
44-0086	43895-87	1988-99 FXR
44-0614	43895-00	2000-05 FXD
44-0685	43758-04	2004-05 FXD
44-0699	40928-06	2006-07 FXD
44-0747	41628-08	2008-up FXD
44-0746	41348-08	2008-up FXWC
44-0793	41547-07A	2008-up FXDF
44-0691	40936-06	2006-up FXDWG (1")
44-0955	43354-00	2000-06 FXSTD
44-0617		2000-06 FXSTD
44-0696	41549-07	2007-up FXSTD
44-0208	43346-83B	1984-06 FXST
44-0207	43863-84	1984-86 FXE
		1986-87 All XL-XLS-FXR-FXRS
44-0083	41109-88	1988-up FXSTS
44-0358	41116-97	1997-2003 FLSTS



### Chrome Front Axle Nut Kits.

VT No.	Model
8768-3	1973-up FX-XL
8769-3	1972-up FLH and WG
44-0599	1972-up WG



**1984-99 FXST Pike Front Axle** fits 41mm fork legs.  
VT No. 44-0229





# Chrome Front Axle Kit

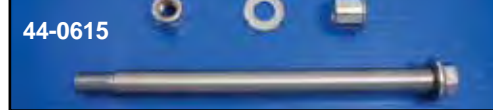
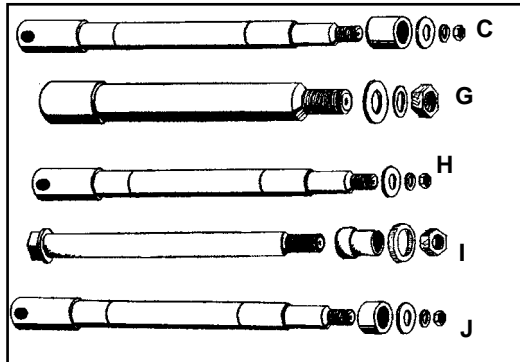

Chrome Front Axle Kits include plated axle, nuts, spacer, and hardware.

Year/Model	Kit	Spacer	Nut Kit	Axle	#	Fork mm	Outside Diameter
1980-83 FXWG, 1984-06 FXST	44-0572	44-0297	8769-3	44-0208	C	41	.750"
2007-up FXST	44-0795	2391-7	2391-7	44-0793		41	25mm
2000-06 FXST-FXDWG	44-0613	—	2022-5	44-0208	C	41	.750"
2006-up FXDWG	—	—	—	44-0691	C	49	1.00"
1984-86 FXE, 1986-87 FXR-FXRS	44-0577	—	8768-3	44-0207	G	35	.750"
1988-99 FXR-FXD	44-0578	—	8769-3	44-0086	H	39	.750"
2000-2003 FXD	44-0614	—	2028-5	44-0614	H	39	.750"
2004-2005 FXD	—	2256-5	2256-5	44-0685	H	39	1.00"
2006-07 FXD	44-0798	—	—	44-0699	H	49	1.00"
1988-96 FXSTS	44-0579	44-0546	—	44-0083	I	—	.750"
2000-up FXSTS	44-0615	—	2032-4	44-0083	I	—	.750"
1987-95 FLST-FLSTF	44-0580	44-0293	8769-3	44-0084	J	41	.750"
1996-99 FLSTF	44-0586	44-0291	8769-3	44-0084	J	41	.750"
1996-99 FLST	44-0587	44-0373	8769-3	44-0084	J	41	.750"
2000-06 FLST	44-0612	—	2034-4	44-0084	J	41	.750"
2000-06 FLSTF	44-0630	2029-5	2029-5	44-0084	J	41	.750"
2007-up FLST	44-0796	2388-5	2388-5	44-0695		41	25mm
2000-05 FLSTS	44-0631	—	—	44-0358	J	41	.750"
1997-99 FLSTS	44-0939	2364-5	—	44-0358	K	41	1.00"
2000-06 FLSTS	44-0740	2388-5	—	44-0358			
2007-up FXSTD	44-0843	—	—	44-0696	K	41	25mm

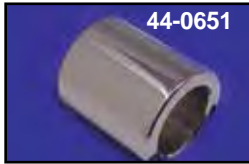

# Front Axle Spacer

## Front Axle Spacers

Chrome	Zinc	Side	Fits
44-0651	44-0297	Right Right	1984-85 FXWG 1984-99 FXST
—	44-0546	Right	1988-96 FXSTS
—	44-0550	Right	1997-99 FXSTS
—	44-0553	Left	1997-99 FLSTS
44-0369	44-0368	Left	1997-99 FXD-FXDL
44-0372	44-0350	Left	1996-99 FLSTF
44-0650	44-0293	Left	1986-95 FLST
44-0661	44-0291	Right	1989-94 FLSTF
44-0373	44-0352	Left	1996-99 FLST
—	44-0628	Left	2000-06 FXST-FLST-FXSTS
—	44-0956	Left	2000-06 FLSTS
—	44-0956	Left	2000-06 FLSTS
44-0811	—	Right/Left	2007-up FLST
44-0799	—	Right/Left	2007-up FXST



**Smoothie Spacer Set** fits front axle. Fits 2000-06 FLST. 3/4" VT No. 44-0116



**Front Wheel Seal Spacers** sold each.

VT No.	Side	Fits
44-0306	Left	1978-95 XL-XLS-FX-FXE-FXEF FXEF-80, 1982-83 FXR-FXRS-FXRT
44-0296	Left	1986-99 All XL models 1984-99 All FXR models 1984 FXE-80, 1985 FXEF
44-0297	Right	1984-86 FXWG 1984-99 FXST
44-0291	Right	1988-99 FLSTF
44-0293	Left	1986-99 FLST
44-0350	Left	1996-99 FLSTF
44-0352	Left	1996-99 All Softail
44-0628	Left	2000-06 FXSTD
44-0925	Right	2000-06 FXSTD



**Chrome Inner Hub Cover** fill area between pulley or rotor mount flange and spoke hole flange on hub for smooth appearance and ease of cleaning. Front models fit rotor side, rear kit fits both sides Fits 1987-93 FXST.  
VT No. 44-2019

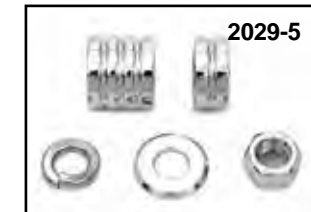
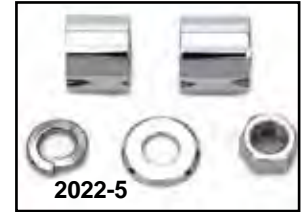
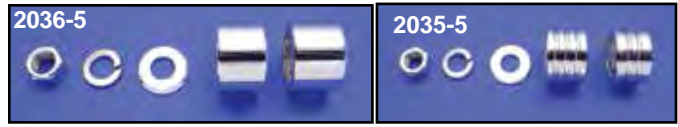

## Chrome Front Axle Spacer, Washer and Nut Kits.

Smooth	Groove	Fits
<b>FXSTS</b>		
—	9823-3	1988-96
9999-3	—	1997-99
2032-4	—	2000-up
<b>FXST-FXDWG</b>		
9826-4	9825-4	1984-95
9991-5	9990-5	1995-96
9993-5	9992-5	1997-99
2022-5	2021-5	2000-06
<b>FXST</b>		
2391-7		2007-up
<b>FXDWG</b>		
2337-5	—	2006-07
2339-5	—	2006-07
2515-5	—	2008-up
<b>FXSTD</b>		
2389-7		2007-up
<b>FLST-FLSTC</b>		
9826-4	—	1984-95
2034-4	2033-4	2000-06
2388-5	—	2007-up
<b>FLSTN</b>		
2390-5	—	2007-up
<b>FLSTF</b>		
9925-4	9924-4	1990-95
9923-5	9922-5	1996-up
2030-5	2029-5	2000-06
<b>FXD</b>		
2028-5	—	2000-03
2256-5	—	2004-05
2339-5	—	2006-07
2514-5	—	2008-up





# Rear Axle Kit



Rear Axle Kits include chrome axle, nuts, sleeves and spacers for each application. Nut kit includes axle nuts in chrome. Fits belt drive.

Kit Cpt	Spacer	Axle only	Nut Kit	Model/Year
44-0547	44-0342	44-0219	8715-4	1985-92 Softtail
44-0548	44-0342	44-0219	8715-4	1993-99 Softtail
44-0620	2026-5*	44-0219	—	2000-up FLST 2000-06 FXST
44-0893	2512-7	44-0895	—	2008 FXST
44-0633	—	44-0219	—	2000-up FXSTD
44-2001	44-0341	44-0219	8715-4	1982-95 FXR
44-0150	44-0227	44-2014	9812-3	1990-99 FXD
44-0681	2038-4*	44-2014	—	2000-05 FXD
44-0694	2335-5*	44-0765	—	2006-07 FXD
44-0713	2516-5*	44-0766	—	2008-up FXD

\*Note: Includes Nut Kit



## Chrome Rear Axles.

VT No.	OEM	Years	Fits
44-0218	41580-79	1984-86	FXWG
		1980-86	FXB-FXSB
44-0219	41110-79A	1982-up	All FXR-FXST
44-0610*	41110-79A	2000-06	Softtail
44-0127	41110-89	2007	Softtail
44-0895	41641-08	2008-up	Softtail
44-2014	41114-90	1990-05	FXD
44-0765	41114-06	2006-up	FXD

\*Note: Includes spacers and nut.



3/4" Threaded Axles feature 1 inch of 3/4" — 16 UNF thread at each end. Use with acorn, pike or nyloc nuts as required.

VT No.	Item	Length
44-0667	Axle	12 <sup>15</sup> / <sub>16</sub> "
44-0638	Axle	13.5"
44-0646	Axle	14.0"
44-0148	Axle	14.5"
44-0652	Axle	15.0"
44-0149	Axle	16.0"
37-0889	Acorn Nut Set	
44-0647	Pike Nut Set	



Axle Locators allow use of 3/4 axle in stock rigid frames with 7/8 axle slots. VT No. 44-1946



Custom Rear Axle for 1986-99 Softtail models. Include 3/4" x 14.5" axle.

VT No.	Style
44-0645	Pike
44-0656	Acorn



**Axle Spacers** feature 3/4" inner diameter for front or rear wheel use.

Sets	Each	Length	Finish
—	44-0937	.560"	Chrome
—	44-0879	3/4"	Chrome
—	44-0342	1.25"	Chrome
—	44-0325	27/32"	Chrome
44-0729	—	1/8"	Chrome
44-0730	44-0253	1/4"	Chrome
44-0731	—	3/8"	Chrome
44-0732	—	1/2"	Chrome
44-0733	—	5/8"	Chrome
—	44-0877	.650	Chrome
44-0734	44-0430	3/4"	Zinc
44-0735	44-0254	1"	Chrome
44-0737	—	1 1/4"	Chrome
—	44-0786	1 5/8"	Zinc
44-0736	44-0429	1 1/2"	Zinc
—	44-0659	1 3/16"	Chrome
—	44-0227	1 7/16"	Chrome
—	44-0658	1 5/64"	Chrome



**Rear Axle Seal Spacer Sets.**

VT No.	Application
44-0421	1982-86 FXR's cast/wire wheel pairs 1984-86 FXST wire wheel, 1982-86 FXWG wire wheel 1982 only FXS-80, wire wheel 1982-86 FXB-FXSB cast wheel
44-1944	As above with lip
44-0427	1987-99 FLT-FXST-FXR



**DIY Universal Axle Spacer** is constructed of stainless steel 6" long to be cut to length.

VT No.	Inner Diameter
44-0670	3/4"
44-0753	1"



**Axle Locator Set** allows use of 3/4 axle in stock rigid frames with 7/8" axle slots. **VT No. 44-1946**

# Rear Axle Spacer

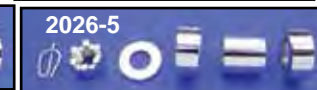

**Chrome Rear Axle Spacer Kits.** FX-FLST Kits include left side spacer, two axle adjuster collars and castle nut. Kits for Dynaglide include castle nut for axle and adjuster collars.

Stock	Grooved	Years
<b>For Softail Models</b>		
9810-4	—	1987-99
2026-5	—	2000-07
2026-5T	—	2008-up
2512-7	—	2008-up
<b>For FXD Models</b>		
9812-3	9811-3	1991-99
2038-4	2037-4	2000-05
2335-5	—	2006-07
2516-5	—	2008-up

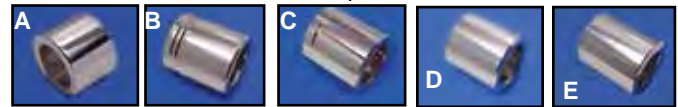

**Rear Axle Spacers.**

Chrome	Zinc	#	Application
44-0325	44-2051	A	1984-86 FXST cast/wire wheel 1973-82 All FL's left cast/wire, 1973-83 FX-FXE-FXEF FXEF-80-FXWG left wire wheel 1981-86 FXE-80 wire wheel 1973-86 All FX cast wheel
44-0342	44-0345	B	1986-99 FXST-FLST
44-0655	—	C	1982 only Classic 1983-up FLH-80 Cast or wire, 1984-86 FXWG wire 1980-86 FXB-FXSB cast wheel
44-0659	44-0341	D	1982-up FXR left side cast/wire 1985-up FXRT cast wheel
44-0227	44-0374	E	1990-99 FXD
44-0813	—	—	2000-07 FXST



**Rear Axle Spacers** allow wheels with 1" or 25 mm inner diameter bearings to fit 3/4" axle.

VT No.	Length
44-0788	1 1/8"
44-0690	1 1/16"
44-1978	1"

## Axle Nut

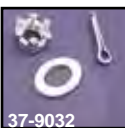

**Chrome Castle Nut Kit** includes washer and cotter pin for rear axles on 1989-up models. Replaces 7987, 511.

**VT No. 37-9032**



**Chrome Rear Axle Nut Kit** is a custom hardware kit with installation instructions. Fits 1973-up Big Twin.

VT No.	Style
8606-6	Acorn
8607-6	Cap



**Chrome Rear Axle Spring Clip** replaces 510 spring clip used on all 1991-up FL, FX, XL. Sold as pack of 5.

**VT No. 2042-5**

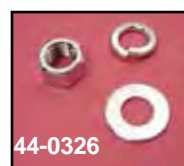

**Chrome Axle Parts** for 1972-79 FL-FLH, 1973-79 FX-FXE-FXS, 1952-79 Sportster.

VT No.	Item	U/M
44-0326	Nut with washer	Kit
37-8127	Nyloc-Nut	10
44-0749	Nut Washer	1





# Rear Axle and Hardware for Softail

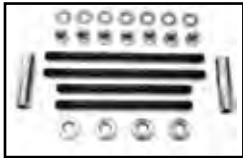
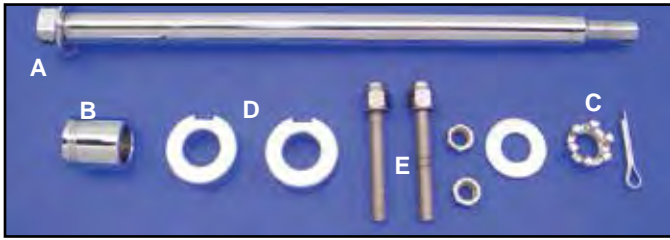

2023-2  
Shown



**Chrome Rear Axle Adjuster and Nut Kit** includes adjusters, collars, axle nut washer and "nugget" chrome cover. Kit allows use of existing nut and cotter pin.

VT No.	Year
44-0635	1986-92
44-0636	1993-99
44-0634	2000-07



**Axle Adjuster Kits** for Softails include collars and adjuster screws with nuts.

VT No.	Year
44-0545	1986-92
44-0642	1993
44-0641	1994-99
44-0609	2000-07
44-0698	2008-up

**FXST-FLST Rear Axle Kit** with chrome hardware and items pictured. Each item is available separately.

VT No.	#	Note	Fits
44-0547	A-B-C-D-E	Kit	1987-92 Kit
44-0548	A-B-C-D-E	Kit	1993-99 Kit
44-0620	A-B-C-D-E	Kit	2000-up Kit
44-0892	A-B-C-D-E	Kit	2007
44-0893	A-B-C-D-E	Kit	2008-up
44-0597		Cap Adjuster	1987-92
44-0219	A	Chrome Axle	
44-0342	B	Chrome Spacer	
8715-4	C	Nut Kit	With washers
44-0545	D and E	Adjuster Kit	1986-92
44-0609	D and E	Adjuster Kit	2000-up
44-0618	D	Collar	1994-99
44-0607	D	Collar	2000-07
44-0725	D	Collar	2008-up
8934-2	E	Adjuster only	1986-92
9515-2	E	Adjuster only	1993-99
9515-2T	E	Adjuster only	1993-99
2023-2	E	Adjuster only	2000-07
2517-2	E	Adjuster only	2008-up



**Chrome Rear Axle Caps** fit 1987-06 FXST-FLST models, completely covers axle ends and cotter key area. Easy to install.

VT No.	Style
37-8908	Smooth
37-9007	Maltese



**Rear Axle Cover** adds a smooth finished look. Easily installed with set screw. Set of two. Fits 1984-06 Softail.  
VT No. 2121-2

## Rear Axle Cover



**Chrome Softail Rear Frame Covers** bolt onto cover axle adjuster area on all Softail frames 1986-99. Hardware and instructions included.

VT No.	Style
42-0034	Smooth
44-0812	Skull
42-2036	Delta



**Chrome Tail Spurs** dress up rear castings on 1986-99 FXST-FLST models. Contour steel covers fit behind adjusters to protect paint when axle is removed. Chrome adjuster nuts supplied.

VT No.	Item
42-0676	Spurs
44-0545	Adjuster Kit

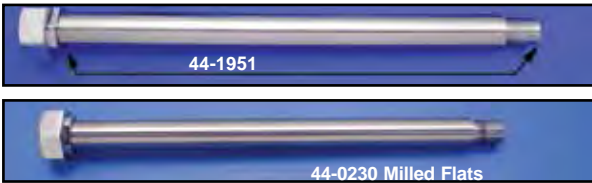

**Note:** Rigid types have a milled head to fit replica rigid.

**VT No. Item Length**

**Rigid**

44-0221	Kit	10.25"
44-2038	Kit	11.75"
44-1951	Axle	10.25"
44-0230	Axle	10.75"
44-2043	Axle	11.75"
44-1985	Axle	11.25"
44-1986	Axle	12.25"
44-1942	Axle	12.50"



**Swingarm**

44-1945	Axle	11.50"
44-0947	Axle	12"
44-1044	Axle	12.50"

**Axle Collar Sleeves** have milled flat section on one end to fit rigid frame slots.

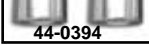

**VT No. Length U/M**

44-0394	1 <sup>5</sup> / <sub>16</sub> "	Pair
44-1987	1 <sup>13</sup> / <sub>16</sub> "	Each
44-1988	2 <sup>3</sup> / <sub>4</sub> "	Each
44-0316		Sleeve Collar
44-0520		Nut

# Rear Axle



**Rigid Frame Disc Brake Rear Axle** for use when 1973-up rear disc brake units are installed on rigid frames. Kit includes .750" diameter axle, nut, special spacer and washers. Other axles sold separately. Spacers may have to be cut to length. Rigid axles have milled area on hex head. Swing arm does not. Length includes threads not head.



**Chrome Rear Axle Nut and Washer Kit** includes two extra thick washers, nut and lock washers for 1973-up, on square swing arms.

<b>VT No.</b>	<b>Brand</b>
8715-4	Colony
44-0520	V-Twin



**Axle Locator Set** allow use of 3/4 axle in stock Rigid frames with 7/8" axle slots.  
**VT No. 44-1946**

# Axle Adjuster

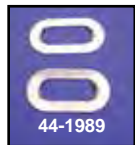

**Axle Protector Plates** prevent axle nuts from scratching painted finish. Sold in pairs, polished stainless. Fits 1984-06 FXST-FLST.  
**VT No. 44-1989**

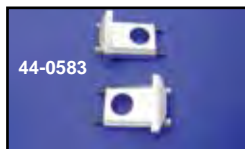

**FXR Rear Axle Adjusters** include heavy axle pull blocks and chrome end caps with allen screws, for 1982-94. Chrome pivot covers also available.

**VT No. Item**

44-0583	Adjusters
42-0030	1982-89 Pivot Cover Set



**Calibrated Rear Wheel Adjusters** feature chrome pyramid blocks with sight indicator to view calibrated adjuster bolt, for accurate and easy wheel alignment. Adjuster bolt is chrome heavy duty 1/2" rod with micrometer markings; nut is stainless steel. Fits 1973-85 FX-FLH, 1984-86 FXST. **VT No. 44-2011**



**Pyramid Adjuster Block Kit** has die cast chrome pyramid end caps for use with stock type pull adjusters. Fits 1997-up FLT.  
**VT No. 44-0250**

# FXD



**Chrome Adjuster Block Set** fits 1991-05 FXD models.  
**VT No. 44-0543**



**Chrome Rear Axle Nut Cover Set** features simple set screw installation. Fits 1991-up FXD.  
**VT No. 37-9375**



**Chrome Rear Wheel Adjuster Hardware** for 1991-05 models.  
**VT No. Item**

2000-6	Swingarm End Plate with Adjuster
2001-2	Swingarm End Plates





# Wheel Hub Bearing



**Deluxe Rear Hub Rebuild** contains all internal parts including longest length inner spacer (white 4.4480). Spacer can be cut down or collar removed for some applications.

VT No.	Note	Fits	Brand
44-1997	1	1984-90 FXST, 1987-91 FXR	Peer
44-2047	1 & 2	1992-99 FXST-FLST-FXR, Dynaglide, XL, 1987-99 FLST Wire Wheel only	Peer
44-2048	1 & 2	As Above for Cast Wheel only	Peer
44-0589		2000-up Softail, XL, FXD	SMT

**Note:** 1. Does not include snap rings and seal washers.  
2. Order spacer shims separately.



**Rear Wheel Bearing Race and Seal Kit** includes two of each bearing, race and proper seals. Fits 1983-94 FXR, 1983-99 FXST-FLST-FLT-XL, 1991-99 Dynaglide, cast or wire wheel.  
**VT No. 44-0420**



**Bearings Kit** includes two tapered bearings and two races replacing 9052 for 1973-99 Big Twin swing arm 1958-85.  
**VT No. Item**  
44-0425 4 Piece Kit  
44-0405 Race and Bearing, one pair  
44-0406 Bearing Only, one piece  
44-0407 Race Only, one piece



## Inner Hub Bearing Tubes.

VT No.	OEM	Length
<b>Steel Dual Flange Hub Spacer, Front and Rear</b>		
44-0338	43601-78	4.420" Orange
44-0336	43602-78	4.434" Yellow
44-0337	43603-78	4.448" White
<b>Cast Wheel Hub Spacer, Front and Rear</b>		
44-2032	43604-78	4.420" Red
44-2033	43605-78	4.434" Yellow
44-2034	43606-78	4.448" White
<b>Front, Cast</b>		
44-2025	43608-82	4.308" FLT
44-0236	43612-92	FLSTF
<b>Front Laced</b>		
44-0237	43668-82	FLT-FLST-FXST-WG



**Adjustable Inner Hub Spacer** for 1973-99 wire wheels and most custom wheel application.  
**VT No. 44-0639**



**Big Twin Hub Rebuild Kit** contains bearings, races, seals and seal spacers. Hub and internal bearing spacer not included. Fits 1986-94 FXR, 1984-99 FXST-FLST  
**VT No. 44-0453**



**Rear Double Row Retro fit** wheel bearing kits for models with bearings. Double row wheel bearings eliminate wheel play, have a longer wear life, require no adjustment. Kits include two bearings, center spacer and spacers. Fit 1984-99 FXST, FLST, 1991-99 FXD, XL.  
**VT No. 44-2995**

**Replica Bearing Kits** include inner spacer, rear.

VT No.	Year	Model
44-0989	2000-07	FLT
44-0997	2000-07	FXST-FXD
44-0998	2008	FLT
44-0999	2009-up	FLT

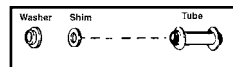

**FLT Wheel Hub Hardware** fits 1982-99 models, 1982-99 FXR models.

VT No.	OEM	Item
44-2024	43613-92	2.424" Spacer for narrow hub
44-2025	43608-82	4.308" Spacer for wide hub
44-2026	43650-82	Spacer Washer
44-2027	43290-82	.032 Shims, 10 pack
44-2028	43291-82	.016 Shim
44-2029	43292-82	.008 Shim
44-2030	43293-82	.004 Shim
44-2031	43294-82	.002 Shim



**Inner Hub Bearing Tube Spacers** may be used in some cast mag wheel applications when flange is removed. Check for proper length fit.

VT No.	OEM	Model/Year	Type	Fits
44-0313*	43623-78	1978-99 FX-XL	2.564 Violet	Front
44-1980*	43624-78	Front	2.550 Pink	Front
44-1981*	43625-78	Choose Length	2.536 Gold	Front
44-0958	43625-78	Front	2.542	Front
44-0356	43608-00	2000-07	FXST	Front
		2000-01	FLT Rear	Front
			and	Rear
44-0362	43613-00	2000-up	Front XL, FXD	Front
44-0858	43517-00	2000-07	FLT	Front
		2002-07	FLT	Rear
44-0859	43755-04	2004-06	FXD	Front
44-0860	43641-01	2001-03	FX	Front
44-0885	43906-08	2008-up	XL	Rear
44-0961	41349-07	2007-up	FXST	Front
		41349-07	FLT	Rear
44-0962	41900-08	2008	FLT	Front
44-0943	41696-08	2008-up	FXST	Rear
44-0708	43905-08	2008-up	FXD	Rear
44-0954	41748-08	2008-up	FXD	Front

\*Note: Choose proper length.



## Wheel Seals.

**Note:** VT No. 14-0139 and 14-0658 feature metal housing all others are rubber covered.

James	VT No.	OEM	Fits
14-0659	14-0140	47519-83A	1983-99 FX, 1985-99 FLST, Front/Rear Wheel Double Lip
—	14-0182	47519-83	1983-84 As Above



# Wheel Bearing Kit

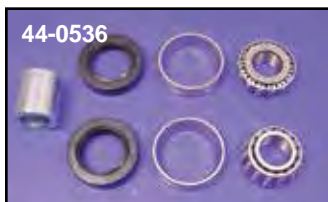

**Front Wheel Assembly Kit** for steel hubs only. Contains two of each of each, bearing, race and seal and one correct seal spacer. Also included for certain applications only are two each snap ring and seal retainer washers. Not included in this kit is the internal bearing spacer which may be ordered separately. Check listing.

VT No.	Wheel	Fits
44-0456	Wire	1984-86 FXWG
44-0457*	Wire	1984-85 FXST
44-0536*	Wire	1986-99 FXST, 1993-99 FXDWG
		1984-99 FLT
44-2045*	Cast	1992-99 FLSTF
44-2046	Cast	1987-91 FLST

**\*Note:** Does not include snap rings and seal washers.



**Wheel Bearing** fits front and rear.

VT No.	OEM Fits	U/M	Size	Year
12-0592	9267 FXD, FXST	Each	3/4"	2000-06
44-0993	9267 FXD, FXST	Pair	3/4"	2000-06
12-0631	9276 Softail Front	Pair	25mm	2008-up
44-0900	9253 ABS/Non-ABS			
44-0901* 21"	ABS/Non-ABS			
44-0902* 23"	ABS/Non-ABS			
44-0903* 26"	ABS/Non-ABS			

**\*Note:** Bearings for larger than stock diameter wheels have a greater reinforced magnetic area that will not set off any engine codes after proper installation.



**Front Wheel Bearing, Race and Seal Kit** contains two of each, bearing, race and proper seals. Fits 1984-94 FXR cast or wire, 1984-99 All FX-FLT-FXST cast or wire, 1991-99 Dynaglide, cast or wire. **VT No. 44-0417**



**Front Internal Hub Kit** includes all internal parts for complete rebuilding of all alloy front hubs. Includes inner spacer, bearings, races seals and seal spacer matched for each year group. Hub is not included.

VT No.	Type	Fits
44-0537	Single Disc	1984-91 FX-FXR, 1984-91 XL
44-2049*		1992-94 FXR, 1992-99 FXDL
44-0611	Single Disc/ Dual Disc	2000-07 FXD, XL Cast or Wire wheel
44-0988	Single Dual	2000-05 FXD 2000-07 XL
44-0990	Single	2007-up FXST

**\*Note:** Order spacer shims separately.



**Wheel Bearing Greaser.** Fitting and spigot greases 1973-99 tapered bearings without removing seals, use existing seal spacer or purchase separately.

VT No.	Item
16-0803	Tool
44-0303	Collar

# Axle Nut Cover

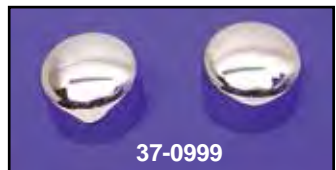
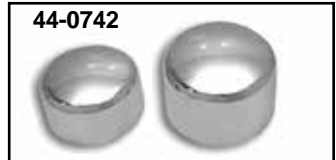

**Chrome Axle Nut Caps Set** for both axle nut and axle head where required. Each cap has an internal hex to allow more thickness for the set screws thread to eliminate thread stripping.

**Note:** These axle caps will not work on late model rear axles with cotter key locking devices.

Front	Rear	Fitment
—	37-8885	1984-94 FXST Does Not Fit Rear 1989-94
—	37-8885	1982-87 FXR
—	37-8885	1981-85 FX
—	37-8884	1973-80 FX
—	37-8886	1971-72 FX
—	37-0041	2000-07 Softail
—	44-0742	2008-up Softail
44-0741	—	2007-up FXST
37-0999	—	2007-up FXST for 25 mm axle
2536-2	—	2007-up FXST
37-0999	—	2008-up Touring for 25 mm axle
—	44-0845	2006-07 FXD
—	37-8885	1980-94 FLT
		Does Not Fit Rear 1989-94





# Cast Wheel Cover



**Chrome Wheel Covers** are contour formed to fit Alloy 16" FXST rear and Fat Boy front and rear, covering up to the step at the valve stem hole area. Both are held in place by the rotors and belt pulley. Sold in pairs.

VT No.	Type	Year
45-0689	Front FLSTF	1986-99
45-0742	Front FLSTF	2000-up
45-0690	Rear FLSTF-FXST	1986-99



**21" x 2.15" Wheel** with billet front hub, stainless spokes and chrome kit. Fits 1984-99 FXST with 41 mm fork and 60 polished stainless spokes and chrome rim.  
**VT No. 52-0139**

# Wheel Assemblies



**Wheel Assemblies** with chrome billet hub for Softail models feature a chrome plated billet hub, chrome spokes and chrome steel rim for either tube type or tubeless application. Rear wheels have extension on pulley side to minimize pulley spacers and bearing is moved outboard to prevent bent axles. Front or rear wheels accept 1 1/2" disc rotors. Single flange are for right side drive. The 1984-99 hub types use Timken bearings and the 2000-up hub types use sealed bearings without ABS.

VT No.	Size	Spoke	Axle Size	Drive Side	Hub Type
<b>52-0122</b>	18" x 8.5"	60	3/4"	Left Hand	2000-up
<b>52-0682</b>	18" x 10.5"	80	1"	Left Hand	2000-up
<b>52-0683</b>	18" x 10.5"	120	1"	Left Hand	2000-up
<b>52-0684*</b>	18" x 10.5"	80	1"	Right Hand	2000-up
<b>52-0685*</b>	18" x 10.5"	120	1"	Right Hand	2000-up
<b>52-0640*</b>	17" x 12"	80	1"	Right Hand	2000-up
<b>52-0642</b>	17" x 12"	80	1"	Right Hand	2000-up

\*Note: Single sided hub flange

# Cast Wheels



**16" Chrome Billet Wheels** have 3-spoke design include bearings, an internal spacer and tubeless tire valve stem.

VT No.	Year	Model
<b>52-1015</b>	2000-2002	FXD-Softail
<b>52-0992</b>	2003-05	Softail



**Rear Billet Hub Wheel** features 80 stainless spokes, chrome billet hub and rim. **\*Note:** For Right Side Drive x 300 only. Fits 18" x 10.5" rear wheel.  
**VT No. 52-0195**



Tenzo Rear



Trex

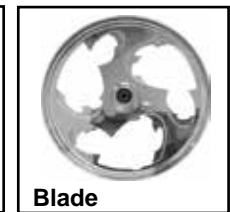

Blade



52-2901 Right Side

**Wyatt Gatling Chrome Forged Billet Wheels** for 1987-99 FXST. Wheels include adapter spacers and bearings as required. Use with 2000-up brake rotor and drive pulley.

Size	Fits	Tenzo	Trex	Blade
16" x 3.5"	Rear	<b>52-2900</b>	<b>52-2903</b>	<b>52-2906</b>
18" x 8.5"	Rear	<b>52-2901</b>	<b>52-2904</b>	<b>52-2907</b>

**Bearing Sets** for 60 spoke wheels.

VT No.	Inner Diameter
<b>12-8850</b>	3/4"
<b>12-8851</b>	1"

**Valve Stem.**

VT No.	Type of Nut
<b>28-2138</b>	Outside



# Hubcap

BIG TWIN



**Chrome FLST Front Wheel Hubcaps** are held by a snap ring. The full 8" dresser hubcaps for wire wheels on glide type forks fit between hub and axle without additional hardware.

VT No.	OEM	Years	Fits
42-9921	43067-86	1986-96	FLST Single Disc 16" wheel held by snap ring
45-0410	43155-97	1997-99	FLST As Above
45-0761			Cap Only
45-0960	43162-97		Front Hub Cap Kit, chrome
45-0934			Cap Only
45-0801	43155-00	2000-06	FLST
45-0805	415401-07	2007-up	FLST
12-0956	11175		Snap Ring for 1986-96 FLST Hubcaps

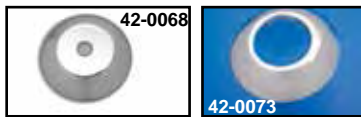

**Chrome 4 1/2" Hubcaps** fit between hub and axle without additional hardware.

VT No.	Type	Year	Model
42-0068	Rear	1984-up	FXST-FLST
42-0073	Front	1986-up	FLST
45-0408	Front, Mag	1984-95	XL, FXD Brushed Aluminum



**Hub Cap Adapter Kits.** Hubcap available separately.

VT No.	Fits	Side	Chrome Hubcap Kit
44-0809	1986-99 FLST	Right, zinc	45-0862
44-0976	2007-up FLST	Right, zinc	
44-0894	1997-99 FLSTS	Left, zinc	45-0866
44-0888	2000-06 FXST	Right, zinc	45-0863
44-0889	1984-99 FXST	Right, zinc	45-0864
44-0890	1997-99 FXSTS	Left, zinc	45-0865
44-0974	2000-06 FLSTS	Left, zinc	45-0867
44-0975	2000-06 FLSTF		
44-0995	2000-06 FLST		
—	2000-06 FLSTS	Right	45-0964



**"Baby Moon" Chrome Rear Hubcap** with screws. Fits 1993-up.  
VT No. 45-0416



**Chrome Mini Cap** fits between swingarm and axle spacer. Fits 1973-95.  
VT No. 45-0692

# Front And Rear Wheel Hub

All hubs include bearings, races, seals, seal spacers and are assembled and chromed for 40 spokes except where noted.



Rear Hubs			
VT No.	#	Year	Model
45-0670	A	1982-85	FXE-FXWG-FXR
45-0325	B	1986-99	FLT
45-0670	A	1984-85	FXST
45-0671	A	1986-99	FXR-FXST-FLST
45-0324	C	1986-99	As Above Billet Type
45-0332	C	2000-06	FXST-FXD, 2000-01 FLT
45-0333	C	2002-07	FLT
45-0333	C	2006-07	FXD
45-0859	C	2008-up	FXD without ABS
45-0473	C	2008	FLT Only without ABS
45-0474		2008-up	FLT
45-0853	C	2008-up	FXST-FLST-FXDWG without ABS
Rear Hubs with ABS			
45-0813		2009-up	FLT with ABS
45-0812	C	2012-up	FXD with ABS
45-0814	C	2011-up	FXST-FLST-FXDWG with ABS



Front Hubs			
VT No.	#	Year	Model
45-0295	D	1984-15	FXST-FXSTC-FXDWG
45-0295	D	1984-85	FXWG, Single Disc
45-0329	F	1996-99	FXST-FXDWG-FLSTS
45-0588	E	2000-07	FXST, Single Disc, Polished
45-0785	E	2008-up	FXST, FLST, FXDWG without ABS
45-0591	E	2000-07	FXST-FLST, Single Disc
45-0688	D	1986-99	FLST-FLSTC Single Disc
45-0298	G	1984-99	FXR-FXD-FXRS
		1984-85	FXSE-80, FXEF Single Disc
45-0292	G	—	As above but Dual Disc
45-0532	H	2000-03	FXD, FXDL Single Disc/Dual Disc
45-0641	H	2000-03	FXDL-FXDX, Single Disc (21")
45-0589	I	2006-07	FXD
45-0788	I	2008-up	FXD with 25mm bearings, 49mm forks w/o ABS
45-0590	J	2006-07	FXDWG
45-0293	D	1988-99	FXSTS
45-0326	A	1984-99	FLT
45-0336	F	2000-07	FLT
45-0786	E	2008only	FLT Dual Disc without ABS
45-0968	E	2009-up	FLT, Touring, Dual Disc without ABS
45-0342		2004-05	FXD



Front Hubs with ABS			
45-0815	E	2000-up	FXST, FLST, FXDWG with ABS
45-0816	I	2010-up	FXD with ABS
45-0817	E	2009-up	FLT with ABS

**Note:** Install ABS bearing first on brake rotor side of hub with greenish tan side facing out. Install non ABS bearing on drive side of hub with lettered side facing out.





# Spoke Set Chart

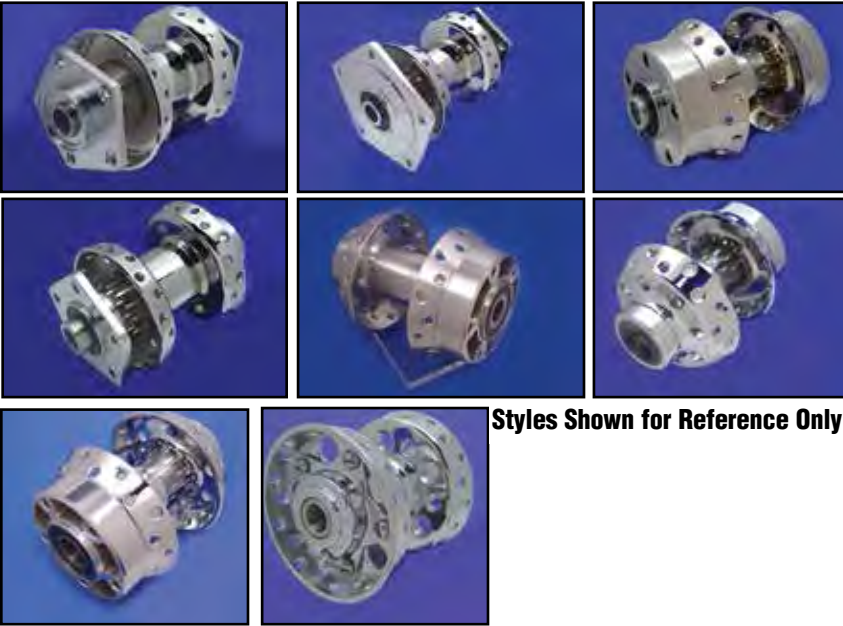

Styles Shown for Reference Only.

## 40 Short Shank Spokes

Note: Spokes in this list fit horizontal flanged hubs as styles shown.

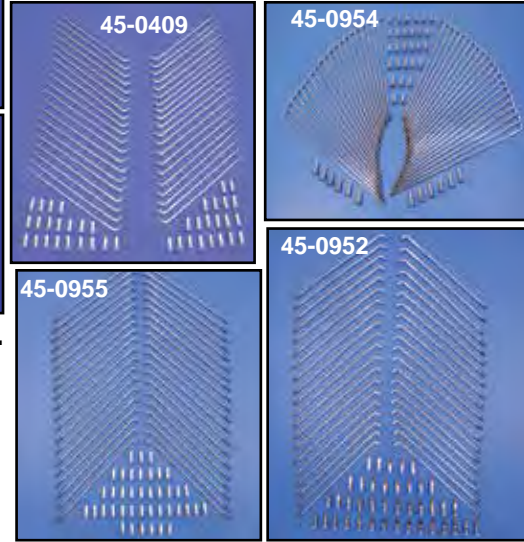

**Flat Flanged Hubs.** Front and rear flanged hubs, including 1936-84 FL-FLH front and rear, 1973-84 FX-FXE rear, 1954-99 XL rear, 1984-95 FLST-FXST-FXDWG front or rear, 1996-up FLST-FXST alloy rear, 1986-up FLT rear, 2000-up XL alloy rear and 1996-up Dynaglide alloy rear. **All spokes listed are 6-8 gauge.** Kits include 40 spokes and 40 nipples.



SPOKE SETS FOR FLAT FLANGE HUBS										
Chrome V-Twin	Chrome Buchanan	Chrome Twirled V-Twin	Chrome Twirled Buchanan	Stainless Twirled V-Twin	Stainless Twirled Buchanan	Chrome Diamond V-Twin	Chrome Diamond Buchanan	Size	Rim Type	Note
45-0620	—	—	—	—	—	—	—	15"	DC	
45-0621	45-0720	45-0703	45-0675	45-0709	—	—	45-0682	16"	DC	3
45-0952	—	45-0765	—	—	—	—	—	16"	Profile Rim	
45-0956	—	—	—	—	—	—	—	16"	Profile Rim	5
45-0762	—	45-0765	—	—	—	—	—	17"	DC	4
45-0601	45-0721	—	—	—	—	—	—	18"	C	
45-0610	—	—	—	—	—	—	—	18"	DC	
45-0602	—	—	45-0727	—	45-0729	—	45-0684	19"	C	
45-0767	45-0728	—	45-0730	—	—	—	—	19"	DC	1
45-0603	45-0723	45-0706	45-0677	45-0726	45-0700	45-0716	—	21"	DC/C	
45-0954	—	—	—	—	—	—	—	21"	Profile Rim	
45-0937	—	—	—	—	—	—	—	23"	DC	

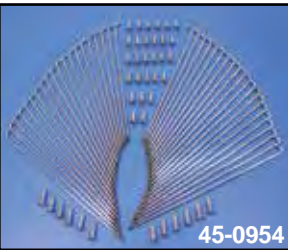

SPOKE SETS FOR FLAT FLANGE HUBS							
Chrome Rippled Buchanan	Stainless V-Twin	Stainless Buchanan	Cadmium Plated V-Twin	Perma Chrome	Size	Rim Type*	Note
45-0731	45-0409	45-0651	45-0710	—	16"	DC	3
—	—	—	—	45-0946	16"	DC	W
—	45-0748	45-0652	—	—	18"	C	
—	45-0955	45-0656	—	—	18"	DC	
—	45-0764	45-0653	—	—	19"	C	
—	—	45-0654	—	—	19"	DC	1
—	—	45-0674	—	—	19"	DC	2
—	45-0713	45-0655	—	—	21"	DC/C	
—	—	—	—	45-0377	23"	DC	

**Notes:**

1. Fits Disc Type Spool Hub Only
2. Fits Drum Type Spool Hub Only (Cross 3)
3. VT No. 45-0409 is Hand Polished
4. Use with rim 52-0435
5. Use with rim 52-0761

\*Note: Rim Type Drop Center = DC or Conventional = C  
Profile Rim = P  
W = Fits wide 52-0730 rim

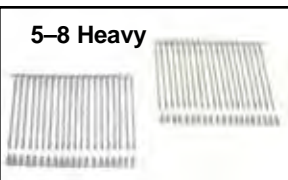
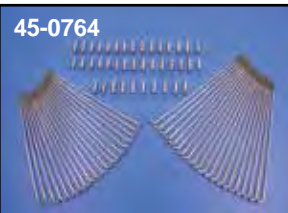

16" Stainless Heavy 5-8 Gauge Spoke Set to fit flange hubs and stock rims. VT No. 45-0738



**6/8 Gauge Nipple 40 Piece Set.**

VT No.	Type
45-0626	Standard, Chrome
45-0160	Standard, Cadmium
45-0680	Standard, Stainless
45-0749	Standard, Chrome
45-0750	Extended, Stainless
45-0521	Extended, Chrome
45-0781	Extended, Chrome
45-0782	Extended, Stainless



# Front Spoke Set



**FX-XL-FXR 1973-up Alloy Hub Spoke Set** with single or dual disc with vertical flanges to house spokes. Sets include 20 long and 20 short shank spokes. Shank is 8 gauge portion which fits in hub flange. with 40 nipples.

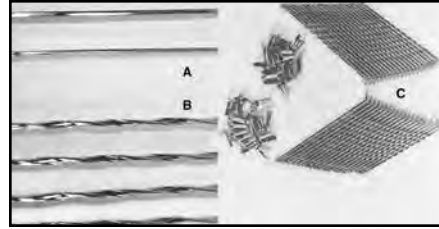

**Spokes listed fit alloy hubs with vertical flanges as shown.**

**All Spokes Listed Are 6-8 Gauge**

**Twirled-Diamond-Stock** are noted as the following:

- B** Twirled Buchanan
- B** Twirled V-Twin
- A** Diamond Buchanan
- C** Ripple Style

Spoke Set for Alloy Front Disc Spool												
Chrome V-Twin	Chrome Twirled V-Twin	Chrome Twirled Buchanan	Stainless Twirled Buchanan	Stainless Diamond Buchanan	Chrome Rippled Buchanan	Stainless V-Twin	Stainless Buchanan	Perma Chrome	Size	Rim Type*	Note	
45-0606	—	—	—	—	—	—	45-0661	—	19"	C		
45-0623	45-0705	45-0676	45-0699	45-0683	—	45-0714	45-0660	45-0631	19"	DC		
—	45-0751	45-0686	45-0701	45-0687	45-0755	—	45-0662	—	21"	DC/C		
45-0611	—	—	—	—	—	45-0612	—	—	21"	DC/C	Fits 2000-up FXD-XL	
45-0953	—	—	—	—	—	—	—	—	21"	P		

# Twirled Spoke Wheel



Spoke Detail

**Twirled Spoke Wheels** include chrome hubs with internals, rim and twirled chrome spokes assembled.

VT No.	Fits	Type	Width
<b>FRONT</b>			
52-0859	1984-99 FLT	16" Single	3.00"
52-2025	2000-06 FLST	16" Single	3.00"
52-0852	1986-99 FLST	16" Single	3.00"
52-0843	1984-95 FXST-FXDWG	21" Single	2.15"
52-0908	1996-99 FXST	21" Single	2.15"
52-0853	1988-99 FXSTS	21" Single	2.15"
52-0971	2000-06 FXST-FXDWG	21" Single	2.15"
52-2014	2008-up FXST w/out ABS	21" Single	2.15"
52-0909	1996-99 FLSTS	16" Single	3.00"
52-0972	2000-07 FLSTS	16" Single	3.00"
52-0845	1984-99 FXR-FXD	19" Dual/Single	2.50"
52-0943	1984-99 FXR-FXD	21" Dual/Single	2.15"
52-0973	2000-03 FXD	19" Dual/Single	2.50"
52-2015	2004-05 FXD	19" Dual/Single	2.50"
52-0974	2000-03 FXD	21" Dual/Single	2.15"
52-2016	2004-05 FXD	21" Dual/Single	2.15"

VT No.	Fits	Type	Width
<b>REAR</b>			
52-0177	1982-84 FXE 1982-86 FXWG 1984-85 FXR	16"	3.00"
52-0842	1986-95 FXST-FLST-FXD	16"	3.00"
52-0851	As Above	16"	4.00"
52-0911	1997-99 FXST	16"	3.00"
52-0976	2000-05 FXST- FLST-FXD 2000-01 FLT	16"	3.00"
52-0978	2000-05 FXST-FXD-FLST 2000-01 FLT	16"	4.00"
52-0858	1986-99 FLT	16"	3.00"



**Since 1969! Wheel Building Service**

Select any of our hubs, a set of spokes including stainless steel, chrome, twirled or diamond spokes and a rim. We will lace and true in our plant. The finished wheel can be shipped in 24 hours. Complete wheel will be billed as follows: Rim, Spokes, Hub and Labor. Service limited to components in stock.

VT No. 60-0125





# Chrome Front Wheels

For 41 and 49mm forks as noted

Complete Wheels in stock for immediate shipment from V-Twin Mfg™. The original aftermarket wheel builders since 1969.

W/Chrome Spokes	Stainless Rim	Rim Spokes	Rim Diameter Width
<b>1988-99 FXSTS with single disc on Spring Fork.</b>			
—	52-0825	16"	3.00"
52-0199	—	18"	2.50"
52-0778	—	18"	4.25"
52-0185	52-0826	21"	2.15"
52-0489	—	21"	3.25"
<b>1984-95 FXST-FXDWG, 1984-85 FXWG with single disc. Fits 41mm forks.</b>			
52-0175	52-0823	16"	3.00"
52-0829	52-0830	19" D.C.	2.50"
52-0169	52-0824	21"	2.15"
52-0455	—	21"	3.25"
52-0450	—	23"	3.00"
<b>Fits 24-0514 assembly only.</b>			
52-0848	52-0849	16"	3.00"
<b>1996-99 FXST-FXDWG-FLSTS with single disc. Fits 41mm forks and Spring Fork (FLSTS)</b>			
52-0904	52-0905	16" (FLSTS)	3.00"
52-0906	52-0907	21"	2.15"
52-1032	—	23"	3.00"
<b>1986-96 FLST with single disc. Fits 41mm forks.</b>			
50-0696	52-0695	16"	3.00"
52-0694	52-0693	21"	2.15"
52-1028	—	23"	3.00"
<b>2000-06 FXDWG with 41mm forks and single disc</b>			
52-1084	52-1085	21"	2.15"
52-0480	—	21"	3.25"
52-0457	—	23"	3.00"
<b>2000-06 FXST/FXSTS</b>			
52-1084	52-1085	21"	2.15"
52-1027	—	23"	3.00"
<b>2008-up FXST</b>			
52-1053	52-1056	21"	2.15"
<b>1997-99 FLST with single disc. Fits 41mm forks.</b>			
52-2019	52-2020	16"	3.00"
52-0479	—	21"	3.25"
52-0456	—	23"	3.00"



<b>2000-up FLSTS with 41 mm fork and single disc without ABS.</b>			
52-1092	52-1093	16"	3.00"
52-2006	52-2007	16"	3.00"
<b>2000-06 FLST-FLSTSF with 41 mm fork and single disc without ABS.</b>			
52-0483	—	21"	3.25"
52-0460	—	23"	3.00"
<b>2007-up FLST-FLSTF with 41mm fork with single disc.</b>			
52-0995	52-0996	16"	3.00"
<b>2008-up FLST, FXST, FXDWG without ABS</b>			
52-1054	—	16"	3.50"
52-1053	52-1056	21"	2.15"
52-0488	—	21"	3.25"
52-0459	—	23"	3.00"
<b>2006-07 FXD with 49mm fork.</b>			
52-2031	52-2032	19"	2.50"
52-2027	52-2028	21"	2.15"
52-1035	—	23"	3.00"
<b>2006-2007 FXDWG with 49mm fork.</b>			
52-2086	52-2085	19"	2.50"
52-2029	52-2030	21"	2.15"
<b>2007 FXST, 2007-up FXSTS</b>			
52-0997	52-0998	21" D.C.	2.15"
<b>2008-up FXDWG with 49mm fork</b>			
52-1053	52-1056	21"	2.15"
<b>2008-up FXDF with 49mm fork without ABS.</b>			
52-0478	—	19"	2.50"
52-0486	—	21"	3.50"
<b>2011-up FLST, FXST, FXDWG with ABS</b>			
52-2054	—	16"	3.50"
52-2055	—	21"	2.15"
52-2056	—	21"	3.25"
<b>2008-up FXDF with 49mm fork without ABS.</b>			
52-0486	—	21"	3.25"
<b>2008-up FXD with 49mm fork without ABS</b>			
52-2039	—	19" DC	2.50"
52-0899	—	19"	2.50"
52-0917	—	21"	2.15"
52-1029	—	23"	3.00"

# Complete Chrome Wheels



BIG TWIN



## Chrome Profile Laced Wheel.

VT No. Fits

**21" Front**

52-0660 2000-06 FXST except FXSTS and 2000-05 FXDWG models

52-0555 2007-up FXST



## Profile Rimmed Wheels



**Chrome Rear Profile Laced Wheel.** The profile rim is an aluminum rim with a smooth chrome finish.

**16" Rear**

VT No. Fits

52-0589 1986-99 FXST

52-0666 2003-07 Softail models

52-0667 2000-05 Dynaglide models

**16" Front**

52-0664 2003-06 FL Softail models

52-0554 2007-08 FLST



## Fat Spoke Wheel



**Front 50 Fat Spoke Radial Laced Wheel** features 3/8" polished stainless steel spokes, billet chromed hub and polished chrome steel rim. Include bearings, seals and center spacer. Fit 1986-99 FLST/C/F/N, 16" x 3.5" wheel.

VT No. 52-0108







Wheel Builders



Since 1969

# Big Twin Rear Wheel



**Complete Wheel Assembly** features the following:

- Chrome Rim
- Chrome or Stainless Spokes
- Chrome Hub with Internals
- 40 Spoke Style



**1986-96 FXR-FXRS-FXST-FXSTC-FLST and FXDG models.**

**Note:** FXR applications must use VT No. 44-0421 seal spacers.

Chrome Spokes	Stainless Spokes	Rim Diameter	Rim Width
52-0176	52-0810	16"	3.00"
52-0215	52-0216	16"	3.50"
52-0861*	52-0862*	16" Deluxe	3.00"
52-0935	52-0936*	16"	4.00"
52-2042	—	16"	4.50"
52-2033	—	17"	4.50"
52-0198	—	18"	2.50"
52-0775	—	18"	4.25"

**1997-99 FXD-FXST-FLST** feature updated rear hub with smooth flange area.

Directly bolts on to models listed. Assembled with all original components.

52-1076	52-1077	16"	3.00"
52-1078	52-1079	16"	4.00"
<b>2000-2005 FXD-FXST-FLST</b>			
52-1080	52-1082	16"	3.00"
52-0217	52-0218	16"	3.50"
52-1081	52-1083	16"	4.00"
52-2044	—	16"	4.50"
52-0777	—	18"	4.50"
<b>2006-07 FXD</b>			
52-2010	52-2011	17"	4.50"

**2008-up FXST, FLST, FXDWG without ABS**

52-2041	—	16"	3.00"
52-2087	—	17"	6.00"

**2011-up FXST, FLST, FXDWG with ABS**

52-2057	—	16"	3.00"
52-2058	—	17"	6.00"

**2008-up FXD without ABS**

52-2040	52-2045	17"	4.50"
---------	---------	-----	-------

**2012-up FXD with ABS**

52-2059	—	17"	4.50"
---------	---	-----	-------

**2007-up FLSTF without ABS**

52-6650	—	17"	6.00"
---------	---	-----	-------

**1982-84 FXE, 1982-86 FXWG, 1982-85 FXR, 1984-85 FXST**

52-0168	52-0809	16"	3.00"
---------	---------	-----	-------

\*Note: Deluxe rims are OE type.



## 1997-99 FXD-FXST-FLST Type Rear Wheel

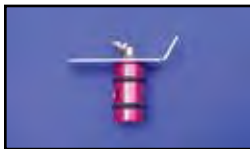

**Wheel Bearing Greaser.** Fitting and spigot greases 1973-99 tapered bearings without removing seals. Use existing seal spacer or purchase separately.

VT No.	Item
16-0803	Tool
44-0303	Collar





# Front Wheel *for* 35 and 39 mm Fork

BIG TWIN



These replica wheels bolt on to stock applications as listed with no modifications.

## 60 Spoke Wheel



**Complete 60 Spoke Wheel** features chrome wide steel rim, steel hub and chrome spokes for any wide frame application. Hub features a .900" extension to minimize pulley spacers and the bearing is moved outboard to prevent bent axles. Accepts 11 1/2" disc rotor, 1984-99 style pulley or 1973-85 chain sprockets. Steel hubs include bearings, seals and spacers. Rim is sealed after truing so that it can also be used with tubeless tires.

VT No.	Size	Width	Tire	Year	Fits
52-0654	16"	5.5"	180-200	1984-99	Rear
52-0677	21"	2.15"	120/90	1984-99	Front

*All front wheels on this page feature a chrome hub, with all internal bearings installed, choice of chrome or stainless spokes and chrome rim completely laced and trued.*

Chrome Spokes Chr. Hub	Stainless Spokes Chrome Hub	Rim Diameter	Rim Width
1984-99 FXR-FXD with single/dual disc. Fits 35 and 39 mm forks.			
52-0170	52-0827	19" Drop Center	2.50"
52-0171	52-0828	21"	2.15"
52-0895	—	21"	3.00"
1984-99 FXR-FXD with single disc, fits 35mm and 39mm forks.			
52-0190	52-0192	19" Drop Center	2.50"
52-0191	52-0193	21"	2.15"
52-1024		23"	3.00"
2000-2003 FXD with single disc forks, FXD, FXDL with 39mm forks single or dual disc. .750" axle.			
52-1086	52-1087	19" Drop Center	2.50"
52-1088	52-1089	21" Drop Center	2.15" Dual Disc only
52-2023	52-2024	21" Drop Center	2.15"
52-1212		23"	3.00"
2004-05 FXD with single or dual disc 39 mm for FXD, FXDL with 1" axle.			
52-2000	52-2001	19" Drop Center	2.50"
52-2002	52-2003	21" Drop Center	2.15"
52-1211		23"	3.00"



**60 Spoke Billet Hub Wheel Assemblies** feature chrome plated billet hub. Polished stainless spokes and chrome rim.

VT No.	Fits	Size
52-0657	1986-99 FXST	16" x 3.50"
<b>Front Wheels</b>		
52-0733	1984-99 FXD-XL	19" x 2.15"
52-0734	2000-03 FXD	19" x 2.15"
52-0139	1984-99 FXST	21" x 2.15"
52-0737	2000-07 FXST	21" x 2.15"
52-0658	1986-99 FLST	16" x 3.50"





# Rear Wheel Rim



**Drop Center Chrome Rims** feature drop center design for bead and 40 spoke holes. All are chrome unless noted. Note: Large hole accepts rubber valve stem tube. Small hole accepts metal stem tubes.

VT No.	Width	Brand	52-0230	3.0"	Perma Chrome (CV)	52-0707	2.5"	V-Twin
52-0226	3.0"	Perma Chrome	52-0222	3.0"	Perma Chrome	52-0229	4.25"	Perma Chrome
52-0699	3.0"	As Above Raw	52-1023	3.0"	Black Gloss	<b>17" Rim with Center Hole</b>		
52-0692	3.0"	Black Gloss	52-0691	3.5"	Perma Chrome	52-0435	4.5"	Perma Chrome
52-0223	4.0"	V-Twin	52-0228	4.5"	Perma Chrome	52-0896	6.0"	Perma Chrome
52-0303	4.0"	Replica	52-0430	5"	Perma Chrome			
52-0381	4.0"	V-Twin						

# Front



**Replica Drop Center Front Rims.**  
2.50" x 19"

Chrome	Black	OEM	Brand
52-0700	52-0234	43018-73	Perma
52-0713		43018-73	DW
52-0752		43001-06	Perma

**21"**  
52-0748 52-1208 2.15"  
52-0788 3.25"  
**80 Spoke Chrome Rim Only**

52-0212	1.85" x 21"
52-0703	3.0" x 16" with large stem hole
52-0704	3.0" x 16" with small stem hole
52-0705	4.0" x 16" with large stem hole



**Conventional Chrome Rims** are flat style. Fits front tires only and has 40 holes.

VT No.	Diameter	Width
52-0202	19"	1.85"
52-0203	21"	1.85"
52-0208	18"	2.15"



**Spoke Thread Protector Sleeves** fit over spoke threads during assembly to avoid damage to rim during lacing.

VT No. 28-0722



**Front Chrome Rim and Spoke Kits** fit hubs as noted.

VT No.	Size	Hub
52-0300	3.00" x 16"	Steel
52-0301	2.50" x 19"	Alloy
52-0302	1.85" x 21"	Steel



**Front Smoothie Wheel Rims** feature a smooth profile with chrome on aluminum construction.

VT No.	Size
52-0790	16" x 3.0"
52-0791	21" x 2.15"



**Deluxe Chrome Front Wheel Rims** are roll formed of high strength steel and finished with a deluxe chrome finish. Both are drop center style with the rolled-edge design for added strength.

VT No.	OEM	Size
52-0702	43001-79	19" x 2.50"
52-0701	43662-80B	21" x 2.15"
52-0748	Replica	21" x 2.15"
52-1291		23" x 3.00"



All Rims are 40 hole. \*Except where noted.

# Wheel Rims



16"				
Chrome	Black	Width	Brand	Note
52-0226		3.00"	Perma Chrome, large	Drop Center
52-0699		3.00"	As Above, large valve stem	Raw Finish
	52-0692	3.00"	Black Gloss, large side stem	43006-40
	52-1023	3.00"	Black Gloss, Small Side Stem	Drop Center/2010-up XL
52-0230		3.00"	Perma Chrome Small Center Valve	43085-97 Drop Center, 8.5 mm
52-0222		3.00"	Perma Chrome, small	43085-81
52-0703		3.00"	With large stem hole	
52-0704		3.00"	With small stem hole	
52-0300		3.00"	Steel, small	
52-0379	52-0376	3.00"	Police Wheel Rim	43006-62
52-0691		3.50"	Perma Chrome	
52-0223		4.00"	V-Twin, large 8.5mm side valve stem hole	Drop Center
52-0303		4.00"	Replica, large	Drop Center
52-0381		4.00"	V-Twin, large	Drop Center
52-0705		4.00"	with large stem hole	
52-0228		4.50"	Perma Chrome, 2010 XL	Drop Center
52-0430		5.00"	Perma Chrome	Rim is for use w/180-200 rear tire
52-0433	52-0434		Replica Kelsey Hayes	
17"				
52-0435		4.50"	Center Hole, 40863-06	2006-up FXD
52-0896		6.00"	Center Hole, 41440-08	2008-up FXD
18"				
52-0027		2.15"		
52-0208	52-0234	2.15"	Front Conventional	
52-1018		2.15"	Steel/Chrome	1952-56 K
	52-0785	2.15"	Black Powder	
52-0707		2.50"	V-Twin w/Center Hole	
52-0025		2.50"	WM2	Alloy
	52-0768	3.15"	Black Powder	
52-0229		4.25"	Perma Chrome	
19"				
52-0202		1.85"	Conventional	Flat style and for front fitment
52-0026		2.50"		
52-0028		2.15"		
52-0977		2.15"	Original Style Edge, XL 1964-1972 Front fitment with drum brake, FX 1971-1972 Front fitment with drum brake	
	52-1209	2.15"	Rolled type edge	
52-0700	52-0234	2.50"	Perma Chrome	43018-73, 1973-up XL
52-0713		2.50"	DW	43018-73
52-0752		2.50"	With Drop Center Hole	43001-06
52-0301		2.50"	Alloy	
52-0977		2.50"	Drop Center/Chrome	1964-72 XL
52-0965		2.50"	Steel/Chrome	1964-72 XL
52-0702		2.50"	Drop Center w/center valve	43001-79
52-0969		3.15"	Steel/Chrome	1952-56 XL
21"				
52-0212		1.85"	80 spoke holes	
52-0302		1.85"	Steel	Rim and Spoke Kit
52-0203		1.85"	Front Conventional	
52-0701		2.15"	43662-80B	Drop Center
52-0748	52-1208	2.15"	Replica	High strength steel
52-0788		3.25"	Center valve hole is 8.5mm.	
23"				
52-1291		3.00"		1980-up FLT, 1984-up FXST.







# Softail Bucket Saddle



**CG Fringed Solo** fits 1984-05 Softail. VT No. 47-2022



**Classic**



**Fringe**

**CG Frame Mount Solo Seats** for 1984-2005 are constructed of black Naugahyde on steel base plate for frame mounting without springs.

VT No.	Style
47-8721	Classic
47-8680	Sonora
47-2022	Fringe

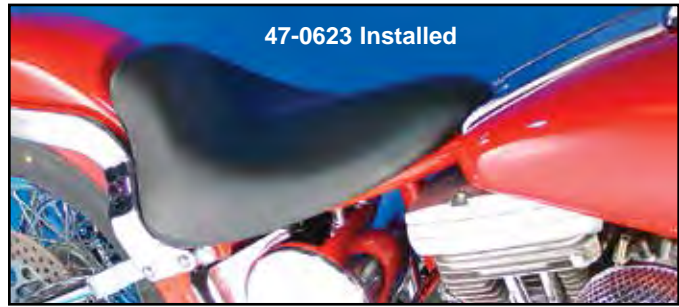

47-0623 Installed

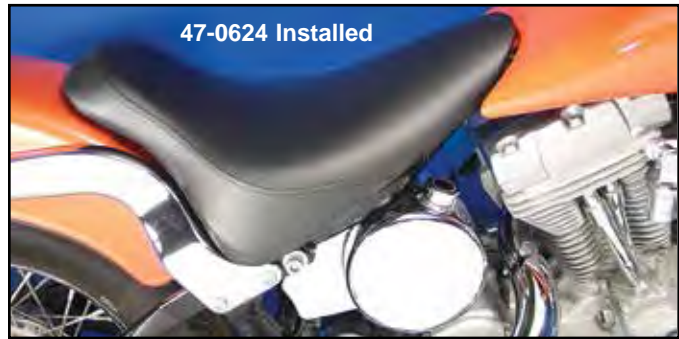

47-0624 Installed



**CG Leather Solo Saddle** for 1984-99 FXST. VT No. 47-0659



47-0623



47-0624



47-2028



47-2026

**Victory Gunfighter Saddles** feature sewn inlay of colored flames on rear pad area with matching flame stitch and thread in front driver area.

2000-05	1984-99	Style/Color
47-2024	47-0588	Teal Flame
47-2028	—	Blue Flame
47-2029	47-0580	Aqua Flame
47-2030	—	Purple Flame
47-2026	47-0565	Orange Flame



47-0630 Installed



47-0630



**Butt Bucket Saddle** fits Softail models. Seats include brackets for direct frame mounting.

VT No.	Year
47-0623	1984-99
47-0624	2000-05
47-0630	2006-14
47-0645	2006-14 Wyatt



47-2005

**Victory Design Originals** by Corbin-Gentry with button detailing.

2000-05	1984-99	Style
47-2005	47-2005	MK I

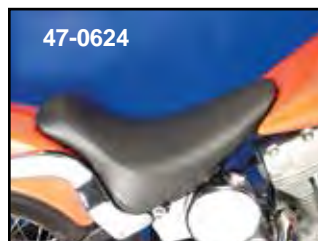

47-0624



47-0630

**Victory Series Saddles** fit 1984-up FXST-FLST models and all Rigid frames. FXST-FLST models require re-use of existing rear tab or can be ordered separately, VT No. 31-0413 for 1984-99 or 31-0653 for 2000-up and Rigid models.

**Victory Series Saddles** fit 1984-05 FXST-FLST models and all Rigid frames. FXST-FLST models require re-use of existing rear tab or can be ordered separately, VT No. 31-0413 for 1984-99 or 31-0653 for 2000-up. Rigid frames require purchase of 31-0562 front mount.

# FXDWG models



BIG TWIN



Wyatt Solo Bucket Saddle fits FXDWG.  
 VT No. Year  
 47-0910 1996-2005  
 47-0603 2006-up



## Victory Series for 1984-05 FX-FLST & Rigid

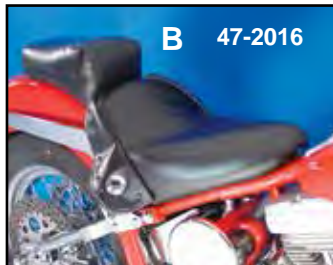

Victory Series Saddle fits 1984-05 FXST-FLST models and all Rigid frames. FXST-FLST models require re-use of existing rear tab or can be ordered separately, VT No. 31-0413 for 1984-99 or 31-0653 for 2000-05 models. Rigid frames require purchase of 31-0562 front mount.

CG Saddles to fit Softtail models. Order rear seat tab assembly separately.

VT No.	Year	Type
47-0987	2007-06	Smoothie
47-0996	1986-05	Smoothie
47-0776	2007-up	Cobra
47-0777	2007-up	Touring Bucket
31-0653		Rear Seat Tab Assembly

All Corbin-Gentry Saddles are constructed on a metal baseplate, have a high density molded foam cushion and are covered in premium Naugahyde unless noted as leather.

Victory Smoothie Saddle is a two piece design on a single steel baseplate.

2000-05	1984-99	#	Note
47-2015	—	A	Concho, chrome spots
47-2016	47-8725	B	Concho, black spots
47-2017	47-8695	C	Fringe, chrome spots



Rubber Seat Bumper Pad Set fits most seats where they rest on the frame to protect the paint. Includes 4 rubber self stick pads.  
 VT No. 31-0374





# Seat Mount Hardware



**Chrome Billet Rear Set Tab** features contoured rear shape, screw included. Kits sit where rear tab is fastened by two screws.

**VT No. 31-0767**



31-0660



31-0653



31-0661



31-0652

**Chrome Rear Seat Tab** includes chrome spring loaded screw. Order fender nut insert separately.

VT No.	Item	Year	Thread
31-0660	Tab	1982-up	1/4" - 20 UNC
31-0661	Tab	1982-up	1/4" - 28 UNF
31-0653	Tab Assembly	2000-up	
31-0652	Nut Insert, 4 pack		



**Seat Bracket Mounting Washers.** Nylon 1/4" inner diameter by 9/16" outer diameter, 1/16" thick for 1982-up models to prevent seat bracket from scratching fender. Pack of 25.

**VT No. 37-8858**



**Rear Seat Tab Screw Kit** includes 1/4 - 20 UNC and 1/4 - 28 UNF threaded knobs and tab cover.

**VT No. 37-1513**



B

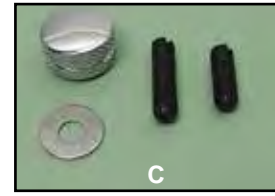

C

**Seat Mount Pins** available as quick release push pin in stainless steel or knurled aluminum in chrome or natural finish with O-Ring and extra stud. Thread into existing seat mount hole with 1/4" - 28 UNF threads. Replacement pin available for VT No. 37-8902.

VT No.	#	Type
37-8902	B	Quick Release with Pin
37-9179	C	Chrome Knob

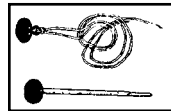

**Black Button Set** with clips, for repairing or installing on custom seats. Set of six.

**VT No. 47-0602**



31-4018



31-0413

**Chrome Seat Mount Tab.** When installing a one piece seat on 1981-84 FXR models, use VT No. 31-4017. Use 31-4018, on 1979-up XL seats. VT No. 31-4013 fits FXWG-FXE-FXST 1973-up rear. Use nylon washer under seat tab.

VT No.	Fits
31-4018	Rear FXR
31-0413	Rear FXE-FXWG
37-8858	Nylon Washer, 25 Piece

## Hardware for FLST

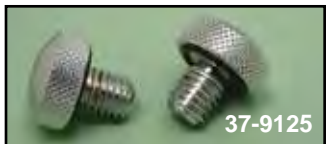

37-9125

**FXST-FLST Seat Tab Knurled Screw Sets** are available with 1/2 - 13 UNC. Screw into frame forward of strut mount. Includes O-ring for snug fit.

**VT No. 37-9125**



**Seat Mount Kit** consists of chrome plated buttonhead hardware and lockwashers for 1987-up Heritage FLST and Fat Boy.

**VT No. 9915-4**



37-0539

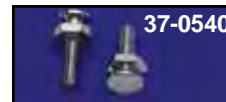

37-0540

**Chrome Seat Mount Bolts** for FXR and Road King secure rear of solo. Seat rod holds front of passenger pad firmly in place and allows quick passenger pad removal.

VT No.	Thread	Fits
37-0539	5/16 - 24 UNF	1994 FLHR, 1982-89 FXR
37-0540	5/16 - 18 UNC	1995-up FLHR



# Saddlebag Hardware

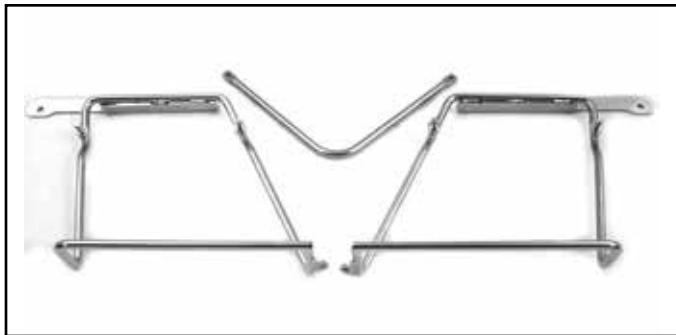

**Saddlebag Bracket Set** includes left and right brackets with rear saddlebag stabilizer bracket for fiberglass saddlebags. Saddlebag bracket set, bottom rail extends out 3½" measuring to the center of the rail. Fits saddlebags that have underneath groove. Fits 1986-up FLST only.

VT No. 49-2752

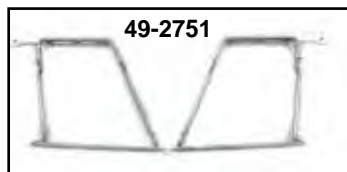

49-2751



49-2542

**Saddlebag Mount Kit.** Adapts VT No. 49-2521 fiberglass bag set to FXST-FLST models 1986-05. Instructions included. Saddlebag mounting bracket is not included with mount kit use 49-2752 for customers who have bags without brackets. Requires turn signal bracket 31-4006 for use.

VT No.	Year	Finish
49-2751	1986-05	Chrome
49-2542	1986-05	Zinc
49-0462		Bracket Zinc

Fiberglass Saddlebag Rivets, pack of 50.			
VT No.	OEM	Length	
37-0566	90965-63	5/16"	
37-0567	90966-67	1/4"	
37-0568	90967-64	3/8"	



31-9913



31-9986

**Directional Signal Relocation Kits** includes special hardware and extension for models listed to provide clearance for saddle bags.

VT No.	OEM	Fits
31-9913	90504-82A	1982-89 FXR
31-9986	68548-87	1986-up FXST-FXSTS



**Caliper Guard** mounts to axle and keeps saddlebags out of wheels on 1986-up Softail, zinc plated.  
VT No. 48-0177

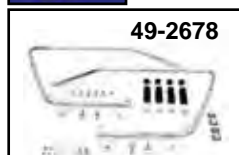

49-2678

**Wyatt Gatling Saddlebag Kit** includes set of chrome saddlebag adapter brackets for quick release mounting, four bail head studs, four receptacles, four cushions, four grommets, and mounting hardware for the left and right side saddlebags. Fits 1984-up FXST, 1986-up FLST.

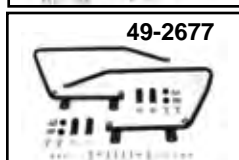

49-2677

VT No. Finish  
49-2677 Black  
49-2678 Chrome



31-9916



31-9917



31-0967



31-0968

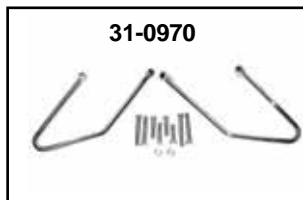

31-0970



31-9912

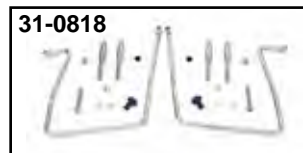

31-0818

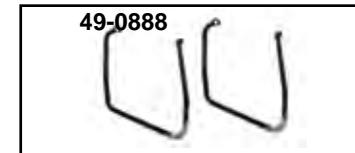

49-0888



49-0889



31-0361

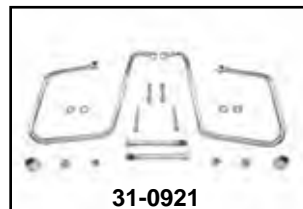

31-0921

**Chrome Saddlebag Supports** are designed to fit the contour of the fender struts and protect your bags from the brake caliper and swing arm.

VT No.	Bolt	Year	Model
31-9916	2	1984-99	FXST, FLST
31-0361	2	1984-99	FXST
31-9917	1	1984-99	FXST, FLST
31-0967	2	2000-05	FXST, FLST
31-0968	1	2000-up	FXST, FLST
31-0970	2	2006-10	FXST, 2007-up FLSTF
31-9912*	2	1982-94	FXR
31-0818	2	1991-07	FXD
		1996-up	FXDWG
49-0888	2	All	Black
49-0889	2	All	Chrome
31-0921	2	2008-up	FXD

\*Note: 1982-89 models require VT No. 31-9913 relocation kit.





# Windshield



**Deflector Screen LX** features rake adjust and quickset hardware. Super tough Lexan hardcoated polycarbonate. Light or medium tint. DOT and TUV approved. Hardware packaged with windshield.

**VT No. 51-0244** Medium Tint

**VT No. 51-0245** 1982-94 FXR  
Light Tint 1993-up FXD  
**Size:** 1984-up FXST  
**H:** 14<sup>3</sup>/<sub>4</sub>" 1993-up FXDWG  
**W:** 15" 1989-up FXSTS  
**Fits all:** 1994-up FLHR  
1986-up FLST



**Flyscreen LS** by National Cycle features Lexan coating and bronze tint. Enhances the front end of your bike and is made from durable high impact acrylic material. Includes triple chrome front trim plate and flush countersunk hex bolts which offers a custom fit for motorcycles with open front ends. The bronze tint is light enough to allow the motorcycle details to show through. Hardware included.

**VT No. 51-0243**

**Fits all:**  
1982-94 FXR  
1993-up FXD  
1984-up FXST  
1993-up FXST  
**Size:**  
**H:** 8<sup>1</sup>/<sub>2</sub>"  
**W:** 9.75"

# Streetshield



**Streetshield Ex** features 4 point ball socket mount with Quikset hardware. DOT approved.

**Size**

**H:** 18"  
**W:** 19<sup>1</sup>/<sub>4</sub>"

**VT No. 51-0325** Smoke

**Fits all:**  
1982-94 FXR  
1993-up FXD  
1984-up FXST

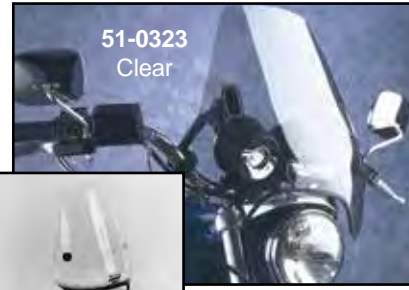

51-0323  
Clear

**Streetshield** is contoured to enhance wind protection. Features 4 point ball socket mount. DOT and TUV approved. Hardware packaged with windshield.

**Size:**  
**H:** 17"  
**W:** 16<sup>1</sup>/<sub>2</sub>"

**VT No. 51-0323** Clear  
**51-0324** Smoke



51-0294

**FXSTS Windshield** is trimmed with mechanically-applied traditional beaded lock. The highly polished chrome mounts attach to the handlebar risers to provide significant clearance for rake and height adjustment. Fits 1989-up FXSTS.

**Size:** H: 13.25", W: 20", Overall Height: 21"  
Clear DOT approved. Hardware packaged with windshield. Custom mount to handlebar risers.

**VT No. 51-0294**



**Fits all:**  
1982-94 FXR  
1993-up FXD  
1984-up FXST



**Lexan Shield** fits 1991-05 FXD with 39mm forks.  
**VT No. 51-0200**

# Toolboxes



50-0600



50-0605



50-0601



50-0603



48-0570



50-0604



50-2025  
installed

**Replica Oval Toolboxes** are for right side use and include keys, VT No. 48-3094 is a leather pouch insert for oval tool boxes. Tools not included.

VT No.	Finish	Side
50-0600	Chrome	Right
50-0605	Chrome	Left
50-0601	Black	Right
48-0570		Liner
50-0603	Key set	
16-1007	Kit	Tool,
		1989-up FXST, FLST



50-2025

Order 27-0861 relocated foot peg brackets separately.

**FXST-FLST Toolbox Kit** is chrome ribbed. Includes two keys, mount bracket, footpeg spacer and hardware.

VT No.	Item
1984-99	
50-0604*	Right Side Kit
50-1012	Left Side Kit

\*Note: Fits all 1984-99 FXST models except FLSTF and FLSTN.

2006-up FXD, FXDWG  
50-2025 Right Side

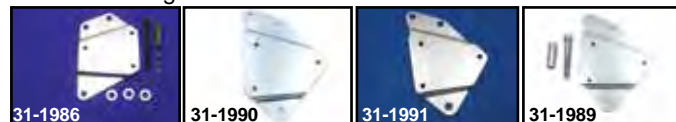

31-1986

31-1990

31-1991

31-1989

**Brackets Only for Toolbox** mounting on 1984-99 Softails.

VT No.	Kit	Side
31-1986	Kit	Right
31-1992	Bracket	Right
31-1990	Bracket	Right (1986-99)
31-1991	Bracket	Left
31-1989	Kit	Left



# Windshield



Switch Blade Removable Windshield allows installation or removal in four seconds without tools. Available in three sizes for three styles of riding and features 4.0 mm Lexan Polycarbonate with quantum coating in either clear or tint. Also features a key lock for "lock solid" mounting. Order mounting system separately.

SwitchBlade® Quick-Release Windshields Applications										
Model Name	Year	Mount Kit	2-up Clear	Chopped Clear	Chopped Tint	Shorty Clear	Shorty Tint	Deflector Clear	Deflector Tint	
<b>FX NARROW GLIDE MODELS with 39mm Fork Tubes FXD/FXDL/FXDX/FXDC Dyna</b>										
FXD Super Glide	1993-05	31-9936	51-0331	51-0354	51-0359	51-0332	51-0333	51-0334	51-0335	
FXDL Dyna Convertible	1994-00	31-9936	51-0331	51-0354	51-0359	51-0332	51-0333	51-0334	51-0335	
FXLR Low Rider Custom	1988-94	31-9936	51-0331	51-0354	51-0359	51-0332	51-0333	51-0334	51-0335	
FXR/FXRS Low Rider	1982-94	31-9936	51-0331	51-0354	51-0359	51-0332	51-0333	51-0334	51-0335	
<b>FX NARROW GLIDE MODELS with 49mm Fork Tubes</b>										
FXD Super Glide	2006-10	31-9947	51-0352	51-0357	51-0362					
FXD 35th Anniversary Super Glide	2007	31-9947	51-0352	51-0357	51-0362					
FXDC Super Glide Custom	2006-14	31-9947	51-0352	51-0357	51-0362					
FXDB Street Bob	2006-15	31-9947	51-0352	51-0357	51-0362					
FXDL Low Rider	2006-09	31-9947	51-0352	51-0357	51-0362					
FXDL Low Rider	2014-15	31-9947	51-0352	51-0357	51-0362					
<b>FX WIDE GLIDE MODELS with 41mm Fork Tubes</b>										
FXDWG Dyna Wide Glide	1993-05	31-9937	51-0336	51-0355	51-0360		51-0338	51-0339	51-0340	
FXWG Wide Glide	1980-85	31-9937	51-0336	51-0355	51-0360		51-0338	51-0339	51-0340	
FXDG Glide	1983	31-9937	51-0336	51-0355	51-0360		51-0338	51-0339	51-0340	
<b>FX WIDE GLIDE MODELS with 49mm Fork Tubes</b>										
FXDWG Dyna Wide Glide	2006-16	31-9947	51-0353	51-0358	51-0363					
<b>FXST MODELS</b>										
<b>Softail</b>										
FXCW Rocker/Rocker C	2008-11	31-9947	51-0352	51-0357	51-0362					
FXST Softail Standard	1984-90/ 1999-12	31-9937	51-0336	51-0355	51-0360		51-0338	51-0339	51-0340	
FXSTB Softail Night Train	1999-09	31-9937	51-0336	51-0355	51-0360		51-0338	51-0339	51-0340	
FXSTC Softail Custom	1987- 99/07-10	31-9937	51-0336	51-0355	51-0360		51-0338	51-0339	51-0340	
FXSTD Softail Deuce	2000-07	31-9937	51-0336	51-0355	51-0360		51-0338	51-0339	51-0340	
<b>FLS MODELS</b>										
<b>Softail (Without Light Bar)</b>										
FLS Softail Slim	2012-15	31-9939	51-0341					51-0344	51-0345	
FLST Heritage Softail	1986-90	31-9939	51-0341					51-0344	51-0345	
FLSTC Heritage Softail Classic	1987-16	31-9939	51-0341					51-0344	51-0345	
FLSTF Fat Boy	1990-16	31-9939	51-0341					51-0344	51-0345	
FLSTFB Fat Boy Low/Fat Boy Special	2010-16	31-9939	51-0341					51-0344	51-0345	
FLSTFBS Fat Boy S	2016	31-9939	51-0341					51-0344	51-0345	
FLSTN Softail Deluxe**	2005-16	31-9939	51-0341					51-0344	51-0345	
FLSTN Heritage Softail Nostalgia	1993	31-9939	51-0341					51-0344	51-0345	
FLSTN/H Heritage Softail Special	1994-96	31-9939	51-0341					51-0344	51-0345	
FLST Heritage Softail	2006	31-9938	51-0341					51-0344	51-0345	
FLST Heritage Softail	1986-90	31-9938	51-0341					51-0344	51-0345	
FLSTC Heritage Softail Classic	1987-16	31-9938	51-0341					51-0344	51-0345	
FLSTF Fat Boy	1990-16	31-9938	51-0341					51-0344	51-0345	
FLSTFB Fat Boy Low/Fat Boy Special	2010-16	31-9938	51-0341					51-0344	51-0345	
FLSTFBS Fat Boy S	2016	31-9938	51-0341					51-0344	51-0345	
FLSTN Heritage Softail Nostalgia	1993	31-9938	51-0341					51-0344	51-0345	
FLSTN(H) Heritage Softail Special	1994-96	31-9938	51-0341					51-0344	51-0345	

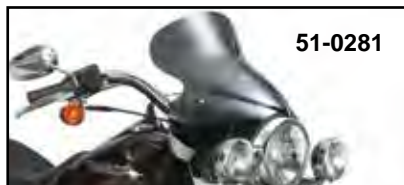

51-0281

National Cycle Wave QR Windshield manufactured from dark tint polycarbonate that features free flowing lines, adjustable rake partitioning and quick release mounting. Order mounting hardware separately.

VT No.	Fits	Mounting Hardware
51-0280	2006-up FXD	31-9947
51-0281	1994-up FLHR	31-9946
51-0282*	1986-up FLST	31-9939

\*Note: Will not work with spotlight bar

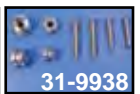
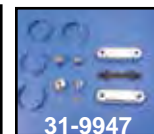

National Cycle Spartan Quick Release Windshield features a full size quantum clear hand coated polycarbonate windshield, quick release hardware and a black powder coated mounting frame. Available in 16 1/4" and 18 1/2" heights. Height is measured from head lamp cutout to top of shield.

VT No.	Height	Fits	Mounting Hardware
51-0284	16 1/4"	1986-up FLST	31-9939*
51-0285	16 1/4"	2006-up FXD	31-9947
51-0286	18 1/2"	1986-up FLST	31-9939*
51-0287	18 1/2"	2006-up FXD	31-9938

\*Note: When installing shield with spotlight bar use 31-9938 kit





# Beaded Shield

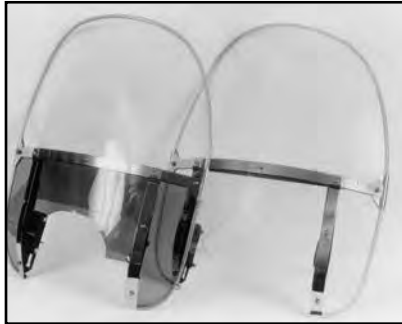

**Beaded Heavy Duty Windshield** feature classic three piece construction. Crystal clear upper with a clean beaded edge. Size: H: 19¼" to 22¼" W: 22½" Clear Top, Colored Lower, DOT approved. Hardware sold separately.



**VT No. Color**  
**51-0239** Clear  
**51-0251** Black

**Fits all:**  
1984-up FXST  
1993-up FXDWG  
1986-up FLST  
1990-up FLSTF  
1993-up FLSTN

**Mount Kit Required**  
**31-9932**  
**31-9932**  
**31-9934**  
**31-9934**  
**31-9934**



**Chopped Heavy Duty Windshield** features wide screen look with low profile. A preferred choice for many. Size: H: 14½" to 17¼" W: 22½" Light Tint. DOT and night use approved. Hardware sold separately.

**VT No. 51-0300**  
**Fits all:**  
1984-1990 FXST  
1999-2007 FXST  
1993-2005 FXDWG  
1986-1990 FLST  
1986-1990 FLST  
1990-2008 FLSTF  
1993-up FLSTN  
**VT No. 51-0302**

**Mount Kit Required**  
**31-9932**  
**31-9932**  
**31-9932**  
**31-9934**  
**31-9934**  
**31-9934**  
**Mount Kit Required**



**Touring Heavy Duty.** Maximum protection on the road. A great look on a large cruiser. Size: H: 19½" to 22½" W: 22¼" Light Tint, DOT approved. Approved for night use. Hardware sold separately.

**VT No. 51-0242**  
**Fits all:**  
1984-up FXST  
1993-05 FXDWG  
1993-up FLST  
1990-up FLSTF  
1993-up FLSTN  
1993-up FLHS

**Mount Kit Required**  
**31-9932**  
**31-9932**  
**31-9934**  
**31-9934**  
**31-9934**  
**31-0438**



50-0726

**Chrome Wind Deflectors** mount onto fork brackets.

**VT No. Year Fits**  
**50-1008** 1983-up FLHT/FLHR  
**50-1067\*** 1986-up FLST  
**50-0724** 1986-up FLST, Black  
**50-0726** 1986-up FLST, Chrome

**\*Note:** Can only be used with king size windshields or spotlamp bracket.



51-0418



51-0419

**FLSTC Replacement Polycarbonate Shield** features pre-drilled mounting holes for use with stock mounting hardware and is 33% thicker than original windshield Available in 20" tall clear or 13¾" tall dark tint. Fits 1995-up FLSTC.

**VT No. Height Color**  
**51-0418** 20" Clear  
**51-0419** 14¼" Dark Tint  
**51-0364** FLST Light Tint



**Chrome Tie Down Brackets.** These chrome tie down brackets mount to the front fork cover and provide a secure point to attach tie downs. Fits 2000-up FLST and 1995-up FLH.

**VT No. 31-0025**



# Luggage Rack for Softails



BIG TWIN



50-1001  
Installed

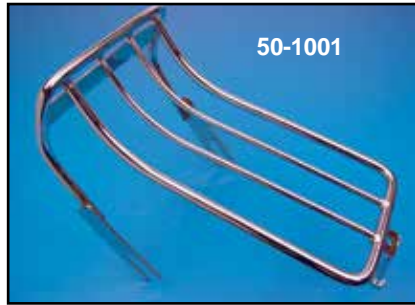

50-1001

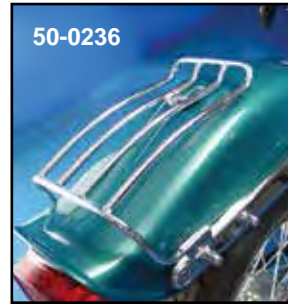

50-0236

**Note: Racks are designed for loads of 10 pounds or less!**



50-0232



50-1101



50-0989

**Chrome FXST Luggage Racks** fit models fitted with a bobbed rear fender.

VT No.	Year	Size
50-1001	1980-99	11" x 5"
50-0236	1984-99	11½" x 6"
50-0232	2000-04	11½" x 6"
50-1101	2000-02	11½" x 5"
50-0989	2000-05	12" x 4½"
50-2071	2006-up	11½" x 6"
50-0040	2000-up	11" x 7"



50-2071  
Installed

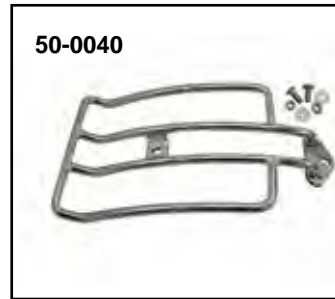

50-0040



50-1014  
Installed

**Chrome Three Channel Luggage Racks** in classic style of the 1960's. Fits FXST-FLST except FLSTS.

VT No.	Year
50-1014	1986-06
50-1209	2000-06
50-2080	2007-up
37-0978	Bolt Set

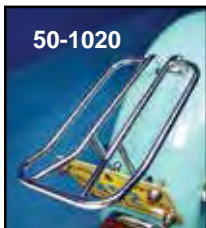

50-1020



50-1020

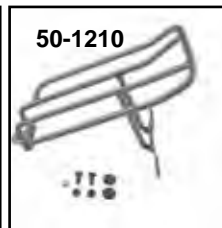

50-1210



47-2523



49-2523

**Luggage Rack Pad** measures 12¾" x 9" with quick release spring loaded clamps to fit three channel stock luggage racks.

VT No.	Item
47-1974	Pad Kit
49-2523	Clamp Set

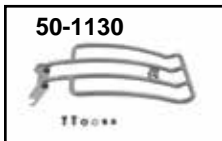

50-1130

FLST	Year	Size
50-1020	1986-2005	10.5" x 6" (Chrome)
50-1210	2006-2010	10.5" x 6"
FLSTF	Year	Size
50-1130	2005-up	10.5" x 6" FLSTF



49-0304



49-0951



49-0832

**Old Style Luggage Rack** is a replica of 1940's accessory, contours all rear fenders. Great for attaching thro-over saddlebags. Does not interfere with post mounted buddy or police solo seats. Size 11" x 7¾".

VT No.	Finish
49-0304	Polished
49-0951	Chrome Replica
49-0832	Black
37-2096	Chrome Screw, 5 pack

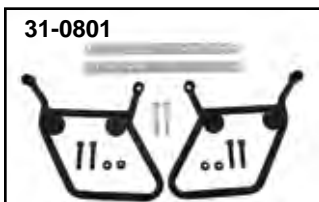

31-0801

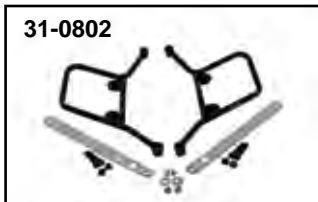

31-0802

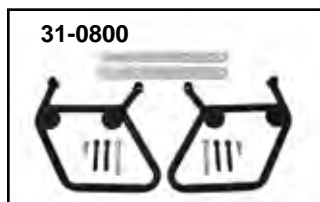

31-0800

**National Bubble Saddlebag Hardware Kit.**

VT No.	Fits
31-0801	1991 FXD
31-0802	1984-2008 FXST, 1986-1990 FLST, 1987-2008 FLSTC
31-0800	1994-up XL



**Black Saddlebag Supports** are designed to fit the contour of the fender struts and protect your bags from brake caliper and swingarm. Supports are 2 bolt type.

VT No. 31-1571





# Luggage Rack

Note: Hardware Included where pictured.

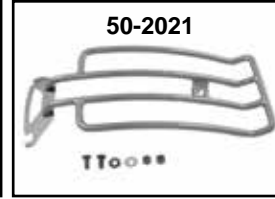

**Contour Fender Racks** feature steel construction for use with solo seats for loads of 10 pounds or less.

VT No.	Year	Model	Rack Size
50-0233	1991-2004	FXD	9½" x 6"
50-0234	1993-2005	FXDWG	11" x 6"
50-0990	2006-up	FXDWG	10½" x 5¾"

**Chrome Luggage Racks** are fender mounted for loads of 10 pounds or less.

VT No.	Fits	Rack Size
50-1019	1982-94 FXR 1976-85 FXE	9" x 6"
50-1107	2002-05 FXDWG	9½" x 5½"
50-2023	1991-05 FXD	9" x 6"
50-2076	2006-10 FXD	9" x 6"
50-1098	1991-01 FXDWG	9½" x 5"
50-1529	2006-up FXD	
50-1130	2005-up FLST	11" x 6"

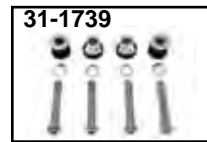

**Docking Mount Kits.**  
31-1739 2006-08 FXWG  
31-1740 2009-up FXD

Note: Racks are designed for loads of 10 pounds or less!

## LEATHER Saddlebag



**Saddlebags** are x-large three buckle thro-over available in black only. Measures 14½" Long x 6" Wide x 12" High. VT No. 48-3127



**Black Genuine Leather Conchos** feature nickel plated disc with leather tails. Sold in a 5 pack. VT No. 48-0122



**Nickel Spoons** for dress up or replacement on saddlebags. Sold in pairs. VT No. 37-8927



**Universal Saddlebag Kit** with random key code for use with vinyl or leather soft side saddlebags. VT No. 49-1420



**Chrome Star Washers** for dressing up seats and saddlebags. Sold in a 10 pack.

VT No.	Item
37-1954	Stars (A)
37-0501	Krommets (B)



**Saddlebags** are large three buckle thro-over style. All bags are glued, sewn and riveted. Available black only. Measures 13" Long x 5" Wide x 12" High.

VT No.	Type
48-3128	Standard
48-3133	FXST

# Classic 1915-1983 Index

<b>A</b>	
ADVANCE UNIT.....	671,672
AIR CLEANER.....	707-712
Velocity Stack.....	707
AIR FILTER.....	707,708,709,710,711,712
ALLEN SCREW LIST.....	1319
<b>ALTERNATOR</b>	
Cover/Housing.....	700
Conversion Kit.....	698-699
Ring Replacement.....	1263
AXLE.....	773-775
<b>B</b>	
BACKREST.....	648
BAFFLE.....	668
BATTERY.....	699,703-706
Box.....	699,700
Cable.....	705
Carrier.....	703
Cover/Side/Top.....	704
Eliminator.....	697
Terminal Hardware.....	706
<b>BEARING</b>	
Ball.....	505
Cam.....	508-509
Fork Stem.....	617
Speed Mainshaft.....	544
Inner Primary.....	760
Pinion.....	499
Rod.....	496-499
Throw Out.....	560
Wheel.....	781
BELT BUCKLE.....	1325
<b>BELT DRIVE</b>	
Belt.....	568,569,570
Drive Kit.....	568-570
Pulley.....	570
BIKE KITS.....	639-641
BOLT LIST.....	1319
BOOKS.....	1268-1270
<b>BRAKE</b>	
Cable.....	604
Caliper Front.....	594,598,599
Caliper Rear.....	594,595,596,597
Caliper Rebuild.....	597-598
Caliper/Wheel Kit.....	594
Disc.....	594,595,598,599,600,601
Drum.....	584,585,588,603
Drum Sprocket Service.....	1263
Fittings/Bolt.....	591
Forward Controls.....	578,579,582,583,586,587
Glide.....	603
Hose.....	590
Hydraulic.....	588
Lever.....	580
Line.....	590,591,592,593
Master Cylinder(Front).....	1052,1053
Master Cylinder(Rear).....	583,589
Mechanical.....	585
Pad.....	602
Pedal.....	583-585
Pedal Pad.....	573,583-585
Rivet.....	566,690
Rotor.....	594,595,598,599,600,601
Shoe/Spring.....	578,584,608
Sprocket(Rear).....	566
Swingarm Brake Kit.....	595
Switch.....	583,590
Tee/Tube.....	592
<b>BREATHER</b>	
Valve Machining Service.....	1264
BUMPER.....	626
BUSHING LIST.....	1307
<b>C</b>	
<b>CABLE</b>	
Battery.....	705
Brake.....	604

<b>CABLE CONTINUED</b>	
Carburetor.....	715
Choke.....	728
Clamp.....	689,729
Clutch.....	726
Heat Shrink Wrap.....	728
Spark Plug.....	728
Speedometer.....	729,730
Throttle.....	724,725,728
Wire Loom Clip.....	689
Wrap(Chrome).....	725
CALIPER.....	594-599
Rebuild.....	597-598
CAM.....	506-511
Bearing.....	501
Bushing(OHV).....	509
Bushing Replace Service.....	1264
Chest Kit.....	506
Cover.....	506
Gasket/Sealer.....	507,1309
<b>CAPS</b>	
Axle.....	776
Chrome.....	731
Gas.....	732,1202-1204,1235
Hub.....	776
Oil.....	748
CARBURETOR.....	698-723
Bendix.....	720
Cable.....	719,725,727
Dell'Orto.....	720
Intake.....	721-722
Jet.....	719,720
Keihin.....	719
Linkert.....	713-716,717,718,721,722
Linkert Rebuild Service.....	1263
Manifold.....	721-722
Mikuni.....	719,723
S&S.....	711
SU.....	719
Tillotson.....	715
CASE.....	492-493
Case Boring Service.....	1263
Race/Rollers.....	499
Seals.....	498
<b>CHAIN</b>	
Adjuster(Rear).....	774
Adjuster(Primary).....	563
Diamond.....	564
Drive System.....	564
Guard.....	632
Masterlink.....	1055
Oiler.....	764
Primary.....	563
Tensioner.....	563
Tsubaki.....	1054
CHAINGUARD.....	632
CHOKE CABLE.....	728
CIGARETTE LIGHTER.....	1031
CIRCUITBREAKER.....	693
<b>CLAMP</b>	
Cable.....	689,728
Exhaust.....	667
Hose.....	1200,1201
Intake Manifold.....	724
CLEANER.....	1271
<b>CLUTCH</b>	
1941-E1984 FL-FX.....	556
Cable.....	725
Collar.....	558
Control(Handle).....	1041-1051,1052
Drum.....	557
Hub.....	558
Jockey.....	573,574,575,576
Kevlar.....	559
Lever.....	561,726
Mousetrap Eliminator.....	561
Pack Kit.....	557

<b>CLUTCH CONTINUED</b>	
Pedal.....	574,575,580,581,582,584,585-587
Pedal Pad.....	573,580
Plate.....	556
Police Kit.....	576
Pressure Plate.....	557
Pushrod(4Speed).....	560
Release(4Speed).....	560-561
Rivet.....	585,590
Rocker.....	574
Rod/Pawl.....	560-561,579
Spring.....	558,560
Throwout.....	560
COIL.....	672,673
COIN HOLDER.....	1031
CONDENSER.....	674
CONNECTING ROD.....	496-497
CONNECTOR(Wire).....	1290-1292
COTTER PIN LIST.....	1316
<b>COUNTERSHAFT</b>	
4 Speed.....	545
Sprocket(Rear).....	546
COWL.....	615
CRANKCASE.....	492-493
Bearing.....	497,498
Breather Kit.....	505
CRANK PIN.....	497
CRANKSHAFT.....	498
Balancing Service.....	1263
CUSTOMIZER KIT.....	731,732
<b>CYLINDER</b>	
Base Nut(1936-85).....	520
Boring Service.....	1260
Gasket.....	532,533,536,1308,1312
Knucklehead.....	533,536
Shovelhead/Panhead.....	532,537
Sleeving.....	1260
Top End Kit (Shovelhead).....	536
<b>D</b>	
DASH.....	737-739
Decal.....	737
Divider.....	735
Wiring.....	694,695
Dash Panel.....	737,739,740
Oil Tank.....	747
DECO TRIM.....	781
DIPSTICK.....	746,748
DISPLAY STAND.....	631,1266
DOWEL PIN LIST.....	628
DISTRIBUTOR.....	676
<b>DRAIN PLUG</b>	
Fork.....	610
Oil.....	492,552
Engine.....	492,552
DRESS UP KIT.....	731-732
<b>E</b>	
<b>ELECTRICAL</b>	
Battery.....	703-706
Circuit Breaker.....	693
Coil.....	672,673,677,679
Fuse Holder.....	693
Ignition.....	669-673
Spark Plug.....	674,682-683
Starter.....	684,685
Switch.....	690,692
Terminal.....	693
Wiring.....	694-695
EMBLEM.....	646,781,1206,1208,1209
Mount.....	725,1208,1209
<b>ENGINE</b>	
Bar/Leggin.....	630
Bushing List.....	1307
Case.....	492-493
Drain Plug.....	492,552
Equalizer Plate.....	571
Flywheel.....	494-495
Gasket List.....	1308-1315



**ENGINE CONTINUED**

Head.....	532,533
Knucklehead.....	486-487
Long Block.....	486-490
Mount.....	490
Offset Sprocket.....	562
Panhead.....	488
Race.....	499
Remanufacture Service.....	1260
Roller.....	496,497
Seal.....	498,1316
Sealant.....	1271
Short Block.....	490
Shovelhead.....	493
Skid Plate.....	645,649
Spacer.....	600
Sprocket.....	562
Stroker Kit.....	495
Throwout Bearing.....	560
<b>EXHAUST.....</b>	<b>653-668</b>
Baffle.....	668
Clamp.....	659,660,661,663,665,667
Components(1936-69).....	659
Cross Over.....	656,659
Dual.....	656,659
Extension.....	663
Fishtail.....	664
Flex Cover.....	666
Gasket.....	668
Heat Shield.....	666
Knucklehead.....	658
Mount.....	654,657,663,664,
Muffler.....	653-655
Panhead.....	661
Port Replacement.....	1265
Repair.....	668
Shovelhead.....	660
Tip.....	653,656,664
Upsweep.....	655

**F**

<b>FENDER.....</b>	<b>620-627</b>
Bumper.....	626
Dress Trim.....	621,622,623,626
Emblem.....	781
Front.....	620,621,622
Glide.....	620
Light.....	1129-1132
Mud Flap.....	622
Pad(Seat).....	1240
Rail.....	626
Rear.....	623-625
Rivet.....	621,622
Spring Fork.....	621,622,1219,1220
Strut.....	624,625
Trim/Tip.....	620,621,622,623,626-627
<b>FILTER</b>	
Air.....	707,708,709,710,711,712
Fuel.....	1199
Oil.....	754-756
<b>FLASHER.....</b>	<b>692</b>
<b>FLYWHEEL.....</b>	<b>494-495,524</b>
Balancing Service.....	1262
Remanufacture Service.....	1261
Stroker Kit.....	495
<b>FOOTBOARD.....</b>	<b>1076-1082</b>
<b>FOOTPEG.....</b>	<b>1058-1060,1064-1068,</b>
	<b>1070-1074</b>
Extender.....	1068
Heel Rest.....	1060
Relocate.....	1059

**FILTER**

Air.....	707,708,709,710,711,712
Fuel.....	1199
Oil.....	754-756

**FLASHER.....**

<b>FLYWHEEL.....</b>	<b>494-495,524</b>
Balancing Service.....	1262
Remanufacture Service.....	1261
Stroker Kit.....	495

**FOOTBOARD.....****FOOTPEG.....**

Extender.....	1068
Heel Rest.....	1060
Relocate.....	1059

**FORK.....**

Adjustable.....	605
Boot.....	611
Brace.....	612
Cover.....	615,1091-1094
Cowl.....	615,1091,1094,1095
Damper/Knob.....	604,610
Drain Plug.....	610

**FORK CONTINUED**

Glide.....	606,607,608
Headlamp Cowl.....	615,1091,1094,1095
Installation Kit.....	606,607
Internals.....	610
Leg Assembly.....	608,609
Leg Bushing Service.....	1265
Leg Sets.....	608,609
Lock Tab List.....	1317
Neck Kit.....	616,617
Nut (Top).....	616
Oil.....	1272
Panel.....	615
Plug.....	605,606,608,613
Riser.....	618,1036-1043
Seal.....	612
Slider.....	608-609
Spring Fork.....	785-786
Spring Fork Rebuild Service.....	1265
Spring.....	611
Stem Nut/Cover.....	608,614,615
Triple Tree.....	608,614
Tube and Slider.....	608,609

**FORK TUBE.....****FORWARD CONTROL**

Jockey.....	573,574,575,576
-------------	-----------------

**FRAME**

Bike Kit.....	639-644
Component.....	648-649
Covers.....	631
Guard/Bar.....	630
Hardtail.....	645
Knucklehead.....	638-639
Neck.....	616-617,649
Pan/Shovelhead(Rigid).....	641,644
Rolling Chassis.....	636,639,641
Skid Plate.....	645,649
Stand.....	628,631
Swingarm (Frame).....	644
Swingarm.....	647
Wishbone.....	643

**FRONT END**

Damper.....	604,610
Glide.....	605,606,614
Spring Fork.....	785-786
Spring Fork Rebuild.....	1265

**FUEL**

Filter.....	1199
Line.....	1200-1201
Petcock.....	1196,1197,1198
Shut Off.....	1199

**FUSE HOLDER.....****G****GAS**

Cap.....	732,1202-1207,1235
Decal.....	1209
Divider.....	735
Emblem.....	646,1208,1209
Mount.....	735,1208,1209
Gasket (Cap).....	1312
Line.....	1199,1200,1201
Mount.....	733,736
Petcock.....	1196-1198
Repair/Sealant.....	733,1272
Shut Off.....	733,1199
Tank.....	646,733-734
Trim.....	735,1208-1209

**GASKET**

Air Cleaner.....	1313
Cam Cover.....	1313
Carburetor.....	1313
Cometic.....	1313
Cylinder.....	532,533,1308,1312
Derby Cover.....	1310
Distributor Base.....	1310
Engine.....	185,186
Exhaust.....	1310
Gasket List.....	1308-1313

**GASKET CONTINUED**

Gas Tank Cap.....	1312
Generator.....	1312
Head.....	1309
Ignition.....	1308
Inspection.....	1310
Manifold.....	1313
Master Cylinder.....	1312
Oil Pump.....	1309
Pushrod.....	1309
Primary.....	451,452,1309,1310
Rocker.....	1308
Sealant.....	1271
Tail Lamp.....	1312
Tappet Guide.....	1308
Top End.....	185,186
Transmission.....	1311

**GASKET KIT**

Bendix.....	720
Keihin.....	719
Knucklehead.....	523,536
Linkert.....	715
Panhead.....	537
Shovelhead.....	537
Transmission(Speed).....	549
<b>GAUGE.....</b>	<b>741-745</b>
Dipstick.....	746,748
Oil.....	747
Speedometer.....	576,741-745
Tachometer.....	742

**GENERATOR.....**

Conversion.....	699
Rebuild.....	698-699,1265

**GOGGLE.....****H****HANDLEBAR.....**

Clamp Cover.....	604,618
Control/Switch.....	690,1050-1051
Damper.....	604,1039-1040
End Plug.....	619
Glide.....	619
Grip.....	619,794
Lever.....	726
Riser.....	618
Throttle.....	724,725,727,728
Two Piece.....	619
Wiring.....	690,694,695

**HANDLEBAR GRIP.....**

Cover(Leather).....	1086
---------------------	------

**HANDSHIFTS.....****HARDTAIL.....****HARDWARE KIT.....****HEADLAMP.....**

Bates.....	1099
Bracket.....	1101,1104,1108,1109,1220
Bulb.....	1206,1207
Connector.....	1096
Cowl.....	1091,1095
Cycle Ray.....	1105
Fork Cover Set.....	1094
HID.....	1104
Internal.....	1091,1101
Rim.....	1091,1092,1095,1102
Spring Fork.....	1114
Visor/Trim.....	1095,1096,1101,1102
	1103,1106,1107

**HEAD**

Bolt.....	520,525,533
Gasket.....	519,1297
Knucklehead.....	533
Panhead.....	537
Remanufacture Service.....	1264
Shovelhead.....	532-533
Top End Kit (Shovelhead).....	537

**HEATSHIELD.....****HELICOIL SERVICE.....****HIGHWAY BAR.....**

<b>HORN</b> .....	<b>1170,1174</b>
Switch.....	690
<b>HOSE</b> .....	<b>751,1201</b>
<b>HUB</b> .....	<b>765,770,771</b>
Cap.....	776
Clutch.....	558,570

**I**

<b>IGNITION</b> .....	<b>669-673</b>
Advance Unit.....	671-672
Coil.....	672,673,677,679
Condenser.....	674
Digital.....	673
Distributor.....	675-676
Electric Start Kit.....	684
Magneto.....	1294-1296
Module.....	672
Points.....	669,674
Spark Plug.....	674,682-683
Switch.....	691-692
System.....	670,672
Timing Plug.....	679
Tune Up.....	674
Weight Spring.....	671
Wiring.....	694-699
<b>INDICATOR LAMP</b> .....	<b>1168</b>
<b>INSPECTION COVER</b> .....	<b>762</b>
<b>INSPECTION TAG</b> .....	<b>1120</b>
<b>INTAKE</b> .....	<b>721-722</b>

**J**

<b>JET</b> .....	<b>721,722</b>
<b>JOCKEY</b> .....	<b>573,574,575,576</b>

**K**

<b>KEY CHAIN/KEY HOLDER</b> .....	<b>1324,1325</b>
<b>KEY</b> .....	<b>1317</b>
<b>KIT BIKE</b> .....	<b>634-635,636,639,640,641</b>
<b>KICKSTAND</b> .....	<b>628-629</b>
<b>KICKSTART</b> .....	<b>550-555</b>
Arm.....	551,554
Bushing.....	551,553
Conversion.....	540
Cover.....	553
4 Speed.....	550-553
Pedal.....	555
Ratchet(Gear).....	551
Shaft.....	551
3 and 4 Speed.....	550
<b>KROMMET</b> .....	<b>781,1145,1146</b>

**L**

<b>LAPEL PIN</b> .....	<b>1324</b>
<b>LEN</b> .....	<b>1137,1139,1153</b>
<b>LEVER</b> .....	<b>1041-1046</b>
Handle Assembly.....	726
<b>LICENSE HOLDER</b> .....	<b>1142-1144</b>
<b>LIFTER/TAPPET</b> .....	<b>512-513</b>
Base(Knucklehead).....	525-526
Base(Panhead/Shovelhead).....	512-513
<b>LIFT</b> .....	<b>1273-1274</b>
<b>LIGHT</b> .....	<b>1091-1169</b>
Bar.....	1153
Bulbs.....	1106,1141-1142,1168
Fender.....	1169
Gasket.....	1165
Headlamp.....	1091-1093,1095-1109
Indicator.....	1101,1184
Marker.....	1148-1151,1154
Reflector.....	1166
Signal.....	1155-1164
Spotlamp.....	1110-1115
Tachometer/Speedometer.....	1168
Tail Lamp.....	1116-1138
Turn Signal.....	1155-1164
<b>LOCK TAB LIST</b> .....	<b>1317</b>
<b>LONG BLOCK SERVICE</b> .....	<b>1260</b>
<b>LOCKWASHER</b> .....	<b>1320</b>
<b>LUGGAGE RACK</b> .....	<b>782,828</b>

**M**

<b>MAGNETO</b> .....	<b>1294-1296</b>
----------------------	------------------

<b>MAINSHAFT</b>	
4-Speed.....	544
Gasket.....	549
Seal/Spacer.....	549
<b>MANIFOLD</b> .....	<b>721-722</b>
<b>MANUALS</b> .....	<b>1268-1270</b>
<b>MARKER LAMP</b> .....	<b>1148-1150</b>
<b>MASTER CYLINDER</b>	
Front.....	1052,1053
Rear.....	583,589
Rebuild.....	1053

**MIRROR**.....

MetricAdapter.....	1195
<b>MODULE</b> .....	<b>672-673</b>
<b>MOTOR MOUNT</b> .....	<b>491</b>
<b>MOTOR PLAQUE</b> .....	<b>565,1328</b>
<b>MOTOR SHOP SERVICES</b> .....	<b>1260-1265</b>
<b>MOTOR SHOP SERVICE</b>	
Alternator Ring Replacement.....	1263
Breather Valve Machining.....	1265
Cam Bushing Big Twin.....	1264
Case Boring.....	1263
Crankshaft Balance.....	1263
Cylinder Boring.....	1260
Cylinder Sleeving.....	1260
Engine Remanufacture.....	1260
Exhaust Port Replacement.....	1265
Flywheel Balancing.....	1262
Flywheel Assembly.....	1261
Flywheel Remanufacture.....	1261
Fork Leg Bushing Install.....	1265
4/5 Speed Rebuild.....	1265
5/6 Speed Conversion Service.....	1265
Generator Rebuild.....	1263
Head Remanufacture.....	1264
Head Resurface.....	1264
Linkert Rebuild Service.....	1263
Long Block Remanufacture.....	1260
Magneto Rebuild.....	1294
Short Block Remanufacture.....	1260
Spark Plug Helicoil Service.....	1264
Spring Fork Rebuild.....	1265
Transmission Remanufacture.....	1265
Valve Seat Service.....	1264
Wheel Truing/Build.....	1265

**MIRROR**.....

MetricAdapter.....	1195
--------------------	------

**MODULE**.....

**MOTOR MOUNT**.....

**MOTOR PLAQUE**.....

**MOTOR SHOP SERVICES**.....

**MOTOR SHOP SERVICE**

Alternator Ring Replacement.....	1263
Breather Valve Machining.....	1265
Cam Bushing Big Twin.....	1264
Case Boring.....	1263
Crankshaft Balance.....	1263
Cylinder Boring.....	1260
Cylinder Sleeving.....	1260
Engine Remanufacture.....	1260
Exhaust Port Replacement.....	1265
Flywheel Balancing.....	1262
Flywheel Assembly.....	1261
Flywheel Remanufacture.....	1261
Fork Leg Bushing Install.....	1265
4/5 Speed Rebuild.....	1265
5/6 Speed Conversion Service.....	1265
Generator Rebuild.....	1263
Head Remanufacture.....	1264
Head Resurface.....	1264
Linkert Rebuild Service.....	1263
Long Block Remanufacture.....	1260
Magneto Rebuild.....	1294
Short Block Remanufacture.....	1260
Spark Plug Helicoil Service.....	1264
Spring Fork Rebuild.....	1265
Transmission Remanufacture.....	1265
Valve Seat Service.....	1264
Wheel Truing/Build.....	1265

**MOTORCYCLE COVER**.....

**MUD FLAP**.....

**MUFFLER**.....

**N**

**NECK CUP KIT**.....

**NUT LIST**.....

**O**

**O-RING LIST**.....

**OFFSET KIT**.....

**OIL**

Cap.....	748
Cooler.....	753
Dipstick.....	746
Drain Plug.....	492,552
Filter.....	754-756
Fitting.....	750,751,752,753
Gauge.....	753
Line.....	525,751
Line (Knucklehead).....	525
Oil (Quarts).....	1271
Pressure.....	692,753
Pump.....	502-504
Seal.....	503
Tank.....	746-747

**P**

**PATCHES (CLOTH)**.....

**PARTS MANUAL**.....

**PEDAL PAD**.....

**PEG**.....

**PETCOCK**.....

  Screen.....

**PILLION PAD**.....

**PIN LIST**.....

  Dowel.....

**PINION**.....

  Cage/Roller.....

  Hardware.....

  Shaft.....

**PIPES**.....

**PISTON**.....

  Panhead/Shovelhead Kit.....

  Ring.....

  Stroker Kit/Big Bore.....

**PLUGS**

  Case.....

  Handlebar End Plug.....

  Fork.....

  Magnetic.....

  Oil Tank.....

  Spark.....

  Timing.....

  Transmission Fill.....

**POINTS**.....

  Conversion Kit.....

  Cover.....

**POLICE**

  Decal.....

  Shifter.....

  Siren.....

  Speedometer.....

**POLISH/CLEANER**.....

**PRIMARY**.....

  Case Saver.....

  Chain/Oiler.....

  Chain Tensioner.....

  Derby.....

  Dress Up Kit.....

  Drive Kit.....

  Equalizer Plate.....

  Gasket.....

  Inner.....

  Inspection Cover.....

  Outer.....

**PULLEY**.....

**PUSHROD**.....

  Clutch.....

  Cover.....

  Engine.....

  Knucklehead.....

  Seal.....

**R**

**RACE**

  Case.....

  Rod.....

**RAIL**

  Fender.....

  Sissy Bar.....

**RATCHET TOP**.....

**REFLECTOR**.....

**REGISTRATION TAG**.....

**REGULATOR**.....

**RELAY**.....

  Generator.....

  Starter.....

**RIM**.....

**RING**.....

**RISER**.....

  Spring Fork.....

**RIVET**.....

**ROCKER**

  Arm.....

  Box/Line(Shovelhead).....

  Cover.....

  Knucklehead.....

  Overhead Oiler.....

  Panhead.....

  Shovelhead.....

**ROD**

  Bearing/Roller.....

  Brake.....



<b>ROD CONTINUED</b>	
Clutch.....	560-561
Connecting.....	496
Roller Cage.....	496,497
Shift.....	560,561,577,579
<b>ROLL PIN LIST.....</b>	<b>1316</b>
<b>ROLLER</b>	
Cage.....	496,497
Countershaft.....	543
OHV.....	499
Tappet.....	512
Transmission.....	543
<b>ROLLING CHASSIS.....</b>	<b>636,639,641</b>
<b>ROTARY TOP.....</b>	<b>546</b>
<b>ROTOR</b>	
Brake.....	594,595,598,599,600,601
<b>S</b>	
<b>SADDLEBAG.....</b>	<b>778,779,880</b>
Relocation (Signal).....	1162,1163
Trim and Rail.....	778,779
<b>SCREW LIST.....</b>	<b>1322</b>
<b>SEAL LIST.....</b>	<b>1315,1316</b>
<b>SEALANT.....</b>	<b>1271</b>
<b>SEAT</b>	
Buddy.....	1253,1254
Police.....	1249-1252
Rear Pads.....	1240
Rigid.....	1235,1236
Solo.....	472,1236-1239,1241,1242,1243, 1245,1246,1249-1250
Springs.....	1248
<b>SERVICE MANUAL.....</b>	<b>1268-1270</b>
<b>SHIFT</b>	
Arm.....	580
Bracket.....	581
Fork (5 Speed).....	548
Forward Control.....	578-587
Hand.....	575-577
Jockey.....	583,585-586
Knob.....	572
Lever.....	572,573,575,576,580
Linkage/Rod.....	560,561,577,579,580
Mousetrap.....	579
Pad(Shift Pedal).....	572
Pawl.....	546
Peg.....	580
Replica Kit.....	578
Rod.....	560-561,579
Slap Stick.....	583
<b>SHIM LIST.....</b>	<b>1307</b>
<b>SHOCK.....</b>	<b>650-651</b>
<b>SHOP SERVICES.....</b>	<b>1260-1265</b>
<b>SHORT BLOCK.....</b>	<b>490</b>
<b>SHOW BIKE KITS.....</b>	<b>731-732</b>
<b>SIGNAL.....</b>	<b>1155-1167</b>
<b>SIREN.....</b>	<b>576</b>
<b>SISSY BAR.....</b>	<b>642</b>
<b>SKID PLATE.....</b>	<b>638,649</b>
<b>SKULL STUFF.....</b>	<b>1017-1022</b>
<b>SLAPSTICK.....</b>	<b>513</b>
<b>SLIDER.....</b>	<b>608-609</b>
<b>SOLENOID.....</b>	<b>688</b>
<b>SPACER LIST.....</b>	<b>1320</b>
OHV Internal.....	498
<b>SPARK PLUG.....</b>	<b>674,682-688</b>
HeliCoil Installation.....	1264
Wire.....	681
<b>SPEEDOMETER.....</b>	<b>576,741-745</b>
Drive Units.....	730
<b>SPOKE.....</b>	<b>765</b>
<b>SPOOL WHEEL.....</b>	<b>1218</b>
<b>SPOTLAMP.....</b>	<b>1110-1115</b>
<b>SPRING FORK.....</b>	<b>785-799</b>
Rebuild.....	1265
<b>SPRING</b>	
Brake Pedal.....	584,585
Clutch.....	558,560
Fork.....	611

<b>SPRING CONTINUED</b>	
Kick Starter.....	553
Kickstand.....	629
Relief Valve.....	504
Valve.....	529-530
<b>SPROCKET.....</b>	<b>562-566,567</b>
Bolt Kit.....	562
Compensator.....	562
Countershaft.....	562
Engine.....	498,562
Nut.....	565
Offset.....	562
Rear.....	566,567
Shaft.....	562
Transmission.....	565
<b>STARTER.....</b>	<b>684-689</b>
Conversion Kit.....	684
Cover.....	684,688
Drive.....	687
Housing.....	686-687
Lever Starter System.....	688
Relay.....	689
Repair Kit (Prestolite).....	680
Shaft.....	686-687
Solenoid.....	688
<b>STATOR.....</b>	<b>696</b>
<b>STROKER.....</b>	<b>495</b>
<b>STRUT.....</b>	<b>624,625</b>
<b>STUD LIST.....</b>	<b>1317</b>
<b>SUSPENSION.....</b>	<b>650,651</b>
<b>SWINGARM.....</b>	<b>647</b>
<b>SWITCH.....</b>	<b>689-692</b>
Brake.....	692
Dimmer.....	690
Directional.....	690
Flasher.....	692
Handlebar.....	690
Hi-Low.....	692
Horn.....	690
Ignition.....	691
Neutral.....	692
Oil Pressure.....	692
Universal.....	690
<b>T</b>	
<b>TACHOMETER.....</b>	<b>742</b>
<b>TAIL LAMP.....</b>	<b>1116-1138</b>
Assemblies.....	1116-1137
Bulb.....	1141
Connector.....	1141
Derby Mount.....	1127
Fender Mount.....	1117,1129,1131,1132
Gasket.....	1312
Lamp.....	1116-1137
Lens.....	1137-1139
License Bracket.....	1137-1142
Side Mount.....	1120-1128
Tombstone.....	1134,1135
Vintage.....	1132-1134,1135
Visor.....	1137,1138
Wiring.....	1128
<b>TAPPET.....</b>	<b>513,514,515</b>
Seal.....	516
Knucklehead.....	526
Oil Screen.....	504
Panhead/Shovelhead.....	513,516
<b>TERMINAL BOARD.....</b>	<b>693</b>
<b>THROTTLE.....</b>	<b>724-727</b>
Cable.....	724,725
Internal.....	724
<b>TIMING</b>	
Advance Unit.....	671-672
Plug.....	669,670
<b>TIRE.....</b>	<b>1210-1216</b>
Tubes.....	1217
Weights.....	1217
Valve Stem Covers.....	1217
<b>TOOL BOX.....</b>	<b>633</b>
<b>TOOL KIT.....</b>	<b>1267</b>

<b>TOOL ROLL.....</b>	<b>1267</b>
<b>TRANSMISSION.....</b>	<b>538-549</b>
Adjuster Kit.....	538-549
Bushing List.....	1307
Case.....	540
Drain Plug.....	552
Fill Plug.....	552
4 Speed.....	538,539
5/6 Speed Conversion.....	538
Gasket.....	549
Jockey.....	573,574,575,576
Kick Starter.....	550-551,553,554,555
Lock Tab.....	548
Mount Plate.....	541
Neutral Switch.....	692
Oil Seal Kit ( Speed).....	549
Plugs.....	552
Ratchet Top.....	547
Rebuild Hardware.....	549
Remanufacture Service.....	1265
Rotary Top.....	546
Seal.....	549
Shift Pawl.....	548
Sprocket/Nut.....	565
<b>TRIPLE TREE.....</b>	<b>605,608,614</b>
<b>TUBE (Tire).....</b>	<b>1217</b>
<b>TUNE UP.....</b>	<b>674</b>
<b>TURN SIGNAL.....</b>	<b>1155-1164</b>
Canceler.....	1166,1167
Equalizer.....	1167
Flasher.....	1167
Gasket.....	1165
Relocation.....	1162,1164
<b>V</b>	
<b>VALVE</b>	
Cover(Panhead).....	519
Guide.....	527,528
Keeper.....	529
Seat.....	528
Spring(Shovelhead/Panhead).....	529,530
Valve Seat Service.....	1264
<b>VELOCITY STACK.....</b>	<b>707</b>
<b>VOLT REGULATOR.....</b>	<b>696,697,698</b>
<b>W</b>	
<b>WASHER LIST.....</b>	<b>1320,1322</b>
<b>WHEEL.....</b>	<b>766-770</b>
Assembly.....	766,767,768
Axle.....	773
Cast.....	766
Hub.....	765,769-770
Hub Cap.....	776
Rim.....	767,769
Seal.....	770
Spoke.....	765,769
Spool.....	1218
Star Hub and Rebuild.....	772
Truing/Building Service.....	1265
<b>WIND DEFLECTOR.....</b>	<b>783</b>
<b>WINDSHIELD.....</b>	<b>782-784</b>
<b>WIRING</b>	
Braided Wire.....	695
Connector.....	689
Dash.....	694,695
Handlebar (Control).....	694
Harness.....	694,695
Pins/Sockets.....	694
Shrink Wrap Tubing.....	693
Spark Plug.....	679-681
Tail Lamp.....	1128
Terminal.....	689,1290,1291
Wire Loom Clip.....	689
<b>WRIST PIN.....</b>	<b>182</b>

## FLAT HEAD/SIDE VALVE

<b>A</b>	
AXLE.....	775,819
<b>B</b>	
BATTERY/BOX.....	818
BELT BUCKLES.....	1325
BOLT KIT.....	808
BRAKE.....	800
Cable(Spring Fork).....	798
Servi-Car.....	799
Spring Fork.....	798-799
BOOKS.....	1268-1270
<b>C</b>	
CABLE BRACKET.....	810
CAM.....	806
CAP	
Axle.....	778
Hub.....	788,817
Oil.....	810,824
CARBURETOR.....	713-716,721,811
CASE.....	809,814,815
Race/Rollers.....	815
CHAIN AND GUARD.....	818,819
CLOTH PATCH.....	1323
CLUTCH.....	812,814
COUNTERSHAFT.....	815,821
CRANKCASE.....	809,814,815
CRANK PIN.....	802
CRANKSHAFT.....	802
CYLINDER.....	807
<b>E</b>	
EARLY TOOL.....	810,811,814,1282
ENGINE	
Components.....	807
Gasket.....	801
Guard/Leggin.....	821
Head.....	801
Mount.....	801
Sprocket.....	819
EXHAUST.....	820,821
<b>F</b>	
FENDER.....	809
FLATHEAD.....	785-828
FLYWHEEL.....	802
FRAME.....	818
Stand.....	821
<b>G</b>	
GAS TANK.....	733-734,810
GASKET	
Flathead.....	801
K Model.....	802
GENERATOR CONVERSION.....	810
<b>H</b>	
HANDLEBAR.....	619,794,795,796,1023-1031
HANDSHIFT.....	813
HEADS.....	801
HENDERSON.....	828
HUB.....	770
HUMMER MODEL.....	822
<b>I</b>	
INDIAN.....	826-827
INSPECTION COVER.....	818

<b>J</b>	
JIFFY STAND.....	821
<b>K</b>	
K MODEL.....	822,823,824
Army.....	816
KEY CHAIN/KEY HOLDER.....	1324
KICKSTAND.....	821
KICK STARTER.....	815,817,819
<b>L</b>	
LAPEL PIN.....	1324
LIFTER.....	808
<b>M</b>	
MAINSHAFT.....	814-815
MILITARY.....	816
MUFFLER.....	820
<b>O</b>	
OIL	
Cap.....	810
Dipstick.....	810
Line.....	813
<b>P</b>	
PATCH (CLOTH).....	1323
PEDAL PAD.....	813
PINION.....	804-805
PISTON.....	807
Ring.....	807
PRIMARY.....	818
<b>R</b>	
RACE.....	802-803
RING.....	807
ROD.....	802,815
Brake.....	798,800
ROLLER.....	802,815
<b>S</b>	
SADDLEBAG.....	816
SCALE MOTOR MODEL.....	1324
SEAT.....	822,824
SERVI-CAR.....	817
SHIFT.....	812-813
SIDECAR.....	825
SIDE VALVE.....	808
SPOKE.....	821,824
SPRING FORK	
Axle.....	787
Brake.....	786,787,788
Damper.....	787
Fender.....	622,787
Fork.....	785
Grip.....	794
Handlebar.....	794-795
Headlamp.....	1104
Hub Cap.....	788
Rebuild.....	789-790,1265
Shock/Ride Control.....	787
Throttle/Cable.....	794,795
Tree/Riser.....	792,793,795
Windshield.....	783
SPRING	
Kick Starter.....	819
Valve.....	808
SPROCKET.....	805,819

<b>T</b>	
TAPPET.....	808
THOR.....	828
TRANSMISSION.....	814-815
TRIPLE TREE (Spring Fork).....	792
<b>V</b>	
VALVE.....	804,808
VL MODEL.....	821
<b>W</b>	
WHEEL.....	766,800,824
WIRING.....	816
WRIST PIN.....	802,807





# V-Twin Mfg. Knucklehead Engine



V-Twin *first* introduced the complete **Knucklehead Engine** in 2002. **100% V-Twin!** This completed our line up of **Replica Engines**, with the first being the Panhead in 1998, followed by the Shovelhead in 1999!



**Knucklehead 87" Alternator-Generator Long Block** features alternator left hand case and generator right hand case. Each long block is assembled with S&S crankcases, Sifton oil pump, S&S 4 $\frac{5}{8}$ " flywheels, Timken main bearing, Sifton Knucklehead lighting cam, matched pinion gear, Torrington cam needle bearing and Torrington main pinion bearing. Cylinders are Motor Shop Ready Brand pre-fitted with forged 8.25:1 pistons. Cylinder heads are Motor Shop Ready brand fitted with Sifton valves, springs and collars. Heads feature stock intake and exhaust ports. Each 87" long block is assembled with a natural finish cam cover, natural finish lifter block, automatic advance distributor and solid lifters. Each long block is pre-run and tested for proper oil pump pressure. Sprocket shaft is correct length for 1970-up 4 or 5 speed transmission assembly.

VT No.	Item
10-1985	Engine
31-0735*	Top Mount

\*Note: Allows installation of Knucklehead engine in Evolution frames. Raw finish



**Replica Linkert Manifold** includes nuts, seals, gaskets & bolts.

VT No.	Item
35-0043	Manifold
35-0113	Adapter to Bendix



**Manifold Kit.** Order nut/seal kit and 35-0064 manifold for 61" engines with Big Port Heads.

VT No.	Item
35-0863	Nut/Seal Kit
35-0064	Manifold



**Upper and Lower** for 1936-69 Big Twin.

VT No.	Year	Finish
8164-19	1936-69	Chrome
8165-19	1936-69	Cadmium
9627-19	1936-69	Parkerized



**Stock Knucklehead Engine Mount** fits 61 and 71 Overhead Oiler Big Twins.

VT No.	Years	Finish
31-0106	1938-47	Chrome
31-0107	1938-47	Black Oxide
31-9006	1936-37	Black Oxide
2649-9	Bolts	Parkerized
2648-9	Bolts	Cadmium



31-0735 Top Mount allows the installation of Knucklehead Engine in Evolution frame, raw finish

# Replica Knucklehead Engine

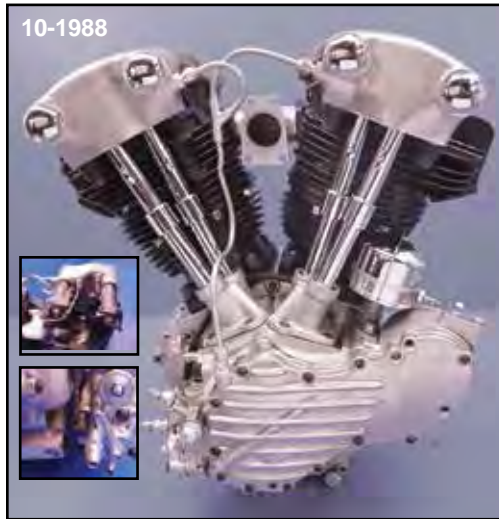

10-1988



Details of 10-1988



10-1983



10-1983

**Industry  
First!**



10-1983



**Over 500 Sold!**

## Replica V-Twin™ Mfg. Knucklehead Long Block

- Shipped fully assembled less carburetor and generator and shop tested for oil pressure. Components used in the assembly include:
- **Crank Case Replica V-Twin Mfg.** with authentic cast profiles. Including relay and number bosses.
- **Rocker Boxes** with natural finish and overhead oiler provision from timing cover.
- **Heads** newly casted Knuckleheads with parkerized lower valve cover cups and tops.
- **Flywheels** Truett and Osborn, cast iron type, assembled with stock rods and Torrington rollers with steel cages at sprocket and pinion shaft ends.
- **Valve Train** includes solid tappet assemblies with Sifton lightning cam, Sifton solid stock pushrods and chrome pushrod covers.
- **Cast Iron Cylinders** fitted with 8.5:1 cast pistons and Hastings rings
- **Oil Pump V-Twin Replica** cast iron with early iron cover
- **Distributor mechanical advance** with corresponding relay mount with distributor post guide slot
- **Intake Manifold** Linkert style 4 bolt manifold with plumber style nuts and brass seals.

VT No.	Item	Stroke	Cubic Inch
10-1983	Long Block		61"
10-1988	Long Block 74"	4"	74"
10-1986	Long Block 84"	4½"	84"
10-1989*	Short Block	4"	
49-0530	Top Mount	Black	

\*Note: Same as long block assembly, less heads, cylinders and piston, distributor, manifold and top oil line.





# V-Twin Mfg. Replica Panhead Long Block



### Replica Details include

- OE Number Boss
- Stock Exhaust Port
- Replica Oil Pump

### FLH Panhead Long Block

- 10-1994 Alloy, 74"
- 10-2003 74"

**Replica Panhead 74" Engines** have replica type heads with stock exhaust ports and V-Twin cases. The 1948-54 style uses a plumber intake manifold. The 1955-61 style uses O-ring intake manifold. Engines include cast iron oil pump. OE number boss in provided blank on left side. Actual case numbers are on right side. The sprocket shaft supplied is for 1936-64 style 4-speed stock transmissions. Engines listed do not include intake manifold.

VT No.	Year	Finish	Distributor
10-1995	1948-53	Chrome	Manual
10-1996	1948-53	Alloy	Manual
10-2015	1955-61	Chrome	Automatic
10-2016	1955-61	Alloy	Automatic

## V-Twin™ Panhead Long Blocks

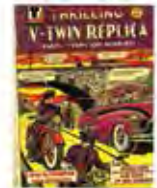

**V-Twin Panhead Parts Dope Reference Guide** for 100% V-Twin restoration components and tips for 1948-65 Panhead models. 272 pages. VT No. 48-1364

**FLH Panhead Long Block** is of 74" or 80" cubic inch displacement featuring a crankcase, Sifton oil pump/breather assembly, stock stroke flywheel, Timken bearing, stock FLH cam installed with a matched pinion and cam gear with a Torrington full compliment bearing. Assembly supplied with a cast finished ribbed cam cover, chrome lifter blocks which are fitted with hydraulic tappets and stock steel pushrods. Cylinders are stock replacement with standard compression 8.5:1 cast pistons and Hastings rings. Top end includes single plug head fitted with rocker arm assemblies, chrome pan covers with thick D-Rings, and chrome steel pushrods covers. Order manifold (Shovel band style), carburetor and 2 brush generator separately. Automatic advance distributor is included. Entire unit is pre-run and factory tested for oil pump pressure. Also available as 1963-65 type with overhead oiler line. VT No. 10-2005 features stainless pans and D-Rings and zinc plated lifter blocks.

VT No.	Replica	Item	Year	Cam Cover
—	10-1977	74" 1958 Style w/Stock Exhaust Ports	1948-65	Finned
10-2003	10-1958	74" 1958 Style	1955-62	Finned
—	10-1976	74" 1958 Style with Alloy Finish	1955-64	Finned
10-1994	—	74" 1958 Style w/Stock Exhaust/Alloy Finish	1955-64	Finned
10-2004	—	80" 1963-64 Style Overhead Oiler	1963-64	Finned
10-2012	—	74" 1963-64 Style Overhead Oiler	1963-64	Finned
10-1998	—	74" 1965 Style Overhead Oiler	1965-69	Smooth
10-1999	—	80" 1965 Style Overhead Oiler	1965-69	Smooth



10-1994 Detail

# 88" Generator-Alternator Pan or Shovelhead Long Block



**Panhead or Shovelhead 88" Generator-Alternator Long Block** features alternator left hand case and generator right hand case. Each long block is assembled with S&S Crankcases, Sifton Oil Pump/Breather Assembly, S&S 4 1/4" stroke flywheels, Timken main bearing, stock FLH cam with matched pinion gear installed with a Torrington full compliment needle bearing. Assembled with a cast finish cam cover, automatic advance distributor, chrome lifter blocks that are fitted with hydraulic tappets and pushrods. Cylinders are S&S 3 5/8" type fitted with 7.75:1 compression ratio cast pistons and rings. Top end also features 3 5/8 Big Bore single plug Panheads with Shovelhead exhaust pipe flange and intake ports, and are fitted with rocker arm assemblies, no lead valves, chrome pan covers, polished thick D-Rings, chrome pushrod covers and chrome rocker box feed line. Entire unit is pre-run and tested for proper oil pump pressure. Order intake manifold (O-ring type) and carburetor separately. Use with 4 speed 1970-84, 5 speed Rigid Softail 1986-99 transmission electric or kick start. VT No. 10-2018 has chrome cam cover in addition to chrome pans.

**Cubic Inch =  $\pi r^2 \times \text{Stroke}$**   
**r = 1/2 of Bore**

CUBIC INCH CHART									
	STROKE	3 1/2"	3 13/16"	3.968"	4 1/4"	4 1/2"	4 5/8"	4 3/4"	5.00"
<b>B O R E</b>	2 3/4"		45"						
	3 5/16"	61"							
	3 7/16"	64.8"		73.7"	78.7"	83.4"	85.7"	88.0"	92.8"
	3 1/2"	67.2"		76.3"	81.6"	86.6"	89.0"	91.4"	96.1"
	3 5/8"	72.1"		81.7"	87.4"	92.9"	95.5"	99.0"	103.2"
	3 1 1/16"	74.6"		84.7"	90.7"	96.1"	98.8"	101.5"	106.8"
	3 13/16"	79.9"		90.6"	97.0"	102.8"	103.7"	108.9"	114.2"
	3 7/8"	82.3"		93.4"	100.1"	100"	108.9"	111.9"	117.8"
	4.00"	87.9"		99.7"	106.8"	113.0"	116.1"	119.3"	125.6"
	4 1/8"	93.4"		106.0"	113.5"	120.2"	123.5"	126.9"	133.6"
4 1/4"	99.2"		112.6"	120.5"	127.6"	131.1"	134.7"	141.8"	

VT No.	Finish	Type
10-2014	Natural	Panhead
10-2018	Polished	Panhead
10-1984	Natural	Shovelhead



**Chrome Y Tube Top Oil Lines** fit Panhead top ends.  
**VT No. 40-0606**



**10-2013**  
**V-Twin Mfg™**  
**Replica Flatside**  
**Shovel**

- V-Twin First
- Replica Engines
- 1997 Evo
- 1998 Panhead
- 1999 Shovel
- 2002 Knucklehead

**Flatside Shovelhead Long Block** is of 74 cubic inch displacement featuring Sifton oil pump/breather assembly, stock stroke flywheel, Timken bearing, stock FLH cam properly installed with a matched pinion and cam gear with a Torrington full compliment bearing. Assembly is supplied with a natural finish Flatside 1966-69 stock style cam cover, chrome lifter blocks which are fitted with hydraulic tappets and stock style pushrods. Cylinders are stock style with standard compression 8.5:1 cast pistons and Hastings rings. Top end includes replica stock type single plug heads with chrome steel pushrod covers and polished rocker boxes with shafts and arms installed. Order manifold (flat seal type), carburetor and 2 brush generator separately. Clamp style automatic advance distributor is included. Entire unit is pre-run and factory tested for oil pressure.

**All long blocks shipped assembled as pictured to fit 1965-69 transmission.**

VT No.	Item
10-2002	74"
10-2013	80"





# Long Block

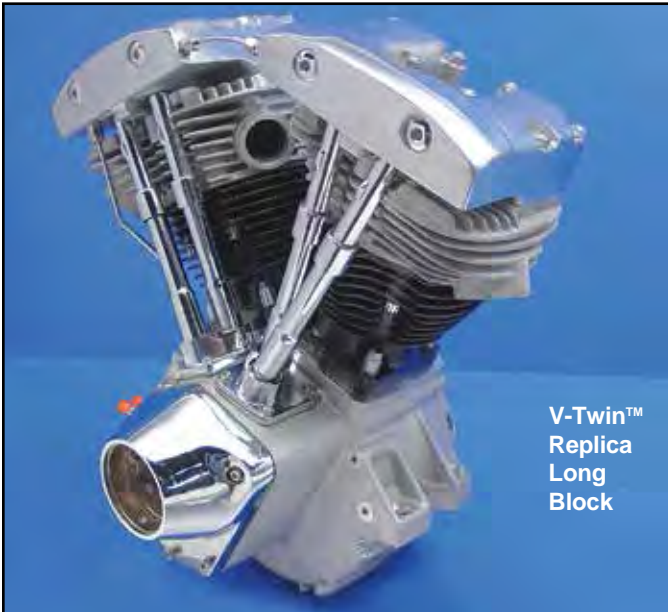

V-Twin™  
Replica  
Long  
Block

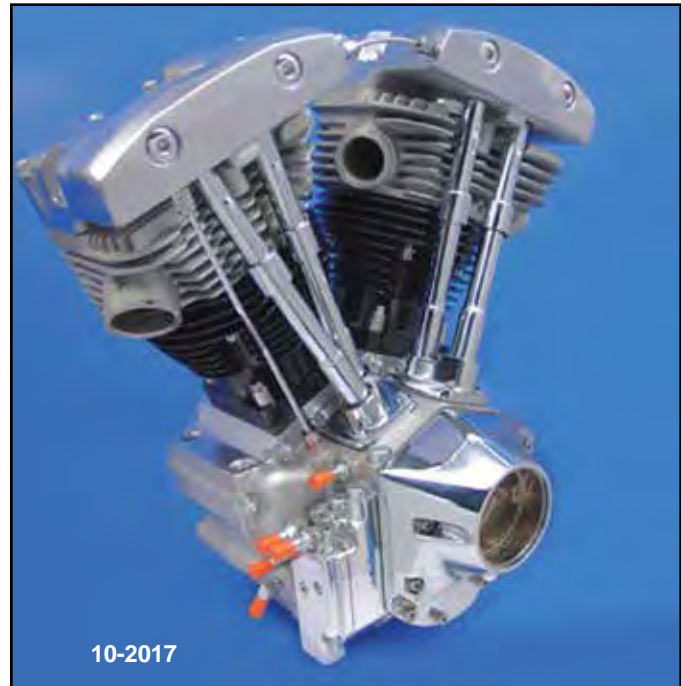

10-2017

**Shovelhead Long Block** is an 80 or 88 cubic inch displacement featuring a S&S crankcase, Sifton oil pump/breather assembly and a stock or 4 $\frac{5}{8}$ " stroke flywheel, Timken bearings, a stock cam properly installed with a matched pinion and cam gear with a Torrington bearing. Assembly is supplied with a chrome nose cover and chrome lifter blocks which are fitted with hydraulic tappets and stock style pushrods. Cylinders are 3 $\frac{1}{2}$ " stock style with standard compression pistons and Hastings rings. Top end includes stock type single plug heads with stainless valves, with shafts and arms installed. Order manifold (flat seal type), stator and ignition system separately. Pre-run factory tested for oil pump pressure.

VT No.	Size	Stroke
10-2001	80"	4 $\frac{1}{4}$ "
10-2017	88" features	4 $\frac{5}{8}$ "

# Short Block



10-0006

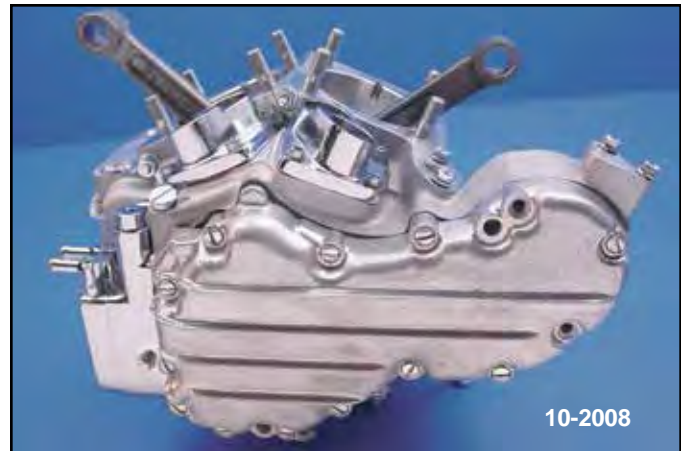

10-2008

**V-Twin™ 80" Short Blocks** are shipped fully assembled as shown. All 80" units feature an S&S Crankcase, Sifton Oil Pump/Breather assembly, stock stroke flywheel, Timken Bearings, stock cam properly installed with a matched pinion and cam gear with Torrington bearing. Assembly is supplied with a chrome nose cone cover and chrome lifter blocks are fitted with standard tappets. Blocks fit 1973-84 Shovelheads.  
VT No. 10-0006

**V-Twin™ Short Blocks** are shipped fully assembled as shown. All units feature an S&S crankcase (except where noted), Sifton oil pump/breather assembly, stock stroke flywheel, Timken bearings, stock cam properly installed with a matched pinion and cam gear with Torrington bearing. Assembly is supplied with a natural cover and chrome tappet blocks are fitted with standard tappets which will accept a hydraulic tappet unit or solid conversion kit not included.

VT No.	Fits	Cu In
10-1952*	1948-62 Panhead	74"
10-2121*	1955-62 Panhead	74"
10-2008	1956-62 Panhead	74"
10-2009	1966-69 Shovelhead	74"
10-2010	1963-64 Panhead	74"
10-1992	1963-64 Panhead	80"
10-1991	1965 Panhead	74"
10-1990	1965 Panhead	80"



\*Note: Assembled with V-Twin replica crankcases.



# Top Engine Mount



**Chrome Big Twin Top Engine Mounts** replace the stock type.

VT No.	OEM	Year	Type
31-0103*	69018-73A	1973-80	FXE-FX
31-0100*	69013-77A	1977-83	FXE-FXS



**Chrome Billet Top Mount** fits 1948-84 Panhead and Shovelhead.

VT No.	Type
31-0748	Plain
31-1275	With holes



**Big Twin 1948-84 Chrome Top Engine Mount**, mounts coil and is available with or without a hole to mount a universal key switch.

VT No.	Type
31-0104	With
31-0105	Without

**Front Engine Mount Nut** replaces 24797-36 on 1936-up Big Twins. Includes lock tab pressed in place.

VT No. 37-9066



**Upper and Lower** for 1936-69 Big Twin.

VT No.	Year	Finish
8164-19	1936-69	Chrome
8165-19	1936-69	Cadmium
9627-19	1936-69	Parkerized
8806-17	1970-84	Chrome
8807-17	1970-84	Cadmium
9926-17	1970-84	Allen
9926-17-P	1970-84	Polished Allen

**Upper Only**

7604-7 1936-84 Acorn

**Lower Only**

7603-4 1936-84 Acorn



**Top Mount Stud Kit** includes studs, washers and nuts.

VT No.	Year	Finish
2368-8	1948-65	Parkerized
2369-8	1948-65	Cadmium
2370-8	1966-84	Cadmium
12-2107	Studs	4 pack

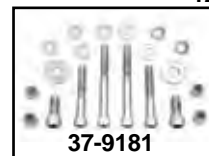

**Chrome Allen Screw Kit** connects engine mounts, front, top and rear to frame on models listed below. Knurled.

VT No.	Fits
37-9181	1948-84 Big Twin 4-Speed
37-9183	1982-83 FXRS



**Maxi-Mount** fits 1948-84 FL-FX. VT No. 31-4020



**Big Twin Chrome Top Engine Mounts** replace the stock type.

VT No.	OEM	Year	Type
31-0101	16853-48	1948-84	FL-FX
31-0110*	16853-48	1948-65	FLH
31-0261*	16853-48	1948-65	FLH, Cadmium
12-2107	16864-48	1948-84	Stud
2650-13	Bolt	1948-72	FL

\*Note: Features choke mount.



**Chrome Heavy Duty Two Piece Top Engine Mounts** are constructed of 1/4" thick steel.

VT No.	Year	Fits
31-0109	1948-84	74 and 80
31-0256	1980-83	FLT-FXR

\*Note: Fits Shovelhead or Panhead engine in Evolution style frame.

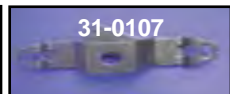

**Stock Knucklehead Engine Mount** fits 61 and 71 Overhead Oiler Big Twins.

VT No.	Years	Finish
31-0106	1938-47	Chrome
31-0107	1938-47	Black Oxide
31-9006	1936-37	Black Oxide
2649-9	Bolts	Parkerized
2648-9	Bolts	Cadmium





# Crankcase Set



1970-84  
Shovel



10-0029

**S&S Crankcase Sets** are shipped set up with Timken left side bearing and race assembly, seal and seal spacer, oil pump drive bushing, needle bearing and pinion race for right side, (pressed in and line honed) ready to assemble. Also included are cylinder studs, nickel plated case bolts, crankcase fittings and a timing and magnetic drain plug. Accepts wheels up to 8½" diameter. VT No. 10-0028 Knucklehead cases fit Panhead style frames and later model oil pumps. **Note:** Oil pump required for assembly for stock bore.

VT No.	Year	Bore	Oil Pump
10-0029	1948-64	Stock	12-8001
10-0030	1965-69	Stock	12-8001
10-0003	1970-84 Shovelhead	Stock	12-8002
10-0004	1970-84 Shovelhead	3 5/8	12-8002



10-0290

**S&S Alternator-Generator Crankcase Set** is shipped with left side bearing race, oil pump drive bushing, cylinder base studs, idler stud, circuit breaker stud, pinion needle bearing and pinion race installed. Pinion race is lined. Honed and ready for assembly. Also included are nickel plated case bolts, crankcase fittings, left side engine bearing, seal and spacer. Accepts wheels up to 8½" diameter.

VT No.	Cylinder Type	Bore	Oil Pump
10-0290	Knucklehead	3 7/16"	12-8001
10-0280	Panhead	3 7/16"	12-8001
10-0034	Shovelhead	3 7/16"	12-8001
10-0044	Shovelhead	3 5/8"	12-8001

### Screws

VT No.	Year	Type
8726-8		Lifter Base Screws
37-8519	1955-69	Cam Cover Screws



**Engine Case Bolt Kit** includes the necessary hardware to bolt together the engine cases of the years listed. Available as OEM stock in chrome, cadmium or acorn in chrome.

Acorn	Chrome	Cadmium	Fits
8127-34	8128-34	8129-34	1936-39 OHV Big Twin
8130-34	8131-34	8132-34	1940-47 OHV Big Twin
8133-34	8134-34	8135-34	1948-64 Panhead
8136-34	8137-34	8138-34	1965-68 Big Twin
8139-34	8140-34	8141-34	1970-78 Shovelhead
8142-34	8143-34	8144-34	1979-95 Shovelhead & Evo



12-0409



10-2535



10-2533

**Pinion/Sprocket Shaft Cage and Roller Kits** include STD size rollers, cages, washers and retaining ring for applications listed.

VT No.	Side	Year
12-0409	Sprocket	1941-54
10-2535	Pinion	1936-54
10-2551	Pinion	1955-57
10-2533	Pinion	1958-69



16-1264

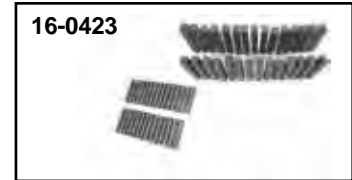

16-0423



16-1264

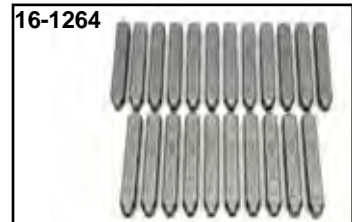

16-1264

**Motor Number Stamp Set** for FL models.

VT No.	Year
16-1039	1936-47
16-1264	1950-69
16-0423	1970-99



41-0151



41-0152

**Gasoila Sealant** available in hard setting red varnish or soft set blue/white with teflon. Red Sealant is the original sealer for inside crank cases or cam covers for sealing pin holes on porous surfaces. Blue/White seals threaded joints on pipe threads and fittings. Both types are insoluble in oil, gas and solvents. The ¼ pint can includes brush, each.

VT No.	Item
41-0151	Red Varnish
41-0152	Blue/White soft set

## Drain Plugs



8116-1



8117-1

**Engine Case Drain Plug/Oil Pump Body Plug** fits Big Twin case 1911-70, oil pump body 1968-84.

VT No.	Finish
8116-1	Chrome
8117-1	Cadmium
9675-1	Parkerized

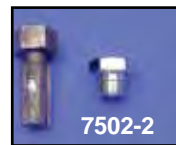

7502-2

**Chrome Oversize Plugs with Tap.**

Kit includes a tap and a dome head plug.

VT No.	Type	Includes
7502-2	Engine Drain	Plug and Tap
7503-1	Engine Drain	Oversize Plug
7500-2	Timing	Tap and Plug, Acorn
7501-1	Timing	Acorn Plug, Oversize
9407-1	Timing	Tap



# V-Twin Replica Case Set



10-0945

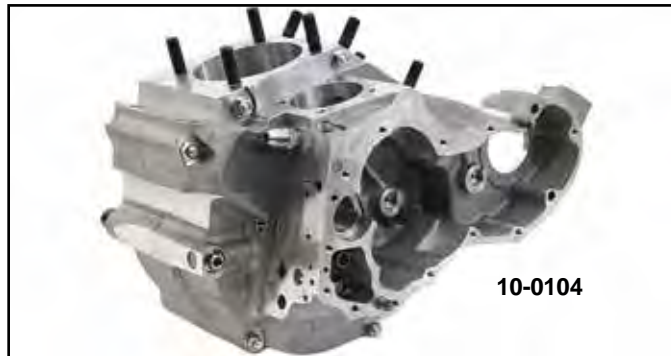

10-0104



49-0946



10-0825

**Knucklehead 1941-47 Left Hand Case and Case Set** features steel bearing insert cast in. Left hand case is machined to fit OE right side case. Order cylinder base studs and case race separately. Note: Cylinder deck height must be finished to match your case.

**VT No. Item**

10-0945 Set FL 1941-1947

10-0104 Set

49-0946 Case Left 74" 1941-47

60-0258 Matching Machine Service

10-1758 Right Side

10-0825 Left, 61" 1936-40

10-0345 Left 74" 1941-47

10-0942 Set, 61"



**Generator and Relay Mounts**



**Right Side Timing Cavity**



**OE Style Number Boss Detail!**

- Components are:**
- Cam Bushing or Bearing
  - Left Case Race or Timken Assembly
  - Idler Gear Stud
  - Circuit Breaker Stud
  - Oil Pump Drive Bushing
  - Right Case Bushing

- Cylinder Base Studs
- Dowel Pins
- Case Bolt Set
- Tappet Oil Screen
- Breather Tube
- Drain and Timing Plug



10-0954



10-0936

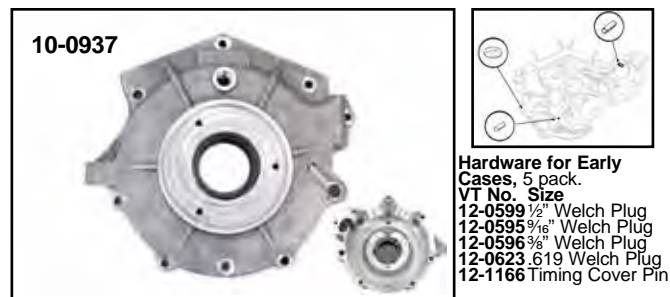

10-0937

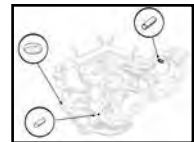

**Hardware for Early Cases, 5 pack.**  
**VT No. Size**  
 12-0599 1/2" Welch Plug  
 12-0595 9/16" Welch Plug  
 12-0596 3/8" Welch Plug  
 12-0623 .619 Welch Plug  
 12-1166 Timing Cover Pin



10-0938

**V-Twin "Shop Ready" Replica Case Sets and Replacement Left Hand Cases** for 1948-68 Big Twins feature left side number boss which is left blank. The 1948-54 case set used stock type loose rollers on both pinion and sprocket shaft and the 1956-69 case sets use a Timken bearing on the sprocket shaft and loose rollers on the pinion shaft side. Both the case sets and left hand only cases are slightly thicker than stock for added strength.

VT No.	Item	Fits
10-0954	Case Set	1948-54
10-0955	Case Set	1948-54
10-0294	Case Set	1955-62
10-1761	Case Set	1965
10-1820	Case Set	1966-69
10-0936	Left Case Only	1948-54
10-0937	Left Case Only	1955-64
10-0938	Left Case Only	1965-69





# Flywheel



10-1007

Replica Flywheel with stock rods



10-1045

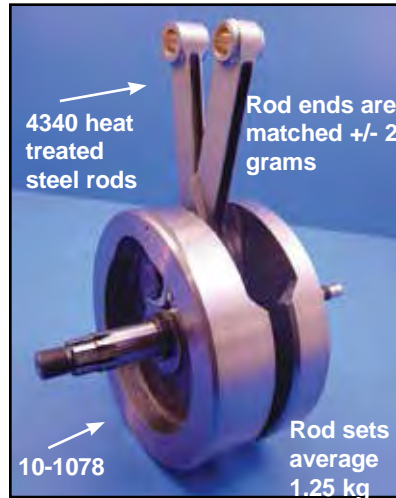

4340 heat treated steel rods

Rod ends are matched +/- 2 grams

10-1078

Rod sets average 1.25 kg

Guaranteed unbreakable 110,000 psi ductile iron flywheels

**Flywheel Assemblies** feature full weight flywheels, with removable pinion and sprocket shafts as original, trued and balanced for cast pistons. Units include forged and machined H-Beam Sifton connecting rod set of certified 4340 steel with multistage heat treatment and are fitted with Torrington Rollers, with alloy bearing retainer cages.

**Complete Flywheel Assembly** for OHV models, is shipped complete, assembled and trued with shafts.

VT No.	OEM	Fits	Note	Brand
10-1017	—	1973-90 74"	3,4	S&S
10-1098	Special	Alt-Gen 80"	1,2	V-Twin
10-1045	23906-78A	1973-E83 80"	2,4	V-Twin
10-1091	As Above	1973-90 80"	3,4	Sifton
10-1070	—	1936-40 61"	2	V-Twin
10-1172	—	1941-52 61"	2	V-Twin
10-1007	23906-41	1941-53 74"	2	V-Twin
10-1112	Stroker	1941-53 80"	2	V-Twin
10-1113	Stroker	1941-53 84"	2	V-Twin
10-1033	23907-54A	1954 Only	2	V-Twin
10-1034	23907-55A	1955-57	2	V-Twin
10-1008	23906-58	1958-64 74"	2	V-Twin
10-1090	—	1958-64 80"	2	V-Twin
10-1002	—	1958-64 80"	2	S&S
10-1000	23906-58	1958-64 74"	2	S&S
10-1001	23906-65A	1965-69 74"	2	S&S
10-1003	—	1965-69 80"	2	S&S
10-1089	—	1965-69 80"	2	V-Twin
10-1082	—	1965-69 74"	2	V-Twin
10-1096	23906-73	1973-77 74"	2	V-Twin
10-1048	23906-70	1970-72 74"	2	V-Twin
10-1047	Special	Alt-Gen 80"	1,3	S&S

**Notes:**

- 1-Special 80" flywheel assembly used for alternator-generator case sets only. Feature late type sprocket shaft and early style pinion shaft.
- 2-Features replaceable pinion and sprocket shafts and thick sprocket side flywheel.
- 3-Features replaceable pinion and sprocket shafts and narrow sprocket side flywheel.
- 4-Require use of 1987-up type pinion shaft bearing and retaining ring.



**Flywheel Thrust Washer Set** used on 1929-54, 61, 74 and 80 Twins, our set contains 2 more washers than the original set, one thinner and one thicker than stock. The 11-piece set contains one each of the following widths; .060, .066, .070, .074, .078, .082, .086, .090, .094, .098, and .102.

VT No. 10-1153 (Complete Set .060-.102 11 piece)

VT No.	Size	VT No.	Size	VT No.	Size
10-1300	.060	10-1304	.078	10-1308	.094
10-1301	.066	10-1305	.082	10-1309	.098
10-1302	.070	10-1306	.086	10-1310	.102
10-1303	.074	10-1307	.090		



10-1601

**Replica Flywheel Sets** feature cast construction to accept OE style components.

VT No.	Year	Model	Stroke
10-1601	1941-53	Big Twin, 74"	3.968
10-1126	1956-69	Big Twin, 74"	3.968
10-1602*	1973-99	Big Twin, 80"	4.250
10-1125	1972-78	Big Twin, 74"	3.968
10-1635*	1973-99	Big Twin	4.250

\*Note: 10-1602 features thick sprocket side flywheel and 10-1635 has narrow side flywheel.



**TRUETT & OSBORN**

**Truett & Osborn Flywheel Sets** feature original weight right and left sides with stock stroke.

VT No.	Fits	Type
10-1043*	1936-40 OHV 61"	Stock
10-1105	1941-52 OHV 61"	Stock
10-1005	1941-53 Big Twin 74"	Stock
10-1114	1941-53 Big Twin 80"	Stroker
10-1115	1941-53 Big Twin 84"	Stroker
10-1006	1956-69 Big Twin 74"	Stock
10-1124	1956-69 Big Twin 80"	Stroker
10-1025	1972-80 80" with 8° taper	Stock
10-1026	L1981-85 80" with 6° taper	Stock
10-1029	1970-71 Big Twin 74"	Stock
10-1028	1973-78 Big Twin 74"	Stock

\*Note: Accepts later tapered pin 1941-80 type.



# Stroker Flywheel



**Motor Shop Ready Stroker Flywheel Assembly with 4 1/2" stroker** is for all 1970-84 Shovelhead Big Twins. Complete flywheel is shipped fully assembled and trued, but not balanced.  
**VT No. 10-1093**



**10-0038**

**Flywheel Assembly with 4 5/8" stroker** is for 1973-84 Big Twins. These flywheels are machined from heat treated steel forgings which makes them structurally superior to cast iron designs. Flywheels are assembled with heavy duty rod set, trued and balanced for pistons listed. Piston sets must be ordered separately.  
**VT No. 10-0038**

**S&S 2900 Series Forged Stroker Piston Sets** machined to fit both 4 3/4" and 4 5/8" stroker flywheels. Includes rings, wrist pins and retainers. When used with 4 3/4" stroke compression will be 8.25:1 with 4 5/8" stroke compression will be 9:1 **Note:** Remember that an 80" 3 1/2" standard bore equals 3 7/16" + .060 bore size.

Size	3 7/16" Bore	3 1/2" Bore
Standard	<b>11-0455</b>	<b>11-0461</b>
.020	—	<b>11-0463</b>
.030	<b>11-0458</b>	—
.040	<b>11-0459</b>	—
.060	<b>11-0461</b>	—

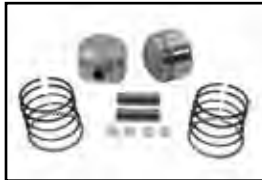

**Shovelhead 84" Hot Set Up** includes 4 1/2" assembled flywheels, 514 cam, spring kit, pushrods, Super 'E' carburetor kit and standard size piston kit. Yields 84 cubic inches with 8:1 compression ratio when used with 3 7/16" bore cylinders. Yields 86" cubic inches with 8:1 compression ratio when used with 3 1/2" bore cylinders. Order pistons separately.

VT No.	Fits	Bore
<b>11-1506</b>	1973-77	3 7/16"
<b>11-1507</b>	1978-84	3 1/2"



**S&S 2720 Series Piston Sets** for 84" Hot Set Up Kits includes rings, wrist pins and retainers.

Size	3 7/16"
Standard	<b>11-0830</b>
.010	<b>11-0831</b>

## Timing Plugs



**Timing Plugs** are available in stock size 5/8 — 18 thread unless noted as oversize (O.S) which is 1 1/16 — 16 thread.  
**A.** Acorn style plug fits all models Big Twin models timing plug holes and oil tanks.

**VT No. Type**  
**7106-1** Chrome

**B.** Acorn style plug with oversize thread and one tap for rethreading stripped out timing hole. Fits all timing holes.

**VT No. Type**  
**7500-2** Plug and Tap (Oversize)  
**7501-1** Plug Only (Oversize)  
**9407-1** 1 1/16" — 16 Tap (Oversize)

**C.** Stock timing plug.

**8114-1** Chrome  
**8115-1** Cadmium  
**9404-1** Cadmium (Oversize)  
**9304-1** Chrome (Oversize)  
**9714-1** Parkerized (Oversize)  
**9502-1** Chrome 1939-51  
**9504-1** Parkerized as above, 7/8" Hex  
**9503-1** As above cadmium



**10-0453**

**Special 6" Taper Sprocket Shafts** for use in S&S flywheels only. Include nut and key.

VT No.	Years	Flywheel Type
<b>10-0453</b>	1955-64	SE or SL
<b>10-0455</b>	1970-up	SE or SL
<b>10-0468*</b>	As Above	Motor Shop Brand

\***Note:** Does not include nut and key

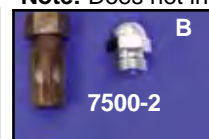

**D.** Functional and custom design plug fits all Big Twin models and Sportster timing plug holes and oil tanks.

**8610-1** Chrome  
**8611-1** Cadmium  
**E.** Allen style plug use on all 1970-up replaces 720.  
**9402-1** Chrome  
**9403-1** Cadmium  
**37-9206** Chrome by Gardner-Wescott  
**9960-1** Chrome (Oversize)





# Rod Assembly



**V-Twin™ Replica Stock Replacement Rod Sets** include new rods, crank pin, nuts, cages and standard rollers fitted and assembled. Piston pin bushings are installed and honed for stock wrist pin.  
**\*Note:** Includes step-crank pin.

VT No.	OEM	Years/Model
10-0186*	24277-37	1936-52 61" Pan-Knuckle
10-0173	24281-41A	1941-73 74" Pan-Shovel
10-0174	24281-74	1974-E81 74" & 80" Shovel
10-0175	24281-80	1981-83 80" Shovelhead



**Sifton™ Big Twin Rod Assembly** features forged and machined H-Beam design of certified 4340 steel with multi staged heat treatment and are fitted with Torrington rollers with extruded alloy cages and a Sifton™ pin and matching nuts. Unfinished type requires honing of upper and lower bushings. Rods are 7.440" center to center and will accommodate up to 5" stroke.

VT No.	Year	Item
10-0271	1941-81	Complete Assembly
10-0272	1981-99	Assembly
10-0274	Unfinished	Rods Only



**S&S Genuine Rods** are heavy duty replacement rod sets included wrist pin bushings, rod races, matched rods, pins, rollers/cages and nuts, for stock or stroker use. "Supreme" is recommended for drag strip applications.

Fits	S&S Heavy Duty	S&S Supreme
1936-52 61" Big Twin	10-0259*	—
1941-81 74" and 80" Shovelhead	10-0260*	10-0262*
	—	10-0263*

**\*Note:** Have 18 bearing steel cages others 17 roller alloy cases.



**Wrist Pin Bushings** for 1936-99 Big Twin are available in bronze replica type or Sifton Ampco 45. Replica type sold in pairs. Sifton type sold each.

Size	VT No.	Type
Standard	10-0756	Replica
Standard	10-0765	Sifton
.002	10-0757	Replica
.005	10-0758	Replica
.010	10-0759	Replica

# Roller Bearings

## Big Twin Connecting Rod Roller Sets.

Each set supplies enough rollers for that application only.

Size	Alloy Cage	Steel Cage
Standard	1973-86 10-0144	1941-72 10-0152
.0002o/s	10-0145	10-0153
.0004o/s	10-0146	10-0154
.0006o/s	10-0147	10-0155
.0008o/s	10-0148	10-0156
.003o/s	—	10-0159



## Bulk Pack Rod Rollers

### 1941-72 Big Twin

Size	Long	OEM	Short	OEM
Standard	—	9171A	—	9101A
.0002	—	9172A	—	9102A
.0004	—	9173A	12-4539	9103A
.0006	12-4532	9174A	12-4540	9104A
.0008	12-4533	9175A	—	9105A
.001	—	9176A	—	9106A

### 1973-86 Big Twin

Size	Long	OEM	Short	OEM
Standard	—	9186	—	9441A
.0002	—	9180	12-4554	9442A
.0004	—	9181	12-4555	9443A
.0006	12-4548	9182	—	9444A
.0008	12-4549	9183	—	9445A
.001	—	9184	—	9446A
.003	12-4552	—	—	—



## Steel Roller Retainer Cages.

VT No.	Application	U/M
12-0404	74 & 80	4 pc
12-0412	As Above, Jims	4 pc
49-0058	45 SV, OE	4 pc
12-4616	45 Roller Set	24 pc

## Big Twin Right Pinion

12-0400	24646-36	1936-54 Big Twin	2 pc
12-0413	24646-36	As Above, Sifton	2 pc

## Big Twin Left Side Sprocket

12-0401	24721-30	1930-54 Big Twin	2 pc
12-0414	24721-30	As Above, Sifton	2 pc

## 45" Left Sprocket

12-0424	24720-29	1929-73	
---------	----------	---------	--



# Crank Pin



10-1450



10-0135



10-0129



10-8357



10-0181

**Crank Pin Lock Kits** include two nuts, 2 locks and mount screws. Nuts and locks are also available separately.

VT No.	Year	Model
10-0335	1936-52	61" and 80"
10-0336	1941-53	74" Big Twin
10-0181	1954-Early81	Big Twin



10-0138

**Connecting Rod Race Set** fits 1936-99 Big Twin. Made from 52100 steel and hardened.

VT No.	Brand	Size
10-0138	Replica	STD
10-0828	Replica	.001 O/S
10-0826	Replica	.002 O/S
10-0830	Replica	.005 O/S
10-0829	Replica	.010 O/S
10-0823	Replica	.002 O/S
10-0809	Jims	STD

## Crank Pin Flywheel Washers

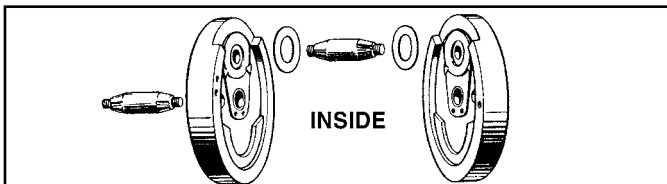

INSIDE

**Crank Pin Flywheel Washers** sold in pairs.

Inside	OEM	Type	Fits	Size
10-1150	6506	Bronze	1971-99 Big Twin	Standard
10-1149	6506B	Bronze	1971-99 Big Twin	.005
10-1284	23972-36	Steel	1936-52 Big Twin 61" OHO	Standard
10-1217	77972-21	Steel	1936-52 Big Twin 61" OHO	.005
10-1286	23973-41	Steel	1941-69 Big Twin OHO	.055
10-1163	—	Steel	1941-69 Big Twin OHO	.060
10-1215	23973-41A	Bronze	1941-69 Big Twin	.055
10-1216	23973-41B	Bronze	1941-69 Big Twin	.060

### Outside

10-1153	24100-17	1936-up Big Twin, All
---------	----------	-----------------------



17-0914

### Crank Pin Nut Lock Plate.

VT No.	OEM	Years	Model
17-0914	23971-41	1941-53	Big Twin
17-0927	23971-54	1954-E80	Big Twin
37-4050	1182	Screws	
2901-4	369-36	1936-40	EL, Lock Tab

Model	Years	OEM	Jims 3 Hole	Jims 1 Hole	Eastern 3-Hole	Eastern Super	V-Twin 2-Hole OHV
Big Twin OHV							
61" OHV Step	1940-52	23962-40 (Step Pin)	—	10-8363	10-0131	—	10-1450 .005 O.S.
74" & 80"	1941-Early81	23961-41	10-8356	—	10-0129	10-0134	10-0135
74" & 80"	1941-Early81	.025 Shorter	10-0352	—	—	—	—
80"	Late1981-99	23961-80A	10-8357	—	10-0130	—	10-1211
80"	Late1981-99	.001 Oversize	10-0353	—	—	—	—
80"		.002 Oversize	10-8358	—	—	—	—
80" 180° oiling	Late1981-99	180° Oiling	10-0354	—	—	—	—

**Crank Pins** are made of 8620 steel with .062 heat treated penetration. Also available are Eastern Super Type .120 heat treatment.



12-0535



12-0573



12-0521



12-0558

### Crank Pin Nut Sets.

Eastern	Jims	OEM	Year	Model
12-0535	12-0602	23966-36	1936-52	61" and 80"
12-0573	—	23967-41	1941-53	74" Big Twin
12-0521	12-0603	23966-54A	1954-Early 81	61" and 80"
12-0558	—	23969-80	1981-83	61" and 80"



**Crank Pin Keys** are sold in packs of 10. Replaces 23985-18, 1941-80 Big Twin.

VT No. 12-0201



10-2571



**Sifton Crank Pin Kit** includes crank pin, rod races, standard rod rollers and retainers.

VT No.	Years	Hole Type
10-2562	1941-80	2 Hole
10-2571	1981-99	2 Hole



10-2522

### Sifton Steel Rod Cage Set

includes four cages, 24366-51 and standard Torrington Roller Set for 1936-up Big Twin. Replaces 42385-40.

VT No.	OEM	Brand
10-2522	Kit	Sifton
12-0404	Cage Set	V-Twin
12-0412	Cage Set	Jims



10-0141

### Rod Bearing Sets With Set of Three Cages

fitted with standard size Torrington rollers for connecting rods. The cage material is noted. Fits 1936-86 74" and 80".



10-2566

VT No.	OEM	Cage
10-0141	24385-40B	Alloy
12-2556	S&S	Steel
10-2566	Cage Set	Alloy





# Sprocket Shaft



**Big Twin Sprocket Shafts** fit as listed, machined and hardened to factory specifications.

Model	Year	OEM	Jims	Eastern	Replica
61 & 74	1930-54	24001-30	<b>10-8314</b>	<b>10-0410</b>	<b>10-0469</b>
74	1955	24001-55	—	<b>10-0411</b>	—
74	1956-64	24001-56	<b>10-8362</b>	<b>10-0412</b>	<b>10-0398</b>
74	1965-69	24001-65	<b>10-8315</b>	<b>10-0413</b>	<b>10-0476</b>
74	1970-71	24001-70	<b>10-8322</b>	<b>10-0414</b>	—
74 & 80	1972-E81	24001-72	<b>10-8316</b>	<b>10-0415</b>	<b>10-0876</b>
80	L1981-86	23909-80	<b>10-8318</b>	<b>10-0416</b>	<b>10-0440</b>

Special to install pre1981 80" Flywheels in 1956-64 BT **10-0418**  
Special to install pre1981 80" Flywheels in 1965-69 BT **10-0419**  
Special to install 1981-85 80" Flywheels in 1956-64 BT **10-0435**  
Special to install 1981-85 80" Flywheels in 1965-69 BT **10-0436**

**Left Crankcase Bearing.** Factory assembled with correct spacer for proper end play.

Timken	VT No	OEM	Fits	Model
<b>12-0310</b>	<b>12-0427</b>	9029	1955-68	Big Twin
<b>12-0309</b>	<b>12-0428</b>	9028	1969-up	Big Twin



**Sprocket Shaft Key.** Sold in 10 pack.

VT No.	OEM	Fits
<b>12-0200</b>	23985-12	1930-55 Big Twin
<b>12-0203</b>	23985-56	1956-80 Big Twin

VT No.	Type	Years	Length
<b>10-8286</b>	V-Twin & S&S	1955-64	.473
<b>10-8269*</b>	.335 Long	1955-64	.335
<b>10-0427</b>	V-Twin & S&S	1965-69	.671
<b>10-8270*</b>	STD	1965-69	.666
<b>14-0108</b>	All	Seal only	5 pack

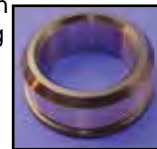

**Engine Shaft Spacer** features built in seal flange to give added support for alternator rotor.



**VT No. 10-0948**

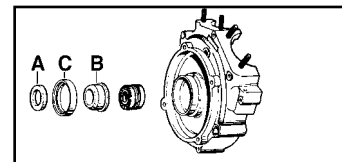

**Sprocket Shaft Spacers** fit Big Twins left side thru seal.



VT No.	#	OEM	Year	Length	U/M
<b>7410-1</b>	C	24031-55	1955-69	Seal	Each
<b>14-0108</b>	C	12026B	1970-99	Seal	5 pack
<b>10-1160</b>	A	24029-55	1955-64	.336	
<b>10-2509</b>	A	24029-65	1965	.621	
<b>10-2513</b>	A	24032-66	1966-69	.516	
Set	A	24033-66	1966-69	.546	
of	A	24034-66	1966-69	.576	
6	A	24035-66	1966-69	.606	
	A	24036-66	1966-69	.636	
	A	24037-66	1966-69	.666	

**Lock Plate, Sprocket Shaft.** Sold in 10 pack.

VT No.	Fits
<b>17-0913</b>	1936-71
<b>17-0917</b>	1972-81

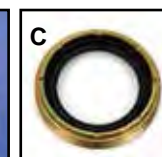
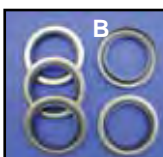

**Big Twin Left Side Engine Case Seals.**

VT No.	#	OEM	Year	Model
<b>7411-2</b>	A	24776-40	1936-54	61-74-80
<b>14-0965</b>		24031-55	1955-68	OE type
<b>7410-1</b>	C	24031-55	1955-68	Colony
<b>7410-1-OS</b>		Oversize	1955-68	Colony (+.002)
<b>7410-1-US</b>		Undersize	1955-68	Colony (-.002)
<b>14-0177</b>		Seal only	For above	
<b>14-0185</b>	B	24031-69	1969 only	Big Twin
<b>14-0108</b>	B	12026B	1970-99	74 and 80 Big Twin, each



**Note:** VT No. 7410-1, area screw-in insert with integral seal. VT No. 14-0965 is stock type screw-in without seal. VT No. 7411-2, 8211-2 both include seal, spacer and snap ring.



**1970-94 Sprocket Shaft Spacer and Seal Kit.**  
**VT No. 10-8284**



**Left Sprocket Shaft Bearing and Hardware Kit** for 1941-54 Big Twin includes loose rollers, cages and end slinger.  
**VT No. 12-0409**



**Left Bearing End Oil Slinger** replaces 24776-40. Fits 1940-54 Big Twin.  
**VT No. 10-0429**



**Engine Sprocket Nut Kit** for 1930-54 Big Twin includes correct nut, key retaining ring and left bearing oil slinger.  
**VT No.** **Item**  
**12-0620** Kit  
**12-0503** Nut only

# Pinion Shaft



**Nut Pinion Shaft Gear End, each.**  
**Eastern Jims OEM Fits**  
**12-0507 12-0613 24023-54 1954-89 Big Twin**



**Pinion Shaft Screws, left-hand, 1951-53 Big Twin. Replaces 24020-51, 5 pack. VT No. 10-0518**



**Lock Plate, Pinion Shaft Nut, 10 pack.**  
**VT No. OEM Fits**  
**17-0913 24015-36 1936-80 Big Twin**  
**17-0929 24016-29 1929-73 45"**  
**12-0209 11218 Taper 1981-92**



**Pinion Keys available in ten packs.**



VT No.	OEM	Type	Fits
12-0202	23985-54	Gear	1954-75
12-0205	26348-15	Gear	1975-86
12-0200	23985-12	Taper	1941-81
12-0209	11218	Taper	1981-92



**Pinion Bearing Sets** for right side includes rollers and cages for Big Twin 61, 74 and 80. OHV and SV. Washers and snap rings included when required except where \*noted.

VT No.	Year
10-2535	1936-54
10-2551	1955-57
10-2533	1958-86

**Case Rollers.**

1940-E54 OHV Big Twin, Big Twin Right Side replaces 9261, 12 per set.

**Size 12-Piece 100 Pack OEM**

Standard	10-0307	12-4523	9261
.0002	10-0308	—	9262
.0004	10-0309	12-4525	9263
.0006	10-0310	12-4526	9264
.0008	10-0311	—	9265
.001	10-0312	12-4528	9266

1955-57 Big Twin Right Side Case Roller Sets, 13 per set.

**Size 13-Piece 100 Pack OEM**

Standard	10-0326	—	9421
.0002	10-0327	12-4518	9422
.0004	10-0328	12-4519	9423
.0006	10-0329	12-4520	9424
.0008	10-0330	12-4521	9425
.001	10-0331	12-4522	9426

1958-86 Big Twin Right Side Case Rollers, 28 pc.

**Size 28-Piece 100 Pack OEM**

Standard	10-0319	—	9220
.0003	10-0339	—	9218
.0002	10-0320	—	9221
.0004	10-0321	12-4512	9222
.0006	10-0322	—	9223
.0008	10-0323	12-4514	9224
.001	10-0324	—	9225
.002	10-0325	—	—

Late 1954 Big Twin Right Crankcase Rollers, 12 pc.

**Size 12-Piece 100 Pack OEM**

Standard	12-4573	12-4593	9241
.0002	12-4602	—	9242
.0004	12-4575	12-4595	9243
.0006	12-4574	12-4594	9244
.001	12-4604	12-4605	9246

1940-54 Big Twin Left Side Case Rollers, 24 per set.

**Size 24-Piece 100 Pack OEM**

Standard	10-0300	—	9220
.0002	10-0301	—	9221
.0004	10-0302	12-4512	9222
.0006	10-0303	—	9223
.0008	10-0304	12-4514	9224
.001	10-0305	—	9225



**All Rollers by TORRINGTON®**

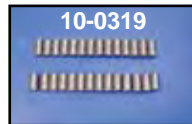

Big Twin Pinion Shafts.					
Model	Year	OEM	Jims	Eastern	Replica
61 & 74	1939-53	24006-39	10-8323	10-0400	10-0441
61 & 74	1954-57	24006-54A	10-8324	10-0401	10-0422
74	1958-72	24006-58	10-8325	10-0402	10-0488
74 & 80	1973-80	24006-73	10-8326	10-0403	10-0875
80	1981-82	24006-80	10-8328*	10-0408	—
80	1983-86	24006-83	10-8328	10-0409	10-0439

\* Requires use of late 3/4 x 20 nut 24016-80



**Pinion Shaft Nut, Taper End.**  
**Eastern Jims OEM Fits**  
**5 pack Each**  
**12-0532 12-0612 24023-36 1936-E81 Big Twin**  
**12-0517 12-0609 24016-80 L1981-83 Big Twin**



**Case Race** machined and ground to factory specifications.

**Replica brand** is manufactured by Sifton.

**Sprocket Left Side Case Race for OHV and 1940-48 Big Twin Side Valve.**

Jims	Eastern	OEM	Size	Year/Model
10-0235	10-0208	24621-40	Standard	1940-54 Big Twin
—	10-0279	Replica	Standard	1940-54 Big Twin
—	10-0209	—	.005	1940-54 Big Twin
—	10-0210	—	.010	1940-54 Big Twin
—	10-0211	—	.015	1940-54 Big Twin

**Pinion Right Side Case Race**

10-0240	10-0204	24599-40	Standard	1940-54 Big Twin
—	10-0293	Replica	Standard	1940-54 Big Twin
10-0241	10-0205	—	.005	1940-54 Big Twin
—	10-0206	—	.010	1940-54 Big Twin
—	10-0207	—	.015	1940-54 Big Twin
10-0243	10-0212	24599-55	Standard	1955-57 Big Twin
10-0244	10-0213	—	.005	1955-57 Big Twin

**1958-92**

10-0245	10-0214	24599-58A	Standard	1958-92 Big Twin
—	10-0278	Replica	Standard	1958-92 Big Twin
10-0246	10-0215	—	.002	1958-92 Big Twin
—	10-0216	—	.005	1958-92 Big Twin
10-0248	10-0217	—	.010	1958-92 Big Twin
—	10-0230	—	.015	1958-92 Big Twin

**1936 OHV Case Races.** Note: VT No. 10-2498

—	10-0226*	413-36	1936-39	Right	—
Standard	—	—	1936-39	Right	.005
—	10-0228*	416-36	1936-39	Left	—
Standard	—	—	1936-39	Left	.002

\*Note: Fits 1937-39 Big Twins, 1936 Overhead Valve.





# Big Twin Internal Spacer

## 1940-57

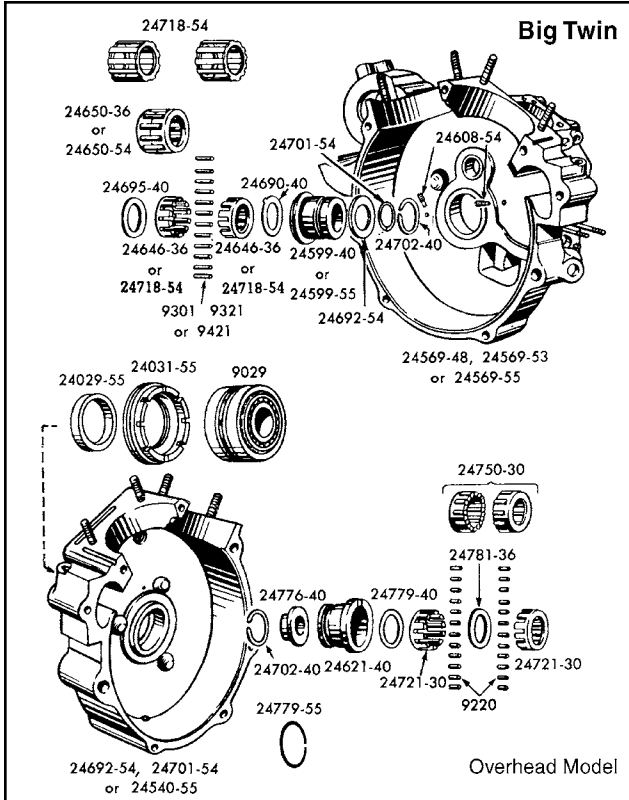

Spacers for 1940-57 Big Twin models.

VT No.	OEM	Description
12-0310	9029	1955-68 Left Crankcase Bearing, each
10-1160	24029-55	1955-64 Sprocket Shaft Spacer .336, 5 pack
14-0965	24031-55	1955-57 OEM type Insert
7410-1	24031-55	1955-57 Sprocket Shaft Seal and Nut, each
14-0177	—	Seal Only for Above, each
12-0400	24646-36	1937-53 Right Roller Bearing Retainer, pair
10-1155	24690-40	1940-50 Right Bearing Washer, 5 pack
10-1154	24692-54	1954-57 Right Bearing Washer, 5 pack
10-1156	24695-40	1940-54 Right Bearing Spacer, 5 pack
12-0913	24701-54	1954-57 Right Bearing Retainer Ring, 10 pack
12-0914	24702-40	1940-54 Crankcase Bearing Ring, 10 pack
12-0403	24718-54	1954-57 Right Roller Bearing Retainer, each
12-0401	24721-30	1930-54 Left Roller Bearing Retainer, pair
10-0429	24776-40	1940-54 Left Bearing End, each
10-1158	24779-40	1940-54 Left Bearing Washer, 5 pack
12-0935	24779-55	1955-69 Left Bearing Retainer Ring, each
10-1159	24781-36	1937-57 Left Bearing Spacer, 5 pack



Steel Roller Retainer Cages.

VT No.	OEM	Year	Brand
<b>Big Twin Right Pinion</b>			
12-0400	24646-36	1936-54 Big Twin	V-Twin
12-0413	24646-36	1936-54 Big Twin	Sifton
12-0402	43578-35	1958-up Big Twin	Sifton
<b>Big Twin Left Side Sprocket</b>			
12-0401	24721-30	1930-54 Big Twin	V-Twin
12-0414	24721-30	1930-54 Big Twin	Sifton

## 1958-99

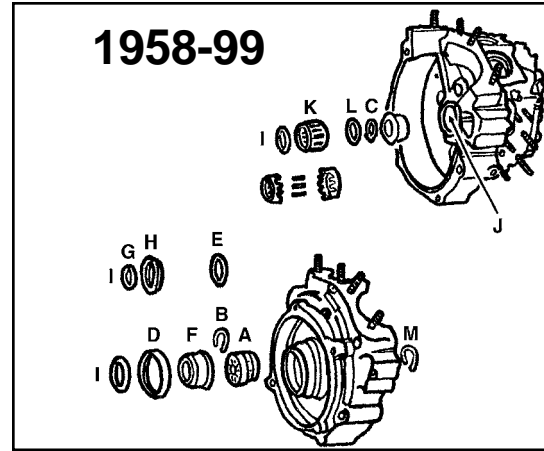

Spacers for 1958-99 Big Twin Models.

VT No.	OEM	Description
12-0310	9029	(A) 1955-68 Left Crankcase Bearing
12-0427	9029	(A) 1955-68 Left Crankcase Bearing, VT
12-0309	9028	(A) 1969-up Left Crankcase Bearing
12-0947	11160	(B) 1985-up Left Bearing Retainer Ring
12-0904	11007	(C) 1958-86 Right Bearing Retainer Ring
12-0946	11177	(C) 1987-92 Right Bearing Retainer Ring
12-0967	11177A	(C) 1993-99 Right Bearing Retainer Ring
14-0965*	24031-55	(D) 1958-68 Crankcase Seal OEM type
7410-1*	24031-55	(D) 1958-68 Crankcase Seal
14-0185	24031-69	(D) 1969 Crankcase Seal
12-0712	23741-55	(E) 1955-84 Crankcase Bearing Shim .003
10-0427	240003-70	(F) Sprocket Shaft Spacer
10-1160	24029-55	(G) 1955-64 Sprocket Shaft Spacer .336 1966-68
10-2509	24029-65	(G) 1965-only Sprocket Shaft Spacer .621
10-2513		(I) Includes the one each of the following 1966-69 Sprocket Shaft Spacers:
Set of Six		24032-66 Size .516, 24033-66 Size .546, 24034-66 Size .576, 24035-66 Size .606, 24036-66 Size .636, 24037-66 Size .666
12-0250	24608-54	(J) Screw right case bushing
10-2533	24650-58	(K) 1958-86 Right bearing assembly, standard
10-1157	24692-58	(L) 1958-86 Right bearing washer
12-0935	24779-55	(M) 1955-69 Left bearing retainer ring
12-0402	43578-35	(N) 1958-66 Right bearing retainer

\*Note: 7410-1, 7410-55 are a screw-in inserts with integral seals. VT No. 14-0965 is original screw-in type without seal.



# Big Twin Pinion Hardware

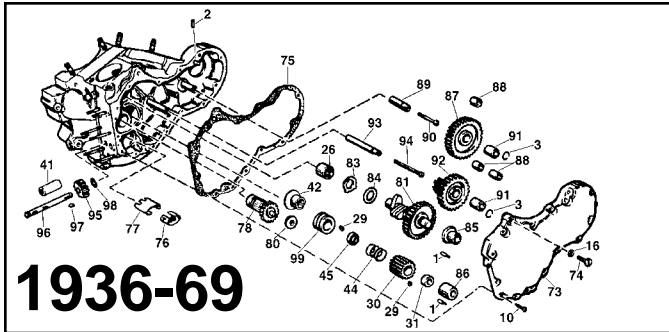

## 1936-69

VT No.	OEM	#	Year/Item
12-1175	271	1	1936-up Bushing Pin
12-1166	377	2	1941-69 Pin
12-0915	25810-15	3	1937-57 Idler and Circuit Breaker Shaft Retaining Ring
8149-12	Chrome	10	1936-69 Screw, set
8150-12	Cadmium	10	1936-69 Screw, set
10-0714	25597-36	26	1936-57 Cam Bushing
10-2527	As Above	26	.005 Oversize
12-0316	9058	26	1958-up Needle Bearing
12-0202	23985-54	29	1954-up Key
12-1379	24010-54	30	1954-77 Pinion Gear
12-1399	24010-39	30	1939-53 Pinion Gear
12-0507	24023-54	31	1954-89 Nut
10-0703	24641-36	41	1936-up Bushing
12-1525	24692-40	42	1940-53 Seal Ring
13-0105	24699-37	44	1937-69 Spring
12-1521	24703-54	45	1954-69 Spacer
12-1520	24703-40	45	1940-53 Spacer
10-0065	25216-36	73	1936-47 Gear Cover
10-0066	25216-48	73	1948-53 Gear Cover
10-0068	25216-58	73	1954-62 Gear Cover
10-0077	25216-65	73	1963-65 Gear Cover
8771-2	25218-63	74	1963-65 Chrome Bolt with 16
8772-2	25218-63	74	1963-65 Cadmium Bolt with 16
15-0122	25225-36C	75	1941-69 Gasket
12-1517	25275-36	76	1936-69 Breather Screen
12-1518	25279-36	77	1936-69 Separator
12-9967	25300-36	78	1936-47 Breather Valve Standard, S&S
12-9968	—	78	As Above, .030 Oversize
12-9907*	25300-36	78	1941-77 Breather Valve Standard, S&S
12-9956*	—	78	As Above, .030 Oversize
12-9909	S&S	80	Washers for above, set
12-1536	25300-36	78	1941-77 Breather Valve Std, includes 8 pc washer set
12-1509	25313-50	80	1950-78 .115, 4 pack, one of each
	25314-50		.120 Breather
	25315-50		.125 Washer
	25316-52		.110 Set
17-0908	25550-57	83	1958-up Lock Washer
10-1254	25550-84	84	1984-up .045 Thick
12-1508	—	84	1936-up Cam Gear Washer Set .050-.095
		84	.050 Cam Gear Washer
12-1440	25550-36	84	.055 Cam Gear Washer
12-1441	25551-36	84	.060 Cam Gear Washer
12-1425	25552-36	84	.065 Cam Gear Washer
12-1426	25553-36	84	.070 Cam Gear Washer
12-1427	25554-36	84	.075 Cam Gear Washer
12-1428	25555-36	84	.080 Cam Gear Washer
12-1429	—	84	.085 Cam Gear Washer
12-1430	—	84	.090 Cam Gear Washer
12-1431	—	84	.095 Cam Gear Washer
12-1432	—	84	.100 Cam Gear Washer
12-1433	—	84	1941-69 Bushing, Standard
10-0704	25581-36	85	.005 Oversize
10-2524	As Above	86	1936-53 Cam Cover Bush Standard
10-0706	25582-36	86	1936-53 .005 Oversize
10-2526	As Above	86	1954-72 Bushing, Standard
10-0707	25582-54	86	.005 Oversize
10-2529	As Above	86	1936-69 Idler Gear, S&S
12-1388	25775-36	87	1936-69 Idler Gear
12-1397	25775-36	87	1936-69 Idler Gear with Holes
12-1393	As Above	87	1936-69 Idler Bushing
10-0716	25785-30A	88	1936-69 Idler Stud
10-0801	25791-36	89	1936-69 Screw
12-0198	25794-36	90	1936-69 Spacer
10-0807	25800-36	91	1936-69 Spacer, .750 Outside Diameter
10-0808	25800-36B	91	1936-69 Retainer Ring
12-0915	25810-15	92	1936-69 Circuit Breaker Drive Gear
12-1396	25850-36A	92	1936-47 Circuit Breaker Drive Gear
12-1479	25850-36	92	1936-69 Circuit Breaker Drive Gear, S&S
12-1389	25850-36A	92	1936-69 Circuit Breaker Drive Gear Stud
10-0802	25856-36	93	1936-58 Circuit Breaker Stud Screw Right Hand
12-0199	25859-36	94	1959-69 Screw, Left Hand
12-0196	1430	94	1939-72 Drive Gear, 25T
12-1449	26345-39	95	1936-67 Gear Shaft
12-0803	26346-36	96	1968-69 Gear Shaft
12-0804	26346-68	96	1936-up Oil Pump Key
12-0205	26348-15	97	1936-69 Ret. Ring
12-0916	26348-36	98	1939-53 Drive Gear
12-1395	26349-39	99	1939-53 Drive Gear
12-1496	26349-39	99	1954-72 Drive Gear
12-1450	26349-54	99	1954-72 Drive Gear

Note: Must be used with 1954-77 Pinion and Cam Gears.

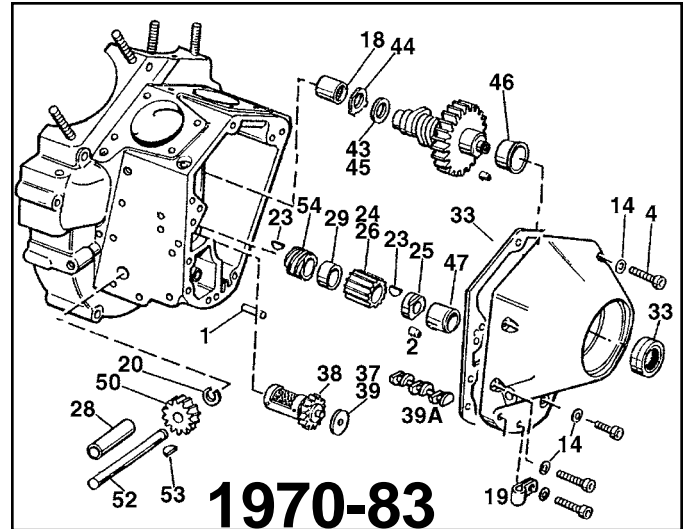

## 1970-83

### 1970-83 Big Twin Pinion Hardware

VT No.	OEM	#	Year/Item
12-1184	275	1	1970-up Bushing Pin
12-1153	358	2	1970-up Dowel Pin
8761-7	Kit	4	1970-92 Chrome Allen Screw Set
9305-7	Kit	4	1970-92 Stock Chrome Screws
9306-7	Kit	4	1970-92 Stock Cadmium Screws
9633-50	6099	14	1970-up Washer, Chrome
12-0316	9058	18	1970-up Needle Bearing
37-8971	10046	19	1981-up Wire Clamp
12-0901	11002	20	1970-up Oil Pump Retainer Ring
12-0202	23985-54	23	1970-up Key, Gear Shaft
12-1379	24010-54	24	1970-77 Pinion Gear
Note:	24040-78	24	Late 1977-up Pinion Gear
See Chart for Pinion Gear Listing			
12-0507	24023-54	25	1970-89 Pinion Gear Nut
12-0613	24023-54	25	1970-89 Pinion Gear Nut, Jims
10-0703	24641-36	28	1970-up Oil Pump Shaft Bush
12-1539	24703-54B	29	1970-89 Pinion Gear Spacer
12-9922	24704-90	29	1990-up Pinion Gear Spacer
15-0871	25225-70B	33	1970-92 Gasket and Seal Kit
12-9907*	25300-36	38	1941-77 Breather Valve, S&S
12-9956*	—	38	1941-77 Breather Valve, S&S, .030 Oversize
12-9906	25313-77	38	1978-85 Breather Valve, S&S
12-9957	—	38	1978-85 Breather Valve, S&S, .030 Oversize
12-9909	S&S	37	Washers for Above (Set)
12-1536	25300-36	38	1941-77 Breather Gear, Sifton Steel includes 8-piece thrustwasher set
12-1537	25313-77	38	1978-99 Breather Gear, Sifton Steel
12-1531	25310-82	38	1982-90 1992-up Breather Valve (Plastic)
12-1509	25313-50	39	1950-78 .110-.125 4 Piece Set
12-1510	—	39	1979-82 .110-.145 Set, 8 pack
12-1530	Nylon	39	1982-up .130-.165 Set, 8 pack
12-1508	25550-36	43	1970-up Cam Gear Washer Set .050-.095 (10 pieces)
10-1254	25550-84	43	1984-up .045 Thick, 5 pack
12-1440	—	43	.050 Cam Gear Washer
12-1441	—	43	.055 Cam Gear Washer
12-1425	—	43	.060 Cam Gear Washer
12-1426	—	43	.065 Cam Gear Washer
12-1427	—	43	.070 Cam Gear Washer
12-1428	—	43	.075 Cam Gear Washer
12-1429	—	43	.080 Cam Gear Washer
12-1430	—	43	.085 Cam Gear Washer
12-1431	—	43	.090 Cam Gear Washer
12-1432	—	43	.095 Cam Gear Washer
12-1433	—	43	.100 Cam Gear Washer
12-1433	—	43	1958-up Lock Washer, 5 pack
10-0705	25581-70	46	1970-up Bushing
10-2525	25581-70	46	1970-up Bushing, .005 Oversize
10-0707	25582-54	47	1954-72 Bushing, Standard, each
10-0708	25582-73	47	1973-92 Bushing Standard
10-2529	As Above	47	1973-92 Bushing .005 Oversize
12-1407	26345-73	50	1973-up Drive Gear, 24T
12-0805	26346-70	52	1970-up Gear Shaft
12-0205	26348-15	53	1936-up Oil Pump Key, 10 pack
12-1450	26349-54	54	1954-72 Drive Gear
12-1408	26349-73	54	1973-83 Drive Gear

\*Note: Must be used





# Big Twin Oil Pump Assembly

## Replica Oil Pump



12-9969



12-9801

Washers

**Sifon™ Oil Pump Assembly** features improved oil pump pressure regulation that will ensure correct oiling to all areas of Big Twin engines. This pump kit includes all necessary fittings, snap rings, keys, gaskets and mounting bolts. Can be used on either chain drive or belt drive models. **Note:** On 1970-80 models a drilling operation is required, use VT No. 16-0986 drill fixture. Available with breather gear kit. Oil pump kits with breather include drive gear, breather gear and washers, uses S&S style gaskets.

Pump	Pump With Breather	Year	Finish
12-9969	12-9800	1936-53	Polish
12-9970	12-9801	1936-53	Chrome
12-9969	12-9806	1954-72	Polish
12-9970	12-9807	1954-72	Chrome
12-9971	12-9802	1973-91	Polish
12-9972	12-9803	1973-91	Chrome

**S&S Complete Oil Pump Assemblies** with billet bodies. Include all internal gears and shafts for years listed. Also available as complete kits that include drive shaft gear, pinion shaft gear and breather gear kit.

### Oil Pump Assembly

VT No.	Years
12-8001	1936-72
12-8002	1973-91



12-8002

### Oil Pump Kits with Breather Assembly

12-8008	1973-91
---------	---------

**Note:** S&S Oil Pumps are machined for two basic groups 1936-72 and 1973-91. Installations on engines from 1936-1969 and 1981-91 are strictly bolt on and require no modifications. Engines from 1970-80 require a simple drilling step and engines from 1970-72 require a plugging step. Both steps can be performed while the engine is still in the chassis. All 1973-76 applications require 1977-up diameter pinion and cam gears.

Warranty: All Oil Pumps are covered under our "exchange only" provision. No credit will be issued as these items are exchange only



12-0105



**Oil Pump Cover** fits 1968-91 type without chain oiler. Order allen screws separately.

VT No.	Item
12-0105	Chrome Cover
12-0106	Polished Cover
12-0109	Cast Cover
8746-12	1/4" - 24 Screws 1968-77
8747-12	1/4" - 24 Screws 1978-91



**Pro Just Adjustable Pressure Relief Cap** allows the precise adjustment of oil pressure by turning the adjusting screw clockwise to increase oil pressure or counterclockwise to reduce oil pressure. Comes with a "super pump" spring provided in our spring kit 13-9222. Works in stock 1981-99 oil pumps as well as S&S and other aftermarket oil pumps. Fits 1981-99 without oil vent. **VT No. 12-9921**



12-9931

**Complete Cast Iron Oil Pump Assembly** for 1950-67 Big Twin, replaces 26201-48D.

VT No.	Item
12-9931	Complete Assembly
12-0295	Rebuild



12-1947



12-1947

**Replica Style Big Twin Oil Pump** for 1941-49 V-Twin includes cast outer cover without rotator.

VT No.	Item
12-1947	Complete
12-9750	Cover Only
40-0509	Fitting
40-0297	Fitting
12-0271	Rebuild



40-0561

**Oil Pump Fitting Kit** fits 1968-84 Big Twin models.

**VT No. 40-0561**

**Chain Oil Adjuster Screws** sold each.

VT No.	OEM	Fits	Head
12-1404	26383-32	1941-53 FL-FX	Hex
12-1476	26383-32	1936-48 Big Twin Slot	
12-0584	63610-53A	1954-64 Big Twin Slot	



12-1404



12-1476



12-1482

**1936-40 Overhead Valve Knucklehead Oil Pump Parts.** Hardware kit includes by-pass kit, adjusting screw kit and gaskets.

VT No.	Item
12-1480	Hardware Kit
12-0477	Pump Assembly
12-1482	Oil Pump Cover, 282-36
12-1545	Oil Pump Cover, Cad
12-0452	Body
12-0453	Body
12-0296	Rebuild Kit
40-1421	Fitting
12-0109	Parkerized Cover



12-0477

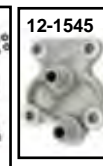

12-1545



42-0011



42-0041

**Chrome Oil Pump Covers** mount onto the existing bolts on Big Twin models

VT No.	Years
42-0041	1970-84 with chain oiler fitting
42-0011	1980-91

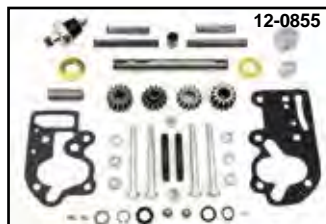

12-0855

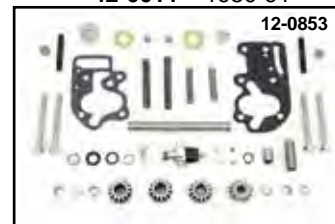

12-0853

### Oil Pump Rebuilds.

12-0296	1936-40
12-0271	1941-49
12-0295	1950-67
12-0855	1968-69
12-0853	1970-72
12-0297	1973
12-0852	1974-77
12-0851	1978-91



12-0851

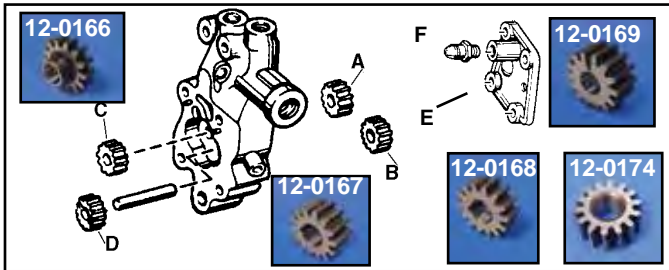

VT No.	Jims	#	OEM	Type	Year
12-1449			26345-36	Drive Gear	1936-72
12-1220			26325-36	Scavenger Idler	1936-40
12-1221			26315-36	Feed Gear	1936-40
12-0179			26317-36	Feed Idler	1936-40
12-0167			26320-36	Scavenger	1936-40
12-0168			26315-48	Feed	1948-61
	12-1434	A	26315-68A	Return Drive	
12-0166		B	26317-48	Idler Feed	1948-61
12-0170		B	26317-62	Idler Feed	1962-67
12-1420	12-1435	D	26317-68A	Return Idler	
12-0167		C	26320-36	Scavenger Gear	1936-up
12-0169		D	26325-49	Scavenger Idler	1949-62
12-0174		D	26326-62A	Scavenger Idler	1962-up
12-0801			26327-68	Idler Shaft	1968-99
12-0800			26327-52	Idler Shaft	1962-67
12-0802			26328-41	Idler Shaft	1941-66
12-1437		A	26328-74	Feed Drive	
12-9905		E	26237-50	Cover	1948-67
12-0801			26327-68	Idler Shaft	1968-99
12-0805			26346-70	Drive Shaft	1970-99
12-0812			26346-36	Drive Shaft	1936-67
12-0803			26346-36	Drive Shaft	1936-67
12-0804			26346-68	Drive Shaft	1968-69
10-0703			24641-36	Bushing	1936-99
40-0510		F	26424-50	Fitting	1948-67
12-0204			26340-36	Key	1941-67
12-0205			26348-15	Key	1936-67
16-1033				Burnish Tool	All

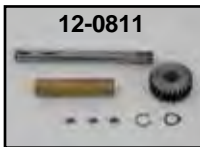

**Sifton Big Twin Oil Pump Drive Shaft Kit** includes 3 keys, shaft gear, bushing and snap ring.

Kit	Shaft	Year
12-0808	12-0812	1936-67
12-0809	12-0804	1968-69
12-0811		1970-72
12-0810	12-0805	1973-99



**Oil Pump Mounting Screw** replaces 1397 for use on all 1941-49 Big Twin models.  
VT No. 12-1405

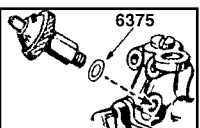

**Sealing Washers** for oil fitting, pressure switch, relief valve, check valve, and tappet oil screen in brass.

VT No.	OEM	Fits	Type
14-0031	6156	1941-69	Big Twin Adjuster Screw
14-0032	6581	1954-78	Big Twin Relief Valve Plug
14-0033	6377	1950-99	Big Twin Oil Pressure
14-0178	6375	1946-57	Big Twin Pressure Switch

# Oil Pump

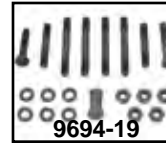
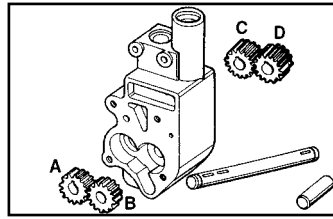

**Replica Oil Pump Mount Kits** for Big Twins includes studs where required. Available as stock style fasteners in chrome, cadmium, parkerized or zinc finish or as custom kits in acorn or allens.

Chrome	Cadmium	Parkerized	Zinc	Acorn	Allen	Years/Style
8740-19	8741-19	9694-19	—	—	—	1936-67 OHV
8742-14	8743-14	—	—	—	8746-12	1968-77 Stock
8744-12	—	—	9787-12	7827-12	8747-12	1978-91 Stock



**S&S Oil Pump Gasket and Master Rebuild Kits** are available with paper or mylar gaskets. Gasket kits include inner and outer gaskets, drive shaft key and snap ring. Master rebuild kits include seal, snap rings, springs, ball, inner and outer gasket, O-rings, and keys.

Gasket Kit	Master Rebuild Kit	Type	Year
15-0657	—	Mylar	1936-91
15-0658	15-0361	Paper	1936-91
15-0362	15-0364	Mylar	1992-99
15-0363	—	Paper	1992-99

**A-Long Oil Pump Nut** with 1/4-24 thread. Used on 1936-67 OHV. Sold each.

VT No.	Finish
8108-1	Chrome
8109-1	Cadmium
9674-1	Parkerized



**B-Standard 1/4 - 24 Thread Hex Nut**, 12 pieces.

8110-12	Chrome
8111-12	Cadmium
9673-12	Parkerized

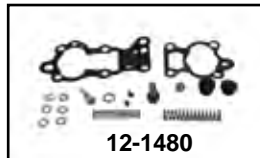

**Oil Pump Gasket Kits** include gaskets, seals, snap ring, balls and keys. Spring and ball bearing not included with James kits.

James	GB No.	Type	Year/Model
—	12-1480	Paper	1936-40 Over Head Valve
15-1184	14-0008	Paper	1941-49 Big Twin
15-0851	14-0009	Paper	1948-67 Big Twin
15-0852	15-0193	Mylar	1968-80 Big Twin
15-0853	14-0025	Paper	1968-80 Big Twin
15-0854	15-0233	Mylar	1981-91
15-0855	14-0026	Paper	1981-91

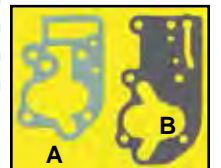

**Big Twin Oil Pump Gaskets** are available in 10 pack.

James	GB No.	#	OEM	Use	Years
15-0939	15-0127	B	26246-68A	Case	1968-80
—	15-0455		26246-68A	Case	1968-80
15-0952	15-0137	B	26273-80B	Case	1980-91
—	15-0727		26245-41	Case	1941-67 (Mylar)
15-0126	—		26245-41	Case	1941-67 (Mylar)
15-0949	15-0293	A	26258-68B	Cover	1968-80
15-0940	15-0294	B	26246-68A	Case	1968-80
15-0953	15-0295	B	26273-80B	Case	1980-91
15-0956	15-0296	A	26276-80A	Cover	1980-91





# Big Twin Oil Pump

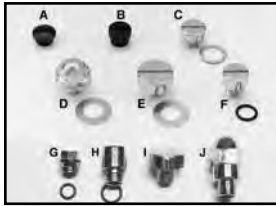

**Tappet Oil Screen, Oil Pump Check Valve and Relief Valve Plugs.**  
Replacement styles as shown.



VT No.	#	OEM	Fits	Finish
8702-2	G	26362-36	1936-80 Check Valve	Chrome
9523-1	B	26362-36	1936-80 Check Valve	Cadmium
9524-1	B	26362-36	1936-80 Check Valve	Parkerized
9525-1	B	26362-36	1936-80 Check Valve	Chrome
9526-1	A	26367-36	Stock, 37-52 By By-Pass	Cadmium
9527-1	A	26367-36	Stock, 37-52 By By-Pass	Parkerized
9528-1	A	26367-36	Stock, 37-52 By By-Pass	Chrome
8704-2	G	24987-52	1952-65 Tappet Screen	Chrome
9603-2	C	24087-52	1952-65 Tappet Screen	Cadmium
9604-2	C	24987-52	1952-65 Tappet Screen	Chrome
9605-2	D	26377-54	Oil Pump Relief 1954-67	Cadmium
9606-2	D	26377-54	Oil Pump Relief 1954-67	Chrome
8705-2	G	655	1966-69 Tappet Screen	Chrome
9874-2	C	655	1966-69 Tappet Screen	Cadmium
9875-2	C	655	1966-69 Tappet Screen	Chrome
37-9222	2	Plugs	1952-65 Set	Chrome
37-9223	2	Plugs	1966-67 Set	Chrome
37-9224	3	Plugs	1966-69 Set	Chrome
8706-6	G	3 Plugs	1970-80 Set	Chrome
8707-6	G	26263-80	1981-99 3 Piece Set	Chrome
37-9225	H	3 Plugs	1970-80 Set	Chrome
37-9226	H	3 Plugs	1981-99 Set	Chrome
2074-6	H	3 Plugs	1981-99 Set	Chrome
2073-2	H	1981-99	1981-99 Each	Chrome
8701-2	G	657	1970-80 Tappet Screen	Chrome
8701-2T	G	657	1970-80 Tappet Screen	Chrome
9876-2	C	657	1970-80 Tappet Screen	Cadmium
9877-2	C	657	1970-80 Tappet Screen	Chrome
8700-2	G	26377-68	1968-80 Relief Valve	Zinc
37-9068	E	26377-68	1968-80 Relief Valve	Chrome
9607-2	E	26377-68	1968-80 Relief Valve	Cadmium
9608-2	E	26377-68	1968-80 Relief Valve	Cadmium
9608-2T	E	26377-68	1968-80 Relief Valve	Chrome
8703-2*	G	26263-80	1980-99 All	Chrome
8703-2T*	G	26263-80	1980-99 All	Chrome
9644-2*	F	26263-80	1980-99 All	Cadmium
9645-2*	F	26263-80	1980-99 All	Chrome
9634-4	F	26263-80	1980-99 2 Piece Set	Chrome
9635-4	F	26263-80	1980-99 2 Piece Set	Cadmium
37-8960*	J	26279-89	1981-99 All Dome Acorn	

\*Note: The 1981-up uses the same plug on check valve, tappet screen and relief valve

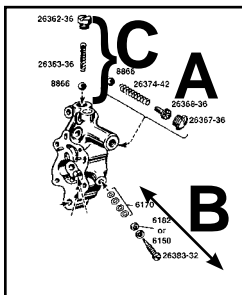

**A-Bypass Kit** fits 1937-40 EL and FL.

VT No. 12-1477

**B-Oil Pump Adjusting Screw Kit** fits 1936-54 Big Twin and 45, includes screw, shims, washer and nut.

VT No. Item

12-1465 Kit  
12-0584 Screw

**C-Check Valve Kit** includes cap, spring and ball.

VT No. 12-1481

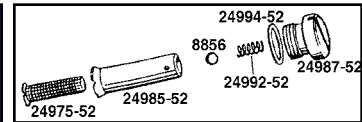

**Oil Screen Parts Kit** for 1952-62 includes all parts shown 24975-52 screen, 24985-52 housing body, 8856 ball, 24992-52 spring, 24987-52 plug, and 24994-52 washer.

VT No.	Item
12-0159	Kit
12-1522	Screen, each
15-0306	Cork Seal, 24990-52, 10 pack
12-0176	Housing Body

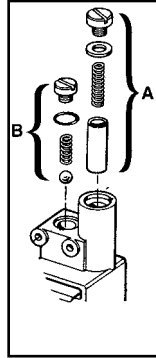

**A-Relief Valve/By Pass Kits** include spring, plug and valve.

VT No.	Year
12-1477	1937-53
37-8946	1954-67
12-1484	1968-72
12-1485	1973-80
12-1486	1981-2000

**B-Check Valve Kits** include ball, spring and cap.

12-1490	1936-55 and 1966-80
12-1489	1956-65
12-1487	1981-99

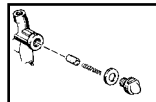

**Oil Pump Relief Valve Kit** for 1954-67 includes plug, spring and valve. VT No. 37-8946

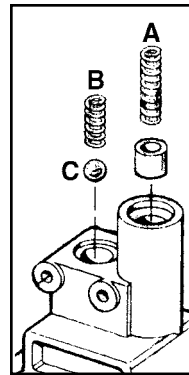

**A-Relief Valves and Springs.**

VT No.	OEM	Years	Item
13-0107	26374-54	1952-72	Spring
13-0217	26374-42	1941-52	Spring
13-0111	26207-83	1983-00	Spring
12-1417	26400-54	1954-81	Valve

**B-Check Valve Springs.**

VT No.	OEM	Years
13-0113	26363-36	1936-55 1966-76
13-0114	26363-56	1956-65
13-0112	26262-80	1981-99

**C-Ball**  
12-0158 8866 1954-99

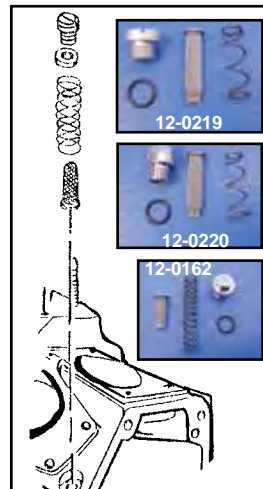

**Oil Screen Kit** includes proper plug, screen o-ring and spring.

Chrome Cap	Stock Replica	Years
12-0151	12-0219	1970-80
12-0152	12-0220	1981-84
—	12-0159	1952-62
12-0162	12-0217	1963-65
12-0150	12-0218	1966-69

**Tappet Oil Screens** are exact replacement of OEM, sold each.

12-1522	24975-52	1952-62
12-1529	24975-63	1963-65
12-1516	24981-66	1966-69
12-1515	24981-70	1970-99

**Oil Screen Spring** for the tappet oil screen, sold in pack of 10.

13-0216	24992-52	1952-62
13-0164	24979-63	1963-65
13-0108	24982-66	1966-69
13-0109	24982-70	1970-82



**"Super-Pump" Spring Kit** for 1966-99 Big Twin.

VT No.	Brand
13-0575	VT
13-9222	E.R.T. SP-1



# Breather Gear

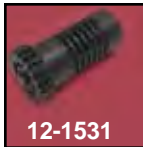

**Stock Plastic Breather Valves.**  
**VT No. OEM Year**  
**12-1531** 25310-82A L1977-99  
**12-1953** As Above .005 Oversize  
**C-Breather Valve Thrust Washer Set** for 1950-99 Big Twin includes one of each size noted.

**VT No. Fits Set**  
**12-1510** 1979-82 8 Steel  
 .110, .115, .120, .125  
 .130, .135, .140, .145  
**12-1530** 1982-99 8 Plastic  
 .130, .135, .140, .145  
 .150, .155, .160, .165

**Breather Valve Thrust Washer Set** for 1950-78 Big Twin. Made of steel, one of each of the following: 110, .115, .120, .125  
**VT No. 12-1509**

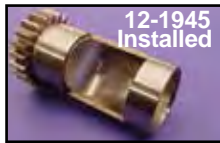

**12-1945 Sifton Air Ramp** fits S&S/ Sifton Breather Gear on 1936-99 models to remove more air and oil from crankcase. Requires removal of screen for installation. Gear not included.

**VT No. 12-1945**

## Ball Bearings

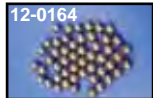

VT No.	OEM	Size	Use/Fits
12-0172	8854	3/16"	1948-52 Hydraulic Unit
12-0161	8856	7/32"	Clutch Hub, 1941-54 All
12-0164	8858	1/4"	Oil Filler, 1948-64
12-0158	8866	3/8"	Check valve, 1941-up FL-FLH, Classic, 1971-up all FX, 1954-up all XL
12-0129		3/8"	Nylon Ball Bearings
12-0156	8872	1/2"	Shifter Cam Plunger 1941-76 with Handshift
12-0157	8860	5/16"	Clutch Ramp Assembly Steering Head 1971-83 All XL, 1954-78 All XL



**Sifton™ Breather Gear Kit** is constructed of precision ground steel with screen installed. Eight piece steel thrust washer set included. Fits 1948-77.

**VT No. 12-1538**

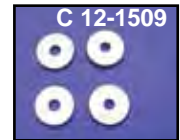

**A-Big Twin Steel Breather Valve** is a machined breather valve and gear. Designed to replace the stock steel or plastic units. Order 8-piece thrust washers separately. Available in stock duration only with either standard or +.030 oversize outside dimension.

VT No.	Years	Size	Brand
12-0786	1936-47	Standard	Sifton
12-9967	1936-47	Standard	S&S
12-9968	1936-47	+ .030	S&S
12-9907*	1948-77	Standard	S&S
12-1536**	1948-77	Standard	Sifton
12-9956*	1948-77	+ .030	S&S
12-9906	1978-99	Standard	S&S
12-1537	1978-99	Standard	Sifton
12-9957	1978-99	+ .030	S&S
12-9909	All	Washer Set	S&S
12-1510	All	Washer Set	Sifton

\*Note: Requires use of late style thrust washer 1979-82.  
 \*\*Note: Includes thrust washer set 1979-82 type.



**Oil Pump Drive Gear Set** fits 1973-84 FL-FX.  
**VT No. 12-1546**

**Sifton High Flow Pinion Shaft Oil Pump Drive Gear** for 1939-53 OHV Big Twins. 6 Tooth gear increases oil flow rate by approximately 25%. Requires use of late style (OEM#26345-73 VT No. 12-1407) oil pump drive shaft gear. Also available as a kit that includes correct drive shaft gear.

**VT No. Item**  
**12-1496** Pinion Shaft Gear only  
**12-1505** Kit



## Breather Parts



**Big Twin Pinion Part Kit** is complete with proper parts.  
**VT No. Fits Kit**  
**12-0101** 1936-53 Five Piece Kit  
**12-0102** 1955-69 Four Piece Kit

**Pinion Shaft Seal Ring** is used on all 1940-53 Over Head Valve Big Twins, sold each. Replaces 24697-40.

**VT No. 12-1525**

**Breather Screens and Separator** fits 1936-69 Big Twin, sold in packs of 5.

VT No.	OEM	Item
12-1517	25275-36	Screen
12-1518	25279-36	Separator

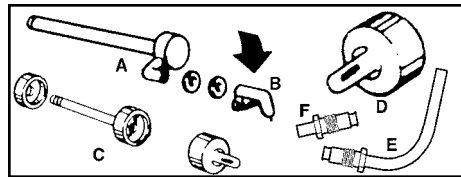

**Primary Breather Tubes** for Big Twin models.

VT No.	#	OEM	Years	Item
49-1743		543-36	1936-38	Tube
12-1514	A	24912-48	1948-57	Tube
12-1448	A	29411-36	1936-47	Tube
12-0997	A&B	1936-47	Kit	
12-1528	B	24918-64	1936-57	Snoot
12-9908*	C	Kit	1958-64	All
12-1513	D	24918-58	1958-64	Rubber Nipple
12-9775				Breather Spacer & Washer Set
40-0547	E	24912-65	1965-66	Tube with Nut
40-0548	F	24913-67	1967	Tube with Nut
12-1191		24914-58	1958-64	Stud Only

\*Note: Includes 24925-58 spacer, 24914-58 stud, (24922-58 collar, 24923-58 cap Note: cap and collar have been pressed together) and 24918-58 rubber ripple.

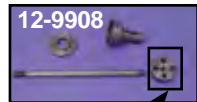

Cap and Collar have been pressed together





# Cam Cover 1948-69 Big Twin

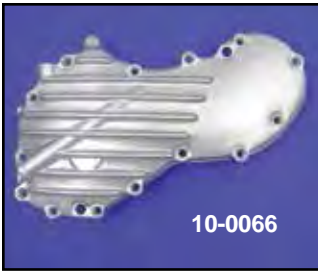

**Chrome Forged Alloy Cam Cover** fits 1948-62 Big Twins. Includes bushings installed.

VT No.	Years
10-0076	1948-53
10-0126	1954-62

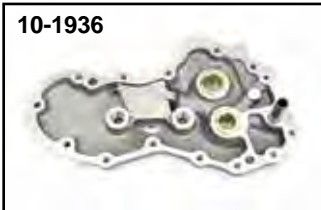

**Big Twin Gear Covers** available in raw finish include bushings and breather pipe. All covers must be reamed for final fit.

VT No.	OEM	Year	Style
10-1936	584-39	1936	Smooth
10-1939	584-37	1937-39	Smooth
10-0065	25216-36	1940-47	8-Fin
10-0066	25216-48	1948-53	8-Fin
10-0067	25216-48	1948-53	4-Fin
10-0068	25216-58	1954-62	4-Fin

**Flatside Style Cam Covers** feature natural finish aluminum with bushings installed. VT No. 10-0077 accepts oil passage bolt.

VT No.	OEM	Year	Finish
10-0077	25216-65	1963-65	Cast
10-0079	25216-66	1966-69	Cast
10-0026	25216-61	1963-65	Chrome
10-1940	25216-66	1966-69	Chrome



**Knucklehead Cam Chest Kit** includes internal Big Twin replacement type parts for years listed, including a Sifton cam, replica cam cover and hardware.

VT No.	Year
10-0498	1937-40
10-0499	1940-47

**Stock Slotted Style Screws.**

VT No.	Year	Finish	Thread
8149-12	1936-69	Chrome	24
8150-12	1936-69	Cadmium	24
9621-12	1936-69	Parkerized	24
2101-12	1950-52	Chrome, Phillips	24
2102-12	1950-52	Cadmium, Phillips	24
9794-12**	1936-69	Chrome	20
9795-12**	1936-69	Cadmium	20
8771-2*	1963-65	Chrome	
8772-2*	1963-65	Cadmium	

\*Note: Oil Passage Bolt

**Chrome Allen Style**

8755-12	1936-69	Chrome	24 (Replica V-Twin)
9827-12**	1936-69	Chrome	20 (S&S)

\*\*Note: For Aftermarket Cases except V-Twin and Replica Cases



# Cam Cover for 1970-92 Big Twin



**Form Fitting Chrome Steel Covers** fit over stock cam cases on Big Twins. No need to remove cam case or disturb cam or gears. Covers held in place by existing screws. Fits 1970-92  
**VT No. 42-0111**



9305-7



8761-7



7402-7

**Gear Cover Screw Sets.**

1970-92	Finish	Type
9305-7	Chrome	Stock
9306-7	Cadmium	Stock
8761-7	Chrome	Allen
7402-7	Chrome	Acorn



10-0110



10-0090



10-0088



10-0111



10-0040



10-1298

**Quick Change Cam Gear Gasket and Seal Kit** fits Shovelhead and Evolution engines, includes both cork and quad seals for pushrods to fit all year range.



**James GB No. Year/Model**  
**15-0871 15-0659 1970-92 Big Twin**

**Nose Cone Gear Covers** fit 1970-Early 73 Big Twin models with side oiling pinion shaft or 1973-92 end oiling models. Polished, or chrome with bushings installed. Seal included.

VT No.	Years	Finish	Brand
10-0110	1970-73	Chrome	MC
10-0090	1970-73	Polished	MC
10-0088	1973-92	Polished	MC
10-0040*	1973-92	Chrome	V-Twin
10-0111	1973-92	Chrome	MC
10-1298	1973-92	Black	MC

\*Note: Includes gaskets and mounting screws. All other numbers include seal only.



48-1327



48-0368



48-1208

**Sifton Patches.**

VT No.	Style
48-1327	Logo
48-0368	Handshake
48-1208	Cam
48-1163	Knucklehead



Tom pictured in 1927 as a champion hill climber. During his 60 year motorcycle career he raced, tuned and sold Harley Davidsons from his San Jose Dealership, and founded the Sifton Products Company.



Some real action. Tom Sifton and his Harley-Davidson at the Oakland Motorcycle Club's hill climb near Oakland, Cal.





# ANDREWS 1948-84 Big Twin Cam



VT No.	Year	Grind	Timing	Duration @ .053	Valve Lift		Application
					Shovel	Pan	
<b>CAMS FOR STREET AND DRAG APPLICATIONS</b>							
			-6/46	220	.390	.412	Stock H/D front cylinder timing
Stock (Front Cyl.) H/D Cams			44/20	244	.390	.412	Listed for Comparison
			14/38	232	.390	.412	Stock H/D front cylinder timing
Stock (Rear Cyl.) H/D Cams			44/20	244	.390	.412	Listed for Comparison
10-2011 10-2020 10-2030	1948-69 1970-77 1978-84	J	21/41	242	.405	.425	Mild street; Panheads and Shovelheads, smooth idle more power through R.P.M. range. Bolts in with no head work.
10-2260 10-2263 10-2267	1948-69 1970-77 1978-84	A2	19/43	242	.450	.470	Bolt in cam that requires no head work. More mid range and hi end power. Idle unaffected.
10-2310 10-2320 10-2331	1948-69 1970-77 1978-84	AB	21/43	244	.450	.470	"A" Intake and long duration exhaust for cooler running and more high-end power. Both in street cam (except 80-81). Okay. for Hydraulic Lifters.
10-2351 10-2353 10-2358	1948-69 1970-77 1978-84	B2	26/50	256	.485	.507	Street Drags: More mid range and high end power, smooth idle. Best cam for modified 74/80 cubic inch and small strokers. Spring spacing required.
10-2430 10-2440	1970-77 1978-84	BH	24/52	256	.450	.470	Hydraulic version of a "B" cam. Usually a bolt in but spring spacing may be required on 1980-81 Shovelheads.
10-2264 10-2265	1948-69		29/53	262	.510	.535	Upgraded version of original #6 Grind. Great street cam for 84/88 inch strokers. Maximum Torque available from 2200 to 6500 R.P.M
10-2600 10-2610 10-2620	1948-69 1970-77 1978-84	C	37/61	278	.525	.550	Best production cam made for big street engines. Strokers from 84" to 96" will really turn on with this cam. Broad torque range pulls from 2000 to 7000+ R.P.M.
<b>CAMS FOR LOW COMPRESSION ENGINES</b>							
10-2420	1948-69	B					Bolt In
10-2130 10-2140 10-2150	1948-69 1970-77 1988-84	1	16/36	232	.427	.450	This is the low compression piston version of "A" grind cam for 74 and 80 cubic inch for engines with 7.5 compression pistons.
10-2340 10-2350	1970-77 1978-84	2	15/35	230	.490	.512	Low compression piston version of a "B" grind cam. More power through R.P.M. range
10-2630 10-2640 10-2650	1948-69 1970-77 1978-84	3	23/43	246	.514	.540	High lift, short duration for motors 84 cubic inch engines or larger. More power for small strokers with 7.5 compression pistons
<b>HIGH PERFORMANCE &amp; DRAGSTER CAMS</b>							
10-2740 10-2750	1948-69 1970-77 1978-84	M	28/56	264	.590	.210	Street Drags: 88+ cubic inch engines maximum mid-range torque cam 3000/6500 RPM. OK for low compression on street. Andrews springs and collars make installation easy.
10-2850 10-2860 10-2870	1948-69 1970-77 1978-84	9	32/64	276	.530	.222	Drags: Broad tip design for maximum mid-range power for strokers from 88 cubic inches and larger. Requires Andrews springs and collars for head set up and installation.
10-2890 10-2900 10-2910	1948-69 1970-77 1978-84	10	34/70 70/34	284 284	.580 .580	.230	Maximum output dragster cam for BIG motors from 92" cubic inch and up. This cam is for best torque up to 6500 R.P.M. Requires Andrews springs and collars.



## Competition Cams



VT No.	Year	Application Hydraulic	P/N	Duration @ .053		Valve Lift		Valve Timing Open/Close		Lift @ TDC	
				Intake	Exhaust	Intake	Exhaust	Intake	Exhaust	Intake	Exhaust
10-5009	78-84	Very good torque and mid-range. Good roll on power.	SHV4000	236	236	.450"	.450"	14/42	42/14	.093"	.093"
10-5010	70-77		SHV-4001								
10-5011	78-84	Good torque strong mid-range and good roll on power.	SHV4010	236	236	.485"	.485"	14/42	42/14	.093"	.093"
N/A	70-77		SHV-4011								
10-5013	78-84	Valve springs needed.	SHV4020	242	242	.485"	.485"	17/45	45/17	.103"	.103"
10-5014	70-77	Increased midrange over	SHV-4021								
10-5016	70-77	Performance cam. Use with carb, pipes and valve springs.	SHV-4031	252	252	.485"	.485"	22/50	50/22	.120"	.120"



# 1948-84 Big Twin Cam



The Leader in Performance Technology

CLASSIC

VT No.	Year	Specifications				Series Grind Number	TYPE & APPLICATION
		DURATION @ .053"		Gross Valve Lift			
		INT.	EXH.	INT.	EXH.		
10-8252	1948-69	248	248	.455°	.455°	Hydraulic 300H	HYDRAULIC - Bolt-in. Broad power range for streetable performance. Works Fireball well with stock compression or increased up to 10:1. Low and mid range improvement. Does not require valve spring change. Works well with stock carburetor and exhaust or performance parts.
		24/44	44/24	479°	479°		
Cam lift at TDC: Int: .126" Exh: .130"*							
10-4380	1948-69	244	244	.455°	.455°	Fireball 296A	MECHANICAL - Bolt-in performance throughout the power range. Also recommended for increased torque in heavy bikes with heavy loads. No spring change required. Works well with stock carburetor and exhaust. Does not have Cranes multi-indexed gear. Replaces A.
10-4381	1970-77	20/44	44/20	.479°	.479°		
10-4382	1978-84	Cam lift at TDC: Int: .108" Exh: .108"*					
10-4383	1948-69	256	256	.490°	.490°	Fireball 308B	MECHANICAL - Performance cam. Can be used with stock compression but works well with 10.5:1 compression ratio. Mid range and top end improvement. Heads must be cleared and may require valve spring change to install. Works well with performance exhaust, carburetor and cylinder head work. Replaces B.
		26/50	50/26	.516°	.516°		
Cam lift at TDC: Int: .129" Exh: .129"*							
10-4352	1948-69	254	264	.450°	.450°	Hydraulic Hi-Roller H298-2B	HYDRAULIC - Performance can be used with performance type carburetor and exhaust. Increased mid-range and top end horsepower. Check valve-to- valve clearance.
		25/49	62/22	.474°	.474°		
Cam lift at TDC: Int: .137" Exh: .128"*							
10-4356	1948-69	266	266	.525°	.525°	Hi-Roller 310B	MECHANICAL - High performance street and drags. Increased compression ratio and/or cubic inches required. Must change valve springs and check spring travel, piston-to-valve, and valve-to-valve clearances.
		31/55	55/31	.553°	.553°		
Cam lift at TDC: Int: .152" Exh: .155"*							
		268	268	.485°	.485°	Hi-Roller 304B	MECHANICAL - Streetable high performance. Increased compression ratio and/or cubic inches required. Must change valve springs and check spring travel, piston-to-valve, and valve-to-valve clearances.
10-4362	1970-77	32/56	56/32	.511°	.511°		
10-4369	1978-84	Cam lift at TDC: Int: .152" Exh: .152"*					
10-4371	1948-69	276	276	.550°	.550°	Hi-Roller 320B	MECHANICAL - Street and drag cam for high performance engines. Increased cubic inches required for best results. Head work required for proper spring travel, piston-to-valve, and valve-to-valve clearances.
		36/60	64/32	.579°	.579°		
Cam lift at TDC: Int: .172" Exh: .160"*							
10-4374	1948-69	286	286	.575°	.575°	Hi-Roller 330B	MECHANICAL - Drag cam for large cubic engines. Head work required for proper spring travel, piston-to-valve, and valve-to-valve clearances, also to insure maximum performance Camshafts having over .450" valve lift in 1948-69 engines, will need to have front
		41/65	73/33	.606°	.606°		
10-4376	1978-84	Cam lift at TDC: Int: .192" Exh: .164"*					

Camshafts having over .450" valve lift in 1948-57 engines, will need to have front intake lobe-to-case clearance checked.

\* To convert cam lift to valve lift, multiply the cam lift figure by the rocker arm ratio: Shovelhead - 1.425; Panhead - 1.5.

<sup>a</sup> Opening and closing figures for camshafts with the multiple keyway gear are based on the gear installed in the "0" position.

<sup>b</sup> Gross valve lift for Shovelhead with 1.425 rocker arm ratio.

<sup>c</sup> Gross valve lift for Panhead with 1.5 rocker arm ratio.



10-8264



10-8263



10-8262



10-8261



10-8260



**Cam Needle Bearings** feature full compliment roller design. OEM# 9058. Fits 1958-99 Big Twin.

**VT No. Brand**  
**12-0397 V-Twin**  
**12-0316 Torrington**



16-1271

**Sifton Inner Cam Bearing Remover Tool** allows removal of needle bearing and will also keep needles from falling into engine. Fits 1958-99 Big Twin.

**VT No. 16-1271**

**Sifton Cam Bushing Kits.** Big Twin type includes cam and gear shaft bushings/bearings with lock pins and thrust plate.

VT No.	Year
10-8264	1936-53
10-8263	1954-57
10-8262	1958-69
10-8261	1970-72
10-8260	1973-92





# S&S Cam

VT No.	Year	S&S#	Application	Valve Timing* Intake	Valve Timing* Exhaust	Valve Duration Intake	Valve Duration Exhaust	Valve Lift Shovelpan	Lift @ TDC + Intake	Lift @ TDC + Exhaust	Requirements Spring Spacing	Lifter Type
N/A 10-5045	1970-77 1978-84	S&S	Engines up to 88" with up +8.5:1. Good low and mid range torque.	18°/38°	40°/18°	236°	238°	.475"/.453"	.158"	.152"	No Bolt In	Hydraulic
10-5050 10-5051 10-5052	1948-69 1970-77 1978-84	S&S 514	80"/84" to 96" engines with 8.5:1 or less CR. Good mid range.	23°/43°	43°/23°	246°	246°	.514"/.540"	.169"	.169"	Yes	Solid
N/A 10-5047 10-5048	1948-69 1970-77 1978-84	S&S 560S	88" to 103" engines with 9:1 to 10:1 CR. Strong power throughout RPM range.	20°/55°	60°/20°	255°	260°	.587"/.560"	.168"	.164"	Yes	Solid

\*Note: Timing designation is function of zero lash @ .053" off base circle.

+Lifts at TDC are measured at the valve and are for reference only. Overlap valve lifts must be checked on assembled motor. Minimum valve to valve clearance of .040" is recommended.



# Sifton Cam



48-1327



48-0368



48-1208

Sifton Patches.  
VT No. Style  
48-1327 Logo  
48-0368 Handshake  
48-1208 Cam



For Identification check these applications:

1978-86 New Shovelhead and 1977 Low Rider  
1970-77 Alternator Shovelhead

For 1948-84 Big Twins								
VT No.	Year	Cam	Degrees	At .053	Lift	TDC	Travel to	Free
Side Kick Cam is similar to 102 but with more top end power. Requires no head work to install. Do not use with hydraulic tappets.								
—	Late 1948-69	103	Opens	Closes	Total	TDC	Coil Bind	Travel
10-0610	Late 1970-77	Inlet	28°	57°	.390	.174	.420	.470
10-0611	Late 1978-84	Exhaust	53°	27°	.390	.174	.420	.470
Aristocrat Cam shows significant gain over stock, requires no head work to install. Fits 1948-up. Do not use with hydraulic tappets.								
—	1948-69	102	Opens	Closes	Total	TDC	Coil Bind	Travel
10-0601	Late 1970-77	Inlet	32°	56°	.412	.200	.440	.490
10-0602	1978-84	Exhaust	53	28	.412	.185	.440	.490
Avenger Cam performs best in 86" and 93" cubic inch engines with 4-Speed works well with hydraulic, perform best with solid lifters.								
10-0603	1948-69	109	Opens	Closes	Total	TDC	Coil Bind	Travel
10-0604	Late 1970-77	Inlet	32.5°	50°	.440	.211	.470	.520
		Exhaust	58.5°	30°	.440	.200	.470	.520
Crusader Cam is a good cam for low end and mid range and is designed to be used with hydraulic lifters.								
—	1948-69	107	Opens	Closes	Total	TDC	Coil Bind	Travel
10-0668	Late 1970-77	Inlet	29°	54°	.440	.193	.470	.520

CUBIC INCH CHART								
Stock 74 Stock 80								
B O R E	STROKE	3 1/2"	3.968"	4 1/4"	4 1/2"	4 5/8"	4 3/4"	5.00"
	3 1/16"	61"						
	3 1/8"	64.8"	73.7"	78.7"	83.4"	85.7"	88.0"	92.8"
	3 1/4"	67.2"	76.3"	81.6"	86.6"	89.0"	91.4"	96.1"
	3 3/8"	72.1"	81.7"	87.4"	92.9"	95.5"	99.0"	103.2"
	3 1/2"	74.6"	84.7"	90.7"	96.1"	98.8"	101.5"	106.8"
	3 5/8"	79.9"	90.6"	97.0"	102.8"	103.7"	108.9"	114.2"
	3 7/8"	82.3"	93.4"	100.1"	100"	108.9"	111.9"	117.8"
	4.00"	87.9"	99.7"	106.8"	113.0"	116.1"	119.3"	125.6"
	4 1/8"	93.4"	106.0"	113.5"	120.2"	123.5"	126.9"	133.6"
4 1/4"	99.2"	112.6"	120.5"	127.6"	131.1"	134.7"	141.8"	

$$\text{Cubic Inch} = \pi r^2 \times \text{Stroke}$$

$$r = 1/2 \text{ of Bore}$$

1 cubic inch = 16.38 cc

1 cubic inch = .0163871 liter



# 1936-84 Replica Cam

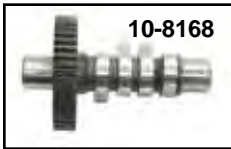

**Sifton Stock Cams** are replica type. Available as cam kit with matching pinion gear or as cam only.

Cam	Cam Kit	Fits
10-8181	10-8201	1936-47 Knucklehead
10-8168	10-8203	1948-53 Panhead
10-8168	10-8208	1954-69 Panhead-Shovelhead
10-8174	10-8204	1970-77 FLH
10-8176	10-8205	1977-84 FLH
10-8179	10-8202	1977-84 FX



**Pinion Shaft Gears.** Orange is the largest, yellow is the smallest on 1936-77. For 1977-89 orange is largest, black is smallest. \*denotes OEM type

1936-53	1954-77	Size/	1977-89	Size/
OHV BT	OHV BT	Color	OHV	Color
24010-39	24010-54	OEM	Big Twin	
12-1399	—	Standard	—	
—	12-1379*	Standard	—	
12-1260	12-1268	Orange	12-9938	Orange
12-1261	—	Black	12-9943	White
—	12-1270	Red	12-9945	Yellow
—	—	Blue	12-9940	Red
—	12-1272	Green	12-9941	Blue
12-1265	12-1273	White	12-9942	Green
—	—	Brown	12-9939	Black
—	12-1275	Yellow	—	



**Circuit Breaker Drive and Idler Gear** fit 1936-69 Big Twins. Order shims separately to fit. Available as lightning with holes or solid. \*Note for high lift cams.

VT No.	OEM	Type	Style
12-1388	25775-36	Idler	S&S
12-1397	25775-36	Idler	Solid
12-1393	25775-36	Idler	Lightning
12-1491	Sifton	Idler	Lightning
12-1492	Sifton	Idler	Solid
12-1396	25850-36A	Drive	Solid
12-1995*	25850-36B	Drive	Solid
12-1479	25850-36	Drive	Lightning
12-1389*	25850-36	Drive	S&S

Shims	Thickness
10-4221	.050"
10-4222	.054"
10-4223	.058"
10-4224	.062"
10-4225	.066"

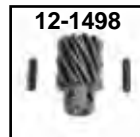

**Reverse Rotation Circuit Breaker Drive Gear and Timer Gear.** Counterclockwise rotation gears allow use of dual fire late type ignition to be installed in timer housing.

VT No.	Item
12-1497	Circuit Breaker Gear
12-1498	Timer Gear with pin
12-0825	Gear Kit



**V-Twin Motor Shop Cam Chest Kit** includes internal Big Twin replacement type parts for years listed including a Sifton™ cam. Order cam bearings and bushing kit separately.

VT No.	Fits	Model
10-0629	1936-47 OHV	Knucklehead
10-0578	1936-47 OHV	Lightning
10-0626	1948-53	Panhead
10-0627	1954-69	Panhead-Shovelhead
10-0660	1970-84	Big Twin Shovelhead



**Crane Stock Cams** built to original specifications. Gear included.

VT No.	OEM	Fits
10-8166	25523-70	1970-77 FX
10-8167	25523-77	1977-84 FX



## Andrews Knucklehead and 61" Engine Cams

VT No.	Year	Grind	Timing	Duration	Lift
10-2965	36-47	N	14/42	236	.355
			42/14	236	.355
Stock replacement Knucklehead cam. For stock motors or restorations, this is the cam.					
10-2970	36-47	S	27/55	262	.370
			55/27	262	.370
Bolt in Knucklehead replacement for stock engines with smooth idle, strong pull to 6000 RPM, equivalent of a "B" cam.					
10-2980	36-47	K	35/63	278	.367
			63/36	278	.367
Bolt in performance Knucklehead cam. Best with 9.5 or higher compression and/or stroker flywheels. 3000/7000 RPM power range.					
10-2960	48-51	K	35/69	278	.367
			63/36	278	.367
Stock replacement for 61" Panhead.					

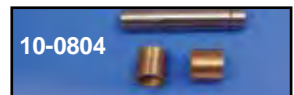

## Idler and Circuit Breaker Drive Gear Shafts Kits.

Sifton	VT No.	Item
10-1292	10-0803	Idler Shaft Kit contains an idler shaft and a bushing, fits 1941-69 Big Twin Over Head Valve
10-1293	10-0804	Circuit Breaker Shaft Kit contains one shaft and two bushings, fits 1941-69 Big Twin Over Head Valve



VT No.	Year	Type
10-1294	1936-58	Circuit Breaker
10-1295	1959-69	Circuit Breaker
10-1296	1941-69	Idler





# Tappet Assembly



**Sifton Tappet Assembly;** Sets of 4, feature centrifugal surface fine grinding and precision fit rollers and pins. Solid units include adjuster screws and lock nuts.

VT No.	Size	Year	Type	Model
10-0770	STD	1948-52	Solid	Panhead
10-0771	.005	1948-52	Solid	Panhead
10-0772	.010	1948-52	Solid	Panhead
10-0588	.002	1953-85	Hydraulic	Pan-Shovelhead



10-0670

VT No.	Size	Year	Type	Model
10-0785	STD	1948-52	Solid	Panhead
10-0674	STD	1953-85	Hydraulic	Pan-Shovel
10-0777*	.005	1953-85	Hydraulic	Pan-Shovel (.7367 OD)
10-0778*	.010	1953-85	Hydraulic	Panhead-Shovelhead
10-0670*	Standard	1953-85	Hydraulic	Panhead-Shovelhead

\*Note: Max Roller Type

## Roller Types

Big Axle      Standard



## Big Twin Tappet Assemblies

include roller assembly installed. Choose Jims, Eastern or Sifton. Jims does not include adjuster screws or nuts where necessary. Jims available with Big Axle Roller Assembly.

## Big Axle      Standard

Jims	Eastern	Sifton	Size
<b>1948-52 Solid</b>			
10-0630	10-0500	—	STD
10-0631	10-0501	—	.005
—	10-0523	—	.010
—	10-0450	—	.015
<b>1953-85 Hydraulic</b>			
10-0634	10-0504	—	STD
—	—	10-0570*	STD (Set)
10-0635	—	10-0505*	.005
—	—	10-0525*	.010
—	—	10-0681*	.005 (Set)
—	—	10-0886*	.010 (Set)
—	10-0530	—	.015
—	10-0531	—	.020
—	10-0532	—	.025

\*Note: V-Twin Replica Type



Solid Tappet



Hydraulic Tappet



10-0541

## Tappet Adjusting Screws and Nuts.

VT No.	U/M	Fits	Item	Type
10-0541	Set	1936-52 Big Twin OHV Kit		OE Style
10-0985*	Set	1936-52 Big Twin OHV Kit		Eastern Style
10-0516	4 pack	1936-52 Big Twin	Screw	Eastern Style
12-0523	10 pack	1936-52 Split	Nuts	Eastern Style
12-1196*	4 pack	1957-85 Big Twin	Screw	

\*Note: 3/32 - 32 thread.

## Replacement Nuts fit each brand of pushrod

VT No.	Brand	Size	U/M
37-8866	V-Twin	3/16 - 32	4 pack
12-0524	Eastern	3/32 - 32	10 pack

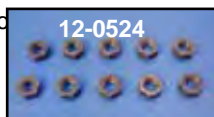

12-0524



**Sifton Tappet Assembly Kit** includes tappets with large single axle roller design and hydraulic or solid units for 1953-84 Big Twin.

VT No.	Type
10-0680	Hydraulic
10-0768	Solid
10-0934	Roller Set
10-0588	Hydraulic .002
10-1451	Hydraulic, 4 piece set, large pin roller



10-1451



**Sifton Big Twin Hydraulic Tappet Assembly** Set of Four, feature centrifugal surface fine grinding and precision fit max-axle rollers and pins. Fit 1953-84.



10-0671

VT No.	U/M	Outside Diameter
10-0670	Set (4)	.7310
10-0673	Set (4)	
10-0671	Each	



10-0198



10-0199

**Hydraulic Tappet Units** replace 17920-53 fits 1953-85 Big Twin.

VT No.	Brand	U/M
10-0521	Crane	Each
10-0199	Sifton™	Each
10-0198	Sifton™	Four Piece Set
10-0277	Replica	Four Piece Set
10-0333	VT	Rowe Set



10-0314

## Sifton Hydraulic Tappet Assembly.

Lifters with replica rollers. are sold in sets of four. Order hydraulic unit set separately. Also available in eight piece tappet and hydraulic unit kit.

VT No.	OEM	Item
10-0313	18522-53A	Tappet Body Set
10-0776	18522-53A	As Above
10-0315	18522-53S	As Above, replica
10-0314	Hydraulic Tappet Body and Lifter Set	



**Lightning Tappet Assemblies** fit 1948-52 Big Twin. Complete units precision machined and drilled for early engines. Holes allow better lubrication in valve train. Adjuster screws included. Sold each unless noted.

VT No.	Size
10-0935	STD, Set of 4
10-0512	STD
10-0513	.005
10-0526	.010

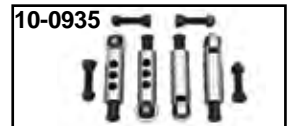

10-0935

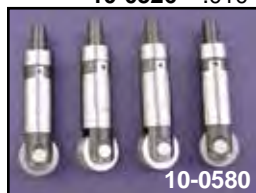

10-0580

**Sifton Maxi-Axle Tappet Assemblies** fit 1953-84 Big Twin feature built in integral pump unit to set as a full hydraulic unit.

VT No.	Size
10-0580	STD
10-0581	.002
10-0582	.005
10-0585	.010

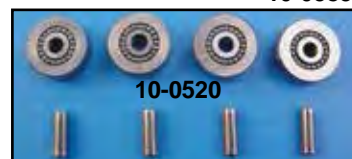

10-0520

**Tappet Roller Repair Kit** includes four pins and four roller assemblies for 1929-84.

VT No.	Brand
10-0520	V-Twin
12-1179	Pins Only, 10 pack
10-0934	Max-Tappet-Pin Kit



10-0934



10-0934



# Tappet Kit



**Sifton Tappet Kit** includes chrome tappet blocks, integral pump lifter set and steel pushrods.

VT No.	Year	Type
11-1604	1966-84	Shovelhead
11-1608	1953-65	Panhead



**Tappet Block Kit** includes four hydraulic tappets.

VT No.	Finish
10-0682	Chrome
10-0683	Zinc



**Stock Solid Tappet Kit** includes lifters with adjuster screw, pushrods and tappet blocks.

VT No.	Years	Type
11-0599	1966-84	Shovelhead
11-1524*	1966-84	Shovelhead
11-0596	1948-65	Panhead
11-0597*	1948-65	Panhead

\*Note: Zinc



**Sifton Performance Cam Kit** includes cam, solid lifters, pushrods and chrome lifter bases.



VT No.	Lift	Model
11-1602	.412	Shovelhead 1970-Early 77
11-1603	.412	Shovelhead 1978-84



**Sifton Hydraulic Pushrod/Lifter Set** includes four max axle lifters with integral pump and four adjustable steel pushrods for 1966-84 Shovelhead.

VT No. 11-0028



**Big Axle Power Hydraulic Glide Tappet Kit** by Jims. Fits 1966-84 Shovelheads. Includes two billet aluminum polished blocks and four power glide tappet assemblies.



VT No.	Item
10-0641	Kit
10-0642	Tappet only, Standard, each
10-0643	Tappet only, .002 Oversize, each
10-0644	Tappet only, .005 Oversize, each



**Solid Tappet Adapter Kit** permits use of hotter cam to run solid lifters by deactivating the hydraulic portion of the stock tappet. Uses stock pushrods. Fits 1953-84 FLH Big Twin Pan-Shovelhead.

VT No.	Brand
8204-4	Colony
8204-4T	V-Twin
11-1074	Sifton



**Sifton Hydraulic Tappet and Pushrod Assembly** includes four hydraulic lifter tappets, four hydraulic tappet units, four pushrods and a lifter base set.

VT No.	Years	Finish	Type
11-0590	1953-65	Chrome	Panhead
11-0591	1953-65	Zinc	Panhead
11-0592	1966-84	Chrome	Shovelhead
11-0593	1966-84	Zinc	Shovelhead



**Super Power Glide Big Axle Tappet Kit by Jims** for 1966-84 Big Twins. Available as complete kit which includes four tappets, four pushrods and two polished billet tappet blocks or as four tappets and four pushrods only.

VT No.	Item
11-2411	Complete Kit
11-2428	Tappet and Pushrods Only







SIFTON  
MOTORCYCLE  
PRODUCTS

# Pushrod Kit



**Solid Pushrod Kits** include 4 alloy pushrods and adapters to convert stock hydraulic lifters to solid. Replacement rods available separately. \*Note: Colony

Sifton	VT No.	Year	Model
11-9533	7131-12*	1953-65	Panhead
11-9534	7132-12*	1966-85	Shovelhead 74" and 80"
11-9539	11-9539	Rods only	For 1953-65 Kit
11-9540	11-9540	Rods only	For 1966-85 Kit

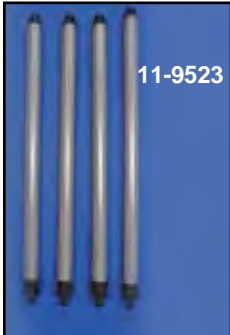

**Sifton Pushrod Sets** are constructed of aluminum alloy with heat treated steel ends. VT No. 11-9520 and VT No. 7122-4 do not include internal hydraulic valve.

Sifton	Colony	Year/Model	Type
11-9520	7122-4	1948-52 Panhead 74"	Solid
—	7519-4	1948-52 Panhead 61"	Solid
11-9522	7515-4	1953-65 Panhead 74"	Hydraulic
11-9523	—	1966-84 Shovelhead (Steel)	Hydraulic
11-9524	7516-4	1966-84 Shovelhead (Alloy)	Hydraulic
11-9527	7506-4	Conversion Pan/Shovel Top End	Solid



**V-Thunder Big Twin Pushrod Kits** are made from .049 wall 4130 chromoly steel tubing. Have exacting tolerances for reliability. These rods fit stock or Velva Touch lifter units.

VT No.	Year	Type
11-7706	1953-65	Stock
11-7707	1953-65 Shovelhead	Stroker
11-7708	1966-84 Shovelhead	Stock
11-7709	1966-84 Shovelhead	Stroker

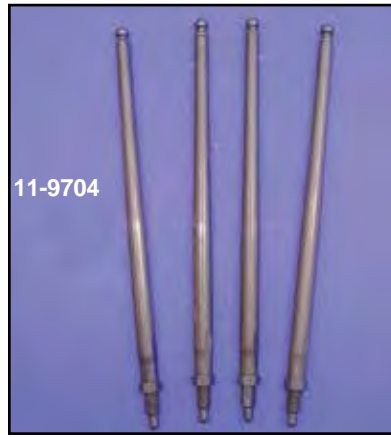

**Taper Lite Adjustable Pushrods** for 1966-84 are manufactured from 4130 steel with hardened adjusters and ball ends. Designed to be installed without removing gas tank, rocker box or camshaft cover. Set of four. Use with stock hydraulic lifters  
**VT No. 11-9704**



**Solid Pushrod Conversion** fits 1966-84 Shovelheads. We put the adjuster into the lifter body to increase the stability of the pushrod at greater angles. A tapered

split lock nut is used for the best way to lock the adjusting bolt into the lifter body. We use a 5/16-32 extra fine thread for easier and close adjustments. Pushrods are long enough to accommodate engines with stroker cylinders. Alloy pushrods have hardened steel tips.

**VT No. 11-9535**



**Solid Tappet Kits** for 1966-84 Shovelhead are made from aircraft quality 4130 seamless chromoly tubing. Extremely rigid, resists flexing even when used with radical cams and high spring rates. Lighter than stock pushrods. Lengths are as long as possible for added rigidity of adjuster. Each set includes 4 pushrods and 4 adjustable solid lifter adapters. Smaller diameter than most moly pushrod sets for clearance in pushrod cover tubes. Instructions included. Fits stock or .200 longer stroker cylinders.

**VT No. 11-9545**

**Replacement Nuts** fit each brand of pushrods or tappets.

8780-4	Colony	5/32 — 32	4 pack
37-8866	V-Twin	5/16 — 32	4 pack
12-0524	Eastern	5/32 — 32	10 pack

\*Note: 5/32 x 32 thread



**Andrews Pushrods** for 1966-84 are available in chromoly or steel aluminum. Pushrods are adjustable. All are stock diameter, so there is no cover interference.

VT No.	Andrews	Type
11-9871	292055	Aluminum
11-9872	292030	Chromoly



# Tappet Base 1948-84 Big Twin



10-0923



10-0095



10-0095 Installed



10-8173



10-1325



10-0987



10-0988



10-0113



10-7530



10-7530 Installed

**Big Twin Tappet Block** fits 1948-83, in chrome or zinc finish. Order seals and gasket kit separately.

VT No.	OEM	Finish	Type
10-0923	Set	Zinc	Panhead
10-0095	Set	Chrome	Set
10-8173	Set	Zinc	Set
10-1325	Set	Zinc	Panhead
10-0987	Replica	Chrome	Front and Rear
10-0988	Replica	Zinc	Front and Rear
10-0113	18610-66	Zinc	Rear
10-7530	Set	Alloy, raw	1948-52
8708-8*	Screws	Chrome	20T 1976-84
8711-8*	Screws	Chrome	24T 1948-75
15-0550	Kit	Gasket	1948-79
15-0551	Kit	Gasket	1979-84

\*Note: 12 point style for Big Twin



15-0119



15-1542

**Tappet Base Gasket** for 1949-99.

GB	James	OEM	Type
15-1542	—	Set	Three Front and Three Rear
15-0119	15-0926	18633-48A	Rear
15-0120	15-0927	18634-48A	Front

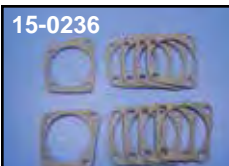

15-0236

**Special Tappet Gaskets.** 74 and 80 tappet based gaskets without oil return holes for use in engines with solid lifters five front and five rear. Fit 1941-85 Big Twin.

VT No. 15-0236



42-0902

**Chrome Pushrod Cover Set** with chrome lifter base covers as a complete dress up kit.

VT No. Year

42-0904 1948-65

42-0902 1966-79

42-0905 1980-84

8605-16T

8709-8T

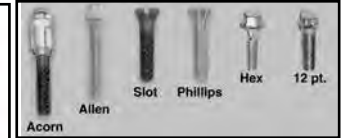

Acorn Allen Slot Phillips Hex 12 pt.

**Tappet Base Bolt Set** for Big Twin models.

1936-75, ¼ — 24 Thread with stock lifter blocks

VT No. Finish Style

8605-16 Cadmium Hex

8605-16T Nickel Plated Hex without taper

8604-16 Chrome Hex

8604-16T Nickel Plated Hex with taper

8102-16\* Chrome Slot

8103-16\* Cadmium Slot

9622-16 Parkerized Slot

7131-8 Chrome Acorn

8760-16 Chrome Allen

2099-16 Chrome Phillips

2100-16 Cadmium Phillips

\*Note: VT No. 8102-16 has a chrome screw slot, VT No 8103-16 is cadmium and slotted for 1936-53 as stock, can be re-fitted with hex top versions.

1976-up with Stock Tappet Blocks. ¼ — 20 thread without taper.

7628-8 Acorn

8726-8 Allen

8709-8 12 point, Cadmium

8709-8T Nickel Plated, ¼ — 20 UNC

8708-8 12 point, Chrome

8710-8 12 point, Black

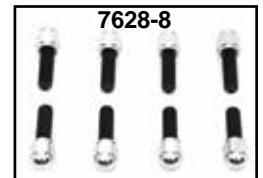

7628-8

For using late tappet bases, without taper, in early 1936-75 cases with ¼ — 24 thread.

8712-8 12 point, Cadmium

8711-8 12 point, Chrome

8713-8 12 point, Black

8480-8 Acorn

8727-8 Allen

¼ — 20 Thread Tapered Screws

for aftermarket cases using pre1976 tappet blocks.

9814-16 Chrome

37-8965 Allen, Chrome

9828-16 Allen, Chrome

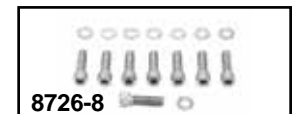

8726-8



8709-8





# Pushrod Cover Kit



**V-Twin Chrome Pushrod Cover Kits** in stock style gives all the parts needed for complete installation. All are 16 piece kits.

VT No.	Year	Model
11-0900	1966-79	Shovelhead
11-0902	1948-65	Panhead
11-0906	1966-84	Stroker, longer
11-0901	1980-85	Quad type
11-1082		Titanium



**Chrome Replacement Upper Pushrod Cover Kits (Outer).** Each kit contains four chrome clips, four springs, four cork gaskets, and four steel washers.

VT No.	Model	Brand
7509-20	Knucklehead (1936-39)	Colony
7507-20	Panhead	Colony
11-0929	Panhead	V-Twin
7508-20	Shovelhead/Knucklehead	Colony
11-0928	Shovelhead/Knucklehead	V-Twin
8602-20	Shovelhead Stroker	V-Twin



**Inner Pushrod Cover Set** in zinc plated steel for 1936-78 type OHV. Set of four.

VT No.	Year	Type	Brand
7808-4	1936-78	Cork	Colony
11-0924	1936-78	Cork	V-Twin
11-0908	1979-99	Quad	V-Twin
9213-4	1979-99	Quad	Colony



**Chrome Grooved Lower Pushrod Cover Set** made of billet, includes rubber seals. Fits 1948-84 Panhead/Shovelhead.

VT No. 7135-8

VT No. 7135-8T



37-9078



37-9079



11-1073

**Pushrod Cover Cup Set.**

VT No.	Item
37-9078	Chrome Skull
37-9079	Gold Skull
11-1073	Brass Hex



37-9078



37-9078



**Pushrod Cover Seal Kit** for 1948-78 Panhead-Shovelhead. Available in rubberized cork or blue rubber.

VT No.	Color
8728-12	Rubberized Cork
14-0970	Rubber



Quad

Cork

O-Ring

**Pushrod Cover Seal Kits** include enough pieces to seal four complete pushrod covers on years listed. Available in cork, quad, machined rubber seals.

James	VT No.	Type	Model/Year
14-0667	15-0626	Cork	1948-79 Big Twin
14-0823	14-0970	Rubber	1948-79 Big Twin, Silicone
14-0669	14-0027	Quad	1980-84 Big Twin



**Chrome Lower Push Rod Tube Sets.**  
\*Note: Gold Plated

VT No.	Brand	Year	Model
11-0922	V-Twin	1948-79	Panhead-Shovelhead
7823-12	Colony	1948-79	Panhead-Shovelhead
11-0907	V-Twin	1980-84	Shovelhead, Quad
11-0918*	V-Twin	1980-84	Shovelhead, Quad
7617-12	V-Twin	1936-39	Knucklehead
7824-12	Colony	1940-47	Knucklehead
7824-12T	V-Twin	1940-47	Knucklehead

VT No.	James	Year	Item
15-0116	15-1137	1936-Early 79	Small Cork
14-0028	—	1936-Early 79	Red Silicone
15-0348	—	1936-Early 79	Rubber
15-0117	15-1138	1948-Early 79	Large Cover
14-0029	—	1948-Early 79	Red Silicone
15-0349	—	1948-Early 79	Rubber



11-0921  
Stroker



11-0915 Stock

**Pushrod Cover Individual Parts**, in chrome steel.

VT No.	Model	U/M
11-0917	Cup	4
11-1073	Cups, Hex, Brass	4
11-0916	Clip	4
13-0101	Spring	10 pack
12-0711	Washer, Inner	10 pack
15-0117	Large Cork	100 pack
15-0116	Small Cork	100 pack
11-0915	1966-99 Big Twin Clip Stock	4
11-0921	1966-84 Big Twin Clip Stroker	4
11-1073	Brass Hex Cup	4

## Pushrod Seals

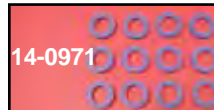

14-0971

**1936-47 Big Twin Pushrod Cover Seal Kits** include enough pieces to seal four complete pushrod covers on years listed.

VT No.	Color
14-0971	Blue
8729-12	Black



14-0508

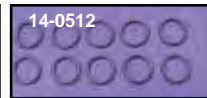

14-0512

**Pushrod Tube Quad Seals or O-Rings.** Quad Seals feature four side seal design, 10 pack.

VT No.	Use	Year
14-0508	Upper Cover Small Quad	1979-84
14-0512	Middle O-Ring	1979-up
14-0514	Lower O-Ring	1979-80
14-0513	Lower Cover Large Quad	1981-83



**Silicone Seals** are lathe cut, then ground with perfect outer diameter finish, withstand heat, oil and gas.

VT No.	OEM	Item	U/M
14-0028	17955-36	Small Push Rod	50 pack
14-0029	17955-48	Large Push Rod	50 pack

# 1948-65 Panhead Set

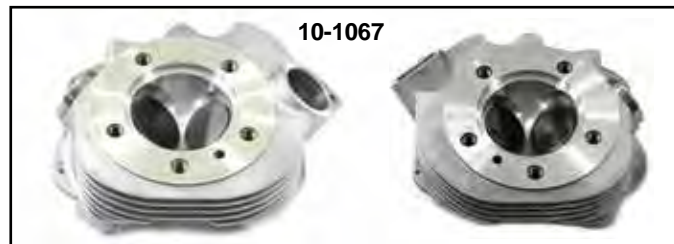
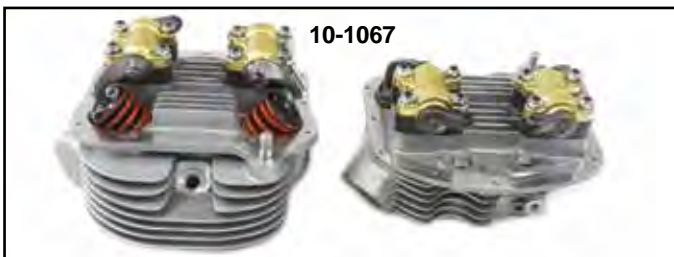
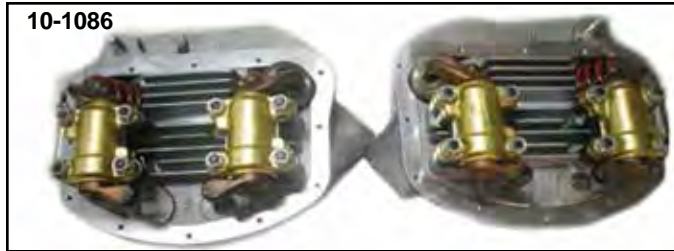

V-Twin "Motor Shop Ready" Panheads feature a Shovelhead o-ring intake port and exhaust port design. Heads are assembled with cast iron valve guides, nitrated valves (Panhead exhaust/ Shovelhead intake), valve springs, lower spring collar, upper spring collar, valve stem seals and valve keeper keys. Fully assembled sets include matched rocker arm assemblies, rocker arm studs and valve oilers installed. Available in single spark plug style only and for either stock or 3/8" big bore cylinders. Order late style o-ring manifold separately for use with Shovelhead cylinders.

Fully Assembled	Heads with valves	Bore
10-1086	10-1139	3 5/8" Big Bore
10-1067	10-1074	Stock Bore

3 5/8" Big Bore Panhead Top End.  
VT No. 10-1341



**Watch Our Videos!**

<http://www.youtube.com/user/TeddCycle>



Motor Shop Welding Service



Motor Shop Exhaust Port Replacement







# Panhead Set

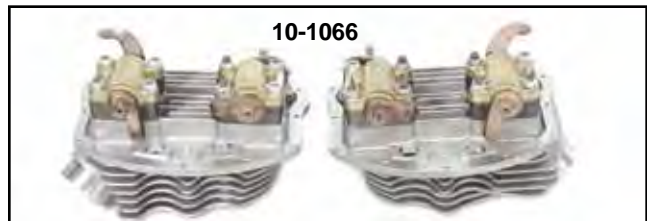

## V-Twin Replica "Shop Ready" Panhead

- Feature original contour castings with the added detail of the stock intake and exhaust port areas. Head are assembled with cast iron guides, valve stem seals, nitrated valves (Panhead exhaust, Shovelhead intake) valve springs, upper spring collar, lower spring collar and valve keeper keys.
- Fully assembled sets include matched rocker arm assemblies, rocker arm studs and valve oilers installed. Single plug side only.
- Order original plumber style or O-ring style intake manifold separately

View our exciting video of the Motor Shop. <http://www.youtube.com/user/TeddCycle>



Motor Shop Valve Service and Replacement



Full Assembled	Heads with Valves	Year	Intake
10-1065	10-1175	1948-54	Plumber
10-1066	10-1957	1955-62	O-Ring



Motor Shop Valve Service and Replacement

# Panhead Rocker Arm

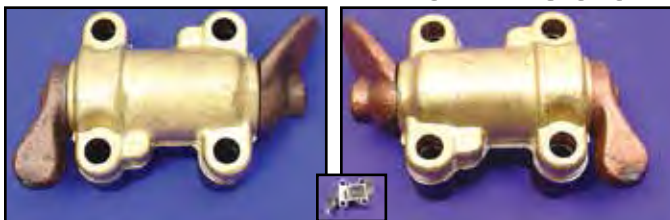

**Rocker Arm Assembly Kit** for 1948-65 Panhead includes all pieces to completely assemble the rocker arms on both heads. Includes four rocker housings with matching fitted rocker arms, heat treated studs and lock nuts, intake oiler tubes and dowel pins.

VT No. 11-0480

**Panhead Rocker Assembly** is complete with shafts and blocks for Big Twin Panheads 1948-65. Note: Upper and lower block set may have to be honed before final assembly for proper arm fit. Sold each.

- | VT No.  | Item  |
|---------|---|
| 11-0526 | Rocker Arm Assembly, rear exhaust, front intake |
| 11-0527 | Rocker Arm Assembly, rear intake, front exhaust |
| 11-0528 | Rocker Arm only, rear exhaust, front intake     |
| 11-0529 | Rocker Arm only, rear intake, front exhaust     |
| 12-2114 | Rocker arm stud 8-piece                         |
| 9917-8  | As Above Colony                                 |
| 12-0571 | Stud nut  |
| 11-0530 | Front oiler                                     |
| 11-0531 | Rear oiler                                      |
| 12-9912 | Rocker dowel pin set                            |
| 12-1292 | Head Plug                                       |

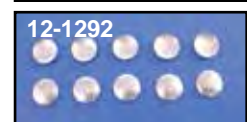



# Panhead Cover

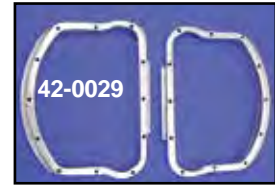

**D-Rings.** Order proper screws separately.

VT No.	Finish	Style
42-0104	Chrome	Steel
42-0758	Zinc	Steel
42-0105	Chrome	Thick Alloy
42-0029	Polished	Thick Alloy
42-0130	Cast	Thick Alloy



**Panhead Valve Cover Screws** in hex stock type, with built-in washer or allen screw type. Long screws for thick alloy D-rings. Short screws fit steel D-Rings.

VT No.	Finish	Fits D-Rings	Type
8732-24	Chrome	Alloy	Hex
8733-24	Cadmium	Alloy	Hex
8736-24	Chrome	Alloy	Allen
8734-24	Chrome	Steel	Hex
8735-24	Cadmium	Steel	Hex
8737-24	Chrome	Steel	Allen

**9984-24** Chrome Washer Set  
**9985-24** Cadmium Washer Set  
**¼ x 20 Hex Thread Screws for Heads** with stripped out threads. Pack of 6.

VT No.	Finish	Fits D Rings
2013-6	Chrome	Alloy
2014-6	Cadmium	Alloy
2015-6	Chrome	Steel
2016-6	Cadmium	Steel



**Forged Aluminum Billet Panhead Covers** full finned design for front and rear for use in custom frames with enough clearance.

VT No.	Finish
49-0789	Chrome
49-0790	Shot Peen



**Panhead Fins** are cast replicas. Panhead fins are to be used with thin D-Rings.

**VT No. 42-0744**



**42-0771 Replica Stainless Steel Panhead Covers** Shown with **42-0029 D-Rings**

**Replica Stainless Steel Panhead Valve Covers** are produced by New Tooling for exact fit and shape. Replaces 17500-48.

VT No.	Finish
42-0771	Stainless
42-0901	Chrome Stainless



**Panhead Covers** in sets for 1948-65 Big Twin.

VT No.	Finish	Type	Brand
42-0103	Chrome	Panhead Cover Set	V-Twin
42-0640	Chrome	Panhead Cover Set	Paughco
42-0759	Polished Aluminum	Panhead Cover Set	Paughco
42-0639	Chrome	Ribbed Panhead Cover Set,	Paughco

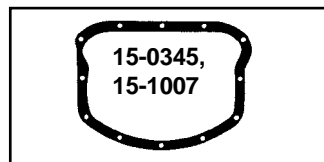

**Panhead Valve Cover Gasket.**

James	VT No.	OEM	Item
	15-1079	15-0111 17507-48	Inner Felt, Thinner .07" 1948-65
	—	15-0140 17507-48	Replica Inner Felt, Thick .15", 48-65
	—	15-0115 17541-48	Cover Gaskets, Thin
	15-1005	15-0114 17541-48A	Thick Composite
	15-1006	— 17541-48B	Thick Cork
	—	15-0347	Cork with metal
	15-1007	15-0345 17541-48B	Thin Graphite
	15-1271	— 17541-48B	Molded Rubber
	—	15-1244	D-Ring and Felt Kit





# Shovelhead Set



11-0082

1978-84 Rubber Band Type



11-0089

1966-77 O-Ring Type



10-1064

V-Twin Mfg. Assembled Heads with cast iron guides, valve stem seals, nitrated valves. Features a complete valve job for maximum flow, horsepower and torque. Available for stock bore application only. Head bolts not included. Max Lift is .550.

VT No.	Fits	Plug
10-1063*	1966-77	Single
10-1064*	1978-84	Single

\*Note: Assembled with chrome rocker box assembly.



40-0203



Rocker Box Line Kit includes "T". Chrome finish. Fits 1966-84 Shovelhead.

VT No.	Finish	OD
40-0203	Chrome	3 mm
40-0235	Brass	6 mm
40-0237	Chrome	6 mm

Replica Shovelhead Head Sets are completely assembled with unleaded valve seats, cast iron valve guides, nitrated valves, valve guide seals and stock type valve spring kit. Fits all 1966-84 Big Twins. Order stud set separately.

VT No.	Item	Year	Type
11-0089	Head Set	1966-77	O-Ring
11-0082	Head Set	1978-84	Band
12-2106	Stud Set (One Head)		



Chrome Engine Air Scoop will force air to rear cylinder. Mounts to left side of Big Twin Shovelhead 1966-84. Brackets are included.

VT No. 42-0317



S&S Cylinder Heads for Shovelhead are complete with valve guides with seals and springs, collars, keepers, and valve for use with up to .590 lift.

VT No.	Year
11-0044	1966-78
11-0046	1979-84



## Cylinder Base Nut

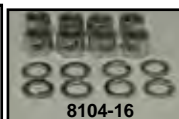

Big Twin 1936-85 Cylinder Base Nuts and Washers, eight piece sets.

VT No.	#	Year	Finish	Style
7017-16	A	1936-77	Chrome	Acorn
7813-8	B	1978-84	Chrome Milled	Hex Acorn
8600-8	C	1966-84	Chrome	Big Bore
8601-8	C	1966-84	Black Oxide	Big Bore
8437-16	D	1936-77	Chrome	Cap
8474-8	E	1978-84	Chrome Milled	Hex Cap
8104-16	F	1936-78	Chrome	Hex
8105-16	F	As above	Cadmium	Hex
9623-16	F	As above	Parkerized	Hex
9100-8	G	1978-84 80" Shovel	Chrome	Hex
9101-8	G	As above	Cadmium	Hex
9102-8	G	As above	Black Oxide	Hex
8860-8	H	Cylinder Base Spacer 1978-84 Shovelhead	Chrome	
8861-8	H	As Above	Black	
9715-8	I	7/16" Lockwashers	Chrome	
8171-8	I	7/16" Lockwashers	Cadmium	
9716-8	I	7/16" Lockwashers	Parkerized	

## COLONY Head Bolt Kit

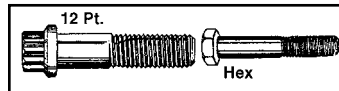

Head Bolts, Head Nut and Washer Kits are accurately machined from high strength steel and hardened to prevent stretching. All bolts feature rolled threads for superior strength and fit.

Big Twin 1936-85 Overhead Valve.

Cad	Chrome	Parkerized	Fits
7825-20	8221-20	—	1948-84 Pan/Shovelhead with washers
—	8777-20	—	As Above Allen
—	7153-20	—	As Above Acorn
—	8714-20*	—	1948-84 Big Twin 74 and 80
—	—	8618-20*	As Above, Black Oxide
—	37-8831*	—	S.T.D. Heads Special Big Twin 74 and 80 With coarse thread

\*Note: Install these bolts with a 7/16" 12 point box wrench.

Head Bolt Washer Kits

8170-10	8488-10	9704-10	For 1948-85 with 7/16" bolts
---------	---------	---------	------------------------------



# Shovelhead Rocker Box



**Rocker Shaft End Cap Kit** for Shovelhead as replica type with hex caps for left side.

VT No.	Year	Finish	Nut Type
2019-8*	1966-84	Chrome	Slot
2020-8*	1966-84	Cadmium	Slot
8222-8	1966-70	Chrome	Slot
8223-8	1966-70	Cadmium	Slot
8224-8	1971-84	Chrome	Allen
8224-8T	1971-84	Chrome	Allen
8225-8	1971-84	Cadmium	Allen

\*Note: Features 1/2 - 20 thread to be used on later type rocker shafts.



**Chrome Allen Rocker Shaft Plugs.** Set of 4. Fit 1971-84 FL-FX models. Includes sockets and cups.  
VT No. 37-0025



**Chrome Rocker Shaft End Plugs** add classic Knucklehead look to any Shovelhead engine. Installation or removal is much easier than original slotted part. Packaged four per set.

VT No.	Fits
7143-4	1966-70
7142-4	1971-84



7137-22



8449-22



8608-36

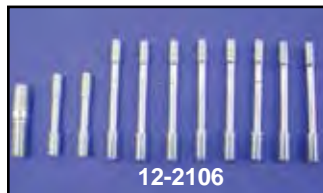

12-2106

**Rocker Box Nut Kit** is for 1966-84 Shovelhead in acorn or cap which includes shaft nuts and washers. Factory type nut sets include washers.

VT No.	Item	Finish
7137-22	Acorn Set	Chrome
8449-22	Cap Set	Chrome
8608-36	Hex Nuts	Chrome
8609-36	Hex Nuts	Cadmium
12-2106	Stud Set for 1 head	Zinc



**Rocker Box Covers** are cast aluminum with polished or chrome finish. Order studs separately, per head.

VT No.	Fits	Type
11-0057	1966-84	Polished
11-0534	1966-84	Chrome
11-0091	1966-84	Polished
11-1077	1966-84	Chrome Assembly
11-1070	1966-84	Chrome Bare
12-2106 Studs	1966-84 Big Twin	Stud Set for 1 head, V-Twin
12-2524 Studs	1966-84 Big Twin	Stud Set for 1 head, Sifton

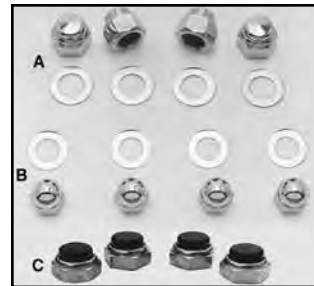

12-8955



8400-8

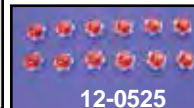

12-0525



8730-8

**Rocker Shaft End Nut Kit** includes four chrome acorn or cap style nuts and washers for replacing "Red Dots" nuts on Shovelhead Big Twin 1966-84, 7/16 — 20 thread nut.

VT No.	#	Type	Finish
8400-8	A	Cap	Chrome
8401-8	A	Cap	Cadmium
8730-8	B	Acorn	Chrome
12-1193	B	Washers	20 pack

**Rocker Shaft End Caps.**

VT No.	#	Color	Finish
12-0525	C	Red	Chrome
12-8955		Red	Replica
12-1966		Red	Satin
37-8926	C	Orange	Nickel
12-0405	C	Green	Nickel

8614-4



**Rocker Shaft End Caps** provide ease of installation, ample clearance between gas tank and a custom touch for Shovelhead 1971-85.

VT No. 8614-4

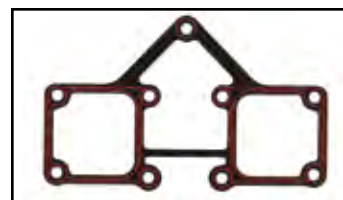

**Metal Backed Rocker Box Gasket Set** features beaded sealing.

VT No. 15-1526





# Shovelhead Top End Kit

Shovelhead Top End Kits include

- Prefitted cylinder set
- Late style assembled heads
- Cylinder base nuts
- Assembled rocker boxes in chrome or polished finish
- Rocker box studs and nuts
- Top end gasket set

VT No.	Size	Rocker Box	Comp
11-0860	74"	Polish	8.5:1
11-0861	74"	Chrome	8.5:1
11-0862	80"	Polish	8:1
11-0863	80"	Chrome	8:1



11-0577



11-0577

**Rocker Box Assembly** for 1966-84 Shovelheads includes covers in chrome or polished finish, four arms, four shafts and chrome end shaft nuts. Assembled.

VT No.	Finish
11-0577	Chrome
11-0578	Polished



11-0520



11-0521

**Rocker Arms** for 1966-84 Big Twin include bushings installed.

VT No.	OEM	Type
11-0520	17360-66	Rear Exhaust, Front Intake
11-0521	17375-66	Front Exhaust Rear Intake



11-0517



14-0148

**Sifton Rocker Adjuster Kit** stops top end clatter on all 1966-84 Shovelheads. Kit includes four steel spacers, four tempered pre-load spring washers and four no-leak rocker seals. No-leak seals are machined of high grade nylon to replace O-Rings on 1966-84 Big Twin. Will not crack, melt or shrink.

VT No.	Item
11-0517	Complete kit
14-0148	No-leak seal sets



**Rocker Arm Shims** fit 1966-84 Big Twin.

VT No.	Size
12-0704	.005
12-0710	.007
12-0715	.015



10-2106



10-0700

**Rocker Arm Bushings** replace 17428-57. Use on 1966-up Big Twin models.

VT No.	Type
10-0700	Stock Split
10-2106	One Piece Sifton

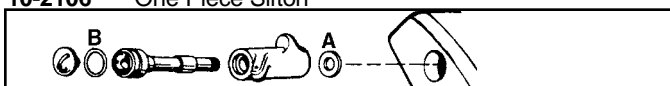

**Rocker Arm Spacer and Shims.**

VT No.	OEM	#	Model	Item	Qty
12-2115	17452-66	A	66-84 Big Twin	Spacer	4 pack
12-2122	17450-73	B	66-84 Big Twin	Shim	10 pack
14-0501	11101			O-Ring	10 pack



11-0570

**Rocker Arm Shaft** for 1966-84 Big Twins.

VT No.	OEM	Brand	U/M
11-0570	17611-66A	Sifton	4
11-0519	17611-66A	V-Twin	Each
11-0539	As Above	Jims	Each



**Sifton Rocker Arm and Shaft Kit** fits 1966-84 Shovelheads includes four rocker arms with bushings installed, four shafts, shims, spacers, chrome replica end caps and nuts.  
VT No. 11-0819



**Jims Roller Rocker 4 Arm Set** features greater strength in critical areas, 660 Bronze bushings with a hardened steel roller tip. Use stock type rocker arm shafts.

VT No.	Item
11-0573	Shovelhead 1966-84 1.50 ratio



# Knucklehead

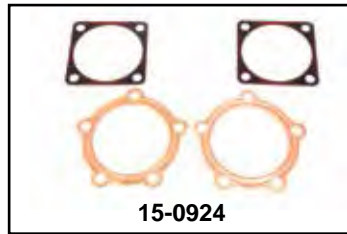
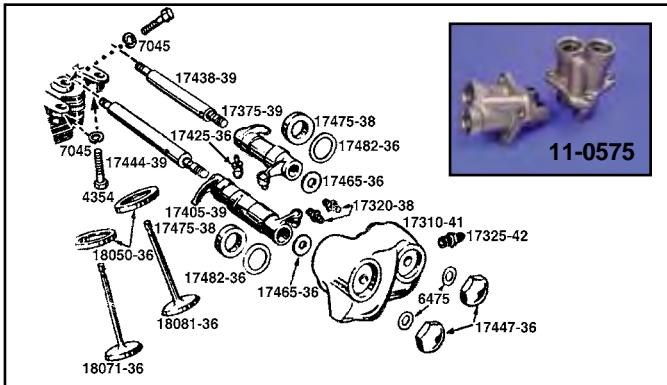

## Knucklehead Top End Parts.

VT No.	OEM	Item	Finish
7110-8	17447-36	Nut Set	Chrome
11-0817	17447-36	Nut Set	Cadmium
11-0818	17447-36	Nut Set	Parkerized
7605-4	17465-36	Thrust Washer Set of 4 and	
	17482-36	Seal Washer Set of 4	
12-0730	6475	Nut Washer	Brass
15-0574	469-15	Fiber Washer	
7705-4	17320-38	Drain Tube Fitting	
8941-3	17325-42	Oil Feed Fitting	
11-0558	17425-36	Rocker Arm Ball Stud	
14-0172	17475-38	Oil Seal	
11-1454		Seal Extension	
11-0675	18050-36	Valve Seat	
11-0575	18600-36	Tappet Block Set	
	18610-36		
9622-16	2329	Tappet Block Screw	Parkerized
8103-16	2329	Tappet Block Screw	Cadmium
8102-16	2329	Tappet Block Screw	Chrome
14-0451		Seal Kit with tube	
15-0924		Head Gasket Set	

# Knucklehead Valve Train



## Knucklehead Valves 1936-47

Type	OEM	V-Twin Steel	V-Twin Nitrate	Precision Machining Black Diamond™
Intake	18071-36	—	11-9641	11-6095
Exhaust	18081-36	11-0613	11-9643	11-6096
Exhaust	1/8" O.S.	—	11-9644	—

**Valves** by Precision Machining (Kibblewhite). Intake valves are made of 8645 heat treated valve steel and the exhaust valves are made of 21-2N heat treated non-magnetic stainless steel.



**Complete Valve Spring Kit** includes springs, collars and keepers necessary for 1936-47 61 and 74 Knucklehead  
VT No. 13-9192



**Valve Spring Kits** include inner and outer springs. Order collars and keepers separately. Fit 1936-47 Knucklehead.

VT No.	OEM	Item
13-9523	Sifton	Spring Set, 8 piece
13-0792	Replica	Spring Set, 8 piece
11-0647	18222-36	Lower Collar Set
11-0644	18221-36	Upper Collar Set
11-9623	18228-36	Valve Keeper



**Rocker Arm Shaft Adjusting Tool** for Knuckleheads. Fits 1936-47.  
VT No. 16-0001

## Knucklehead Guides V-Twin Cast Iron

Size	Intake	Exhaust
Standard	11-0790	11-0791
Standard	11-1967	Set
Seal	14-0452	—

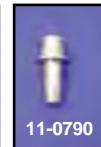

**Knucklehead Gift Set** includes motor model, keychain, lapel pin, belt buckle.  
VT No. 48-1375



**Knucklehead Illustration Patch.**  
VT No. 48-1163



**V-Twin Knucklehead Parts Dope Reference Guide** for 100% V-Twin restoration components and linkert tips for 1936-47 Knuckleheads is volume #2.  
VT No. 48-1331





# Replica Knucklehead



10-1007

### Knucklehead Flywheel Assemblies.

Trued, ready for installation. All parts brand new!

### VT No. Year Type

10-1070	1936-40	61"
10-1172	1941-52	61"
10-1007	1941-47	74"
10-1112	1941-47	Stroker

### Flywheel Sets Only

10-1601	1941-52	74"	VT
10-1043	1936-40	61"	TO
10-1005	1941-53	74"	TO

10-1941 for Motor

Replica Knucklehead long block comes complete with linkert brass carburetor. Fits 1936-1947. VT No. 10-1941

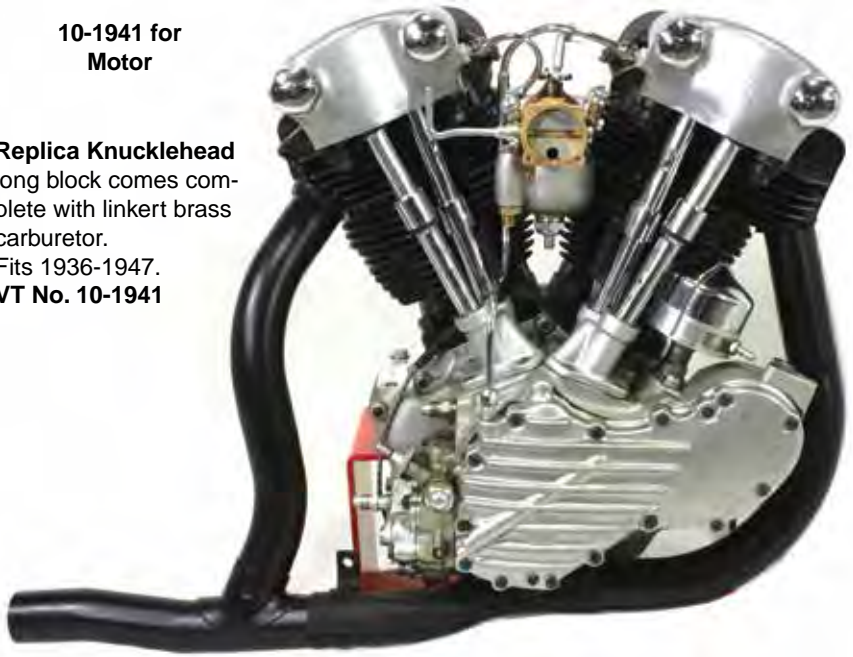

Note "Baby Butt" manifold is fitted to 74" large port cylinder heads, to accept a 3 bolt Linkert carburetor on the later Knuckleheads.



Linkert Detail



VT No. 29-1115



Replica Knucklehead Motor is fitted with V-Twin Mfg.'s exclusive replica exhaust system produced with our world exclusive tooling and fixtures.

Every Part By V-Twin Mfg.

## Replica™ Knucklehead

11-0850



11-0850



**V-Twin Replica™ Knucklehead Head Set** feature original cast iron with black finish. Head sets include valves, springs, collars, guides with parkerized upper and lower valve cover sets installed.

VT No.	Item	Type
11-0850	1937-40	With valves
11-0857	1941-47	With rocker assembly
11-0858	1941-47	With rocker assembly and chrome covers
11-0891	1941-47	With valves, shafts, arms and boxes



40-0240



40-0247



40-0239



9848-9

### Top Oiler Line 1936-47 Knucklehead.

1936-41 is banjo type. 1942-47 is flared nut type in tin or chrome finish.

VT No.	OEM	Year	Item	Finish
40-0240	3573-36	1936-41	Banjo line	Tin
40-0247	3573-36	1936-41	Banjo line	Chrome
40-0518	63578-36	1936-41	Banjo Bolt, each	Cadmium
9848-9	Kit	1936-41	Banjo Nipple Kit	Cadmium
			with banjo bolt and washer	
9847-9	Kit	1936-41	As Above	Chrome
14-0154	6440	1936-41	Washer for above, 10 pack	
40-0112*	63480-42	1942-47	Oil Line	Chrome
40-0239*	63480-42	1942-47	Oil Line	Tin
8941-3	17330-42	1941-47	Line Fittings	Cadmium
	17325-42		3 piece set	
7349-3	As above			Chrome
8630-1	33615-36	1936-41	Line Fitting	Cadmium
			For Timing Cover	
9738-1	33615-36	1936-41	As Above	Chrome
9701-1	33615-36	1936-41	As Above	Parkerized

\*Note: Nut type ends.



**1940-47 Knucklehead Oil Filter and Bracket Kit** includes oil filter assembly with polished top and chrome canister body and zinc plated mount bracket. Order oil lines and fittings separately.

VT No.	Item
40-0564	Oil Filter Kit
40-0370	Oil Line Set, Cadmium
40-0107	Oil Line Set Chrome
40-0505	Fitting Set

40-0505

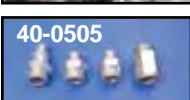

## Knucklehead



42-6174

**Knucklehead Lower Valve Spring Cup Sets** include parkerized 4 piece set of lower covers with oil lines and nuts attached. Kit also includes rocker cover strip set with screws in parkerized finish and chrome or parkerized cover set with gaskets.



42-3637

VT No.	Finish	Year
42-3637	Parkerized	1936-37
42-6174	Parkerized	1938-47
42-6175	Chrome	1938-47

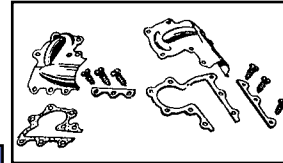

42-0863

42-0854

**Knucklehead Rocker Parts.** Order strip set with gaskets separately.

VT No.	Item	Finish
42-0863	Cover Set, Replica	Chrome
42-0854	Cover Set	Parkerized
7517-8	Cover Strip and Gasket Kit	Zinc
7517-8T	As Above, V-Twin	
42-0864	Cover Strip and Gasket Kit	Parkerized
42-0983	Cover Strip and Gasket Kit	Chrome
15-0270	Cover Gaskets Only	
37-0565	Cover Screw, 34 pieces	Parkerized
8440-12	Mounting Kit	Chrome

### Head Bolt and Washers for 1936-47 OHV Knucklehead.

Parkerized	Cad	Chrome	Fits
9725-20	7713-20	—	1936-39 with washers
—	—	8456-20	As Above Cap Style
9726-20	7714-20	8220-20	1940-47 with washers
2010-10	2009-10	—	1936-47 OHV, Washers only

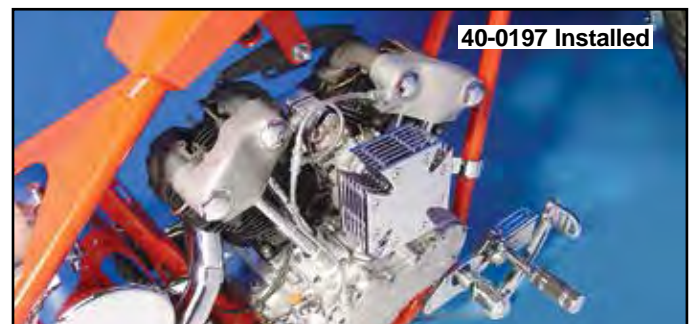

40-0197 Installed

**1941-47 Braided Top Oil Line**  
VT No. 40-0197





# Knucklehead



1936-99 Shown Installed



**Pushrod Cover Kit** for 1936-39 Knucklehead includes chrome lower tubes, clips, cups, and zinc inner tubes, complete with gaskets and springs.

Replica Pushrod Cover Kits are in chrome steel.

VT No.	Finish	Year	Model
11-0904	Chrome	1936-39	61"
11-0903	Chrome	1940-47	61" and 74"
11-0939	Cadmium	1940-47	61" and 74"

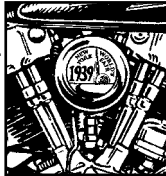

**1936-47 Tappet Block Kit** includes four standard size lifters with adjusters and zinc finish tappet blocks. VT No. 11-0598



10-0782

**Sifton Tappet Assembly for Knucklehead** feature centrifric surface fine grinding and precision fit rollers and pins. Solid units include adjuster screws and lock nuts. Sold in set of four.

VT No.	Size
10-0782	Standard
10-0783	.005

**Tappet Assemblies** for 1936-47 Knucklehead.

Jims	Eastern	Item
10-0647	10-0510	Standard 18493-36 Exhaust
—	10-0511	.005 Exhaust

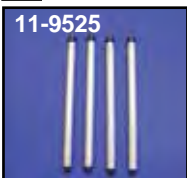

11-9525



11-1303

**Solid Pushrods for Knucklehead.**

Sifton	Colony	Year/Model
11-9525	7505-4	1941-47 74"
—	7518-4	1936-47 61"
11-1303	—	Replica



49-2601



49-2650



49-0011



49-0037



10-1186

**Rocker Box Set** for 1938-47 Knucklehead.

VT No.	Finish	Year
49-2601	Natural	1941-47
49-2650	Polished	1941-47
49-0039	Polished	1936-40
49-0037	Nuts	1936-47
49-0011	Rocker Box	1936-40
10-1186	Cast Tab Set	1936-47



9699-12

**Hex Rocker Mounting Kit** includes plated stock replacement bolts and washers used to mount rocker boxes on 1936-47 FLKn.

VT No.	Finish	Type
8778-12	Chrome	Hex
8779-12	Cadmium	Hex
9699-12	Parkerized	Hex



11-0559

**Replica Knucklehead Rocker Arm and Shaft Kit** includes 4 forged steel rocker arms with ball studs installed and 4 matching shafts.

VT No.	OEM	Item
11-0559	Kit	Arms and Shafts

**Knucklehead Rocker Shaft Four Piece Set**

which includes 17441-39, 17438-39, 17441-39 and 17444-39. Fits 1939-47 Overhead Valve 61" and 74".

VT No.	Size	Type
11-0540	Standard	Sifton
11-0025	Rocker Arms	

**Shaft End Nuts, left side**

9840-8	Chrome
9841-8	Cadmium
9842-8	Parkerized

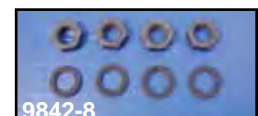

9842-8



# OHV Valve Guide

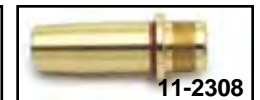

Big Twin 1948-78							
Size	V-Twin Cast Iron		Precision Machine Cast Iron		Precision Bronzium	Precision Manganese Bronze	
	Intake	Exhaust	Exhaust	Intake	Intake	Intake	Exhaust
Standard		11-0705	11-1166	11-1167		11-2300	11-2308
+0.01		11-0691	11-0967	11-0975		11-2301	11-2309
+0.02		11-0706	11-0968	11-0976		11-2302	11-2310
+0.03		11-0688	11-0969	11-0977		11-2303	11-2311
+0.04		11-0707	11-0970	11-0978		11-2304	11-2312
+0.06	11-0703	11-0708	11-0971	11-0979	11-0743	11-2305	11-2313
+0.08	11-0704		11-0972	11-0980		11-2306	11-2314
+0.10			11-0973	11-0981		11-2307	11-2315



Big Twin 1948-78			
Size	Precision Machine Ampco 45		Rowe Ampco 45
	Intake	Exhaust	Intake
Standard	11-1164	11-1165	
+0.01	11-0951	11-0959	
+0.02	11-0952	11-0960	
+0.03	11-0953	11-0961	
+0.04	11-0954	11-0962	
+0.06	11-0955	11-0963	
+0.08	11-0956	11-0964	11-1876
+0.10	11-0957	11-0965	11-1962

### Late Shovelhead

Size	Precision Machine Ampco 45		Precision Machine Cast Iron		Precision Machine Manganese Bronze	
	Intake	Exhaust	Intake	Exhaust	Intake	Exhaust
Standard	11-0982	11-0989	11-0996	11-1003	11-2326	11-2331
+0.01	11-0983	11-0990	11-0997	11-1004	11-2327	11-2332
+0.02	11-0984	11-0991	11-0998	11-1005	11-2328	11-2333
+0.03	11-0985		11-0999	11-1006	11-2324	
+0.04		11-0993	11-1000	11-1007	11-2329	11-2334
+0.06	11-0987	11-0994	11-1001	11-1008	11-2330	11-2335
+0.08			11-1002	11-1009		



### Late Shovelhead 1979-84

Size	V-Twin Cast Iron		Rowe Cast Iron	Rowe Ampco 45
	Intake	Exhaust	Intake	Intake
STD	11-0714			11-1883
+0.03		11-0695	11-9795	
+0.04				11-1886
+0.06				11-1887



**Big Twin 1979-80 Valve Guide Retaining Ring.** Replaces 18105-79. VT No. 12-0936



**Overhead Valve Guide Gasket.**

VT No. OEM Years  
 15-0297 18265-37 1936-47  
 15-0210 18196-51 1948-85



**Rowe Patch.**  
 VT No. 48-1523

48-1523



48-0498  
80" UL



48-0470  
Knucklehead



48-0030  
1340 cc



48-0033  
Dual Cam



48-0025  
Panhead



48-0044  
Shovelhead



48-0048  
Shovelhead



48-0372  
XLCH 1971



48-1824  
45"

**Motor Plaques** measure 18" x 24" and are made of metal.

**Motor Plaque Set** includes 9 plaques. VT No. 48-1811





# Valve Guide



**Guides** to accept seals on 1981-85 Shovelhead standard size with replica valves.

Guide	Type	Valve	Seals
11-1168	Exhaust	11-1135	14-0145
11-1169	Intake	11-1136	14-0145
Collar	Type		
11-0648	Upper		
11-0666	Lower		
11-0513	Keeper		

Rowe Unhoned Cast Iron Valve Guides					Rowe Iron Tru-Bore Guide		
Intake and Exhaust Guide is the same unless noted.					inner diameter. Honed		
Size	Shovelhead Circlip Type Late 1979-84	Shovelhead Flange Type .040 Shorter*	Shovelhead Flange Type .060 Shorter*	Pan/Shovel 1948-79	1948-79 Machined to accept guide seal (by V-Twin)	1979-84 Shovel Intake	1979-84 Shovel Exhaust
Standard	—	—	—	—	11-9631	—	—
.001	—	—	11-2119	—	11-9632	—	—
.002	—	—	11-2122	—	11-9633	—	—
.003	—	—	11-2125	—	11-9663	11-1929	—
.004	11-2126	—	—	—	11-9634	11-1930	—
.006	—	11-2130	11-2131	—	11-9635	—	—
.008	—	—	11-2134	—	11-9636	—	—
.010	—	—	—	—	—	—	—
.012	—	—	—	—	—	—	—
Top Dia.	.625	.625	.531	.562	.562	.060"	.060"
Seal#	14-0146	14-0146	—	14-0145	14-0145	—	—
Overall	1.98	1.96	1.940	.210	—	1.92"	1.92"
Length					*For High Lift Cams		

## Valve Guide Seal



**Valve Stem Oil Seal Kits** include four pieces of proper guide seal and installation tool.

VT No.	Year
16-0403	1948-79
16-0404	1980-84



**Sifton Valve Stem Seal** features a Viton seal with double coil spring for tension, and steel band to secure to guide. Fits 1948-84 Shovelhead.

VT No. 14-0973



**Sifton Teflon Valve Stem Seal Set** for Big Twin provide maximum valve stem oil control as seals wipe excess oil from the valve stem by means of a unique spring loaded wiper assembly which prevents unwanted oil from reaching and contaminating the cylinder. Machining required. Fits 1948-84.

VT No. 14-0259

## Valve Seat



11-0641

**Stock Replacement Valve Seats** for Big Twin models.

VT No.	OEM	Fits	Type
11-0651*	18018-66	Intake 1966-84	Nickel
11-0653*	18017-66	Exhaust 1966-84	Nickel
11-0675	18050-36	Intake and Exhaust 1936-47 Knucklehead	Nickel

\*Note: For use with unleaded or leaded gasoline.

**Oversize Valve Seats** can be used with unleaded gas. Replacement size is actual size of seat supplied by V-Twin Number. Stock size is noted as reference only.

### Intake

VT No.	Fits	Stock Size
11-0641	1948-65	1.940 x 1.562 x .400
Replacement Size		2.016 x 1.635 x .453
11-0670	1966-84	2.132 x 1.752 x .400
Replacement Size		2.164 x 1.750 x .453

### Exhaust

11-0641	1948-65	1.940 x 1.562 x .400
Replacement Size		2.016 x 1.635 x .453

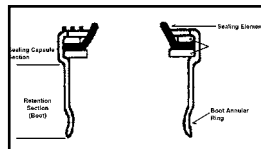

**Valve Stem Seals** in 10 packs for years listed. Installation tools and plastic 10 pack sleeves available separately.

VT No.	Fits	Mfg. No.
14-0145	Big Twin 1948-78	1408
14-0146	Big Twin 1979-84	1427
14-0982	Big Twin 1948-78	Sifton
14-0375	Big Twin 1979-84	Sifton
16-1753	Sleeve 3/8"	

### Installation Tools

16-0133	1948-79 Big Twin	Black
16-0134	1981-83 Big Twin	White

Note: 14-0164 is 5/16, 14-0145 and 14-0146 are 3/8.

YouTube



Welcome to Motor Shop

Watch Our Video!

<http://www.youtube.com/user/TeddCycle>

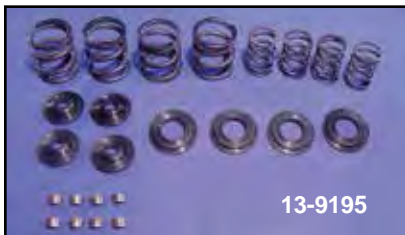

**Valve Spring Kits** include all springs, collars and keepers necessary for each application.

VT No.	Year	Model
13-9193	1948-79	Pan-Shovelhead
13-9194	1980-81	Shovelhead
13-9195	1981-84	Shovelhead Big Twin



**1948-84 Pan-Shovelhead Valve Spring Sets** include inner and outer.

VT No.	Fits	Replaces
13-0169	1948-84	18201-57B/18204-36A
13-0179	1966-84	18201-82/18202-82



**Andrews Valve Gear** for 1966-84 Shovelhead 74 and 80.

VT No.	Fits
11-9877	Upper Collar, T-6 Aluminum for .600 lift, 4 piece set
11-9878	Upper Collar, T-6 Aluminum, adds .060" spring travel and is for medium lift
11-9879	Low profile, lower spring collars, accept 1980-up guides + K Line seals. Also provides easier installation of high lift cams
13-9250	Hi-Lift Spring Set

# Valve Spring Kit



**Valve Keeper Keys** are packaged and sold in four pairs per package enough for one engine. Fits 1936-85 Big Twin. Keys are split type.

VT No.	OEM	Brand
11-0513	18228-36	V-Twin
11-9616	18228-36	Manley
11-9623	18228-36	Sifton



**Steel Valve Collars 61, 74 and 80 Big Twin.**

VT No.	OEM	Use	Year
11-0515	18222-48	Lower	1948-79
11-0644	18221-36	Upper	1936-80
11-0516	18222-79	Lower	1980-Early 81
11-0666	18222-81	Lower	1981-84
11-0648	18219-81	Upper	1981-84
11-0712	18219-81	Upper	1981-84



**1948-79 Lower Collar Seal Set** includes four seals (VT No. 14-0145) to use with stock style guides.

VT No. 11-0874



**Crane Valve Springs and Retainers** for 1948-84 models. Thermo-cool coated springs reduces friction and disperses heat quicker than a stock spring. Order set of four upper retainers separately

VT No.	Item	Type
13-9172	Valve Spring Set	Performance
11-7750	Upper Retainer Set	Chromoly

1 cubic inch = 16.38 cc

1 cubic inch = .0163871 liter

$$\text{Cubic Inch} = \pi r^2 \times \text{Stroke}$$

$$r = 1/2 \text{ of Bore}$$

		CUBIC INCH CHART								
		Stock 74				Stock 80				
		STROKE	3 1/2"	3 13/16"	3.968"	4 1/4"	4 1/2"	4 5/8"	4 3/4"	5.00"
<b>B O R E</b>					74"	80"				
		2 3/4"		45"						
		3 5/16"	61"							
		3 7/16"	64.8"		73.7"	78.7"	83.4"	85.7"	88.0"	92.8"
		3 1/2"	67.2"		76.3"	81.6"	86.6"	89.0"	91.4"	96.1"
		3 5/8"	72.1"		81.7"	87.4"	92.9"	95.5"	99.0"	103.2"
		3 11/16"	74.6"		84.7"	90.7"	96.1"	98.8"	101.5"	106.8"
		3 13/16"	79.9"		90.6"	97.0"	102.8"	103.7"	108.9"	114.2"
		3 7/8"	82.3"		93.4"	100.1"	100"	108.9"	111.9"	117.8"
		4.00"	87.9"		99.7"	106.8"	113.0"	116.1"	119.3"	125.6"
	4 1/8"	93.4"		106.0"	113.5"	120.2"	123.5"	126.9"	133.6"	
	4 1/4"	99.2"		112.6"	120.5"	127.6"	131.1"	134.7"	141.8"	





# Valve Spring

13-2110



**Sifton Lightweight Valve Spring Kits** include springs, keepers, retainer, and lower collars unless noted.

**74" and 80" Shovelhead, 1966-84**

**VT No. Type**

**13-2110** Has 160 lb seat pressure, up to .600" valve travel. Hard-anodized aluminum retainers. Uses stock lower collars.

**13-2115** Has 160 lb seat pressure up to .600" valve travel. Titanium retainers. Uses stock lower collars.



**Sifton Valve Spring Retainers and Keeper Sets.** Keepers are CNC machined and then heat treated.

**Keeper Set**

**11-2021** Pan/Shovelhead

**Upper Retainer Sets**

**11-2020** Pan/Shovel Titanium Offset 0.70" to allow more installed spring height.

**11-4248** Pan/Shovel aluminum offset 0.70" to allow more installed spring height.

**11-2022** Lower collar set. Pan/Shovelhead machined to work with .562" diameter guide seals and counter Bored for added clearance.

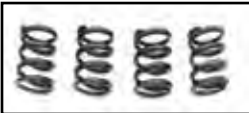

**Sifton Big Twin Valve Spring Set** for high lift cams can be used with stock retainers and lower collars for up to .600" lift. Fits 1948-84.

**VT No. 13-2000**



# Valve Spring



**Manley 1948-79 Valve Spring Kits 74 and 80 FL-FX .495 Lift Kits except Evolution**

VT No.	Collars Top	Combined Loads	Coil Bind	Recommended Cam Lift
11-9229	Titanium	140 @ 1.480 300 @ 1.000	.950	Stock-.500"

The above ".495" lift kits do not require cylinder head machining for installation. These kits are supplied with lower collars that allow additional spring travel as compared to stock collar and provides these kits the ability to accept camshafts up to .495" lift. Note: 11-9229 is for stock stem diameter valves

**Manley Valve Kits. 74 and 80 FL-FX .500"-.600" Lift Kit except Evolution**

VT No.	Combined Loads	Coil Bind	Recommended Cam Lift
11-9612	180 @ 1.600 320 @ 1.100 360 @ 1.000	.930	.500-.600

The above kit features tri-spring (outer-intermediate-inner) interference fit to reduce harmonics and control spring surge. Additional machining is required to lower the height of the valve guide to avoid interference with the top collar. Springs have more pressure than stock but can be used with .500" lift or .600" lift cams. Includes titanium top collars.

**74 and 80 FL-FX .465" Lift Kit except Evolution**

VT No.	Combined Loads	Coil Bind	Recommended Cam Lift
11-9613	150 @ 1.450 300 @ 1.000	.950	Stock .465

The above kit does not require machining for installation. However, do not exceed .465 lift due to the potentially high stress on the springs. The springs are interference fit to help the harmonics. Supplied with steel top collars. Use with stock stem diameter valves only.



11-9621

**FL-FX Upper Collar** for fitment of the double matched springs, color coded, for stock valve stem diameters, fits 1941-84 Big Twin models, in set of 4.

**Red Collars** used most often by combining ease of installation and good spring pressure, which will accommodate most cams. Allows spring to sit .080 higher than green collars.

**VT No. 11-9621**



**Sifton Valve Spring Kits** feature four double matched competition springs. Fits 1941-84 FX-FL, order top colored collars separately from this page. Mfg# 3030.

**VT No. 11-9618**



**Valve and Spring Kit by**

**Sifton for Shovelheads**

includes two intake and two exhaust valves with nitrated finish, complete spring set and keepers with upper and lower collars. Four piece valve set available separately.

VT No.	Year	Item
11-0794	1966-79	Kit
11-0795	1980-81	Kit
11-0796	1982-84	Kit
11-0679	1966-84	Valve Set



**Sifton Valve Keepers.** 1941-84 FL-FX steel valve keepers fit stock 3/8" valve stems. Sold in sets of four.

**VT No. 11-9623**



**Sifton 74 Pan Valve Spring Set** with 160 lb seat pressure, .600 valve travel and titanium retainers.

**VT No 13-2010**



**S&S Complete Valve Spring Steel Kits** for L1981-84 BT. Each kit includes springs, top collar, lower collar, retainers and shims. Cam to .590" lift

**VT No.11-2063**



**S&S Valve Spring Kits Pan-**

**Shovelhead 1948-84 Big Twin** to be used with stock style guides and lower spring collars, stock 3/8"

diameter valves, and stock keepers. By grinding .060 to .090 off the tops of the valve guides cams with lifts up to .550" may be used. Kit includes four aluminum top collars and four of each inner and outer springs.

**VT No. 13-9226**



# Replica Valves



Model and Year	Type	OEM	Sifton		V-Twin™			
			Nitrate Steel	Steel	Nitrate Steel	Chrome Steel	Stainless Nitrate Steel	Stainless Steel
Shovelhead	Intake	18075-81	11-1136		11-0845			11-1132
	Exhaust	18086-81	11-1135		11-0846			11-1133
Panhead	Intake	18071-48			11-9664		11-0624	11-9659
	Exhaust	18082-57	11-1120	11-0661	11-0614	11-0632		11-9656
	Intake	1/8" Oversize		11-9645				
	Exhaust	1/8" Oversize		11-0615				
Shovelhead	Intake	18074-66	11-1119	11-0664	11-0605	11-0630	11-0625	
1966-85	Exhaust	18082-57	11-1120	11-0661	11-0614	11-0632		11-9656
	Intake	1/16" Oversize		11-9295	11-0606			
	Exhaust	1/16" Oversize			11-0615			
Shovelhead	Intake	18074-66					11-2000	



Model and Year	Application	ROWE VALVES		PRECISION MACHINE		
		Forged & Shot Peened Head		Stainless		
		Roller Burnish Stem (1)		Black Diamond™ (6)	Racing Black (4)	Razor (5)
Panhead 1948-1965	Intake 18071-48	—		11-6000	—	—
	1/16" O.S.	—		11-6007	—	—
Shovelhead 1966 and Later	Intake 18074-66	11-6030		11-6001	—	—
	1/16" O.S.	—		—	11-6015	—
	Exhaust 18086-81	—		11-6007	11-6017	11-6085
	5/32" O.S.	—		—	11-6016	—
Shovelhead 1981-84	Exhaust 18086-81	—		11-6089	—	—
	Intake 18075-81	—		11-6090	—	—

Valves by Rowe or Precision Machining (Kibblewhite). Intake valves are made of 8645 heat treated valve steel and the exhaust valves are made of 21-2N heat treated non-magnetic stainless steel. These valves are available with the following stems and heads:

- Roller Burnished Stem:** Roller burnishing smooths the finest grind finish (16 microinch) to a 4 microinch.
- Racing by Kibblewhite Precision Machining** feature a sharper profile angle to maximize flow, 11-6015 has 2.00 head, 11-6016 has 1.812 head, 11-6017 has 1.780 head, 11-6018 has 1.90 head and 11-6019 has 1.63 head.
- Razor Back by Kibblewhite** are one piece forged EV-8 stainless steel, fully CNC machined with hard chrome stems.
- Black Diamond:** One piece stainless steel valve with a stellite tip and black nitron impregnated stem to improve wear properties and reduce friction.



**Chromoly Valve Keys (Set of 8)** for Pan/ Shovelhead 1948-81.  
VT No. 11-9614



**Manley Stainless Valve** machined from 1-piece forging with a swirl polished finish and chrome plated stem. Sold pairs.

### Shovelhead 1966-85

VT No.	Type	Head Dia.	Stem Dia.	OEM
11-9012	Intake	1 <sup>5</sup> / <sub>16</sub> stock	.3765 stock	18074-66
11-9013	Ni Intake	1 <sup>5</sup> / <sub>16</sub> stock	.3765 stock	18074-66
11-9011	Exhaust	1 <sup>3</sup> / <sub>4</sub> stock	.3745 stock	18082-57
11-9014	Ni Exhaust	1 <sup>3</sup> / <sub>4</sub> stock	.3745 stock	18082-57

### Panhead 1948-65

VT No.	Type	Head Dia.	Stem Diameter	OEM
11-9028	Intake	1 <sup>3</sup> / <sub>4</sub> stock	.3765 stock	18074-48
11-9011	Exhaust	1 <sup>3</sup> / <sub>4</sub> stock	.3745 stock	18082-57

**Note:** Ni is Nitrate finish.

**Manley's "Street Master"** intake and exhaust valves feature stainless steel construction, chrome plated stems, hard tips, smooth turned underhead angle and radius, forged combustion dish and machined combustion face rim.

VT No.	Type	Head Dia.	Stem Dia.	OEM
<b>Shovelhead 1966-85</b>				
11-9020	Intake	1 <sup>5</sup> / <sub>16</sub> " stock	.3765 stock	18074-66
11-9021	Exhaust	1 <sup>3</sup> / <sub>4</sub> " stock	.3745 stock	18082-57





# Pan-Shovelhead Cylinder and Piston Kit

Over 50,000 Pieces Served Since 1978!



**Replacement Cylinders Only** for stock bore, stock stroke and compression. Must be honed to standard size for proper fit. Sold each without piston.

VT No.	OEM	Type
<b>1948-52 74"</b>		
11-1283	—	Front
11-1284	—	Rear
<b>1948-65 Panhead 74"</b>		
11-0502	16485-48	Front
11-0503	16494-48	Rear
<b>1966-78 Shovelhead 74"</b>		
11-0500	16484-66	Front
11-0501	16492-66	Rear
<b>1979-85 80"</b>		
11-0496	16498-80A	Front
11-0497	16499-80A	Rear
11-0481	GME	Front
11-0474	GME	Rear

**Note:** The use of Colony 12 point head bolts 8714-20 chrome or 8618-20 black and cylinder base nuts 8600-8 in chrome or 8601-8 in black will allow extra clearance for tightening when necessary on 1948-84 Big Twin cylinders.



**S&S Cast Iron Cylinders** for Shovelheads are stock length and include base nuts, head bolts, head and base gaskets.

VT No.	Size	Fits
11-0062	3 <sup>7</sup> / <sub>16</sub> "	1966-78 74"
11-0063	3 <sup>1</sup> / <sub>2</sub> "	1978-84 80"



**Metal Cylinder Base Gasket** has a steel base metal which has been coated on both sides with a specially formulated high temperature oil

resistant rubber compound. Silicone beading around the inner and outer perimeter forms a seal on both sides of gasket. Sold in pairs.



**Cylinder and Piston Kits** are honed and pre-fitted with 8.5:1 stock compression pistons and Hastings rings. They are ready to run and will require break-in as suggested in the appropriate shop manual. Sold in pairs for stock stroke only. Order gasket set separately.

VT No.	Years	Compression Ratio	Piston
<b>Panhead 74"</b>			
11-0885	1948-52	8.5:1	Cast
11-2602	1948-65	8.5:1	Cast
<b>Shovelhead 74"</b>			
11-2603	1966-78	8.5:1	Cast
<b>Shovelhead 80" 1979-85</b>			
11-2604	Replica	8:1	Cast
11-2612	GME	8:1	Cast
11-2613	GME/Wiseco	9.5:1	Forged
11-2614	GME/Wiseco	7:1	Forged

V-Twin	James	Fits
—	15-1087	Shovelhead
—	15-1123	Shovelhead 3 <sup>5</sup> / <sub>8</sub> " Big Bore .032" thick
15-1532	15-1122	Shovelhead 3 <sup>5</sup> / <sub>8</sub> " Big Bore .020" thick
—	15-1090	Panhead



**Big Twin Cylinder Base Studs** feature heat treating and interference thread at cylinder base. Sets of eight.

VT No.	OEM	Fits
8856-8	16831-30	1930-77
12-2100	16831-30	1930-77
8857-8	16837-78	1977-84
12-2101	16837-78	1977-84



# Knucklehead Cylinder Kit

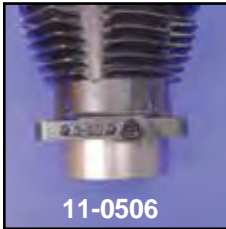

**Replica Knucklehead Cylinder Sets** feature iron cast construction, original markings with black painted finish and are pre-fitted with cast pistons and Hastings Rings.

VT No.	Year	Fits	Compression
11-0506	1936-47	61"	7.5:1
11-0507	1941-47	74"	8.5:1

Replica Details!

**Knucklehead Replacement Cylinder and Piston Kits** are honed and pre-fitted with stock compression cast pistons and Hastings Rings. They are ready to run and will require break-in as suggested in the appropriate shop manual. Sold in pairs for stock stroke only. Order gasket set separately.

VT No.	Year	Fits	Compression
11-2600	1936-47	61"	7.5:1
11-2601	1941-47	74"	8.5:1

**Knucklehead Replacement Cylinders Only** for stock bore, stock stroke and compression. Must be honed to standard size for proper fit. Sold each without piston.

VT No.	OEM	Type	Year	Fits
11-0495	16483-36	Front	1936-47	61"
11-0494	16490-36	Rear	1936-47	61"
11-0499	16483-41	Front	1941-47	74"
11-0498	16491-41	Rear	1941-47	74"



## 3 5/8" Shovel Cylinders

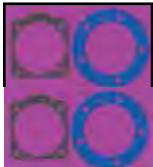

**Big Bore Gasket Kit** fits all 3 5/8" cylinders. Kit includes two Teflon gaskets and 2 base gaskets.

GB	James	Fits
15-0886	15-0599	Shovelhead
—	15-0877	Evolution



**Metal Cylinder Base Gasket** has a steel base metal which has been coated on both sides with a specially formulated high temperature oil resistant rubber compound. Silicone beading around the inner and outer perimeter forms a seal on both sides of gasket, pairs. (Shovelhead 3 5/8" Big Bore .020 Thick)

VT No. 15-1122



**3 5/8" Cylinders** sold as a kit with 7.5:1 pistons, rings, gaskets, head bolts and cylinder base nuts. Also available as cylinder set only.

### Stock Cylinder

VT No.	Item	Brand
11-0380**	Cylinder Set, Sifton	**Note: Honed to size
11-0297	Cylinder Kit	Sifton
11-0283	Piston	Kit
11-0252	Rings	Set

### .200 Longer Cylinder

VT No.	Item	Brand
11-0385**	Cylinder Set.	Sifton **Note: Honed to size
11-0289	Cylinder Kit	Sifton
11-0068*	Cylinder Set	S&S

\*Note: Order pistons separately.

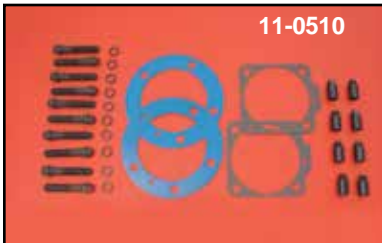

**Magnum Cylinder Small Parts Kit** for installing 3 5/8" barrels on Shovelhead cases. Includes two (2) head gaskets, one each front and rear cylinder base gasket, eight (8) cylinder base nuts, and ten (10) head bolts with washers.

VT No.	Item
11-0510	Complete kit
15-0599	Gasket set
8618-20	Black bolt set
8714-20	Chrome bolt set
8600-8	Chrome base nuts
8601-8	Black base nuts



**S&S 3 5/8" Sidewinder Cylinder Kit** fits 1966-84 Shovelheads. Includes front and rear cylinders stock 5.330 length for 4 1/4 stock stroke, cast pistons with 7.75:1 compression, gaskets, base nuts and headbolts.

VT No. 11-0061





# Replica Piston Kit

V-Twin Piston Kits include two cast alloy pistons, genuine Hastings three piece ring set, two wrist pins and four circlips. All Big Twin pistons have a steel expansion control strut cast as original.

61-74-80 Overhead Valve Piston Set use 22588-78 Pin Lock, VT No. 12-0929.							
COMP Dia.	STD 61" OHV 3 <sup>5</sup> / <sub>16</sub> " Bore	STD 8.5:1 74" 1200cc 3 <sup>7</sup> / <sub>16</sub> " Bore	LOW 7.5:1 74" 1200cc 3 <sup>7</sup> / <sub>16</sub> " Bore	HIGH 10:1 74" 1200cc 3 <sup>7</sup> / <sub>16</sub> " Bore	8.5:1 74" Stroker 3 <sup>7</sup> / <sub>16</sub> " Bore (S&S)	STD 8:1 80" 1340cc 3 <sup>1</sup> / <sub>2</sub> " Bore	LOW 7:1 80" 1340cc 3 <sup>1</sup> / <sub>2</sub> " Bore
STD	11-0426	11-0216	11-0307	11-0322	11-0455	11-0226	11-0317
.010	11-0847	11-0217	11-0308	11-0323	—	11-0227	11-0318
.020	11-0427	11-0218	—	11-0324	—	11-0228	11-0319
.030	11-0848	11-0219	11-0310	11-0325	11-0458	11-0229	11-0320
.040	11-0428	11-0220	11-0311	—	11-0459	11-0230	11-0321
.050	—	11-0221	11-0312	—	11-0460	Shovelhead	Shovelhead
.060	11-0429	11-0222	11-0313	—	11-0461	—	—
.070	—	11-0223	11-0314	—	—	—	—
.080	11-0439	—	—	—	—	—	—



## Stroker Piston

COMP Dia.	8.5:1 4 <sup>1</sup> / <sub>2</sub> " Stroker 3 <sup>7</sup> / <sub>16</sub> " Bore	8.25:1 4 <sup>5</sup> / <sub>8</sub> " Stroker 3 <sup>1</sup> / <sub>2</sub> " Bore	8.25:1 (S&S) 4 <sup>5</sup> / <sub>8</sub> " Stroker 3 <sup>7</sup> / <sub>16</sub> " Bore	7.5:1 (S&S) 4 <sup>1</sup> / <sub>2</sub> " Stroker 3 <sup>5</sup> / <sub>8</sub> " Big Bore	7.5:1 4 <sup>1</sup> / <sub>2</sub> " Stroker 3 <sup>5</sup> / <sub>8</sub> " Big Bore
STD	11-0288	11-0461	11-0455	11-0237	11-0283
.010	—	—	—	—	11-0238
.020	—	11-0463	—	—	—
.030	—	—	11-0458	—	—
.040	—	—	11-0459	—	—
.050	—	—	11-0460	—	—
.060	—	—	11-0461	—	—



Over 100,000 Kits Served since 1976!

## Ring Set

**HASTINGS**  
The Ring Leader.



Wrist Pin and Lock Kit replaces 22760-73.  
1948-85  
VT No. 11-0870



Wrist Pin Locks. 10 packs.  
VT No. Year  
12-0910 1932-53  
12-0911 1952-77  
12-0929 1978-82

Hastings Piston Ring Sets are replacements for OEM ring sets. 61" and 74" FLH type will fit V-Twin Pistons. 74" FL type to fit OEM Pistons only. Also fit any of our cast pistons. Include cast compression rings and a 3-piece oil ring. Except where noted. Sold in sets for two pistons.

Model Size Bore Comp Ring Oil Ring	61" OHV 3 <sup>5</sup> / <sub>16</sub> " 3 <sup>3</sup> / <sub>32</sub> " 3 <sup>1</sup> / <sub>16</sub> "	74" FL 3 <sup>7</sup> / <sub>16</sub> " 3 <sup>3</sup> / <sub>32</sub> " 3 <sup>1</sup> / <sub>16</sub> "	74" FLH 3 <sup>7</sup> / <sub>16</sub> " 1 <sup>1</sup> / <sub>16</sub> " 3 <sup>1</sup> / <sub>16</sub> "	Moly
Mfg.#	6627	5193*	6482	2M6482
STD	11-0170	11-0117*	11-0176	11-1368
.010	11-1404	11-0118*	11-0177	11-1369
.020	11-0171	11-0119*	11-0178	11-1370
.030	11-1405	11-0120*	11-0179	11-1371
.040	11-0172	11-0121*	11-0180	11-1372
.050	—	11-0122*	11-0181	11-1373
.060	11-0173	11-0123*	11-0182	11-1374
.070	—	—	11-0183	11-1375
.080	11-1681	—	11-0184	11-1376

\*Note: Features One Piece Oil Control Ring.

80" FL-FX Shovelhead 1340cc			
Mfg. #	6127 Cast	2M6127 Moly	
STD	11-0185	11-1363	
.010	11-0186	11-1364	
.020	11-0187	11-1365	
.030	11-0188	11-1366	
.040	11-0189	11-1367	

Hastings Patch.  
VT No. 48-1479

3 <sup>5</sup> / <sub>8</sub> " Big Bore Shovelhead 5 <sup>1</sup> / <sub>4</sub> " Compression Ring	
Mfg.#	2M5722 Moly
STD	11-0196
.010	11-0197
.020	11-0198
.030	11-0199
3 <sup>5</sup> / <sub>8</sub> " Big Bore Shovelhead 1 <sup>1</sup> / <sub>16</sub> " Compression Ring	
Mfg.#	2M5721 Moly
STD	11-0252
.010	11-0253
.020	11-0254
.030	11-0255

3 <sup>5</sup> / <sub>8</sub> " S&S Big Bore .058 Compression Ring	
Mfg.#	S&S 94-1210 Moly
.060	11-0262

One Piece V-Twin Cast Iron Ring Sets for 2 pistons with one piece oil ring.		
Dia.	1200cc FLH 3 <sup>7</sup> / <sub>16</sub> " Bore 74"	1340cc 3 <sup>1</sup> / <sub>2</sub> " Bore 80"
STD	—	11-2508
.010	11-2501	11-2509
.020	11-2502	11-2510
.030	11-2503	11-2511
.040	11-2504	11-2512
.050	11-2505	—
.060	11-2506	—
.070	11-2507	—

FLH Piston Ring Three Piece Set features compression rings with a size of 1<sup>1</sup>/<sub>16</sub>" and oil rings with the size of 3<sup>7</sup>/<sub>16</sub>".  
VT No. Size  
11-1207 74"  
11-0134 80"



Note: Piston Kits include Hastings X Ring.  
\*Note: Rings are packaged per piston.

1948-78 1200/74" FL-FLH 9:1 Compression 3/16" Bore.

	Piston Kit	Wiseco Rings*
Standard	11-9725	11-9753
.010	11-9726	11-9754
.020	11-9727	11-9755
.030	11-9728	11-9756
.040	11-9729	11-9757
.050	11-9730	11-9758
.060	11-9731	11-9759
.080	11-9732	11-9760

1978-84 1340/80" Shovelhead 7:1 Compression 3/2" Bore.

	Piston Kit	Wiseco Rings*
Standard	11-9733	11-9759
.020	11-9735	11-9760
.030	11-9736	11-9764
.040	11-9737	11-9765

1978-84 1340/80" Shovelhead 8.5:1 Compression 3/2" Bore.

	Piston Kit	Wiseco Rings*
STD	11-9444	11-9759
.010	—	11-9762
.020	11-9446	11-9760
.030	11-9447	11-9764
.040	—	11-9765

1978-84 1340/80" Shovelhead 9.5:1 Compression 3/2" Bore.

	Piston Kit	Wiseco Rings*
STD	11-9738	11-9759
.010	11-9739	11-9762
.020	11-9740	11-9760
.030	11-9741	11-9764
.040	11-9742	11-9765

 Wiseco Replacement Wrist Pins are sold each.  
VT No. Bore Size  
11-9776 3/16" and 3/16"  
11-9777 3/2"

 Wiseco Replacement Circlips fit all Wiseco pistons, available in pairs. Fits 3/16" and 3/2" bore pistons.  
VT No. 11-9773

S&S Button Style Keepers available in different thickness to control wristpin end play which varies with bore size. Button style keepers must be fully supported by wrist pin hole. Sold in pairs.  
3/16" and 3/2" Bore

VT No.	Range	Type
11-2168	STD to +.040	Teflon
11-2169	+.050 to +.090	Teflon



**SHOP TIP Piston Installation**

Caution: Do not install piston pin without lubricating it first with motor oil or assembly lube. Touch up outer edges of piston pins with emery cloth before installation.

- Refer to applicable service manual for proper installation methods.
- Piston should be measured front-to-rear at the base of piston skirt, perpendicular to wrist pin.
- Piston should be set-up with the following tolerances:

Recommended piston/cylinder running clearances:

	Minimum	Maximum	Preferred
Evolution® Models (Aluminum Cylinders)	.0015	.0022	.002
Big Twin Models (Cast Iron Cylinders)	.0015	.003	.0025
Sportster Models (Cast Iron Cylinders)	.003	.004	.0035

Specifications for ring end-gap are supplied with the ring sets and vary by type and size.  
Note: Run engine at moderate speeds for at least 500 miles, avoiding excessive running in lower gears, in order to properly break-in new pistons and rings.



## Piston Kit



MC Moly Coated Piston Kits feature cast construction with moly (moS<sub>2</sub>) coating which helps reduce friction and wear, while allowing adequate break in. Hastings Moly Rings Set, wrist pins and locks included. 8.5:1 comp ratio.

Size	3/16" 74"	3/2" 80"
	1948-84 FLH-FX	1978-84 FLH-FXE
Standard	11-0267	11-0273
.010	11-0268	11-0274
.020	11-0269	11-0275
.030	11-0270	11-0276
.040	11-0271	11-0277
.050	11-0272	—

## Forged Piston Kits KB PERFORMANCE PISTONS



The Keith Black 390 Hypereutectic alloy is cast in a permanent steel mold.

Engine	Panhead Shovelhead	1340cc Shovelhead	1340cc Shovelhead
Model	FLH-FX	FLH-FX	FLH-FX
Years	1941-79	1980-84	1980-84
C.I.D.	74"	80"	80"
Bore	3.438"	3.498"	3.498"
Stroke	3.969"	4.250"	4.250"
Head Type	.656 Dome	.426 Dome	
Cylinder Height	5.330"	5.330"	5.330"
Compression Ratio	9.0:1	7.2:1	8.3:1
Standard	11-2200	11-2234	11-2251
.005	11-2201	11-2235	11-2252
.010	11-2202	11-2236	11-2253
.020	11-2203	11-2237	11-2254
.030	11-2204	11-2238	11-2255
.040	11-2205	11-2239	11-2256
.050	11-2206	—	—
.060	11-2207	—	—
.070	11-2208	—	—
.080	11-2209	—	—





# Knucklehead Gasket

Replica Gasket OE Quality Since 1967

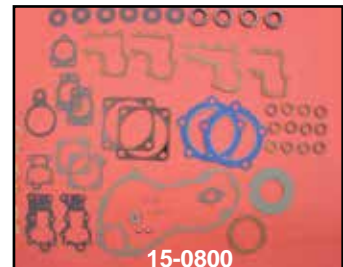
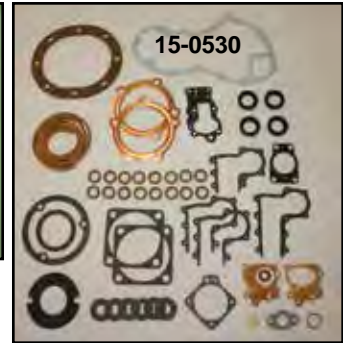
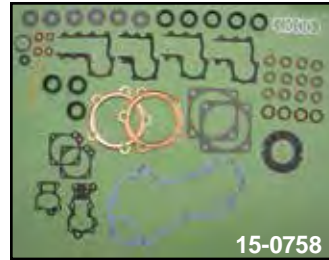
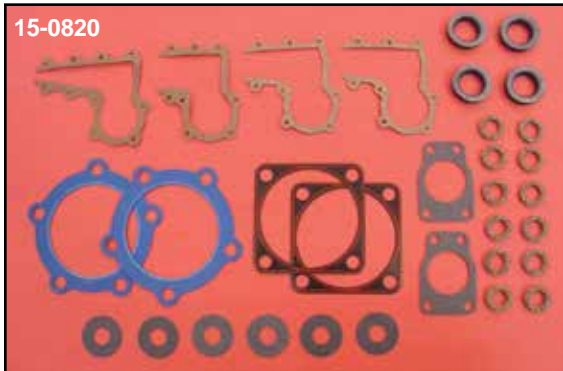
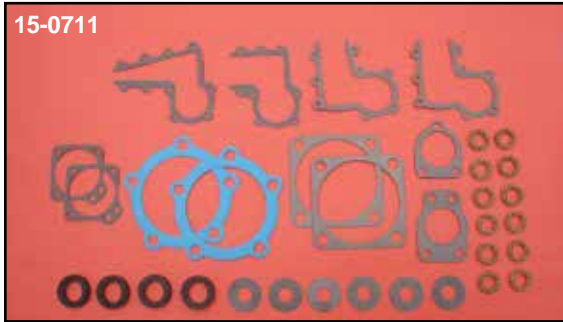
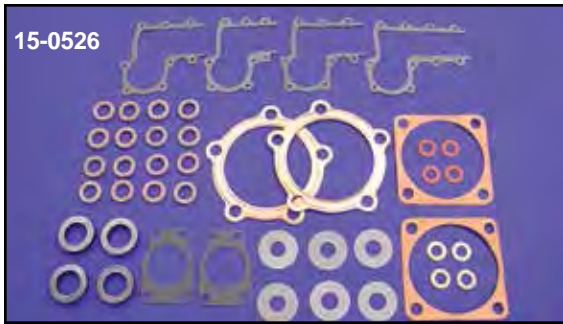

**Complete Gasket Kit for Knuckleheads.**

VT No.	Type	Year	Brand
15-0758	Replica	1937-40	GB
15-0530	Replica	1941-47	GB
15-0507	Standard	1941-47	GB
15-0800	Standard	1941-47	James



**Knucklehead Head Gaskets.** Made of copper. Fit 1936-47.

VT No. 15-0268



**Knucklehead Top End Gasket Set** features copper head gaskets and cylinder base gaskets with bead on metal.

VT No. 15-0924



**Base Gaskets.**

VT No.	Year	Model	Brand
15-0412	1930-36	VL	GB
	1936-48	UL	GB
	1936-47	Knucklehead	GB
15-1290	1936-47	All	With Bead

**Left Side Engine Case Seals.**

VT No.	#	OEM	Year	Model
7411-2	A	24776-40	1936-54	61 and 74-80
14-0965		24031-55	1955-68	Big Twin, OE type
7410-55	C	24031-55	1955-68	Big Twin
7410-1	C	24031-55	1955-68	Big Twin, Colony
7410-1-OSC		Oversize	1955-68	.002
7410-1-USC		Undersize	1955-68	.002
14-0177		Seal only	For above	
14-0185	B	24031-69	1969 only	Big Twin
14-0108	B	12026B	1970-99	74 and 80 Big Twin, 5 pack
10-8284		Kit	1970-99	74 and 80

**Note:** VT No. 7410-1 and 7410-55 are screw-in inserts with integral seals. VT No. 14-0965 is a stock type screw-in without seal.

VT No. 7411-2 and 8211-2 both include seal, spacer and snap ring.

**GB™ Top End Kits** include all gaskets and O-rings including pushrod corks from the cylinder base and up. Perfect for piston and valve jobs.

**Fits Big Twin Overhead Valve**

VT No.	OEM	Years	Model
15-0711	17034-38	1941-47	Knucklehead
15-0526	—	1941-47	Knucklehead, Replica
15-0820	17034-38	1941-47	Knucklehead, James

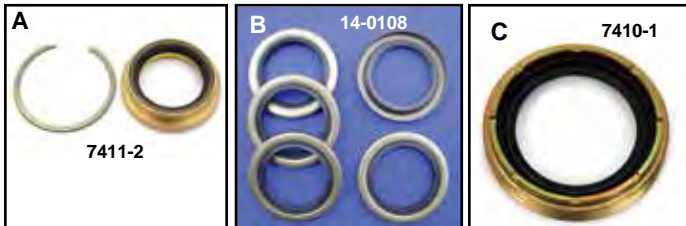



# Pan-Shovelhead Gasket Set



**GB™ Top End Kits** include all gaskets and O-rings including pushrod corks from the cylinder base and up. Perfect for piston and valve jobs.

**Fits Big Twin Overhead Valve Top End**

VT No.	OEM	Year	Model
15-0604	17034-48	1948-65	Panhead
15-0605	17034-66	1966-69	Shovelhead
15-0606	17034-78	1978-85	Shovelhead

**GB™ Complete Gasket Kits** include all of the gaskets, seals and O-rings necessary to rebuild each model listed. Models which require quad pushrod seals include quad type. Head gaskets are Teflon; all other components are stock replacement type.

VT No.	OEM	Year	Model
15-0508	17028-48	1948-65	Panhead
15-0509	17029-66	1966-69	Shovelhead
15-0510	17029-70	1970-77	Shovelhead
15-0511	17029-79	1979-84	Shovelhead 4-Speed
15-0512	17029-80	1980-85	Shovelhead 5-Speed

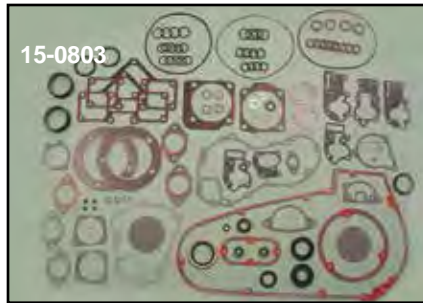

**James Gasket Sets** for Big Twin. Top quality gaskets are available as complete sets, engine sets or top end sets. Contain gaskets, oil seals and O-rings necessary for a complete rebuild.



**Complete Engine Gasket Sets Big Twin Overhead Valves.**

James	OEM	Years	Model
15-0801	17028-48	1948-65	Panhead (Teflon Head Gaskets thick and thick Pan cover gaskets)
15-0804	17029-66	1966-84	Shovelhead (Teflon Head Gaskets)
15-0803	17029-70A	1970-84	Shovelhead (Fire Ring Head Gaskets)

**\*Note:** VT No. 15-0804 includes primary gaskets and seals, VT No. 15-0801 does not include primary gaskets.

**James Top End Sets.**

VT No.	OEM	Years	Model
15-0821	17034-48	1948-65	Panhead (Teflon Head Gaskets)
15-1186	—	1948-65	Panhead (Fire Ring Head Gaskets)
15-1295	17034-48	1948-65	(.045" fire ring head gaskets & Foamet® cylinder base gaskets)
15-0823	17034-66	1966-84	Shovelhead (Teflon Head Gaskets/Quad Pushrod Seals)
15-1187	—	1966-84	Shovelhead (Fire Ring Head Gaskets)
15-1188	—	1978-84	Shovelhead 3 5/8" Big Bore (Teflon Head Gaskets/Steel Base Gaskets)

**Fire Ring Head Gasket Set** for 1966-84 Shovelheads includes head gaskets, exhaust port gasket and intake manifold seals only.

VT No.	Type
15-1216	Fire Ring
15-0887	Fire Ring with Bead

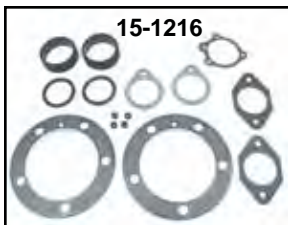

48-0498  
80" UL



48-0470  
Knucklehead



48-0030  
1340 cc



48-0033  
Dual Cam



48-0025  
Panhead



48-0044  
Shovelhead



48-0048  
Shovelhead



48-0372  
XLCH 1971



48-1824  
45"

**Motor Plaques** measure 18" x 24" and are made of metal.

**Motor Plaque Set** includes 9 plaques. **VT No. 48-1811**



# 4-Speed Transmission



17-0026



17-0025



17-0026



17-0026



17-0000

replica early kick arm



17-0004



17-0035

17-0035

with chrome kick cover and arm



17-2500



Motor Shop Assembles  
10 Transmissions Per  
Batch

Over 3000 in service since 1993

**4-Speed Transmissions** include Replica™ Cast Case, internal parts, kicker cover and components, clutch rod, throwout bearing, natural finish ratchet top with chrome dust cover, arm, mount studs, clutch hub nut, seal and key, fully assembled for Big Twins. All are 3.00 ratio FL style.

- Big Twin 1936-64 models feature original style case **VT No. 43-9149** with early style main drive gear, 44 rollers and 2:1 ratio speedometer drive gear for kick start only.
- **VT No. 17-0025 and 17-0035** for 1936-64 feature chrome kick cover and chrome offset kicker arm.
- **VT No. 17-0026 and 17-0000** feature original style aluminum kick cover and early one piece black kick arm for kick start only.
- **VT No. 17-0004** fits electric start primary cover

VT No.	Year	Type
17-0025	1936-64	Ratchet
17-0026	1936-64	Ratchet
17-0004	1965-69	Ratchet
17-0035	1936-64	Jockey
17-0000	1936-64	Jockey
17-2500	1936-40	Jockey

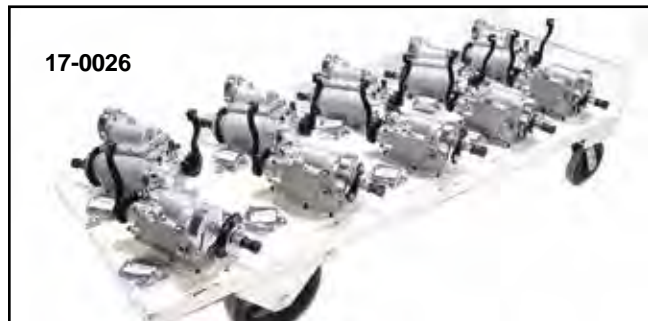

17-0026

# 4-Speed Replica Transmission

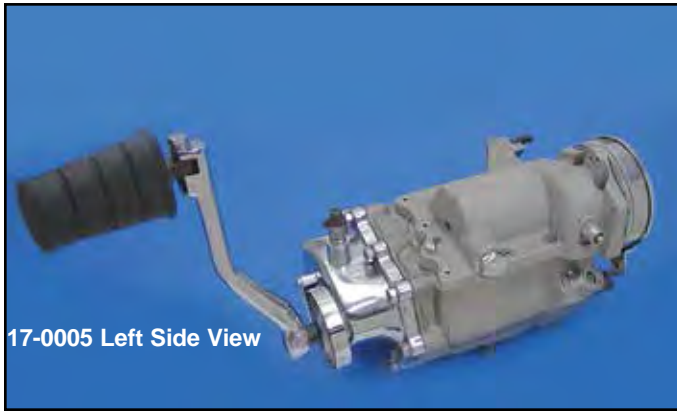

**4-Speed Transmissions** include Replica™ cast case internal parts, chrome kicker cover and components, clutch rod, throw-out bearing, natural finish ratchet top with chrome dust cover, arm, mount studs, clutch hub nut, seal and key, fully assembled for Big Twins.

- 1970-84 models feature case with mount lugs to accept aluminum inner primary covers. Speedometer drive gear supplied is 1:1 ratio. Torrington needle bearings used throughout. VT No.'s 17-0012, 17-0013 will accept belt or chain final rear drive which accepts electric start.

**Note:** The shift pattern will be reversed when installed in mid-shift models as it has the FL type ratchet top to be used with forward controls.

VT No.	Ratio	Year
17-0005	3.00	1970-84 FLH
17-0006	2.44	1970-84 FX
17-0012*	3.00	1970-84 FL with Rotary Top
17-0013*	2.44	1970-84 FX with Rotary Top

\*Note: Available with 1979-85 type with Rotary Top.

# 5 Speed Conversion



**S&S 5-Speed Transmission Case** is designed for 4-Speed Big Twin frames and includes shift lever adjustment screw, shifter shaft guide, all studs and dowel pins required for assembly. Requires shorter countershaft and countershaft needle bearing for assembly.

VT No.	Item
43-1051	Case Assembly
17-0548	Shorter Countershaft
12-0394	Countershaft Needle Bearing
43-4605	FX Starter/Battery Box Bracket
43-4606	FL Starter/Battery Box Bracket
21-4750	FX Shifter Linkage Kit
21-4756	FL Shifter Linkage Kit



**5-Speed Transmission** as pictured, direct bolt in replacement on 1970-84, for the 4-speed unit. Completely assembled using replica gears, shafts and transmission case. All internal parts interchange with stock 5-speed components. Available with late clutch release mechanism. Use 1980-84 FXR 5-speed transmission sprocket with offset so teeth are closer to transmission case. Inner primary must be clearanced for final fitting. Available with late clutch release mechanism for 1987-up type cable.

**VT No. 17-0015**





# Transmission Case



43-9105



43-0783

## Replica 4-Speed Transmission Cases.

VT No. OEM # Years

### Ratchet Type

43-9156 34701-65A 1965-Early 78

43-9105 34702-78 1 Late 1977-Early 79

### Rotary Type

43-0783 34702-80 2 1979-84

1. Uses the Torrington style 4th gear bearing VT. 12-0300 and accepts reverse gear idler shaft.

2. Can also be used on 1981-84 models belt or chain drive with Torrington style 4th gear bearing VT No. 12-0300 and 17-0101 bearing retainer and 17-9883 housing for kick starter side.



**4 Speed Transmission Case and Ratchet Top Set** fits 1965-Early 1979 Big Twin. Both parts are in a natural alloy finish. Case accepts Torrington 4th gear bearing VT No. 12-0300. FLH style ratchet top gives 1 down, 3 up shift pattern and is assembled with all internal parts, including chrome dust cover and arm. **VT No. 43-0550**

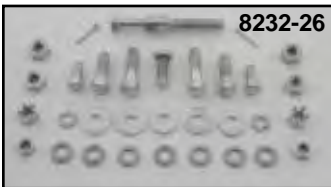

8232-26



9418-19



9419-19

**Big Twin Transmission Mount Kit** include bolts and washers necessary for installation.

VT No.	Year	Finish
8231-26	1936-64	Chrome
8232-26	1936-64	Cadmium
9695-26	1936-64	Parkerized
2314-36	1936-47	Parkerized
7602-11	1936-64	Acorn
37-9158	Biter Washer for Above	
9418-19	1965-76	Chrome
9419-19	1965-76	Zinc
9420-21	1977-86	Chrome
9421-21	1977-86	Zinc



## 1936-64 Big Twin Transmission Case

replaces 34700-36. Includes main drive case race and countershaft bushings installed. Order studs separately. Case will accept reverse gear idler shaft.

VT No. Item

43-9149 Case

12-2108 Kick Cover Studs

12-2104 Mount Studs



**1936-64 Big Twin 4-Speed Transmission Case and Ratchet Top Set** features a natural alloy finish. Case includes main drive race and countershaft bushings installed. Ratchet top with FLH style pattern is assembled with all internal parts including chrome dust cover and arm. Screws included.

VT No. 43-0551



**Hardware Kit** fits 1979-84 Big Twin 4-Speed case.

VT No. 17-0849

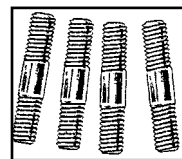

12-2104

**Transmission Mount Case Studs** are heat treated as original for 4-Speed. Available in set of 4.

VT No.	OEM	Type	Year	Brand
12-2104	34723-47	Stock	1948-83	Replica
9654-4	34723-47	Stock	As Above	Colony
12-2105	34724-36	Oversize	1936-83	Replica
9655-4	34724-36	Oversize	As Above	Colony
12-2124	34722-36	Stock	1936-47	Replica
9919-3*	34725-26	Aligning	1936-83	Replica

\*Note: Use for rigidity when 4-speed belt drive is used



48-1331



48-1364

V-Twin Specialized Catalogs are available for dealers to supply to customers.

VT No. Item

48-1331 Knucklehead (Version 2)

48-1364 Panhead



# Trans Mount Plate



**Replica Big Twin Transmission Plate Kit** includes adjuster strap and all hardware necessary for installation.

VT No.	Finish	Year
17-0244	Chrome	1936-57
17-0245	Parkerized	1936-57
17-0246	Chrome	1958-64
17-0247	Black	1958-64

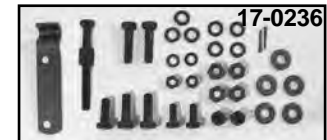
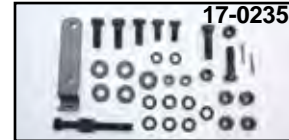

**Adjusting Strap Kit** for 1936-64 Big Twin includes strap, adjusting screw and mount bolts.

VT No.	Finish
17-0235	Parkerized
17-0236	Chrome



**Replica Parkerized Adjuster Kit** includes adjuster screw with machined head and correct straps. Fits 1941-64 FL.

**VT No. 17-0891**

## Steel Transmission Mount Plates.

VT No.	OEM	Fits	Finish
17-6660	47698-36	1936-57	Chrome
17-6654	47698-36	1936-57	Black
17-6650	47698-36	1936-84 74 and 80 Big Twin	Chrome
	47698-65	Rigid/Swing arm 4-Speed	
17-6657		As Above	Black
17-6653	47698-58A	As Above	Parkerized
17-6651	Custom	Fits Rigid mount 5-Speed Transmission in 4-Speed, Paughco Frame	Zinc
17-6658	Custom	Fits 4-Speed Transmission in 5-Speed, Paughco Frame	Chrome



**Adjustable Transmission Plate.** The built in dual adjusters operate from the end of the 1/2" thick steel place by counter bored socket head screws which allow accurate alignment of the mainshaft and are ideal for open belt drives models. The three holes at the front fit various frames. Fits 4 speed Big Twin transmissions from 1979-86 with flat bottom cases and 1936 to early 1978 cases if the sliders are milled off the bottom of the case.

VT No.	Finish
17-7660	Chrome
17-7661	Black



**Billet Offset Transmission Plates** for 4-Speed, 1/4" offset.

**VT No. 17-0790**



**Rigid Frame Transmission Plate Spacer** will raise transmission position on 1936-57 frames.

**VT No. 31-0491**



**(A) Transmission Adjuster Kit** includes three pieces as shown allowing the late model transmission case to be secured and adjusted. Strap and adjuster bolt available separately. For use on 1936-64 model Big Twin.

VT No.	OEM	Item	Finish
17-0110	Kit	Adjusting Set, 3 piece	Chrome
17-0108	47720-36	Strap	Chrome
17-0109	47720-36	Strap	Black Phosphorized
17-0107	34735-36	Adjuster	Chrome
9735-1	34735-36	Adjuster	Chrome
9737-1	As Above		Parkerized
9736-1	As Above		Cadmium

**(B) Even Pull Kit** allows a more positive even transmission adjustment. For use on late style transmission assembly in a rigid frame.

**VT No. 17-6655**

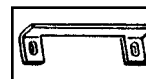

**Transmission Bolt Lock Tab** replaces 34747-65. Will lock the front 2 bolts securing the transmission plate to frame on 1965-84 Big Twin.

**VT No. 17-0943**





# 4-Speed Big Twin Transmission

Refer to opposite page for photo regarding this listing.

Gear	#of Teeth	Ratio	Model	Year	VT No.	Motor Shop	Jims	Andrews	OEM	Note	#
<b>Mainshaft Gears</b>											
1st and 2nd	15 x 20	Stock	UL/FL	1938-58	<b>17-0539</b>	—	—	<b>17-1093</b>	35282-36	1	A
1st and 2nd	15 x 20	Stock	FL/FLH	1959-84	<b>17-0197</b>	—	—	<b>17-1091</b>	35282-59		A
1st and 2nd	17 x 20	Stock	FX/FXE	1974-79	<b>17-0198</b>	—	—	—	35282-74		A
1st and 2nd	17 x 25	Stock	FX/FXE	1980-85	<b>17-0542</b>	—	—	—	35282-79		A
3rd	24	Stock	UL/FL	1938-58	<b>17-9829</b>	—	—	<b>17-1048</b>	35306-36	2	B
3rd	24	Stock	FL/FX	1959-85	<b>17-0188</b>	—	—	—	35306-59		B
3rd	24	Stock	FL/FX	1959-85	—	<b>17-0545</b>	—	<b>17-8230</b>	35306-59	3	C
3rd	23	1.35:1	FL/FX	1937-85	<b>17-9901</b>	—	—	<b>17-9755</b>	—	4	B
4th	26	Stock	FL/FX	1941-76	<b>17-0194</b>	—	—	<b>17-8231</b>	35065-65B		D
4th	26	Stock	FL/FX	1977-85	<b>17-0195</b>	—	—	<b>17-8232</b>	35067-77	5	D
3-4 Shift Clutch			FL/FX	1941-85	<b>17-0113</b>	<b>17-0114</b>	—	<b>17-8234</b>	35440-38		E
3-4 Shift Fork			FL/FX	1941-85	<b>17-0115</b>	<b>17-0122</b>	—	<b>17-9750</b>	34158-36	6	F
<b>Countershaft Gears</b>											
1st	26	Stock	UL/FL	1936-85	<b>17-0199</b>	—	—	<b>17-1092</b>	35765-36		G
1st	24	Stock	FX/FXE	1974-85	<b>17-0196</b>	—	—	—	35717-74		G
2nd	21	Stock	FL/FX	1936-85	<b>17-0782</b>	<b>17-0896</b>	—	<b>17-8229</b>	35751-36		H
2nd	24	Stock	FXWG	1980-85	<b>17-9753</b>	—	—	—	35751-79		H
3rd and 4th	15 x 17	Stock	FL/FX	1941-75	<b>17-0200</b>	—	—	<b>17-8236</b>	35713-36		I
3rd and 4th	15 x 17	Stock	FL/FX	1976-84	<b>17-0201</b>	—	—	<b>17-8237</b>	35716-76		I
1-2 Shift Clutch			FL/FX	1941-85	<b>17-0112</b>	<b>17-0114</b>	—	<b>17-8233</b>	35665-36		J
1-2 Shift Fork			FL/FX	1941-85	<b>17-0116</b>	<b>17-0122</b>	—	<b>17-9750</b>	34159-36	6	K
Speedometer Drive			FL/FLH	1937-E61	<b>17-9160</b>	—	—	—	35635-36		L
Speedometer Drive			FL/FLH	L1961-68	<b>17-9161</b>	—	—	—	35635-62		L
Speedometer Drive			FL/FLH	1969-80	<b>17-0094</b>	—	—	—	35635-69	7	L
<b>Counter/Mainshafts</b>											
Mainshaft			FL/FLH	1937-64	<b>17-0139</b>	<b>17-0223</b>	—	<b>17-8500</b>	35039-50		M
Mainshaft			FL/FLH	1965-69	<b>17-0140</b>	<b>17-0224</b>	—	<b>17-8501</b>	35040-65		M
Mainshaft			FL/FX	1970-84	<b>17-0141</b>	<b>17-0142</b>	—	<b>17-8502</b>	35039-70		M
Mainshaft			FL/FX	L80-E84	<b>17-0144</b>	—	—	—	35039-80		M
Mainshaft			FL/FX	1985-86	—	—	—	<b>17-8503</b>	35039-85	8	M
Countershaft			FL/FX	1936-75	<b>17-0128</b>	<b>17-0325</b>	<b>17-0125</b>	<b>17-7650</b>	35614-65		N
Countershaft			FL/FX	1976-79	<b>17-0129</b>	<b>17-0326</b>	<b>17-0131</b>	<b>17-7651</b>	35614-76		N
Countershaft			FL/FX	1980-85	<b>17-0130</b>	<b>17-0327</b>	<b>17-0138</b>	<b>17-0137</b>	35614-80		N

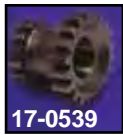

## Gear Sets

1st	17 x 20	2.44:1	FL/FX	1937-85	<b>17-0190</b>	—	—	<b>17-8225</b>	—	9	A,G
1st	16 x 20	2.60:1	FL/FX		<b>17-0191</b>	—	—	<b>17-8226</b>	—		A,G
1st	15 x 20	3.00:1	FL/FX	1938-58	<b>17-0202</b>	—	—	—	—		A,B
1st	15 x 20	3.00:1	FL/FX	1938-58	—	—	—	<b>17-1052</b>	—	1, 10	A,G
1st	15 x 20	3.00:1	FL/FX	1959-85	—	—	—	<b>17-1049</b>	—	10	A,G
1st and 2nd (2.24 1st and 1.65 2nd)			FL/FX	1937-85	<b>17-0060</b>	—	—	<b>17-6656</b>	—		A,G
3rd		1.35:1	FL/FX	1937-75	—	—	—	<b>17-8227</b>	—		B, I
3rd		1.35:1	FL/FX	1976-85	<b>17-9158</b>	—	—	<b>17-8228</b>	—		B, I

## Complete Gear Sets include A, B, C, D, E, F, G, H, I, J

2.44 1st, 1.35 3rd			FL/FX	1936-76	—	—	—	<b>17-6000</b>	—	11	
2.44 1st, 1.35 3rd			FL/FX	1977-84	—	—	—	<b>17-6004</b>	—	11	
2.44 1st, 1.23 3rd			FL/FX	1936-76	—	—	—	<b>17-6001</b>	—	9, 11	
2.44 1st, 1.23 3rd			FL/FX	1977-84	—	—	—	<b>17-6005</b>	—	9, 11	
2.60 1st, 1.35 3rd			FL/FX	1936-76	—	—	—	<b>17-6002</b>	—	11	
2.60 1st, 1.35 3rd			FL/FX	1977-84	<b>17-6027</b>	—	—	<b>17-6006</b>	—	11	
2.60 1st, 1.23 3rd			FL/FX	1936-76	—	—	—	<b>17-6003</b>	—	11	
2.60 1st, 1.23 3rd			FL/FX	1977-84	<b>17-6028</b>	—	—	<b>17-6007</b>	—	11	

## Notes:

- 1-2 Cluster has no rear counterbore and requires short length 1936-58 early third gear.
- V-Twin gear has bronze bushing. Andrews gear is machined to size no bushing is used.
- Motor Shop and Andrews Gear features ball milled lead in ramps. Can be used in early transmission, requires late type 1959-85 1-2 Cluster.
- Replacement for 1.35:1 3rd Gear Set only.
- Andrews Gear is updated type with O-Ring groove.
- Sifton and Andrews Shift Forks sold in sets only included 1 each, lead main and counter.
- Use VT No. 36-0810 Speedometer Drive for 17-9160 use 36-0812 drive for 17-0094.
- For Rear Belt Drive Models
- Stock FX ratio
- Stock FL ratio.
- Does not include Mainshaft and Countershaft

## Reverse and 3-Speed Big Twin Transmission Parts

VT No.	OEM	Description
<b>17-9876</b>	33231-64	Idler Spacer Washer
<b>17-9877</b>	33626-72	H. Shift Mirror Mount
<b>43-9106</b>	34800-65	3-Speed Lid Assembly
<b>17-9888</b>	35073-70	Low Gear Mainshaft
<b>17-9890</b>	35762-39	Countershaft Low, 3-Speed and Reverse
<b>17-9892</b>	36140-36	Idler Gear
<b>17-9893</b>	36150-31	Bushing Idler Gear
<b>17-9894</b>	36158-36	Idler Shaft
<b>17-1190</b>	35775-39	Countershaft
<b>12-1520</b>	35703-39	Cluster Gear
<b>17-9815</b>	35775-39	Countershaft Gear

# 4-Speed Big Twin Transmission



Refer to opposite page for the parts listing.

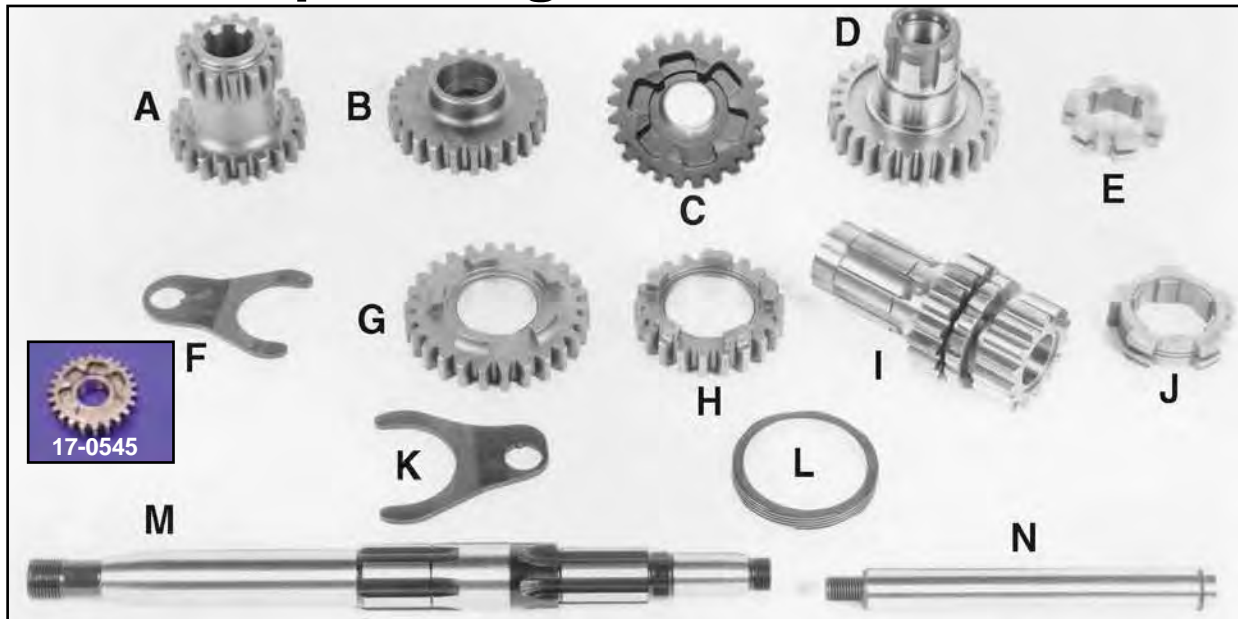

1936-69 Big Twin Mainshafts are made to factory prints for 4 speed models.

VT No.	Length	Sifon	Andrews	OEM	Years
17-0139	11 <sup>3</sup> / <sub>4</sub> "	17-0223	17-8500	35039-50	1936-64
17-0140	12"	17-0224	17-8501	35039-65	1965-69
17-0141	12 <sup>1</sup> / <sub>2</sub> "	17-0142	17-8502	35039-70B	1970-79
	12 <sup>7</sup> / <sub>16</sub> "	17-0144		35039-80	L1980-E1984



**Big Twin Countershaft/Mainshaft Rollers** set of 88 used.

88 Pack	100 Pack	OEM	Size
17-0145	12-4576	9084	Standard
17-0146	12-4577	9085	.0004
	12-4608		.0006
		12-4578	9086 .0008
17-0147	12-4579		.0008
17-0148			.0010



**Needle Bearings for Big Twin** feature full complement roller design.

VT No.	Torrington	OEM	Type/Use
12-0397	12-0316	9058	1958-99, Cam
—	12-0326	35690-54	Closed, Transmission
12-0396	12-0327	35961-52	Open, Transmission
12-0398	12-0300	8905	MD Gear, 1977-81
12-0399	12-0349	8906	MD Gear, 1982-85
12-0854	—	8906	MD Gear, 1982-85

**Note** the bearing surface outside diameter for main drive gear bearings do not interchange.

Outside Diameter	Year	Type
1.6290	1941-76	Loose Rollers
1.6235	1977-85	Full Complement



**Oil Deflector Main Drive Gear Kit.** Includes all parts pictured to fit 1936-64 3 and 4-Speed models. Replaces 35211-36 lock nut. **VT No. 17-0204**

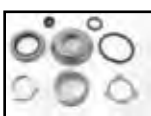

**Main Drive Gear Seal Kit** for 1941-76 Big Twin. **VT No. 17-0693**

**Replacement Big Twin Transmission Bushings** for 1941-85 3 and 4-Speed.

VT No.	OEM	Application
10-0729	35789-36	Countershaft Low 1936-85
10-0734	35789-36	As Above, Jims
10-0730	35791-36	Countershaft Second
10-0735	35791-36	As Above, Jims
10-0727	35094-65	Main Drive Gear 1941-85
10-2548	35094-65	As Above Motor Shop
10-2487		As Above Andrews Gear
10-0728	35322-38	Mainshaft Second and Third Handshift Models Only
10-0738	35322-38	As Above, Jims

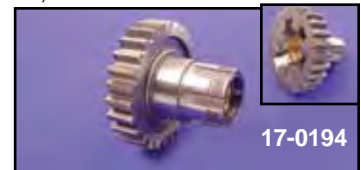

**Main Drive Gear.** V-Twin and Sifon brands include bushing and seal installed. Andrews brand includes installed bushing only. Order seal separately for Andrews brand.

VT No.	OEM	Year	Brand
17-0194	35065-65B	1941-76	V-Twin
17-8231	35065-65B	1941-76	Andrews
17-0598	35065-65B	1941-76	Sifon
17-0195	35067-77	1977-85	V-Twin
17-8232	35067-77	1977-85	Andrews with O-Ring Groove
	35067-84		Sifon
17-0352	As Above	1977-85	Sifon
17-0599	35067-77	1977-85	Replica
10-0727	35094-65	Bushing	OE
10-2548	35094-65	Bushing	V-Twin
10-2487*	35094-65	Bushing	Andrews
14-0106	12013A	All	Gear Seal, 5 pack

\***Note:** Bushing to fit Andrews 4th gear only.

**Note** the bearing surface outside diameter for main drive gear bearings do not interchange.





# 4-Speed Mainshaft Group

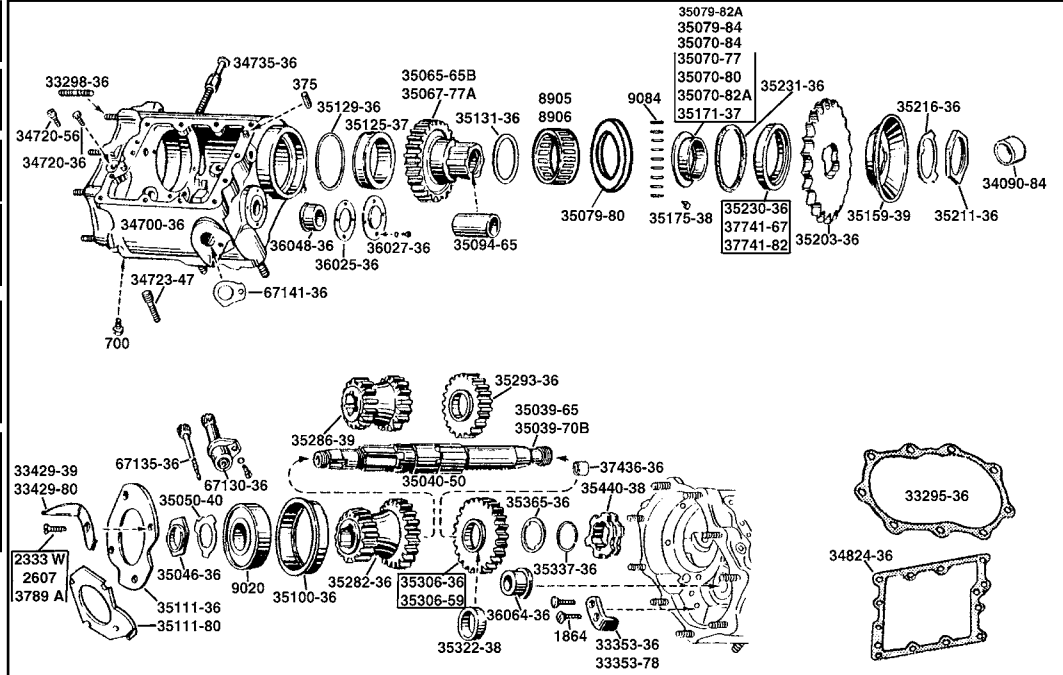

## Mainshaft Group 1936-85 64"-74"-80" 3-4 Speed.

VT No.	OEM	Item	17-9761	35100-36	1936-79 Bearing Housing, Right
12-1172	375	Dowel Pin	17-9883	35100-79	1980-84 Bearing Housing, Right
8114-1	700	Chrome Drain Plug	17-0104	35111-36	1936-79 Retaining Plate
8495-1	700	Cadmium Drain Plug	17-0101	35111-80	1980-85 Retaining Plate
12-0300	8905	1977-81 Needle Bearing	17-0150	35125-37	1937-78 Standard Race
12-0349	8906	1982-85 Needle Bearing	17-0690	Replica	1937-78 Standard Race
12-0307	9020	Ball Bearing	17-0220	As Above	Jims
12-9937	9020	Ball Bearing, Fafner	17-0230	—	1937-78 .002 Race, Jims
17-0145	9084	Standard Roller, 88 pieces	17-0151	—	1937-78 .005 Race
17-0146	9085	.0004 Roller, 88 pieces	17-0221	As Above	Jims
17-0147	9086	.0008 Roller, 88 pieces	17-0152	—	1937-78 .010 Race
17-0148	—	.001 Roller, 88 pieces	17-0222	As Above	Jims
17-0411	1864B	Bumper Plate Screw	12-0918	35129-36	Retaining Ring
37-9174	2333W	1936-79 Plate Screw	17-0162	35131-36	1936-77 Standard .060 Washer
37-0557	2607	1980 Plate Screw	17-0414	—	1936-77 .065 Washer
37-9173	3789A	1980-84 Plate Screw	17-0164	—	1936-77 .070 Washer
12-2109	24823-80	1965-85 Cover Stud Set	17-0165	—	1936-77 .080 Washer
15-0158	33295-36	Cover Gasket	17-0205	35159-39	1936-64 Oil Deflector
12-2108	33298-36	1936-64 Cover Stud Set	17-0185	35171-37	1937-76 Main Drive Spacer
17-0407	33353-36	1941-77 Bumper Plate	17-0392	35171-37	1937-40 Main Drive Spacer
17-0408	33353-78	1978-79 Bumper Plate	12-0207	35175-38	1941-77 Spacer Key
17-0409	33429-39	1939-79 Oil Deflector	8408-1	35211-36	Sprocket Lock Nut
17-0410	33429-80	1980-84 Oil Deflector	17-0901	35216-36	Lock Tab
17-0609	34090-84	1984-85 Inner Race	14-0122	35230-39	1941-78 Oil Seal
43-9149	34700-36	1936-64 Big Twin Transmission Case	7805-2	As above	3 piece kit
9620-13	34720-36	1936-55 Top Plug	7805-2T	As above	3 piece kit
37-8890	34720-56	Gear Box Vent	14-0123	35231-36	1941-78 Cork
12-2104	34723-47	Stud, Set of 4	17-0197	35282-59	1959-85 Low and 2nd
12-2105	34724-36	Stud Oversize Set of 4	17-0198	35282-74	1974-79 FX Low and 2nd
17-0107	34735-36	Chrome Adjusting Screw	17-9829	35306-36	1936-58 3rd Gear
15-0161	34824-36	1936-78 Cover Gasket	17-0188	35306-59	1959-84 3rd Gear
15-0162	34824-79	1979-84 Cover Gasket	17-0545	35306-59	1959-84 3rd Gear
17-0139	35039-50	1936-64 Mainshaft 1 1/4"	10-0728	35322-38	1941-58 3rd 2nd Gear Bushing
17-0140	35039-65	1965-69 Mainshaft 1 2"	12-0919	35337-36	3rd Retaining Ring
17-0141	35039-70	1970-83 Mainshaft 1 1/2"	17-0158	35365-36	Mainshaft 3rd Washer Standard .063
12-1103	35046-36	Bearing Nut (Replica)	17-9601	—	Mainshaft 3rd Washer -.005
17-0900	35050-40	Lockwasher	17-9602	—	Mainshaft 3rd Washer -.010
17-0194	35065-65B	1941-76 Main Drive Gear	17-9603	—	Mainshaft 3rd Washer -.015
17-0195	35067-77	1977-85 Main Drive Gear	17-9604	—	Mainshaft 3rd Washer +.005
17-0186	35070-77	1977-79 Main Drive Spacer	17-9605	—	Mainshaft 3rd Washer +.010
17-0187	35070-80	1980-81 Main Drive Spacer	17-9606	—	Mainshaft 3rd Washer +.015
17-0063	35070-82A	1982-85 Main Drive Spacer	17-9607	—	Mainshaft 3rd Washer +.020
17-9242	35079-80	1980-81 Drive Spacer Washer	17-0113	35440-38	Small Shift Clutch
17-0062	35070-84	1984-86 Main Drive FXWG Spacer, .391" thick	17-9830	37436-36	Mainshaft End Bushing
17-0064	35079-82A	1982 only Main Drive Spacer	14-0129	37741-67	1980-81 Oil Seal
17-0066	35079-84	1984 FXST Main Drive Spacer	14-0130	37741-82	1982-85 Oil Seal
10-0727	35094-65	1941-84 Main Drive Bushing	17-0108	47720-36	Chrome Strap
			17-0109	47720-36	Black Strap



# 4-Speed Countershaft

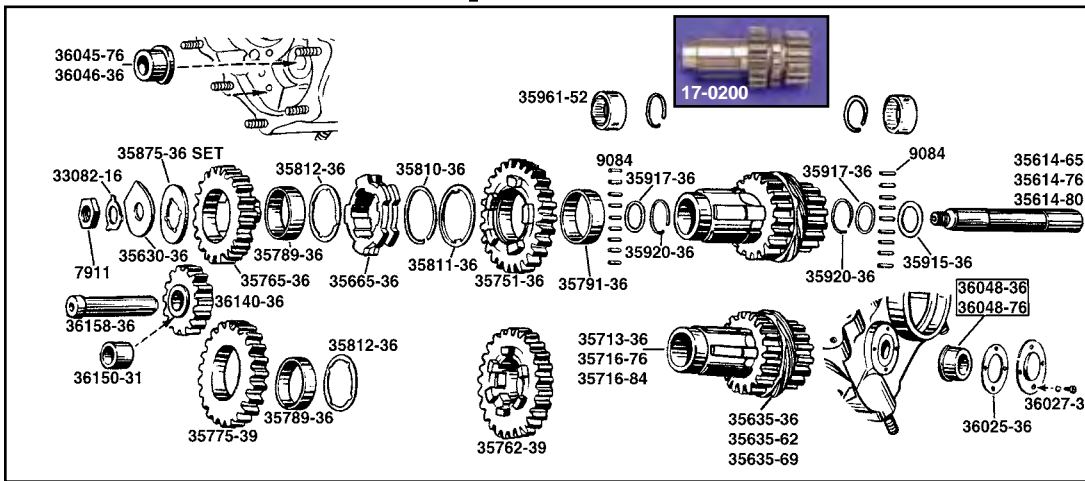

## Countershaft Group for 1936-85 Big Twin 3 and 4 Speed.

VT No.	OEM	Item
14-0507	1115	O-Ring
12-0527	7911	Nut, 5 pack
17-0902	33082-16	Lockwasher, 10 pack
17-0128	35614-65	Countershaft, 1936-75
17-0129	35614-76	Countershaft, 1976-79
17-0130	35614-80	Countershaft, 1980-85
17-0145	9084	Needle, Standard 88 piece
17-0146	9085	.0004 Oversize
12-4608	—	.0006 Oversize
17-0147	9086	.0008 Oversize
17-0148	—	.001 Oversize
17-0126	35630-36	Lock Plate, 5 pack
17-0112	35665-36	Shifter Clutch Large
17-0200	35713-36	1936-76 Countershaft Gear, 15-17 Teeth
17-0201	35699-76	1976-85 Countershaft Gear, 15-17 Teeth
N/A	35751-36	2nd Gear (21T) 1936-78
17-0782	35751-36	2nd Gear (21T) Sifton
17-0896	35751-36	2nd Gear (21T) Replica
17-9753	35751-79	2nd Gear (24T) 1980-83
17-9890	35762-39	Low, 3-Speed and Reverse
17-0199	35765-36	Low Gear 26T 1936-85
17-0196	35717-74	Low Gear 24T 1974-85 FX
10-0729	35789-36	Low and Reverse Bushing
10-0730	35791-36	Low or 2nd Bushing
12-0925	35810-36	Lock Retaining Ring, 10 pack
17-0167	35811-36	Retaining Washer, 5 pack
17-0161	35812-36	Bearing Washer, 5 pack
17-0123	35875-36	Washer Set 7 pieces includes .074, .078, .082, .085, .090, .095, .100
17-0179	—	.050 Countershaft Washer, 5 pack
17-0180	—	.055 Countershaft Washer, 5 pack
17-0181	—	.060 Countershaft Washer, 5 pack
17-0182	—	.065 Countershaft Washer, 5 pack
17-0183	—	.070 Countershaft Washer, 5 pack
17-0211	35876-36	.074 Countershaft Washer, 5 pack
17-0212	35877-36	.078 Countershaft Washer, 5 pack
17-0213	35878-36	.082 Countershaft Washer, 5 pack
17-0214	35879-36	.085 Countershaft Washer, 5 pack
17-0215	35882-36	.090 Countershaft Washer, 5 pack
17-0216	35883-36	.095 Countershaft Washer, 5 pack
17-0217	35884-36	.100 Countershaft Washer, 5 pack

17-0225	—	.0105 Countershaft Washer, 5 pack
17-0226	—	.110 Countershaft Washer, 5 pack
17-0170	35915-36	Gear Roller Washer Left .060
17-0206	—	As Above, .050
17-0207	—	As Above, .055
17-0209	—	As Above, .065
17-0210	—	As Above, .070
17-0169	35917-36	Washer
12-0924	35920-36	Lock Ring, 10 pack
12-0327	35961-52	Needle Bearing 1977-84
15-0171	36025-36	Cap Gasket, 10 pack
17-0127	36027-36	End Cap, Chrome
17-0171	36046-36	Standard Right Bushing 1937-76
17-0172	As above	.005 Oversize 1937-76
17-0173	36048-36	Standard Left Bushing 1937-76
17-0174	As Above	.005 Oversize 1937-76
17-0175	36045-76	Standard, Right Bushing 1976-79
17-0176	As Above	.005 Oversize 1976-79
17-0177	36048-76A	Standard, (R or L) Side Bushing 1976-84
17-0178	As Above	.005 (Right or Left) Bushing 1976-84
17-9892	36140-36	Idler Gear Reverse
17-9893	36150-31	Idler Gear Bushing
17-9894	36158-36	Idler Gear Shaft

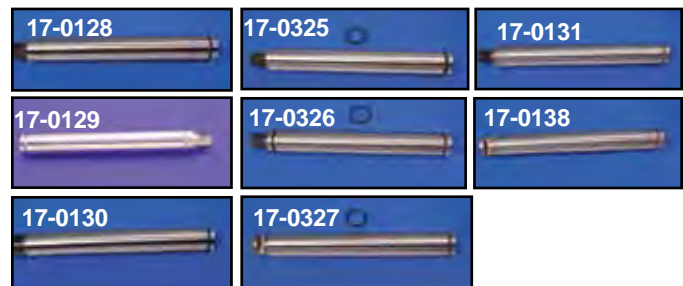

## 4-Speed Countershafts.

VT No.	Sifton	Jims	Andrews	OEM	Years
17-0128	17-0325	17-0125	17-7650	35614-65	1936-75
17-0129	17-0326	17-0131	17-7651	35614-76	1976-79
17-0130	17-0327	17-0138	17-0137	35614-80	1980-85



**Transmission Countershaft End Cap Kit** is for clutch side with gasket and screws, Replaces 36027-36.  
VT No. 17-0127



**Transmission Needle Bearings** feature full compliment roller design.

VT No.	Torrington	OEM	Type
12-0461	12-0326	35690-54	Closed
12-0396	12-0327	35961-52	Open



36-0094	17-9160	35635-36	Speedometer Gear, 7 Teeth
36-0095	17-9161	35635-62	Speedometer Gear, 4 Teeth
36-0096	17-0094	35635-69	1969-80 Speedo Gear 7 Teeth





# 1979-85 Big Twin Rotary Transmission Top

4-Speed Rotary Top Shifter Linkage and Hardware for 1979-85 FX-FL-FXWG models.

VT No.	OEM	#	Item U/M
17-0120	650	2	Plug, 10 pack
17-9945	2818A	3	Bolt
9656-8	—	4	Screw Set, Chrome
9657-8	—	4	Screw Set, Zinc
8905-7	—	4	Screw Set Allen
12-0702	6750	10	Shim, .005, 10 pack
12-0703	6752	11	Shim, .015, 10 pack
12-0938	11016	14	Snap Ring, 10 pack
12-0939	11036	15	Pawl Retainer, 10 pack
14-0102	12010	16	Cover Oil Seat, 5 pack
37-8856	25715-47	17	Grease Fitting, 10 pack
15-0217	25811-11	18	Switch Washer, 10 pack
10-1269	32535-48	19	Lever Washer, 5 pack
17-9947	33167-79	20	Top Cover
17-9909	33174-79	21	Shaft Cover
17-2125	As Above	21	Chrome
17-9820	33177-79	22	Lever Complete FL-FXWG
17-9933*	As Above	22	Chrome Forged, Steel
17-9873	33185-79	25	Shifter Rod Assembly FX-FXE
17-9869	33187-79	26	Spacer Standard, 5 pack
17-9870	—	26	Spacer .005 Oversize, 5 pack
17-9998	—	26	Spacer .010 Oversize, 5 pack
17-9910	33188-79	27	Plunger Body
17-9872	33190-79	27A	Lever Arm FL-FXWG
15-0157	33196-79	28	Cover Gasket, 10 pack
17-0907	33197-79	29	Bolt Lock, 10 pack
17-0163	33198-79	30	SW Bushing, each
13-0124	33199-79	31	Pawl Spring, 10 pack
13-0125	33201-79	32	Carrier Spring, 10 pack
32-0043	33901-79	34	Neutral Switch
17-9948	34020-79B	35	Cam Assembly
14-0533	34036-80		Shifter Cam Seal, Oversize 1980-84, 10 pk
12-0917	34040-52	37	Retaining Ring, 10 pack
17-0076	34062-52	38	Cam Follower
13-0130	34068-52A	38A	Cam Follow Spring, 10 pack
17-0115	34158-36	40	Main Shifter Fork
17-0116	34159-36	41	Countershaft Shifter Fork
17-0118	34168-52	42	Finger Roller, 2 pack
12-0526	34179-33	43	Bushing Nut, 5 pack
17-0906	34180-33	44	Lock Washer, 10 pack
17-9896	34184-79	45	Shifter Finger
17-0136	34145-76	46	Fork Shaft
17-0058	34461-72	47	Shifter Pawl Spacer
17-0057	34476-72	48	Shifter Pawl
17-9949	34494-74C	49	Pawl Carrier
17-9906	34517-80	50	Rear Pawl Stop
17-9907	34518-80	51	Front Pawl Stop
17-9958	Set	50/51	Pawl Stop Set
17-9904	34652-80	52	Shifter Lever Shaft
17-9843	34655-79	53	Lever Complete FX-FXE
17-9937	As Above		Chrome Forged
17-9882	34658-79	54	Lever Pin, 5 pack
17-9874	34659-79	55	Rod Linkage FX
15-0162	34824-79	56	Cover Gasket
17-9911	35336-74	57	Thrust Washer, 5 pack

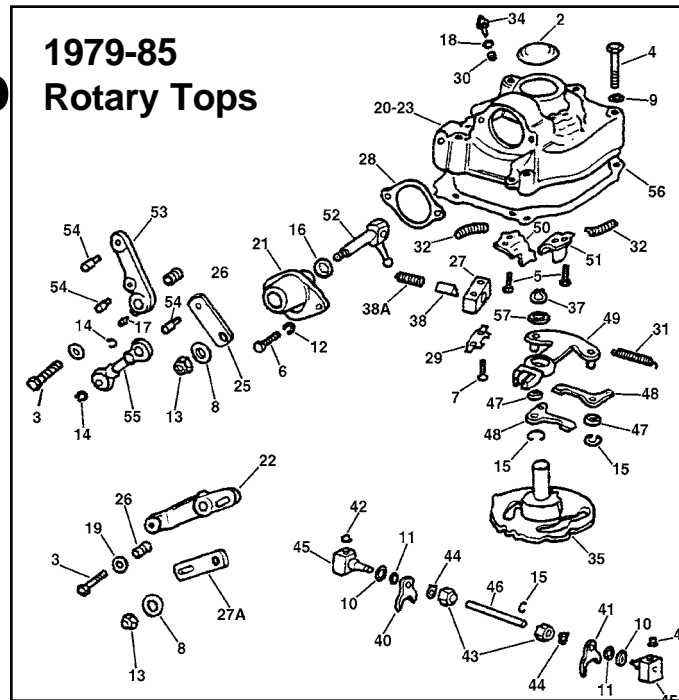

**1979-85 4-Speed Trans Top** includes all parts completely assembled. Arm with grease fitting is chrome plated; all other parts have a natural finish.

VT No.	OEM	Fits
17-0010	33158-80	FLH
17-0011	33183-80	FXE



**Shifter Top Hardware Kit** fits Late 1979-85 4-Speed Big Twin rotary top includes all parts except top casting, shaft cover and linkage.  
**VT No. 17-0950**

## Jockey Top

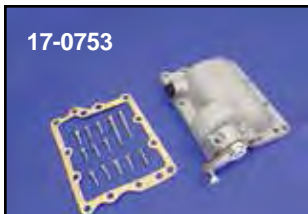

**Hand Shift Jockey Top** with alloy finish is for 1936-78 Big Twin. 4 Speed type. Available with or without neutral switch.

VT No.	Type
17-0753	Without switch
17-0754	With switch

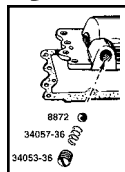

**Cam Plunger Kit** includes numbers 34053-36 cap screw, 34057-36 spring, and 8872 ball on 1936-79 hand shifter models.

VT No.	Item
17-9764	Kit
13-0129	Spring, 10 pack
12-0156	Ball, 50 pack



**Inner Shifter Arms** fit 3 and 4 speed hand shift transmission tops. VT No. 17-0500 has 5/16" — 24 threaded hole. VT No. 21-0216 adapter arm reverses shifting on 1936-50 tops.

VT No.	OEM	Year	Finish
17-0504	34448-36	1937-50	Parkerized
17-0501	34448-36	1937-50	Zinc
17-0500	34448-51	1951-65	Zinc
21-0216	—	1936-50	Zinc

# 1952-79 Big Twin Ratchet Top

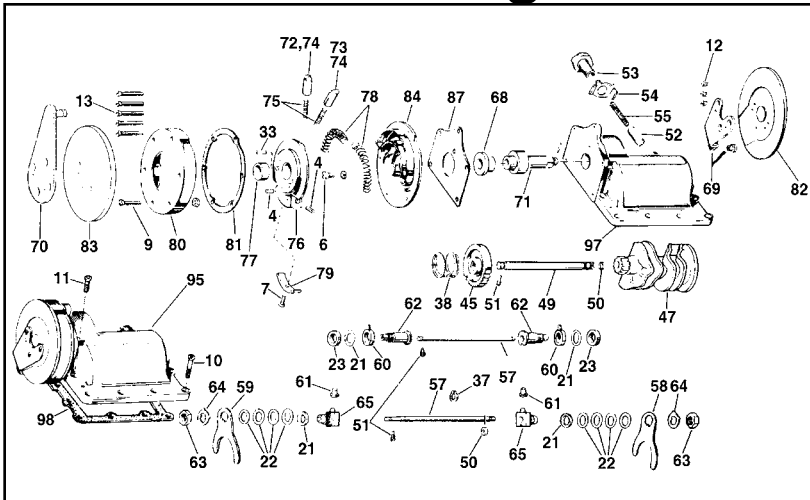

## 1952-79 Big Twin Ratchet Top Parts.

VT No.	#	OEM	Item
12-1162	4	623	Roll Pin
17-0079	6	1369	Phil. Screw, 10 pack
17-0078	7	1608	Screw, 10 pack
17-0077	9	1764	Screw, 6 pack
8148-13	10	1765W	Cadmium Screw
	11	1766W	Set
21-1987	12	1767W	Stainless Steel Lever Screw, 12 pack
17-0074	13	1772W	Screw, 5 pack
12-1171	33	9106A	Pawl Carrier Pin
12-0702	21	6750	Shim .005"
12-0703	22	6752	Shim .015"
17-9751	23	6754	Shim 3/32"
10-1257	22		Shim .007
13-0126	38	33390-26	Gear Spring, 10 pack
17-9765	45	33960-36A	Gear
17-9766	47	34019-73	Shifter Cam, FL only
17-0208	47	44006-76	Shifter Cam, FX
17-0133	49	34030-36	Cam Shaft Hand Shifter
17-0134	49	34031-41	Cam Shaft Foot Shifter
14-0117	50	34036-36	Oil Seal
17-0132	51	34050-36	Lock Screw, each
17-0076	52	34062-52	Cam Follower
17-0075	53	34064-52	Cam Bolt
17-0916	54	34066-52	Lock Tab, 10 pack
13-0130	55	34068-52A	Spring
17-0135	57	34140-36	Fork Shaft 1936-76
17-0136	57	34145-76	Fork Shaft 1977-84
17-0115	58	34158-36	Main Shifter Fork
17-0116	59	34159-36	Countershaft Shifter Fork
17-0097	60	34165-36	Shifter Finger
17-0117	61	34168-39	Finger Roller Pair
17-0096	62	34175-36	Bushing Fork
12-0526	63	34179-33	Nut, Bushing, 5 pack
17-0906	64	34180-33	Lock Tab, 10 pack
17-0069	65	34182-76	Shifter Finger, Late 76-79
10-0725	68	34435-52	Shaft Bushing Footshifter models
10-0732	68	34430-36	Shaft Bushing Handshifter models only
21-0202	69	34447-52	Chrome Lever
21-0195	70	34447-74	FX Lever, Chrome
17-9767	71	34453-52	Shifter Shaft
17-0073	72	34477-53	Shifter Pawl, Left
Pair	73	34478-53	Shifter Pawl, Right
17-0068	74	34478-75	Shifter Pawl, Late 1975-Early 79
13-0133	75	34482-53	Pawl Spring, 10 pack
17-0071	76	34488-52B	Pawl Carrier
10-0726	77	34498-52	Pawl Bushing
13-0134	78	34500-52A	Carrier Spring, 10 pack
17-0070	79	34525-54	Pawl Retainer
17-0103	80	34551-52	Shifter Cover, Aluminum
17-0102	80	34551-52	Shifter Cover, Chrome
15-0159	81	34552-52	Cover Gasket
21-0200	82	34555-52	Chrome Cover
21-0201	83	34555-74	FX Chrome Cover
17-9895	84	34560-52	Adapter Plate
15-0160	87	34565-52	Plate Gasket
17-0050	95	34799-65	Shifter Top, Complete
17-0105	97	34803-59	Shifter Top, Bare
15-0161	98	34824-36	Top Gasket

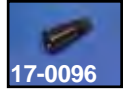

## Ratchet Top Assembly Unit

replaces 34799-65 features cast shifter drum, chrome arm and cover, and natural finish or chrome top casting. FLH type has a 1 down, 3 up shifter pattern, FX has a 1 up and 3 down pattern.

VT No.	Type	Item	Type
17-0050	Plain	Complete	FL
17-0281	Plain	Complete	1952-58
17-0045	Chrome	Complete	FL
17-0980	Chrome	Complete	FL
17-0852	Plain	Complete	FX
17-0875	Chrome	Complete	FX
17-0106	Plain	Top Casting Only	—
17-0232	Chrome	Top Casting Only	—

**Ratchet Top Shifter Cam Follower Kit for 1952-78 Big Twin.** Includes bolt, follower, spring and lock tab.  
**VT No. 17-0750**

**Gear Box Vent Screw** with chrome finish. Replaces 34720-56 in 1936-84 4-speed transmissions. Sold each.

VT No.	Finish
37-8890	Chrome
17-0432	Zinc

## Transmission Top Cover Screw Kit.

Stock fasteners and special vent screw fits Big Twin 4-Speed models.

Chrome	Cadmium	Parkerized	Year	Type
8147-13	8148-13	—	1936-78	Stock Slot
	8148-13T*	Note: Zinc	1936-78	Stock Slot
8750-14	—	—	1936-64	Allen
9612-13	9613-13	9620-13	1936-55	Stock Oval
2103-13	2104-13	—	1950-53	Phillips Oval
8748-12	8749-12	—	1965-79	Allen

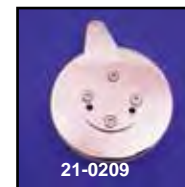

**Chrome Dust Shield and Shifter Lever Set** complete with mounting hardware.

VT No.	Fits	Type
21-0210	1952-E78 FL, Covers Ratchet Drum	Full
21-0208	1952-E79 FL	Stock
21-0214	1974-E79 FX	Stock
21-0209	1974-E79 FX, Covers Ratchet Drum	Stock





# Shifter Fork

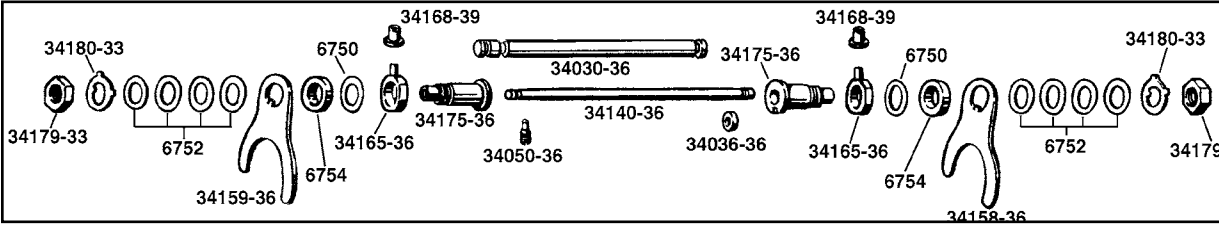

**Shifter Clutches** for 1936-85 4-speed Big Twin.

Sifton	VT No.	Andrews	Fits
17-0250	17-0112	17-8233	Countershaft, Large 1-2
17-0251	17-0113	17-8234	Mainshaft, Small 3-4
—	17-0114	Set of Clutches includes one each number	

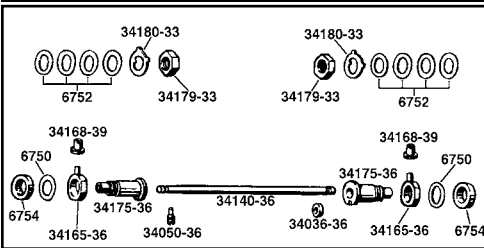

**Shifter Fork Shaft Kits** include shaft, lock screw, finger, rollers, seal, bushing, nuts, locks, shims and spacer for years listed. Order forks separately.

VT No.	Years
17-9154	1936-75
17-9155	1976-78
17-9156	1979-84

## Shifter Fork Group Big Twin Transmission 1936-78 3 and 4 Speed.

VT No.	OEM	Item	Note
17-0133	34030-36	Shifter Cam Shaft	Hand Shifter
17-0134	34031-41	Shifter Cam Shaft	Foot Shifter
14-0117	34036-36	Oil Seal	1936-79
14-0533	34036-80	Oil Seal	1980-85
17-0132	34050-36	Lockscrew	Each
17-0135	34140-36	Shifter Fork Shaft	1936-76
17-0136	34145-76	Fork Shaft	1977-84
12-0939	11036	Snap Ring, Shaft	1977-84
17-0115	34158-36	Shifter Fork	Main
17-0116	34159-36	Shifter Fork	Countershaft
17-9750	—	Fork Set	Andrews
17-0097	34165-36	Shifter Finger	1936-Early 76
17-0069	34182-76	Shifter Finger	Late 1976-E79
17-0117	34168-39	Finger Roller, pair	1939-78
17-0118	34168-52	Finger Roller, pair	1979-84
17-0096	34175-36	Finger Bushing	1936-84
12-0526	34179-33	Bushing Nut (5 pack)	1936-84
12-0702	6750	Fork Shim .005"	10 pack
10-1257	—	Fork Shim .007"	10 pack
12-0703	6752	Fork Shim .015"	10 pack
17-9751	6754	Fork Shim 3/32"	10 pack
10-0732	34430-36	Shaft Bushing	Hand Shifter
10-0725	34435-52	Shaft Bushing	Foot Shifter

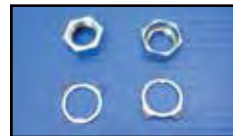

**Shifter Fork Nut Kit** includes two nuts, two locks, fits 1936-84 3 and 4-speed Big Twin and 1936-73 45's.  
VT No. 17-2121



Steel Big Twin Shifter Forks for 1936-85 4-speed.

VT No.	OEM	Fits	Brand
17-0115	34158-36	Mainshaft	V-Twin
17-0116	34159-36	Countershaft	V-Twin
17-0122	Pair	Set	Sifton
17-9750	34158-36 34159-36	Set	Andrews

# Lock Tabs



**74 and 80 Transmission Hardware Kit** includes all locks, springs, keys, retaining rings and clips for all 4 speed, all the hard to get small parts.

VT No.	Fits	Type
17-2120	1936-79	Ratchet Top
17-2122	1979-84	Rotary Top



**Transmission Lock Kit** contains lock tabs and snap rings needed when rebuilding 74 and 80 4-speed transmission.  
VT No. 17-0926

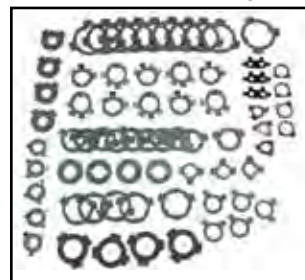

**Lock Tab 70 Piece Assortment** for all Big Twin and XL's contains a greater quantity of more popular type and is carded for display and removal.  
VT No. 17-0940

# 4 Speed Transmission Gasket and Seal Kit

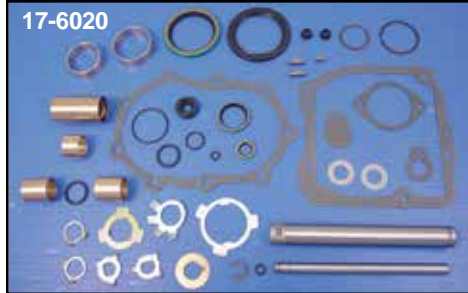
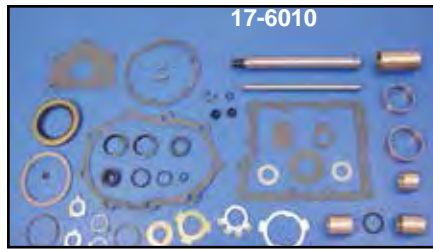

**Jims Hardware and Rebuild Kit** includes bushings, locks, keys and snap rings for completing a 4 speed transmission rebuild. James gasket set included.

VT No.	Years
17-6008	1936-76
17-6009	1976-Early 77
17-6010	Late 1977-79
17-6020	1980-85

**Deluxe 4-Speed Transmission Gasket Kits** include all seals, corks, locks and gaskets as the factory number, the kit replaces.

VT No.	Years
15-0614	1936-79
15-0783	1936-79
15-0620	1980-84



**Big Twin 4-Speed Transmission Main Seal Kit** fits 1936-84. It includes seals for clutch hub, main drive gear, main shaft, cork and sprocket lock tab.

Sifton	James	Year
14-0684	15-1164	1936-79
—	15-1238	1980-81
—	15-1165	1982-84



**4-Speed Mainshaft Spacer and Seal Kit** includes coated seal, correct spacer, nut and locktab.

VT No.	Years
17-0823	1937-76
17-0766	1937-76
17-0767	1977-78
17-0769	1979
17-0768	1981-82
17-0770	1983-85

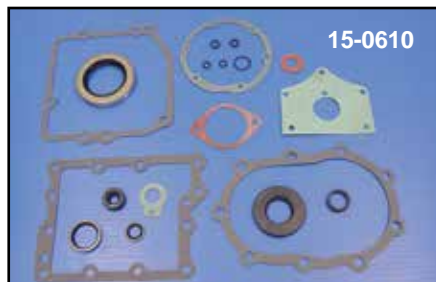

**Transmission Gasket Sets.** Complete gasket and oil seal kit listed below for individual application for 4 speed models.

James	GB No.	OEM	Year
15-0836	15-0608	33031-36	1936-64
15-0836	15-0609	33031-65	1965-69
15-0836	15-0610	33031-70	1970-79
15-0836	15-0612	33031-80	1980-85

**Mainshaft Seals** fits 1936-85, 74 and 80 4-speed models.

James	VT No.	OEM	Years/Type
—	7805-2*	35230-39	1939-80 Kit, Complete
14-0637	14-0122	35230-39	1939-80 Double Lip
—	14-0187	35230-39	1939-80 Double Lip Coated
14-0645	14-0129	37741-67	1979-81 Rubber
14-0646	14-0130	37741-82	1981-85 Rubber
—	14-0576	—	1981-85 Metal
—	12-0207	35175-38	1938-77 Key
14-0638	14-0123	35231-36	1936-76 Cork

\*Note: Kit includes key and cork.





# 4-Speed Kick Starter Kit



**Heavy Duty Kick Start Kit** features a chrome smooth thick wall kick cover and heavy duty kick starter arm. Fits all 4-Speed Big Twin 1936-84. Requires use of wafer type release bearing kit.

VT No.	Item	Year
22-1020	Kick Starter Kit	1936-84
22-0834	Kick Starter Kit	1941-84
18-3203	Release Kit	1936-64
18-3204	Release Kit	1965-69
18-3607	Release Kit	1970-84



**V-Twin Complete Kick Starter Kit** fits 1936-84 models. Kit includes a reinforced kick cover, chrome arm and all gears and hardware to make conversion complete. Kit available with a polished or chrome plated kick starter cover.

VT No.	Type
22-0301	Chrome
22-0302	Polished

\*Note: When Installing any type of our 74-80 kick starter kits on 1980-85 4-Speed, our VT No. 17-0101 late bearing retainer, which incorporates a kick starter stop built in is required.

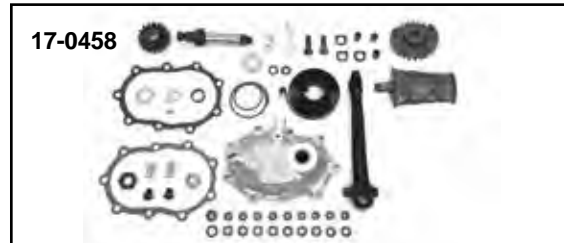

**Kick Starter Kit** fits 1936-84 4 Speed Big Twin. Kit includes cast cover, black arm and parkerized nut set as shown and comes partially assembled with finger shaft and clutch release finger. Kit also includes gasket and chrome hex nuts.

VT No.	Year	Type
22-1042	1941-64	Chrome
22-1124	1941-64	Replica
22-1047	1936-84	Replica
22-0212	1941-64	Replica
22-1157	1941-52	Replica
17-0458	1954-63	Replica

**Our Original Kick Starter Kit Developed in 1979!**



# Kick Starter Parts for 4-Speed Big Twin

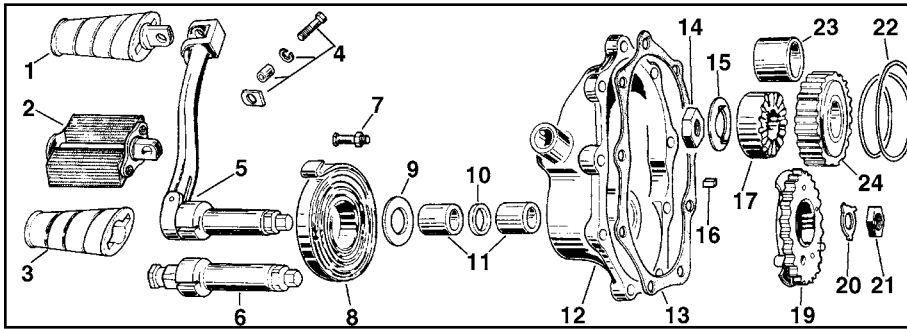

74" and 80" Kick Starter Parts listed below will fit 1936-84 3 and 4 Speed models.

VT No.	#	OEM	Item
17-0301	1	33175-16B	Kick Starter Pedal
17-0300	2	33175-16	Bicycle Pedal
28-0213	3	33182-63A	Kick Starter Rubber
17-0306	4	33213-31	Pin Kit
17-0095	5	33068-54	Early Kick Starter Arm
17-0312	6	33096-54A	Kick Starter Shaft
8120-3	7	33090-36	Spring Stud
8120-3T	7	33090-36	Spring Stud
13-0123	8	33085-36	Kick Starter Spring
17-0413	9	33080-36	Thrust Washer
14-0115	10	33076-37	Kick Starter Seal
10-0720	11	33288-37	Bushing Kit
43-0100	12	33277-36A	Kick Starter Cover
15-0158	13	33295-36	Kick Starter Gasket
12-0500	14	7977	Mainshaft Nut
17-0903	15	33396-39	Mainshaft Lock
12-0206	16	33393-50	Key
17-0403	17	33381-39	Kick Starter Clutch Gear 1939-74
17-0416	17	33560-75	Kick Starter Clutch Gear 1975-85
17-0400	19	33350-36	Crank Gear
17-0334	19	33350-36	Crank Gear, Sifton
17-0902	20	33082-16	Kick Starter Shaft Lock
12-0527	21	7911	Kick Starter Shaft Nut
13-0128	22	33391-36	Ratchet Spring
10-0721	23	33438-50	Gear Bushing
10-2486	23	As Above	.005 Oversize
17-0401	24	33430-50	Starter Gear, 16 Tooth
17-0402	24	33430-59	Starter Gear, 14 Tooth



**Big Twin Small Parts Only Kick Starter Kit** contains parts as pictured, 16 tooth ratchet gear set, 24T crank gear, kick starter shaft, ratchet spring, lock tabs, nuts and key.

VT No. 17-0412

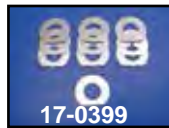

**Sifton Kick Starter Gear and Shaft Assembly** includes large gear, corresponding shaft, nut, lock tab and thrust-washer.

VT No. 17-0335

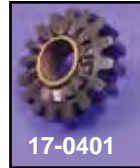

**Complete Kick Starter Ratchet Gear Kit** contains ratchet gear, clutch gear, spring and key way. It is available with 16 or 14 tooth starter gear. Used on all 1936-85 4 Speed Big Twin.

VT No.	Type	Year
17-0404	16 Tooth Kit	1936-69
17-0405	14 Tooth Kit	1936-69
17-0671	14 Tooth Kit	1970-85



**Bumper Plate, Kick Starter for Big Twin.**

VT No.	OEM	Fits
17-0407	33353-36	All 1941-75
17-0408	33353-78	1978-up 4 Speed



**Kick Starter Bumper Plate Screws** replace 1864B. Used on all 1936-85 Big Twins.  
VT No. 17-0411



**Oil Deflector Mainshaft Starter Gear** replaces 33429-39, fits all 1941-79 Big Twins. 33429-80 fits 1980-84 Big Twins.

VT No.	OEM	Fits	Item
17-0409	33429-39	1941-79 Big Twin	Deflector
17-0410	33429-80	1980-up Big Twin	Deflector
37-9134	2333W	1941-79	Screw
37-9173	3789A	1980-84	Screw

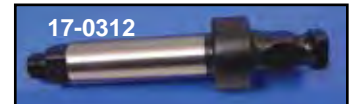
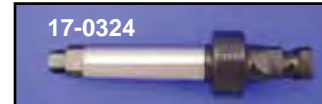

**Big Twin Kick Starter Shaft** replaces 33096-54A. Fits 1936-84 Big Twin.

VT No.	Type
17-0312	V-Twin™
17-0317	Jims
17-0324	Sifton

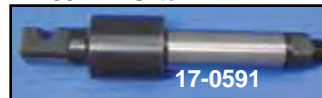

**Longer Kick Start Shaft** fits 1937-84 Big Twin 4-speed, eliminates the use of fold out kick starter arm. The stroker

I-Beam or other offset arms may be fitted.

VT No.	Brand
17-9145	Jims
17-0591	Sifton

**Kick Start Shaft with gear.** Fits 1941-1964 FL.

VT No. 17-0829

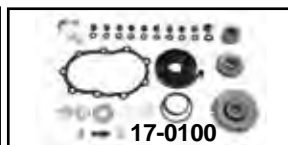
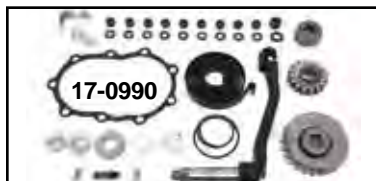

**Replica Kicker Kit.**  
17-0990 Kicker Kit  
17-0100 Small Parts





# 4-Speed Transmission

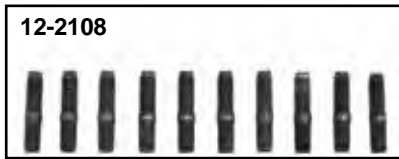

## 4-Speed Kick Starter Cover Stud Set.

VT No.	OEM	Piece	Years	Type
12-2108	33298-36	9	1936-64	VT
17-1489	Zinc	9	1936-64	VT
12-2109	33298-36	7	1965-85	VT
	24823-80	2		
9637-13	33298-36	9	1936-84	Colony
	24818-52	4	Parkerized	

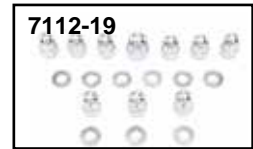
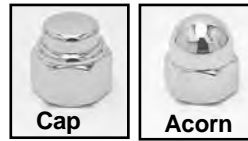

## Transmission Side Cover and Clutch Arm Nut Kit fits all 1936-84 Big Twins.

VT No.	Type	Finish
7112-19	Acorn Style	Chrome
8442-19	Cap Style	Chrome
8113-20	Hex Stock	Cadmium
8112-20	Hex Stock	Chrome
8112-20T	Hex Stock	Chrome
9671-20	Hex Stock	Parkerized
9671-20T	Hex Stock	Parkerized
8751-19	Extra Deep Thread for Long Studs on late models Acorn style	
8752-19	Same As Above, Cap Style	



# 4-Speed Trans Plugs

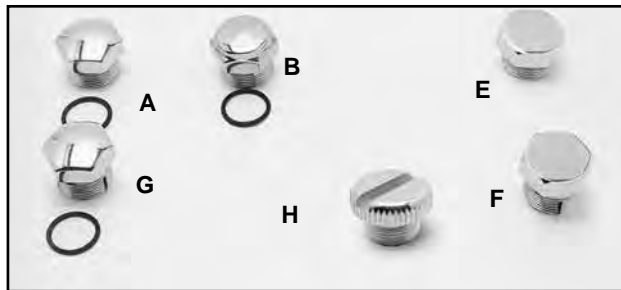

4-Speed Mini Dipstick for 1936-84.  
VT No. 17-0861

## Transmission Fill Plugs.

A. Fill Plug will fit all 1940-84 Big Twins.

VT No.	Finish
7351-2	Chrome

B. Cap Style Plug fits 1940-84.

8801-2	Chrome
--------	--------

E.-F. Stock Plug is available in standard or oversize self tapping. Fits 1936-up Big Twin.

VT No.	Finish	Type
8118-1	Chrome	Standard (E)
7616-1	Cadmium	Standard (E)
9700-1	Parkerized	Standard (E)
8406-1	Chrome	Oversized (F)
8407-1	Cadmium	Oversized (F)

G. Chrome Fill Plug is designed to restore "pulled" threads in the transmission side over. It fits all 1940-84 Big Twin.

7156-2	Chrome
--------	--------

H. Replica Transmission Filler Plug is available in chrome plated steel or brushed aluminum. It fits 1958-80 Big Twins.

VT No.	Finish	Brand
9400-1	Chrome	Colony
9401-1	Aluminum	Colony
37-9081	Chrome	V-Twin
37-9080	Alloy	V-Twin

# Drain Plugs



## Transmission Drain Plugs.

A. Chrome dome head plug with an oversize thread and one tap for rethreading the stripped out drain hole. Fits 1965-up Overhead Valve Big Twin and 1967-up Sportster.

VT No.	Type
7502-2	Plug and Tap
7503-1	Plug Only

B. Stock style of drain plug and brass gasket used on Sportster transmission and motor case also oil tank with 1/2"-13 thread.

VT No.	Finish
8494-1	Chrome
8495-1	Cadmium
15-0194	Brass Gasket
552	



37-0095



37-8934

Magnetic Drain Plugs prevent metal particles from circulating through engine, transmission cases and oil tank.

VT No.	OEM	Size	Use
37-0096	707	1/2 - 13	74 Transmission
37-0097	700	3/8 - 24	Big Twin Case Plug 74 and 80
37-0095	60348-65A	1/2 - 20	74 and 80 Inner Primary
37-0098	720	5/8 - 18	Oil Tank and Time Hole
37-8934	734-739	1/8 - 27	NPT 1987-89 Big Twin Primary Transmission, FXST-FXR
37-0099	739A	1/8 - 27	NPT 1990-up Big Twin Transmission
37-9242		1/8 - 27	NPT 1990-up Big Twin Transmission with Hex
37-8961	718	1/4 - 18	NPT Chain Cover
37-9217	722	3/8 - 18	FXR Drain



# 4-Speed Kick Starter Cover



**Replica Cast Kick Starter Covers** for 1936-84 Big Twin 4-speed.

VT No.	OEM	Years
43-0148	33277-36	1951-67
43-0153	33277-36	1937-50
43-0982	33277-36A	1937-50

17-0882 Clutch Release Lever Bushing, 1936-52 EL, 1941-84 FL  
17-0354 Cadmium Bushing



**Chrome Smooth Kick Starter Cover** for 1936-85 4-speed Big Twins. The cover is heavy die-cast with machined flat surface. It accepts allen screws for mounting and includes short finger shaft and finger. Use with release bearing kits listed.

VT No.	Item
43-0107	Chrome Cover
8820-9	Allen Screws
17-9923	Finger Shaft, Short
17-1499	Finger Only
18-3203	Release Kit for 1936-64
18-3204	Release Kit for 1965-69
18-3607	Release Kit for 1970-84



**Kick Starter Covers** for 1936-84 Big Twin 4-speeds include bushings installed.

VT No.	OEM	Type	Years
43-0100	33277-36A	Polished	1968-84
43-0101	33277-36A	Chrome	1968-84
43-0164	33276-70	Chrome	Electric Start Only



**Finned Kick Starter Cover** with cast finish fits 1936-84 kick starter Big Twins. Bushings with seal installed.

VT No.	Brand
43-0161	V-Twin
43-0274	Sifton



**Chrome Cover** dresses up clutch arm on 1936-84 Big Twins. Acorn nut included.  
VT No. 42-0527

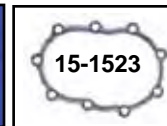

**Big Twin 4 Speed Transmission Side Cover Gasket** replaces 33295-36.

VT No.	Type
15-0158	GB
15-0769	GB, pair
15-1035	James
15-0595	James, Silicone
15-1523	GB, Silicone



**Kick Starter Bushing** fits 1941-84 Big Twin 4-Speed.

VT No.	OEM	Item
10-0720	33288-37	Kit
10-2107	Sifton	Standard
10-2108	As Above	.005"
14-0115	33076-37	Seal, 5 pack
16-1732	—	Installation Tool
2762-3	Kit	Bushing Kit
2764-2		Tool



## Kicker Springs



**Kick Starter Return Spring** for all 1936-85 Big Twins.

VT No.	OEM	Finish
13-0123	33085-36	Chrome
13-9249	33085-36	Black
13-0945	33085-36	Parkerized
42-0217	33150-59	Chrome Cover



**Kicker Spring Studs** fits 1936-84 Big Twin kick starter.

VT No.	OEM	Finish
8119-1	33090-36	Chrome
8119-1T	33090-36	Chrome
8120-1	33090-36	Cadmium
9717-1	33090-36	Parkerized
9717-1T	33090-36	Parkerized
8120-3	33152-59	With screw for attaching cover
8120-3T	As Above	
17-0601		Zinc Kick Starter Bolt Kit
17-0602		Chrome Kick Starter Bolt Kit





# Kick Starter Arm

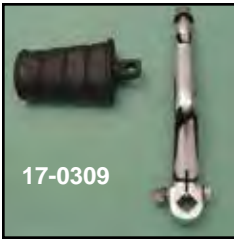

**Complete Kick Starter Arm And Pedal Assembly Kit** includes heavy forged offset kick arm VT No. 17-0308, kick starter pedal 17-0301 and necessary hardware for easy installation.

VT No.	Item
17-0309	Kit Complete
17-0308	Kick Starter Arm
17-0301	Kick Starter Pedal
17-0982	Arm Kit, SS



**Stroker Kick Starter Arm Kit** includes I-Beam, 1" longer chrome kick starter arm with chrome rail type buffalo kick pedal and hardware.  
**VT No. 17-9921**



**Chrome Stroker Kick Starter Arm** features forged I-Beam profile for unbreakable service. Fits 1954-85 Big Twin.  
**VT No. 17-0160**



17-0322

**Kick Starter Arms** are constructed of forged steel for durability for 1954-84 FX-FL.

VT No.	OEM	Finish	Type
17-0308	33052-71	Chrome	Heavy
17-0310	As above	Stainless	Heavy
17-0018	As Above	Chrome	Standard
17-0322	33052-71	Black	Polished
17-0344	Natural	Replica	Black
17-0601	Bolts	Chrome	Kit
17-0602	Bolts	Chrome	Kit



17-0344



## Bicycle Style Kicker Pedals

**Replica Bicycle Style Kick Start Pedal** features black rubber blocks.

VT No.	Finish
17-0316	Parkerized Shaft Tube, Cadmium Side Plates
17-0320	Zinc
17-0321	Parkerized
17-0848	Nickel Plated
17-0341	Parkerized
17-0955	Military, Parkerized
17-0962	Military, Chrome

**Additional Parts Sold Separately**  
17-0831 Inner Plate, Raw  
17-0832 Inner Tube Raw  
17-0874 Inner Plate, Cadmium  
17-0866 Inner Plate, Parkerized  
17-0330 Rod and Rubber Kit, 4 pc  
17-0319 Center Axle  
17-0626 End Cap Raw  
17-0863 End Cap Cadmium  
17-0832 Axle Tube Raw  
17-0505 Rebuild Kit  
17-0431 Pedal Stud Set  
17-0855 Parkerized Kit; cad outer cover, parkerized pedal axle, pedal bolt kit & related hardware.

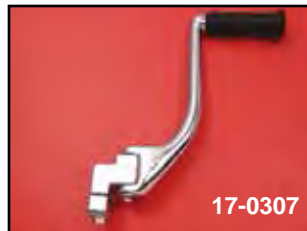

17-0307



17-9934

**Chrome Fold-Out Kick Starter Arms** replace 33057-77, 1977-84 FX-XL models. The 17-9934 features flat kick starter pedal that spins.

VT No.	Type
17-0307	Stock
17-9934	Flat Pedal Style



17-0384



17-0095



17-0323



2894-7

**FL Kicker Arm** straight style for 1954-69 FL, FX 1971-72, to fit with stock 2:1 exhaust only; fits closer to chassis and replaces 33068-54.

VT No.	Item
17-0095	Chrome
17-0323	Black
17-0384	Black Kit
<b>Mounting Kits</b>	
2894-7	Parkerized
2894-7T	Parkerized
2895-7	Cadmium
2895-7T	Zinc
2896-7	Chrome



17-0048



17-0047



17-0350



17-0351

**Replica One Piece FL Kick Starter Arm** is forged steel for replacements on 1936-53 Big Twins.

VT No.	OEM	Years	Finish
17-0048	33063-36A	1941-53	Chrome
17-0047	33063-36A	1941-53	Black
17-0350	33063-36	1936-40	Black
17-0351	33063-36	1936-40	Chrome
17-0290	Kit	1936-40	Black



17-0300



17-0044



17-0043



17-0041

**Chrome Original Bicycle Style Rubber Kick Starter Pedal and Axle Assembly** are available in colors. Replace 33175-16A. Includes bushing, bolt and spring clip. The pedal is chrome plated. *We've Colorized The Classics!*

Complete Pedal	Rubber Only	Color
17-0300	28-0207	Black
17-0044		Blue
17-0043	28-0209	Red
17-0041	28-0208	White



**Kick Starter Rubber Pedal Assembly** includes mount bolt pin kit with bushing for one piece kick starter arms 1936-76 models.

VT No.	Item	Color/Style
17-0315	Complete Pedal	Black/H-D
17-0261	Complete Pedal	V
17-0283	Complete Pedal	45"
17-0301	Complete Pedal	Black
17-0311	Complete Pedal	White
17-2123	Shaft Only	
28-0213	Rubber	Black
28-0214	Rubber	White
28-0341	Rubber	Black, 45"
28-0458	Rubber	Black, FLH Logo
28-0482	Rubber	Black Skull Design
28-0249	Rubber	Skull
17-0971	Pedal	
17-0283	Pedal Kit	Black, 45"
17-0624	Sifton Cast	Black



**Army Kicker Pedals** are all steel construction, bicycle style round pedals.

VT No.	Type
17-0955	Parkerized
17-0962	Chrome



**Skeleton Kick Starter Pedal Assembly.**

VT No.	Style
17-0302	Chrome Skeleton
17-0303	Brass Skeleton
17-0378	Pedal Shaft for 17-0302

**Pedal Pin Bolt Kit** fits 1931 and later kick starter Twins. Each kit contains one of the following: 4336 pedal pin bolt, 33213-31 pedal pin bushing, 33215-30 spring washer and 7045 lock washer.

VT No.	OEM	Item
17-0306	Complete	Kit
37-9060	Chrome	Kit
37-9061	Chrome	Allen Kit, each
17-0771	Replica	Kit, each
37-0964	Chrome	Kit, each
10-2494	33213-30	Bushing, 10 pack
13-9184	33215-30	Spring Washer, 10 pack
2769-4T	Kit	Kick Starter Pedal Mt Kit, Parkerized
2770-4	Kit	Kick Starter Pedal Mt Kit, Parkerized



# Kick Starter Pedal

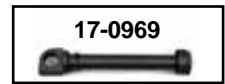
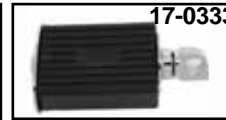

**Deco Plastic Replica Kick Starter Pedal** in cadmium or chrome with plastic pedal.

VT No.	Finish/Color
17-0331	Cadmium/Black
17-0333	Chrome/Black
17-0332	Chrome/Yellow
17-0395	Alloy/Beck Style
17-0964	Black Pad Only
17-0877	Bicycle Cast
17-0969	Shaft Only, parkerized
17-0972	Shaft Only, chrome
17-0355	Bronze
17-0359	Polished Alloy



**Red Baron Billet Kick Starter Pedal** includes chrome axle shaft.  
VT No. 17-0651



**Chrome Flat Kick Starter Pedals.**  
VT No. Type  
17-0299 O-Ring  
17-9150 Rail



**Maltese Kick Starter Pedal Assembly** is constructed of billet alloy with chrome axle shaft.  
VT No. 17-0765



**Kick Starter Pedal.**  
VT No. Style  
17-0386 Knuckle Alloy Assembly

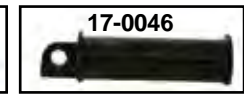

**Spool Kick Starter Pedal.** Order bolt kit separately except where noted.

Black	Chrome	Item
17-0979	—	Spool w/bolt kit
17-0046	17-2124	Spool
17-0459	17-0461	Holes
17-0961	—	Parkerized Bolt Kit
2894-7	—	Parkerized Mounting Kit
2895-7	—	Cadmium Mounting Kit
—	2896-7	Chrome Mounting Kit
21-0521	—	Parkerized Shifter Peg
17-0957	—	Hex Kick
17-0343	—	Brass Swiss Cheese
17-0837	—	Brass Swiss Cheese w/bolt kit
17-0623	—	Spool
17-0877	—	Pedal Pad







# 1941-Early 84 FL-FX Clutch Part

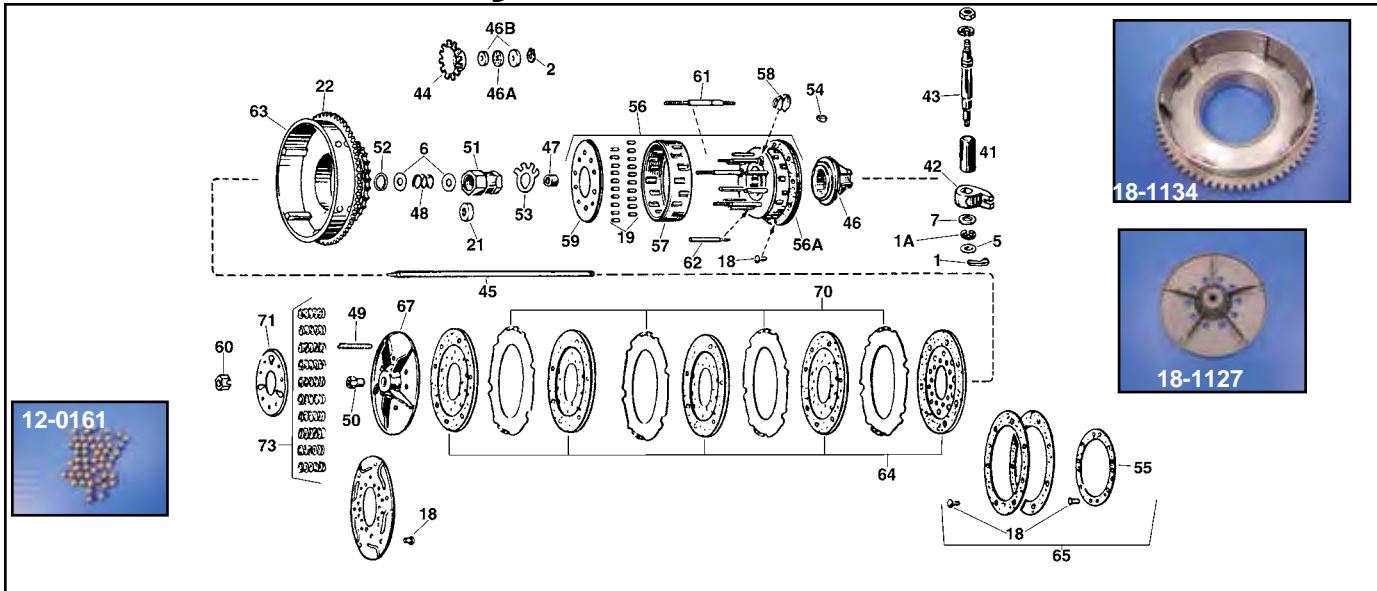

VT No.	#	OEM	Item
37-8786	1	528	Cotter Pin, 3/32 x 5/8
12-0900	1A	11000	Retaining Ring
12-0923	2	11096	Retaining Ring
12-1158	5	6320	Washer, 5/16 x 1 1/16 x 1/16
37-0533	6	6402	Washer, 25/64 x 59/64 x 1/32 (2)
12-9918	7	6443HW	Washer, 13/32 x 1 1/16 x 1/16
37-8807	18	8226	Rivet, 3/16 x 7/32 (brass) (8)
12-0161	19	8856A	Clutch Hub Bearing Ball
12-0344	19	9540A	Clutch Hub Bearing Standard Roller
14-0103	21	12014	Mainshaft Nut Oil Seal
18-1135	22	33163-65B	Ring Gear
17-0229	41	33291-36	Upper Shaft Bushing
17-1509	42	37070-39	Release Finger
17-1499	42	37070-39B	Release Finger
17-0124	43	37074-38	Release Lever (Shaft with pin)
17-9827	43	37074-38A	Release Lever (Shaft with snap)
18-3624	44	37228-75	Oil Slinger
18-3117	45	37285-41	Clutch Pushrod
18-3118		37285-65	Clutch Pushrod
18-3119		37285-70	Clutch Pushrod
18-3120		37285-75	Clutch Pushrod
18-3121	46	37310-39	Pushrod Bearing Standard grade
18-8229		37310-39	Pushrod Bearing OEM grade
12-0342	46A	37312-75	Pushrod Bearing
12-0370	46B	37313-80	Thrust Washer
14-0124	47	37337-36	Pushrod Cork Oil Seal
—	48	37348-41	Pushrod Oil Seal Spring
18-3202	49	37357-41	Pushrod Adjusting Screw
18-3201		37357-41A	As Above with Ball End
12-0514	50	37361-41	Adjusting Screw Nut
—	51	37496-41	Mainshaft Nut, Clutch Side
12-0508	51	37496-65	Mainshaft Nut, Clutch Side
17-0121	51	Kit	Nut-Seal-Lock
—	52	37498-41A	Oil Seal Retaining Ring

VT No.	#	OEM	Item
17-0904	53	37503-41	Clutch Nut Lockwasher
12-0208	54	37523-15	Clutch Hub Key
18-1125	55	37549-41	Hub Friction Disc Lining with Rivets
18-3124		—	As Above Nyla-Tron with Rivets
18-3153	56	37550-41A	Clutch Hub Assembly including
—		—	71 and 60 3-Stud
18-3154		—	As Above 5-Stud
18-3151	56A	37550-41B	Clutch Hub Bare 3-Stud
18-3150		—	As Above 5-Stud
18-3612	19	37566-41A	Clutch Hub Roller Retainer
		& 57	
13-0138	58	37574-44	Hub Bearing Plate Spring
18-3613	59	37576-41	Hub Bearing Plate
12-0509	60	37581-47	Hub Stud Nut, Black
12-0580	60	37581-47	Hub Stud Nut, Chrome
18-3114	61	37583-41	Drive Hub Stud
18-3115	62	37585-41	Clutch Hub Pin
18-0152	63	37702-65	Clutch Shell with Starter Gear 1965-69
18-1134	63	37702-70A	Clutch Shell with Starter Gear 1970-84
18-1149	63	37707-82	Clutch Shell, 1982-85
			with Rear Belt Drive
18-3159	63	37703-41B	Clutch Shell, Kick Starter only 1941-84
18-1124	64	37850-41	Set of Lined Clutch Discs 1941-67
18-1121	64	37930-68	Set of Lined Clutch Discs 1968-84
18-1127	67	37871-41	Releasing Disc
18-1143	67	—	As Above, Chrome
18-1126	70	37975-41	Drive Disc, Steel with rattler (each)
18-1129	70	37975-81	Drive Disc Steel, Smooth (each)
18-3652	70	37975-81	As Above Barnett (each)
18-3111	71	38010-41	Pressure Plate, 3 hole
18-3235	71	—	As Above, Chrome
18-3112	71	—	As Above, Black, 5-Hole
18-3236	71	—	As Above, Chrome
18-3113	71	—	As Above, Black, 10-Hole
13-0139	73	38075-41	Set of Clutch Springs 1941-67
13-0136	73	38075-68	Set of Clutch Springs 1968-84

**Steel Plates. Note** 18-8301 has smaller lug c



VT No.	Style	Year	Brand
18-1129	Smooth	1941-84	York
18-8288	Smooth	1941-84	Alto
18-8301	Smooth	1941-84	York
18-1126	Rattler	1941-67	Replica
18-8287	Rattler	1941-67	Alto





# Clutch Pack

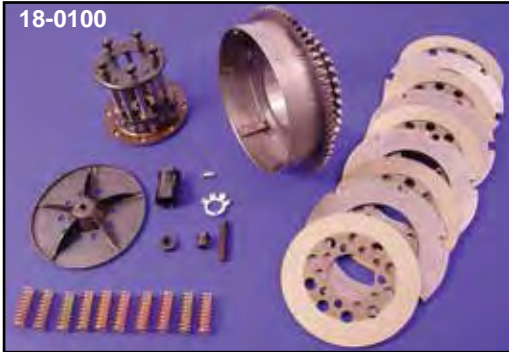

**Clutch Pack Kit** for 1941-84 Big Twin fits 4-speed models. Kit includes kick or electric clutch drum, 3 or 5 stud complete clutch hub, 4 steel and 5 fiber plates, clutch springs, outer clutch, releasing disc and clutch hub nut with lock tab, key and seal.

**York Clutch Assembly** fits 1941-84 Big Twin with belt or chain drive in wet or dry clutch systems and offers multiple plate increase in friction. Kits include clutch hub, bearing, wet or dry clutch discs, diaphragm, spring, retainer pressure plate and bolts.

VT No.	Item	Years	Hub
18-0099*	Kick only	1941-67	3
18-0101	Kick only	1941-84	5
18-0170	Kick and Electric	1965-69	5
18-0100	Kick and Electric with Rear Chain Drive	1970-84	

VT No.	Item
20-0260	Clutch Pack Assembly with standard duty spring
18-0517	As Above with heavy spring
16-0310	Puller Tool
16-0556	Lock Plate Tool
18-0785	Plate Set (15 piece)
18-3234	Replacement Clutch Spring
20-0876	Pressure Plate
20-0871	Outer Plate

\*Note: Features 3 1/2" plate early clutch and steel plate with rattlers.

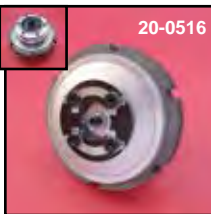

**Power Clutch** converts old style clutch packs to smooth modern diaphragm spring function. It is available for early chain and belt drive with wet or dry clutch. Kit includes clutch hub with bearing, clutch discs (friction and steel), diaphragm spring, spring retainer, pressure plate and four shoulder bolts. It utilizes existing clutch basket.

VT No.	Year	Brand
20-0516	1936-84	Rivera
18-0542	1936-84	Plate Set



**Clutch Drums** fit 1941-84 kickstarter models.  
Raw Chrome  
18-3159 18-0526



**Sifton Diaphragm Clutch Spring Pressure Plate** for 1941-84 Big Twins. Includes 5-stud clutch, diaphragm spring, pressure plate, rollers, adjustment screw and stud nuts. Use on all Big Twins 1941-64 with open primary and 1965-84 Big Twins with open or closed primary. It updates old style coil spring clutch to new style diaphragm clutch for positive clutch engagement.

VT No. 18-0540



**Barnett Scorpion Clutch Kit** features over twice as much friction surface area compared to stock clutch. All Scorpion clutches provide a positive engagement and release. Scorpion clutches incorporate 6 heavy duty coil springs. In addition, an extra spring set with a different

spring rate is included which allows the clutch to be tuned for street or race application depending on usage. Tunability is easy without removal of the primary cover. Barnett Friction Plates are compatible with any primary oil. Kit is designed to be used with stock type clutch basket. Fits 1936-Early84.

VT No.	Item
18-3822	Kit
16-0555	Puller Tool



**BDL Competitor Clutch Kit** features 9 springs and shoulder bolts for simple adjustment, large 40mm double row hub bearing, polished pressure plate and Kevlar clutch.

VT No.	Fits
20-0627	1936-84 Big Twin with Belt or Primary Chain
18-0547	Replacement Friction/Steel Sets for Above
20-0627	







# Clutch Hub



**Big Twin Stud Clutch Hub** fits 1941-Early 84 and features 53 long rollers, outer spring plate and nuts.

VT No.	Stud
18-1216	5
18-1218	3



**Clutch Hub Nut and Seal Kit** for use on all 1941-84 Big Twins. Includes nut, seal, and lock tabs. Packaged.

VT No.	OEM	Item
17-0121	17-0121	Kit Complete
17-0881	14-0103	Seal, 5 pack
	12-0508	Nut, each
	17-0904	Lock, 10 pack
	12-0208	Key, 10 pack
	17-0881	Kit Replica
	2548-8	Nut



**The Big Fixx for 74 and 80 Clutch** contains 52 roller bearings which take the place of the offset roller bearings and bearing retainer, resulting in a smoother more positive, wobble-free clutch operation.

VT No. 20-0229



**Sifton Retainer Kit** includes a clutch drum retainer designed to smooth clutch operation of all 1941-84. The retainer cures the problem of the uncontrollable "Grabby Clutch" found in the clutch system.

VT No.	Item
18-3116	Retainer Kit
12-1195	Snap rings

18-3116 Installed



**Spring Collar Assembly** for 1941-84 eliminates wobbly pressure plate, gives a balanced spring load, providing a smooth positive clutch operation with a minimum number of adjustments. The nuts go through the spring collar which strengthen and stabilize it. Assembly is available for 3 and 5 stud hubs. Outer spring plate is available separately.

VT No.	Item
20-0300	Kit, 3 Stud
18-8242	Plate, 3 Stud
18-0795	3 Piece Nut Set
20-0332	Polished Outer Plate

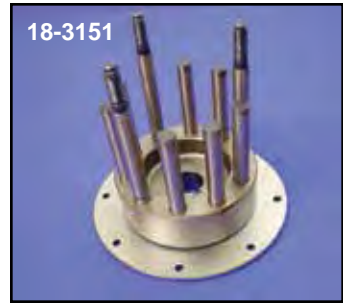
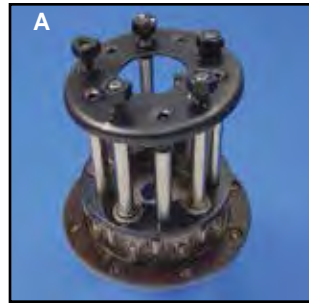
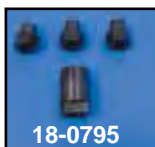

**Big Twin Clutch Hubs** for 1941-84 are available assembled with rollers, liner, top plate and adjusting nuts. They are also available as bare hub only.

VT No.	#	Item
18-3153	A	Complete 3 Stud
18-3154	A	Complete 5 Stud
18-3151*		3 Stud
18-3150*		5 Stud
18-3111	C	Outer Plate 3 Hole, Black
18-3235	C	As Above, Chrome
18-3112	C	Outer Plate 5 Hole, Black
18-3236	C	As Above, Chrome
18-3113	C	Outer Plate 10 Hole, Black
18-1125	B	Hub Liner, Stock with rivets
18-3124	B	Hub Liner, Nyla-tron with rivets
37-8807		Rivets for Liner

\*Note: Sold as bare hubs.

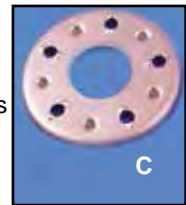
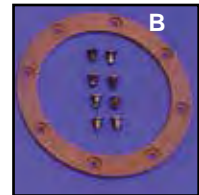

**Big Clutch Hub Hardware Kit** for 1941-84 includes 20 rollers with cage, liner with rivets, retainer springs, outer pressure plate with either 3 or 5 adjusting nuts.

VT No.	Hub Type
18-3638	3 Stud
18-3639	5 Stud



**Sifton Clutch Spring Sets** are heavy duty ten piece sets with red coating.

VT No.	Fits
13-0788	1941-67
13-0789	1968-84
2481-6	Nuts

**Rollers Only.**

20 Pack	100 Pack	OEM	Size
12-0344	12-4590	9540A	Standard
12-0363	12-4591	9541	.0002

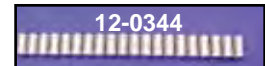

18-3611



**Clutch Stud Nut and Plate Kit** includes slotted nuts, roller retainer plate, outer pressure plate and retainer springs in proper amounts for hubs listed 1941-84.

VT No.	Item
18-3611	3 Stud, Stock
18-3620	5 Stud
18-3621	10 Stud



**Chrome Clutch Spring Set** for use on 1941-84, when exposed on belt drive models. Ten pieces per kit. These are our late style springs with durable chrome finish.

VT No. 13-0200

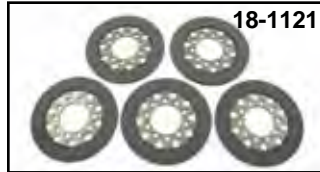

# Clutch Set

**Extreme Duty Police Service Clutch Set** is an original molded fiber over metal replacement clutch set for Big Twins 1936-84. It is superior to stock or competition units in that fiber is integrally molded to plates, not glued on and holds constant thickness under heat. The 1968-84 type is also available bonded to alloy plate for lighter weight. Use steel plate VT No. 18-3652 when installing.

VT No.	Years	Type	Plates	Material
18-1124	1936-67	Steel	3 1/2	Fiber
18-1121	1968-84	Steel	5	Fiber
18-0150	1968-84	Steel	5	Kevlar
18-1122	1968-84	Alloy	5	Fiber

**Steel Plates. Note 18-8301** has smaller lug cut.

VT No.	Style	Year	Brand
18-1129	Smooth	41-84	York
18-8288	Smooth	41-84	Alto
18-8301	Smooth	41-84	York
18-1126	Rattler	41-67	Replica
18-8287	Rattler	41-67	Alto

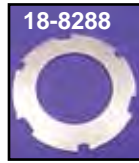

**Kevlar Clutch Kit** for 1941-84 Big Twin includes 5 friction and 4 steel plates.

VT No. 18-0172



**Red Eagle Clutch Set** by Alto is available in fibers and steel. Sold as Kevlar or Red Eagle type. Both are bonded to steel.

VT No.	Year	Type
18-0225	1941-83	Carbonite
18-8277	1941-67	Red Eagle, requires extra steel plate
18-8278	1941-67	Kevlar, requires extra steel plate
18-8279	1968-83	Red Eagle
18-8280	1968-83	Kevlar



**Series K Clutch** performs flawlessly under extreme heat conditions with smooth precise shifting. The steel backing plates have maximum strength and Kevlar friction plate is the most durable friction material made. Fits 1941-83. Note: Made to run wet or dry in a sealed primary. Incidental oil from primary chain will not affect clutch operation. One extra steel plate is required for 1967 and older models. VT No. 18-3667



**Carbon Fiber Clutch Sets** by Barnett features good energy absorption. For wet or dry primary. Fits 1941-83. VT No. 18-3692



**Clutch Short Brass Rivets.** 100 pack.

VT No. 37-8807\*

\*Note: For clutch hub friction disc.



**Clutch Pak-Kit.** Heavy duty factory type for Big Twins.

Complete kit includes our five piece original bonded to steel police clutch or Kevlar friction and four steel plates, clutch hub liner with rivets, and ten springs. VT No. 18-3664 includes 3 1/2 bonded plates and three steel plates with rattlers, springs and hub liner.

VT No.	Item	Year	Type
18-3664	Original Police	1941-67	Dry
18-3644	Original Police	1941-84	Dry
18-3649	Kevlar Fiber	1968-84	Wet/Dry

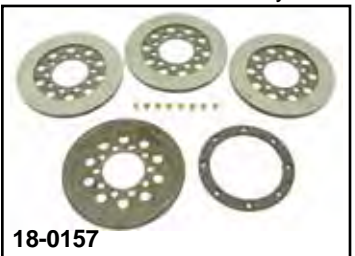

**Replica Dry Clutch 3 1/2 Plate Set** for 1941-67 Big Twin includes linings riveted on with flex grooves in the outer plate. Replaces 37930-41 and 37950-41.

VT No.	Brand
18-0151	Replica
18-0157	VT

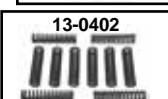

**1936-40 EL Replica Clutch Plate Set** includes two external tooth lined on both sides plates, one external tooth fiber plate, two steel drive internal tooth plates, one spring plate with j-slots, one clutch hub liner with four rivets.

VT No.	OEM	Year	Item
49-1160			Plate Set
12-0626			Hub Nut
2452-2			Adjuster Screw
18-0431	2547-36		Clutch Spring Collar
18-0435	2489-36		Clutch Drive Disc w/Studs
18-0563	2472-36		Clutch Hub w/thrust plate
49-0820	2493-36		Clutch Shell Inner Race
49-0828	2039-36		Clutch Drum Shell w/sprocket
49-0829	2550-36		Clutch Shell with Sprocket
49-0979			Clutch Kit
49-0036			Clutch Drum Kit
13-0402			Spring Set
18-0067			Clutch Hub Bearing Kit







# Clutch Release 4-Speed/Throw-Out



**Late Type Throw-Out Bearing Kit** includes parts pictured to replace stock components on 4-speed Big Twins or as retro fit on earlier models.

Kit	Years	Rod Only
18-3203	1936-64	18-3266
18-3204	1965-69	18-3265
18-3607	1970-85	18-3120



**Throw-Out Bearing** for 1975-up includes two 37313-80 thrust washers, 37312-75 bearing, and retaining ring 11096. Use on all 1975-up Big Twins.

VT No.	Item
18-3623	Kit
12-0342	Bearing Only
12-0923	Retainer, 10 pack
12-0370	Thrust Washer, 5 pack

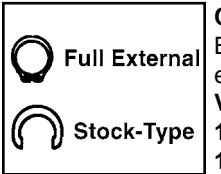

**Clutch Push Rod Snap Ring** for 1975-up Big Twins, replaces 11096 in stock or full external configuration.

VT No.	Type
12-0923	"C" Type, Stock
12-9992	Full External Type



**Early Throw-Out Bearing** replaces 37310-39 on 1936-70 Big Twins in standard or Replica grade quality.

VT No.	Type
18-3121	Standard
18-8229	Replica Grade



**Throw-Out Bearing Conversion Kit** includes clutch pushrod, gasket, throw-out bearing and gear. Converts late bearings to old-style heavy-duty throw-out bearings.

VT No.	Year
18-3608	1941-61
18-3610	1965-69
18-3609	1970-84



**Tamer Clutch Hub Retainer Kit** eliminates all clutch drag and lunging while in gear or while stopped. This kit greatly reduces gear clash, and increases clutch and transmission life by providing a clean and free clutch release. The kit fits all 1941-84 Big Twin with belt or chain drive. Instructions included.

VT No. 18-1112



18-0453



18-0341



18-0871



18-0690

1936-40 EL

18-0341	Finger
18-0452	Arm
18-0690	Throwout Bearing Kit
18-0871	Oil Slinger
18-0453	Kit



**Clutch Release Rebuild** for 1970-84 4-speed Big Twins includes parts shown plus a heavy duty throw out bearing, with matching release finger and shaft.  
VT No. 17-0610



**Heavy-Duty Throw-out Bearing Kit** is for all 4-speed Big Twin models 1970-84. The kit includes a solid throwout bearing of 24 mm diameter (Stock is 17 mm) with larger thrust washers, an oil slinger and small parts.

VT No.	Item
18-3256	Rebuild Kit
18-3247	Bearing 24mm only
18-3624	Slinger Only, Steel
18-3724	Washer Set
18-0261	Bearing Kit



18-3119



18-3120



18-0745

**Clutch Push Rods** are for Big Twin 3 and 4-speed high strength.

VT No.	OEM	Years	Length
18-3117	37285-41	1941-64	13"
18-3118	37285-65	1965-69	13 <sup>1</sup> / <sub>4</sub> "
18-3119	37285-70	1970-75	13 <sup>7</sup> / <sub>8</sub> "
18-3120	37285-75	1975-84	13 <sup>3</sup> / <sub>4</sub> "
18-0745	Replica	1975-84	13 <sup>3</sup> / <sub>4</sub> "



37-1957

37-1955

**Clutch Push Rod Adjuster Kit** includes screw and nut.

VT No.	Type
37-1955	Replica
37-1957	Ball



13-0136

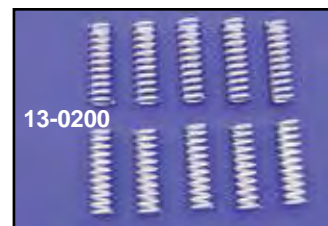

13-0200

**Clutch Spring Sets**

VT No.	Year	Brand
13-0163	1968-84	BTE
13-0172	1941-67	BTE
13-0139	1941-67	York
13-0136	1968-84	York
13-0200	1941-84	Chrome
13-9228	1941-84	BTE



# Clutch Release 4-Speed



**Mousetrap Eliminator Kit** includes bracket, handle, cable, clutch set and springs for 1952-79 Big Twin models.

**VT No. 22-0750**



**Mousetrap Eliminator Soft Pull Conversion Kit** features soft pull by elimination of mousetrap linkage by using the late model cable and shorter arm for 1952-78 Big Twin models.

**20-0304**

- VT No.**    **Item**
- 20-0304**    Kit
- 18-3601**    Short Bracket
- 18-3604**    Short Arm

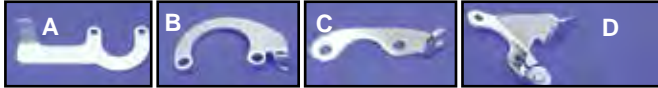

### Clutch Cable Release Brackets.

VT No.	#	OEM	Type	Finish
<b>18-3602</b>	A	Eliminator	Mousetrap	Zinc
<b>18-3601</b>	B	Short	1968-79	Chrome, Bent down
<b>18-8309</b>	C	Short	As Above	Chrome, Bent up
<b>18-3600</b>	D	62576-65A	1965-78	Chrome
<b>18-8252</b>	D	62576-79	1979-84	Chrome

**Note:** A is mousetrap eliminator bracket. It extends out from stock wrap around oil tank on 1936-64, for best results cut and redrill clutch arm 2" shorter. B and C are for 1941-79 models when using 18-3604 arm. D is the stock type which acts as cable bracket and oil tank mount.

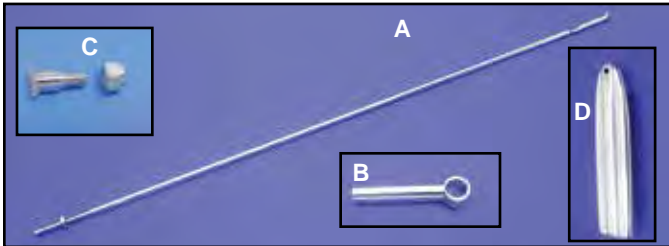

### Clutch Lever Rods And Hardware.

Cad	Chrome	#	OEM	Years	Item
<b>Foot Clutch</b>					
<b>18-0575</b>	Raw		3671-36	1936-51	Rod
<b>18-8302</b>	<b>18-3614</b>	A	36918-36	1936-64	Rod
<b>18-1223</b>	<b>18-3616</b>	A	36917-65	1965-84	Rod
<b>18-8304</b>	<b>18-3617</b>	B	36916-36	1936-65	Rod End
<b>18-0432</b>	—	B	36916-36	1936-39	Rod End
	<b>49-0046</b>		36916-36	1936-73	Rod End, Parkerized
<b>7819-4</b>	<b>21-0205</b>	C	33879-36	All	Rod End Bolt
<b>49-1372</b>	—	B	36916-36	1936-65	Rod End
<b>18-8329</b>	—				Rod End
<b>18-0432</b>	—				Rod End Cad
<b>Mouse Trap</b>					
<b>18-8303</b>	<b>18-3615</b>	A	369 18-52	1952-67	Rod
<b>18-1224</b>	<b>18-3629</b>	A	36918-65	1965-67	Rod
<b>18-8305</b>	<b>18-3633</b>	B	36916-52	1952-67	Rod End
—	<b>42-0302</b>	D	38495-52	1952-67	Cover
<b>9204-3</b>	<b>9203-3</b>	C	36921-52	All	Rod End Bolt



**18-3606**



**18-3627**



**18-3605**



**18-3603**



**18-3604**



**18-3626**



**18-0452**



**18-0850**

### Chrome Clutch Release Levers 1936-84 4-Speed Big Twins.

VT No.	OEM	Year/Type
<b>18-3606</b>	37052-65	1965-78 Aluminum Primary
<b>18-3627</b>	37053-68	1968-Early78 FLH, 1971-Early79 FX
<b>18-3605</b>	37054-79	1979-84 FL, 1979-85 FX
<b>18-3603</b>	37051-36	1936-64 FLH
<b>18-3626</b>	37051-36	As Above Parkerized
<b>18-0452</b>	37051-36	1936-39 Raw UL, EL
<b>18-3604</b>	Eliminator	1936-78 FX, FL
<b>18-0850</b>	Cadmium	1936-39 EL, UL

**Note:** VT No. 18-3606 clears alloy primary on 1965-78 for mousetrap or police jockey clutch. VT No. 18-3604 is for installing a mousetrap eliminator cable on 1936-78, clears wrap around oil tank.



**A**



**B**

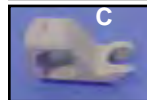

**C**

**D**



**E**

**18-0341**

**Finger Shafts** are for clutch release levers on 1939-84 4-Speed models. Shafts are for early cotter type or late snap ring type.

VT No.	#	OEM	Item
<b>17-0124</b>	A	37074-38	Early shaft cotter type
<b>17-0970</b>			Clutch Release Finger Shaft Kit
<b>17-9827</b>	B	37074-38A	Clutch lever release shaft w/snap ring
<b>18-0341</b>			Finger, 1936-38
<b>17-1509</b>	C	37070-39	Finger, 1939-74
<b>17-1499</b>	D	37070-39B	Finger, 1975-84
<b>12-0900</b>	E	11000	Snap Ring, 10 pack
<b>17-9923</b>			VT Finger Shaft, Short for 43-0107 Kick Cover
<b>12-9918</b>		6443HW	Thrust Washer
<b>12-1158</b>		6320	Lower Washer
<b>16-1800</b>		—	Reamer for Finger Shaft
<b>17-0354</b>			Bushing



**Chrome Cover** dresses up clutch arm on 1936-84 Big Twins. Acorn nut included.  
**VT No. 42-0527**





# Engine Sprocket



**Solid Engine Sprocket Conversion Kit** includes solid splined sprocket, engine nut with lock tab, engine seal spacer and shims. This kit will replace the entire compensator motor sprocket assembly.

VT No.	Fits	Teeth
19-0445	1970-84 FX-FL	22T
19-0423	1970-84 FX-FL	23T
19-0424	1970-84 FX-FL	24T
19-0425	1970-84 FX-FL	25T



**Compensator Sprocket Kit** includes all parts pictured with 24T sprocket. Fits 1970-84 FLH-FXE-FLT-FXR.

VT No. 19-0404

Order spacer and shims separately.

VT No.	OEM	Year	Size	Item
10-0427	24002-70	1970-up		Spacer
10-0428	24032-70	1970-up	.060"	Shim
	24033-70	1970-up	.090"	Shim
	24034-70	1970-up	.120"	Shim
	24035-70	1970-up	.150"	Shim
	24036-70	1970-up	.180"	Shim
Set of 6	24037-70	1970-up	.210"	Shim

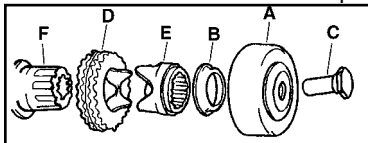

## Compensator Sprocket Parts.

VT No.	#	OEM	Year	Item
19-0071	D	40275-70	Sprocket	1970-84 24 Teeth
19-0070	D	40282-70	Sprocket	1970-84 23 Teeth
19-0116	E	40299-70	Slide cam	1973-83
19-0117	B	40324-70	Cup	1970-83
19-0118	F	40375-70	Extension	1970-85
19-0119	A	40384-70	Retainer and Cover	1970-83
12-0506	C	40392-70	Nut	1970-90



**Sprocket Nut and Lock Tab Set** for 1955-up Big Twins allows locking of nut by utilizing 2 tabs which fit into sprocket holes when non-compensator sprocket is used.

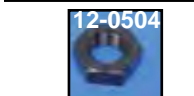

VT No.	Item
17-0945	Kit
12-0504	Nut Only

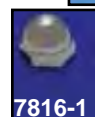

**Acorn Engine Nuts** for all Big Twin.

VT No.	Fits
7107-1	1936-54
7816-1	1955-76



**Chrome Pike Engine Nut** fits Big Twin 1955-up sprocket shaft.

VT No. 37-0890



## 1970-83 Big Twin Compensator Engine Sprockets

VT No.	Teeth	Type
19-0379	22	FLH-FXE
19-0070	23	FLH-FXE
19-0071	24	FLH-FXE



## Big Twin Offset Engine Sprockets with spline.

24T	25T	Offset
19-0135	19-0136	1/4"
19-0103	19-0107	1/2"
19-0104	19-0108	3/4"
19-0105	19-0161	1"
19-0106	19-0162	1 1/4"
17-0945	17-0945	Nut Kit



## Engine Sprockets

Spline	Taper	Teeth
1955-up	1930-54	
19-0050	19-0054	22
19-0051	19-0055	23
	19-0137	23
19-0052	19-0056	24
19-0053	19-0057	25
—	12-0200	Key
17-0945	12-0503	Nut
		Chrome Sprockets.
	19-0492	— 24
	—	19-0075 23



## Taper Sprocket Kits.

19-0138	22T
19-0137	23T
19-0139	24T
19-0140	25T



## Compensator Sprocket Engine Nuts.

VT No.	Year	Type
12-0506	1970-90	Replica
12-1946	1970-90	Chrome

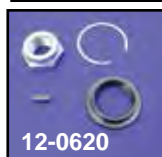

**Engine Sprocket Nut Kit** includes correct nut, key retaining ring and left bearing oil slinger.

Kit	Nut	Fits
12-0620	12-0503	1941-54 Big Twin
12-0619	12-0501	1929-73 45
12-0633		1941-54 Slinger

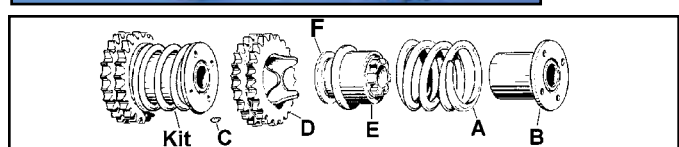

## Compensator Parts for 1955-69 Big Twins.

VT No.	#	OEM	Item
19-0046	Kit	ABCDEF	Complete Kit
13-9238	A	40302-55	Spring
19-0391	B	40385-55	Nut
12-0210	C	40390-54	Key
19-0044	D	40275-55A	24T Sprocket
19-0406	E	40292-55A	Slide Cam
19-0045	F	—	Sprocket Shaft Extension



# Primary Chain Tensioner

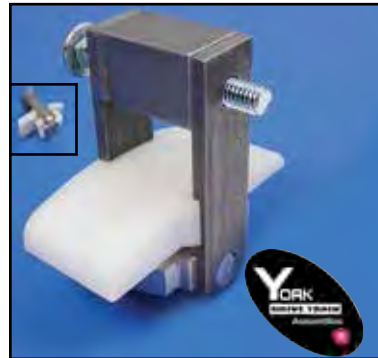

**York Big Twin Hydraulic Primary Chain Tensionator™** features a hydraulic valve which controls the motion of the submerged piston which constantly keeps the chain in tension for 1965-06 Big Twins.  
**VT No. Item**  
**18-0120 Kit**  
**18-0128 Shoe**



**York Chain Adjuster Kits** feature automatic self adjusting by use of spring loaded shoe.

**VT No. Year**  
**18-0580** 1965-00  
**18-0581** 2001-06  
**18-3681** Nylon



**Self Adjusting Chain Tensioner** fits models with wet clutch. The tensioner replaces factory type detent adjuster shoe assembly. Tensioner kit includes all hardware and instructions for complete conversion. Fits 1965-2000.

**VT No. Item**  
**18-0580** Tensioner  
**18-3681** Nylon Pad Only

**Chain Tensioner Parts** fit Big Twin models.

VT No.	#OEM	Type	Year
18-8247	All	Complete Kit	1965-84
18-8314	All	Complete Kit	1985-99
18-3217	B-C-F-G	Hardware Kit	
37-9030	A	1783 Screw, 10 pack	
37-8801	B	3862B Bolt, 5 pack	
18-3682*	C	4401W Hex Bolt, each	
28-0225	E	39976-65B Nylon Pad	1965-00
28-0568	E	— Red Nylon Pad	
17-0915	G	39996-65 Lock, 10 pack	
18-3218	H	39990-65 Shoe Mount Bracket	1965-00
18-3219	F	39993-65 Plate	
18-3622	I	39992-65A Nut and 39998-65 Anchor Plate	
18-3634	J	— Anchor Plate with carriage bolt (K)	
37-8802	K	5444 Carriage Bolt, 5 pack	
18-3223	I	39992-65A Nut Only	

\*Note: Early style hex bolt screws into 18-3223 nut.



**28-0225 Primary Chain Nylon Liners.**



VT No.	OEM	Year	Model
28-0233	39976-65	1965	Big Twin
28-0225	39976-65B	1966-84	Big Twin
28-0568	Red	1966-84	Big Twin

## Installation Instructions

1. Drain oil.
2. Remove the primary cover, the original adjuster shoe with the bracket and the carriage screw.
3. Install the longer carriage screw from the kit into the serrated adjuster pad.
4. Install the inner guide onto the carriage screw. Install the shoe with the springs onto the inner guide and place the outer guide onto the inner guide pins as shown.
5. Position the shoe, springs and guide assembly at the lowest point of possible adjustment on the pad. Install the original carriage screw lock nut and tighten it.
6. The amount of spring exposed from the bottom of the shoe will depend on chain wear. It should be 5/8 inch or less.
7. If more than 5/8 inch exists, raise the bottom of the spring by loosening the nut and raising the assembly for kit 18-0580 or by using shims provided for kit 18-0581. Make this adjustment until 5/8 inch of spring is exposed.
8. Replace the primary cover with a new gasket and fill it with oil to the proper level.

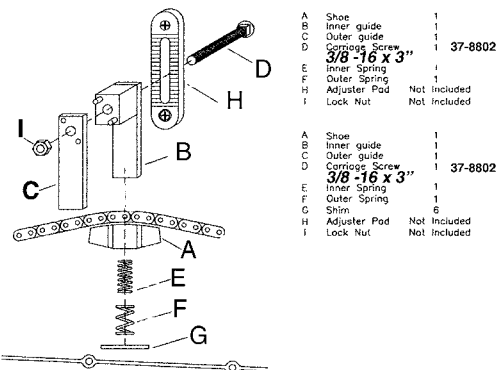





# Primary Chain

## Primary Chain Drive System

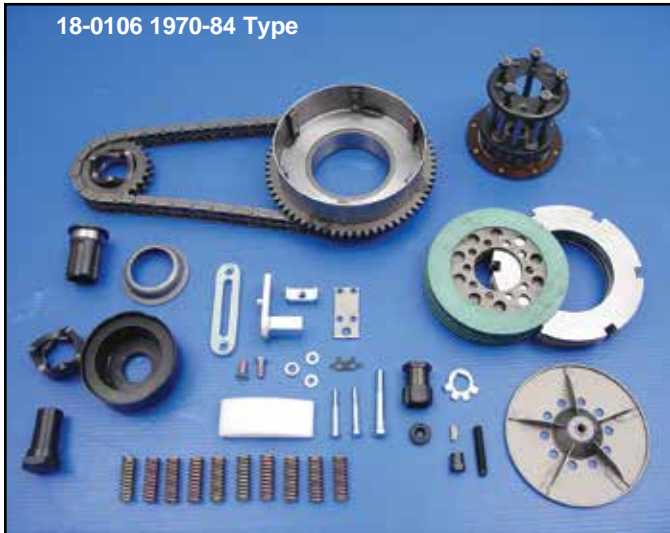

**Primary Chain Drive Systems** for Big Twins include 76 or 82 link primary chain, chain shoe adjuster assembly, clutch drum basket with starter ring gear and steel and fiber clutch plates with pressure plate assembly. Correct front compensator sprocket assembly includes all parts necessary for installation, including sprocket nut. Big Twin 5 Speed Softail models and all pre1985 FLH-FX 4-Speeds require 82 link primary chains; 1980-up FLT-FXR 5-Speeds require 76 link primary chains.

82 Links	76 Links	Year
18-0106*	18-0110*	1970-84
18-0107*	—	1965-69
18-0108*	—	1955-64
18-0117	—	1955-64
18-0109	—	1936-54

\*Note: Units include compensator front sprocket assembly.

## Primary Hardware



**Chain Oil Kit** contains cadmium plated oiler body, 63607-54, oiler adjusting screw, 63610-53, and nut and brass washer used on 1954-62 Panheads.  
**VT No. 2321-4**

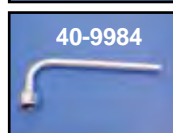
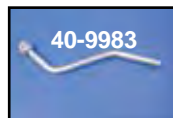
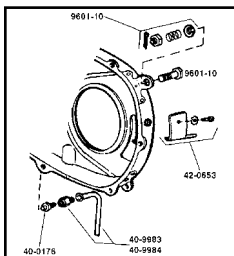

**1954-64 Rear Chain Oiler Kit** for 1954-64 replaces 63591-62 to fit on rear of inner primary cover. Kit includes screw.

VT No.	Item
42-0653	Rear Chain Oiler
40-0176	Oil Fitting
40-9983	Oil Drain 1936-57
40-9984	Oil Drain 1958-64
42-0589	Oil Guard
40-0835	Drain Fitting
10-0835	Oil Tank Fittings



**Replica Primary Chain** features Figure '8' Side Plates for reduced weight on Early models!

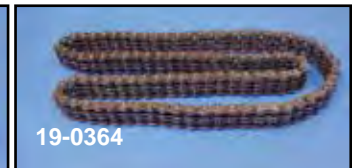

### Diamond Endless Primary Chains.

VT No.	Size	Fits
19-0367	428 x 2 x 82	1936-64 Big Twin 74 and 80, Figure 8
19-0360	428 x 2 x 82	1965-84 Big Twin (Oval)
19-0392	428 x 2 x 80	Special Length
19-0363	35 x 3 x 92	1952-56 K-Model
19-0364	35 x 2 x 96	1938-up Servi-Car
19-0365	35 x 2 x 100	1929-52 Solo
19-0366	428 x 2 x 88	1930-36 VL Side Car
19-0380	428 x 2 x 90	1930-36 VL Solo
19-0361	428 x 2 x 76	1974-06 FLT/FXR



**Primary Chain Connector Links** are sold each for size 428 x 2 chain. Fits all Big Twins.

**VT No. 19-0377**



### TYK Brand Primary Chains.

VT No.	Links	Fits
19-0878	76	1980-06 FLT
19-0876	82	1936-06 FL-FX
19-0877	82	Chrome, Link
19-0934	82	1936-64, Link



### Duckworth Chain

19-0791	80	1941-84 FL, sidecar
---------	----	---------------------



**Chrome Chain Primary Drive** for Kick Start includes chrome 24T motor sprocket, nut, clutch drum, clutch springs, pressure plate and spring plate for splined motors. Fits 1955-84 FL and 1971-84 FX.

VT No.	Fits	Shaft
18-0963	1955-84	Splined
18-0964	1941-54	Tapered



**Drive Chain and Sprocket Spacer Kit** is used for installing extra wide rear tires or wheels on 1973-85 4-Speed FX-FL models. Includes special offset 22T transmission sprocket, machined and chromed rear sprocket spacer-plate and 5 extra long sprocket mount bolts and nylock nuts.

VT No.	Item	Teeth
19-0101	Complete Kit	22
19-0399	Sprocket Only	22
19-0447	Sprocket Only	23
19-0448	Sprocket Only	24

**Rotor Spacers** provide offset when required, with 7/16" bolt holes. Each disc measures 2 1/16" inner diameter with 4 5/16" outside diameter. For 1980-99.

VT No.	Thick	Material
23-0320*	1/16"	Steel
19-0128	3/16"	Steel
19-0452	3/16"	Billet
19-0413	1/4"	Steel
19-0414	5/16"	Steel
19-0412	1/2"	Billet



\*Note: Use when installing flat rotor on 1973-75 Big Twin.



**Rear Chain Tensioner** by LBV reduces chain vibration and frequency of adjustment by utilizing a durable urethane roller which revolves on sealed bearings mounted on chrome anchor plates.

VT No.	Year	Model
19-0431	1973-85	FL-FXE-FXWG
19-0436	Roller only	All

## Trans Sprocket

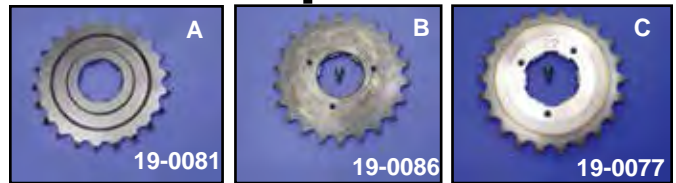

**Big Twin Countershaft Sprockets** machined of durable steel.

# Teeth	1936-79 FL-FX 4-Speed (A)	1980-85 FL-FX 4-Speed (B)	1980-85 FXR-FLT 5-Speed (C)
20	19-0076	—	—
21	19-0080	—	—
22	19-0081	19-0086*	19-0077*
23	19-0082	19-0087*	19-0078*
24	19-0083	19-0088*	19-0079*
25	19-0084	—	19-0100*
26	19-0085	—	—

\*Note: "C" type uses allen screw to lock sprocket nut in place, "B" type use VT No. 17-0905 lock tab and "A" type uses 17-0901 lock tab.



**Drilled-Lightning Counter Sprockets** for 1936-79 Big Twin.

VT No.	Teeth
19-0059	22T
19-0127	28T

## Sprocket Nut



**Lock "N" Seal** includes deflector, lock washer and nut with built-in seal for all 1941-64 74" models.

VT No. 17-9768



**Oil Deflector Main Drive Gear Kit.** Includes all parts pictured to fit 1936-64 3 and 4-Speed models.

VT No.	OEM	Item
17-0204	Kit	All
17-0205	35159-39	Deflector
17-0901	35216-36	Lock Washer, 10 pack
8408-1	35211-36	Lock Nut
12-0515	35211-36	Lock Nut



**Super-Nuts** both have built-in seal for mainshaft surface. Duo-Nut features double action sealing by use of the mainshaft seal and an O-Ring recessed on the back side of nut.

VT No.	Type
17-1498	Super-Nut
17-9759	Duo-Seal Nut
14-0120	Seal Only, 5 pack
14-0685	As Above, James
14-0574	O-Ring



**Oil Deflector Main Drive Gear Kit.** Includes all parts pictured to fit 1936-64 3 and 4-Speed models. Replaces 35211-36 lock nut.

VT No. 17-0204



**Duo-Seal Super Nut Kit** includes a nut with seal and O-ring on back side, with lock tab for 1941-84 Big Twins.

VT No. 17-1490



48-0498  
80" UL



48-0470  
Knucklehead



48-0030  
1340 cc



48-0033  
Dual Cam



48-0025  
Panhead



48-0044  
Shovelhead



48-0048  
Shovelhead



48-0372  
XLCH 1971



48-1824  
45"

**Motor Plaques** measure 18" x 24" and are made of metal.

**Motor Plaque Set** includes 9 plaques. VT No. 48-1811





# Rear Sprocket



1973-84 Big Twin, 1979-81 XL

**Rear Sprockets.** Replace OEM 41470-73. Used on all 1973-86 FX, FXE, FXEF, FXWG, FXST, FL and FLH, 1979-81 Classic, cast or wire wheel. Dish type sprocket with 9.8 mm offset.

Zinc	Chrome	Teeth
—	19-0047	43
—	19-0049	44
—	19-0032	45
19-0048	19-0033	46
19-0034	19-0035	47
—	19-0037	48
—	19-0039	49
19-0040	19-0041	51

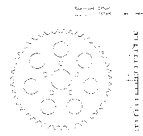

**Note:** Sprocket offset measured from bolt mount surface to center of teeth.

1982-84 FXR with chrome finish. 16mm offset.

VT No.	OEM	Teeth
19-0020	N/A	46
19-0021	40954-81	48
19-0022	40954-83	51



**Chrome 5-Spoke Sprockets.** Offset models have 9.8mm offset.

Offset	Flat	Teeth
1973-99		
19-0672	19-0674	48
19-0673	19-0675	51



**Complete Dowel Pin Sets** are for each specific application.

VT No.	Year	Fitment
19-0110	1930-59	Mechanical and Hyd. Kit
19-0115	1935-52	45 Solo Kit
19-0112	1960-66	Hydraulic Kit
19-0113	1967-72	Hydraulic Kit



**Rivet Set** will cap head of solid steel rivets for 3/8 round head size.

VT No. 16-0709

Offset is measured from bolt hole surface to center line of teeth.

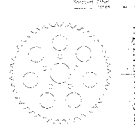

**Chrome Sprockets** have a 6 mm offset.

VT No.	Teeth
19-0042	48
19-0043	51



Flat Sprockets	Teeth
19-0120	48
19-0124	49
19-0121	51



**Chrome Lazer Design Rear Sprockets** with 9.8mm offset for 1973-84 FX-FL or flat.

Offset	Flat	Teeth
19-0129	19-0132	48
19-0130	19-0133	49
19-0131	19-0134	51

**Pulley Spacers** provide offset when required, with 7/16" bolt holes. Each disc measures 2 1/16" inner diameter with 4 9/16" outside diameter. For 1980-99.

VT No.	Thick	Material
23-0320*	1/16"	Steel
19-0128	3/16"	Steel
19-0452	3/16"	Billet
19-0413	1/4"	Steel
19-0414	5/16"	Steel
19-0412	1/2"	Billet
19-2001	5/8"	Billet

**\*Note:** Use when installing flat rotor on 1973-75 Big Twin.



**Rear Sprocket Kits** replacements for brake drums with rivet on sprockets. Includes rivet and dowels.

VT No.	OEM	Teeth	Years	Model
19-0012*	41470-30	51	1930-57	Rigid Big Twin except 1936 OHV
19-0015	41420-30			Dust Ring Rigid Big Twin Zinc
19-0408	As Above			Dust Ring Rigid Big Twin Raw
19-0000	Kit	51	1930-57	Big Twin with ring
19-0001	41470-58	51	1958-61	Big Twin
19-0002	41470-62	51	1962-66	Big Twin
19-0003	41470-67	51	1967-72	Big Twin



**530 Standard Diamond** is the mainstay of the motorcycle chain.

VT No.	Links	VT No.	Links
19-0320	100	19-0327	108
19-0321	102	19-0324	110
19-0322	104	19-0325	112
19-0323	106	19-0326	120



**530 XDL Self Lube** eliminates the possibility of hit and miss lubrication, as it has a constant and consistent lubrication in the pin bushing (wear) area.

VT No.	Link	VT No.	Link
19-0330	100	19-0334	108
19-0331	102	19-0335	110
19-0332	104	19-0336	112
19-0333	106	19-0337	120



**530 XLO Diamond O-Ring Chain** includes a .214 pin which has been produced using a special alloy steel and case hardened for optimum strength.

VT No.	Links	VT No.	Links
19-0354	102	19-0357	110
19-0355	104	19-0358	112
19-0348	106	19-0398	120



**530 Diamond Nickel Plated Chain** offers rust-proof protection along with a nickel finish. Each part of the nickel plated chain is individually plated before assembly Size 50ENP.

VT No.	Links
19-0340	100
19-0341	102
19-0342	104
19-0343	106
19-0344	108
19-0347	120

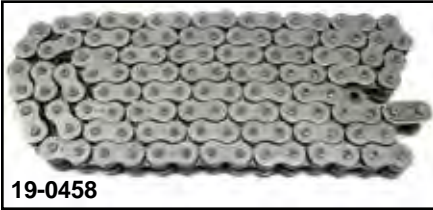
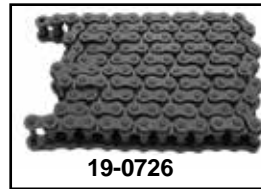

V-Twin Chain is 120 links by 530.

VT No.	Finish	Type
19-0723	Nickel	STD
19-0725	Nickel	STD
19-0726	Parkerized	STD
19-0457	Natural	Heavy Duty
19-0458	Natural	O-Ring
19-0823	Silver	O-Ring
19-0824	Nickel	O-Ring
19-0329	Gold	O-Ring
19-0832	Chrome	Heavy Duty



**"530 QR" Solid Roller Chains** is an economical, high quality, solid roller chain.

QR	Size
19-0512	108
19-0514	112
19-0559	130

# Chain



**530 Sigma O-Ring Chain** with 10,600 lbs. tensile strength, features heavy-duty, wide-waist link plates for increased durability.

Standard S Series	Size	Standard S Series	Size
19-0540	102	19-0545	112
19-0541	104	19-0554	130
19-0542	106	19-0555	150
19-0543	108		



**530 HSL Tsubaki** is a virtually maintenance free chain that has heavy duty shot-peened side plates sintered metal bushings and quad-staked riveting.

HSL	Size
19-0528	110
19-0529	112
19-0530	120
19-0531	Connecting Link



**Diamond Spare Parts Kit** includes two master links, one link and one offset link for all 530 heavy-duty chain. **VT No. 19-0352**

**Master Links.** Replacement link for #50 530 chain. Note: sold in 10 packs unless noted otherwise.

VT No.	Fits Chain Type
19-0350	Standard
19-0351	Nickel
19-0375	XDL Self Lube
19-0353	XLO O-Ring, each
19-0376	N.O.S. Repair Link with 2 Masterlinks OEM, 40052-15

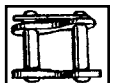

# Rear Sprocket Bolt



Year	Wheel Type		Drive Type		Style	Nuts/Washer	
	Cast	Spoke	Belt	Chain			
<b>FLH-FX-FXST-FLST</b>							
1973-85		8837-10		•	Cap	•	
1973-85		37-8131		•	Hex	•	
1973-98		8834-10		•	Allen	•	
1973-98	8838-10			•	Acorn		•
1973-98	8835-10			•	Allen		•
1973-98	9608-10	9609-15	•	•	Dome	•	•
1973-85		9856-15		•	Collar	•	•
1973-up		8836-10		•	Acorn	•	
1973-up	9857-10				Collar		•
<b>FLT</b>							
1980-84		8836-10		•	Acorn	•	
1980-84		8837-10		•	Cap	•	



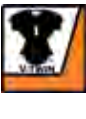

# Belt Drive



**BDL 8mm Belt Drive available** in 1½", 2" and 3" for all 1936-84 Big Twins with 4-Speed Transmission with Kick start on electric start. Can be used with stock type clutch or BDL Competitor Clutch. All 2" and 3" Belt Drives include Big Fix Bearing Kit.

### 1½" Kick Starter only (Open or Closed Primary)

VT No.	Fits	Belt	Front Pulley	Rear Pulley
20-0611	1936-54	20-0102	20-0905	20-0919
20-0612	1955-64	20-0102	20-0906	20-0919
20-0613	1965-78	20-0102	20-0907	20-0919
20-0614	1979-84	20-0102	20-0904	20-0920

### 1½" Kick and Electric Starter (Open or Closed Primary)

20-0615	1965-78	20-0100	20-0904	20-0918
20-0616	1979-84	20-0102	20-0904	20-0918
20-0617	1979-84	20-0100	20-0904	20-0918

### 2" Kick Starter Only (Open Primary)

20-0618	1936-54	20-0104	20-0910	20-0923
20-0619	1955-84	20-0104	20-0911	20-0923

### 3" Kick Starter Only (Open Primary)

20-0620	1936-54	20-0105	20-0912	20-0924
20-0621	1955-84	20-0105	20-0913	20-0924

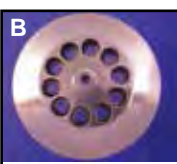

**A-Clutch Dome For Big Twins** is a highly polished clutch dome which gives that finished custom look to our open belt drive units.

VT No.	Type
20-0334	3 Hole, Polished
20-0335	3 Hole, Chrome
20-0339	5 Hole, Polished

**B-Clutch Releasing Disc.** Precision machined aluminum pressure plate for all 1941-84 Big Twin.

20-0332 Polished

**C-Bearing Support** is used when cast aluminum inner primary cover is removed for installation of open belt drive on 1965-84 Big Twin 4 speed, the main shaft requires additional support.

20-0228	Chain type fits with belt front and rear chain drive
20-0227	Belt type, with front and rear belt
12-0313	Bearing for VT No. 20-0228
12-0379	Bearing for VT No. 20-0227

**Note:** No warranty on belts sold when as part of kit or individual replacements.



**BDL 11mm 1½" Belt Drive Fits** 1936-84 4-Speed Big Twin with kick or electric starter and can be used with stock clutch or BDL Competitor Clutch. All 1965-up Drives include idler bearing assembly.

### Kick Starter Only

VT No.	Fits	Belt Pulley	Front Pulley	Rear
20-0622	1936-54	20-0117	20-0908	20-0921
20-0623	1955-64	20-0117	20-0909	20-0921
20-0624	1965-84	20-0117	20-0909	20-0921

### Kick and Electric Starter

20-0625	1965-84	20-0117	20-0909	20-0922
20-0626	1979-84	20-0117	20-0909	20-0922

with Rear Belt Drive

### Electric Start 5-Speed FLT-FXR

20-0633	1979-84	20-0116	—	—
---------	---------	---------	---	---



**BDL Replacement Starter Ring Gear** for 8mm and 11mm 4-Speed belt drives.

### VT No.

20-0933	1½" x 8 mm or 11 mm Belt Drives
20-0965	3" Belt Drives

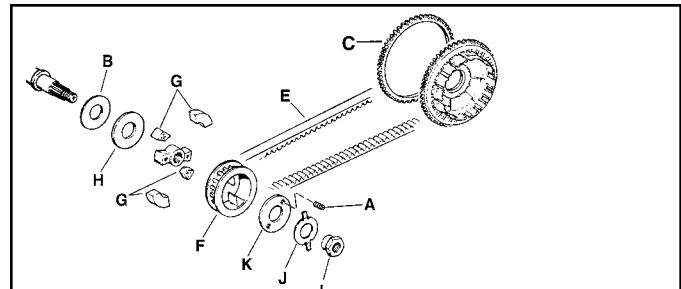

### 1980-83 FXB Belt and Pulley Replacements.

VT No.	OEM	#	Item
20-0309	24051-80	B	Spacer .012
20-0310	24052-80	B	Spacer .023
20-0311	24053-80	B	Spacer .035
20-0312	24054-80	B	Spacer .055
18-1135	33163-65B	C	Ring Gear
20-0453	40009-80	E	Belt Only (Stock)

**Note:** There is no warranty on belts when sold as part of kit or individual replacements.



# 3" BDL Belt Drive



**BDL 3" Electric Start Belt Drives** with biliet motor plate. Includes 8mm belt, polished motor plate, double row sealed mainshaft support bearing, polished side guard, polished dome pulley covers and Kevlar clutch.

**\*Note:** Can only be used with 1991-up starter motor and some modifications will be necessary to install these kits.

VT No.	Fits	Belt	Front Pulley	Rear Pulley
20-0602*	1970-78 FX with Ratchet Lid Transmission	20-0105	20-0901	20-0915

**Note:** There is no warranty on belts when sold as part of kit or individual replacements.



**BDL 8mm x 42mm Electric Start Belt Drives for 4 Speeds.** Includes a polished pressure plate, Kevlar clutch and features a shorter length clutch hub that eliminates unnecessary weight past the end of the mainshaft and can be installed without any modifications to inner primary. Sealed inner primary bearing not included.

VT No.	Fits	Belt	F. Pulley	R. Pulley
20-0609	1970-83 Big Twin with Rear Chain Drive	20-0631	20-0903	20-0917
20-0610	1979-84 Big Twin with Rear Belt Drive	20-0630	20-0902	20-0916
18-0554	Replacement Clutch Pack for Above Units			

**Note:** There is no warranty on belts when sold as part of kit or individual replacements.



**Brute IV Primo 3" Combination Belt Drive/Engine Plate Kits** includes inner motor plate, clutch pack, starter housing and chrome solid belt guard. Order chrome dome cover and rotor cover separately. Engine plate and starter housing have satin finish.

VT No.	Item	Year	Model
20-0020*	Combination Kit	1970-78	FX-FL 4-Speed
20-0105	Replacement Belt for Above		

**\*Note:** Can only be used with 1990-up starter and ratchet lid type transmission.

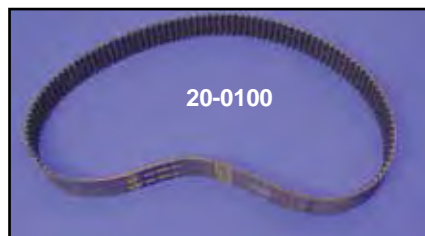
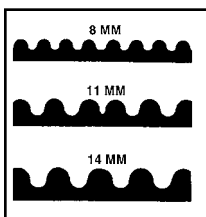

## Primary Belt

### NUMBER OF TEETH

STD	Kevlar	Application	GATES P/N	Belt	F. PULLEY	R. PULLEY	Length
20-0100	20-0200	8mm 1965-78 FL-FX Closed Primary Electric Start	30853-1-ST 1 1/2"	132	41	61	42 1/2"
20-0102	20-0201	8mm 1937-84 FL-FX Closed Primary Kick Electric Start Bulls Eye Belt	30853-2-BE 1 1/2"	132	39, 40, 41	61 or 62	42 1/2" plus
20-0103	20-0202	8mm FL-FX Open 1 1/2" 1937-84 FL-FX	37144 x 1 1/2"	144	47	76	46 1/2"
20-0104	—	8mm FL-FX Open 2" 1937-84 FL-FX	37144 x 2"	144	47	76	46 1/2"
20-0105	20-0204	8mm FL-FX Open 3" 1937-84 FL-FX	37144 x 3"	144	47	76	46 1/2"
20-0115	20-0205	11mm 1937-84 FL-FX Open or Closed Primary Kick or Electric Start	30884 x 1 1/2"	96	29	44	42 1/2"
20-0117	20-0206	11mm 1937-84 FL-FX Open or Closed Primary Kick or Electric Start	1185 x 1 1/2"	99	31	47	43 7/8"
20-0116	20-0207	11mm 1979-84 FLT-FXR Closed Primary Electric Start with 5-Speed Transmission	30991 x 1 1/2"	92	31	47	40 1/2"
20-0106	20-0208	14mm with or w/o Idler Closed 1 1/2" 37-E84 FL-FX	38078D x 1 1/2"	78	24	37	43 1/2" + .035
20-0110	—	14mm Idler Closed 1 1/2" 1979-84 FLT-FXR 5-Speed	30931 x 1 1/2"	72	24	37	40 1/2" —
20-0453	—	FXSB Sturgis	40009-80		78		OEM

**Note:** All belts by Primo, BDL or Karata for drives carry no warranty of any kind, as sold either as individual replacements or complete drive kits.





# Front Pulley



20-0720



20-0498

**Big Twin Drive Pulley** accepts 1.125 or 1.5 wide belts. Front Pulley includes pulley indexing nut seal and seal spacer as required. Fits 1979-84 4-Speed.

**Front**

VT No.	Finish	Tooth
20-0720	Raw	33

**Rear**

20-0452	Silver	70
20-0498	Chrome	70



20-0449

**Final Drive Front Pulleys** available for Big Twin models as supplied by V-Twin or BDL. All BDL pulleys are 1/3 lighter than stock and include nut, lock plate and screws. Stock size pulley noted by \* utilizes 10-24 allen bolt to lock nut.

# of Teeth	V-Twin	BDL
	79-84 BT 4-speed	79-84 BT 4-speed
29		20-0653
30		20-0654
31		20-0655
32		20-0656
33	20-0449*	20-0657*



20-0053

**11MM Early Model Without Idler.** Outer front pulley guides allow 100% belt-to-pulley contact for superior belt tracking. Idler system not required as this unit is for models with adjustable transmissions only, kick starter. The belt is 11mm x 1 1/2" wide.

VT No.	Fits	Replacement Belt
20-0052	1937-54 FL Tapered shaft	20-0117 Open/Closed primary
20-0053	1955-64 FL Splined shaft	20-0117 Open/Closed primary

**11MM Primo 11mm Late Model Belt Drive Kits** converts from chain to belt, ultra smooth and reliable. Fits inside primary case, idler no longer required. Measures 11mm x 1 1/2" wide.

VT No.	Fits	Replacement Belt
20-0050	1965-84 FL-FX Kick start	20-0117
20-0051	1965-84 FL-FX Electric start	20-0117
—	1979-84 FL-FX 5-Speed Electric Start	20-0116

**Note:** There is no warranty on belts when sold as part of kit or individual replacements.



20-0047



**Note:** All belts by Primo, Karata and BDL are manufactured by Gates Rubber. Belts for drives carry no warranty of any kind, as sold either as individual replacements or complete drive kits.

**8MM Closed Closed Primary for 74" and 80"** is designed to fit inside primary cover. Increases horsepower, mileage and quiets engine while retaining stock appearance. Closed Primary. Kick start only 8mm. 1 1/2" belt type.

VT No.	Years	Replacement Belt
20-0047	1978-84	20-0102
20-0010	1965-84	20-0100
20-0499*	1978-84	20-0102

**\*Note:** For models with belt drive.

**8MM Open or Closed Open Or Closed Primary Belt Drive.** Kick starter models only (8mm) 1 1/2" belt type.

VT No.	Fits	Replacement Belt
20-0044	1937-54	20-0102
20-0039	1955-64	20-0102

**8MM Open Open primary belt drive for 74" and 80"** 8mm. These units were designed for competitive use or big inch street engines.

**Note:** All 2" and 3" belt drive units fit adjustable transmission bikes only.

VT No.	Fits	Width	Replacement Belt
20-0040	1937-54	2"	20-0104
20-0041	1955-84	2"	20-0104
20-0042	1937-54	3"	20-0105
20-0043	1955-84	3"	20-0105

# Brute Classic



8mm	Rep. Belt	Year/Type
20-0070*	20-0102	1979-84 Splined w/Rear Belt Drive
18-8325	—	Repl. Clutch Pak for Above Drives



**Alternator Cover Set** includes polished outer housing and chrome rotor cover.  
**VT No. 20-0337**



**Belt Shroud and Side Guard Kit** is for alternator Big Twins with 1½", 2" or 3" open belt drives. The kit includes chrome belt shroud and polished side guard.

VT No.	Item	Fits
20-0251	Kit	Alternator Big Twin
20-0252	Kit	Generator Big Twin
20-0222	Belt Shroud	Generator Big Twin with 3" Drive
20-0220	Belt Shroud	Generator Big Twin with 1½" or 2" Drive



**Frame Mount Kickstand Stop** for use on all open belt drive Big Twin by clamping to frame tube. Cut to desired length.

VT No.	Fits
27-1729	1¾"
27-1656	1"



**Acorn Engine Nuts** for all Big Twins.  
**VT No. Year**  
**7107-1** 1936-54  
**7816-1** 1955-76



**Chrome Pike Motor Nut** fits 1955-up Big Twin sprocket shaft.  
**VT No. 37-0890**



**Equalizer Engine Plate** designed for open primary on all 1970-up cone motors, connects engine and transmission for a rigid unit, when eliminating the inner primary. Alternator cover, engine plate, idler assembly and bearing support sold separately.

VT No.	Item
20-0306	with Idler Slot
20-0307	without Idler Slot

20-0306 Installed



# Belt Drive



**Polished Alternator Cover for Big Twins** is for use on all Cone motors. Designed to protect your alternator, also helps cooling by acting as a heat sink. It has a mounting lug for belt shroud built in. **VT No. 20-0330**



**Chrome Big Twin Alternator Rotor Cover** presses over 1981-up rotors for tight fit.  
**VT No. 20-0216**



**Chrome Alternator Rotor Cover** fits major brand belt drive and open primary set ups. Installs to completely cover the steel alternator rotor.  
**VT No. 20-0238**



**Outside Belt Guide Plate** is for all Primo 8, 11 and 14 mm front pulleys except taper shaft.  
**VT No. 20-0230**



**Sprocket Nut and Lock Tab Set** for 1955-up Big Twin allows locking of nut by utilizing two tabs which fit into sprocket holes when non-compensator sprocket is used.  
**VT No. Item**  
**17-0945** Kit  
**12-0504** Nut Only



**Nerf Bar** is constructed of 1" chrome bar, bolts to left side for primary protection. Fits 1958-84 FL.  
**VT No. 20-0305**



## Primo Replacement Pulley

VT No.	Primo#	Year	Type	Belt
<b>Primo 8mm Front Pulleys 74 and 80 HD</b>				
20-0555	P-39-T	1937-54	Tapered Shaft	1½" Belt (Use with Adjustable Transmissions)
20-0556	P-39-S	1955-64	Splined Shaft	1½" Belt (Use with Adjustable Transmissions)
20-0558	P-41-S	1965-84	Splined Shaft	1½" Belt
20-0559	P-47-T-2	1937-54	Tapered Shaft	2" Belt (Open Installation)
20-0560	P-47-S-2	1955-84	Splined Shaft	2" Belt (Open Installation)
20-0561	P-47-T-3	1937-54	Tapered Shaft	3" Belt (Open Installation)
20-0562	P-47-S-3	1955-84	Splined Shaft	3" Belt (Open Installation)
20-0547	P-47-T-3-N	1937-54	Tapered Shaft	3" Belt (Open Installation) (Laser-Etched)
<b>Primo 8mm Rear Pulleys 74 and 80 HD</b>				
20-0565	P-62-K	1937-64	Rear Pulley	1½" Belt (Kick-Starter only, Closed Primary)
20-0566	P-61-K	1965-84	Rear Pulley	1½" Belt (Kick-Starter only, Closed Primary)
20-0567	P-61-E	1965-84	Rear Pulley	1½" Belt (Electric Starter, Closed Primary, 4-Speed)
20-0569	P-76-2	1937-84	Rear Pulley	2" Belt (Kick-Starter only, Open Primary)
20-0570	P-76-3	1937-84	Rear Pulley	3" Belt (Kick-Starter only, Open Primary)





# Knob



Hand Shifter Knobs with  $\frac{3}{8}$  x 24 thread unless noted.

- | VT No.  | Style   |
|---------|---|
| 21-1936 | Small, Plain, Black                               |
| 21-2011 | Large, Plain, Black                               |
| 21-0694 | Large, World's Fair                               |
| 21-1945 | Small, World's Fair Insert                        |
| 21-1946 | Army Style  |
| 21-1947 | Masonic Style                                     |
| 21-1948 | Purple Heart Style                                |
| 21-0780 | Universal Shifter, brass finish, skull            |
| 21-0762 | Panhead Motor                                     |
| 21-0700 | Flathead Motor                                    |
| 21-0769 | Knucklehead Motor                                 |
| 21-2121 | Brass Skull                                       |
| 21-2015 | Brass Skull (none)                                |
| 21-0650 | Brass Skull, $\frac{7}{16}$ — 20                  |
| 21-0651 | Brass Skull, $\frac{1}{4}$ — 20                   |
| 21-0588 | $\frac{1}{4}$ — 20 and $\frac{3}{8}$ — 24 Adapter |
| 21-0829 | Black Knob with photo insert                      |
| 21-0986 | Police Emblem                                     |
| 21-0763 | Purple Heart Friend                               |
| 21-0966 | Metro Police, Washington, D.C.                    |
| 21-0953 | Shovelhead Motor                                  |
| 21-0965 | Evo Motor   |
| 21-0937 | Dice, Red   |
| 21-0938 | Dice, White                                       |
| 21-0939 | Dice, Black                                       |
| 21-0832 | Large Temperature Gauge                           |
| 21-0924 | Temperature Gauge                                 |



21-0937 Installed



49-0364



21-0963



**Billet Shifter Assembly** fits 1948-85 FL.  
VT No. 21-0259



22-0738

1936 Style Knucklehead Shifter Parts.

- | VT No.  | Item  |
|---------|-------|
| 49-0364 | Gate  |
| 21-0963 | Lever |
| 22-0738 | Kit   |

YouTube



Watch Our Video!  
<http://www.youtube.com/user/TeddCycle>



Tank Shift Lever



# Brake



### Clutch and Brake Pad Set.

**VT No. Color Item**

**28-0301** Black 3 Piece

**28-0302** White 3 Piece

**28-0551\*** Black 1 Piece \*Note: Oval Pad only

**28-0312** Black 3 Piece, Replica

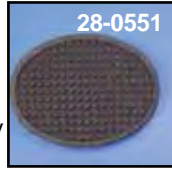

**Rocker Clutch Pedal Pads.** Cast original style with nickel plating.

**VT No. Type**

**49-1921** Toe

**49-1923** Three Piece Set



**Replica Rubber Pedal Set.** Original "Beck" design from the 1940's three piece set fits brake pedal and rocker clutch.

**VT No. 28-0986**



**21-0934**



**21-0932**



**22-0654 Installed**

**Jockey Pedal Assembly.** Original "LEE" styling. Chrome jockey pedal mounts to OE style rocker clutch bracket. Available separately.

**VT No. Brand**

**21-0934** Paughco

**21-0932** Lee Style

**22-0654** Lee Kit



**21-0697**

### Red Baron Cross Shifter Knob

is machined of billet with natural finish.

**VT No. Thread**

**21-0697** 3/8 — 24

**21-0703** 7/16 — 20



# Slap Sticks™



**21-0306**



**21-0125**



**21-0305**

**VT No. 21-0125 Installed**

### Jockey Handle Only.

Order knob separately.

**VT No. Year Type**

**21-0306** 1952-78 Ratchet

**21-1987** Stainless screws for VT No. 21-0306

**21-1997** Chrome screws for VT No. 21-0306

**21-0125** 1979-84 Rotary

**21-0305** 1936-51 Jockey

**Speed**

4

4

3-4





# Foot Clutch Kit

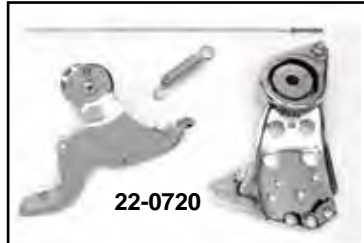

Rocker Clutch Kit does not include clutch rod.

Chrome	Black	Year
22-0720	22-1016	1936-84
Chrome	Parkerized	Year
	22-0565	1936
22-1676	22-0997	1939-40
	22-0565	1936 Type
22-1678	22-1675	1936-38

Note: Clutch is released with pedal in forward position.



### Components.

VT No.	Item
49-0471	Pedal, 1936-38
49-0472	Bracket, 1938-40
49-0476	Bracket, 1936-37

Note: Clutch is released with pedal in forward position.

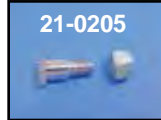

### Rocker Clutch Lever Rod and End.

Cadmium	Chrome	OEM #	Years	Item
18-8302	18-3614	36918-36	1936-64	Rod
18-1223	18-3616	36917-65	1965-84	Rod
18-8304	18-3617	36916-36	1936-up	End
49-0046		36916-36	1936-73	End, Parkerized
7819-4	21-0205	33879-36	1936-84	Bolt

### Clutch Lever Rods And Hardware.

Cad	Chrome	#	OEM	Years	Item
<b>Foot Clutch</b>					
18-0575	Cadmium		3671-36	1936-51	Rod
18-8302	18-3614	A	36918-36	1936-64	Rod
18-1223	18-3616	A	36917-65	1965-84	Rod
18-8304	18-3617	B	36916-36	1936-up	Rod End
7819-4	21-0205	C	33879-36	All	Rod End Bolt
18-8329	—				Rod End
18-0432	—				Rod End

Jiffy Stand or Shifter Mount Plate Bolt Kit to attach assembly to left side of frame. Fits 1936-99.

VT No.	Finish	Type
9617-18	Chrome	Hex for Mount Plate
9617-18T	Chrome	Hex
9618-18	Cadmium	Hex for Mount Plate
9619-18	Parkerized	Hex for Mount Plate
9619-18T	Parkerized	Hex for Mount Plate

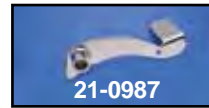
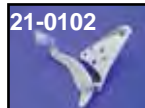

Jockey Parts for all Big Twins with ratchet or jockey top.

VT No.	Item
21-0102	Pedal and plate
21-0103	Pedal only
21-0987	Pedal only
21-0104	Plate only
21-2023	Rod End
21-0934	Pedal and Plate



Rocker Clutch Cable Adapter fits all rocker clutch assemblies when fitted with a clutch cable. Fits 1941-85. VT No. 22-0341



# Jockey Clutch Assembly

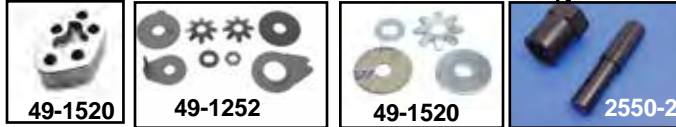
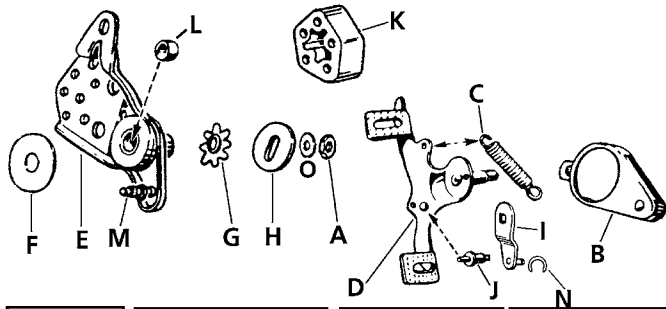

Bushing  
Installation  
Tool  
VT No. 2550-2



VT No. 22-0703 Installed



VT No. 22-0705 Installed



22-0703



22-0590



22-0705



21-0163



21-0163  
Installed

## Components.

VT No.	#	OEM	Item
9617-18	—	—	Bolt Mt Kit, Chrome
9618-18	—	—	Bolt Mt Kit, Cadmium
9619-18	—	—	Bolt Mt Kit, Parkerized
37-8959	A	—	Nut, Zinc
37-0732	A	—	Nut, Parkerized
49-0664	—	—	Cover, 1936-38
21-0316	B	36830-36	Cover, Chrome
49-2597	B	36830-36	Cover, Black
49-1506	—	—	Cover, Stainless Steel
49-0664	—	—	Cover, Black
13-0946	—	2412-36	Spring, Parkerized
13-0962	C	36880-36	Spring, Parkerized
13-0135	C	36880-36	Spring, Parkerized
13-0170	C	36880-36	Spring, Chrome
2350-2	—	1942-64	Pedal, Stud
2351-2	—	1936-39	Pedal, Stud
49-0146	D	36811-65	Pedal, Black
49-2528	D	—	Pedal, Chrome
49-0125	E	36842-41	Bracket, Black
49-2529	E	36842-41	Bracket, Chrome
49-1520	F, G, H, O	—	Friction Parts Kit
49-1252	—	—	Friction Kit, Eight Piece
49-0935	—	—	Friction Kit
49-0145	I	36816-65A	Rod Lever, Chrome
2482-3	J	36866-41	Foot Lever Pin
2544-1	—	—	Spacer Stud, 1936-39 Big Twin
21-0313	K	36869-70	Spacer Block
37-8937	G	36906-36	Spring Washer, 5 pack
37-8938	H	36913-41	Shaft Washer, 5 pack
37-8939	F	36899-41	Friction Disc, 5 pack
10-2508	L	36857-36	Bushing
2353-2	M	30871-40	Spring Stud
12-0907	N	11037	Snap Ring
37-8954	O	36909-36	Washer
49-0031	D	36811-65	Clutch Pedal, Parkerized



49-1519



49-0831

Friction Kit fits 1936-38 EL and 1936-40 W. Kit includes spring.

## VT No. Fits

49-1519	1936-38 EL
49-0831	1941-52 WL

**Slap Stick Jockey Kit** includes assembly with jockey handle for 4 Speed 1952-78 ratchet top Big Twin models. VT No. 22-0705 and 22-0735; 1979-84 is for rotary tops and include handle, cable and rocker clutch, spacer, and front and rear brackets to attach the jockey cable. VT No. 21-0163 includes cable and two brackets for use with a billet shifter assembly such as 22-0755.

VT No.	Item	Speed	Year	Type	Style	Type
22-0703*	Kit	4	1952-78	Ratchet	Slap	Pedal
22-0590	Kit	4	1952-78	Ratchet	Slap	Rocker
22-0705	Kit	4	1979-84	Rotary	Slap	Rocker
21-0163	Kit	—	1979-84	Rotary	—	—
21-0125	Handle	—	1979-84	Rotary	—	—
21-0313	Spacer Block	—	1965-84	—	—	—

\*Note: 1965-78 requires spacer block 21-0313





# Police Style Jockey Shifter

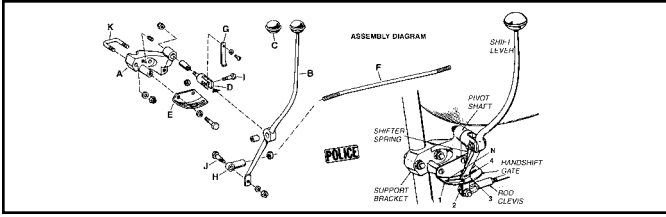

## Police Jockey Shifter Hardware List

VT No.	#	OEM	Item
43-0124	A	33631-66	Support Bracket, Alloy
21-1988	B	33676-66	Shifter Lever, 3 and 5 Gallon
21-1936	C	33745-31	Shifter Ball, Small
21-2011	C		Shifter Ball, Large
21-1992	D	33776-66	Pivot Shaft
21-1990	E	33789-66	Guide 4 Speed
21-1991	E		Guide 4 and 5 Speed
21-1935	F	33857-52	3 and 4 Speed Reverse Rod
21-1994	F		Shifter Rod, Ratchet Top
21-2044	F	33857-66	Shifter Rod, 3 Speed and Reverse
21-1993	G	33865-66A	Spring, Shifter Lever
21-0204	H	33870-51	Shifter Rod, End
21-1995	I	33875-66	Shoulder Bolt, Lever
21-0205	J	33879-36	Shoulder Bolt, Rod End
21-0315	K	38460-52	U Bolt, Bracket
23-0421		42269-30	Clevis Pins, 10 pack
21-0962			Shifter Mount Bracket
21-0878			Shifter Support Bracket, Alloy
21-0989			Police Shifter Lever Assembly, Chrome
21-0990			Jockey Shift U-Bolt
21-0231	1941-64		Rod End, Zinc



22-0712 Installed



22-0712



22-0711 Installed

**Police Style Jockey Shifter Kit** clamps to all Big Twin front frame tubes. VT No. 22-0711 features a smooth gate for shifting. Use either rocker clutch pedal or jockey pedal for operating clutch.

VT No.	Year	Fits	Model
22-0710	1936-79 only	Handshift	All
22-0711	1952-79 Big Twin	Ratchet Top	FX-FLH
	1979-84	Rotary Top	FLH
22-0712	1979-84	Rotary Top	FL-FXE
22-0737	1979-84	Rotary Top	3.5

# Police



50-1541



48-1981

**Police Fender Marker Plate** fits 1936-84 45" and Big Twins. Order decal set separately.

VT No.	Item
50-1530	Marker Plate
48-1981	Decal Set
50-1541	Set



50-1530



39-0932

**Police Special Speedometers** feature black face with white numerals and needle.

39-0671	1:1	0-120 MPH
39-0932	2:1	0-120 MPH
39-0327	2:1	10-100 MPH
39-0862	2:1	10-100 MPH
39-0303	1:1	10-100 MPH
39-0322	1:1	0-120 MPH
39-0375	2240:60	0-120 MPH, 1980-84 FLH
39-0864	2:1	0-100 MPH, Police
39-0857	1:1	0-100 MPH, Police

**Police Siren Complete Units** include brackets for units.

VT No.	Fits	Cover Wheel
49-0390	1973-84 FL	Rear
49-0391	1949-52 W	Rear
49-0392	1958-72 FL	Rear
49-0400	1941-57 FL	Rear
49-0406	1936-84 All	Front



49-0390



49-0391



49-0392



49-0400



# Big Twin Handshift

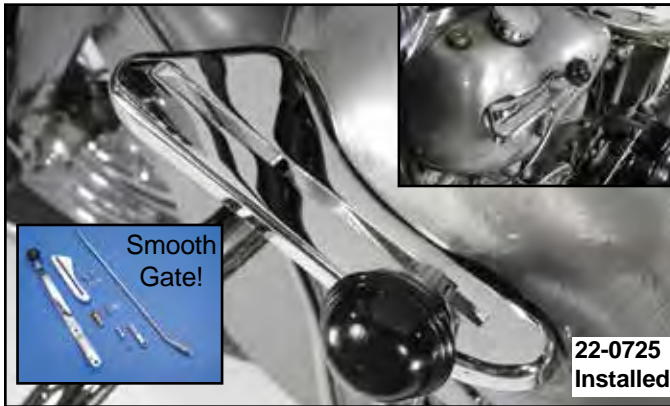

Smooth Gate!  
22-0725 Installed



22-0722 Installed

**Chrome 4 Speed Ratchet Top Tank Shifter Kit** features smooth gate, handle and rod and pivot bolt for 3.5 gallon tanks for years listed.

VT No.	Years
22-0725	1947-64
22-0722	1936-46



21-0905



22-1077

**Shifter Lever Kit** includes correct gate, rod, end, pivot bolt and shifter lever. Chrome shifter lever fits Big Twin for left side mounting. Note: Pattern from front to rear.

VT No.	Year	Item	Pattern
22-1077	1937-46	4-Speed	1N234
21-0907	1947-50	4-Speed with hook	432N1
21-0905	1951-65	4-Speed	432N1
22-1078	1947-65	3-Speed and Reverse	32N1R
49-0101	—	Smooth Gate	

### Parts Available Separately

VT No.	OEM	Year	Item
21-1938	33675-37A	1938-73	Chrome Lever
21-0157	33675-37C	1965-73	Chrome Lever
21-0187	33675-37	1936-46	Chrome Lever
21-1937	33675-37A	1938-73	Painted Lever
21-0963	—	1936	Chrome
7818-5	33775-37	1938-73	Pivot Bolt Kit
7818-5T	33775-37	1938-73	Pivot Bolt Kit
21-1944	—	—	Chrome Lever



7818-5

**Shifter Lever Stud And Bushing Kit** contains necessary hardware required to mount shifter lever on Twins with handshift. Spring steel wave washer is furnished to help prevent rattles.

VT No.	Year	Finish
7818-5	1947-65	Cadmium
7818-5T	1947-65	Zinc
9711-5	1947-65	Parkerized
9711-5T	1947-65	Parkerized
9018-5	1947-65	Chrome
2582-3	1938-46	Parkerized
2581-6	1937-38	Cadmium

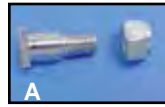

**Hand Shifter Rods** for stock style. Order end separately.

VT No.	#	OEM	Years	Type
21-0205	A	33879-36	1936-79	Shoulder Bolt
7819-4	A	33879-36	1936-79	As Above, Cadmium
9706-4	A	33879-36	1936-79	As Above, Parkerized
21-0204	B	33871-67	All	Rod End, Chrome
21-0231	—	—	1941-64	Rod End, Zinc
21-2070	As Above	As Above	All	Parkerized
21-2075	As Above	As Above	All	Cadmium
21-1940	C	33857-36	1936-50	Big Twin with hook end, Cadmium
21-2046	As Above	As Above	—	Chrome
21-1935	D	33857-51	1951-79	Big Twin, Cadmium
21-1951	—	33857-51	1951-79	Big Twin, Chrome
21-2044	—	33857-66	1951-79	Chrome
21-0723	—	—	8.25"	Chrome



49-0364



49-0107



49-0073

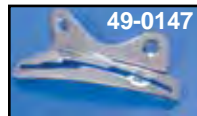

49-0147



49-0076



8212-3

**1940-46 Shifter Gates** for 61, 74" and 80" models. Pattern is noted from top to bottom.

VT No.	OEM	Speed	Type	Top to Bottom
49-0364	2209-36	4 Speed	1936 Chrome	1N234
49-0107	33785-40	3 Speed	Black	1N23
49-0073	33790-39	3 Speed	Chrome	1N23
49-0147	33791-39	3 & R	Chrome	R1N23
49-0076	33789-37	4 Speed	Chrome	1N234
8212-3	33822-36	3 & 4	Gate screws (3) Chrome	
37-9026	—	—	Screw Set	



49-0111

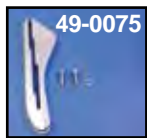

49-0075



49-0074



49-2569

**Shifter Gates** for late type Big Twin.

VT No.	OEM	Fits	Speed	Pattern
49-0111	33791-47	1947-65 FL & 1947-48 EL	3	32NIR
49-0075	33789-47	1947-66 FL, 1937-41 UL	4	432N1



**Slotted Oval Head Screws** are 5/16-24 x 23/32 long. to fit various applications such as stock air cleaner and tank shifter guide and replaces 33822-36.

VT No.	Type
8212-3	Chrome
9710-3	Parkerized
37-9026	Chrome (2)



21-0925

**Forward Shifter Tank Kit** includes chrome gate, lever and arm for 1936-46, 4 Speed model EL and FL.

VT No.	Item
21-0925	Kit
21-0945	Gate
21-0978	Gate, brass 4 speed
21-0893	Gate, 3 speed
21-0216	Arm
17-0504	Inner Arm





# Forward Shifter Kit

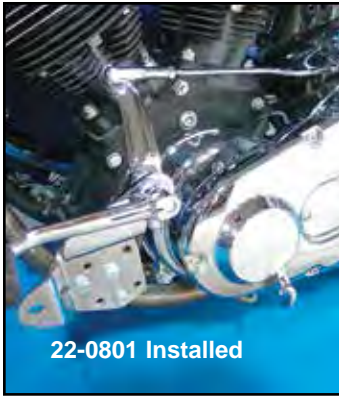

22-0801 Installed



22-0801

1952-78 FLH Type



22-0802

**FLH-FXWG-FXST Forward Shifter Control** is for 1979-84 FLH-FXWG with down turn shifter arm. It does not include the ratchet arm and dust cover. Also, it can be used on ratchet top 4-speed 1952-79 models, when it is not desired to remove the arm and dust cover.

**VT No. 22-0802**

**No Mix-Ups No Searching One Kit Does It All For Less!**

Shifter kit on this page is compatible with VT No. 22-0500, 22-0501, 22-0505, 22-0506, 22-0510 and 22-0512.

**Note:** FLH models 1979-83 rotary trans tops have the down turned shifter top arm. Check motorcycle or your factory parts book for correct application.



22-0802



22-1055



22-1015

**Original Forward Shifter Control Kit.** FLH type allows the use of foot pegs or footboards. Order complimenting forward brake control on opposite page. Units allow 1 down and 3 up shifting pattern. The 22-0801 and 22-1055 kits include proper ratchet arm and dust cover. All other kits attach to existing components on shifter mechanism. Instructions and diagram are included with each kit. Kit is display packaged!

VT No.	Fits	Speed
22-0801	1952-79 FL-FLH	4
	1971-76 FX-FXE	4
22-0802	1979-up FLH	4
	1980-85 FXWG	4
	1985-FXST	4
22-1055	1974-78 FXE	4
22-1015	1979-99 FX-FXE	4
	1981-99 FXR	5

## Replica Foot Shifter



22-0805

**Replica Foot Shifter Kit** for 1952-69 Big Twin includes black bracket, cadmium rod assembly, zinc inner arm, chrome cover, and shifter lever.

**VT No. 22-0805**



21-0208

**Replica Foot Shifter Kit** for 1970-84

Big Twin includes chrome bracket and cover and chrome rod assembly. Order chrome ratchet drum cover kit for 1970-Early 79 models only.

VT No.	Fits
22-0809	1970-84
21-0208	Drum Cover Kit



22-0805



# Forward Shifter Kit

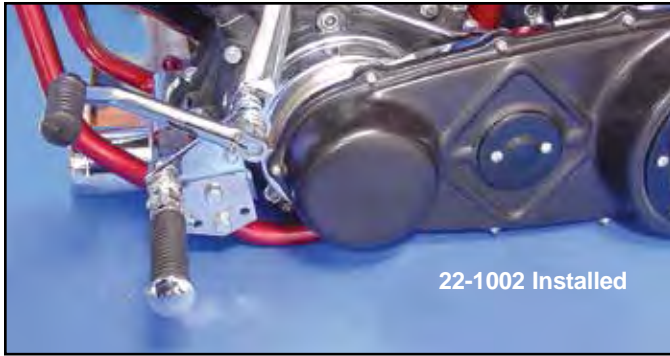

**Softtail Style Replica Forward Shifter Kit** is complete with all hardware necessary for installation on 1952-84 4-speed. Use in conjunction with our FXST replica controls listed, as all kits place pegs in a forward position. Foot rests on peg while shifting for added comfort. This is an exact stock replacement in chrome for 1980-85 FXWG. Kit includes chrome heavy duty shifter bracket, inner lever, shifter lever, rod, rubber shift peg and foot peg, all which is display packaged and labeled with detailed instructions and assembly diagram for each model listed below.

VT No.	Fits
<b>22-1002</b>	1952-78 FLH Ratchet Top 4-Speed 1971-73 FX-FXE
<b>22-1056</b>	1974-78 FX-FXE Ratchet Top 4-Speed
<b>22-1003</b>	1979-84 FLH-FXWG-FXST Rotary Top 4-Speed
<b>22-1004</b>	1979-84 FXE Rotary Top 4-Speed 1981-99 5-Speed FXR-FXS-FXRS



# Mousetrap Kit



**Mousetrap Installed**

**Mousetrap Booster Assembly** includes all parts as shown, chrome cover, chrome spring, zinc plated arm, natural finished aluminum bracket, cable and handle assembly, for use on foot shifter models 1952-67.

**VT No. 22-0702**

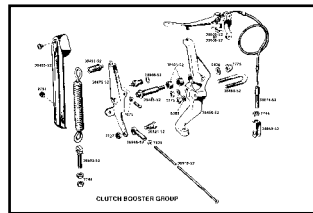

**Component List for VT No. 22-0702 Mousetrap Clutch Booster Assembly.**

VT No.	OEM	Finish	Item
18-3633	36916-52	Chrome	Rod End
18-3615	36918-52	Chrome	Pull Rod
21-2026	36921-52	Zinc	Rod End Bolt
21-2076	36921-52	Chrome	Rod End Bolt
9203-3	36921-52	Chrome	Rod End Bolt
9204-3	36921-52	Cadmium	Rod End Bolt
43-0122	38456-52	Aluminum	Booster Bracket
21-0315	38460-52	Zinc	U Clamp, each
2705-5		Chrome	U Clamp Kit
2705-5		Cadmium	U Clamp Kit
43-0123	38472-52	Zinc	Bell Crank
42-0302	38495-52	Chrome	Spring Cover
13-0143	38498-52	Chrome	Booster Spring
13-0142	38498-52	Black	Booster Spring
21-0312	38502-52	Zinc	Eye Bolt
12-0330	38505-52	Each	Needle Bearing
36-0400	38618-52	Complete	Cable
36-0688	36668-92	Replica	Cable
26-0526	45002-65	Polish	Handle Assembly, 1965-68
26-2127	45002-41	Chrome	Handle Assembly, 1952-64
26-2126	45002-41	Polish	Handle Assembly, 1952-64

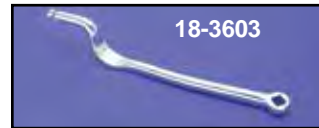

**Mousetrap Clutch Release Levers** for 1936-78 Big Twin with ratchet top.

VT No.	OEM	Year
<b>18-3603</b>	37051-36	1936-64 with tin primary
<b>18-3626</b>	37051-36	As Above Parkerized
<b>18-3606</b>	37052-65	1965-78 with aluminum covers

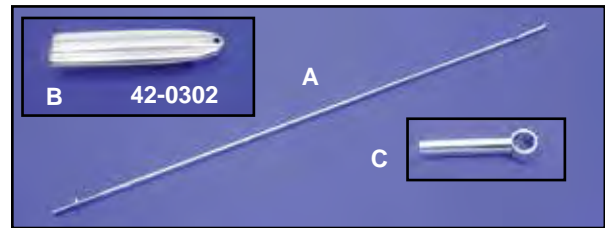

**Clutch Lever Rods and Hardware** for mousetrap.

Cadmium	Chrome	#	OEM	Years	Item
<b>18-8303</b>	<b>18-3615</b>	A	36918-52	1952-65	Rod
—	<b>18-3629</b>	A	36918-65	1965-67	Rod
<b>18-8305</b>	<b>18-3633</b>	C	36916-52	1952-67	Rod End
—	<b>42-0302</b>	B	38495-52	1952-67	Cover



**Mousetrap Cables** are stock length and fit 1952-65.

VT No.	Type
<b>36-0400</b>	VT
<b>36-0688</b>	Replica





# Shifter Lever

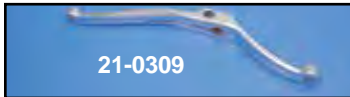
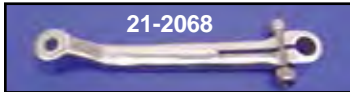

**Chrome Shift Lever** for Big Twin Models.

VT No.	Fits	Type
21-2013	1952-84 FLH, not threaded	Stock
21-0311	As Above, Spline	Stock
21-2068	As Above, Stainless Steel	Stock
21-0308	1952-84 FLH	Heel Toe
21-0309	1952-84 FLH Spline	Heel Toe
21-0302	1974-85 FXE Spline	Stock

# Shifter Linkage

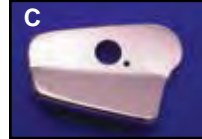
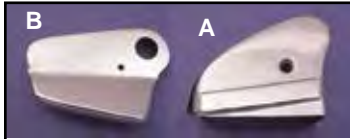

**Chrome Replica Foot Shifter Lever Cover** for Big Twin.

VT No.	#	Fits
42-0320	A	1952-64 FL
42-0319	B	1965-84 FLH
42-0661	C	1971-73 FX only



**FX-FXE Shifter Linkage** replaces 34614-74 on

1974-84 4 Speed models. Features adjustment at both ends. Cadmium finish.

VT No.	Type
21-2021	Assembly
17-9781	Right Thread end only



**Chrome Cover Shifter Lever** replaces 60400-74. Use on all 1974-up FX models except FXWG and FXR. VT No. 42-0324

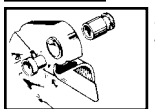

**Shifter Bracket Bushing**

VT No.	Fits
10-2502	1952-69 Big Twin
10-2511	1970-84 Big Twin



**Forked Rod End Clevis** is threaded  $\frac{5}{16}$  — 24 for use on shifter or brake rods.

VT No.	Pin Size	Finish
21-2033	$\frac{1}{4}$	Chrome
49-3065	$\frac{5}{16}$	Chrome



**Clevis Pins**, zinc plated includes cotter pins and washers, sold in 10 pack.

VT No.	Use
23-0421	1930-69 Brake, 1982-up Brake
21-1986	1952-84 Shifter
	1970-81 Brake



**Chrome Shift Shaft Cover** has  $\frac{1}{2}$ " inner diameter to fit over unused shifter shaft in primary cover when installing forward controls, sold each.

VT No.	Type
37-8872	Acorn
44-0047	Dome



**Shifter Rod Linkage** is available as a complete rod, end and shoulder bolt, or separately, chrome.

VT No.	#	Item	Finish
21-0207	A	Rod Kit complete	Chrome
21-0226	A	2" Rod Kit complete	Chrome
21-0212	A	As Above	Cadmium
21-0230		Shifter Rod Extended 4" fits 1958-78 Big Twin	Chrome
21-0205	B	Shoulder Bolt and Nut	Chrome
9103-4	B	Shoulder Bolt and Nut	Chrome
9706-4	B	As Above	Parkerized
7819-4	B	As Above	Cadmium
21-0213	B	As Above	Cadmium
21-0204	C	Rod End Lolly-Pop	Chrome
21-0231		Rod End Kit	Zinc
21-2070	C	As above	Parkerized
21-2075	C	As above	Cadmium
23-0421		Clevis Pin	Zinc

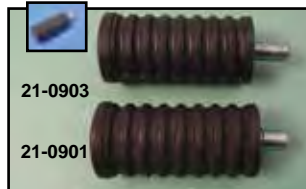

**Stock Rubber Shifter Pegs** are long or short stud. The  $\frac{7}{8}$ " long stud is used when the lever is unthreaded and stud accepts a nut. Short  $\frac{5}{8}$ " threaded screws into lever. Includes a 10 pack of 5 long and 5 short.

VT No.	Color	Type
21-0901	Black	Short
21-0317	Black	10 pack
21-0902	White	Short
21-0903	Black	Long
21-0904	White	Long
21-0908	Black	X-Long

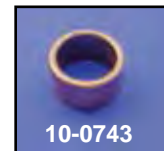

**Inner Shifter Arms** are splined and fit through primary cover on 1974-84 FX 4-Speed, have linkage through front primary cover.

VT No.	Year	Model	Item
17-9756	1974-Early79	FX-FXE	Lever
17-9757	1979-84	FX-FXE	Lever
17-9769	1982-84	FXR	Lever
10-0743	1974-84	FX	Bushing
12-0905	1974-84	FX	Snap Ring

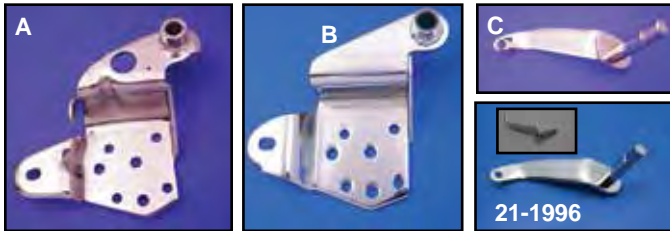

**Frame Mount Shifter Brackets** as stock replacements or when installing forward controls. VT No. 21-2030 and 21-2029 include bushing and zerk grease fitting in stock configuration. VT No. 21-0100 is our original heavy duty bracket constructed of 7mm steel. Order inner shift arm separately.

VT No.	#	Finish	Style	Fits
21-2029	A	Chrome	Stock	1970-84 FLH
21-2030	A	Zinc	Stock	1970-84 FLH
21-0100	B	Chrome	Heavy	1952-84 FLH
21-0877	B	Black		1952-84 FLH
21-0485	B	Zinc	Heavy	1952-84 FLH
21-0120	C	Chrome	Smooth	Inner Arm
21-1996	C	Chrome	Splined	Inner Arm

**Jiffy Stand or Shifter Mount Plate Bolt Kit** to attach assembly to left side of frame. Fits 1936-99.

VT No.	Finish	Type
9617-18	Chrome	Hex for Mount Plate
9618-18	Cadmium	Hex for Mount Plate
9619-18	Parkerized	Hex for Mount Plate
9619-18T	Parkerized	Hex for Mount Plate



**V-Twin Shifter Washer Set** includes 5 large and 5 small nylon washers to reduce vibration at inner shifter arm and pedal. Sold as a 10 pack.  
VT No. 37-9104

## Shifter Bracket



**1952-69 Shifter Bracket.** Stock type, accepts 42-0320 cover, replaces 33630-52. Arm and inner levers are non-splined.

VT No.	Item	Finish	Finish
21-2064	Bracket		Zinc
21-2071	Inner Arm		Chrome
21-2073	Inner Arm		Zinc
21-2072	Heel Toe Arm		Chrome
21-2080	Heel Toe Arm		Zinc
21-2013	Shifter Arm		Chrome
21-0568	Heel-Toe Set		Chrome
12-0905	Snap Ring		

## Ratchet Shifter Levers



**Chrome Dust Shield and Shifter Arm Set** include mounting hardware.

VT No.	Fits	Type
21-0210	1952-Early 78 FL, Covers Ratchet Drum	Full
21-0208	1952-Early 79 FL	Stock
21-0214	1974-Early 79 FX	Stock
21-0209	1974-Early 79 FX, Covers Ratchet Drum	Stock



**Chrome Shifter Arms** for Big Twin models.

VT No.	#	Model/Type
21-0202	A	1952-78 FL
21-0215	A	1952-78 FL, Zinc
10-2484		Bushing For Above
21-0195		1974-Early 79 FXE



**Chrome Shifter Drum Covers** for ratchet tops on 1952-79, 4-Speed.

VT No.	#	Year	Item
21-0200	A	1952-73 FL 1971-73 FX	Dust Cover with indent
21-0206	A	As Above	Zinc
21-0199		1952-73 FL	Smooth
21-0201	B	1974-79 FX	Dust Cover
21-1987			Stainless Allen Screws, 12 pack

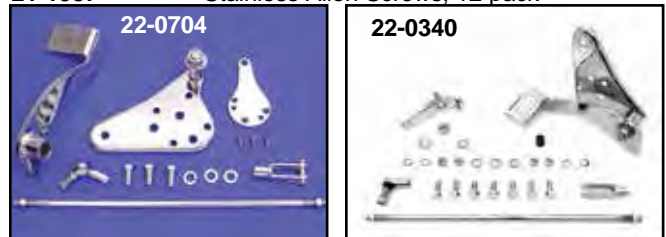

**Competition Foot Shifter Kit** allows one up and all down shifting pattern for positive shifts.

VT No.	Year/Top
22-0704	1952-78 Ratchet
22-0340	1979-84 Ratchet
21-0421	1952-78 Arm
21-0381	Shifter Lever





# Billet Forward Control



22-0755



22-0760 Right



22-0760 Left

**Chrome Billet Forward Control Set** fits 1986-99 Softail, 1958-84 FX-FL includes rubber belted pegs as shown. Includes left and right sides complete with master cylinder. Order shifter rod and stainless steel brake lines separately.

**VT No. Position**

**22-0760** Stock

**22-0755** +2"

**22-0767** +2" with Pirate Pegs

**22-0789** +2" with Left Side Hydraulic Clutch

**22-0758** +3"

**Note:** 3" extended unit 22-0758 not suitable for FLST models with stock fender.

**Billet Shifter Rod Kit** fits 2" & 3" extensions.

**21-0223** 1986-99 Softail

**Replacement Hardware**

**23-3005** Master Cylinder Only (3/4")

**23-0859** Master Cylinder Kit (3/4")

**23-0574** Master Cylinder Top Only with Top and Screws

**28-0607** Matching Grip Set

**27-0579** Driver Peg Set

**27-0615** Matching Passenger Peg Set

**21-0673** Shifter Peg

**28-0634** Shifter Peg Rubber

**21-0677** Shifter Lever, Inner

**21-0154** Shifter Lever

**23-0773** Brake Plunger Rod

**21-0785** Plunger Clevis

**FXST Brake Line Required**

**Components**

**23-0946** Spike Brake Pedal Pad

**23-4050** Banjo 10mm 35°

**23-8120** Stainless Line 32"

**23-9228** Tee Fitting

**23-4396** Line Fitting

**23-8020** Stainless Line 12"

**23-4047** Banjo 10mm Straight



22-0819 Right Side

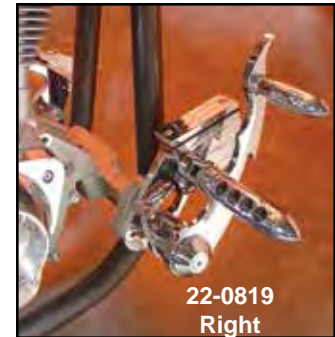

22-0819 Right

**Satan's Chrome Billet Forward Control Set** fits 1986-99 Softail, 1958-84 FX-FL includes rubber belted pegs as shown. and left and right side complete with master cylinder. Order shifter rod and stainless steel brake lines separately.

**VT No. 22-0819**



22-0758 Right

**Chrome Shifter Rod, Stock**

**21-0207** 1958-85 FL

**21-0224** 1979-84 FX

**Chrome Shifter Rods** fit 2 and 3" extended controls

**21-0219** 1958-78 Big Twin 4 Speed Ratchet

**21-0226** 1958-78 Rod Only +2"

**21-0218** 1979-84 FXE 4 Speed



22-0758 Left



21-0223 Billet Rod for 22-0755



21-0673



27-0615

## Forward Controls

**Complete Right and Left Side Brake and Shifter Set** for 4-Speed. Units are fully chrome plated, and fit all hydraulic brake models with disc or drum brakes, for rigid or swing arm frames. Kits use a Kelsey type master cylinder VT No. 23-1735, which is not included with kit. Parts for each shifter side parts include correct linkage for either 1952-78 ratchet top or rotary top 1979-84 4 Speed.

**VT No. Year/Model**

**22-0713** 1952-79 FL-FX

**22-0714** 1979-84 FXWG-FXST-FLH

**Top**

Ratchet

Rotary



22-0713 Left



22-0713 Right



21-0165

21-0166

**Chrome Billet Spacers** fit left side shifter with 3-hole and right side brake with 2-hole for 1984-99 Softail or custom application.

**Shifter Brake Thick**

**21-0175 21-0164** .50"

**21-0165 21-0166** .75"

**21-0167** — 1.0"

**21-0169 21-0170** 1.25"

**21-0171 21-0172** 1.5"

**21-0173 21-0174** 1.75"



# Forward Control Kit

**Chrome Forward Control Kit** fits 1958-86 Big Twins, 1986-99 FXST custom application. Includes shift and brake sides including 3/4" bore chrome Kelsey Hayes style master cylinder. Kit is supplied with O-ring pegs, but can be replaced with other style of clevis mount pegs. A universal nylon brake line kit, chrome mount hardware and 4 and 5 speed styles shifter rods are also included.

VT No.	Item
22-0716	Kit Complete
21-0109	Shifter Lever Only

## Brake Control for 1971-85 FX

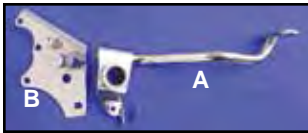

**Chrome FX-FXS Brake Pedal and Plate.**

VT No.	#	OEM	Year	Item
23-0107	B	50800-71B	1972-Early79	Plate
23-0106	A	42399-72A	1972-Early79	Pedal
23-0904		42399-72B	1972-Early79	Pedal
10-1154		24692-54	1972-Early79	Pivot Washer

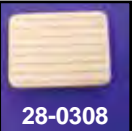
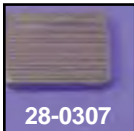

**Brake Pedal Rubber** replaces 42394-65. Fits all FX's with center mount brake set up, available in black or white.

VT No.	Finish
28-0307	Black
28-0308	White



**Brake Lever Spring** for FX-FXE models.

VT No.	OEM	Years
13-0149	42425-71	1971-Early 79
13-9218	42425-79	1979-84



**FX-FXE Brake Switch** replaces 72005-73A for rear stoplight on 1973-77 models.

VT No. 32-7766



**Clevis Pins** are zinc plated, include cotter pins and washers. Sold in pack of 5 or 10.

VT No.	OEM	Use
23-0421	42269-30	Brakes 30-69, 82-up, Shifter 52-84
23-0464	Parkerized	As Above, 5 pack
21-1986	42269-70	1970-81 Brakes
2501-12	Panhead	Kit, 1930-69

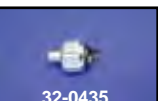
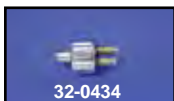
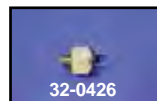
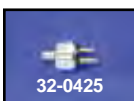

**1951-70 Hydraulic Brake Switch.**

VT No.	Type	Brand
32-0425	Screw	V-Twin
32-0434	Screw	Accel
32-0426	Flag	V-Twin
32-0435	Flag	Accel



**Chrome FX-FXE Brake Control Kit** is a replacement for mid style transmission mount on 1972-85 Superglides with parts pictured. Master cylinder is not included.

VT No.	Year	Type
22-1057	1972-79	Wagner
22-1058	Late1979-82	Kelsey Hayes

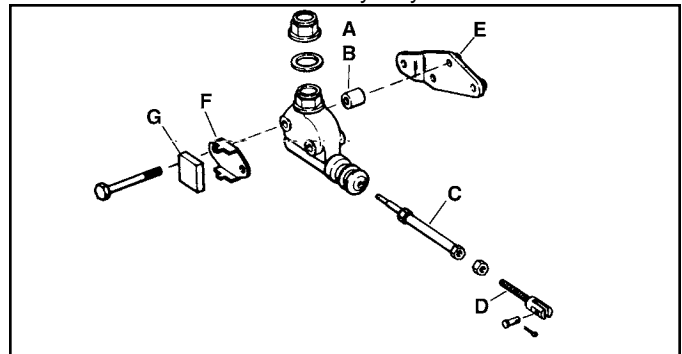

**Rear Master Cylinder Hardware.**

VT No.	OEM	#	Years	Item	Finish
23-0133	5983W	A	1972-E79	Spacer (2)	Zinc
23-0134	5890	B	1979-82	Spacer (2)	Zinc
23-0119	42257-72	C&D	1972-79	Plunger Cpt	Chrome
23-0124	42257-79	C&D	1979-82	Plunger Cpt	Chrome
23-0122	42330-72	D	1972-82	Clevis	Chrome
23-0247			1972-82	Plunger	Chrome
23-0109	42299-72	E	1972-E79	Support	Chrome
23-0130	42299-79	E	1979-82	Support	Chrome
23-0421	42269-30	H	(10 pack)	Pin	Zinc

**Foot Brake Lever and Bracket Mounting Kit** includes nut, washers and bolts are duplicates of stock hardware for 1936-71 Big Twin.

VT No.	Finish
9732-7	Chrome
9733-7	Cadmium
9734-7	Parkerized
9734-7T	As Above, V-Twin







# Big Twin Mechanical Brake

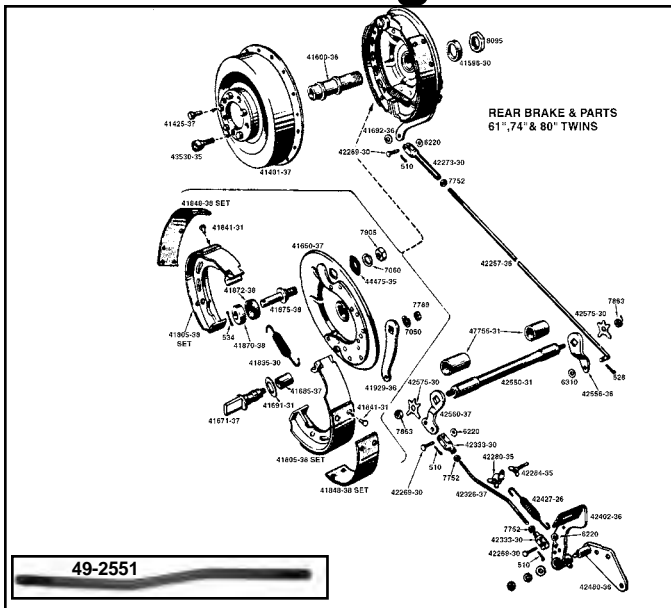

## Rigid Brake Parts For 1937-57 Big Twin Models.

VT No.	OEM	Finish	Item
23-0429	41400-37	Chrome	Brake Drum Complete
23-0430	41400-37	Black	As Above
19-0015	41420-30	Chrome	Splash Ring
23-0441	41425-37	Plain	Dowel Pin Set
44-0215	41552-36	Chrome	Rear Axle
7704-2	41576-36	Chrome	Axle Adjuster
8014-2	w/Nuts	Cadmium	Pair
44-0322	41595-36	Chrome	Axle Spacer
8160-4	41596-30	Chrome	Sleeve Collar Kit
8160-4T	41596-30	Chrome	Sleeve Collar Kit
8161-4	As Above	Cadmium	Includes Nut, Collar and Lock Tab
37-8791	41603-35	Parkerized	Lock Tab
44-0316	41596-30	Chrome	Collar, each
44-0330	41600-36	Chrome	Axle Sleeve
23-0415	41650-37	Chrome	Backing Plate
23-0420	As above	Black	Backing Plate
23-0417	41671-37	Plain	Cam
23-1023	41671-37	Raw	Cam
10-0740	41685-37	Standard	Cam Bushing
10-2496	41685-37A		.015 O.S. Cam Bushing
23-1990	41691-31		Cam Shim, 5 pack
23-0508	41805-38		Stamped Shoe Set
23-1750	41805-38		Replica Cast Shoe Set
23-0504	41848-38		Lining Set with Rivets
13-0145	41835-30		Shoe Spring Set
23-0418	41870-38		Outside Pivot Cup Kit
3 Piece Kit	41872-38		Inside Pivot Cup
	41875-38	Complete	Pivot Stud
2720-6T	Kit	Complete	Kit
2720-6	Kit	Complete	Complete
23-0066	7 Piece		Pivot Stud
23-0068	7 Piece		Pivot/Parkerized
23-0009	41875-38	Black	Pivot/Chrome
23-0067	Kit		Pivot Stud Only
23-0428	41929-36	Chrome	Pivot/Cam
23-0449	As above	Parkerized	Rear Lever
49-2552	42257-36	Parkerized	Rear Rod
23-0423	42257-36	Chrome	Rear Rod
23-0902	Replica	Chrome	Rear Rod
23-0903	Replica	Parkerized	Rear Rod
23-0421	42269-30	Zinc	Clevis Pin, 10 pack
23-0464	42269-30	Parkerized	Clevis Pin, 5 pack
2501-12	Kit	Parkerized	Clevis Pin Kit
23-0425	42273-30	Chrome	Rear Clevis
23-0444	As above	Parkerized	Front Rod
23-0422	42326-37	Chrome	Front Clevis
49-2551	As above	Parkerized	1937 Front Clevis
23-0424	42333-30	Chrome	Foot Lever
23-0443	As above	Parkerized	Foot Lever
23-1341	As above	Chrome	Replica
23-0104	42402-36	Chrome	Replica, 3 Hole
23-0156	—	Chrome	Lever Spring, each
23-0456	As above	Parkerized	Lever Spring, each
23-0471	—	Parkerized	Lever Bracket
13-0150	42427-26	Black	Lever Bracket
13-0173	42427-26	Chrome	Lever Bracket
23-0105	42480-36	Chrome	Lever Bracket
23-0446	As above	Parkerized	Lever Bracket
23-1563	42480-36	Parkerized	Lever Bracket
23-0048	1936	Parkerized	Lever Bracket
23-0419	42550-31	Plain	Cross Shaft
10-0741	47755-31	Pair	Shaft Bushing
23-0426	42560-37	Chrome	Shaft Lever, 2 hole
23-0447	As above	Parkerized	Shaft Lever, 1 hole
23-0427	42556-36	Chrome	Shaft Nut
23-0448	As above	Parkerized	Lock kit
7820-4	7863	Cadmium	Kit
4 Piece Kit	42575-30		Kit
9677-4	As Above	Parkerized	Lock Tab, pair
8409-4	As Above	Chrome	Nut, 5 pack
8409-4T	As Above	Chrome	Nut, 5 pack
17-0935	42575-30		Nut, 5 pack
37-6137	7905	Chrome	Nut, 5 pack
37-6138	7905	Parkerized	Nut, 5 pack
37-0709	7789	Parkerized	Nut, 5 pack
37-0009	7789	Chrome	Nut, 5 pack
37-8660	510	Zinc	Cotter Pin
37-8661	534	Zinc	Cotter Pin
37-0799	7060	Parkerized	1/2" Lockwasher
23-0416	44475-35	Black	Lock Plate
23-0452	44475-35	Chrome	Lock Plate
23-0069		Parkerized	Brake Switch Clamp
23-1706			Spring Clamp

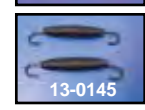
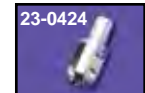
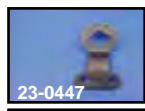
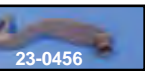

**Rigid Brake Drum Assemblies** for 1937-57 are complete replacements with sprocket and dust shield riveted on. Drawn steel construction. Replaces 41400-37.

Chrome	Black	
23-0429	23-0430	
23-0291	23-0051	with wrench
	23-0248	(Cast)

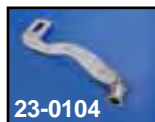

**Replica Brake Pedals.** Rigid and include grease fitting and slot.

Chrome	Parkerized	Year
23-0104	23-0456	1936-57
—	23-0867	1940-57
23-0942	—	1936 Only
23-0868*	—	1936 Only
23-0816*	—	1936-38
23-0977	23-0983	1936-38

\*Note: Nickel Plated.

## Brake Shoe Springs.

Front		
13-0146	41835-69	1969-72 FLH Glide
13-0201	41835-57	1949-71 Glide
13-0208	44486-28	1929-52 45 Solo
13-0209	44484-35	1936-57 Big Twin
13-0146	41835-69	1952-72 Sportster
Rear		
13-0145	41835-30	1930-57 Big Twin
13-9233	41836,37-58	1958-62 Hydraulic
13-0148	41836,37-63	1963-72 Hydraulic
13-9260	—	1960-62 Hydraulic
13-0146	41835-69	1952-78 Sportster
13-0208	44486-28	1935-52 45 Solo

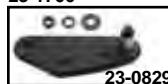

**Replica Foot Brake Lever Stud** available with threaded end or peen-end. Hardware included. Note: Oversize studs require purchase of 2/32" ream to refit worn pedals.

Stock	Oversize	Year	Type
2315-6	2309-6	1936-38	Threaded
2316-5	2310-5	1937-57	Big Twin and 45
23-0829	—	1936-38	Plate
23-0048	—	1936	Plate

Wheel Lug Bolts	Chrome	OEM	Years	Fits
37-8675	23-0440	43530-35A	1936-72	3/8" — 20
37-8691	—	43530-35A	1936-72	3/8" — 20
—	37-8919	43531-35	Oversize	7/16" — 20
49-0457	—	43531-35	1936-37	3/8" — 20
23-0090	—	43631-35	1936	3/8" — 20



**Mechanical Backing Plate Kit** for 1936-57 includes plate, springs, shoes, cam pivot stud and plate. Arm not included.

**VT No. Replica Finish**  
**22-0708 22-0745** Chrome  
**22-0709 22-0746** Black



**Rear Brake Drum Kits** feature backing plate with all components installed, including a pre-arc set of brake shoes to fit the drum supplied. The drum has the 51 tooth sprocket riveted on with an original style dust ring. Kits are available in black or chrome finish. Lug bolts included, but axle and sleeve kit must be purchased separately.

**VT No. Finish**  
**23-0876** Black  
**23-0877** Chrome



**Drum Backing Plate and Drum** for 1936 Only fits 61" Overhead Valve.

**VT No. Item**  
**49-0357** Backing Plate  
**49-5515** Black Drum  
**49-0555** Kit

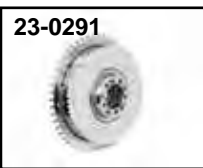

**Cast Rear Brake Drum** fits 1937-57 Rigid.

**VT No. Type**  
**23-0291** Chrome  
**23-0248** Black



**Foot Brake Lever and Bracket Mounting Kit** includes nut, washers and bolts which are duplicates of stock hardware for 1936-71 Big Twin.

**VT No. Finish**  
**9732-7** Chrome  
**9733-7** Cadmium  
**9734-7** Parkerized  
**9734-7T** Parkerized



**Emergency Brake Lock** fits mechanical brake pedals on Rigid 1936-57 Big Twins.

**VT No. Item**  
**23-1949** Complete  
**23-0055** Pedal and Plate Kit

## Mechanical Brake

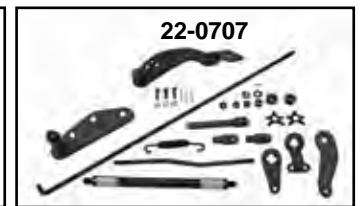
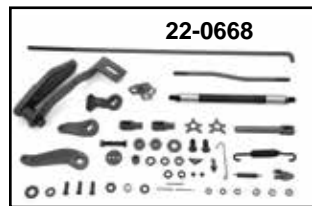

**22-0171**

**Mechanical Kit** for 1936-57 Big Twin is perfect for finishing a restoration or for forward controls on a custom rigid frame. For use on mechanical brake frames with a cross shaft tube only. Hardware is included. Footboards may be used with this kit.

**VT No. Type**  
**22-0706** Chrome  
**22-0707** Parkerized  
**22-0668** Parkerized **Note:** Includes stop lamp switch kit  
**23-0666** Parkerized Cross Shaft Kit  
**2796-2** Grease Fitting  
**9677-4T** Nut Set  
**51-0481** Shaft Kit  
**22-0171** Kit



**Brake Shoe Sets** fit 1937-57 Big Twin Rigid and are complete with linings installed. Sold in pairs. Note: When new shoes are installed, they may have to be "arced". VT No. 23-1795 shoe sets are fit to our drums.

**Mechanical, Rear.**

**VT No. Type**  
**23-0500** Stock  
**23-1795** Arced  
**23-1750\*** Cast  
**23-0504** Linings Only  
**23-0986** Stud Kit

**\*Note:** Original Cast Construction







# 1958-69 Brake



**1958-69 Hydraulic Brake Kit** includes all parts illustrated as replacement for flat side engine or for use on cone motors with an outside frame pipe. Available with or without cast iron Wagner style master cylinder

- VT No. Master Cylinder**  
**22-0747** Without, Zinc  
**22-0401** Without, Chrome  
**22-0403** With Chrome  
**22-0402** With Painted  
**22-0781** With, Zinc & Rubber Pedal Pad

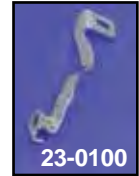

**1958-69 Big Twin Rear Brake Components.**

- | VT No.  | Item        | Finish  |
|---------|-------------|---------|
| 23-0100 | Pedal       | Chrome  |
| 23-0101 | Pedal Plate | Chrome  |
| 23-1742 | Spacers     | Zinc    |
| 13-0147 | Spring      | Chrome  |
| 13-0175 | Spring      | Chrome  |
| 23-0115 | Plunger     | Chrome  |
| 23-0192 | Plunger     | Zinc    |
| 16-0432 | Tool        | Locking |

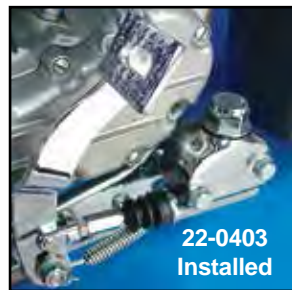

**Master Cylinder Cover**  
**VT No. 42-0315**

# Forward Brake Kit



**Brake Kit for 1979-84 FLH** includes chrome pedal, chrome plate with front footboard bracket, plunger, spring and stud. Order master cylinder separately.

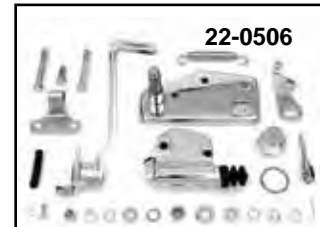

- | VT No.  | Item                     |
|---------|--------------------------|
| 22-0300 | Chrome Kit               |
| 23-1735 | Chrome Master Cylinder   |
| 23-1772 | Alloy Master Cylinder    |
| 27-0596 | Rear Floor Board Bracket |
| 37-6366 | Master Cylinder Stud     |



**Chrome Hydraulic Brake Pedals and Backing Plates.**

VT No.	#	OEM	Year	Item
23-0120	A	42411-70	1970-78 Big Twin	Stop
23-1742		50668-35	Spacers for above	Spacers
13-0147	B	42427-58	Spring	Spring
23-0103	D	42402-73A	1970-Early 79 FLH	Pedal
23-9192	C	42402-79	Late 1979-84 FLH	Pedal
23-0451	E	42480-79	1979-84 FLH	Plate
23-0102	F	42401-73A	1970-Early 79 FLH	Plate

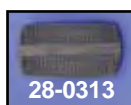
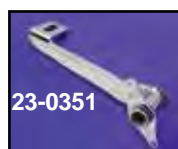

**28-0457**



**Chrome Forward Brake Pedal** allows driver better access to pedal from footboard. Fits 1979-84 FLH.

- | VT No.  | Item  |
|---------|-------|
| 23-0351 | Pedal |
| 28-0313 | Pad   |
| 28-0457 | Pad   |



**VT No. 22-1017 Shown**

**Original Forward Brake Control Assemblies** will equip all Big Twins with hydraulic brakes and powered by either Evolution or 1970-99 Shovelhead engines. Available in either Wagner or Kelsey Hayes styles, with or without master cylinders. Footboards can be fitted to our Wagner style kits VT No. 22-0500, 22-0505 or 22-0506. Wagner styles use

41761-73 master cylinder, or Kelsey Hayes type 41576-79A, for those wishing to utilize their existing master cylinder. Complete assemblies include detailed instructions and diagram for installation. Display packaged.

- | VT No.  | Type         | Note                        |
|---------|--------------|-----------------------------|
| 22-0500 | Wagner       | Without Master Cylinder     |
| 22-0505 | Wagner       | With Plain Master Cylinder  |
| 22-0506 | Wagner       | With Chrome Master Cylinder |
| 22-0501 | Kelsey Hayes | Without Master Cylinder     |
| 22-1017 | Kelsey Hayes | With Chrome Master Cylinder |

\***Note:** For kits 22-0500, 22-0505, 22-0506, 22-0501, and 22-1017, use Russell front line 23-8809 and rear line 23-8915 for disc brake models, and tee 23-0707.



**Footpeg Mounting Studs** fit through Wagner or Kelsey Hayes master cylinders to mount foot pegs to these forward assemblies. Stud side shown accepts that size footpeg yoke.

- | VT No.  | Type                       |
|---------|----------------------------|
| 37-8986 | Kelsey Hayes Type 3/8 — 24 |
| 37-8987 | Wagner Type 1/2 — 20       |



Pedal Shown with Pad 28-0311 Available Separately.

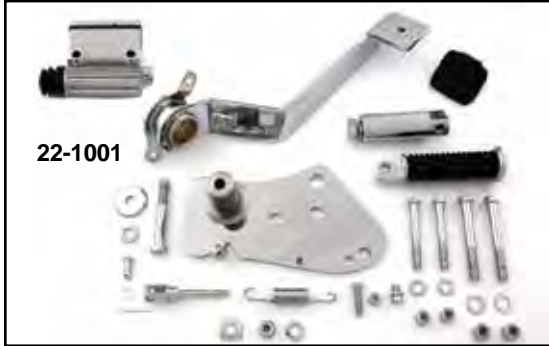

# Forward Brake Control Kit

**FXST Replica Forward Brake Control** for use on all 1970-99 Big Twin with Shovelhead or Evolution engines equipped with hydraulic disc or drum brakes. Designed after the 1984-99 FXST which places the driver peg in back of the brake pedal, so the brake is easier to operate from this comfortable position. Redesigned to accept a Wagner or Kelsey-Hayes style master cylinder or GMA masters, also available with chrome KH or Wagner style masters. Hardware includes linkage pedal mount plate, rubber covered footpeg. This kit is the exact compliment to our shifter kits listed and when used with one of these kits, places the pegs in forward and raised position.

VT No.	Item	Master Cylinder
22-1066	Dual-use kit	Without
22-1001*	Complete kit	Kelsey type
22-1018*	Complete kit	Wagner type
23-1743	Brake Pedal for Above	
23-1744	Pedal Plate	
13-0181	Brake Pedal Spring	
23-0984	Pin	

**Note:** Kits VT No. 22-1001 and 22-1018 use Russell stainless lines VT No. 23-8809 front and 23-8802 from junction to rear caliper. Use tee VT No. 23-0707.

## Brake Pedal Pads



**Brake Pedal Pad** features chrome die cast backing with black rubber insert pads. Fits 1965-84 FLH.  
VT No. 28-2226



**Brake Pedal Pad Only** for 1983-up FLT. Replaces 42416-83.  
VT No. 28-2233

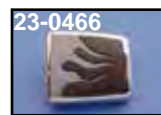

VT No.	Model
23-0466	1984-up FXST, Flame
28-0761	1980-up FL, Flame

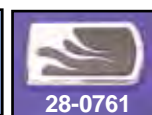

**Brake Pedal Pad** features chrome die cast backing with black rubber insert pads.

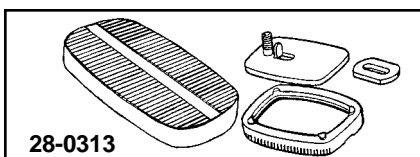

### Brake Pedal Pad Kit

VT No.	Year/Model	Type	Color
28-0313	1965-79 FLH	Kit	Black
28-0310	1965-79 FLH	Pad only	Black
28-0621	1965-79 FLH	Pad only	White
28-0067		Pad only	Red
28-0071		Pad only	Black



**FXST Brake Pedal Rubber** with stud replaces 42532-82. Stock on all 1983-up FXST models. VT No. 28-0548



**Slide On Black Brake Pedal Pad** replaces 36954-62 on 1936-84 FL and Rigid brake pedals, slides on.

VT No.	Type
28-0304	Stock
28-0457	"H"
28-0070	Stock



**Skull Pedal Pad** is constructed of neoprene. Sold each.

VT No.	Type
23-0823	FXST
23-0824	FLST-FLH



28-0457 Installed

28-0005 Fudgesickle kick starter pedal rubber





# 1958-72 Hydraulic Drum Brake

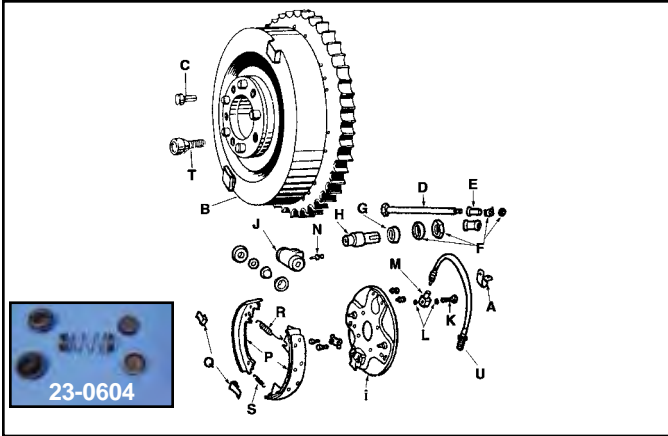

**Big Twin Hydraulic Rear Backing Plate Assembly** includes chrome or black backing plate, with wheel cylinder, shoe set and springs installed. Hose fitting and banjo bolt are supplied. Order proper brake drum and axle kit separately.

## Hydraulic Brake Parts for 1958-72 Big Twin.

VT No.	#	OEM	Year	Item
37-8129	A	9995	1958-72	Clamp, 10 pack
23-0431	B	41400-58C	1958-62	Brake drum, chrome
23-0432	B	41400-58C	1958-62	Brake drum, black
23-0433	B	41400-63	1963-66	Brake drum, chrome
23-0434	B	41400-63	1963-66	Brake drum, black
23-0435	B	41400-67	1967-72	Brake drum, chrome
23-0436	B	41400-67	1967-72	Brake drum, black
23-0441	C	41425-37	1958-72	Dowel Pin
44-0214	D	41552-58A	1958-66	Axle, chrome
44-0213	D	41552-67	1967-72	Axle, chrome
44-0321	E	41595-58	1958-66	Spacer, chrome
44-0353	E	41595-67	1967-72	Spacer, chrome
44-0354	E	41595-67	1967-72	Spacer, zinc
8160-4	F	41596-30	1958-72	Collar Lock and Nut Kit
8161-4	F	As above	1958-72	Cadmium
44-0319	G	41596-58	1958-62	Spacer, side plate
44-0318	G	41596-63	1963-72	Spacer, side plate
44-0329	H	41600-58	1958-62	Axle sleeve
44-0355	H	41600-63	1963-66	Axle sleeve
44-0327	H	41600-67	1967-72	Axle sleeve
23-3022	I	41650-58	1958-62	Side plate, chrome
23-0714	I	41650-63	1963-72	Side plate, chrome
23-0715	I	41650-63	1963-72	Side plate, black
23-0748	J	41740-58	1958-62	Wheel cylinder
23-0749	J	41740-63	1963-72	Wheel cylinder
23-0713	K	41743-58	1958-72	Wheel cylinder bolt
23-0026	L	41744-58	1958-72	Copper gasket, 10 pack
23-0755	M	41745-58	1958-62	Swivel fitting
23-0712	M	41750-63	1963-72	Swivel fitting
23-0711	N	41749-58	1958-72	Bleeder nipple, 10 pack
23-0604	O	41748-62	1958-62	Cylinder kit
23-0605	O	41748-63	1963-72	Cylinder kit
23-0501	P	41801-58A	1958-62	Brake shoe set
23-0502	P	41801-63	1963-72	Brake shoe set
23-1989		41802-58	1958-62	Brake Linings
23-1987		41809-63	1963-72	Brake Linings
23-0603	Q	41835-58	1958-72	Spring clip set
13-0148*	R	41836-63	1963-72	Shoe Spring Set
	S	41837-63		
13-9233	S	41836-58	1958-62	Shoe Spring Set
		41837-58		
13-9260	S	—	1960-62	Shoe Spring Set
13-0763	Set		1958-62	Shoe Spring
23-0440	T	43530-35A	1958-72	Lug Bolt, Chrome
37-8675	T	43530-35A	1958-72	Lug Bolt, Parkerized
23-0716	U	42300-58	1958-62	Hose
23-0717	U	42300-63	1963-72	Hose

VT No.	Year	Finish	Drum	Axle Kit
23-9241	1958-62	Black	23-0432	44-0562
23-9240	1958-62	Chrome	23-0431	44-0562
23-9242	1963-66	Black	23-0434	44-0582
23-9247	1963-66	Chrome	23-0433	44-0582
23-9242	1967-72	Black	23-0436	44-0567
23-9247	1967-72	Chrome	23-0435	44-0567



**Brake Drum Steel Backing Plate** for hydraulic drum models have the mount stud and shoe cams installed.

Chrome	Black	#	OEM	Years
23-3022	23-3027	A	41650-58	1958-62
23-0714	23-0715	B	41650-63	1963-72



**Rear Hydraulic Cast Brake Drums** are complete replacements with sprocket riveted on.

Chrome	Black	Years	Type
23-0431	23-0432	41400-58C	1958-62
23-0433	23-0434	41400-63	1963-66
23-0435	23-0436	41400-67	1967-72
—	23-0930	Kit	1963-66

**Brake Shoe Retainer Clip** replaces 41835-58, fits 1958-72 FL-FLH models. Sold in pairs.  
VT No. 23-0603



**Wheel Lug Allen Wrench** fits all front and rear wheels 1935-72 FL models.

## VT No. Item

- 16-0102 Lug Wrench
- 16-1730 Drive Socket
- 16-1789 T-Handle

**Lug Bolt Kit** includes 5 lug bolts and "T" wrench.

## VT No. Lugs

- 49-0830 Parkerized
- 23-1207 Chrome



23-0749

**Wheel Cylinders and Kits** are replacements for stock units. The cylinders are completely assembled, and ready for installation.

## Wheel Cylinders

VT No.	OEM	Year
23-0748	41740-58	1958-62
23-0749	41740-63	1963-72

## Rebuild Kits

23-0604	41748-62	1958-62
23-0605		1963-72



**Brake Drum Dowel** fits all rear drums. 1937-72. Five piece set.

VT No. 23-0441

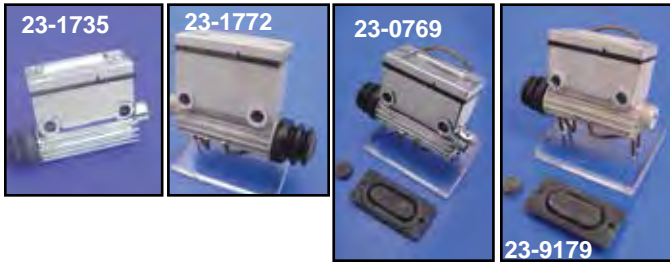

**Kelsey Type Master Cylinder.** Alloy style for 1979-85 models complete with internals.

VT No.	OEM	Type	Fits
23-1735	41754-79A	Chrome	1979-84 FLH
23-1772	41754-79A	Alloy	As Above
23-0769	42453-80A	Chrome	1980-83 FXWG 1979-84 FXS
23-9179	42453-80A	Polish	As Above



**Billet Master Cylinders** feature Wagner or Kelsey Hayes style mount holes 5/8" bore.

VT No.	OEM	Type
23-3003	Kelsey-Hayes	5/8" bore Inline
23-3032	Kelsey-Hayes	5/8" bore Inline
23-3004	Kelsey-Hayes	5/8" bore Offset
23-3034	Wagner	5/8" bore Inline
23-3033	Wagner	5/8" bore Offset
23-0878	Rebuild Kit for 23-3003/23-3004	
23-0860	Rebuild Kit for 23-3034/23-3033	



**Chrome Rear Master Cylinder Cover** fits FL-FX Kelsey style.

VT No.	Style	Year
23-0617	Smooth	1979-up
24-0639	Eagle Spirit	1979-84
24-0601	Finned	1979-84



**Chrome Billet Master Cylinder Reservoir** replaces original plastic unit on 1982-86.

VT No. 23-3029

**Rear Master Cylinder Boots** are sold each.

VT No.	Fits
28-0501	1958-69 FL
28-0502	1970-78 FL-FX
28-0503	1979-84 FLH, 1978-82 FX
28-0504	1983-up FX
28-0505	1979-86 FLT
28-1955	41764-58 41764-70, 5 early and 5 late



Thread Chart	
<b>OEM Rear Master Cylinders</b>	
Kelsey-Hayes. Late 1979-84 FL, FX; 80-85 FXWG, FLT	3/8"-24 Inverted Flare
Wagner-Lockheed. 58-Early 79 FL, FX	3/8"-24 Inverted Flare
(Girling type) 83-Early 87 FX, 1982-Early 87 FXR	3/8"-24 Inverted Flare (to caliper)
All Late 1987-2002 Big Twin, TC/B, XL	1/8" NPT (to reservoir master cylinder)
All H-D Brake Tees	3/8"-24 banjo bolt
All H-D Brake Tees	3/8"-24 Inverted Flare (brake line)
1/8 NPT (brake light switch)	

# Master Cylinder



**Wagner Style Master Cylinder.** Drum Type for 1958-72, disc type 1973-Early 79. Units are assembled with internals and include cap and boot.

Drum	Disc	Finish
23-0750	23-0751	Painted Silver
23-0752	23-0753	Chrome
23-0050	—	Black
23-0025	—	Silver

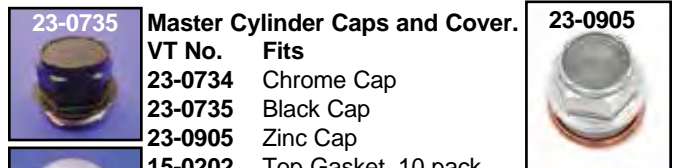

VT No.	Fits
23-0734	Chrome Cap
23-0735	Black Cap
23-0905	Zinc Cap
15-0202	Top Gasket, 10 pack
37-8470*	Cap Cover

\*Note: Fits over existing cap secured by set screw.



**Chrome Rear Master Cylinder Covers.**

VT No.	Fits
42-0315	1958-79 FLH
42-0316	1979-84 FLH

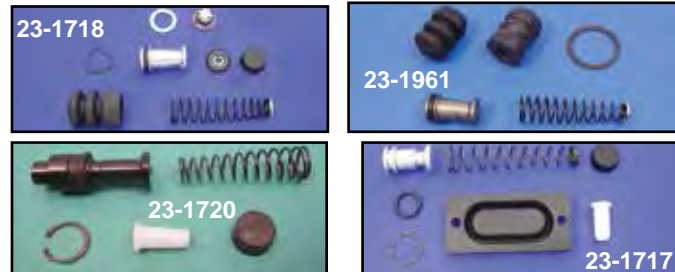

**Rear Master Cylinder Rebuilds**

VT No.	OEM	Fits
23-1718	41762-58A	1958-79 Big Twin
23-1961	Deluxe Kit	1958-79 Big Twin
23-1717	42374-77B	1979-84 FL, 80-86 FLT
23-1720	42374-82A	1983-85 FX 4-speed 1984-86 FXST-FLST

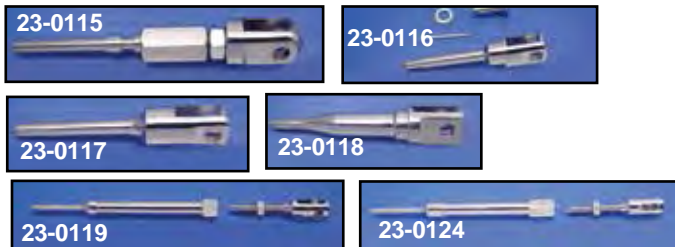

**Chrome Brake Plunger Assemblies.**

VT No.	OEM	Fits
23-0115	41770-58	1958-69 FL
23-0116	42333-70	1970-79 FL, 3" long
23-0117	2333-79	1979-84 FLH, 3 3/8" long
23-0118	40923-79	1979-81 FLT
23-0119	42257-72	1972-79 FX
23-0124	42257-79	1979-82 FX
23-0122	42330-72	1972-82 FX Clevis only
23-0247		1972-82 Plunger only







# Replica Brake Line



23-0716



23-0717



23-0601



23-0730



23-0719



23-0720



23-2288



23-0732

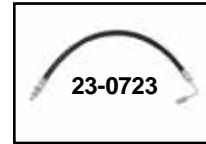

23-0723



23-0741

**Rear Brake Hoses** are made of rubber, OE replacements. All hoses are D.O.T. approved.

**VT No. OEM Years Model**

23-0716 42300-58 1958-62 FL

23-0717 42300-63 1963-72 FL-FX

23-0601 7988 Hex Nut and Lockwasher for Above 7242

23-0719 45151-78 1979-83 FX

23-0720 42300-73A 1973-80 FLH

23-2288 40912-81 1981-84 FLH

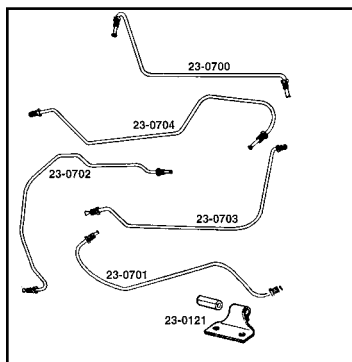

**Rear Steel Brake Lines** are available in chrome or zinc plated. Front fits between master cylinder and junction. Rear is from junction toward rear caliper. Order rubber hose for final connection to rear wheel cylinder or caliper separately.

Chrome	Zinc	OEM	Fits	Type
23-0700	23-0761	42302-58	1958-69 FLH	Front Section
23-0701	23-0762	42304-70A	1970-78 FLH	Front Section
23-0704	23-0763	42304-79	1979-84 FLH	Front Section
23-0703	23-0764	42301-58A	1958-69 FLH	Rear Middle Section
23-0702	23-0765	42303-70A	1970-72 FLH	Rear Middle Section
—	23-9023	45150-79	1979-83 FXE	Front Section
—	23-9182	41004-82	1983-E84 FX	Front Section
—	23-0121	42314-71A	1970-84 FLH	Bracket

**Hoses Listed** are stock rubber construction and D.O.T. approved.

**VT No. OEM Length Fits**

23-0730 45120-72A 44½" 1972-81 FL-FLH

23-0732 45521-74A 40" 1974-77 XL-FX

23-0723 45121-77 19" Upper & Lower 1978-79 FX FXE, 1977-79 XL Lower only 1980-82 FX-FXE Lower only

23-0741\* 45124-83 41" 1983 FXSB

23-2294 45113-83 46" 1983 FXWG

**\*Note:** Hose is one piece dual disc hose with built in junction block.

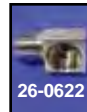

26-0622



23-1988

**Brake Hose Fittings** for front master cylinder, chrome.

**VT No. OEM Model Type**

26-0622 43307-78 FX-XL Angle

23-1988 63609-72 FLH Straight

23-0517 Converts 10mm late threads to ½" NPT with inverted flare, early thread hose type, straight.



23-0517

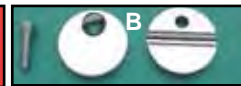

**Front Chrome Brake Line Clamp** fits under triple tree to secure stainless brake line. Mount hole is ¼ — 20.

**VT No. Type**

23-0675 A

23-0686 B

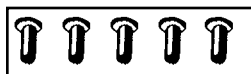

**Clutch and Brake Brass Rivets.**

VT No.	OEM	Type	Use	U/M
37-8805	—	Short 4-4½	Brake	100
37-8806	41871-31	Long 4-5	Brake	100
37-8807*	8226	Short 7-4	Clutch	100

**\*Note:** For clutch hub friction disc.



32-0425



32-0434



32-0426



32-0435



32-0443

**1951-84 Hydraulic Brake Switch.**

VT No.	Type	Brand
32-0425	Screw	Replica
32-0434	Screw	Accel
32-0426	Flag	Replica
32-0435	Flag	Accel
32-0443	Flag	Replica

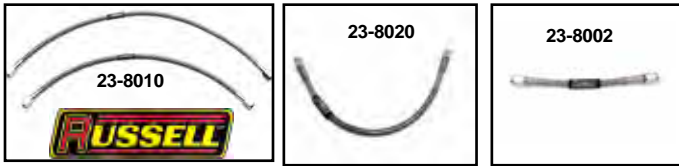

**10mm Russell Street Legal Universal Brake Lines** are build it yourself line assemblies ready for adapter fittings. They are preassembled with high performance #3 stainless braided hose with a rugged Teflon® inner, and crimp-on chrome plated female swivel hose ends. Clear coated for abrasion resistance. Meet the guidelines of the D.O.T. MVSS-106 requirements and are 50-state legal, and compatible with all brake fluids.

VT No.	Length	VT No.	Length	VT No.	Length
23-8352	4"	23-8110	30"	23-8272	56"
23-8002	6"	23-8120	32"	23-8282	58"
23-8010	9"	23-8130	34"	23-8229	60"
23-8020	12"	23-8342	36"	23-8332	62"
23-8030	15"	23-8140	38"	23-8312	64"
23-8362	16"	23-8242	40"	23-8322	66"
23-8040	17"	23-8150	42"	23-5833	68"
23-8212	18"	23-8252	43"	23-5835	72"
23-8050	19"	23-8262	44"	23-5836	74"
23-8060	21"	23-8192	45"	23-5840	80"
23-8070	23"	23-8372	46"		
23-8939	24"	23-8160	47"		
23-8080	25"	23-8202	50"		
23-8090	26"	23-8170	52"		
23-8100	28"	23-8180	54"		



**Chrome Banjo Bolt Kits** are for use with universal or stock lines, front and rear. Washers are included. The VT No. 37-8979 is to be used when a master cylinder or caliper uses a 3/8"-24 banjo bolt and the line has a 12mm hole instead of 10mm.

VT No.	Line	Size/Item
23-0612	10mm	3/8"-24
23-0613	10mm	Washers
23-0614	12mm	7/16"-24
23-0615	12mm	Washers
37-8979	12mm	3/8"-24 (Special Kit)
14-0568	10mm	Washer with O-Ring
14-0567	12mm	Washer with O-Ring

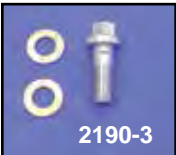

**Chrome Banjo Bolts** include seal washers.

VT No.	Size	MM	Style
2190-3	3/8" - 24	10	Dome
2191-3	3/8" - 24	10	Allen
2192-3	7/16" - 24	12	Dome
2193-3	7/16" - 24	12	Allen



**Brake Banjo Seal Washers** feature built in O-Rings.

VT No.	Type
14-0567	7/8", 12mm fits handlebar cylinders 1984-00, single disc
14-0568	3/8", 10mm fits 1982-00 dual disc Brake Calipers
14-0578	2001-up master cylinder and brake calipers
14-0048	2006-up Banjo Bolts



**Allen Button Head Banjo Bolts** are sold with washers.

VT No.	Size	MM
37-8517	3/8"-24	10mm
37-8518	7/16"-24	12mm

# Universal Brake Fitting & Bolt



**Chrome Adapter Fittings** see listing for application.

\*Note: Most common use

**VT No. Fitting Type Adapts To:**

- 23-4047 10mm Banjo, Straight
- 23-4050 10mm Banjo, 35°
- 23-4053 10mm Banjo, 45°
- 23-4051 10mm Banjo, 90°
- 23-4052 7/16" Banjo, Straight
- 23-4053 7/16" Banjo, 35°
- 23-4056 7/16" Banjo, 35°
- 23-4054 7/16" Banjo, 90°
- 23-4057 12mm Banjo, Straight
- 23-4058 12mm Banjo, 35°
- 23-4059 12mm Banjo, 90°
- 23-4244 1/8" Male NPT, Straight
- 23-4279 1/8" Male NPT, 90°
- 23-4293 1/8" Male NPT, 45°
- 23-4298 Male "T"
- 23-6033 Flare Union
- 23-6034 3/8"-24 Banjo Bolt
- 23-6035 7/16"-24 Banjo Bolt
- 23-6040 10mm x 1.25" Banjo Bolt
- 23-6041 12mm x 1.25" Banjo Bolt
- 23-6036 3/8"-24 Double Banjo Bolt
- 23-6042 10mm x 1.25" Double Banjo Bolt
- 23-0746 3/8"-24 Brake Switch Banjo Bolt
- 23-6037 35° Rear Banjo, 10 mm
- 23-6038 90° Short Rear Banjo, 10 mm
- 23-6039 90° Long Forward Control Banjo, 10 mm
- 23-4396 3/8"-24 Male Inverted Flare, straight, 2 pack
- 23-4380 3/8"-24 Male Inverted Flare, 90° and 120°

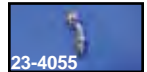

- 23-4281 3/8"-24 Male Inverted Flare, 45°  
\*Rear Calipers
- 23-4282 3/8"-24 Male Inverted Flare, 90°, short  
\*Junction Block to Front Caliper
- 23-4283 3/8"-24 Male Inverted Flare, 90°, long  
\*Junction Block to Front Caliper
- 23-4284 3/8"-24 Male Inverted Flare, 150°  
\*Forward Controls
- 23-4285 3/8"-24 Male Inverted Flare, 60°  
\*Rear Calipers
- 23-4306 Front Wide Glide Junction Block
- 23-4307 Front Narrow Glide Junction Block
- 23-4305 90° long forward control banjo, 10 mm
- 23-4303 35° short rear brake banjo, 10 mm
- 23-4304 90° short rear brake banjo, 10 mm

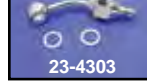
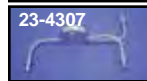
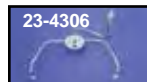

CLASSIC





# Front Stainless Brake Line



**FX Series** Refer to next page for diagram.

\*Note: D.O.T. approved.

Year	Model	Front	Type	Rear	Diagram#
1974-76	FX-FXE	23-8900	1	23-8915	19
As Above +4 Ext		23-8901	1	23-8915	19
As Above +8 Ext		23-8901	1	23-8915	19
1977	FXS	23-8902	5	23-8915	19
1978	FXS	23-8704	5	23-8803	6
1977-79	FX-FXE-FXEF	23-8703	5	23-8803	6
1979	FXS	—	5, 14	23-8803	6
1980	FXE-FXEF	—	5, 14	23-8803	6
1980	FXS	23-8712	5, 14	23-8803	6
1980-83	FXWG	23-8713	5, 14	23-8802	6
1980-81	FXB	23-8705	5, 14	23-8803	6
1981	FXS	23-8711	5, 14	23-8802	6
1981	FXWG	23-8711	5, 14	23-8802	6
1982	FXWG	—	5, 22	23-8802	6
1982	FXE	—	5, 22	23-8803	6
1982	FXS-FXB	23-8714	—	23-8803	6
1982-83	FXR	23-8732	5, 22	—	3
1983	FXWG-FXDG	23-8720	5, 24	23-8810	2
1983	FXE	23-8734	5, 24	23-8803	6
1983	FXSB	23-8733	5, 24	23-8810	2
1983	FXR-FXRS	23-8733	5, 24	—	3
1983	FXRT	23-8737	31, 22, 32	—	3



## Brake Tee



### Billet Aluminum Brake Tee

VT No. Type

23-9227 Front 3/8"-24 inverted flare in all 3 holes

23-9228 Rear 3/8"-24 inverted flare in 2 holes and 1/8" NPT in center hole



### Universal Straight Chrome Union with bracket.

VT No. Thread

23-0635 1/8" NPT

23-0688 3/8" - 24

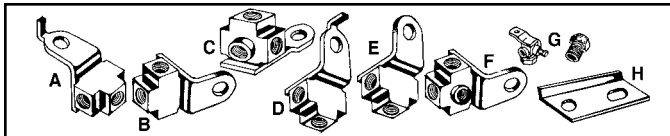

**Chrome Billet Round Brake Tees.** VT No. 23-3771 is for dual disc applications. VT No. 23-3770 has counterbored mounting.

VT No.	Style	Holes	Thread
23-3768	Inverted	3	3/8" — 24
23-3769	Inverted	2	3/8" — 24
	NPT, Center	1	
23-3770	NPT	3	1/8"
23-3771	Thread	2	3/8" — 24

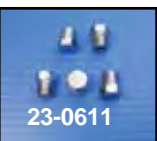

### Chrome Front and Rear Replacement Brake Tees.

Front	OEM #	Model
23-0706	43308-78 A	1978-79 FX
23-0708	44311-80 B	1980-82 FXWG
23-0705	43310-77 D	1977 FXS & 1979-84 All FX models except FXWG
		1979-81 XL, XLCH, XLS
Rear	OEM #	Model
23-0709	83566-51 C	1958-69 FL
23-0707	42318-72 E	1972-84 FL, 1977-79 FX, 1980-82 FXWG
23-0710	42309-70 F	1971-72 FX and 70-83 with sidecar
23-0611	42311-58 G	Brake Tee Plug 5 pack
23-0027	45152-78 H	Tee Bracket FX-FXST Chrome



**Chrome Steel Brake Line Tees** have a 5/16" mounting hole.

VT No.	Type
23-0570	Center hole inverted flare 3/8"- 24 UNF, side tubes 3/8"- 24 UNF
23-0571	Center hole 1/8" - 27 NPT, side tubes 3/8" - 24 UNF
23-0572	Center hole and side tubes 1/8" - 27 NPT
23-0939	Maltese Style



# Brake Line

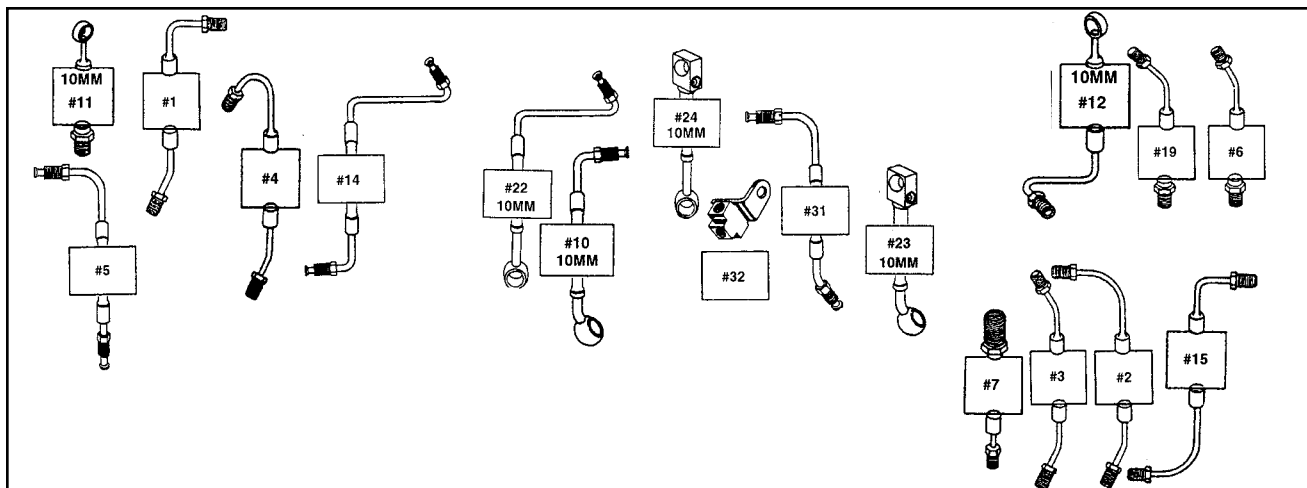

### FL Touring/Dresser Series

Year	Model	Front	Diagram#	Rear	Diagram#
1963-72	FL			23-8914	7
1972-80	FL-FLHS	23-8903	6	23-8802	6
	As Above +4" Ext	23-8904	6	23-8802	6
	As Above +8" Ext	23-8905	6	23-8802	6
1981	FLHS	23-8708		23-8802	6
1981	FLH	23-8708		23-8809	4
1982	FLHS	—	11	23-8802	6
1982-84	FLH	—	11	23-8809	4
	As Above +2" Ext	23-8923	11	23-8809	4
	As Above +4" Ext	23-8924	11	23-8809	4
1983	FLT-FLHT-FLTC-FLHTC	23-8721	5, 23	—	5

### Upper Dual Disc Front Lines (sold each)

VT No.	Model	Type	Diagram
23-8908	1978-79 FX-FXE	Stock 19"	5
23-8959	1978-79 FX-FXE	-2"	5
23-8909	1978-79 FX-FXE	+2"	5
23-8910	1978-79 FX-FXE	+4"	5
23-8911	1978-79 FX-FXE	+6"	5
23-8912	1978-79 FX-FXE	+8"	5
23-8906	1977-81 FX	Stock 14"	5
23-8952	1980 FXWG	Stock 22½"	14
23-8919	1982-83 FLT	26"	10
23-8920	1982-83 FLT	+4"	10
23-8926	1983 XLH-FXE-FXWG	Stock 24"	12
23-8927	1983 XLH-FXE-FXWG	+2"	12
23-8928	1983 XLH-FXE-FXWG	+4"	12
23-8951	1981 FXE-FXWG	Stock 24"	14

### Lower Lines-Dual Disc Lower Lines (2 required, sold each)

23-8908	1978-82 FX-FXE	Stock 19"	5
23-8959	1978-82 FX-FXE	-2"	5
23-8909	1978-82 FX-FXE	+2"	5
23-8910	1978-82 FX-FXE	+4"	5
23-8911	1978-82 FX-FXE	+6"	5
23-8912	1978-82 FX-FXE	+8"	5
23-8909	1977-82 FX, 1982-83 FXR-FXRS	Stock 21"	5
23-8910	1977-82 FXS-FXB-FXWG 1982-83 FXR-FXRS	+2"	5
23-8911	1977-82 FXS-FXB-FXWG 1982-83 FXR-FXRS	+4"	5
23-8942	1981 FXE-FXE	23"	14
23-8942	1981 FXE-FXE	25"	14





# Caliper and Wheel Kit

**Chrome Rear Wheel/Brake Assembly** for 1973-85 FX-FLH includes chrome 16" x 3.0 Wheel Assembly, chrome caliper, chrome 51T sprocket with bolts, 10" or 11½" rear drill brake disc, brake disc bolts, chrome caliper bracket, caliper support spring and chrome stay bar with bolts.

VT No.	Caliper Type
52-0600	10"
52-0601	11½"



# Rear Disc Kit



**Edart Rear Disc Kit** fits stock rigid frame applications. Disc is 49T sprocket with caliper and pads, axle, and sleeve and spacer to use with OE style star hubs.

VT No.	Item
22-0773	Kit
23-0785	49T Sprocket

## “Sprotor”



**Edart Sprotor Kit** includes 48T stainless disc sprocket.

VT No.	Item
23-0897	Kit
23-1711	Disc/Sprocket
23-1704	Replacement Brake Pad Set
23-0869	Bolt Set



# Front Caliper

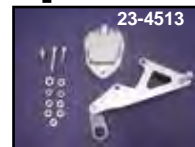

**GMA Billet Aluminum Brake Calipers** are machined from billet aluminum and clear anodized. Units feature dual pistons which are internally connected, brake pads and brackets, when provided. They include spacers and hardware necessary for installation. Hoses and brake discs are not included.

### Front

23-4503	FLH10	1973-83 FLH Front. Use 5/8" bore master cylinder
23-4508	400	1977-83 FX-XL Dual Kit, 8 piston 1980-83 FXWG. Use 3/4" bore master cylinder
23-9205	200DD	1949-73 FLH Dual Kit fits 10" brake disc 8 piston. Use 3/4" bore master cylinder
23-4513	200E	1974-77 FX Single Disc. Use 5/8" bore master cylinder

### Components

23-4520	PA2	GMA Caliper Piston, pair,
23-4521	PA4	GMA Caliper Piston, pair, fits 23-4508
23-4509	PA1	Caliper Piston, pair, fits 23-4503
23-4510	RB1	Caliper O-Ring Seal Kit fits 23-4503, 23-4513, 23-9205
23-4522	RB-4	Caliper O-Ring Seal Kit fits 23-4508
23-4512	A-Pad	SBS Brake Pad Set fits Calipers: 23-4503/23-4502/ 23-4500/23-4501
23-9169	F Pad	SBS Brake Pad Set fits Calipers: 23-4508, 23-9205
23-4514	B Pad	SBS Brake Pad Set fits Calipers 23-4513



# Rear Calipers



**GMA Billet Aluminum Brake Calipers** are machined from billet aluminum and clear anodized. Units feature dual pistons which are internally connected, brake pads and brackets, when provided. They include spacers and hardware necessary for installation. Hoses and discs are not included. Use with 5/8" bore master cylinders.

### VT No. GMA Model

23-4500	115	1981-84 FX-FL. Use 5/8" bore master cylinder and 11.5" disc
23-4501	100	1973-80 FX-FLH. Use 5/8" bore master cylinder and 10" disc
23-4502	R10	Rigid Frame with 10" brake disc

### Components

23-4509	PA1	Caliper Piston, pair, fits 23-4500, 23-4501
23-4510	RB1	Caliper O-Ring Seal Kit fits 23-4500, 23-4501
23-4512	A-Pad	SBS Brake Pad Set fits Calipers: 23-4500, 23-4501



# 1973-84 Big Twin Rear Disc Kit

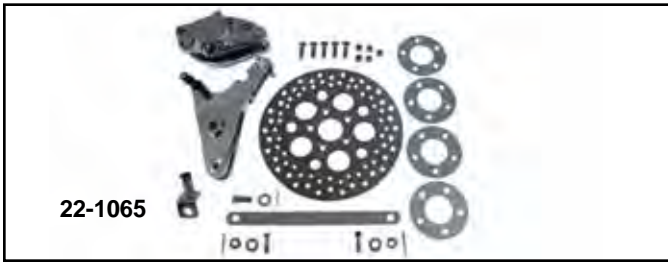

**Chrome Dual Action Rear Caliper Kit** for 1973-82 FX-FL models features twin pistons and an internal crossover passage which feeds brake fluid to a second piston within the inside caliper half. The kit includes 11.5" stainless steel brake disc, chrome bolts, chrome anchor arm, and a machined chromed alloy "Y" bracket.

VT No.	Item
22-1065	Complete Kit
23-9193	Caliper Rebuild Kit



**Caliper Conversion Kit** with 11.5" brake disc updates 1973-82 FX-FL models from 10" to 11.5" brake discs. Includes caliper bracket, 11.5" drilled brake disc in stainless or zinc plated steel, mount bolts and the dual piston caliper. By converting to this style caliper, rattle and chatter will be eliminated and a much greater stopping power will be achieved. Calipers should be used with master cylinders listed below. Use with 5/8" bore master cylinder.

VT No.	Item	Brand
22-1067	11.5" Kit with Stainless Steel Disc	GMA
22-1068	11.5" Kit Complete with Steel Disc	GMA
23-3028	Kelsey Type Master Cylinder	Edart
23-8915*	Rear Line Stainless Steel	Russell
23-8809*	Front Line Stainless Steel	Russell
23-0707*	Brake Tee	

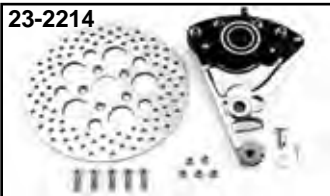

**Caliper Conversion Kit** includes 11.5" brake disc, caliper mounting bracket and caliper assembly. It helps eliminate caliper rattle and chatter.

VT No.	Rotor	Year
23-2216	Steel	1973-82
23-2214	Stainless	1973-82
23-1109	Chrome/SS	1973-82
23-1024	Chrome/SS	1982-86

## Brake Assembly Kit for 1958-85 Big Twin



**Swingarm/Brake Assembly Kit** for 1958-85 FL-FX contains all parts pictured, for stock tire width. Includes chrome swingarm with pivot pin and bearing kit,

chrome caliper and bracket, caliper anchor arm, 10" or 11.5" drilled steel (zinc) rotor, 16" x 3" complete chrome wheel, 51T chrome sprocket, 12" FX (spring) or FL covered shock set with shock studs and chrome axle assembly.

VT No.	Disc	Shock
55-0602	10"	FX
55-0603	10"	FL
55-0604	11.5"	FX
55-0605	11.5"	FL



**10" Caliper Kit** features all parts as pictured. The kit fits 1973-80 FX-FL and includes black or chrome rear caliper, 10" steel drilled disc, chrome bolts, chrome support bracket and anchor bar with bolts.



VT No.	Finish	Disc	Brand
23-2210	Black	Steel	Replica
23-2211	Chrome	Steel	Replica
22-0540	Chrome	Stainless	Replica
22-1087	Alloy	Steel	GMA





# 1973-82 Banana Rear Caliper



23-2219



23-2237



23-2218



23-2215



23-2240



23-2227



23-9193 for 23-2227



23-2217



23-3051



23-3055



23-0693



2855-7

**Rear Brake Caliper Guide Pin**

**Kit for 1982-Early 87.**

**VT No. Year Model**

**23-0693 1982-87 FX**

**2855-7 1980-85 FLT**

**Caliper Assemblies** are fully assembled with disc pads and all internals for rear FX-FL models and front FL models. Calipers accept 1/8" NPT line.

## Front

VT No.	OEM	Years	Finish
23-2219	44104-72A	1973-80	Black
23-2237	44105-72	1973-80	Chrome

## Rear

23-2218	44105-72	1973-80	Black
23-2215	44105-72	1973-80	Chrome
23-2240	44105-72	1973-80	Chrome
23-2227	44011-81	1981-82	Chrome Dual Piston for 11"
23-9193	Kit	1981-82	For Above
23-2217	44011-81	1981-82	Black
23-3051	44011-81	1981-82	Chrome
23-3055	44050-82A	1982-86	Chrome



23-0524

**Chrome 1973-80 FLH-FXE Caliper**

**Bracket** will accept stock 1981-82 caliper.

**VT No. Size**

**23-0524 10"**

**23-0542 11 1/2"**



**Caliper Mount Bracket** for 11.5" brake discs replaces 44015-81. Cast aluminum bracket fits all 1981-82 FX Big Twins with 11 1/2" discs only.

**VT No. Type**

**23-2256 Chrome**

**23-0578 Bushing for Pin**



23-2257



23-9186



23-0111



23-9033

**Caliper Mount Bracket** for 11.5" brake discs replaces 44027-82 and fits 1982-Early 87 FXST Big Twin with 11 1/2" rotors only.

**VT No. Finish**

**23-9033 Black**

**23-0898 Chrome**



23-1729



23-0861

**Caliper Mount Bracket and Anchor Arm** is for FX-FL with a 10" rotor.

VT No.	OEM	Year	Item
23-2257	44166-73	1973-80	Mount Bracket
23-9186	Special	Rigid	Mount Bracket
23-1729	44154-73	1973-82	Anchor Arm 12 5/8" length
23-0861	Special	1973-82	Anchor Arm 10 5/16" length
23-0111		1973-80	Caliper Support



23-3065

**Chrome Caliper Anchor Arm** for 1983-86 FL-FX models replaces 41039-82.

**VT No. 23-3065**



**Chrome Clevis Pin** replaces 40919-81 on rear caliper bracket. It includes washer and cotter for 1981-85 Big Twin.

**VT No. 23-1749**

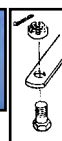

**Caliper Support Bar Bolts** secure bar to caliper bracket and swing arm on 1973-85 FX-FL models.

**VT No. Finish Brand**

**37-8135 Chrome V-Twin**

**9106-8 Chrome Colony**

**9107-8 Cadmium Colony**



# Rear Caliper Kit



**1973-80 FX-FL Black or Chrome Caliper** with chrome bracket set. Caliper includes all internal parts.

**VT No. Type**  
**23-0539** Chrome  
**23-0798** Black

## Caliper Rebuild



**Brake Rebuild Kit** includes all components pictured to fit 1973-80 banana rear calipers. Kit also includes an oversize ground pin to repair elongated mount hole in caliper body. **VT No. 23-1756**

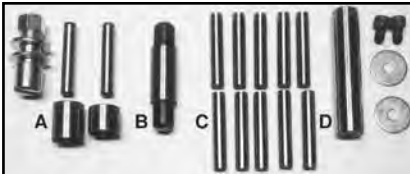

**(A) Caliper Pin Replacement Kit** for Big Twin eliminates brake squealing, grinding, caliper wobble. Kits include mounting stud, locknut and washer, 2 brake pad pins and stainless steel caliper mounting bracket bushing. Replaces 44331-73 for 1973-80 Big Twins.

VT No.	OEM	Item
23-1727	Kit	Complete
23-0113	45822-75	Short Bushing
23-0114	45821-75	Long Bushing

**(B-C) Rear Caliper Parts** are available as complete rebuild kit or as individual parts.

VT No.	#	OEM	Item
23-1732	B	44107-72	Mount Pin, each
23-1733	C	44124-72	Pad Pins, 10 pk

**(D) Oversized Caliper Mounting Pin Rebuild Kit** replaces stock mounting pin, by boring caliper hole oversize. Gives longer life of caliper housing before replacement. Complete kit with instructions.

**VT No. 23-1736**

**Chrome Caliper Mount Bolt Kits** mount through caliper to bracket on Big Twins.

VT No.	OEM	Type	Year/Fits
23-1726	44134-72A	12 Point	1973-80 BT, Rear 1972-80 BT, Front
2088-8	44134-72A	Allen	1973-80 BT,Rear 1972-80 FL,Front
37-8672	—	Allen	As Above,Front
23-0600	44132-72	Washers	For Above
37-0508	44201-82	Allen	1982-84 FX, Rear
37-0508T	As Above	Allen	1982-84 FX, Rear

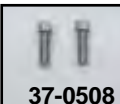

Caliper Thread Chart	
OEM Calipers	
Front:	All 1984-2002 Single Disc Calipers 3/8-24 banjo bolt
Rear:	All L1987-2002 Big Twin, TC/B, XL 3/8-24 banjo bolt
Front:	All 11984-2002 Dual Disc Calipers 3/8-24 banjo bolt
Rear:	1982-Early 87 FXR, XL; 84-Early 87 FXST; 83-86 FXWG 3/8-24 banjo bolt
Front:	1977-83 FX, FXWG, FXR, XL 3/8-24 Inverted Flare
Banana Caliper	1973-83 FL, FX, XL 1/8 NPT



**1972-84 Front and 1973-80 Rear Chrome Caliper Cover** includes mount studs.

**VT No. Item**  
**42-0312** Cover Kit  
**37-0093** Stud Set Only



**Disc Caliper Bleeder Screw Repair Kit** for replacing stripped threads in 1972-83 alloy caliper housing.

**VT No. 23-0110**



**Bleeder Screws** available in 10 pack.

VT No.	OEM	Size	Fits
23-0711	41749-58	1/4 — 28	1958-77 Caliper and Wheel Cylinder
37-8264	Chrome	1/4 — 28	As Above, 5 pack
23-1731	44146-77	3/8 — 24	1977-86, Late 1987-89 Front or Rear Calipers
37-8265	Chrome	3/8 — 24	As Above, 5 pack



**Speed Bleeders** by Russell feature a built in check valve and replaces the original bleeder screw for a permanent installation. Sold in pairs.

VT No.	Size
23-0520	1/4"
23-0521	3/8"

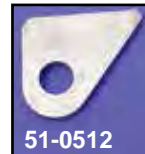

**Weld On Mount Tabs** fit Rigid Frames when mounting brake units.

VT No.	Type
51-0511	Hydraulic Rear Back Plate
51-0512	Caliper Arm Tab
51-0513	1987-99 Caliper Mount Strap (Right Side)
51-0845	1987-99 Caliper Mount Strap (Left Side)

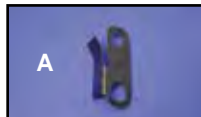

**Vibration Clips** fit as replacement to dampen pad rattles.

VT No.	#	OEM	Year	Type
23-1753	A	41768-73	1973-78	Front, FL
23-0112	B	41670-73	1973-81	Rear, FX-FL
23-9176	C	44211-82	1981-83	Rear





# Caliper Piston and Seal



**Pistons Only**, less seals, pistons are sold each.

VT No.	OEM	Front
23-1722	44109-72A	1972-Early 80 FL-FLH
23-1725	44118-80	Late 1980-84 FL-FLH
23-1723	44275-74	1974-77 FX, 1974-76 XL
23-2278	44157-77	1978-82 FX
23-1721	43946-79	1980-82 FLT
VT No.	OEM	Rear
23-1724	44129-73	1973-Early 80 FX-FL
23-1725	44118-80	Late 1980-84 FX-FL
23-1721*	43946-79	1980-86 FLT

\*Note: 1980-85 FLT have Dual Piston Caliper.

**Caliper Seal Kits** contain seal and dust boot for year listed.

VT No.	OEM	Front
23-0606	44277-74 44278-74	1974-77 FX Single Disc
23-0607	44151-77 44153-77	1979-83 XL FX-FXE Dual Disc
23-0608	44133-72 44127-72A	1972-Early 80 FL-FLH

23-0609	44007-80L 44133-72	1980-84 FLH
23-0610	43945-79 44947-79	1979-83 FLT

VT No.	OEM	Rear
23-0608	44133-72 44127-72A	1973-Early 80 All FL-FX
14-0923	44127-72A	O-Ring only for above
23-0609	44007-80 44133-72	Late 1980-84 All FL-FX
23-0610	43945-79 43947-79	1980-85 FLT Dual Piston Caliper



# Dual Disc Front Caliper 1977-83 FX



**Chrome Dual Disc Caliper and Rotor Set** includes two chrome calipers and two drilled discs. Fits 1977-83.

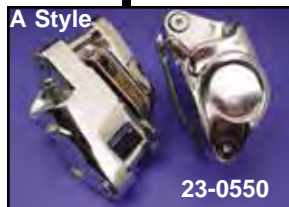

**Dual Disc Front Disc Calipers** includes body, piston, seals. Dual type fits 1977-83 FX-FXWG with 10" brake discs. Order mounting hardware separately.

VT No.	Side	Finish	Style
23-2221	Right	Black	A
23-1121	Right	Chrome	A
23-2238	Left	Black	A
23-1120	Left	Chrome	A
23-1119	Right and Left	Black	A
23-1122	Right and Left	Black, ET	B
23-2220	Right and Left	Chrome, Daytona	B
23-0550	Right and Left	Chrome, ET	A

## 1977-83 FX Dual Disc Caliper Hardware

VT No.	#	OEM	Item
23-0509	A	44098-77	Pad Set (4)
23-9198	B	44141-77	Seat, brake hose
23-1731	C	44146-77	Bleeder Fitting
23-0607	D	44151-77 44153-77	Seal, piston
23-2278	E	44157-77	Piston
23-0523	F	44158-77 44161-77	Plate, Outer Plate, Inner
23-1734	G	44162-77	Pin
24-0602	H	44173-77 44174-77	Screw
37-8970	I	—	Chrome Insert, Each
24-0603	J	46018-77 46019-77	Mount Bushing Set

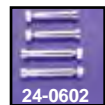
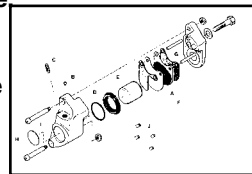

**Mount Bushing Set** fits in lower leg where caliper attaches. Set of four.

VT No.	OEM	Type
24-0603	46019-77	Lower (2) 1977-83
	46018-77	Upper (2)

VT No.	Item	Rotor
23-0250	Caliper Brake Disc Set	Zinc Steel
23-0258	Caliper Brake Disc Set	Polished Stainless Steel
23-0259	Caliper Brake Disc Set	Stainless Steel
8831-10*	Bolt Set FXWG	
8758-10	Bolt Set XL-FX	

\*Note: Two kits required.



**Chrome Lower Slider Set Only** fits 1977-82 dual disc 35mm forks.

VT No. 24-0541

# Caliper Inserts

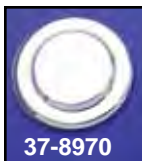

**Chrome Round Caliper Insert** fits 1977-83 dual calipers.

VT No. 37-8970



**Narrow Glide Axle Cap** with alloy finish. Fit 1973-83 FX models with 35 and 39 mm fork tubes.

VT No.	OEM	Fits
24-0505	45410-75	Left
24-0504	Chrome	Left

# 1974-77 Front Caliper



**Single Disc Caliper Kit** for 1974-77 FX includes billet caliper, 11.5" drilled zinc plated steel disc and mount bolts.

- |               |                       |
|---------------|-----------------------|
| <b>VT No.</b> | <b>Item</b>           |
| 23-0626       | Kit                   |
| 23-4513       | Caliper Only (GMA)    |
| 23-1100       | Caliper Only (Edart)  |
| 23-1106       | Caliper Only (Smooth) |

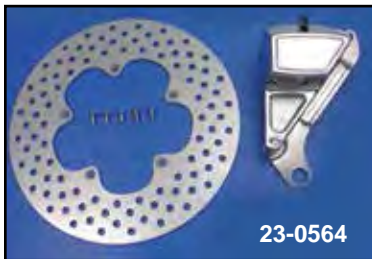

**Chrome Caliper Kit** for 1974-77 FX includes zinc or polished stainless steel 11.5" brake disc.

- |               |                 |               |
|---------------|-----------------|---------------|
| <b>VT No.</b> | <b>Disc</b>     | <b>Finish</b> |
| 23-0564       | Steel           | Zinc          |
| 23-0565       | Stainless Steel | Polished      |



**Single Disc Front Caliper Assembly** for 1974-77 FX features stock type construction in black or chrome with piston installed. Caliper units include zinc plated brackets and hardware. Fits 11.5" brake disc on stock 35mm forks.

- |               |               |             |
|---------------|---------------|-------------|
| <b>VT No.</b> | <b>Finish</b> | <b>Type</b> |
| 23-1730       | Black         | Stock       |
| 23-1737       | Chrome        | Stock       |

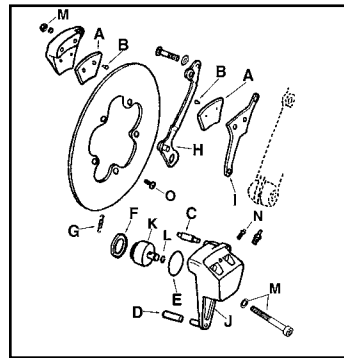

**Front Caliper Service Fix Kit** for 1974-77 includes seal kit, spring, pins and bleeder screw.  
**VT No. 23-0148**

## Single Caliper Pieces for 1974-77 FX.

- |               |          |            |                                       |
|---------------|----------|------------|---------------------------------------|
| <b>VT No.</b> | <b>#</b> | <b>OEM</b> | <b>Item</b>                           |
| 23-1723       | K        | 44275-74   | Piston                                |
| 12-0943       | L        | 44274-74   | Piston, Friction Ring                 |
| 23-0514       | A&B      | 44281-74   | Pad Set                               |
| 23-0606       | E&F      | 44277-74   | Caliper Seal Kit                      |
|               |          | 44278-74   |                                       |
| 23-0148       |          | Kit        | Service Kit includes C, D, E, F, G, N |
| 23-1747       | C&D      | 44280-74   | Caliper Pin Set, Two piece            |
|               |          | 44283-74   | Set                                   |
| 23-1995       | H        | 44272-74   | Anchor Arm                            |
|               | I        | 44276-74   | Plate, Floating Lining                |
| 23-0065       | —        |            | Anchor Arm Only                       |
| 37-8996       | M        | Kit        | Mount Bolt Kit Chrome                 |
| 23-1730       | J        | Complete   | Black Caliper Assembly with A-F+H,I   |
| 23-0711       | N        | 41749-58   | Bleeder Screw                         |
| 8759-5        | O        | 41191-74   | Chrome Rotor Screw Set                |



## Clover Leaf Style 11.5" Brake Discs for 1974-77.

- |               |             |                           |              |
|---------------|-------------|---------------------------|--------------|
| <b>VT No.</b> | <b>Type</b> | <b>Finish</b>             | <b>Brand</b> |
| 23-0302       | Drilled     | Zinc                      | Dura         |
| 23-0303       | Plain       | Zinc                      | Dura         |
| 23-0317       | Drilled     | Stainless Steel           | Russell      |
| 23-9042       | Drilled     | Stainless Steel, Polished | Russell      |
| 23-0358       | Drilled     | Stainless Steel, Polished | Dura         |
| 23-0636       | Drilled     | Stainless Steel           | Dura         |





# Replica Steel Brake Disc

V-Twin Mfg™ Brake Discs feature fine finish ground surface. Available with or without holes in steel unless construction is noted as stainless. Exactly interchangeable with stock discs. Order bolt set separately.



Drilled	Plain	OEM	Dia.	Bolt Kit	Fits
<b>FRONT</b>					
23-0304	23-0305	41813-79	10"	8738-10 Cast or Wire	1972-84 FLH 1973 only FX
23-0309	23-0310	41806-72B	10"	8738-10 Cast or Wire	1972-84 FLH, 1973 only FX with built in offset
23-0311	23-0312	44137-77A	10"	8758-10 Cast or Wire	1977-83 All FX Cast or Wire Wheel 1982-83 FXR Cast or Wire Wheel, 2 <sup>3</sup> / <sub>8</sub> " Inner Diameter Center Hole
23-0298	23-0299	44137-77A	10"	8831-10 Wire	FXWG 1980-83 Dual Disc Wire Wheel with 2" Inner Diameter Center Hole. Requires 2 Bolt Sets.
23-0370	—	44210-79	10"	8792-5	1979-83 FLT
23-0371	—	44210-79	10"	8792-5	As Above Stainless
<b>REAR</b>					
23-0304	23-0305	41791-79	10"	8738-10	1973-80 All FL 1978-80 All FX's Cast or Wire
23-0309	23-0310	41806-72B	10"	8738-10	1973-78 All Big Twin with built in offset
23-0307	23-0308	41791-79	11.5"	8791-10	1981-92 FXST-FXR Cast or Wire
—	23-0155	41791-79	11.5"	8791-10	1981-92 Softail-FXR (Stainless)
23-0297	23-0313	40909-81A	12"	8791-10	1981-84 FLH Cast or Wire .390" thick.
23-0297	23-0313	40939-79A	12"	8792-5	1979-85 FLT

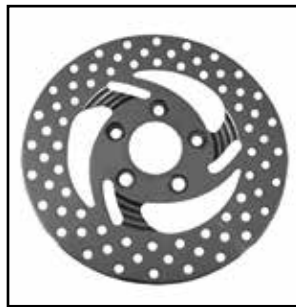

**Brake Disc Spacers** provide offset when required, with 7/16" bolt holes. Each disc measures 2 1/16" inner diameter with 4 5/16" outside diameter For 1980-99.

VT No.	Thick	Material
23-0320*	1/16"	Steel
19-0128	3/16"	Steel
19-0452	3/16"	Billet
19-0413	1/4"	Steel
19-0414	5/16"	Steel
19-0412	1/2"	Billet



\*Note: Use when installing flat brake disc on 1973-75 Big Twin.

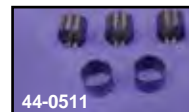

**Brake Disc Bolt Spacers** will adapt 1973-up FX-FL rear hubs to accept brake discs for front fork use, VT No. 44-0528 fits dual disc type 1980-83 FXWG.

VT No.	Outside Diameter	Inner Diameter
44-0528	3/8"	5/16"
44-0511	7/16"	3/8"
44-0554	7/16"	5/16"

## Polished 10" Brake Discs.

Note: VT No. 23-0848 has chrome center. All brake discs have 2" inner diameter center hole.

VT No.	Fits	Style
23-0847	Rear, Left	1973-80, Center hole is 2"
23-0848	Rear, Left	1973-80, Center hole is 1.98"
23-0854	Front, Right	1973-80
23-0849	Rear, Right	1973-80

# Stainless Brake Disc



**Drilled Stainless Discs** feature rustless finish for appearance and long service life, in Russell or Dura Rotor brand. Available in standard or polished finish. Russell High Performance and Dura stainless steel brake discs are compatible with all disc pads including sintered metal and OEM.

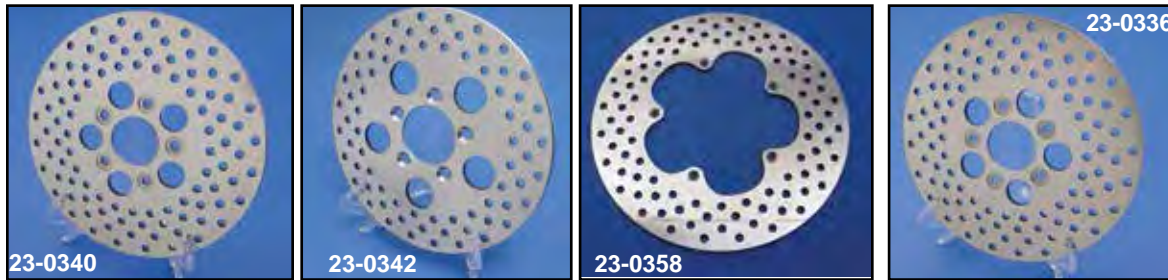

Dura Rotor		Russell		OEM	Dia.	Bolt Kit	Fit
Polished	Standard	Polished	Standard				
<b>FRONT</b>							
23-0340	23-0336	23-9043	23-0315	41813-79 or 44137-79	10"	<b>8738-10</b> Wire	1972-84 FLH, 1973 only FX Cast or Wire Wheel
23-0358	23-0636	23-9042	23-0317	41807-74	11.5"	<b>8758-10</b> Cast	2" Inner Diameter Center Hole
23-0342	23-0335	23-9046	23-0316	44137-77A	10"	<b>8759-5</b> C/W	1974-77 FX Cast or Wheel
23-0340	23-0336	23-9043	23-0315	44137-79	10"	<b>8758-10</b> Cast or Wire	1977-83 All FX Cast or Wire Wheel, 2 3/8" Inner Diameter Center Hole.
				41813-79 44137-79	10"	<b>8794-10</b> Wire	1980-83 FXWG Dual Disc Wire Wheel. Requires 2 Bolt Sets. 2" Inner Diameter



Dura Rotor		Russell		OEM	Dia.	Bolt Kit	Fits
Polished	Standard	Polished	Standard				
<b>REAR</b>							
23-0340	23-0336	23-9043	23-0315	41813-79	10"	<b>8738-10</b> Cast or Wire	1973-80 All FL 1978-80 All FX's Cast or Wire
	23-0439			41806-72B	10"	<b>8738-10</b>	1972-80 Big Twin Rear, Wire with built in offset
23-0341	23-0333	23-9044	23-0318	41791-79	11.5"	<b>8791-10</b> Cast or Wire	1981-92 FXST-FXR Cast or Wire



11½" Rear Brake Disc.			
VT No.	Item	Fits	Finish/Note
23-0687	18 Spoke	1984-up FXST	Polished Stainless
23-0388	Razor	1979-99 XL	Polished Stainless Note: Features stainless construction polished to high gloss. Order VT No. 8791-10 tapered screw set separately.
23-0583	Floating	1984-84 FX, FXST FXR	Order bolt set separately





# Brake Disc Pad Set

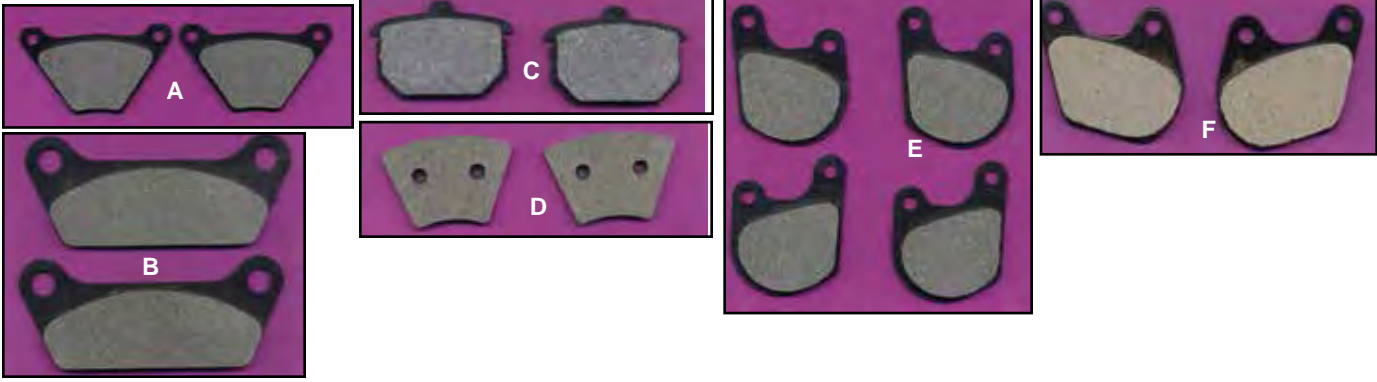

**Brake Disc Pads** are available in **Dura** or **SBS** brand. **Dura**, **Dura Disc Kevlar** for excellent stopping on all types of disc brake discs. **Dura Rotor** replacement pads are a soft organic compound designed to be compatible to all types of brake discs. **SBS brand** is available in **Sintered**, **Ceramic** or **Carbon Tech** compounds. **Sintered Metal Pads** provides maximum stopping power but can never be used in calipers that were originally equipped with non-sintered pads. Works best with stainless steel disc brake discs. **Ceramic Pads** are designed for general purpose use on carbon steel brake discs and can be used on calipers originally equipped with sintered metal brake pads. **Carbon Tech Pads** designed for use in all stock or aftermarket calipers. Works well with stainless steel or cast iron discs.

## Rear Disc Pad Sets for Stock Type Calipers

Fits	OEM	Dura Soft	Dura Ceramic	Dura Semi Metallic	Dura Kevlar	Dura Sintered	SBS Sintered	SBS Ceramic Tech	SBS Carbon	Photo #
1973-77 FL, FX	44131-73	23-0513	23-0913	23-0644	23-0621	23-0955	—	23-1761	23-1775	A
1973-81 FL, FX (Except FLT)	44005-78	23-0507	23-0913	23-0644	23-0621	23-0955	—	23-1761	23-1775	A
1980-85 FLT	43957-80	23-0508	23-0918	—	23-0628	—	—	23-1765	—	B
1982-86 FXR, FXST	44209-82	23-0511	23-0912	23-0641	23-0619	—	—	23-1764	23-1776	C

## Front Disc Pad Sets for Stock Type Calipers

1972-77 FL-FLH	44131-73	23-0513	23-0913	23-0644	23-0621	23-0955	—	23-1763	23-1775	A
1978-85 FL-FLH (Except FLT)	44005-78	23-0507	23-0913	23-0644	23-0621	—	—	23-1763	23-1775	A
1974-77 FX	44281-74	23-0514	23-0915	23-0645	23-0623	—	23-1767**	23-1786	—	D
1978-83 FX	44098-77	23-0509*	23-0911	23-0646*	23-0624*	—	—	23-1760*	23-1783*	E
1980-83 FLT	43395-80	23-0510	23-0999	23-0640	23-0618	—	—	—	23-9166	F

\*Note: Set of Four

\*\*Note: Dura Rotor Brand

# Brake Disc Bolt

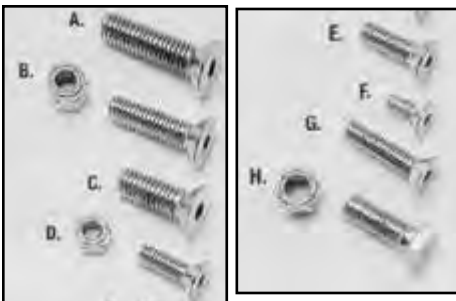

## Chrome Rear Brake Disc Bolts.

See listing for applications.

#	Thread
A	7/16 - 14 x 1 3/4
B	3/8 - 16 x 1 1/2
C	7/16 - 14 x 1 1/4
D	5/16 - 18 x 1
E	5/16 - 18 x 1
F	1/4 - 20 x 5/8
G	5/16 - 18 x 1 1/4
H	3/8 - 16 x 1 3/8
I	3/8 - 16 x 1
J	3/8 - 16 x 1



Brake Pad Assortment.  
VT No. 23-0000

## Chrome Front Brake Disc Bolts.

Wheel Type	Disc	Year	VT No.	#
<b>FX-FXWG-FXST-FXDWG</b>				
Spoke	Dual	1980-83	8831-10*	D
Spoke/Cast	Dual	1978-82	8758-10	E
Cast	Single	1974-80	9600-5	G
Spoke	Single	1974-80	8759-5	F
<b>FLH</b>				
Spoke/Cast	Single	1973-84	8738-10	H
Spoke/Cast	Single	1973-84	8739-10	I
<b>FLT</b>				
Cast	Dual	1982-85	8847-5	A
Cast	Dual	1980-81	8792-5	C

\*Note: 2 kits required.

## Chrome Rear Brake Disc Bolts.

Wheel Type	Year	VT No.	#
<b>FX-FLH</b>			
Cast	1979-91	9632-5	J
Spoke-Cast	1973-80	8738-10	H
Spoke-Cast	1973-80	8739-10	I
Spoke-Cast	1979-92	8791-10	B
Spoke-Cast	1981-84	8791-10	B
<b>FXST-FLST-FXR</b>			
Cast	1979-91	37-9236	J
Cast	1979-91	9632-5	J
<b>FLT</b>			
Cast	1980-81	8792-5	C
Cast	1982-85	8847-5	A

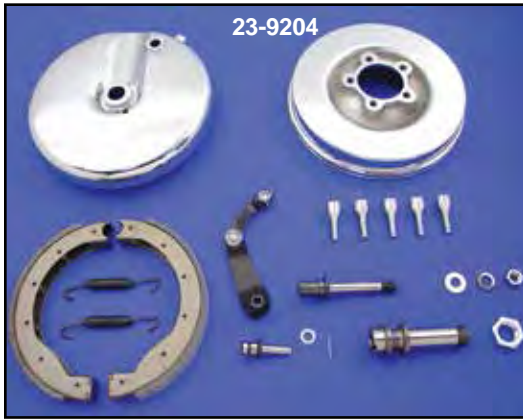

# 1949-71 Glide Brake Kit

**Glide Front Brake Backing Plate Kits** consist of all hardware including brake shoes, springs, backing plate, drum, axle sleeve, nuts, cam with lever and mount stud. Available for left side 1949-69 and right side 1969-71. Chrome kit includes chrome drum and chrome backing plate. Black kit includes black drum and polished backing plate.

VT No.	Year	Type	Side
23-9204	1949-66	Chrome Kit	Left
23-9218	1949-66	Black Kit	Left
23-9254	1967-68	Black Kit	Left
23-9222	1969-71	Chrome Kit	Right
23-9223	1969-71	Black Kit	Right

## Glide Part

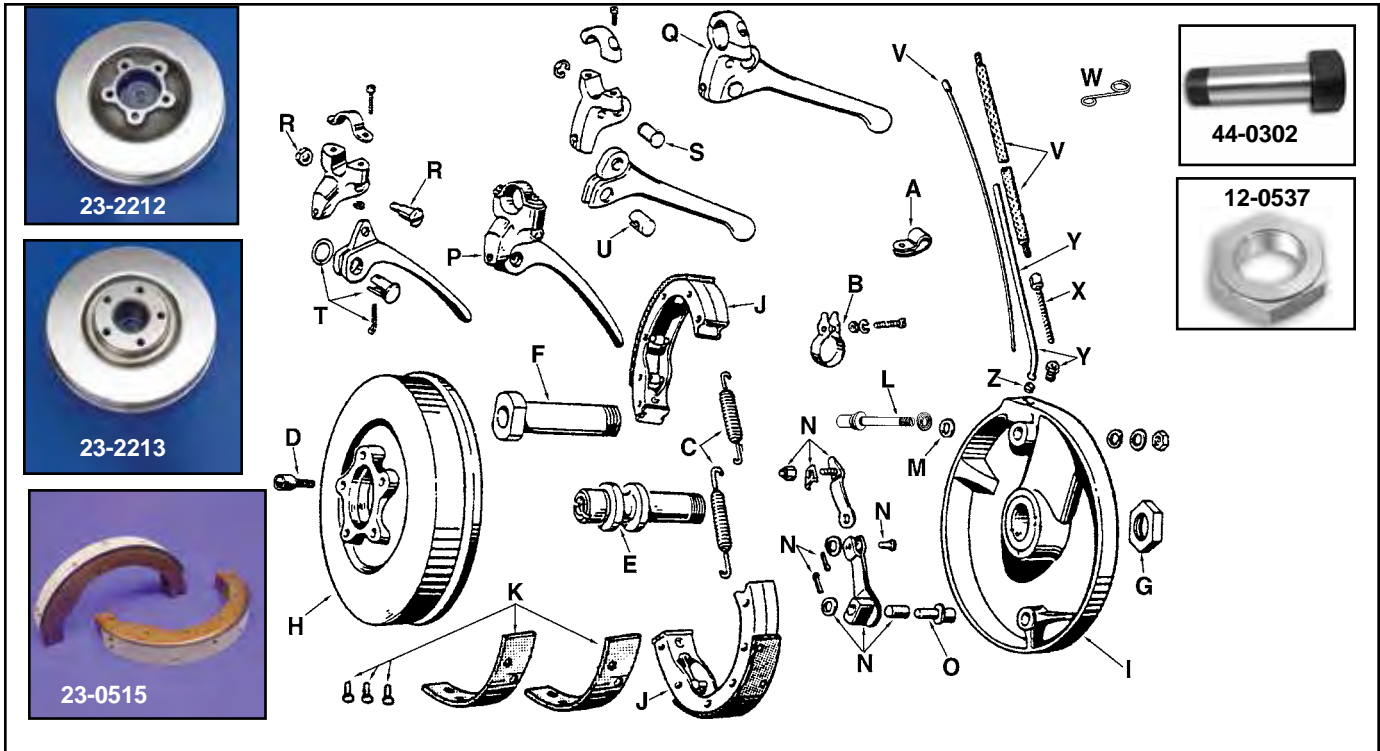

**Drum Parts** for 1949-72 Glide fit left unless noted as right.

VT No.	OEM	#	Item
37-0520	9963	A	Cable Clip
37-8776	9980	B	Clip, Bar, Black
13-0201	41835-57	C	1948-68 Shoe Springs
13-0146	41835-57	C	1969-71 Shoe Springs
37-8675	43530-35A	D	Lug Bolts, Parkerized
23-0440		D	Lug Bolts, Chrome
44-0301	43882-48	E	1948-66 Axle Sleeve
44-0302	43882-67	F	1967-71 Axle Sleeve
12-0537	43886-30	G	Axle Sleeve Nut
23-2212	44111-48	H	1948-66 Drum Chrome
23-9922	44111-48	H	As Above, Black
23-2213	44111-67	H	1967-71 Drum Chrome
23-2225	44111-67	H	As Above, Black
23-0081		I	Front Finned Drum, Black
23-2223	44141-50	I	1948-66 Side Plate Polished, left
23-2224	44141-50C	I	1948-66 Side Plate Chrome, left
23-2233	44141-50B	I	1967-68 Side Plate Polished, left
23-9231	44125-69	I	1969-71 Side Plate, Chrome, right
23-0515	44401-49A	J	1949-72 Set of Shoes, Complete
23-0390		J	As Above .025 Oversize
23-0505	44432-54	K	Set of Linings and Rivets
23-0450		K	As Above .025 Oversize
24-0127	44448-48	L	Pivot Stud
		L	with (M) locating washer

24-0128	44454-48	M	Locating Washer
24-0146	44490-48	N	Left Cam Lever Assembly includes
Kit	45175-49	N	Clevis
Kit	45216-49	N	Clamp
Kit	44525-49	N	Clevis Pin
24-0158	44490-69A	N	Cam Lever Assembly
	45175-69	N	1969-72 Right Side
23-1759	44499-48	O	Brake Cam Lever Stud
26-2126	45002-41	P	Early Lever Assembly, Polished
26-2127	45002-41C	P	As Above Chrome
26-0526	45002-65A	Q	1965-72 Lever Assembly
26-0525	45002-65	Q	As Above, Chrome
8819-4	45031-41	R	1941-64 Pivot Screw
26-0507	45031-41	S	1965-72 Pivot Pin, 10 pack
26-0506	45033-49	T	1941-64 Bushing, Lever, 5 pack
26-0505	45036-68	U	Pin and Bushings, 10 pack
	45039-68		For 1965-72 Lever
36-2385	45060-54	V	Cable and Housing 60"
31-0193	45092-66	W	Cable Guide
8818-3	45159-50	X	Adjusting Screw
24-0142*	45202-50	Y	1949-51 and 1969-91 Brake Cable Tube and Nut, Chrome
24-0644	45202-50	Y	Brake Cable Tube Only, Cadmium
24-0143	45200-60	Y	1960-68 Cable Tube and Nut, Chrome
24-0645	45200-60	Y	As Above, Cad
24-0131	45207-49	Z	Cable Tube Seat

\*Note: Includes adjuster screw (X).



**Pivot Stud Kit** for front brake shoes on 1949-71 FLH and 1958-71 Servi-Car. Kit includes 44448-48 stud and 44454-48 locating washer, which is serrated for positive lock on brake plate.

VT No.	Item
24-0127	Kit
24-0128	Washer, 5 pack





# Brake Cable Component



## Front Brake Cable Components.

VT No.	Model/Item	Finish
24-0142	1949-71 FLH Adjuster Tube Kit	Chrome
24-0644	1949-71 FLH Brake Cable Tube Only	Cadmium
8818-3	FL-XL Adjuster only	Cadmium
9741-2	FL-XL Adjuster only	Chrome
24-0143	1960-67 FLH Crossover Tube Left Side Brake	Chrome
24-0645	1960-67 FLH Crossover Tube Left Side Brake	Cadmium
36-2385	1948-71 FL, 1952-72 K-XL, 60" Brake Cable cut to length	
24-0095	1952-72 K-XL Cable Tube only	Chrome
24-0646	1952-72 K-XL Cable Tube only	Cadmium



## 1965-72 Glide Cable/Handle Assemblies.

VT No.	Finish
36-0576	Polish
36-0577	Chrome

**Glide Cable and Fitting Kit** features parts pictured to install brake cable on 1949-71 glide forks. Handle, cable, adjuster, tube and fitting are included.

VT No.	Item	Finish	Years
24-0141	Complete Kit (Polished Lever)	Chrome	1965-71
36-0415	Complete	Chrome	1949-64
36-0416	Complete	Cadmium	1949-64
24-0142	Tube and Adjuster Only	Chrome	1949-64
8818-3	Adjuster Only	Cadmium	1949-71
9741-2	Adjuster Only	Chrome	1949-71
36-0419	Adjuster Only	Chrome	1949-71
36-0420	Adjuster Only	Zinc	1949-71
36-2385	Cable Only		1949-71
36-2565	Cable Only		1949-71
<b>1949 Only</b>			
24-1375	Kit		1949
36-0892	Adjuster Only	Zinc	1949
36-0893	Clamp		
24-1405	Tube	Zinc	1949
26-0953	Handle		1949



**Cross Over Brake Tube Kits** allow the use of left side brake drum with 1949-68 footshift models with a right hand brake handle assembly. Kits include handle, cable, adjuster and cross over tube.

VT No.	Finish	Years
24-0204	Polish/Cadmium	1949-64
24-0205	Chrome	1949-64
24-0208	Polished	Riser Cover
24-0209	Chrome	1965-68

# Damper Knob Kit

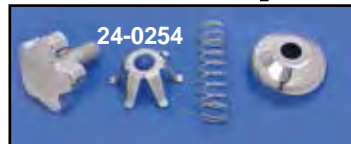
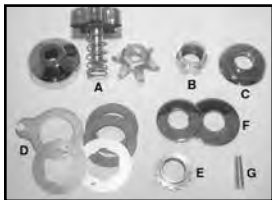

**FLH Glide Steering Damper Hardware** is for 1949-59 FL with drilled and tapped fork stem.

VT No.	#	Item
24-0753		Kit (A-B-D-G), Chrome
24-1461		Kit, Black
24-0254	A	Chrome Adjusting Knob Kit with spring and spider washer
24-0314		Kit, Black
24-0207		Damper Knob with Cover
24-0120	B	Crenelated stem nut (Cadmium)
24-0113	C	Chrome Seat Nut with Dust Guard
24-0115	D	Friction Disc Set, 5 piece Set (2)
15-0697		Friction Washer only
24-0175		Plate with Hole, each
24-0174		Plate with Pin, each
24-0176		Plate with Tab, each
24-0278	E	Cone Cover Nut
24-0117	F	Dust Shield Set Upper and Lower
37-9097	G	Frame Anchor Pin, each
24-1038		Black Cover



**Steering Damper Assembly Unit** for 1960-84 FL includes all pieces shown, including alloy adjusting knob. Order 24-9963 chrome handlebar clamp cover to complete installation.

VT No.	OEM	Item
24-0202	46700-60	Kit Complete
24-0201	46746-52	Knob Only
24-9963	Chrome	Riser Cover
24-1060	58589-60	Polish
13-0551	46751-48	Spring
24-0115	Set	Friction Set



**Steering Damper** is a machined alloy universal, multi-position, and adjustable damper. It can be secured between the frame and most forks. Fork tube and frame clamps are sold separately.

VT No. 24-0168

# 1973-84 FLH Glide



**FLH Style Fork Assemblies** are available as single disc model 1972-84 type, which accepts large banana caliper to accept a 10" brake disc. They include chrome slider covers, and chrome triple trees that accept aluminum cowlings and a lower tree that includes a padlock tab. Also included axle and nut, neck bearings, top nut, crown nut, chrome tapered aluminum sliders with stock length tubes and all 1977-up type internals installed. Lower sliders and tube assembly with internals also available in pairs. **Note:** When using a 1972 wheel order axle 44-0228 separately.

VT No.	Item	Slider
24-0520	Kit	Polished
24-0795	Kit	Chrome
24-9943	Kit Custom	Forks include 24-0829 black trees which have a solid mount top. Trees with 4 3/4" center to center riser mount holes. Accepts 24-9900 top tee cover and tins
24-1240	Kit	Chrome Leg/Tree Assembly
24-0519	Leg Assy	Right and Left with Chrome Lower Sliders
24-0084		Chrome Lower Sliders Set
24-0087		Polished Leg Set

**\*Note:** V-Twin fork assembly is shipped complete with axle, nut, spacer, top nut, bearing, cone nut and dust cover. Sliders and tubes are assembled.

## Adjustable Fork Assembly



**Adjustable Fork Assemblies.** FLH include black adjustable rake triple tree set, polished sliders with 1977-up type internals installed, stainless slider covers, axle and nut, fork bearings, and cone nut. VT No. 24-2525 and 24-0790 accepts 23-2219 caliper. 24-0550 accepts left side brake component kit VT No. 23-9218. Units accept VT No. 28-0221 riser bushing sets and VT No. 24-9910 top tree cover which place riser stems 3.5" center to center.

VT No.	Type	Year
24-0550	Left	1949-66
24-1865	Left	1967-71
24-1866	Right	1967-71
24-2525	With Chrome Sliders	1972-84
24-0790	Polished	1972-84

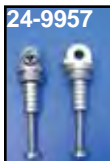

**Adjustable Fork Tube Plugs.**

VT No.	Year	Finish
24-9957	1950-76	Zinc
24-0828	1977-84	Zinc
24-1828	1977-84	Chrome



**Adjustable Position Tab Set** replaces 45710-58 on all adjustable forks 1950-up. **VT No. 24-0124**



**Fork Stem Lock Tab** for 1948-84 FLH-FXWG. Replace broken, bent or missing tabs on stock lower triple trees, to be welded on. **VT No. 51-0103**

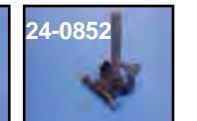

**Black Adjustable Fork Tree Kit** is available for 1949-76 FLH, 1977-84 FLH, 1980-86 FXWG 41mm fork legs. Showa type is 1977-up. Kits feature swivel type plugs which are included. Lower tree has two positions for changing rake and fork lock tab. Kits use VT No. 28-0221 rubber bushing kit and VT No. 24-9910 top tree cover.

VT No.	Fits
24-0799	1949-76 FLH Complete Set, Black
24-0797	1977-84 FLH 80-86 FXWG Complete, Black
24-0004	As Above without Tabs
24-1055	Partial Kit
24-5001	Partial Kit
24-0817	Top Tree Only 1973-up
24-0852	Lower Tree only with Stem
24-1069	Lower Cross Bar without Slider Cover Tabs
24-0928	Lower Tree only with Stem with damper
24-0495	Lower Cross Bar only with tabs for slider covers
24-0124	45710-50 Adjustable Position Tabs
24-9957	45777-50 Early Top Plugs 1949-76, pair
24-0828	45777-77 Late Top Plugs 77-84 Showa type, pair.
37-9170	Top Tee Bolts with Lock Tabs, Kit
17-0936	45752-50 Lock Tabs
24-0197	Top Nut Kit
37-1545	Pivot Bolt
24-0798	Early Top Tree





# Glide Drum Brake Fork



1949-59 Units feature early style solid mount trees.



24-0789

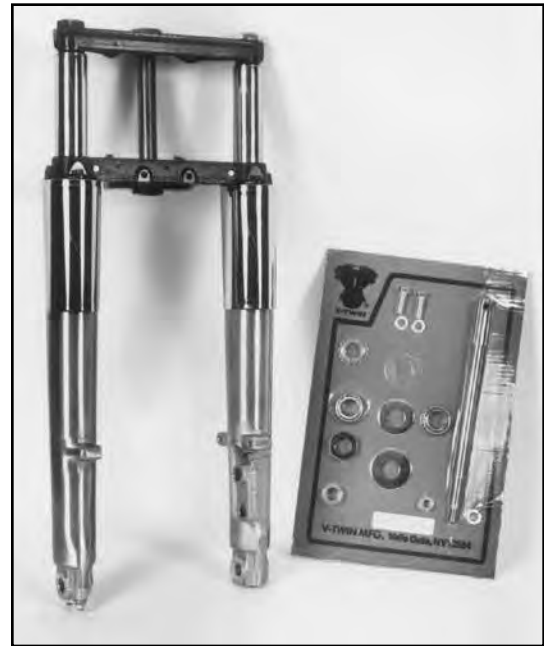

DRUM

Glide Fork Assemblies feature black lower triple tree without lock tab and accept a left or right side drum brake assembly with chrome or polished slider.

The 1960-71 Style has a black top tree with 3" center to center spacing which will accept rubber bushing kit VT No. 28-0221. VT No. 25-2134 riser clamp fits two piece bars. VT No. 25-2132 Riser Kit fits one piece bars.

Both VT No.'s 25-2134 and 25-2132 riser kits allow the use of 24-0250 handle-bar clamp cover on aluminum cowl. Both forks accept VT No. 24-0251 aluminum cowl set or 3 piece chrome VT No.'s 24-9913 or 24-9909 stainless panel set, not included. Includes slider covers VT No. 24-0190 in chrome. Both have polished aluminum lower sliders with late 1977-up type internals installed in 41mm stock length hard chrome fork tubes. Axle nut, neck bearing, top crown nut and dust covers included.



24-0880

### Complete Fork Assembly

VT No.	Year	Brake Side	Slider
24-0789	1949-59	Left	Polish
24-0790	1949-57	Left	Chrome
24-0755	1949-59	Left	Chrome
24-0756	1960-66	Left	Polish
24-0757	1960-66	Left	Chrome
24-0866	1967-68	Left	Polish

24-0880	1969-71	Right	Polish
24-0881	1969-71	Right	Chrome

### Leg Assembly Only

24-0791	1949-68	Left	Polish
24-0754	1949-68	Left	Chrome
24-0845	1969-71	Right	Polish
24-0846	1969-71	Right	Chrome



Cooling Ring clamps to brake drum on 1949-72 Big Twins. VT No. 24-9982



23-0083

Cast Drum with fins. Fits 1949-66.

VT No.	Finish
23-0081	Black
23-0083	Chrome



42-0311

Chrome Front Caliper-Disc Covers for 1972-84 front FLH, or 1973-81 rear FX-FL.

VT No.	Year	Fits
42-0311	1973-80	Front Disc
42-0312	1972-84	Front Caliper
	1973-80	Rear Caliper
37-0093		Caliper Cover Bolt Set



Fork Installation Kits for 1949-66 FLH. VT No. 24-0777

## Hardware



Glide Axle Leg Caps are cast for 1949-77 FLH type. They replace 45836-48.

VT No.	Finish
24-0327	Zinc
24-0337	Chrome

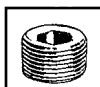

Lower Leg Drain Allen Plug replaces 45830-48 on 1948-76 FLH lower legs.

VT No.	Finish
37-8777	Zinc
9909-2	Chrome
37-0062	Stainless Steel

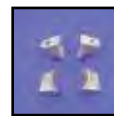

Weld On Tabs of cast alloy are used to restore FLH Glide legs to accept fenders, they must be welded on to stock or turned down legs. Sold as four piece set.

VT No. 24-0152



Chrome Fork Slider Bottom Cap Stud and Nut Kit includes locknuts and studs.

VT No.	Year	Model
8813-4	1949-77	FLH Wideglide
8826-6	1973-up	Showa and Kayaba



Big Twin Glide Lower Leg Cap fits 1977-99.

VT No.	OEM	Finish
24-0328	45832-77	Polish
24-0336	45832-77	Chrome



# 41mm 10" Dual Disc Fork Assembly



**Glide Fork Assembly** with chrome sliders accepts left side drum brake. Assembly features black triple trees without lock tab and 3" center to center spacing which will accept rubber bushing kit.  
**VT No. 24-0867**



**41mm Glide Fork Assemblies** include forged chrome replica triple trees and hard chrome tubes on stock length forks, chrome tubes on overstock length and polished or chrome lower legs with all internals installed less hardware. Stock overall length is 31".



**49mm Fork Assembly** includes chrome upper and lower trees with stock tubes and chrome sliders. Fits 1971-99 FX.  
**VT No. 24-1319**

**FXWG Style Dual Disc Fork/Wheel and Caliper Assemblies** to fit 1948-99 Big Twin FL-FX-FXWG feature polished or chromed lower sliders without reflector boss, hard chrome fork tubes and internals installed. Includes chrome trees with 1" diameter stem and frame lock tab, neck bearings, axle spacer and top nut. Stock length is 31" overall. Kit also includes 21" all chrome assembled wheel with bearings, drilled 10" steel brake discs with chrome screws, and choice of black or chrome dual disc calipers complete with pads. VT No. 24-9947 has smooth lower legs.

**Dual Disc Fork Assembly** uses two 11" rotors for FL-FX 1971-84.  
**VT No. 24-0086**



VT No.	Item	Caliper	Sliders
24-2000	Kit	Chrome	Polished
24-2011	Kit	Chrome	Chrome

Fork Assembly Only		
24-0779	Fork Assembly	Polished
24-9974	Fork Assembly	Chrome
24-9947	Fork Assembly	Polished

**Fork Installation Kit** fits 1973-84 FL, 1980-83 FXWG.  
**VT No. 24-0776**

The V-Twin™ Fork Assembly is shipped complete with axle, axle nut, spacer, top nut, bearings, cone nut, dust cover, triple trees, fork tubes and sliders. Fork tubes and sliders are fully assembled with internals. Final assembly of the remaining components is done by the dealer. Every leg assembly is shipped dry. We recommend use of the appropriate fork oil such as Type B. The amount of fork oil to add varies by model. A FX will need about 6 oz per leg, a FL will need about 8.5 oz per leg and a FXWG needs about 10 oz per leg. Due to oil cling, a dry fork leg needs about 1 oz more to fill than a drained leg would require.

## Bare Fork Assembly



**FXWG Dual Disc Fork Assembly Front Wheel Speedometer Drive Kit** will allow use of 2:1 ratio speedometer. Kit includes axle, speedometer drive and adapter flange.  
**VT No. 36-0547**



**Fork Installation Kit** includes two bearings, dust covers, top nut axle and related hardware. Fits 1980-83 FXWG with dual disc.  
**VT No. 24-0776**

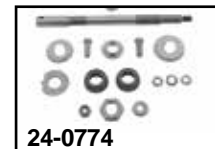

**Bare Fork Assembly** includes stock leg assembly with hard chrome tubes on stock length forks and chrome tubes on overstock length and polished or chrome lower legs with all internals installed, with chrome triple tree set, less hardware. Stock overall length is 31".

	(A) FXWG, Dual 10"		(B) FXST, Single 11.5"		(C) FXST, Dual, 11.5"	
	Polish	Chrome	Polish	Chrome	Polish	Chrome
Stock	24-1500	24-1525	—	24-1532	24-1501	24-1546
2"	24-1503	24-1526	24-1509	24-1533	24-1515	24-1540
4"	24-1504	24-1527	24-1510	24-1534	24-1516	24-1541
6"	24-1505	24-1528	24-1511	24-1535	24-1517	24-1542
8"	—	—	24-1512	24-1537	24-1518	24-1543
10"	—	—	24-1513	24-1538	24-1519	24-1544
12"	—	—	24-1514	24-1539	24-1520	24-1545

**Fork Installation Kit** includes two bearings, dust covers, top nut, axle and related hardware.

VT No.	Type	Year	Model
24-0776	2 Disc	1980-83	FXWG
24-0774	1 Disc	1984-99	FXST
24-0833	1 Disc	1986-99	FLST
24-0772	2 Disc	1984-99	FLT
24-1158	2 Disc	2000-07	FLT
24-0773	2 Disc	1986-99	FLST





# 35 mm Fork Kit



**35mm FX-FXR Fork Assembly with Cast Lower Sliders.** Complete Narrow Glide Fork Assemblies for FXE and FXR models.

Dual	Year	Model
24-8550	1977-84	FXE
24-8551	1982-83	FXR
24-8568	1982-83	FXR



**Chrome Lower Slider Set Only,** fits 1977-82 dual disc 35mm forks. **VT No. 24-0541**



**Fork Stem Lock Tab** replaces broken, bent or missing tabs on stock lower triple trees, to be welded on. Fits 1971-84 FXE. **VT No. 51-0102**

### Lower Tree Applications.

VT No.	OEM	Fits	Tube Size (mm)
24-0804	Black	1971-72 FX	33.4
24-0805	Black	1973-83 FX	35
24-0827	Chrome	1973-83 FX	35
24-1160	Stem Only	1" bearings tapered inner diameter	



### Lower Stem Pinch Bolts.

VT No.	Type	Fits	Finish
37-8834	Hex	1973-86 FX	Zinc
37-9220	Allen	1973-86 FX	Chrome



**1973-83 Narrow Glide Axle Cap.** Fits FX models with 35 and 39 mm fork tubes.

VT No.	Finish	Fits
24-0505	Alloy	Left
24-0504	Chrome	Left
24-0507	Alloy	Right

# 33.4 and 35 mm Fork Plug



**E-Z Fill Fork Tube 35mm Top Plugs** feature small oil fill cap built in to fork tube top plug which will allow fork oil change/fill without removing top fork cap. Sold as a pair. Fit 1973-85. **VT No. 24-0862**



**Fork Tube Spring Retainer and Pin Wrench Kit** includes two retainers for 1952-72 Sportster and pin wrench for installation and removal of retainers. **VT No. 7700-3**



# 35 mm Fork Tube and Slider Assembly

**Fork Tube and Slider Assembly** available in right and left pairs, completely assembled. Units have hard chrome fork tubes, and either polished or chrome lower sliders, with springs and all internal components installed. Dual Disc.

VT No.	OEM	OEM	Fits	Slider
24-9969	45900-80	45901-80	1977-83 FX	Polished
24-0589	As Above	Chrome	1977-83 FX	Chrome
24-9938	45900-80	45901-80 +2"		Polished
24-8567	1977-83	FXE		Chrome



**Top Triple Tree** for FX with 33.4 or 35 mm tubes.

VT No.	OEM	Year	Finish
24-0801	45739-62B	1971-72	Cast
24-0802	45738-73	1973-84	Cast
24-0803	45738-73	1973-84	Polished
24-0826	45736-78B	1973-84	Chrome

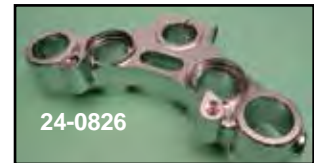

### Chrome 35mm Forged Aluminum Fork Brace

adds rigidity to forks by clamping to fork seal area of lower leg. Fits FX-FXR with 35mm forks 1973-87. **VT No. 24-0323**



**Lower Fork Stem Covers** are for FXR-FXD 1957-85 with 35mm forks. VT No. 42-0290 can be installed without disassembling forks. VT No. 42-0308 replaces 45750-70 in one piece style.

VT No.	Type
42-0308	One Piece
42-0290	Three Piece
8757-8	Allen Screws for Above

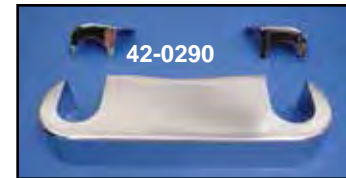

### 35 mm Taper-Top Socket Fork Cap Set.

Unique tapered style uses hex wrench for installation. Fits 1973-84 FX for Showa Kayaba. **VT No. 24-0850**



### Chrome Domed Top Bolt fits 35 mm.

VT No.	OEM	Fits
7622-1	45993-73	1973-85 FX
37-8988	As Above	Pair
24-0616	Washer	10 pack



### Chrome Top Fork Tube Plug

fits 1952-71 33.4 mm tubes. Replaces 45756-59. Sold each. **VT No. 7621-1**





# Fork Tube

**Attention!!**  
 These fork tubes have been manufactured and tested for exact fit and application per model. It can be difficult to identify the front end assemblies because they may not always be original equipment. Before installing, compare old and new tubes. Be sure the stock top plugs fit into the new fork tubes. To avoid scratching the chrome, we suggest that the tubes be lightly rubbed with oil before installing into fork legs. Be absolutely sure you have the right tubes before you install them. No fork tubes can be accepted for return that are scratched or damaged due to improper installation or handling.



## 33.4mm

1954-72 XL and 1971-72 FX

24-0012 Stock 22<sup>3</sup>/<sub>4</sub>" replaces 45953-71, Hard Chrome

## 35mm

1975-83 XLH-XLCH-XLCR, 1983 XLX-XLS and 1976-83 FX-FXEF, Showa for 35mm forks.

24-0013 Stock 23<sup>1</sup>/<sub>4</sub>", replaces 45407-75 Hard Chrome

24-0440 As Above, Chrome

24-0425 2" over stock, replaces 45644-77, Chrome

24-1351 2" over stock, replaces 45644-77, Hard Chrome

24-0426 4" over stock, Chrome

24-0427 6" over stock, Chrome

24-0428 8" over stock, Chrome

1979-82 XLS and 1977-83 FXS-FXB-FXSB-FXR-FXRS models, Showa for 35mm forks.

24-0425 Stock 25<sup>1</sup>/<sub>4</sub>" replaces 45644-77, Chrome

24-1351 Stock 25<sup>1</sup>/<sub>4</sub>" replaces 45644-77, Hard Chrome

24-0426 2" over stock, Chrome

24-0427 4" over stock, Chrome

1973-74 XL and 1973-77 FX-FXE, Kayaba for 35mm forks.

24-1073 Stock 23<sup>1</sup>/<sub>2</sub>", Chrome with internals

24-0015 Stock 23<sup>1</sup>/<sub>2</sub>", replaces 45977-73, Hard Chrome

24-0421 2" over stock, Chrome

24-0422 4" over stock, Chrome

**Note:** Fork tubes that have been installed into triple trees are not returnable as the installation mars the chrome finish.

# 41mm Fork Tube and Slider Assembly



24-9917



24-0516



24-0763



24-0400

## 41mm

FL-FLH Fork Tubes

1949-Early 77 FL for 41mm forks.

VT No.	Item	Finish
24-0400	Stock 20", replaces 45950-48	Chrome
24-0023	Stock 20", replaces 45950-48	Hard Chrome
24-0024	As above machined steel	Plain Steel
24-0401	2" over stock	Chrome
24-0402	4" over stock	Chrome
24-0403	6" over stock	Hard Chrome



24-0408

Late 1977-84 FL-FLH, 1980-83 FLT-FLHT for 41mm forks.

24-0406 Stock 20<sup>7</sup>/<sub>8</sub>", replaces 45825-77A

24-0025 Stock 20<sup>7</sup>/<sub>8</sub>", replaces 45825-77A, Hard Chrome

24-0407 2" over stock, Chrome

24-0408 4" over stock, Chrome

24-0026 As Above, Hard Chrome

24-0059 6" over stock, Hard Chrome

1980-83 FXWG for 41mm forks

24-0408 Stock Length 24<sup>7</sup>/<sub>8</sub>", replaces 45417-80, chrome

24-0026 Stock Length 24<sup>7</sup>/<sub>8</sub>", Hard Chrome

24-0059 2" over stock, Hard Chrome



24-0032



24-0999

FL 1949-76 Leg Assembly includes all internals.

VT No.	Finish
24-0032	Hard Chrome
24-0999	Raw



24-0087

Fork Tube and Slider Assembly is available in right and left pairs, and is completely assembled. Units have hard chrome fork tubes, and either polished or chrome lower sliders, with springs and all internal components installed.

VT No.	Disc	Fits	Slider
24-9917	Dual	1980-83 FXWG	Polished
24-0516	Dual	1980-83 FXWG	Chrome
24-0763	Dual	1980-83 FXWG	Smooth Legs Polished
24-1341	Dual	1980-83 FXWG	Chrome
24-0519	Single	1973-84 FLH	Chrome
24-0783	Single	1973-84 FLH	Polished
<b>Lower Slider Set Only</b>			
24-0087	Single	1973-84 FLH	Polished



24-1341



24-0519



24-0783





# Fork Damper Tube

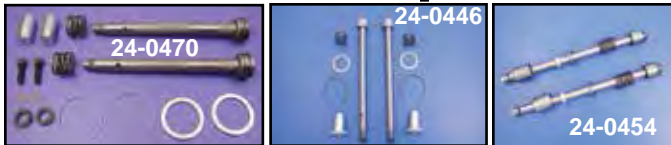

**Fork Damper Tube Kit** includes damper tubes with rings, screws and washers, lower stops, slider seal washers and retaining rings for both sides.

VT No.	Fork Type	Fits	MM
24-0136	Wide Glide	1949-76 FLH	41
24-0447	Showa	1977-84 FLH	41
24-0445	Showa	1980-83 FXWG	41
24-0454	Steel Leg	1971-72 FX	33.4
24-0457	Kayaba	1973-76 FX	35
24-0446	Showa	1976-83 FX	35

**Fork Damper Tubes** are sold in pairs without hardware.

VT No.	OEM	Fits
<b>41mm</b>		
24-0133	46100-48	1949-76 FLH
24-0820	45418-80	1980-83 FXWG
24-0147	45831-77	1977-84 FLH
<b>35mm</b>		
24-0096	45409-75	1975-83 FX, Showa
24-0675	45412-75	1975-86 Nylon Ring



## Fork Internal

**33.4 mm Fork Bushing Set.** Fits 1952-72 FX, 4 piece. Replaces 45818-52  
VT No. 24-0145



**Damper Tube Screw.**

VT No.	OEM	Type/Model
24-0188	45995-73	Kayaba, 1973-86
24-0787	45405-75A	Screw pair with washer for Showa
24-0786	Showa	Screw only, 5 pack
24-0328	45832-77	Leg Cap for Showa forks

**1973-76 Kayaba Fork Internals,** sold in pairs.

VT No.	#	OEM	Item
24-0189	B	45978-73	Tube Piston
12-0945	C	45979-73	Piston Snap Ring
24-0219	D	45985-73	Top Spring Collar
12-0988	C	45932-73	Upper Snap Ring

**Fork Internal Kit** includes springs, damper parts and plugs for FLH.

VT No.	Years
24-0743	1949-76
24-0744	1977-84

**Lower Damper Tube Stops,** sold in pairs.

VT No.	OEM	Fits
24-0129	46121-48	1949-76 FLH
24-0459	45918-73	1973-77 FX Kayaba
24-0094	45402-75	1976-83 FX Showa
24-0258	45834-77	1977-83 FL-FXWG

**Lower Damper Tube Springs.**

VT No.	OEM	Fits
13-9210	46062-71	1971-72 FX, pair
13-1945	43855-77	1977-up FL-FXWG-FXST, pair
13-9160	45382-83	1983-86 FXR-FX, 10 pack



**Glide Front Fork Damper Set** is for both sides for 1949-77 Big Twin.  
VT No. 24-0136

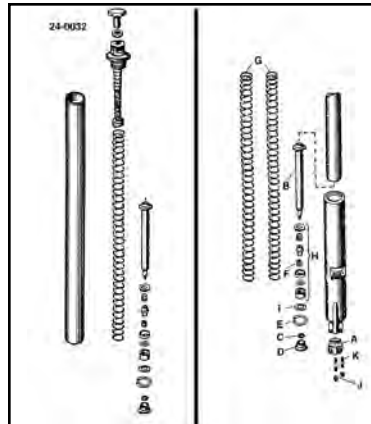

VT No.	#	OEM	Item
24-0327	A	45836-48	Leg Cap
24-0133	B	46100-48	Damper tube only, pair
15-0218	C	46111-48	Gasket
15-0219		46125-48	Upper Gasket
15-0220		45850-48	Felt Washer
24-0129	D	46121-48	Lower Damper Bushing, pair
12-0920	E	46172-48	Retaining Rings, 10 pack
13-9156	F	46161-49	Damper Valve Spring, 10 pack
24-0907	G	46051-49A	Fork Spring, pair
12-0707	I	45826-49	Damper Shim
8813-4	J/K	7725	Studs and Nuts
		45840-48	
24-0032			Leg Assembly, pair



**Replica Glide Bushing Set** for 1949-76 Big Twin includes two long and two short bushings.  
VT No. 24-0132

**Front Fork Damper Parts** for 1949-76 FL Glide forks. VT No. 24-0032 leg set includes tubes with all internal parts installed.

## Fork Drain Plug

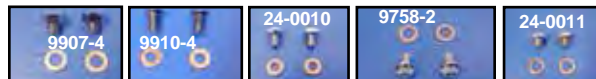

**Fork Drain Screws** are supplied with washers, sold in pairs.

VT No.	OEM	Use
9907-4	46201-52	1952-72 XL-K
	6218W	Chrome
9908-4	As Above	Cadmium
9909-2	45830-48	1948-Early 77 Chrome
9910-4	45790-80	1973-up Showa Fork Lower Legs
	45986-73	
24-0010	45790-80	1976-up Showa Fork Lower Legs
9758-2	45858-77	1977-up FLH, 1980-up FXWG
24-0011	45858-77	1977-up FLH, 1980-up FXWG

**Drain Screw Washers** are available in a 10 pack.

VT No.	OEM	Years	Use	Material
14-0959	6218W	1952-72	Early XL	Copper
14-0019	45986-73	1973-75	Kayaba	Fiber
14-0020	45403-75	1976-up	Showa	Fiber

**Damper Tube Washers** are sold in 10 pack.

VT No.	OEM	Model
14-0017	45992-73	1973-74 XL Kayaba
	Fiber	1973-76 FX
14-0018	45406-75	1975-up XL Showa
	Copper	1976-up FX



# Fork Spring



**Progressive Suspension Fork Lowering Kit** comes with Progressive rate fork springs and spacers. Each kit can be installed at two different levels to lower fork 1" or 2". Fits 1984-up FXST-FLST, 1993-up FXDWG, 1980-up FLH-FLT, 1978-86 FL-FXWG.  
**VT No. 24-1561**



**35mm Progressive Suspension Fork Springs** feature high quality and performance replacement fork springs. Eliminate front end sag, reduce nose dive under braking, improve cornering stability, increase ride

comfort and allow forks to utilize full travel. Sold in pairs. Fit 1983-87 FXRT, 1982-87 FXR-FXRS, 1985-86 FXRD, 1973-86 FX-FXE-FXS-FXSB. **VT No. 24-2040**



**Fork Spring Lowering Kits.** Installation requires minor disassembly to lower the front forks 1/4" or 2" depending on the spacer used. Kit includes springs, spacers and hardware. Easily converts back to stock by reinstalling stock fork springs.

**24-0159** 40 1980-83 FXWG  
**24-0161** 35 1975-82 FX



**Fork Tube Spring Sets** feature high tensile strength wire construction with ground ends. Sold in pairs for OEM replacement per the factory number. For more fork spring applications check factory parts book.

VT No.	Year	Model
<b>33.4mm</b>		
<b>24-0900</b>	1971-72	FX-XLH
<b>35mm</b>		
<b>24-0901</b>	1973-77	FX
<b>24-0904</b>	1976-83	FX-FXE
<b>24-0903</b>	1977-83	FXS-FXS-80-FXB
<b>24-0906</b>	1982-83	FXR
<b>41mm</b>		
<b>24-0907</b>	1949-77	FL-FLH
<b>24-0908</b>	1977-84	FLH, 1980-83 FLT
<b>24-0902</b>	1980-83	FXWG

# Fork Boot



28-0439



**"Gaiter" Fork Boots** are flexible type for 41mm forks or 39mm forks. Rubber boots are 230 mm long, black. Sold in pairs.

VT No.	Size
<b>28-0439</b>	41mm
<b>28-0440</b>	39mm



28-0900



28-0902



28-0903



28-0905



28-0901



28-0912

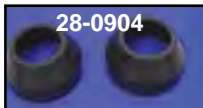

28-0904

**Black Rubber Fork Boots** are designed for a better fit and improved sealing and wiping action. Sold in pairs.

VT No.	Year	Model	MM
<b>28-0900</b>	1971-72	FX	33
<b>28-0902</b>	1973-77	Kayaba	
		FX-FXE-FXS-FXFS	35
<b>28-0903</b>	1975-87	Showa	
		FX-FXE-FXS-FXFS-FXR	35
<b>28-0905</b>	As Above	White	41
<b>28-0901</b>	1949-E77	Wide Glide	41
<b>28-0912</b>	As Above	White	41
<b>28-0904</b>	1984-up	FXST	41
	1980-83	FXWG	

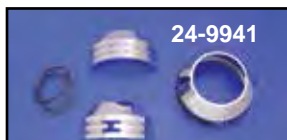

24-9941

**Chrome 41mm Fork Boot Covers.** Requires removal of front wheel. Fits 1980-up FXWG-FXST-FXDWG.

**VT No. 24-9941**



24-0104



24-0105



24-0106



24-0098



24-9049

**Chrome Wiper Boot Covers** are die-cast to fit over the stock rubber fork wiper boot.

VT No.	Type	Year	MM
<b>24-0104</b>	Kayaba	1973-75 FX	35
<b>24-0105</b>	Showa	1976-83 FX	35
<b>24-0106</b>	Wide Glide	1949-77 FL-FLH	41
<b>24-0098</b>	Wide Glide	1980-83 FXWG,	41
		1984-90 FXST	
<b>24-9049</b>	Wide Glide	1980-up ST	41

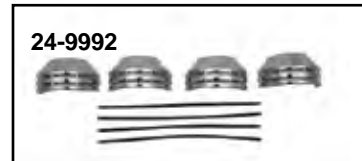

24-9992



24-9993

**Two Piece Chrome Fork Boot Cover Sets** install over stock rubber fork boot by the unique interlocking springs supplied with the kit to securely hold boot covers in place.

VT No.	MM	Year	Model
<b>24-9992</b>	35	Pre1987	FX-FXR
<b>24-9993</b>	41	1980-up	FXWG-FXST-FXDWG





# Fork Seal



**V-Twin Deluxe Seal Kits** include seals, gaskets, snap rings, washers and o-rings. James kits include seals and o-rings only.

James	VT No.	MM	Year	Models
14-0036	14-0014	41	1948-76	FLH
14-0037	14-0938	41	1977-84	FLH-FLT-FXWG
—	14-0043	33.4	1952-70	XL-XLH, Gasket only
14-0039	14-0940	33.4	1971-72	FX
14-0040	14-0941	35	1973-77	FX, Kayaba
14-0041	14-0942	35	1976-83	FX-FXR
		35	1975-84	FX Showa



**V-Twin™ Deluxe Glide Fork Seal Kit** fits 1949-76 and includes all the necessary seals and gaskets plus felt retainer, washer and circlips.

VT No.	Item
14-0014	Kit
24-0611	Rings
14-0135	Seals Only, 5 pack



**Fork Seal Kit** replaces 45849-49. Complete seal kit for 1949-76 FL-FLH and includes both upper and lower seal and gaskets.

VT No. 14-0015

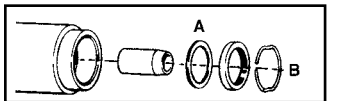

**A-Slider Seal Washers** are zinc plated.

VT No.	OEM	Year/Model
24-0617	45854-48	1949-76 FL-FLH
24-0615	45844-77	1977-up FL, 1980-up FXWG,
24-0642	45928-73	1973-76 FX-XL
24-0091	45911-80	1980-83 XL, 1982-83 FX



**GB Deluxe Fork Seal Rebuilding Kits** include all pieces illustrated as appropriate for each application.

VT No.	Fits	Size
14-0702	1973-74 Kayaba	35 mm
14-0703	1975-84 Showa	35 mm
14-0706	1977-84 FLH	41 mm
14-0014	1949-76 FLH	41 mm



**Leak Proof Fork Seals** feature a Teflon coating to reduce drag and carry a manufacturer's lifetime guarantee. Sold in pairs.

VT No.	Size	Fits
14-0250	35 mm	1973-76 Kayaba FX's
14-0251	35 mm	1975-87 FX, Showa
14-0252	41 mm	1977-up FL-FLT-FXWG



**Fork Seal Sets** are molded with factory part number. Sold in pairs.

VT No.	OEM	Years	Type	MM
14-0010	45975-71	1971-72	FX	33.4
14-0013	45927-73	1973-76	FX, Kayaba	35
14-0011	45400-75	1976-82	FX-FXR Showa	35
14-0012	45843-77	1977-83	FLH-FXWG	41
		1980-84	FLT	
		1980-84	FXWG	



**GB Upper Fork Seal Kit** is used to update 1949-77 FL/FLH to later style fork seal. The kit contains seals and spacer washer. Its new style seal replaces original type narrow seal, felt and top washer.

VT No. 14-0046

**B-Fork Seal Retaining Ring.**

VT No.	OEM	Year	Model
24-0611	45856-48	1949-76	FL-FLH
24-0612	45842-77	1977-up	FL-FXWG
24-0641	45931-73	1973-76	FX-XL
24-0613	45401-75	1975-80	FX-XLH

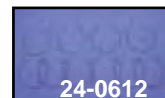

# Fork Brace



**Chrome Billet Fork Brace** has a unique three-

piece design allows which easy installation on 41 mm fork assemblies. VT No. 24-0768



24-0841 Installed

**Chrome Fork Brace** is a four piece design for easy installation on 41mm or 39 mm forks.

VT No.	Size	Fits
24-0842	41mm	1984-up FXST, 1993-05 FXDWG
24-0841	39mm	1985-05 FXR, FXD
24-1039	39mm	Custom
24-1041	41mm	Custom

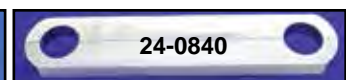
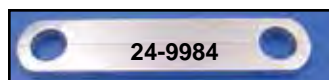

**Tweek Bar Fork Brace** is a two piece design which clamps directly to fork tube. \*Note: As noted clamps directly to fork tube other clamp to fork leg.

VT No.	Size	Fits	Finish
24-9984*	41 mm	1949-84 FLH, 1980-up FXWG-FXST	Polish
24-0840*	41mm	As Above	Chrome
24-0768	41 mm	Three Piece	Chrome



# 41 mm Fork Plug



**Glide Fork Plug Kit** includes fork tube plugs and matching top filler cap plugs, for FL-FLH 1949-84.

**VT No. Fits**

- 24-0140** 1949-84
- 24-0625** 1977-up Showa, FL-FXWG-FXST
- 24-0599** 1977-up Showa (Tapered)



**Inner Fork Tube Plugs** are for 1949-up Big Twin glide model forks.

VT No.	OEM	Year	Finish	U/M
<b>24-0144</b>	45776-49	1949-Early 77	Chrome	Pair
<b>24-0326</b>	45776-49	1949-Early 77	Zinc	Pair
<b>8716-1</b>	45838-77	1977-up	Chrome	Each
<b>8716-1T</b>		1977-84	Chrome	Each
<b>24-0187</b>	45838-77	1977-up	Chrome	Pair
<b>8226-1</b>	45776-49	1949-Early 77	Chrome	Each



**Fork Plug Sets.**

VT No.	Year	Type	Finish
<b>24-0750</b>	1949-79	Fixed, Vented	Zinc
<b>24-9957</b>	1949-76	Adjustable, Vented	Zinc
<b>24-1762</b>	1949-71	Adjustable	Chrome
<b>24-0828</b>	1977-up	Adjustable, Non-Vented	Zinc
<b>24-1828</b>	1977-up	Adjustable, Non-Vented	Chrome

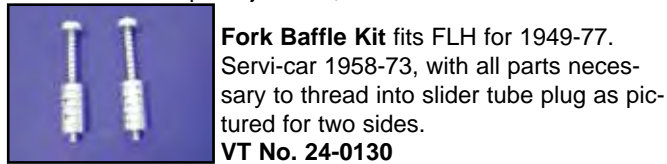

**Fork Baffle Kit** fits FLH for 1949-77. Servi-car 1958-73, with all parts necessary to thread into slider tube plug as pictured for two sides.

**VT No. 24-0130**

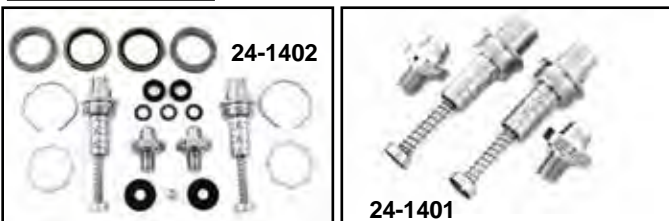

**Top Fork Plug Kit.** Replica of the distinct 1949 style as original, fits 1949-76 FL. Includes top plug set, lower plugs with baffles and gasket set.

**VT No. Item**

- 24-1402** Complete Kit
- 24-1401** Partial Kit

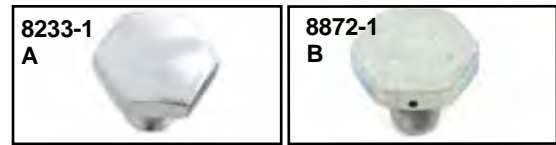

**Fork Tube Top Caps** are stock style and vented when required. Sold each unless noted as pair.

VT No.	OEM	Finish	Fits
<b>7620-1</b>	A 45754-49	Chrome	1949-77 FLH
<b>7620-1T</b>	45754-49	Chrome	1949-77 FLH
<b>24-0184</b>	A 45754-49	Chrome	1949-77 FLH, Pair
<b>8872-1</b>	B 45754-60	Zinc	1960-77 FLH
<b>9911-1</b>	B Flat Top	Chrome	1960-77 FL
<b>24-0186</b>	45419-80	Chrome	1977-up FL
	45418-80		

<b>9912-2</b>	B Flat Top	Chrome	1978-up FL
<b>8233-1</b>	A 45419-80	Chrome	1977-84 FL
<b>8233-1T</b>	A 45419-80	Chrome	1977-84 FL

**Note:** VT No. 8872-1 and 9912-2 are flat top like stock



**Taper-Top Socket Fork** fit 41mm Glide .

**VT No. Years/Model**

- 24-0154** 1948-76 FLH
- 24-0155** 1977-up FLH-FXWG
- 24-0981** 1977-up Allen

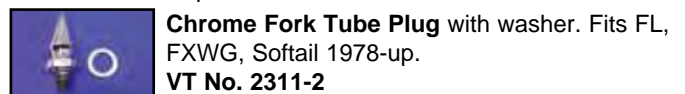

**Chrome Fork Tube Plug** with washer. Fits FL, FXWG, Softail 1978-up.

**VT No. 2311-2**



**Chrome 1949 Style Fork Tube Plugs** feature dome shaped as original, with vents. Fit 1949-76 Glide style forks. Sold in pairs.

**VT No. Year**

- 24-0465** 1949
- 24-1087** 1950-59



**Fork Tube Cap Washer and Seal** for Showa and Kayoba fork legs, sold as pack of 10.

VT No.	OEM	# Fits	Finish
<b>24-0616</b>	45997-73	A 73-up FX-XL-FXR	Zinc
<b>24-0610</b>	5710	A 80-up FXWG fits Tube Plug	Zinc
<b>9964-2</b>	5710	A 80-up FXWG fits Tube Plug	Chrome
<b>14-0132</b>	45773-48	B 48-up FLH-FXWG, Cap Seal Pack of 5	





# 41 mm Glide Tree

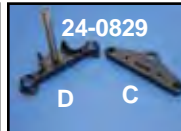
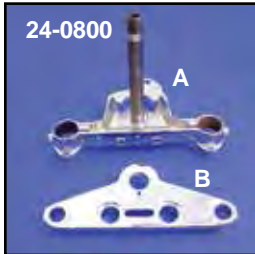

**FLH Triple Trees** fit Big Twin FL fork tubes 41mm 1948-84, 1960-84 types can be fitted with aluminum cowl sets only, VT No. 24-0251. 1949-59 can be fitted with tin cowl sets, 24-9913. All lowers accept lower slider covers. The 1948-59 style top trees have 1/2" holes for post riser mounting.

VT No.	OEM	Finish	Year	Item
<b>Tree Sets</b>				
24-0800*	Fits cowl	Chrome	1960-84	A and B
24-0486	Fits cowl	Chrome	1960-84	A and B
24-0829	Fits tins	Black	1948-59	C and D

<b>Lower Tree Only</b>				
24-0811	45700-60	Chrome	1960-84	D
24-0444*	45700-69A	Chrome	1960-84	A
24-0813*	45700-69A	Black	1960-84	A
24-0830	45700-48A	Black	1948-59	D
24-0985	45700-48A	Chrome	1948-59	D
24-1070	Lock Tab	Raw	1973-84	

<b>Top Tree Only</b>				
24-0003	56121-73	Chrome	1973-84	B
24-0814	56121-73	Black	1973-84	B
24-0751	56121-48	Black	1948-59	C-Solid
24-0752	56121-48	Chrome	1948-59	C-Solid
28-1949	56159-49	4 Piece	1960-72	Riser bushing
28-0221	56153-73	Set	1973-84	Riser bushing
37-8835	4729	Zinc	1948-84	Lower Pinch Bolt
24-0674	—		1948-84	Stem Only

\*Note: Lower tree has a lock tab.



**Solid Handlebar Mount Adapter Kit** eliminates the flex style stock rubber mounts. The addition of this kit gives a solid mount handlebar setup.

VT No.	Year	Finish
25-2102	1962-72	Chrome
25-2103	1973-up	Chrome
25-2223	1973-up	Chrome
25-2224	1973-up	Brass
25-2225	1973-up	Black



**Fork Stem Die**  
**VT No. Item**  
**16-0272** Die Holder Tool  
**16-0051** Die Tool with Holder Set



**Dies** are round type adjustable to restore damaged or mistreated threads. Fits 1936-84 Big Twin 1" x 24T FL-FLH Fork Stem  
**VT No. 16-0836**



**FXWG Triple Trees** accept 41mm fork tubes. Bottom tree features built in rake and rounded edges. Trees use VT No. 28-2218 rubber bushing set and headlamp bracket VT No. 31-9991 which can be purchased separately. Trees fit 1980-86 FXWG, FXST.

VT No.	Type	Years
<b>Tree Sets</b>		
24-0000	Stock	1980-86
<b>Top Tree Only</b>		
24-0007	Stock	1980-86
<b>Lower Tree Only</b>		
24-0825	Stock	1980-86
24-0843*	Stock	1980-86
24-0064	Without lock	1980-86

\*Note: Includes lower bearing.



**Chrome 1980-86 FXWG Headlight Bracket** mounts bottom mount headlights on fork and also covers rough casting on lower tree. **VT No. 31-0140**



# Fork Panel



24-0500



24-1960

**1948-84 FLH Headlamp Cowl Kit** available with complete light assembly with rim and chrome or polished housing set with matching top handlebar cover as pictured.

- VT No. Item**  
**24-0500** Chrome Kit  
**24-0501** Polished Kit  
**24-1960** Black Kit  
**37-0808** Screw Kit, Stainless Steel  
**37-0815** Screw Kit, Chrome  
**37-0949** Screw Kit, Replica



24-0190

**Slider Covers** fit 1949-84 FLH model forks. Stock length is 6<sup>5</sup>/<sub>8</sub>" overall.

- VT No. Finish Fits**  
**24-0190** Chrome Stock  
**24-9962** Stainless Stock  
**24-1184** Brushed SS  
**24-1962** Black Stock  
**24-0191** Chrome 1" Over  
**24-9983** Stainless 1" Over  
**24-9987** Stainless 2" Over  
**24-0138** Chrome 2" Over  
**24-9961** Chrome 3" Over  
**24-0139** Chrome 4" Over  
**24-0386** Chrome Flame



24-9962



24-1962



24-9904



24-9900



24-9988



24-9905



24-9908

**Top Triple Tree Covers** are available in either a stainless steel or chrome finish. Note: 24-9904 and 24-9900 for 1949-59 solid mount glide risers.

- | VT No.   | OEM      | Finish    | Type/Style                                       |
|----------|----------|-----------|--|
| 24-9904  | 45740-49 | Stainless | FLH, Solid                                       |
| 24-9900  | 45740-49 | Chrome    | FLH, Solid                                       |
| 24-9988  | 45741-50 | Stainless | Adjustable, Solid                                |
| 24-9905* | 45741-60 | Stainless | 3 <sup>1</sup> / <sub>2</sub> " center to center |
| 24-9908* | 45741-60 | Chrome    | 3 <sup>1</sup> / <sub>2</sub> " center to center |

\*Note: 3<sup>1</sup>/<sub>2</sub>" C/C, fit the 1960-up type Iso mount trees.



**Handlebar Clamp Cover** replaces original type FLH 1960-84 Wide Glide forks.

- | VT No.   | OEM      | Year    | Type                    |
|----------|----------|---------|-------------------------|
| 24-0250  | 56590-60 | 1960-79 | Chrome Smooth           |
| 24-0281  | 56590-60 | 1960-79 | Polished Smooth         |
| 24-1862  | 56589-60 | 1960-79 | Black                   |
| 24-9963* | 56589-60 | 1960-79 | Chrome with Damper Hole |
| 24-0330  | 56590-79 | 1980-84 | Chrome Smooth           |
| 37-8701  | Chrome   | 1960-84 | Screws for Above        |
| 37-8701T | Chrome   | 1960-84 | Screws for Above        |

\*Note: Uses 24-0202 damper kit.



24-1464



24-9912



24-9922



24-1755



24-9909



24-9258



24-1753



24-1755



37-0547



24-7943

**Fork Covers** fit 1949-59 FLH triple trees.

- | VT No.   | Years   | Item         | Finish/Note                               |
|----------|---------|--------------|---|
| 24-1464  | 1955-59 | 5 Piece Kit  | Black                                     |
| 24-9913  | 1955-59 | 3 Piece Kit  | Chrome, 3 Rib, Hydra Glide                |
| 24-9909  | 1955-59 | 3 Piece Kit  | Stainless, 3 Rib, Hydra Glide             |
| 24-1753  | 1955-59 | 4 Piece Kit  | Black, 3 Rib, Hydra Glide                 |
| 24-9912* | 1949    | 4 Piece Kit  | Stainless, 4 Rib                          |
| 24-9258  | 1950-54 | 4 Piece Kit  | Stainless, 3 Rib                          |
| 24-9922* | 1950-54 | 4 Piece Kit  | Stainless, 4 Rib, Hydra Glide             |
| 24-1755* | 1950-54 | 4 Piece Kit  | Chrome, 3 Rib, Hydra Glide                |
| 24-9902  | 1949-59 | Left         | Stainless, 46281-49                       |
| 24-9903  | 1949-59 | Right        | Stainless, 46273-49                       |
| 24-7943  | Set     | Right & Left |   |
| 24-9923  | 1950-54 | Front        | Stainless, 4 Rib Hydra Glide              |
| 24-9924  | 1949    | Front        | Stainless, 4 Rib                          |
| 24-9906  | 1955-59 | Front        | Stainless, 46273-49A<br>3 Rib Hydra Glide |
| 24-9907  | 1955-59 | Front        | Chrome, 3 Rib, Hydra Glide                |
| 24-1085  | 1949-59 | —            | Screws, set of 6                          |
| 37-0547  | 1949-59 | —            | Mount Kit                                 |

\*Note: 1949-53 type feature straight ribs and includes VT No. 24-9904 tree cover.



**Control Cable Guide** replaces 56600-49 on 1949-60 FL's to prevent cables and wiring from abrasion on top triple tree and has black plastic construction.

**VT No. 28-0222**





# Neck Kit with stop



**Smooth Neck Cup Set** features built in stop and includes races and bearings.  
**VT No. 24-0874**



**Chrome Internal Fork Stop Kit** includes pieces for complete installation on Big Twins, and custom frames which accept press in neck cups. Kit allows choice of turning radius of 35 or 45 degrees. For 1936-87 Big Twin in 35° and 45° configuration.  
**VT No. 24-0296**

**Chrome Mega-Neck Cup Set** features 1" inner diameter bearing set with large outside diameter on the outer race which provides 1.68 times the radial capacity and 1.57 times the axial capacity of a conventional bearing. Kit includes chrome cups, bearings, races and two dust shields.  
**VT No. 24-0300**

# Top Nut



**Chrome Glide Acorn Nut** is 1" x 24T with Shoulder for alignment in top tee, fits 1948-up FL-FLH.  
**VT No. Item**  
**37-0442** With  
**7802-1** With  
**24-1459** With  
**37-0443** Without



24-1459



**Chrome Fork Stem Nut Cover** to fit over stock stem nut and held in place by set screws. Cover is one piece.  
**VT No. Fits**  
**24-0636** 1971-87 35mm fork  
**24-1336** 1980-up 39mm fork



24-0185



37-8138



24-0226

## Stock Type Stem Nut

VT No.	Year	Type	Finish
24-0185	1948-up	Glide	Zinc
37-8138	1960-up	Glide	Chrome
24-1456	1960-up	Glide	Zinc
17-0924		Lock Tab	
37-0597	Chrome	Nut	
17-0924	Zinc	Lock tab, 10 pack	



17-0924



37-8137

**Chrome Flat Top Stem Nut** replaces 45718-71 on 1978-86 FXE-FX-FXR.

VT No.	Item
37-8137	Nut, 7/8 x 24 threads per inch
9963-1	Washer
9963-1T	Washer
37-0988	Washer



VT No. 24-0663



VT No. 24-0662



VT No. 24-0113

**FL Cone Cover Nut** features cover with built in nut. Replaces 48330-48.

VT No.	Item	Years
24-0113	Hex Type	1960-84
24-0662	Replica Type	1949-84
24-0663	Cone Type	1960-84



24-0622

**Lower Cone Nut** for Big Twins.

VT No.	OEM	Years
24-0622	48330-48A	1949-59
24-0278	48330-48B	1960-84



**1949-60 Top Nut** features crenelated design for use with steering damper plates. Replaces 45718-49.  
**VT No. 24-0120**



**Wide Glide Top Nut Kit** fits 1948-84 FL, 1971-2010 FX. Includes top nut, cover set and lock nut, and tapered bearing set.  
**VT No. 24-1460**



**Stem Nut and Lockwasher Kit** includes lock washer and nut.

VT No.	Finish	Item
8808-2	Black	Kit
37-8138	Chrome	Kit
24-0197	Zinc	Kit
24-0226		Nut with Stainless Steel Cover



**1949-84 Stem Nut and Lower Cone Nut Set.** Thin profile of cone nut allows use of outer covers and cowls.  
**VT No. 24-0317**



# Big Twin Neck Kit



24-0122



24-0253



24-1282



12-0348



12-0823

## Fork Stem Bearings and Races.

Order separately as noted.

VT No.	Item	Type	U/M	
24-1282	Kit	All	7 Piece	
12-0334	1949-59 Big Twin	Bearing	Each	
12-0365	1949-59 Big Twin	Race	Each	
24-0118	1960-up Big Twin	Bearings	Pair	
VT No.	Brand	Year	Item	U/M
12-0384	Peer	1960-up Big Twin	Bearings	Pair
12-0823	VT	1960-up Big Twin	Bearing	Each
12-0335	Timken	1960-up Big Twin	Bearing	Each
12-0348	Timken	1960-up Big Twin	Race	Each
12-0383	Peer	1960-up Big Twin	Race	Each



24-0121



24-0119



24-1751

**Big Twin Neck Cup Assembly** available as a complete kit which includes chrome neck cups with races installed and a chrome top nut. Available as component parts for 1948-86 Big Twins.

VT No.	Item
24-0122	Kit, Complete with chrome cups
24-1751	Kit, Complete with zinc cups
24-0253	Kit with cups
24-0121	Cup Set, zinc
24-0119	Cup Set, chrome
24-1071	Without races, Cup Set, chrome



24-0126

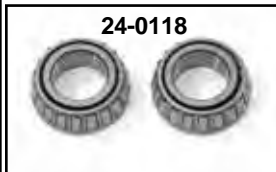

24-0118

**1960-84 Chrome Cup Set** for use with early fork tins.

24-0126	Cup Set
24-0118	Bearing, pair
24-0112	Lower Cover



24-0322

**Chrome Smoothie Neck Cup Kit** includes races, 1" bearings and dust cover set for Big Twins.

VT No.	Item
24-0322	Kit
24-1156	Top Cover
24-0112	Lower Cover



**Sealed Bearing Set** for 1" stems.  
VT No. 24-0089

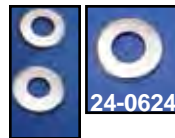

24-0624

## Dust Shields.

VT No.	Finish	Fits	Model
24-0618	Zinc		48-up Big Twin
24-0112	Zinc	Lower	48-up FX-FL
24-0624	Zinc	Chrome (Low)	48-up FX-FL
24-0117	Zinc	Upper & Low	60-up FX-FL
24-0114	Chrome	Upper & Low	60-up FX-FL
24-0237	Chrome	Upper	Big Twin



24-0103

**Sealed Timken Neck Bearings** feature built in rubber seal where bearing contacts top of race. Available as a complete kit with chrome cups that includes dust shields or as bearings only that can be used to update models where races are pressed into frame neck.

VT No.	Item
24-0103	Chrome Cups with races and Sealed Bearing Kit 1949-88 Big Twin
24-0102	Two Sealed Bearings for 1989-up FXST-FLST, FXR 1980-up FLT, 1992-up Dynaglide model



**Hexagon Neck Cup Kit** includes 1" neck bearing set.  
VT No. 24-0305



**Bearing Seal Set.** Metal backed seal fits all 1" neck bearing applications pair.  
VT No. 14-0174

# Raked Kit



24-0274

**"Raked" Fork Neck Cup Kit** replaces existing removable cups to provide 3° rake when installed. Kit includes cup set, bearing set and dust covers with instructions. Fits 1949-87 Big Twin.

VT No.	Finish
24-0274	Stainless
24-0283	Chrome

**Note:** Rake neck kits are for **show applications** only and require longer fork tubes to be installed.





# Glide Riser



**Replica 1949-59 Big Twin Riser Kit** includes two chrome post risers with zinc plated caps, chrome riser link with four studs and acorn nuts, two rubber bushings, two screws and two flex lock nuts as pictured.

VT No.	Item
25-2175	Kit
25-2117	Riser with bushing and top clamp
37-8820	Bolt Only
37-9149	Flex Nuts



**Chrome Riser Link** fits 1949-60 FL and has 4<sup>3/4</sup>" center to center mounting holes.

VT No.	Use
49-0417	Top Clamp
37-8810	Four Studs and Four Acorns, Set

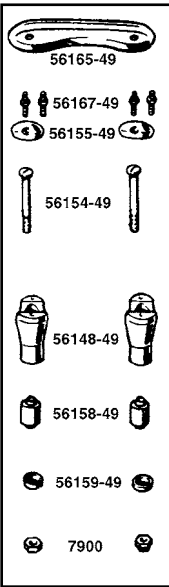

**Chrome Early Style Glide Risers** feature rubber bushings for use on 1949-59 models of FLH. Order top riser link separately.

VT No.	Item
25-2117	Riser and Top Chrome Set
25-2137	Replica Early Style Zinc Top
37-8820	Bolts, pair with nuts
25-2137	Tops, Zinc, pair
25-2212	Tops, Chrome, pair
28-1949	Rubber Washer, pair
37-8810	Kit, 4 pc Rubber Bushing, pair
28-1950	Rubber Washer only, pair
28-2223	.007 Oversize Rubber Bushings, pair
37-8810	Acorn Nuts with Stud Set

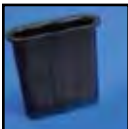

**Control Cable Guide** replaces 56600-49 on 1949-60 FL's to prevent cables and wiring from abrasion on top triple tree. Guide has black plastic construction.

VT No. 28-0222



**Stock Type Risers** are original tapered type, through bolt design, chrome steel. Bolts not included. \*Note: Feature rubber Iso-inserts, and 5/16" acorn nuts.

VT No.	Rise
25-2171	3"
25-2129	4", Threaded
25-2173	5"
25-2130*	5"
25-2176*	3"
25-2220	3"
25-2250	3"



**Black Handlebar Clamp** fits 1960-78 FL. VT No. 25-2134

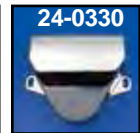

**Handlebar Clamp Cover** replaces original type FLH 1960-84 Wide Glide Forks.

VT No.	Year	Type
24-0250	1960-79	Chrome Smooth
24-1862	Black	As Above
24-0281	1960-79	Polished Smooth
24-9963*	1960-79	Chrome with Damper Hole
24-0330	1980-84	Chrome Smooth
37-8701	1960-84	Chrome Screws for Above
37-8701T	1960-84	Chrome Screws for Above

\*Note: Uses 24-0202 damper kit.

# Bushing



**Handlebar Riser Bushing Kit** includes two bushings and two washers for 1949-72 FL. The 1960-72 FL requires VT No. 26-2121 for solid type mounting.

VT No.	#	Note	Years	Item
28-1949	A-B	Kit	1949-59	Four pieces
28-1950	B	Pair	1949-59	Two washers
28-2121	A	Pair	1949-72	Two bushings
28-2223	A		.007	Oversize
26-2121	C	Set (4)	1960-72	Bushings Steel



**Solid Handlebar Mount Adapter Kit** eliminates the flex style stock rubber mounts. The addition of this kit gives a solid mount handlebar setup.

VT No.	Fits
25-2102	1962-up
25-2103	1973-up



**Chrome Duo-Glide Bar Set** is a chrome stock type with switches and cables installed. Fits 1960-64 FL.

- VT No. Item**  
**25-0662** Bar Set  
**25-0933** Bar Assembly  
**25-0941** Bar Set (Throttle Only)

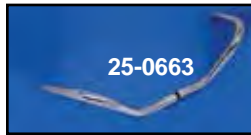

**Two Piece Bars.** Original Buckhorn type, knurled to fit stock riser block on 1960-78 FL, 1" diameter on both ends enables snap throttle to be used.

**VT No. 25-0663**



**Replica Chrome Cross Bar Kit** includes fluted tube and two stainless clamps for FLH models.

- VT No. Item**  
**49-0153** Cross Bar  
**31-0530** Clamp Set Only  
**37-1969** Bolt Set

## Grips

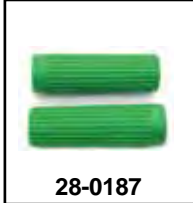

**1962-72 Rib Style Grips.**

- VT No. Color**  
**28-0118** Black  
**28-0119** White  
**28-0184** Red  
**28-0185** Blue  
**28-0186** Yellow  
**28-0187** Green



**Replica Waffle Grips** are replacement for 56212-53 on 1949-61, in 1 1/8" size or 1974-up late type 1 1/8" size. Available in pairs. Order chrome plugs separately.

VT No.	Color	Year	Inner Diameter
28-0159	Black without plug hole	1949-72	1 1/8"
28-0110	Black with plug hole	1949-72	1 1/8"
28-0111	White	1949-72	1 1/8"
28-1985	Black with chrome plugs	1974-up	1 1/8", 1" left grip
28-0134	Black with chrome plugs	1953-72	1 1/8"
28-0121	White	1974-84	1 1/8"

## Handlebar

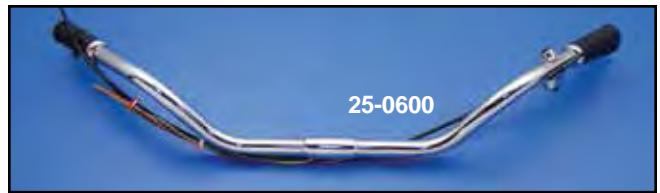

**Early Glide Bars** use stock internal components for years listed. Available in one piece with reinforced center or two piece type. Some hand fitting internals required.

VT No.	Note	Type	Fits	Piece
25-0697		Bar Only	1949-53	1
25-0601	A	Assembly	1949-53	
25-0661		Bar Only	1954-59	1
25-0600	B	Assembly	1954-59	1
25-0602	C	Assembly	1954-59	
25-2180		Bar Only	1965-73 FL-FLH	2

A Complete with Push Throttle/Spark/Switches  
 B Complete with Push Throttle/Push Spark/Switches  
 C Complete with Pull Throttle/Push Spark/Switches

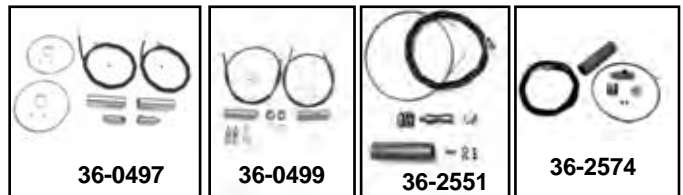

**Order Internals Separately Listed Below**

VT No.	Item	Year/Fits
36-0497	Throttle Spark	1949-53 Two side, push
36-0499	Throttle Spark	1954-64 Two side, push
36-2551	Throttle Only	1954-73 One side, push
36-2574	Throttle Only	1954-73 One side, pull
36-0073	Cable Wire Set	

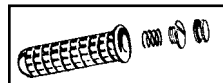

**Grip Hole Plugs** for 1953-61 are zinc plated with groove, pair. **VT No. 28-0625**



**Chrome Hole Plugs** for 1960-84 snap in as replacements.  
**VT No. 28-0618**





# Glide Fender



50-0124



50-1144

**Replica Fender for 1949-84 FLH.**  
VT No. **Finish**  
50-0124 Raw  
50-1144 Chrome



**Replica Glide Raw Finish Front Fender** replaces 59000-48A with early type brackets riveted on. Fits 1949-57.  
VT No. **50-0742**



50-0172



50-0169

**Fat Kid Steel Front Fenders** fit 16" wheels on Glide Forks.

VT No.	Fits	Finish
50-0172	1980-99 FXWG-FXST	Raw
50-0169	1949-84 FLH	Raw



50-0127



50-0135



50-0128



50-0115



50-1147

**Glide Type Fenders** are finished as noted, include chrome or raw braces riveted on. Fit 19" and 21" tires only for 1949-84 FL.

VT No.	Fender	Braces
50-0127	Plain	Chrome
50-0135	Plain	Raw
50-0128	Chrome	Chrome
50-0115	Raw Springer Type	Chrome
50-1147	Raw	Raw



**Glide Fender Bracket,** zinc finish.  
VT No. **50-1148**



50-0124



50-0137



50-0117



50-1081



50-0140



**FLH Front Fenders** fit 1949-84 Wide Glide type forks for 16" wheels.

VT No.	Type	Note
50-0124	Replica Raw	Without trim holes
50-0137	Replica Raw	With trim holes
50-0117	Replica	Without brackets
50-1081	Replica	1979-84 with fender tip indent and trim holes
50-0140	Replica	Less Brackets, Raw

**All fenders listed fit 41mm wide style glide fork assemblies.**



50-1086

**Front Fender Mount Kit** attaches fender to original style assembly.

VT No.	Model	Year	Finish
37-0830	FXWG	1980-83	Chrome
50-1086	FLH	1949-84	Zinc
2292-8	FLH	1951-78	Chrome
17-0941	FL Locktabs	1975-84	Zinc
37-0895	FLT	1980-up	Zinc



31-3967



31-0539

**Glide Fender Brackets** replace braces on 1948-84 FLH fenders for repair or mounting on custom 7" wide fenders.

VT No.	Year
31-3967	1958-84
31-0539	1949-57
50-1148	1949-up, zinc



50-1530



50-1541



48-1981

**Police Fender Marker Plate** fits 1936-84 45" and Big Twins. Order decal set separately.

VT No.	Item
50-1530	Marker Plate
48-1981	Decal Set
50-1541	Set



# Front Fender for 35 and 39mm Fork



**Front Stock Type Fender** in raw steel, has chrome tubular type brackets riveted in place.

VT No.	Year	Type	Cable Bracket
50-0120	1970-83	Assembled	Right
50-0392	1970-83	Assembled	Left
50-0118	1970-83	Unassembled	
50-0119	1970-83	Bobbed	
50-0932		Bracket set	
50-0789	1984-91	Assembled	
37-6370	—	Stainless Steel Rivets	25 pieces



**Springer Style Fender** fits 1973-up 35 and 39 mm models with 19" or 21" wheels.

VT No. 50-0116



**Chrome Front Fender Allen Head Screw Kits** contain all the necessary screws for mounting front fender brackets to fender and bracket to fork legs. Use on all 1973-up FX stock type front fenders. VT No. 37-6367



**Fender Rivets** fit 1973-up FX-XL models, stainless, pack of 25. VT No. 37-6370



**Chrome Fender Tips** in stamped, includes screws. Fits fender width as noted.

VT No.	Style	Width	Type
50-1055	Eagle	4"	XL-XLS
50-1050	Smooth	4"	XL-XLS
50-1049	Smooth	5"	FX
50-0915	Eagle	5"	FX



**Emblem Sets** feature threaded studs to attach to fender as original accessory, but can be mounted to fenders and saddlebags, sold as pair.

VT No.	OEM	Finish	Type
38-6674	11530-46	Nickel	Deluxe
38-0923		Chrome	Deluxe
38-6675	91583-52	Nickel	O.H.V.
38-6676	91582-50	Chrome	Hydra-Glide
38-6680	59195-58	Chrome	Duo-Glide
38-6555		Chrome	Electra-Glide
37-8842*	7613A	10 pack	Speed-Nuts

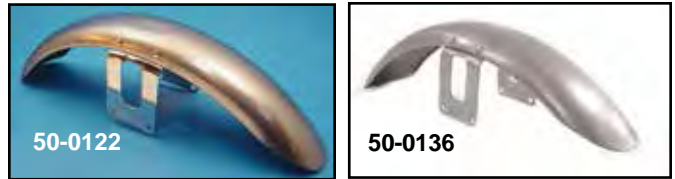

50-0122



50-0136



50-0123



50-0164



50-0165



50-0191



50-0889

**Narrow Type Front Fenders** for 35 or 39mm forks feature a raw or chrome steel finish with brackets riveted on. VT No. 50-0122 fits 19" wheels on 1973-90 XLX models, 50-0164 fits 1973-up models with 21" wheels and 1991-up with 19" or 21" wheels.

VT No.	Finish	Wheel	Brackets
50-0122	Plain	19"	Chrome
50-0136	Plain	19"	Raw
50-0123	Chrome	19"	Chrome
50-0164	Raw	19"	Chrome
50-0165	Raw	19"	Raw
50-0191	Chrome	19"	Chrome
50-0889	Raw	19"	Raw
50-1140	Raw	19"	Raw



50-0133

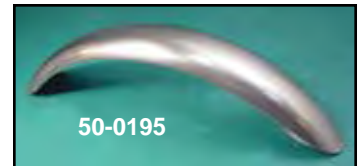

50-0195



50-0196

**Universal Sport Style Front Fender** is rolled on edge and in front. The brackets are not included.

VT No.	Type
50-0133	Chrome (drilled)
50-0195	Plain
50-0196	Chrome





# Spring Fork Fender



50-0144



50-0750

Spring Fork Front Fenders are 7½" wide for 16" or 18" wheels with riveted on wide braces. Big Twin fits with outside rockers.

VT No.	Year/Model
50-0144	1936-48 Big Twin
50-0750	1936-46 Big Twin

### Separate Pieces

51-0540	Lower Brace Set 1936-48 Big Twin
50-0182	Skirt Set Only Right and Left
50-0779	Fender without Braces



50-0914

Stainless Fender Trim for 1939-48 Big Twin and 45", 1940-49 Spring fork front Includes clips.

VT No.	Fits
50-0914	Front
37-8458	Clips, 25 pack



50-0883

Bobber Fender is 6" wide without holes. Order bracket to mount to spring fork rear leg tabs. Fits 1936-57 Spring Forks.

VT No.	Item
50-0883	Fender
50-1566	Bracket



50-1566



28-0701



28-0702

Mud Flaps. Stock type for front and rear fenders for Big Twin.

VT No.	Type	Color	Note
28-0701	Rubber	Black	Plain
28-0702	Rubber	White	Plain

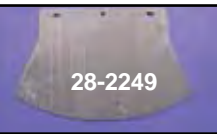

28-2249

Early Mud Flap replaces 59235-26 in rubber with laminated cloth construction.

VT No.	Item
28-2249	Mud Flap
49-0425	Mount Hardware

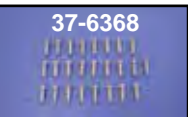

37-6368

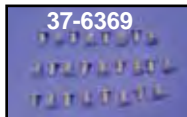

37-6369



37-6370

Replacement Fender Rivets fit all FL front and rear fenders and FX front fenders, pack of 25.

VT No.	Fits
37-6368	Big Twin Fender Brace
37-6369	Big Twin Fender Top
37-6370	FX Front, 1973-up Stainless



50-0894



50-0895



50-0751



50-0760



50-0474

Replica Front Fenders feature two piece spot welded skirt panels and correct width braces.

VT No.	Year	Model
50-0894	1936-46	Big Twin
50-0895*	1936-46	Big Twin
50-0751	1947-48	Big Twin
50-0760		Fender Body Only
50-0474		Bobbed

\*Note: 50-0895 has fender lamp holes. All other are without fender lamp holes.

Front Fender Mounting Kit is used to install stock front fenders on 1936-57 Spring Forks.

VT No.	Item
8203-6	Kit, Cadmium
9680-6	Kit, Parkerized
9742-6	Kit, Chrome
8009-2	Locks Only
50-0730	Brace Set
50-0734	Reinforcement Plate



50-0730



50-0734



Universal Springer Style Fender for 18, 19, and 21" wheel. Brackets must be fabricated.

VT No. 50-0780

Note: All Items Shipped with a Raw Finish may have some oxidation (rust on surface)!



# Rigid Rear Fender



50-0143



50-0180



50-0156



50-0744



50-0142



50-0880



50-0892



50-0280



50-0157



50-0283



50-0284

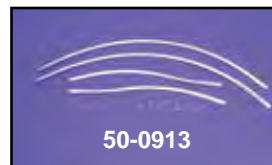

50-0913

**Stainless Fender Trim** for Rigid rear 1939-48 Big Twin. Includes clips.

VT No.	Fits
50-0913	Rear
37-8458	Clips, 25 pack

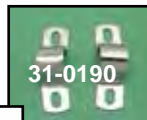

31-0190

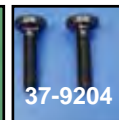

37-9204



31-0457

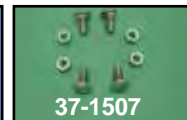

37-1507

**Fender U Clamp** is used on 1936-57 Rigid models secures rear fender to frame cross tube. Replaces 59800-36.

VT No.	Finish	Note
31-0190	Chrome	Order chrome carriage bolts separately
31-0457	Parkerized	Order chrome carriage bolts separately
37-9204	Black	Bolt set, when using rear frame bar
37-1507	Chrome	Carriage bolts



50-1054



50-0525



50-0557



50-1010

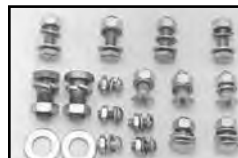

**Rigid Rear Fender Mounting Kit** includes hardware to install rear fender on 1936-57 Big Twin.

VT No.	Finish
8202-18	Cadmium
9708-18	Chrome
9707-18	Parkerized
2493-6	Parkerized
2460-2	Parkerized

**Rigid Rear Fenders.** VT No. 50-0143 and 50-0141 feature relief over skirts to accept stainless fender trim attached by clips. Fully assembled and riveted together with hinge. VT No. 50-0142 has smooth skirts for 1949-57 Rigid Big Twin and VT No. 50-0744 has fender plate built in.

## Big Twin

VT No.	Fits
50-0143	1939-54
50-0180	1936-39
50-0156*	1939-46 with Narrow braces
50-0157*	1947-48 with Wide braces
50-0744	1949-51
50-0142	1949-57
50-0880	1936-57 Bobbed
50-0892	1936-57 Bobbed
50-0280	1936-57, Short
50-0283	1936-46, Short
50-0284	1936-50, Short
50-1054	1939-46, Tail Only
50-1053	1949-54, Tail Only
50-1199	1955-57, Tail Only No Cut Out
50-0525	1949-57, Straps
50-0349	1936-46 Narrow Brace Set
50-0348	1946-57 Rear Fender Brace Set
50-1010	Fender Plate
50-0449	Rear Fender Raw Brace
50-0525	Rear Fender Raw Brace, 1949-1957
50-0549	Rear Fender Tail End, 1949-53

\*Note: Features two piece spot welded skirt.

**Note: All Items Shipped with a Raw Finish may have some oxidation (rust on surface)!**

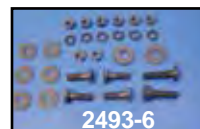

2493-6



**Stainless Steel Strip Set** is shown installed on a Rigid Fender. VT No. 50-1045



**Accent Bars for Rigid Rear Fender**  
VT No. 2634-12T



50-0283



50-0284

**Raw Rigid Rear Fender Assembly.**

VT No.	Fits	Year
50-0283	Without tail end hinge	1936-48
50-0284	Without tail end hinge	1949-51

**Rear Fender Mount Raw Steel Mount Brace Set.**

50-0348	1946-57 FL
50-0349	1941-46 FL Narrow





# Rear Fender

All Fenders are STEEL!

# Strut Set

FRAME • FENDERS • TANKS

We suggest pre-fitting all component parts including engine and transmission assemblies before painting or final assembly of a frame, fender or tank.



50-0702



50-0705



50-0761



50-0884



50-0774



50-0879



50-0743

Replica FLH Rear Fenders replace the original steel part. Taillight cut out and turn signal mounts noted.

VT No.	Application	Tail Lamp	Type
50-0702	1958-76 FL	A	Flip
50-0705	1958-78 FL	B	Flip
50-0761	1973-78	C	Flip
50-0884	1973-78	C and D	Flip
50-0774	1979-84 Replica	C and D	One Piece
50-0879	1979-84 FLH	C	One Piece
50-0743	1979-84 Replica	B	One Piece

Accepts A Early 1955-72 type  
Taillight Type B Tombstone or Beehive  
C Late 1973-up large style  
D Turn Signal Indents



50-1054



50-1053



50-0703

Rear Fender End. One-half of hinge is riveted to fender end.

VT No.	Year	Model
50-1054	1939-46	Rigid Big Twin and 45
50-1053	1947-54	Rigid Big Twin and 45
50-1199	1955-57	Rigid Big Twin, no cutout
50-0703	1958-78	No Cut Out
50-1006	1958-78	Hinge with Pin
50-0931	1939-48	Hinge with Pin
37-8840	1939-78	Hinge Pin

624



50-0900



50-0979



50-1072 Installed

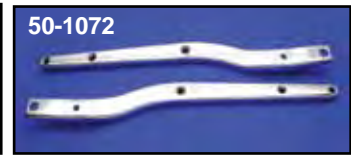

50-1072

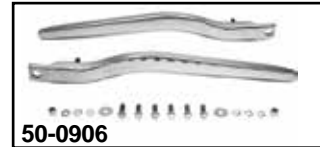

50-0906



50-0901



50-0902



50-0907



50-0903



50-1080

Chrome Fender Strut Sets are available in smooth or stock style with signal and mount holes. Smooth is without holes, stock is with holes.

Smooth	Stock	OEM	Fits
N/A	50-0900	59929-73	1973-83 FX-FXE
N/A	50-0979	As Above	Less turn signal holes
50-0906	50-1072	59923-58	1958-76 FLH with 5 holes
N/A	50-0901	As Above	With 7 holes
N/A	50-0902	59933-77	1977-84 FLH
50-0907	50-0903	59960-80 59961-80	1980-85 FXWG
N/A	50-1080	As Above	less turn signal holes



Strut Spacers replace 59938-72 on 1972-84 FX-FXE models, pack of 10.

VT No. 37-9093



Chrome Allen Fender Strut Bolt Kits

include necessary allen head bolts, washers and nuts for fender mounting.

VT No. Year/Model

37-9047	1980-85 FXWG
2527-8	1980-85 FXWG
37-9048	1973-85 FX
37-9049	1958-84 FL without saddlebags/luggage rack

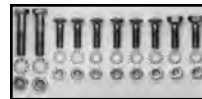

Chrome Rear Fender Support Mount Kit to replace original hardware for FLH.

VT No.	Year	Style
9638-30	1958-80	Acorn
8879-30	1958-80	Stock
2625-30	1958-80	Replica

Note: All Items Shipped with a Raw Finish may have some oxidation (rust on surface)!

# Rear Fender 71-84 FX-FXE-FXWG

All Fenders are STEEL!

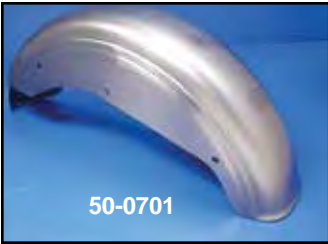

50-0701



50-1076



50-0704



50-0700



50-0942

**FX-FXE Rear Fenders** for 1972-84 FX models use stock struts. **\*Note:** Accepts tail lamp as noted. All fenders use either 50-0900 stock or 50-0905 smooth struts.

VT No.	Type	Tail Lamp
50-0701	Flare End	No
50-1076	Stock 1971-72	33-0300
50-0704*	Stock 1973-84	33-0301
50-0700	Smooth	No
50-0942	Full, Smooth	No



**Chrome Steel Struts** fit FXE-FXWG as noted.

Smooth	Stock	Year
N/A	50-0900	1973-83
N/A	50-0979	Without Signal Hole
50-0907	50-0903	1980-85 FXWG
N/A	50-1080	Without Signal Hole
2522-6		Mount Kit



50-0942



50-0471



50-1525



50-0860

**Dresser Rear Fender** not drilled, to be installed with modification.

VT No.	Width
50-0942	6.5"
50-0471	7.5"
50-0860	8.0"
50-1525	9.0"



Stock Style  
50-0793



Cateye Style  
50-0755



Slice Style  
50-0756



50-0150

**FXWG Bobbed Style Rear Fender Kits** fit 1965-85 FLH, 1971-84 FX-FXE models. Kits include steel fender chrome struts, chrome tail lamp bracket and tail lamp. Available in three styles.

VT No.	Tail Lamp Style
50-0793	Stock
50-0755	Cateye
50-0756	Slice
50-0150	Fender Only
50-1080	Struts



50-0150



50-0170



50-0547

**Bobbed Style Rear Fenders** fit stock struts. Order light brackets separately. VT No. 50-0547 is 8" wide for use with 160 tire and is not drilled.

VT No.	Year	Model	Light Bracket
50-0150	1980-85	FXWG	31-0160
50-0170	1972-84	FXE	31-0472
50-0547	1972-85	All	31-3192

## FXR



50-1064



50-1106

**Stock Type Rear Fender** fits 1981-up FXR-FXRS models. Replaces 59634-81A.

VT No.	Item	Year
50-0768	Fender	1981-94 FXR
50-1064	Struts	1982-86 FXR
50-1106	Struts	1987-94 FXR



50-0768

**Note: All Items Shipped with a Raw Finish may have some oxidation (rust on surface)!**





# Fender Trim

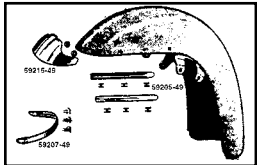

50-1023



50-0958

**Front Fender Trim Set** for 1949-72 FL models includes tip, side strips, and lower end trim.

**VT No. Years**

**50-0958** 1949-58 Kit

**50-0997** 1949-70 Lower End Trim Only

**50-1022\*** 1958-66

**50-1023\*** 1967-72

**\*Note:** Include tip and side spears only.



50-0997



50-1099

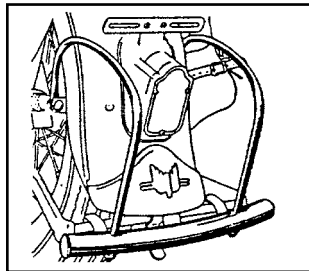

**Rear Bumpers** with original cabbage cutter design grill.

**VT No. Type**

**50-1099** With Grill

**50-1040** Without Grill



50-1037

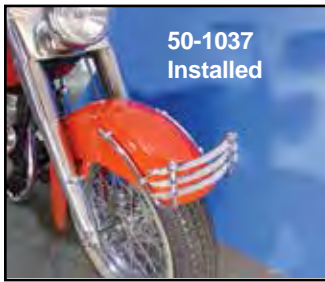

50-1037  
Installed

**Front Bumper** with original cutter design. Includes parts for mounting to FLH-FLT front fenders. Fender requires drilling for installation.

**VT No. Item**

**50-1037** Complete Kit

**37-9024** Chrome Eye Bolt Set



50-1033  
Installed

**Sargent Stripe Set** includes six pieces in stainless with attachment clips. Drill template included for 1949-57 rigid fenders.

**VT No. 50-1033**



**Chrome Rigid Rear Fender Stripe Set** features die cast construction with stud mountings to fit 1949-57. Note: Instructions and templates on web.

**VT No. 50-1052**



50-0991

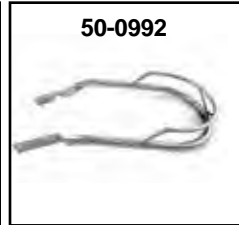

50-0992



50-1047

**Chrome Fender Trim Rails** for FLH, 1949-84 drum and disc models, and rear for 1958-84 FL models.

**VT No. Fits Style**

**50-0992** Front V Design

**50-1047** Drum only V Design

**37-9108** Spacers For Above

**50-0991** Rear V Design

**37-8997** "T" Bolt Front

**37-0854** Front Mount Kit

**50-0345** Rear V



50-1100



50-1058



50-1058



31-1346

**Front and Rear Bumpers** feature rubber inserts as original.

**VT No. Year Type**

**50-1100** 1968-80 Front, FLH

**50-1058** 1968-84 Front Rubber insert

**37-9108** 1968-up Front Spacer, four piece

**37-0855** 1968-84 Mount Bolt Kit

**31-1346** 1977-up Front, Bracket



50-1045  
Installed

**Stainless Steel Fender Trim Set** features two 9" and two 10" strips for the top of all 7 1/4" wide rigid, swing arm or bobbed rear fenders. T-bolts and supplied for ease of installation. **Note:** Template on web.

**VT No. 50-1045**



50-1084  
Installed



50-1084



50-1531

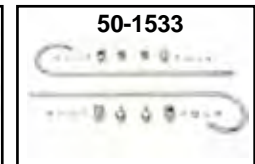

50-1533



50-1532

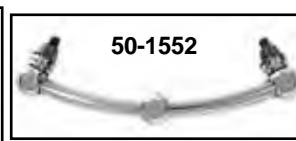

50-1552



50-1534

**Chrome Front Fender Rails** fit FL style front fenders. Includes mount stanchions and template.

**VT No. Type**

**50-1084** Rail Trim Kit, Custom

**50-1531** 1949-up, Short

**50-1533** 1949-up Wide Glide Forks, Candy Cane

**50-1532** Dual Rail, 9" Long

**50-1552** Lower Fender Rail

**50-1534** Loop



# Fender Tip and Trim

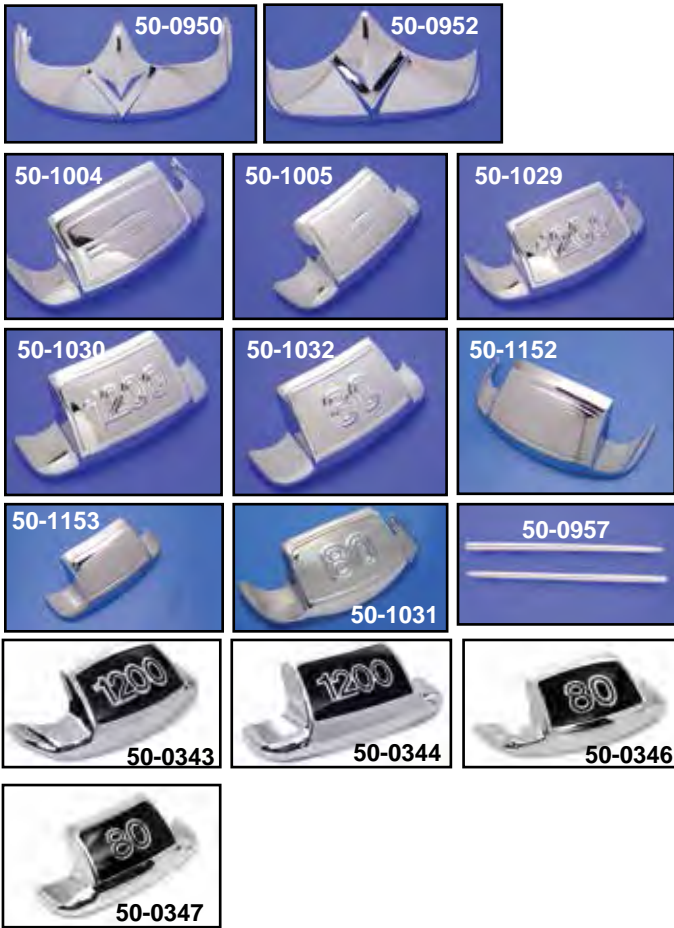

Die Cast Chrome Fender Tips fit 1958-84 FLH. Order the side rails separately.

Front	Rear	Years
50-0950	50-0952	1959-66
50-1004	50-1005	1967-72
50-1029	50-1030	1978-79
50-1031	50-1032	1980-84
50-1152	50-1153	1980-84
	50-1191	1980-84
Painted Inlay		
50-0343	50-0344	1200 cc
50-0346	50-0347	80"
Stainless Side Rails		
50-0957		1967-up



**Lower Fender Trim** includes screws except 50-1015. Fits 1949-84 FLH.

VT No.	Type
50-1003	Smooth
50-1009	Ribbed
50-1132	Flame
50-1133	Smooth
50-1015	Smooth
37-1508	Screw Kit



**1936-58 Fender Tips.** Order the side rails separately.

VT No.	Type	Year	Finish
50-0953	Front	1949-58	Stainless
50-0955	Front	1935-46	Chrome
50-0956	Rear	1935-46	Chrome
50-0954	Rails	1949-56	Stainless
50-0951	Rails	1957-66	Stainless
50-0531	Rails	1957-up	Chrome
37-8784	Set	Four T-Bolts and Four Nuts	

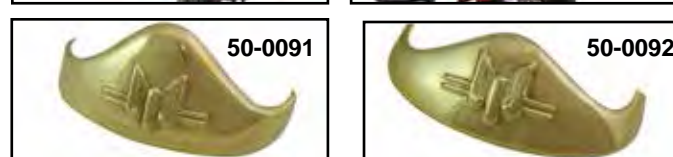

**1936-48 Fender Tips.**

Chrome	Brass	Type
50-0047	50-0091	Rear, Rocket Style
50-0048	50-0092	Front, Rocket Style



**Chrome Fender Tips** in stamped steel. For 1934-57 front or rear fenders.

VT No.	Style
50-0999	Smooth
50-0916	Eagle



**Chrome Fender Tip Set.** Tips attach by 2 studs on each tip. Installation requires drilling of holes in fenders. Order side rails separately. **VT No. 50-0504**

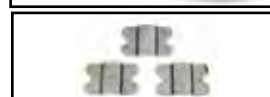

**Rear Fender Wiring Loops.** Set of 3. **VT No. 50-0339**





# Kickstand



**Chrome Smooth Kickstand Bracket** is one-piece forged design with recessed mount hardware.  
**VT No. 27-0250**



**Chrome Kickstand Assembly** fits 1936-85 models. Kit includes late style mount bracket with built in spring plate, lock tab, spring and flat bottomed forged side stand with mount hardware.  
**VT No. 27-1720**



**Custom Kickstand Assembly** features full forged construction with chrome smooth contour design, including recessed mount screws for 1936-99 Big Twin, 4-Speed, 1984-up Softtail models. Stock length.

**VT No. 27-0253**

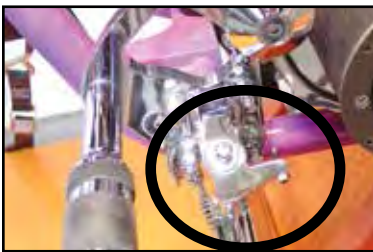
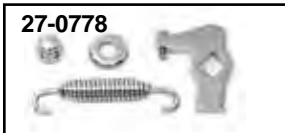
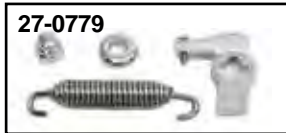

**Chrome Adjustable Kickstand Locktab** fits 1936-up Big Twin models. Prevents stand from hitting primary cover.

VT No.	Item	Year
27-0514	Tab	1936-up
27-0778	Kit	1941-84 FL
27-0779	Kit	1986-up FXST



**Chrome Kickstand Assembly** as shown is for 1936-85 Big Twin-FL-FX-FXWG and for 1984-99 FXST.

**VT No. Year/Type**

**27-1555** 1936-85 Stock

**27-1617** 1936-85 Extended for 2-4" Front Fork

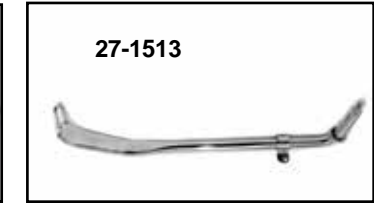
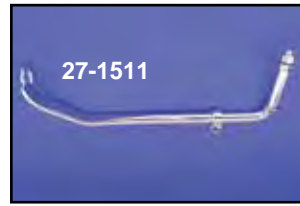

**Forged Big Twin Kickstand** is made of heat treated steel and chrome plated. It features a flattened base as original. Extended types fit extended fork lengths as noted.

VT No.	OEM	Length
27-1511	50061-36	Stock
27-1603	Heavy 18mm	Stock
27-1512	Extended	2-4"
27-1513	Extended	4-6"

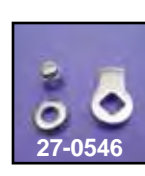
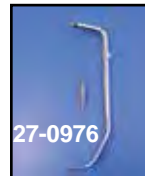

**Forged Kickstand** with spring fits 1936-84 Big Twin.

**VT No. Item**  
**27-0976** Stand Kit  
**27-0546** Lock Kit



**Kickstand Lowering Wedge** fits under the mount bracket to change the angle of the bracket and assembly, when using shock or fork lowering kits. **VT No. 31-0215**



**Kickstand Bumper Pad** is for use on all 1970-85 Big Twins with aluminum primary. Adhesive backed for quick installation. Sold in a 10 pack.  
**VT No. 28-0704**

# Display Stand

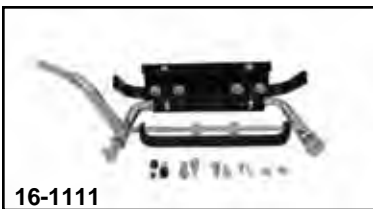

**Chrome Center Display Stand** shows off 'Dresser' on stand, by standing upright, and allows fluid levels to be checked. It tucks under floor boards when not in use. Fits 1970-79 FLH.

**NOTE: NOT FOR USE AS RIDE OFF STAND.**

**VT No. 16-1111**



# Kickstand

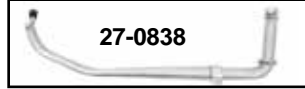
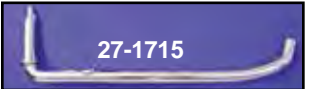
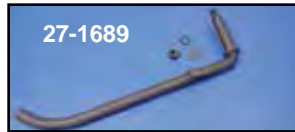
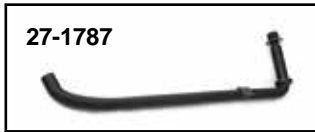

**Replica Stock Kickstand Legs** replace 50061-36 for 1936-69 models.

VT No.	Finish	Type
27-1787	Parkerized	Replica
27-1679	Black	
27-1689	Parkerized	
27-1707	Cadmium	
27-1708	Chrome	
27-1715	Chrome	
27-1790	Chrome	Replica
27-0838	Zinc	Replica

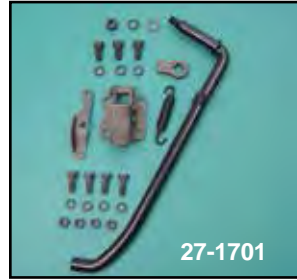

**Replica Kickstand Assembly** fits 1936-57 Rigid Big Twins. Includes bracket, lock tab, spring, spring tab, leg and hardware in stock or chrome finish.

VT No.	Item
27-1732	Kit, Replica
27-1701	Kit, Black and Parkerized, Complete
27-1713	Kit, Chrome Complete
27-0082	Kit, zinc
27-0172	Parkerized Replica

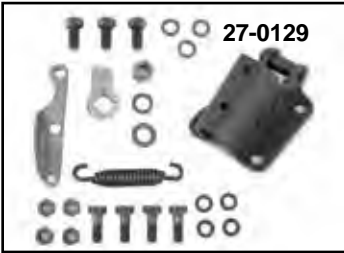
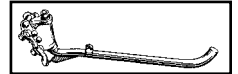

**Replica Kickstand Mount Kit** includes bracket, spring, clip, locktab and mount hardware in parkerized finish.



VT No.	Item	Year	Finish
27-0713	Kit	1936-57	Parkerized
27-0129	Kit	1958-84	Parkerized
27-0381	Bracket	1936-38	Parkerized
27-1508	Bracket	1936-57	Parkerized
27-0533	Bracket	1936-84	Parkerized
27-0598	Bracket w/o	1936-57	Parkerized
27-1682	Spring Clip	1936-84	Parkerized
27-1683	Spring	1936-84	Black
13-0876	Spring	1936-84	Parkerized
27-1684	Lock Tab	1936-84	Parkerized
27-1273	Lock Tab	1936-84	Parkerized



**Kickstand and Foot Clutch Bracket Mounting Kit** attaches assembly to left side of frame for 1936-99 models.

VT No.	Finish	Type
7803-11	Chrome	Acorn
9617-18	Chrome	Hex
9617-18T	Chrome	Hex
9618-18	Cadmium	Hex
9619-18	Parkerized	Hex
9619-18T	Parkerized	Hex

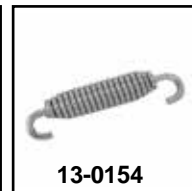
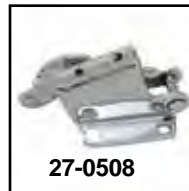

**Chrome Big Twin Kickstand Hardware Springs**

VT No.	Item	Year
13-0154	Spring	1936-85
27-0508	With Spring Tab	1936-85, 10 pack
13-0452	Kickstand Spring	
27-0507	1936-84 Big Twin	
27-0506	Spring Plates	1936-90
27-0504	Leg Stop	



**Complete Chrome Kickstand Mounting Kit** includes kickstand mount spring leg stop and spring plate. Fits 1936-84 Big Twin

VT No.	Item
27-0511	Kit
27-0805	Kit with bolts





# Front Engine Bar



**Lindby Custom Highway Bars** with footpegs feature 1 1/8" tubing for front highway bars and 1" tubing for rear. Both front and rear have built in O-ring footpegs and rear highway bars will work with stock exhaust systems.

## Big Twin Front

VT No.	Year	Model
50-2063	1979-84	FLH 4 Speed
50-2064	1965-78	FLH

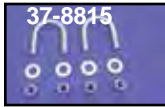
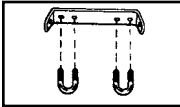

**U Clamp Sets** have a forged design as original.

VT No.	Use
37-8815	Front Engine Bar Clamps
2203-8	As Above, Parkerized

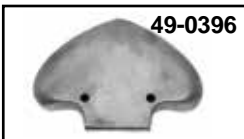
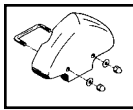

**"Atlas" Style Replica Front Engine Bar Bolt Cover** will mount to 1936-47 Big Twin front bar. U-bolt and acorn nuts available separately.



VT No.	Finish
49-0396	Raw
49-0397	Chrome
49-0534	U-Clamp



## Big Twin Engine Bar Mount Kits.

Chrome	Cadmium	Parkerized	Year
2630-8	2631-8	—	1951-54
—	—	2477-10	1948-54
—	2495-11	—	1958-69
—	—	2203-8	1936-47, 1955-57

**FOR ENGINE BARS LISTED ON THIS PAGE**  
**WARNING:** ENGINE/FRAME BARS MAY PROVIDE LIMITED LEG AND COSMETIC VEHICLE PROTECTION UNDER UNIQUE CIRCUMSTANCES (FALL OVER WHILE STOPPED, VERY LOW SPEED SLIDE). THEY ARE NOT MADE NOR INTENDED TO PROVIDE PROTECTION FROM BODILY INJURY IN A COLLISION WITH AN AUTOMOBILE OR ANY OTHER OBJECT.

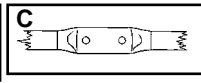
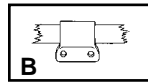
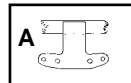

**1" Front Engine Bars** fit on stock frames for years listed. Order U-Clamp separately.

## FL-FLH 4-Speed Models

VT No.	#	OEM	Years	Model
51-1337		Black	1936-38	Big Twin
51-1323		Chrome	1936-38	Big Twin
51-0900	A	49038-36	1936-47	Big Twin
	A	1954-57	Straight Leg	
51-0899	A	49038-36	As Above	Big Twin Black
49-1314		Raw	1936-47	Bracket
51-0896	B	49038-49	1948-Early 54	Big Twin Wish Bone
51-1043	C	49038-49	1948-52	Big Twin Wish Bone with flat mount
51-1044		As Above	Black	
51-1537		49038-48	1948-Early 54	Big Twin Wish Bone
		Black		
51-0609		49059-48	1948-53	Spacers
51-0894		49038-58B	1958-78	Big Twin FL-FLH
51-0901		49039-78	1958-78	Big Twin (1 1/4") FL-FLH
31-4011*		49032-74	1973-84	FX
51-0902		49040-79	1979-84	1 1/4" FL-FLH
51-0891		49016-72D	1972-84	1 1/4" FX, FXE

\*Note: Allows installation of 51-0901 mounting bracket on FX models.

# Rear Frame Bar



**Chrome Rear Frame Bars** fit 1958-84 FL, FLH Swing Arm 4 Speed models.

VT No.	OEM	Fits
51-0928	49137-65	1965-66 Big Twin FL-FLH mounts to shock stud 54-0409
51-0932	49150-58	1958-64 Big Twin FL-FLH Mount Stud for 51-0932
51-0903	37-9022	1968-84 Big Twin Swingarm. Use 54-0425 Stud Spacers when bars are not used

VT No. 51-0903 Installed



## Rear Frame Bars

Item	Finish
51-0895	Chrome
51-0889	Black

**Big Twin Rear Frame Bar Mounting Kit** fits 1936-57 Big Twin. Order VT No. 37-9204, 59802-47, pair of upper bolt studs when it is desired to leave fender bolted in place after removing bar.

VT No.	Item	Finish
9530-13	Bolt Kit	Chrome
9531-13	Bolt Kit	Cadmium
9532-13	Bolt Kit	Parkerized
37-9204	Bolt Set, Upper	Black
37-9176	Bolt Set, Lower	Cadmium

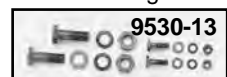



# Rear Frame Stand

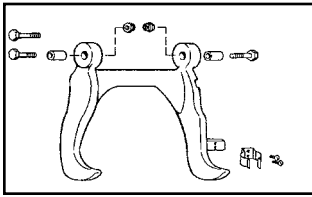

**Center Stand** for 1958-84 Big Twins. Features natural finish aluminum construction, with bushings and bolts. Replaces 49400-59A.

VT No.	Item
49-0928	Stand Complete
37-9306	Bushing Only
2744-10	Mount Kit



**Chrome Front Stand** not for use as ride off. Fits 1965-84 FLH.  
VT No. 16-1111

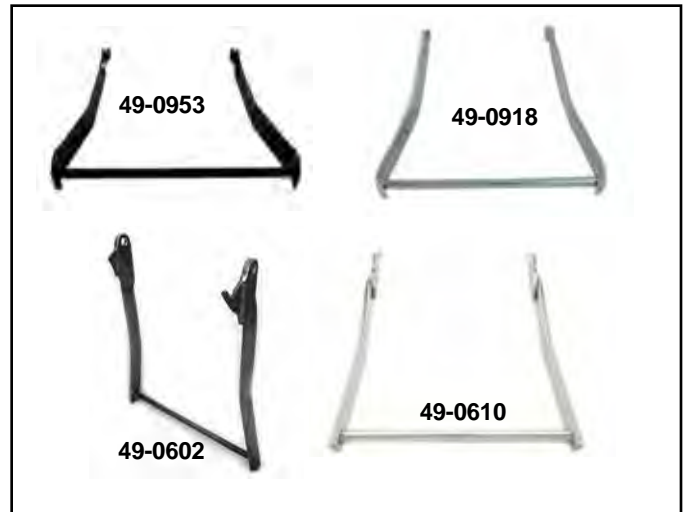

**Rear Frame Stands** for Rigid Big Twin. Order stand catch and mounting hardware separately. VT No. 49-0602 is of tubular shape material.

VT No.	Year	Model	Finish
49-0953	1938-57	Big Twin	Black
49-0033	1941-57	Legs Only	Raw
49-0918	1938-57	74 and 80	Chrome
49-0602	1936 and 1937	Big Twin	Black
49-0610	1936-37	Big Twin	Chrome

**Caution: Not intended for use as a ride off stand.**

## Side Cover



**FLH Left Side Covers** for belt and chain drive models. Covers left side and oil tank. Includes brackets, knobs and hardware. fits 1982-84 FLH.  
VT No. 42-9931



**Chrome Knurled Knobs** for attaching side cover or battery tops on FL models. Sold in pairs. Fits  $\frac{5}{16}$  - 18" Thread,  $1\frac{1}{2}$  outer diameter  
VT No. 37-8873

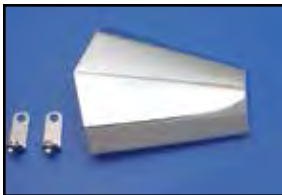

**Chrome Engine Air Scoop** will force air to rear cylinder. Mounts to left side of 1966-84 Big Twin Shovelhead. Brackets are included.

VT No.	Item
42-0317	Kit
31-1025	Brackets



**Chrome FLH Starter Relay Cover Kit** includes hardware. Replaces 66425-68. Use on 1965-84 FL-FLH.

VT No.	Style
42-0313	Smooth
42-0553	Gold Inlay Spirit



**Chrome Front Fender Rail** for 6" front fenders. 1936-52.  
VT No. 50-1534

**Mounting Hardware** fits all models with rear stand.

VT No.	Year	Finish
8840-10	1930-35	Parkerized
2910-6	1936	Parkerized
8841-10	1936-37	Parkerized
8015-4	1938-57	Parkerized
9616-4	1938-57	Chrome
51-0479	1936-57	Tab Set

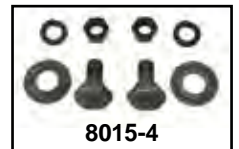

**74 and 80 Stand Catch.** Replaces 49580-36.

VT No.	OEM	Finish	Year
31-0186	49580-36	Parkerized	1936-46
31-0480	49580-36	Chrome	1936-46
31-0370	49580-36	Black	1936-46
31-0853	49580-36A	Parkerized	1947-57





# Big Twin Rigid Chain Guards



27-1600



27-1677



27-0111



27-0126



27-0127



27-0117



27-0124



27-0100

**Universal Chrome Left Side Guard** is 25" long.  
VT No. 27-0100



**Rear Chain Guard Mount Kits** include bolt, nut, spring, washers and cotter pin for Big Twins and 45's.



Detail of 27-0117

Replica V-Twin Chain Guards are produced with permanent tooling for exact fit and shape.

VT No.	Finish	Fits
9746-7	Parkerized	1936-57 Big Twin
2071-10	Chrome	1936-57 Big Twin
13-9186	Black	1936-57 Stud Spring

**Rigid Chain Guards** by V-Twin Mfg.™ include built in stud for mounting to stock rigid rear fender. Order hardware separately.

VT No.	Finish	Year	Type
27-1600	Black	1936-57	V-Twin
27-1677	Chrome	1936-57	V-Twin
27-0126	Black	1941-57	Replica
27-0127	Chrome	1941-57	Replica
27-0117*	Black	1936-40	Replica
27-0124*	Chrome	1936-40	Replica

\*Note: 3 Rivet Construction



49-0494



49-0492

**Outer Chain Enclosure Cover.**

VT No.	Finish
49-0494	Chrome
49-0492	Black

# 1958-84 Swingarm Chain Guards



27-0109



27-0108



27-0121

**Chrome V-Twin Replica 1958 Style FLH Rear Chain Guard** fits 1958-84 FL.  
VT No. 27-0121

**Isomount Swingarm Chrome Chain Guard** is complete with rubber bushing and rear bracket.

VT No.	Fits
27-0109*	1958-85 FX-FL-FXE
27-0108*	1973-82 FX-FL
37-0593	Mount Kit

\*Note: Fits 1958-84 FL also for "the lighter" FX look.



27-0118

**V-Twin Replica 1958-62 FLH Black Chain Guard** fits 1958-84 FX-FL.  
VT No. 27-0118



27-0110



27-0116

**Full Chain Guard** includes bushing. For 1963-84 FLH style.

VT No.	Finish
27-0110	Chrome
27-0116	Black

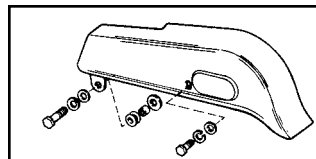

VT No. 28-0422  
Mount Kit for 1963-84 FLH

**Bolt and Bushing Kit** fits FLH chain guard 1963-84.

VT No.	Item
28-0422	Chain Guard Bolt and Bushing Kit
28-0132	Rubber and Steel Bushing Set
37-0427	Steel Bushing only
28-0411	Rubber Grommet Only



# Toolbox



**Rigid Toolbox Kit** includes a raw bracket and a tool box.

VT No.	Finish	Type
50-0926	Chrome	Oval
50-1186	Black	Oval
50-0341	Black	Rectangle
50-0041	Black	Rectangle



**Toolbox Mounting Kit** for Big Twins includes all necessary stock hardware to mount the tool box. Cadmium plated.

VT No.	Fits
2002-13	1955-57
2003-6	1958-Early 1962
2004-6	Late 1962-1964

**Mounting Kit** for 1935-54 Big Twin and 45 Toolbox includes all necessary stock hardware to mount the stock oval tool box as listed.

VT No.	Finish
8206-9	Cadmium Kit
9669-9	Parkerized Kit
9669-9T	Parkerized Kit
37-9178	Cup Washer

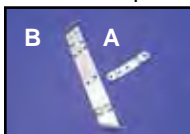
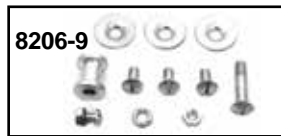

**Two Piece Toolbox Mount** is used on 1936-53 models as replacement mounts for stock and custom rigid frames. Mounts box higher than one piece style bracket.

VT No.	#	Item	Year
31-0525	A and B	Kit	1948-54
31-0655	A and B	Kit	1948-53, Replica
31-0772	B	Bracket	1948-53
31-0406	A	Cross Bracket	1948-53
31-0579	A	Cross Bracket	1948-53, Replica



**Replica Vertical Toolbox Mount** for Knucklehead.

VT No.	#	Year	Item
31-0626	A	1936-37	Each
31-0683	A	1938-40	Each
31-0578	B and C	1941-47	Kit
31-0412	C	1941-47	Cross Bracket
49-1258		1938-40	Pad
49-1259		1936-37	Pad



**Replica Toolbox Mounting Bracket** is a one piece design mount that fits all Rigid frames is correct for 1954-57. **VT No. 31-0528**

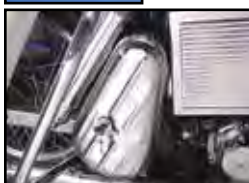

**1977-84 FLH Toolbox Kit** fits right side, contours rear shock and bolts to rear battery tray and exhaust tube mount. Kit is ribbed and allows use of FXE or FLH exhaust.

**VT No. 50-2022**



**Spark Plug Holder** clamps to the rear frame tube on Rigid Big Twins. Holds two spark plugs.  
**VT No. Finish**  
42-0318 Chrome  
42-1537 Black



**Replica Toolboxes** are for right side use and include keys, VT No. 48-3094 is a leather pouch insert for oval toolboxes. Order mount hardware separately.

VT No.	Type	Shape
50-0600	Chrome	Oval
50-0926	Kit	Oval
50-0601	Black	Oval
50-0608*	Chrome	Oval
50-0615	Raw	Oval
49-0996	Raw	Oval (2 bullet holes by 9 mm Glock)
50-0602	Chrome	Rectangle
50-0983	Black	Rectangle
50-1139	Raw	Rectangle
50-0947	Raw	Rectangle
50-1535	Black	Rectangle
50-0603	Key Set	
	Parkerized Keys	
50-0342	Lock with keys	
50-0505	Lock Kit	



**\*Note:** Requires purchase of appropriate mounting kit which includes correct knob as listed below.



**Toolbox Mounting Bracket** mounts kidney toolbox to 1977-84 FX on the rear passenger peg block on left side.

VT No.	Item
50-0934	Kit
31-0527	Bracket



**Toolbox Wing Nuts** have a zinc finish.  
**VT No. 37-6136**





# V-Twin Replica Motorcycle Kit

## V-Twin Replica Knucklehead

This machine is recreated with the original *Bobber* styling of the late 1940's, utilizing the full range of V-Twin Replica Parts. Engine details include cast motor case with relay and number boss, but reinforced at cylinder base area for added strength. Knuckleheads are replicated from ductile cast iron with accurately formed valve cover set and plumber style manifold. Foot Shift model includes hand-shift gate and handle for decoration only. Other components in assembly include:

- 29° V-Twin Replica frame
- Replica Knuckle Tanks
- Chopper Solo Seat
- 16" Rear and 18" Front Wheel
- Chrome Stock Inline Spring Fork

### We've done your homework on this one!

- V-Twin Replica Motorcycle Kits are equipped with all the necessary parts except gas, oil and battery electrolyte!
- All components used throughout the assembly have been selected for each particular year of application.
- Engine is completely assembled pre-run and tested for oil pressure
- Transmission completely assembled
- Wheels, laced and trued in our facility with bearings pre-set



Take a closer look.  
**Original Styling!**  
 Want a really different look...  
**How about Stock?**



Replica	Bobber	Type	Finish
55-5013	55-5009	Handshift	Chrome
55-5014	55-5010	Handshift	Resto
55-5016	55-5011	Footshift	Chrome
55-5017	55-5012	Footshift	Resto
	55-3637	Handshift	Resto







# 1948 Replica Panhead



*Left Side Detail includes Rocker Clutch and Diamond Primary*

- Just Add...**
- Paint
  - Assembly
  - Gas, Oil, Electrolyte
  - Rider



*Kits include all parts necessary for complete construction!*



*Authentic Fork Look!*



*Accessories include original style Spotlamps!*



***Our Replica is supplied with all the options included. There are no extras. There is nothing else to buy. You can plan your construction project up front and actually be able to visualize the end result. You will not end up spending extra time and money searching for parts that are virtually impossible to find. In the long run, you would spend more time and money on parts than you would the V-Twin kit.***

**Industry First!  
First Assembly done  
Raw Finish in 1998!**

- Available as a complete project kit based on an authentic **V-Twin Replica Wishbone Frame**.
- Unassembled kit is available with parts necessary to complete an entire Exemplar Panhead.
- Kits are available in either chrome, with chrome plated components and accessories, or as a restoration style with restoration finishes of black and parkerized components.
- Choose hand or foot shift control assemblies for desired configuration.
- Supplied with a completely assembled and test run 74" V-Twin Replica Panhead™ engine with either aluminum or chrome detailing.
- Pre-wired dash base assembly
- Parts book and maintenance manual included
- 4-Speed early transmission is assembled into the V-Twin™ Replica 4-Speed gear box, complete with ratchet top and chrome or restoration particulars.
- See the V-Twin Mfg.™ catalog for details on all items included in this kit.
- Replica Motorcycle Kits are sold as component parts. Manufacturer's Statement of Origin (MSO) is supplied for the frame and engine.
- Check your state for registration, title and licensing requirements.

	Handshift Chrome	Handshift Resto	Footshift Chrome	Footshift Resto
1948 Panhead Replica	55-5003	55-5008	55-5002	55-5007
1941 Knucklehead Bobber	55-5009	55-5010	55-5011	55-5012
1941 Knucklehead Replica	55-5013	55-5014	55-5016	55-5017





# V-Twin Replica Brazed Knucklehead Frame



Brazed	Year	Rake
51-1040	1936	28°
51-1039	1937	28°
51-1938	1938-40	28°
51-1942	1941-Early 1946	29°



## Rolling Chassis Kits

V-Twin Mfg. **Rigid Replica Rolling Chassis** include Replica Fork™, Replica Frame™ and related components as appropriated for model years listed. Available in chrome or restoration (resto) finish. Available in hand or foot shift style tanks.

HandShift	Handshift	Footshift	Footshift	Year/Model
Chrome	Resto	Chrome	Resto	
	55-1937	—	—	1939 Replica Knucklehead
55-2536	55-2539	55-2529	55-2522	1948 Replica Panhead
55-2532	55-2523	—	—	1941 Replica Knucklehead
55-1956	—	—	—	1956 Replica Panhead
55-2537	55-2546	55-2524	55-2533	1957 Replica Panhead
55-2531	55-2527	—	—	1947 Replica Knucklehead "Bull"
55-2538	55-2541	55-2528	55-2534	1949 Replica Panhead





# V-Twin Replica Knucklehead Frame

V-Twin™ Replica Frames...the difference is REAL!



Neck Detail



Over 3000 Served Since 1995!



51-1040

Use replica mount kit for mounting coil.



51-1040



51-1041



Cross Shaft



**Knucklehead Frame Notes:**

VT No.	Year	Rake #1	#2	#3	#4	
51-1040	1936	28°	Rectangular Tool Box Pads	No 5th Mount	7/8 Tank Brace	Open Brake Tab
51-1039	1937	28°	Rectangular Tool Box Pads	5th Mount	7/8 Tank Brace	Open Brake Tab
51-1041	1938-40	28°	Round Tool Box Pads	5th Mount	1" Tank Brace	Closed Brake Tab
51-1947	1947	30°	2 Tool Box Holes	5th Mount	1" Tank Brace	Closed Brake Tab

**The Construction**

V-Twin™ Replica Frames feature steel forgings in neck, front and rear engine mounts, rear axle plates, swingarm and shock mounts. In this process, the steel is first fired as red hot ingot, next huge hammers compact and orient the grain structure into a rough shape of the parts. Subsequent hits form the part into its final shape, after which it is machined and heat treated which results in increased strength and resistance to wear. The related components used in construction are accurately formed stampings and drawn over mandrel seamless tubing which is tig welded together during final assembly.

**Toolbox Bracket Details**



Square  
1936-37

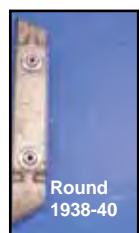

Round  
1938-40

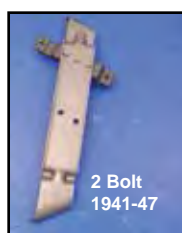

2 Bolt  
1941-47

V-Twin™ Replica Knucklehead Frame is an authentic reproduction of the factory style frame. Details include forged parts as original in neck, front and rear engine mounts, side car loops, top seat yoke, footboard tabs and rear axle plates. Exact blanked and formed stampings are utilized in appropriate areas. Rear fender cross bar is supported by exact duplicated "saddles" brazed at each end. Seat post and mechanical brake cross shaft bushings, correct tool box mount and grease fittings are installed. The 28° or 29° neck angle will accept inline spring forks. The frame will accommodate Knucklehead or Big Twin Flathead Engines and 3 or 4 Speed transmission only. Knucklehead frames require purchase of clamp on coil bracket kit VT No. 49-0099.

\*Note: Includes seat post, transmission plate and axle assembly.

VT No.	Year	Rake	Brazed
51-1040	1936	28°	51-1040
—	1937	28°	51-1039
51-1041	1938-40	28°	51-1938
—	1941-Early 1946	29°	51-1942
51-1947*	1947	30°	—





# V-Twin Replica Knucklehead Frame



1936-40 Neck has original forge mark!



51-1941



51-1941



51-1947



51-1947

**Knucklehead Frame** is an authentic reproduction of the factory style bull neck frames. Forged parts included in the construction are the neck, front and rear motor mounts, side car loops, yoke and rear axle plates. The 30° neck angle will accept offset spring forks. Top cross member across rear legs is brazed as on original Knucklehead frames. Seat post and mechanical brake cross shaft bushings, **correct tool boxmount, and grease fittings are installed.**

**VT No. Rake**

51-1941 29°

51-1947 30°

**Replica Frames** with accoutrements as shown on detailed areas make this the premier frame in the industry.

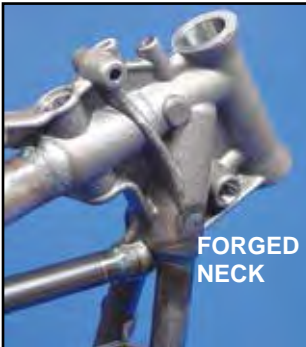

FORGED NECK



REAR AXLE PLATES



SIDE CAR MOUNTS



SEAT POST FORGING

**Forged Neck** yields the hallmark look of this replica, which will accept a neck lock and glide damper stud. Top engine mount has key hole slot which is the 1953-57 type. Spark and throttle cable mount tabs are also provided.



**Rear Engine and Front Transmission Mount** is of forged steel, with bushing installed. Transmission mounts incorporate a formed reinforcement strap to connect the two tier support strap assembly, all of which is constructed accurately of blanked and formed stampings.



FOOT BOARD TABS

**Right Side** exhibits formed steel parts including fifth mount and lower rear fender bracket. The forged footboard tabs are welded in place as original. Mechanical cross tube features laminated support bracket with bushing and grease fitting installed.



**Forged Steel Parts** deliver full strength and exact detail in front engine and side car lugs.

**Over 8000 Served since 1995!**



# Replica Knucklehead



55-1947



Sold unassembled and unpainted.



55-1955



Bobber  
Knucklehead  
Chassis  
VT No. 55-1945



55-1945

- Bobber Chassis Kit.**  
**VT No. Style**  
 55-1936 Knuck  
 55-1938 Knuck  
 55-1945 Knuck  
 55-1960 Evo-Shovelhead TC-88  
 55-1955 Panhead  
 55-1947 Knucklehead  
 55-1938 Knucklehead  
 55-1948 Panhead

**FOR SALE**  
 V-Twin Mfg.  
 Knucklehead 74" Complete but  
 Needs Paint, Wiring, Assembly  
**\$19,500<sup>00</sup>**  
**Phone: (845) 565-2806**  
**We Sell Knuckleheads**  
**One Part at a Time!**



1947 Knucklehead Replica Kit includes fully assembled motor, transmission, wheel assemblies and fork. All parts included except paint and assembly. See web parts build list. VT No. 55-1947

See You on The Web!

[www.vtwinmfg.com](http://www.vtwinmfg.com)

1957 Panhead  
VT No. 55-1957

CLASSIC





# Frame and Fork Kit



55-0000



55-0000



55-0000



VT No. 55-1939

Green Bobber Kit.  
VT No. 55-1939



## Frame and Fork Kit

VT No	Frame	Fork	Fits
55-0000	51-1953	49-2407	1946-48 FL, 1946-48 UL
55-0001	51-1953	49-2412	1946-48 FL, 1946-48 UL
55-0002	51-1957	49-2420	1941-68 FL, 1971-99 FX
55-0003	51-1948	49-2420	1946-48 FL, 1946-48 UL
55-0004	51-1200	49-2407	1946-48 FL, 1946-48 UL
55-0005	51-1200	49-2412	1956-62 FL, 1946-48 UL
55-0006	51-1948	49-2417	1941-45 FL, 1937-45 UL
55-0007	51-1957	49-2417	1941-45 FL, 1937-45 UL
55-0008	51-1942	49-2909	1941-45 EL, 1941-45 FL
55-0009	51-1942	49-2900	1941-45 FL, 1941-45 EL
55-0010	51-1938	49-2900	1941-45 FL,
55-0011	51-1938	49-2909	1938-45 EL, 1941-45 FL,
55-0012	51-1947	49-2407	1946-48 FL, 1946-47 EL
55-0013	51-1947	49-2412	1946-48 FL, 1946-48 UL
55-0014	51-1039	49-2900	1941-45 FL, 1941-45 UL
55-0015	51-1039	49-2909	1937-45 EL, 1941-45 FL
55-0016	51-1957	49-0835	1997-05 FLST
55-0017	51-1957	49-0839	1997-05 FLST
55-0018	51-1957	49-0843	1997-05 FLSTS
55-0019	51-1948	49-0835	1997-05 FLSTS
55-0020	51-1948	49-0839	1997-05 FLSTS
55-0021	51-1948	49-0843	1997-05 FLSTS

## V-Twin Product Subassemblies

### Watch Our Video!

<http://www.youtube.com/user/TeddCycle>



TT Bobber Short Oil Tank



1955 Panhead Replica. Museum quality.  
VT No. 55-1520



40-0488



40-0493

Replica "Bobber" Rigid Frame Oil Tank fits 1936-57 Big Twins. Tank is 1/16" shorter to accommodate a raised position for chain alignment. Tank will accept mini 12 volt battery.

- VT No. Finish
- 40-0488 Chrome
- 40-0493 Black
- 37-1018 Spacers

# Replica 1959 Duo-Glide Kit



You'll want to take a closer look.  
*Original styling!*  
Want a really different look ...  
How about "STOCK"?

V-Twin Mfg. Replica Swingarm Rolling Chassis Kit features Replica Frame™ and appropriate style components for each year as listed. Accepts a Panhead or Shovelhead engine.

VT No.	Year-Group	Model
55-2525	1958-59	Panhead
55-2567	1960-65	Panhead
55-2566	1966-72	FLH
55-2526	1973-84	FLH
55-1959	1959	Pan Replica



**Weld-On Mount Tabs** fit Rigid frames when mounting brake units.

VT No.	Type
51-0511	Hydraulic Rear Back Plate
51-0512	Caliper Arm Tab
51-0513	1987-99 Mount (Right Side)
51-0845	1987-99 Mount (Left Side)

**1959 Duo-Glide Replica Kit** includes fully assembled motor, transmission, wheel assemblies and fork. All parts included except paint and assembly. See web parts build list.

VT No. 55-1959

## Rigid Frame



**Stock Rigid Frames** are available in either wishbone or straight leg style. Features stock neck for Wide Glide triple trees and bobbed mounts. No stretch or rake. Does not accept a seat post.

**4-Speed Rear Chain Drive**

Wishbone Type	Straight Leg	Engine	Brake
51-2178	51-2179	Panhead or Shovelhead	Mechanical

## Skid Plate

**Steel Skid Plates** replace 24490-36, 1936-99 Big Twin.

VT No	Finish
42-0101	Chrome
42-0098	Stainless
42-0777	Chrome
42-0117	Black
42-5025	Black, Replica







# V-Twin Replica Straight Leg Frame

V-Twin Mfg. is the sole maker of Rigid Frames which utilize "Forged" components!

**Since 1995...**



51-1956



51-1956

**Replica Straight Leg Rigid Frame** with cross tube is for chain drive models. This frame is an authentic reproduction of the 1954-1957 straight leg frame with a stock 30° neck rake. Details include forged parts as original neck, front and rear engine mount, side car mounts, top seat yoke, axle, seat post and footboard tabs. Front engine mount spacer will allow installation of a Knucklehead or Flathead engine. Cross shaft may be removed for use with hydraulic or disc brakes. Disc or drum brake tabs are available separately. Seat post bushing and mechanical brake cross tube bushing may require reaming prior to assembly. The frame has an indent on the left lower rear frame bar for tooling fixture. A Bill of Sale is supplied.  
**VT No. 51-1956**

## Retro Rigid

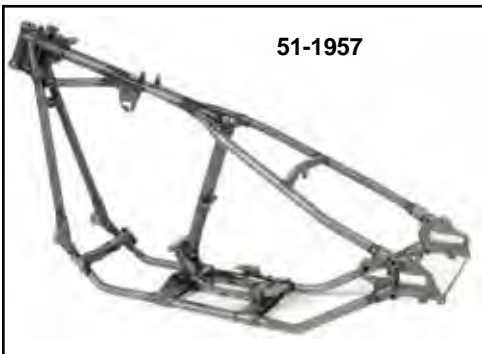

51-1957



51-1948



51-1948



51-1957

**Replica Retro Rigid Frame** features original style construction including forged parts in neck, side car mounts and rear axle areas. Rear axle plates are 10<sup>3</sup>/<sub>4</sub>" between inside surfaces. Order rear mount for TC-88 models separately. This retro rigid frame can be fitted with a Panhead or Shovelhead engine with a 4-Speed transmission. A tin inner primary 42-0617 must be utilized for this application. Use of a 1/2" offset transmission mount plate and 1/2" offset motor sprocket with splines will offer clearance to use a 200 rear tire with a chain rear drive. Additional clearance can be achieved with the addition of a 1/4" offset transmission sprocket.

**\*Note:** For Evolution/TC/Shovelhead/Panhead engines.

Frame will accept:

- Flatside tanks
- Softail oil tank
- 230 rear tire with chain
- 200 rear tire with belt
- +2" raised neck
- Stock rake, 30°
- Order related parts separately.
- 31-0859 oil tank bracket
- 44-1942 axle
- 51-0625 TC-88/ Evolution rear engine mount adapter
- 44-1946 axle collars

**Raw Style**  
**51-1957\*** Straight Leg  
**51-1948\*** Wishbone

Related Components		
VT No.	Item	Note
17-0945	Engine Sprocket Nut Kit	
19-0399	Transmission Sprocket	22T
19-0447	Transmission Sprocket	23T
19-0448	Transmission Sprocket	24T



# V-Twin Replica Wishbone Frame



51-1949



51-1200



51-1953



**Rear Section** demonstrated forged rear axle plates and replica tool box mount for authentic look.



**Seat Area** utilizes cast yoke to accept stock seat post bushing which is included. Rear down tube has cast front oil tank mount and coil mount blocks installed. Lower tube bushing is welded to secure lower seat post lock nut.

Our replica frames are available for Big Twins from 1936-99 for the original look and style of the factory.

## Forged Neck is accomplished in 4 stages.

Note:



**The Forging Process**  
In this process, the steel is first fired as red hot ingot, next huge hammers compact and orient the grain structure into a rough shape of the part, subsequent hits form the part into its final shape, after which it is machined and heat treated which results in increased strength and resistance to wear.



**V-Twin™ Replica Wishbone Frames** are authentic reproductions of 1948-53 Big Twin rigid frames. Details include forged parts as original in neck, front and rear engine mounts, side car loops, top seat post yoke, footboard tabs and rear axle plates. Exact blanked and formed stampings are utilized in their respective places. Neck will accept steering key lock. Mechanical brake cross shaft bushings, correct tool box mount and grease fittings are installed. The 1949-51 model has lugs on inside front down tubes to accept horn, 1948 model does not. Frame will house Panhead or Shovelhead engines and a 4 Speed transmission. VT No. 51-1015 will allow installation of a Knucklehead or Flathead engine with front engine mount space with front mount spacer. Complete kits include seat post, axle and transmission plate already installed.

VT No.	Year
51-1949	1948
51-1200	1949-52
51-1953	1948-54

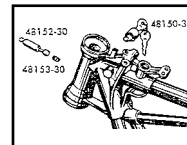

**Complete Steering Head Lock Assembly Kit** includes cylinder lock, two keys, pin, frame plug, spring and plunger.

VT No.	Item
37-9021	Complete Kit
51-0610	Trim Ring

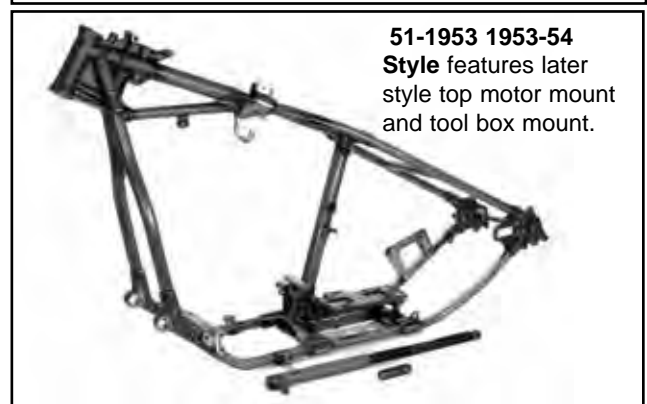





# V-Twin Mfg. Replica Swingarm Frame



Swingarm Pivot Points Forged Steel as Original



51-1006



51-1004



51-1006

Neck Detail



Forged Front Lower Motor Mount for Strength



Seat Post Yoke

V-Twin Swingarm Frames are our authentic reproductions of FLH styles for the years listed to accept Panhead or Shovelhead engines, 4 Speed Transmissions, seat posts and round or square swing arms. Details include forged parts as original in neck, engine mounts, front transmission mount, top seat post yoke, strut and swingarm pivot mount and footboard mounts, as required. All stamped components are pressed and formed as stock.

VT No.	Year
51-1003	1958-64
51-1006	1965-68
51-1004	1969-84

**1958-64 Style** accepts a 6 volt battery, early wrap around tank and includes footboard tabs. Neck will accept plunger type lock assembly. Features low seat area.

**1965-68 Style** accepts a 12 volt electric start system as stock. Neck will accept lock assembly.

**1969-84 Style** accepts a 12 volt electric system. Neck includes 17 digit serial number boss and tab for stem padlock.

## Forged Neck is accomplished in 4 stages.



### The Forging Process

*In this process, the steel is first fired as red hot ingot, next huge hammers compact and orient the grain structure into a rough shape of the part, subsequent hits form the part into its final shape, after which it is machined and heat treated which results in increased strength and resistance to wear.*



51-2170



**Paughco Swingarm Frame** features stock style neck with no rake or stretch. This frame utilizes electric start components from 1965-1984 FLH-FXE models. Frame will house a 4-speed transmission and a Panhead or Shovelhead engine. Frame uses oil tank and frame swingarm for chain drive or belt drive.

VT No. 51-2181

**Paughco Swingarm Frame** accepts Panhead or Shovelhead engines with chain or belt drive. Swingarm frame features low seat area to be used with stock type seats and wrap around style oil tank or with stock type square oil tank. This low seat frame use 40-0412 oil tank for kick starter or 40-0408 oil tank for electric start models. 51-0907 swingarm is suggested for chain drive, 51-2149 swing arm is suggested belt drive applications. Frame will accept a 4-speed transmission.

VT No. 51-2170



# Hardtail



51-0457



51-0457

Exact  
Replica!



51-0823



51-0920



51-0781

CLASSIC

**Big Twin Weld-On Hardtails** fit to stock frames for 1958-85.

**VT No. Drive Style**

- 51-0920 Chain Drum
- 51-0781 Replica Drum
- 51-0457 Replica Assembly
- 51-0823 Replica Rear Section

**Miscellaneous**

- | VT No.   | Item                                  |
|----------|---------------------------------------|
| 51-5001  | 200 SERIES XL RIGID CHASSIS KIT       |
| 52-0232  | 18" X 2.15" BLACK POWDER COAT RIM     |
| 52-0898  | 16" X 3.00" FRONT WHEEL, CHROME       |
| 52-1255  | 18" X 2.15 FRONT OR REAR WHEEL        |
| 52-2038  | 16" X 3" REAR WHEEL, STAINLESS STEEL  |
| 49-0010  | SPROCKET SEAL RING, STEEL             |
| 49-1648  | HEADLAMP STUD NUT                     |
| 49-1872  | INNER PRIMARY REBUILD KIT             |
| 49-1920  | SOLO REAR KICKSTAND CATCH, CHROME     |
| 49-2003A | KICKSTAND BUSHING ONLY, PARKERIZED    |
| 49-2382  | JIFFY KICKSTAND LEG ONLY, CHROME      |
| 50-0621  | BLACK RIGID TOOL BOX KIT              |
| 51-0106  | WYATTS 250 RIGID FRAME                |
| 51-0704  | 250 FRAME REAR SECTION                |
| 51-0823  | RIGID HARDTAIL FRAME REAR SECTION     |
| 51-0966  | 4-SPEED FRAME W/O TRANSMISSION PLATE  |
| 51-0979  | REAR SWING ARM, CHROME                |
| 51-1341  | OE WIDE REAR TIRE KIT W/O REAR PULLEY |
| 51-1342  | WIDE TIRE KIT                         |
| 51-0337  | SWITCHBLADE REMOVABLE WINDSHIELD      |
| 49-1518  | 45" FRONT SEAT BRACKET                |
| 49-1380  | SEAT T SPACER RIVET PLATE, RAW        |
| 49-1381  | SEAT T CROSS STRAP, RAW STEEL         |
| 35-0037  | S&S "B" CARBURETOR KIT                |

### The Bobber Replica

The "Bobber" style was perhaps the first mainstream customized motorcycle following the motorcycle's evolution from utilitarian form of transportation to a vehicle used for recreation. From the Harley-Davidson 'Shop Dope', Nov. 16, 1973: "Suggestions for preparing 1937 & 1938 'WLDR' model motorcycles for long-distance racing such as 200-mile race at Daytona, Florida. Remove headlight, horn, muffler, speedometer, front mudguard, and rear half of rear mudguard. (Some riders make up short narrow front fender for sand kicked up by the front wheel.)" There are an additional 12 points concerning the turning & preparation of the motorcycle for racing, you can see the beginning of the bobber style. It wasn't a big step for racing enthusiasts to copy the racers of the day, strip off all unnecessary parts from there stock bikes to reduce weight and make them at least look fast and lean. This was the birth of the "Bobber", a styling cue named for the 'bob tailed' rear fender and based more upon what's not there, a minimalist form- follows function exercise. Plus it was a financially economical look; any kid from the early 1950's could buy a beat up or army surplus motorcycle for a few bucks, take off the some sheet metal and the muffler and have a hot rod. Add a fancy paint job and you have custom motorcycles to go along with the chopped and channeled hot rod cars of the day. 'Speed' lines borrowed from the art deco era & graphic embellishments like scallops made them all look like they were going 100 mph whole standing still. Scallops got longer and evolved into flames. Bobbers eventually evolved into choppers, where frames were chopped & raked to accommodate extended front ends, everything got chromed, and the motorcycles were customized from the frame out. But the Bobber was where it all started.



**Tedd Cycle first use in 2003**





# Gas Tank



38-0830

38-0831

38-0817

38-0818

38-0819

38-0820



38-6696

38-6162

38-6699

38-7022

38-6695

38-6682

38-6670

# Emblem

3.5 Gallon Tank w/shut off provision and emblem mount	3.5 Gallon Tank w/emblem mounts and shut off rod provisions	3.5 Gallon Handshift Tank Kit with emblems and cap	Year	Emblems
	38-0136	38-0469	1940-46	38-6696
38-0830			1947-50	38-6699
38-0831	38-0896	38-0574	1951-54	38-6699
38-0817	38-0890	38-0569	1955-56	38-7022
38-0818	38-0891		1957-58	
38-0819	38-0892	38-0570	1959-60	38-6670
38-0820	38-0893	38-0571	1961-62	38-6162
38-0821	38-0893	38-0572	1963-65	38-6695
<b>5 Gallon Handshift Tanks with emblem mounts</b>				
		38-0546	1966	38-6682
		38-0543	1967-72	38-6682



38-0136

38-0895

38-0896

38-0890

38-0892

38-0891

38-0893

38-0894

38-0546

38-0821



38-0835



38-0836



38-0837



38-0839



38-0841

## Bobbed Gas Tank 3.5 Gallon VT No. Fits

- 38-0835 1947-50 FL
- 38-0836 1951-54 FL
- 38-0837 1955-56 FL
- 38-0839 1959-60 FL
- 38-0840 1961-62 FL
- 38-0841 1963-65 FL

# Swingarm

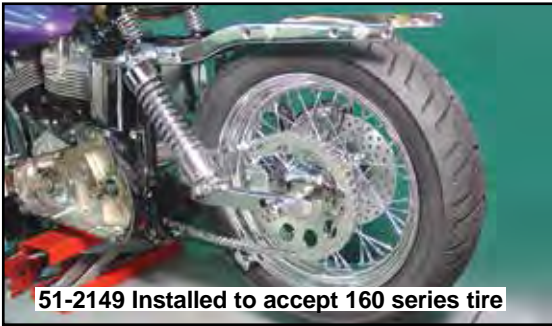

51-2149 Installed to accept 160 series tire



51-2149



51-0907



51-0898



51-2149



51-0908



51-0825



51-0908

**1973-85 FX-FL Swingarms** available for chain and belt drives. Bearings/races not included. For use with banana style caliper only. VT No. 51-2149 will accept up to 160 tire with chain.

Chrome	Black	Year	OEM	Type
51-0907	51-0898	1973-E78	47500-73	Standard
51-2149*		Custom	47446-79	1/2" Wide
51-0908	51-0825	1973-1984	47500-78	Standard
	51-0741	L1978-1984		1 1/4" Lower, Chain

\*Note: See listing in Big Twin Section for custom length rear axles.



**1958-72 Round Rear Swingarm** features forged axle plates with round tube construction. Raw finish, replaces 47500-58B  
VT No. 51-0972

# Rebuild Kit



44-1973



44-1958

**1958-86 Big Twin Swingarm Pivot Kit** includes pin, spacers, seals, bearings, races and lock. VT No. 44-1995 includes 1" longer pin for stripped out frames.

VT No.	Year	Model
44-1958	1958-72	FL-FLH
44-1973	1973-85	FX-FL-FXWG-FXE-FXS
44-1995	1973-85	Includes Special Pin
44-1996	1958-85	Special Pin Only
44-1974	1985-86	FXWG-FXE-FXB



44-0102



44-0103

**Big Twin Swingarm Bearing Kit** includes tapered bearings, races, and seals for each application.

VT No.	Fits
44-0102	1958-72
44-0103	1973-85



44-0105



44-0106

**74 and 80 Swingarm Rebuild Kit** includes parts pictured for all 1958-84 Big Twin models.

VT No.	OEM	Years	Use
44-0105	—	1958-72	Bearings, Races and Seals
44-0106	—	1973-85	As Above
44-0425	—	1958-85	Bearings and Races
44-0100	47517-58	1958-84	Spacer (2)
17-0909	47513-58	1958-84	Lock Tab (10)
44-0101	47510-58	1958-84	Black Pivot Bolt
44-0099	47510-58	1958-84	Chrome Pivot Bolt
44-0405	9033	1958-84	Cup and Cone (1)
14-0138	47519-58	1958-72	Seals (5)
14-0139	47519-72	1973-84	Seals (5)
44-0406	—	1958-84	Bearing Only



**Swingarm Pivot Bolts.**

VT No. 44-1996 and 44-0082 are used to remedy a stripped out left side frame boss, VT No. 44-1996 is 1" longer on threaded end and VT No. 44-0082 is self tapping .025" oversize. All others are stock configuration.

VT No.	OEM	Finish	Year	Model
44-0101	47510-58	Black	1958-84	Big Twin
44-0099	47510-58	Chrome	1958-84	Big Twin
44-1996	1" Longer	Chrome	1958-84	Big Twin
44-0082	Self Tapping	Black	1958-84	Big Twin



**Swingarm Bearing Seals** are for FL-FX.

James	VT No.	OEM	Fits
14-0657	14-0138	47519-58	1958-72
14-0658	14-0139	47519-72	1973-84





# Frame Tabs, Mounts, Seat Tabs and Bars



**Rigid Big Twin Frame Repair Parts** to be welded on for restoration or repair.

VT No.	Item
27-1560	Footboard Tabs, Forged
27-0311	Footboard Tabs, Stamped
51-0503	5th Transmission Mount
51-0508	Side Car Loop Only
51-0528	Rear Axle Plates Right and Left Pair
51-0502	Right Front Brake Boss End, 2 Hole
51-0501	Left Front Shift Boss End, 3 Hole
51-0545	1948-54 Lower Tank Mount with cross plate
51-0644	1948-54 Lower Mount Tab Set
51-0632	1955-57 Lower Tank Mount without cross
51-0592	1948-54 Front Cable Tab
31-0475	Motor Mount Frame Spacer
51-0593	1948-53 Horn Bracket Strips Set
51-0573	Crossover Tube Only
51-0529	Front Oil Tank Mount
51-0522	Rear Motor and Front Transmission Mount 1936-57
51-0598	Saddles for Seat
49-1258	Tool Box Pad Set, Round, 5/16 x 24
49-1259	Tool Box Pad Set, Rectangular, 5/16 x 24
51-0503	5th Transmission Mount
51-0511	Rear Fender Mount
51-0510	Rear Fender Mounting Bracket
51-0512	Frame Anchor Mounting Tab
51-0481	Brake Cross Over Kit
51-0522	Cross Shaft Bracket Set



**Chrome Rigid Vibrator Bar** fits between side car loops on 1936-57 stock rigid frames.

VT No.	Item
49-2560	Bar Only
51-0667	Bar and Spools



**Weld-On Mount Tabs** fit Rigid Frames when mounting brake units.

VT No.	Type
51-0511	Hydraulic Rear Back Plate
51-0512	Caliper Arm Tab
51-0513	1987-99 Caliper Mount Strap (Right Side)
51-0845	1987-99 Caliper Mount Strap (Left Side)



**.036" Big Twin Engine Mount Shims** for front and rear 1936-99.  
VT No. 31-1306

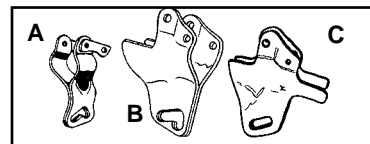

**Big Twin Top Engine Mounts** are two halves with seat tee and rear tank mounts incorporated into the top mount. Weld in place for accurate restoration.

VT No.	#	Fits
51-0584	A	1948-52 Panhead
51-0530	B	1953-69 Panhead-Shovelhead
51-0505	C	1970-84 Shovelhead



**Seat Post Top Yoke.**

VT No.	Year
51-0594	1936-47
51-0533	1948-57
51-0567	1958-84



**Big Twin Footboard Tabs**

available in stamped or authentic forged steel construction for custom or stock frames. Sold in pairs to be welded on 1936-84 models.



VT No.	#	Dia	Type
27-0664	A	1"	Forged Exact
27-1560	A	1 1/8"	Forged Exact
27-0311	B		Stamped Tabs



**Neck Lock Tab** to be welded on Big Twin neck for use with lower glide lower tree with tab.

VT No. 51-0517

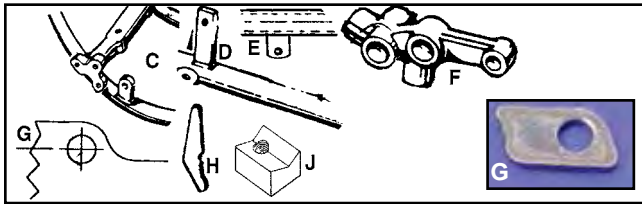

**Frame Repair Tabs** to weld on to repair stock frames.

VT No.	#	Fits	Type
51-0578	C	1958-84 FL	Brake Tee
51-0579	D	1958-84 FL	Rear Pipe
51-0570	F	1965-84 Big Twin	Upper Shock Mount, pair
51-0569		1958-64 Big Twin	Upper Shock Mount
51-0517	G	1969-up Big Twin	Neck Tab for Lock
51-0506	H	—	Gusset Plate
51-0599	I	—	5th Mount Transmission
51-0145		1936-57	Plate Set

**Coil Mount Block Set** has a with  $\frac{3}{8}$ " —24 UNF thread.

VT No.	Item
51-0532	Block Set
8824-8	Stud Set
8824-8T	Stud Set



**Lower Tank Mount** for 1955-84 FL.

VT No.	Item
51-0632	Welded Mount
51-0639	Cross Bracket
51-0666	Welded Set

**Weld In Lock Insert** is cast steel for 1936-84 frames.

VT No.	Item
51-0958	Casting
51-0349	Insert with lock



**Steel Skid Plates** replace 24490-36, 1936-99 Big Twin.

VT No	Finish
42-0101	Chrome
42-0098	Stainless
42-0777	Chrome
42-0117	Black
42-5025	Black, Replica

**Weld On Dowels** are tapped for  $\frac{5}{16}$ " — 24 UNF thread.

VT No. 51-0858

51-0431	45 Rear Fram Cross Brace
51-0437	Rear Forging Mount
51-0439	Front Forging Engine Mount
51-0459	Rear Frame Motor Mount
51-0527	Rear Frame Motor Mount, Front and Rear
51-0119	Rigid Frame Tube Set, 1948-53
51-0120	Rigid Frame Tube Set FL 1954-1957
51-0144	Raw rigid frame seat post plate set
51-0172	Lower Frame Front Motor Mount
51-0535	Triple Tree Neck Frame Tab
51-0551	Frame Coil Mount Weld-On Type
51-0618	Fat Bob Tank Mount Kit

# Frame Component



**Front Side Car Frame Loops** fit rigid frames for replacement and repair, will accept 1" diameter tubing, pair, front lower mount, each. Front engine mount is one piece forged with three holes on left and two holes on for brake side. Components must be welded on.

VT No.	Item
51-0523	Side Car Loop Set, Straight Leg, Right and Left
51-3157	Side Car Loops, Right and Left
51-0585	Side Car Loop Set, Wish Bone, Right and Left
51-3647	1936-47 Front Engine Mount
51-0595	1936-47 Front Engine Mount
51-0526	1948-84 Front Lower Mount
51-0500	Cast Side Car Mounts
51-0068	Casting Number Plate

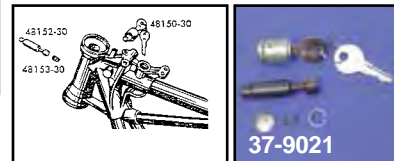

**Complete Steering Head Lock Assembly Kit** includes cylinder lock, two keys, pin, frame plug, spring and plunger.

VT No.	Item
37-9021	Complete Kit
51-0610	Trim Ring

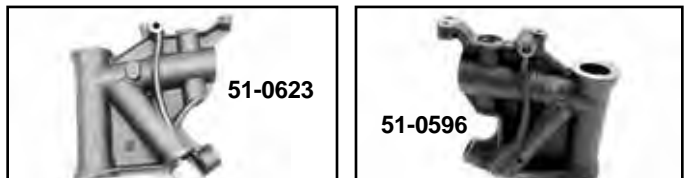

**Big Twin Neck Forgings** machined to accept stock diameter tubing. 51-0520 features late number boss and tab for pad lock.

VT No.	Year	Rake
51-0623	1936-40	28°
51-0596	1941-45	29°
51-0606	1946-E47	30°, Bull Neck
51-0525*	1948-68	30°
51-0520	1969-87	30°

\*Note: Machined to accept neck lock tumbler 37-9021.

**Top Frame Casting** fits 1948-65 Panhead.

VT No. 51-0067

**1936 Style Side Car Mount Set and Cross Bar.**

VT No. 49-1320





# Shock and Shock Cover



**Dura Shocks** feature nitrogen charge pump to fit 1973-84 Big Twins.

VT No.	Length	Type
54-0028	11"	Exposed
54-0029	12"	Exposed
54-0031	12"	Covered

All shocks are measured eyelet to center of eyelet.

**Shock Sets** for FL-FLH-FX-FXE except FXR-FLT.

VT No.	Style	Length	Year	Type
54-0112	Stock	12.0"	1973-85	Chrome Springs
54-0113	Stock	12.0"	1973-85	Full Covered
54-0108*	1" Shorter	11.0"	1973-85	Chrome Springs
54-0107*	1" Shorter	11.0"	1973-85	Full Covered

\*Note: Feature chrome body and springs, lower bike.

**FL-FLH-FX**

54-0110	54509-71A	13.5"	1958-72	Chrome Springs
54-0111	54500-67	13.5"	1958-72	Full Covered
28-0220	All			Rubber Bushing



**13.5" Shock Sets** fit 1958-72 Big Twins.

VT No.	Type
54-0027	Exposed
54-0030	Covered



**Chrome Shock Cover Set.** The 11" type fits Progressive shocks 54-2013 and 54-0061, and 12" type fits shocks 54-2004 and 54-0060, sold in pairs.

VT No.	Type
54-5028	11"
54-5029	12"

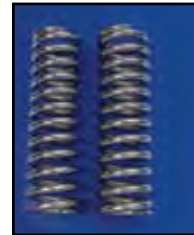

**Chrome Shock Springs** convert FL to FX style exposed chrome springs or to replace springs on FX models. Springs are stock tension. Sold in pairs.

VT No.	OEM	Lgth	Years
54-0150	54555-73	11.5"	1973-up FX-FL
54-0151	54570-67	13.5"	1967-72 FLH

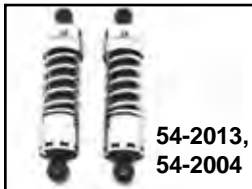

All shocks are measured eyelet to center of eyelet.



**Chrome Shock Covers** are a 1950's style top cover. They fit all models of swing arm with stock shocks including Electra Glide 1958-64, 1965-82 without saddlebag guards. Replaces 54704-52 and 54705-52.

VT No. 54-0154



**Chrome Shock Spring Covers.**

VT No. 54-0155 and 54-0157 fit V-Twin shock assemblies 1967 and later, with upper spring retainers. VT No. 54-0402 is replica type for shocks which disassemble at lower eye.

VT No.	OEM	Fits/Length
54-0155	54702-67	1967-72 FL-FX 9 1/2"
54-0402	54702-56	1956-66 XL and Big Twin Replica Type
54-0156	54702-73	1973-84 Big Twin

**Progressive Suspension 412 Series Chrome Shocks** are manufactured from the finest material available. Magnum 412 Series shocks are nitrogen charged with six-stage automatic damping and an adjustable spring preload. Available with chrome spring and end caps. Shock cartridge is not chrome. All shocks are measured eyelet to center of eyelet.

Year/Model	11.0"	12.0"	13.5"
1973-84 FLH-FX	54-2013 without cover	54-2004* without cover 54-0089* with cover	
1958-72 FL-FLH			54-0087* with cover

\*Note: Denotes stock length shock. When installing other than stock length shocks, tire to fender clearances must be checked.



**Shock Tool** for 1958-81 FL-FX scissor type. Replaces 94700-65.  
VT No. 16-0100

Mount Studs not included with shock sets.



**Shock Stud Conversion** allows use of shocks with 1/2" holes with steel inserts. Simply press out stock bushing and sleeve, replace with the 2-piece style. Fits the 5/8" diameter studs on many models. Use a 5/8" cup washer for final assembly. Set of 8 rubbers.

VT No.	Item
28-0133	Rubber Bushing
54-0418	5/8 Cup Washers, 10 pack



**Shock Bushings** fit 1958-84 Big Twin, pack of 10. Replaces OEM 85210-42A.

VT No.	Item
28-0220	Bushings
37-0431	Steel Sleeves



**Shock Stud Washer** 10 pack.

VT No.	OEM	Type	Finish
54-0418	54544-65	5/8" Hole Cup	Chrome
54-0419	54543-65	3/8" Hole Cup	Chrome
54-0420	54545-65	1/2" Hole Cup	Chrome
54-0421	6718	1/2" Hole x 1" Flat	Chrome
54-0424	6722B	5/8" Hole x 1.3" Flat	Zinc
54-0432	6415B	3/8" Hole x 1.25" Flat	Zinc



**Nyloc shock stud nut** is 5/8-18 UNC thread, replaces 7993.

VT No.	Finish	Qty
54-0422	Zinc	10
54-0447	Chrome	4

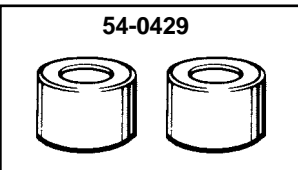

**Replacement Hardware** fits stock or aftermarket shocks 1967 later, top clip type.

VT No.	OEM	Item	U/M
54-0204	54558-73	Rotating Cam	Pair
54-0203	54559-73	Cam Sleeve	Pair
54-0205	54635-73	Spring Retainer	Pair
54-0429	54700-67	Upper Cover	Pair



**Stock Stud Spacers** replace 5960W on 1965-85 FLH when rear frame bars are not used. Zinc plated, pair.

VT No. 54-0425

# Shock Stud



**Shock Stud Kits** feature all pieces for upper and lower positions. Including washers, nuts and lockwashers as necessary. Studs and bolts are zinc plated. Outer nuts and washers are chrome.

VT No.	Year
54-0466	1958-64 *Note: with chrome studs.
54-0464	1958-64
54-0463	1965-66
54-0462	1967-72
54-0465	1973-84



**Rear Shock Studs**, with cup washers. Each kit includes two studs and four chrome plated cup washers. Cup washers and lock nuts may be purchased separately.

### Upper Pair

Chrome	Zinc	OEM	Fits
54-0445	54-0408	54515-58A	1958-64 FL 3/8" thread
—	54-0409	54515-65	1965-66 FL
54-0440	54-0410	54515-67	1967-72 FL-FX
54-0442	54-0416	54515-73	1973-84 FX

### Lower Pair

Chrome	Zinc	OEM	Fits
54-0446	54-0411	54517-58	1958-64 FL
—	54-0413	54517-65	1965-66 FL
54-0441	54-0412	54517-67	1967-72 FL-FX
—	54-0401	3958	1973-84 FL-FX





# Sissy Pad



**Mini Back Rest** in black features a stainless steel insert with chrome frame mounting system for short sissy bars.  
**VT No. 47-0753**

**Button Sissy Bar Pads** mount to square stock sissy bars, Mini fits 12" bar, 2 button fits 16" bar. Chrome mount clamps included, black only.

VT No.	Type
47-1963	Mini
47-1964	2-Button
47-1972	Smooth
47-0457	Buttoned
47-0478	Buttoned
31-1987	Brackets for Above

# Luggage Rack



**Chrome Luggage Rack** is fender mounted for loads of 10 pounds or less. Fits 1982-94 FXR and 1976-85 FXE. 9" x 6" in size. **VT No. 50-1019**



47-1974  
 Installed



50-1013 Installed



50-1013

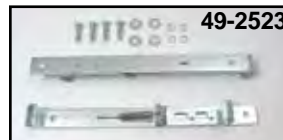

49-2523

**Three Channel Luggage Racks.** Classic style of the 1960's for FLH models for 1958-84 FLH.

VT No.	OEM	Item
50-1013	53403-58D	Luggage Rack
37-0545	90908-58	Strut Spacer

**Luggage Rack Pad** measures 12 $\frac{3}{4}$ " x 9" with quick release spring loaded clamps to fit 3-channel stock luggage racks.

VT No.	Item
47-1974	Pad Kit
49-2523	Clamps



**FXWG-FXST Luggage Rack** is for 1980-99 models and many Swing Arm frames fitted with a bobbed rear fender rack contours to fender curves.

**VT No. 50-1001**



49-0304



49-0951



49-0832



42-0532



42-0538

**Eagle Spirit Medallion** is 3 $\frac{1}{2}$ " for universal, and has an adhesive backing.

VT No.	Finish
42-0532	Chrome
42-0538	Gold Inlay

652



50-1563

**Old Style Luggage Rack** is a replica of 1940's accessory, contours all rear fenders 1934-up. Great for attaching thro-over saddlebags. Does not interfere with post mounted buddy or police solo seats.

**VT No. Finish**

49-0304	Polished
49-0951	Chrome Replica
49-0832	Black Replica
37-2096	Chrome Screw, 4 pack
50-1563	Black Strap

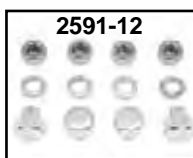

2591-12

49-2523 Clamps  
**Luggage Rack Mount Kit**  
**VT No. 2591-12**



# Sissy Bar

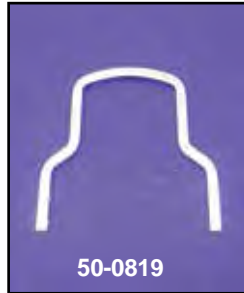

Fitment	12" Round Bar Upright w/Tilt Top	11" Square Bar Upright	10" Square Grab Rail	Upright Width
	Chrome	Chrome	Chrome	
1958-84 FL-FLH	50-0322	50-0815	50-0819	8 <sup>3</sup> / <sub>4</sub> "
1972-85 FX	50-0320	50-0817		8"
1982-94 FXR		50-0816		6 <sup>3</sup> / <sub>4</sub> "



Fitment	Side Straps	20" Square Bar Upright	16" Square Bar Upright	Upright Width
	Chrome	Chrome	Chrome	
1958-84 FL-FLH	50-0805	50-0462	50-0811	8 <sup>3</sup> / <sub>4</sub> "
1972-85 FX	50-0804	50-0813		8"
1982-94 FXR	50-0806	50-0812		6 <sup>3</sup> / <sub>4</sub> "



Fender Mount Sissy Bar Kit includes mount bracket and 8<sup>1</sup>/<sub>2</sub>" grab rail, measured from top of fender, with chrome finish. VT No. 50-0503

Sissy Bar Inserts mount with screws to cross bar.

VT No. Type

50-0820 Chrome Maltese

42-0045 Skull

42-0156 Live to Ride





# 2" Drag Pipe



**Radii Pipe Set** features full curve with 2" outside diameter and requires fabrication of brackets for mounting. Fits 1970-84 Shovelhead.

VT No. 30-0331

## Wyatt Gatling Down Draft Drag Pipes

Chrome	Black	O.D.	Fits
30-0721	30-0755	1 3/4"	1970-84 FX, FL
30-0725	30-0726	2"	1970-84 FX, FL

# 1 3/4" 1971-84 FX-FXE Exhaust

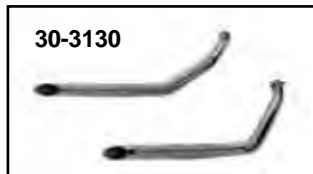
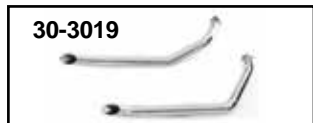
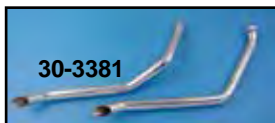

**Goose Style Drags.** Retro chopper styling in 1 3/4" diameter slash cut ends, and a length of 35" long. Use 31-2101 P-Clamps for mounting. Fits 1970-84 74 and 80 FXE.

VT No.	Brand
30-3130	Cycle Shack, 35" long
30-3381	Wyatt's
30-3019	VT
30-0770	Lake

**FX-FXE Model Muffler Pipes** feature 1 3/4" head pipe and true one-piece construction in chrome. Fits 1971-84 FX-FXE-FXS-FXB-FXEF-FXWG models except 1983-84 WG with both kick and electric starters, and both 74" and 80" engines Mount bracket included with muffler pipes only. Fits Shovelhead-type engine only.

VT No.	Style
30-3130	1 3/4" Goose Drags
30-3237*	Heat Shields for Drag Pipes Only
31-4050	Bracket, Black
31-4058	Bracket, Chrome



\*Note: Could fit muffler pipes if trimmed down



**Billet End Tips** fit 1 3/4" straight cut drags.

VT No.	Finish
30-0796	Chrome
30-0797	Black
30-0800	Black, taper



**Radii Drag Pipe Sets** with formed heatshields (as noted) are 1 3/4" slash cut style with a length of 38".

Chrome	Black	Year	Model	Shields
30-3001		1971-84	FXE	Yes
30-3017		1970-84	FXE	No
30-3101	30-3417	1970-84	FXE	No
	30-3418		Slash Cut Ends	
	30-3419		Slash Cut Ends	
	30-3420		Goose	
15-0450			Exhaust Port Stud, Nut and Gasket Kit	
15-0759			Copper Gasket only	



61-0178 Drag Pipe Set, 1970-84 FL

- 30-0823 HEAT SHIELD BOOT GUARD, PARKERIZED
- 30-0017 REAR CYLINDER HEADER PIPE, BLACK
- 30-0863 REPLICAY HEADER PIPE, 16-1/2", BLACK
- 30-0996 REPLICA MUFFLER CHROME
- 30-0486 BATIQUE FISHTAIL EXHAUST PIPE END, RAW



**Caution:** These exhaust products are not legal for sale or use in California on pollution controlled vehicles. These products are intended for non-highway only.



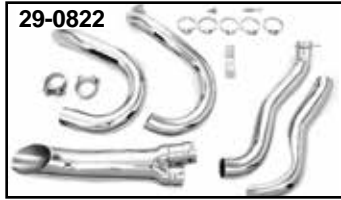

29-0822 Installed

2:1 Exhaust Headers for use forward controls. Fits 1970-84 Shovelheads.

VT No.	Finish
29-0822	Chrome
29-0824	Black



29-0094 Installed



30-0580

Chrome Knucklehead Upsweep Pipe Set includes front and rear upsweep pipe set for rigid frames. Front Pipe is two piece type. Use 1 3/4" extensions or mufflers.

VT No.	Type
29-0094	Upsweep
30-0580	Stacked Upsweep
31-9920	End Clamps
31-2101	P-Clamps



29-0094

## FXR 1982-83



FXR Exhaust Bracket Mounting Block fits 1982-86 FXR models. Sold as each. VT No. 28-0229



31-2116

T-Bolt Set is a replacement for all of our muffler pipes which have channel type mounting. Supplied with nut.

VT No.	U/M
31-2116	Pair
31-0223	10 pack



40-0094

Chrome Oil Tank fits 1982-94 FXR models. Includes mounting hardware and hose. Replaces 62406-81. VT No. 40-0094



31-0189



31-0188

FXR Exhaust Pipe Brackets, zinc plated.

VT No.	OEM	Type
31-0189	65670-82	Front
31-0188	65671-82	Rear



Cast Inner Primary. Fits 1990-1993 FXR. VT No. 43-0233



Caution: These exhaust products are not legal for sale or use in California on pollution controlled vehicles. These products are intended for non-highway only.

## Upsweep Exhaust



29-0090 Installed

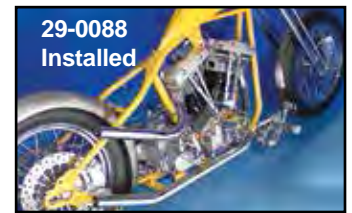

29-0088 Installed

Up Sweep Header Sets with brackets will accept straight fishtail extensions or mufflers which must be purchased and mounted separately.

VT No.	Model	Year	Note/Frame
29-0092	Panhead	1948-57	#1 Rigid
29-0093	Panhead	1958-65	#1 Swing Arm
29-0091	Early Shovelhead	1966-69	#4 Swing Arm
29-0090	Early Shovelhead	1966-69	#1-2-3 Rigid
29-0088	Shovelhead	1970-84	#2 Rigid
29-0085	Shovelhead	1970-84	#4 Swing Arm

1. Features 'S' type front pipe for better ground clearance. Three piece system.
2. Will not fit with electric start wrap around oil tank.
3. To be used with hydraulic brakes only.
4. Can only be used with FXE type Battery Box

## Shot Gun Drag Pipe



30-3164

Shot Gun Exhaust Systems fit Rigid or FXST-FLST frames only. Will not fit frame with shocks unless noted. Available as a drag pipe with slash cut ends or with tapered muffler. Pipes have 1 3/4"

outside diameter unless noted. Drag pipe lengths are noted.

Tapered	Drag	Length	Fits
29-0103	30-3158	40"	1970-84 Shovelhead Kickstart only
—	30-3155	40"	1966-69 Shovelhead
—	30-3210*	40"	1970-84 FX-FXE
—	30-0357**	34"	1966-84 FX-FL
—	30-3164	40"	1966-84 FX-FL

\*Note: 40" Pipe Set clears shocks and FXE Battery. Designed for swing out kick arm VT No. 17-0307.

\*\*Note: 34" pipe is header set. No slash cut.

\*\*\*Note: 2" outside diameter.



30-3205 Installed



30-3153

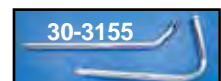

30-3155

Shot Gun Drag Pipe Sets for Rigid or Swing Arm models as noted. Bracket not supplied. Note type of front pipe. Outside is a 2 piece set, flat pipe type is three piece set.

VT No.	Model	F Pipe	Frame
30-3153	Knucklehead	Flat	Rigid
30-3150	Panhead	Outside	Rigid
30-3163	Panhead	Flat	Rigid
30-3205**	Panhead	Flat	Rigid
30-3149	Panhead	Flat	Swing Arm
30-3164	Shovelhead	Flat	Rigid
30-3155	Shovelhead	Outside	Rigid

\*Note: Fits STD heads.

\*\*Note: Side by side shorty







# 2 into 1 Exhaust

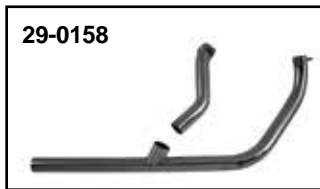

**Stock Type 2 into 1 Exhaust.** Single type for 1970-84 FLH fits Shovelheads when the front pipe is inside front frame tubes.

VT No.	Type	Year	Shield Set
29-0146	Chrome, K & E	1970-84 FL	30-0333
29-1160	Chrome, K & E	1970-84 FL with Heat shields	
29-0147	Black, K & E	1970-84 FL	
29-0158	Chrome, Electric Only	1970-84 FL-FLH	30-0333
29-1155	Chrome	1980-84 FLT	30-0308

**Chrome Crossover Exhaust Pipe** for Big Twin models with crossovers. To fit stock systems only. Replaces 65494-70. VT No. 30-0226



**Megaphone Widow Trust Muffler Set** available in chrome or black finish and has an overall length of 15". Includes 1 7/8" end clamp and 6" mounting strap. Megaphone end is 3 3/4" in diameter. Straight thru pipe with no baffle. Fits over 1 3/4" pipes that have 1 7/8" outer diameter.

**Chrome Black**  
30-1025 30-1026



**Caution:** These exhaust products are not legal for sale or use in California on pollution controlled vehicles. These products are intended for non-highway only.

# 1970-84 FLH Dual Crossover System



Right Side

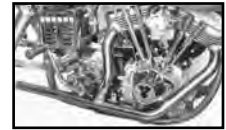

Left Side

**Chrome Dual Pipe Crossover System less Mufflers** features intersection of left side cross over at rear pipe, 1 3/4" outside diameter. Fits 1970-84 Shovelhead. Order heat shields and mufflers separately. Pipes are for kick and electric. VT No. 29-1101



**Rocket Fishtail Kit** for FLH includes two cigar mufflers and three tip fishtail tips. VT No. 30-0872



**Rocket Fin Set** with 3-fins OE style cigar mufflers 1950-65. VT No. 30-0955



**Chrome Megaphone Tip.**

VT No.	Fits Over	Length	U/M
30-0949	1 7/8"	24"	Each
30-0734	1 3/4"	25"	Each
30-0844	1 3/4"	30"	Each



**Chrome Megaphone** sold as a pair.  
30-0024 1 3/4" 30" Pair  
30-0984 1 7/8" 15.25" Pair





# 1970-84 Dual Exhaust

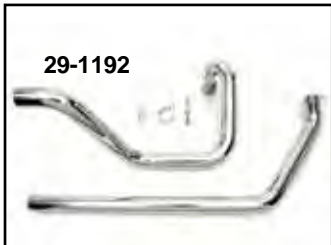
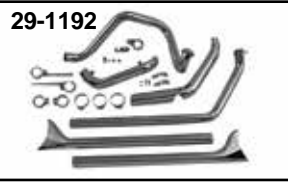

**True Dual Chrome Exhaust Systems** feature a single pipe for each side. Each pipe is independent. Rear pipe is for the left and front pipe is for the right without intersection. 1 3/4" outside diameter. Order heat shield set separately. Does not include hardware. Uses 1 3/4" slip on mufflers.

VT No.	Fits
29-1165	1970-84 Shovelhead FLH
29-1192	1970-84 Shovelhead FLH with fishtail kit

**Shield Set**  
30-0292



**Two Piece Heat Shield Set** fits 29-1165 for 1970-84 FLH.  
VT No. 30-0292



**Chrome Super Muffler Clamp Set** attaches muffler to 1 3/4" header pipe.  
VT No. 31-1007



**Dual Exhaust Pipe Clamp Kits** are for FLH models. Order pipe support separately for 1958-84.

VT No.	Year	Item
31-0706	1958-65	Clamp Set
31-0707	1966-69	Clamp Set
31-0708	1970-84	Clamp Set
31-2117	Right Side	Support
31-2118	Left Side	Support



**High Temperature Exhaust Wrap** reduce radiated exhaust heat. Wrap that will withstand up to 2000 degrees. Tie wraps sold available separately.

VT No.	Size	Item
48-0125	14"	Stainless Tie Wraps, 4 pack
48-0157		Stainless Wraps, 10 pack
48-0126	25' x 2"	Black Wrap
48-0127	25' x 2"	Tan Wrap
48-0131	25' x 1.5mm	White Wrap
48-0132	25' x 1.5mm	Black Wrap
48-0137	25' x 2	Brown Wrap
48-0139	25' x 2	Copper Wrap



**Footboard Mount Kit** fits 1970-84 FLH with drag pipes.  
VT No. 27-0599



**Footboard Bracket** must be used to replace the right side factory floorboard mount if you want to retain footboards on a 1970-84 FLH when using a drag pipe.

VT No. 31-0098



**Caution:** These exhaust products are not legal for sale or use in California on pollution controlled vehicles. These products are intended for non-highway only.







# Knucklehead Exhaust

29-1116



29-1115



**Batique Pipe End** fits over exhaust tube as noted. Sold each.

<b>VT No.</b>	<b>OD</b>
30-0793	1 3/4", Chrome
30-1376	1 3/4", Black
30-1393	1 7/8", Chrome



29-1115 Installed

1936-47 Knucklehead Two Into One Exhaust are designed to replace stock style 1 3/4" outside diameter pipe systems.

**Replica 3 Pc Finish**

29-1116 29-0182 Chrome

29-1115 29-0181 Black



**Replacement Muffler With Built-In Y-Pipe.** Replaces 65201-37. Used on 1936-40 Knuckle, 1936-40 UL.

<b>VT No.</b>	<b>Type</b>
30-0995	Black, Replica
30-0165	Black
30-0166	Chrome
30-0438	Black Tip

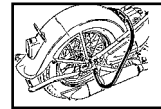

1936-47 Knucklehead Exhaust Pipes. Flat connector pipe features exact riveted construction as original. Y-Pipe features factory style saddle.

<b>Chrome</b>	<b>Black</b>	<b>OEM</b>	<b>Type</b>
30-0177	30-0261	65440-36	Front
30-0176	—	65493-36	Rear
30-0746	30-0981	65465-36	Flat
30-0199	30-0200	65505-41	Y-Pipe
—	30-0981	65465-36	Flat
<b>Replica Type</b>			
30-0762	—	65440-36	Front
30-0748	30-0747	65493-36	Rear
30-0746	30-0981	65465-36	Flat
30-0864	30-0975	65505-41	Y-Pipe

**Note:** Three and four Piece Replica Exhaust Systems require hand fitting during final assembly. We suggest to loosen motor mount bolts during installation to allow pipes to adjust to motor position then re-tighten engine bolts.



**Rear Hanger Reinforcement Clip** braces rear muffler clamp at mount bolt. Body clamp not included.

<b>VT No.</b>	<b>Finish</b>	<b>Year/Model</b>
49-2577	Black	1930-36 UL
49-2578	Black	1936 EL, 1937-40 UL
49-2591	Chrome	1936 EL, 1937-40 UL
49-2579	Black	1941-47 FL
49-2592	Chrome	1941-47 FL

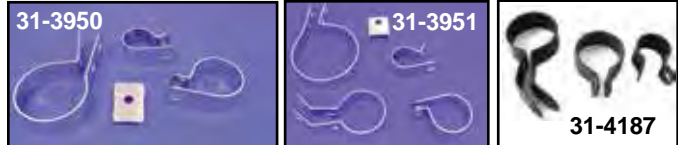
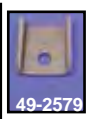
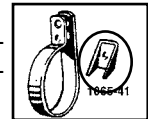

**Exhaust Pipe Clamp Sets** complete in black or chrome for single exhaust. Number of clamps in each kit shown.

<b>Chrome</b>	<b>Black</b>	<b>Year</b>	<b>Model</b>	<b>Clamps</b>
31-3950	31-2125	1936-1940	Knucklehead	3
31-3951	31-2126	1941-1947	Knucklehead	4
31-2930	31-4187	1941-1947	Knucklehead	3
2772-22	2719-22	1936-57	Bolt Set	

**Rear Clamp Kit** with reinforcement clip for 1941-57 BT.

<b>VT No.</b>	<b>Finish</b>	<b>VT No.</b>	<b>Finish</b>
31-1264	Parkerized	31-4084	Chrome Set
31-1269	Stainless	31-4085	Parkerized Set
31-1295	Parkerized	31-9009	Parkerized Set
31-1297	Chrome		

**Chrome Knucklehead Drags** fit 1936-47 models 61 and 74", 1 3/4" inner diameter.

<b>VT No.</b>	<b>Item</b>
30-3120	Pipes
31-2101	P-Clamps



**Clamps Not Included With Header Sets.**



**Watch Our Video!**  
<http://www.youtube.com/user/TeddCycle?feature=watch>



**Caution:** These exhaust products are not legal for sale or use in California on pollution controlled vehicles. These products are intended for non-highway only.





# True Dual Exhaust 1948-69



**True Dual Chrome Exhaust Systems** by Paughco, feature a single pipe for each side. Each pipe is independent. Rear pipe for the left side and front pipe for the right side without intersection. Panhead styles fit with or without mousetrap. The pipes have 1 3/4" outside diameter. Order heat shield set separately. Does not include hardware. Use 1 3/4" slip on mufflers.

### Crossover Kits.

VT No.	Fits	Shield Set
29-1106	1948-64 Panhead	30-0376
29-1107	1965 only Panhead	—
29-1108	1966-69 Shovelhead	—

**Note:** Three and Four Piece Replica Exhaust Systems require hand fitting during final assembly. We suggest to loosen the motor mount bolts during installation to allow pipes to adjust to motor position then re-tighten engine bolts.

## Dual Pipe Crossover System 1948-69



**Dual Pipe Cross Over Systems** less mufflers, chrome. Feature intersection of left side cross over at rear pipe, 1 3/4" outside diameter.

VT No.	Year/Model	Shield Set
	1949-57 Panhead, Rigid Mechanical with Mousetrap	30-0302
29-1100	1958-64 Panhead with Mousetrap	30-0301
29-1164	1965 only Panhead with Mousetrap Kick and Electric	—
29-1188	As Above Replica	—
29-1102	1966-69 Shovelhead, four piece Kick and Electric	—
29-1189	As Above Replica	—

**Dual Exhaust Pipe Clamp Kits** for FLH. Order pipe support separately for 1958-84.

VT No.	Year	VT No.	Year
31-0706	1958-65	31-2117	Right Side Support
31-0707	1966-69	31-2118	Left Side Support
31-0926	1958-69	31-2117	Right



**Rear Cross Over Pipe Clamp** bolts to rear cylinder base, each.

VT No.	OEM	Fits	Finish
31-3946	65510-54	1954-61	Cadmium
31-0474	65510-61	1962-64	Chrome
31-4189	Paughco	1954-61	Chrome

## 1948-84 Exhaust Component



**Rear Heat Shields** by Paughco.

Rear	Fits	Rear	Fits
30-0128	29-1165	30-0130	29-1100
30-0128	29-1108	30-0130	29-1101
30-0128	29-1107	30-0130	29-1102
30-0129	29-1106	30-0130	29-1164



**Chrome Rear Exhaust Pipes** are for Big Twin models with crossovers. To fit stock systems only.

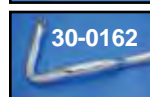

VT No.	OEM	Years
30-0225	65494-61	1958-64
30-0162	65494-65	1965-69



**Front Cylinder Header Pipe.**

VT No.	OEM	Years
30-0547	Replica	1948-65 Chrome
30-0562	Replica	1948-65 Black

**Chrome Rear Exhaust Pipe** for Big Twin with crossovers. To fit stock systems only. Fits 1958-65 Panhead, replaces 65496-61. **VT No. 30-0222**

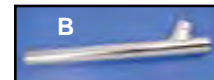

**1958-84 Stock Exhaust Connector Flat & Y Pipes** are stock replacement type.

Chrome	Black	#	OEM	Years	Type
30-0746			Replica	1936-64	Flat
30-0864	30-0898		Replica	1936-57	Y
30-0199	30-0200	B	65505-41	1936-57	Y
30-0745			Replica	1958-64	Y
30-0201	30-0202	B	65505-58	1958-64	Y
30-0225					Crossover
30-0194		C	65538-65	1965-69	Combo

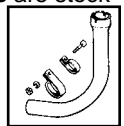

**Front Pipe to Frame Clamps** for 1936-69. Set includes 65512-37A pipe clamp and 65513-58 to frame for secure installation.

VT No.	Item
31-0229	31-3989 Set, Parkerized
	31-0229 Set, Chrome
	31-3988 Frame Clamp Only, Black
	31-0926 Front Clamp Only, Parkerized



**Cylinder Pipe** for use with single exhaust.  
**Chrome Black Year**  
 30-0173 30-0259 1948-65  
 30-0561 30-0749 1948-65



**Caution:** These exhaust products are not legal for sale or use in California on pollution controlled vehicles. These products are intended for non-highway only.







# Panhead Clamp



## 1948-65 Panhead Exhaust Clamps.

VT No.	Item	Finish	Type
31-2113	Allen Type	Chrome	Allen
31-0265	As Above, two piece type	Chrome	Allen
31-3960	Extra wide	Chrome	Allen
31-4039	Allen Type	Chrome	Allen
31-2111	Stainless Type	Stainless	Hex Nut
31-0225	Replica 1948-64	Stainless	Hex Bolt
31-0834	Replica 1948-53	Stainless	Hex Bolt
31-4056	Replica 1965 Only	Zinc	Allen



**Replica Finned Exhaust Clamp**  
fits Panhead 1948-65. Replacing  
factory accessory 65519-48.  
VT No. 31-0425

# 1966-69 Shovelhead Exhaust

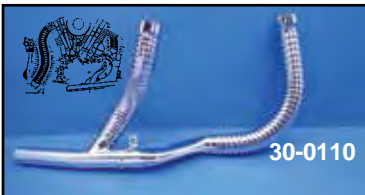

**Chrome Flex Exhaust Covers** for all Big Twin 74 and 80, 1 1/4". Slides on.

VT No.	Type
30-0110	MCM
30-0311	Replica



**Two Into One Exhaust** for rigid or swing arm frames on 1966-69. It is a three piece set incorporating the Y-flat pipe combination. Chrome  
VT No. 29-0152



VALS GATE, NY.  
(914) 562-5138

Since 1968



**Clamp Set** for 2:1 single exhaust available as listed. Exhaust sold separately.

## Chrome Parkerized Stainless Year

31-9002	31-9005	31-2143	1958-69
31-0229*	31-3989	—	1936-69 FL, EL two piece

\*Note: Front Clamp Set

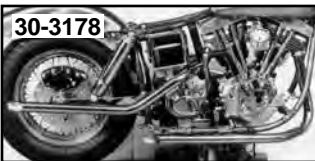

**30-3178** with over the transmission rear pipe fits kick start only in Rigid or Swingarm frame

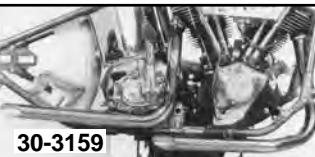

**1966-69 Big Twin Drag Pipes** available to fit either mechanical or hydraulic brakes or with over the trans rear pipe that will work with electric start applications.

VT No.	Type	Brand
30-3159	Mechanical and Hydraulic	Paughco
30-3178	Over Trans	Paughco

\*Note: Turn Out Ends.

**Note:** Three and four Piece Replica Exhaust Systems require hand fitting during final assembly. We suggest to loosen motor mount bolts during installation to allow pipes to adjust to motor position then re-tighten engine bolts.



## 1966-69 Pipes

VT No.	Type
30-0194	Combo Y
30-0160	Rear, 65493-66, 1966-69 FL
30-0998	As Above, Black
30-0983	Rear, 65493-66, 1966-69 FLH
30-0157	Rear Dual
30-0159	Front 65443-66
30-0162	Crossover



**Caution:** These exhaust products are not legal for sale or use in California on pollution controlled vehicles. These products are intended for non-highway only.





# 1948-65 Panhead Exhaust



**Chrome Flex Exhaust Covers** for all Big Twin 1936-69, 1 3/4". Slides on.  
**VT No. Type**  
**30-0110 MCM**  
**30-0311 Replica**



29-0178 Installed



31-4187

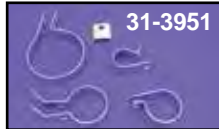

31-3951



31-2126



31-2127

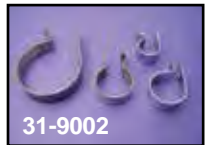

31-9002



31-9005



31-2143



31-0225



31-0229



31-1264



31-1269



31-1271



31-0031

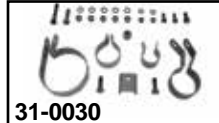

31-0030



31-0069

**Clamp Set** for 2:1 Single Exhaust available as listed. Order exhaust separately, order header clamps in stainless, VT No. 31-0225 in stainless to complete set.

Chrome	Parkerized	Stainless	Year
—	31-4187	—	1941-57 (3 Piece)
31-3951	31-2126	—	1941-57 OHV
—	—	31-2127	1950-57
31-9002	31-9005	31-2143	1958-69
—	—	31-0225	1948-65
31-0229*	31-3989*	—	1936-69 FL, EL 2-piece
—	31-1264	31-1269	1950-57 Rear
—	—	31-1271	1941-57 End
2772-22	2719-22	—	1941-57
31-0031	31-0030	31-0069	1941-57

\*Note: Front Clamp Set

## 1941-49 Muffler



30-0880

The 30-0880 & 30-0884 have the original seam type construction.



30-0880

**FL Stock Replacement Muffler** replaces 65251-41. Fits all 1941-49 FL, EL, UL.



30-0164

**VT No. Finish**  
**30-0163** Black  
**30-0164** Chrome  
**30-0880** Black, Replica  
**30-0884** Chrome, Replica



29-0823

**Two Into One Exhaust** designed to replace stock style with 1 3/4" outside diameter pipe systems. Fit rigid or swing arm frames. Systems are four piece construction. 1965 only are original three piece design.

VT No.	Years	Finish/Fits
29-0173*	1948-57	Chrome
29-0174*	1958-64	Chrome
29-0178*	1948-57	Black
29-0154	1965	Pan, Chrome
29-0155	1965	Pan, Black
29-0823	1958-64	Black, 4 Piece Set

\*Note: Features replica style saddle Y and riveted flat pipe.



30-0975 Best Made!



30-0746



30-0981

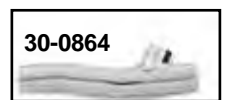

30-0864



30-0200



30-0975



30-0547

**Replica Header Pipes.**

Chrome	Black	Type	Year
30-0746	30-0981	Flat	1948-64
30-0864	30-0200	Y	1948-57
—	30-0975	Y	1948-57
—	30-0898	—	1948-57 (1.2mm thick)

Front	Rear	Finish
30-0547	30-0561	Chrome
30-0562	30-0749	Black



30-0562

## Drag Pipe



30-2128

**Drag Pipes** have less ground clearance than original equipment. Requires the use of P-Clamps. **Notice: To avoid scraping, do not use unless front fork is stretched at least 4" longer than stock.**

VT No.	Style
30-3128	1 3/4" Goose Drag
31-4055	Bracket



**Caution:** These exhaust products are not legal for sale or use in California on pollution controlled vehicles. These products are intended for non-highway only.







# Cigar Muffler

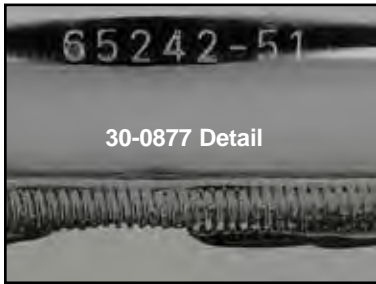

Muffler/Trumpet Set for 1958-84 FLH.

VT No.	Type
30-0564	Dual
30-0441	Single

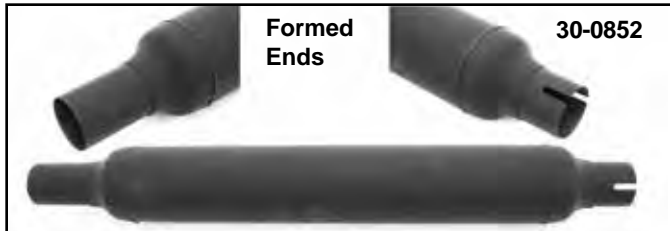
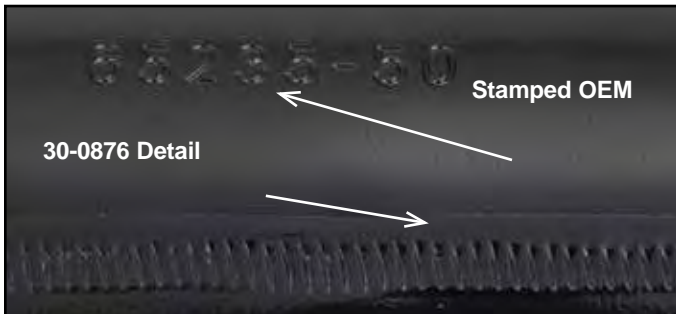

30-0877, 30-0876, 30-0398 feature original seam type construction. Cigar Mufflers replace 1950-66 FL-FLH, 1 1/4" inlet, 3 1/4" body diameter. Kit includes two mufflers and clamps. \*Note: Not seam-less.

VT No.	OEM	Fits	Length	Brand
30-0877*	Chrome	1950-57	24"	Replica
30-0876*	Black	1950-57	24"	Replica
30-0143	65235-50	1950-57	24"	V-Twin
30-0852	Black	1950-57	24"	V-Twin
30-3189	Chrome	Kit		Pair
30-0189	65235-50	1950-57	24"	DCC
30-0339	65235-50	1950-57	24"	Black
30-0220	65236-58	1958-66	22"	DCC
30-0282	65236-58	1958-66	22"	V-Twin
30-0398*	65236-58	1958-66	22"	Replica



Caution: These exhaust products are not legal for sale or use in California on pollution controlled vehicles. These products are intended for non-highway only.





# Replica Muffler



30-0141

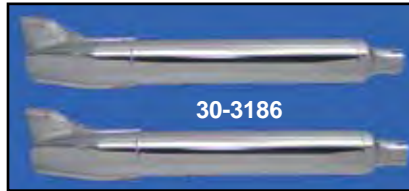

30-3186

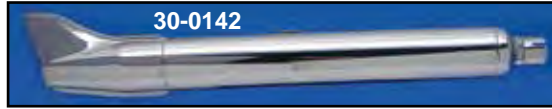

30-0142



30-0218



30-3187

V-Twin™ Replica Chrome Seamless Muffler features classic fishtail or turnout ends with factory duplicated stock seams and welding for restoration or nostalgic looks with a 3/4" outside diameter. All fit 1 1/4" inlet, single and dual applications. Pairs include two mufflers and four clamps.

VT No.	Length	Type	U/M
30-0141	26 3/4"	Fishtail	Each
30-3186	26 3/4"	Fishtail	Pair
30-0142	33"	Fishtail	Each
30-0218	28"	Turnout	Each
30-3187	28"	Turnout	Pair

Note: VT No. 30-0141 stock FLH 1958-66, VT No. 30-0218 stock on 1967-69, VT No. 30-0142 clears saddlebags.



30-0817



30-0818

Straight Fishtail Muffler with scalloped fishtail tip.

Chrome Black Length  
30-0817 30-0818 32"



30-0142



30-0218

1970-84 FLH Replica Mufflers

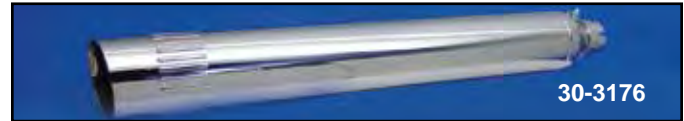

30-3176



30-0346

1970-84 FLH Replica Chrome Mufflers. Kit include two mufflers and four clamps. \*Note: Not seamless.

VT No.	Item	U/M	Measurements
30-3176	Muffler	Each	28" long
30-3188	Muffler Kit	Pair	
30-0346*	Muffler	Each	27 1/2" long, 3 1/2" outside diameter

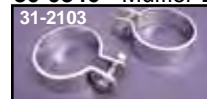

31-2103

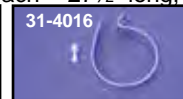

31-4016



31-2109

31-4016	65293-58	3/4"	Stainless Clamp	Each
31-2103	End Clamp	1 7/8"	Chrome	Pair
31-2109	Body Clamp	3/4"	Chrome	Pair



31-2117



31-2118

Black FL Muffler Support Tubes use on 1958-84 FL. Replaces 65318-58A right side and 65318-59B left side.

VT No.	Side
31-2117	Right
31-2118	Left



31-4016



31-2109

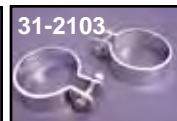

31-2103



31-2144

3/4" Stainless Clamp replaces 65293-58, fits cigar and other stock dimension mufflers, sold each.

VT No. 31-4016 Polished

Inlet and Body Clamps for mufflers on this page.

VT No.	Type
31-2109	3/4" Body, pair
31-2103	End Clamps, pair
31-2144	End Clamps, Heavy



Chrome 30" Straight Pipe Extension is 1/8" inside diameter to fit over 1 1/4" pipes and allows extension to slide over to desired length. Pair.

VT No. 30-0314



Caution: These exhaust products are not legal for sale or use in California on pollution controlled vehicles. These products are intended for non-highway only.







# Fishtail Exhaust



**V-Twin Mfg.™**  
**Fishtail Kits** include two (2) fishtails, two (2) inlet and two (2) body clamps. Pipes are 1 3/4" inside diameter the full length to fit over drag or dual

exhaust systems. Fishtails do not include baffles.

VT No.	Length
30-3165	30"
30-0137	36"

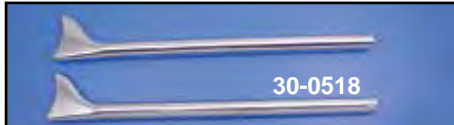
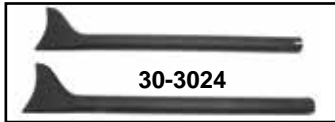

**Fishtail Straight Pipes** fit over 1 3/4" pipes. Sold each except where noted. Order clamps separately. Available in chrome or black finish.

Chrome	Black	Item	U/M
30-0138	—	18" Fishtail	Each
30-0945	—	18" Fishtail	Set
30-0139	—	30" Fishtail	Each
30-0948	30-3024	30" Fishtail	Set
30-0781	—	33" Fishtail	Set
30-0893	—	30" Fishtail	Set
30-0136	—	36" Fishtail	Each
30-0518	30-3025	36" Fishtail	Set
30-3049	30-3052	36" Fishtail (Indian)	Set
31-2105	—	1 7/8" Hanger Clamps	Set
31-2101	—	1 3/4" Hanger Clamps	Set
31-2103	—	1 7/8" End Clamps	Set

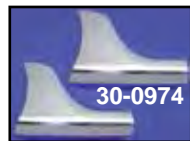

**30-0974 Shown on Knucklehead Bobber**  
**Chrome Classic Fishtail Tips** slip over the outlet of the muffler or straight pipe. Tip measures 7 1/8" long and 5 5/8" high. Sold as pair.

VT No.	I.D.	30-3422	1 7/8"
30-0974	1 7/8"		
30-3421	1 3/4"		



**Chrome Tapered Fishtail Muffler** features 1 3/4" inlet. Use 2 1/2" body clamps for mounting which are sold separately.

VT No.	Item	U/M
30-0253	Muffler 27" Long	Each
30-0264	As Above	Pair
30-0254	Muffler 31" Long	Each
30-0369	Muffler Set, 31"	Set
31-2106	Body Clamps, 2 1/2"	Pair
31-2103	Inlet Clamps, pair	



**Chrome Flash Gordon Fishtail Muffler** with 2.5" diameter to fit 1 3/4" pipes. Sold each.

VT No.	Item	Length
30-0140	Muffler	31.5"
30-0399	Muffler	24"
31-2106	Body Clamp	



**A-Chrome Fishtail Style Mufflers** are 2 7/8" diameter, with steel baffle core. Inlet end fits 1 3/4" OD pipes. Order clamps separately.

VT No.	Type	30-0152	36", each
30-0151	30", each	31-2103	1 7/8" end clamp
30-3185	30" Set includes 31-2099 clamp		
31-2099	2 7/8" Body Clamp		

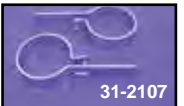

Order muffler clamps separately.

VT No.	Type	Size	Type
31-2107	Body	2 3/4"	Standard
31-2103	Inlet	1 7/8"	Standard
31-2144	Inlet	1 7/8"	Heavy



**Chrome Muffler End Clamp** fits slip on mufflers. VT No. 31-1007



**Caution:** These exhaust products are not legal for sale or use in California on pollution controlled vehicles. These products are intended for non-highway only.





# Universal Muffler

Universal Mufflers fit over 1 3/4" pipes and use clamps for mounting. All clamps available separately.

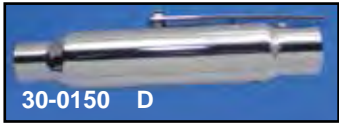
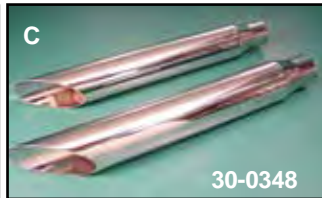

**Turnout Muffler Set** has 1 3/4" inner diameter inlet. Order clamps separate. Channel type mounting features concealed track on back. 20" long and 2 1/2" body diameter.

**VT No. U/M**  
**30-0625** Pair  
**30-0146** Each

**2:1 Collector** has 1 3/4" inlet 3" diameter, 29" long, fits most parallel exit pipes. End may be rotated to position.

**VT No. Type**  
**30-0207** Turnout  
**30-1563** Slash End  
**VT No. Type Length**  
**30-0207** Turnout 29"  
**30-1563** Slash 21"

**Slip On Chrome Mufflers** steel baffled with 1 3/4" inlet.

VT No.	Type	Length	Dia.	Mt	Type	U/M	Removable Baffle
30-0149	A-Slash	16"	2 1/2"	Stud	Each	No	No
30-0148	B-Tapered	16 1/2"	2 1/4"	Channel	Pair	No	No
30-0641	B-Tapered, Black	16 1/2"	1 3/4"		Pair		
30-0642	B-Tapered, Chrome	16 1/2"	1 3/4"		Pair		
30-0147	C-Baloney Slice	16 1/2"	2 1/2"	Stud	Each	Yes	Yes
30-0348	C-Baloney Slice	16 1/2"	2 1/2"	Channel	Pair	Yes	Yes
30-0150*	D-Shorty	12"	2 1/4"	Stud	Each	Yes	Yes
30-0067	Trumpet				Each	Yes	Yes
30-0871	Vape				Each		
30-0296	E-Megaphone	20"			Each	Yes	Yes
30-0794	Megaphone	20"			Pair	Yes	Yes
30-0827	Megaphone				Pair		
30-0848	Megaphone Upsweep				Pair		
30-2105	F-Megaphone Upsweep			Channel	Pair	Yes	Yes
30-2167	Megaphone Upsweep			W/Flap		Yes	Yes
30-1375	G-Megaphone Upsweep			Stud	Pair	Yes	Yes

\*Note: Fits 1 3/4" or 1 1/2" diameter.

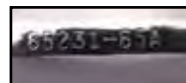
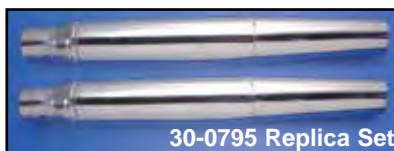

**Replica Tapered Muffler Set** replaces 65231-65A with 1 3/4" inlet.

**VT No. 30-0795**



**Caution:** These exhaust products are not legal for sale or use in California on pollution controlled vehicles. These products are intended for non-highway only.

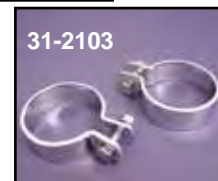

**Chrome Turn Out Mufflers** have a 3" diameter body, 1 3/4" inner diameter inlet, 30" or 36" overall length. Order clamps separately. Great for single or dual exhaust use on FLH models. Will not fit 1985-94 FLT models. 30-0190 has mount track on back.

**VT No. Size U/M**  
**30-0190** 30" Pair  
**30-0191** 36" Each  
**30-0382** 36" Pair  
**31-2108** 3" Body Clamp Pair  
**31-2103** 1 7/8" End Clamp Pair  
**31-1007** 1 7/8" End Clamp Pair



**Upsweep Muffler** is 31" long with upsweep tail.

**VT No. U/M**  
**30-3391** Each  
**30-0565** Pair

CLASSIC







# Heat Shield



1970-84 FLH 3 Piece Chrome Heat shield Set for 2:1 exhaust system. VT No. 30-0333

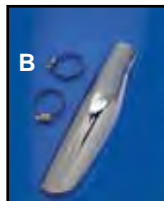

Chrome Heat Shields fit 1970-84 FLH models, not FLT. Worm clamps included.

- | VT No.   | # | Item           |
|----------|---|----------------|
| 30-0111  | A | Front 26"      |
| 30-0287  | A | Front 24"      |
| 30-0112  | B | Rear           |
| 30-0288  | B | Rear           |
| 30-0130  |   | Rear           |
| 30-0208  | C | Lower Y, 8"    |
| 30-3239* | D | Lower Y, 10"   |
| 30-1562  |   | Lower Y, 14"   |
| 30-0211  | E | Left, Top      |
| 30-3220  | F | Left, Vertical |



\*Note: Notch for rear pipe fits other 2:1 FL style headers.



Chrome Replica 'Spoon' Heat Shield.

- | VT No.  | Type              |
|---------|-------------------|
| 30-0429 | 5 1/2" with holes |
| 30-0221 | 5 1/2"            |
| 30-0834 | 5 1/2" OE type    |
| 2577-1  | 5 1/2"            |
| 30-0865 | 4"                |
| 30-0245 | 9"                |
| 30-0465 | 5 1/2" SS         |



Universal Straight Heat Shields are available for 1 3/4" or 2 1/4" pipes. Includes mounting clamps. Sold individually.

For 2 1/4" Pipes

- |         |     |
|---------|-----|
| 30-0120 | 4"  |
| 30-0121 | 10" |

For 1 3/4" Pipes

- |         |     |
|---------|-----|
| 30-0122 | 10" |
| 30-0123 | 12" |
| 30-0124 | 18" |



Left Side Cross Over Heat Shield fits 1948-64 Paugcho left side pipe and stock 1961-64 cross over.

VT No. 30-0083



1970-84 FLH Heat Shield Set includes 5 pieces, 2 for the left and 3 for the right side to fit dual cross over systems. VT No. 30-0350

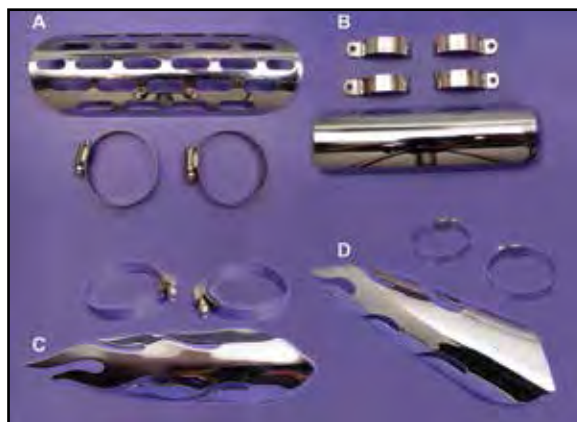

VT No. 30-0118 Installed



Universal Heat Shields include clamps for installation.

- | VT No.  | # | Type       | Dia.   | Length |
|---------|---|------------|--------|--------|
| 30-0109 | A | Perforated | 1 3/4" | 9"     |
| 30-0106 | B | Smooth     | 1 3/4" | 7"     |

Skull

- | Chrome Black    | Dia.   | Length |
|-----------------|--------|--------|
| 30-3385 30-0466 | 2 1/4" | 9"     |
| 30-3386 30-0467 | 2 1/4" | 12"    |
| 30-0468 30-0471 | 1 3/4" | 9"     |
| 30-0470 30-0472 | 1 3/4" | 12"    |

Flame

- | Chrome Black    | Dia.   | Length |
|-----------------|--------|--------|
| 30-0118         | 1 3/4" | 8"     |
| 30-0117         | 1 3/4" | 11"    |
| 30-0481 30-0483 | 1 3/4" | 9"     |
| 30-0482 30-0484 | 1 3/4" | 12"    |
| 30-0473 30-0479 | 2 1/4" | 9"     |
| 30-0478 30-0480 | 2 1/4" | 12"    |

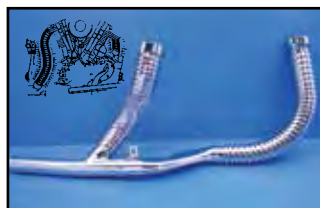

Chrome Flex Exhaust Covers for all Big Twin 74 and 80, 1 3/4". Slides on.

- | VT No.  | Type    |
|---------|---------|
| 30-0110 | MCM     |
| 30-0311 | Replica |



**Exhaust Brackets** are 1" wide x 1/8" thick for mounting goodies, pairs.

VT No.	Type
31-9971	3" Short
31-9972	4 3/4" Long
31-9973	L Bend 1" x 3 3/4"



**Offset Chrome Exhaust Strap Brackets.**

Straight strap 6" long, 3/8" holes. Offset 2" between 3/8" holes. Made from 1/8" steel.

VT No. 31-2115



**Chrome Brackets.** Sold in pairs.

VT No.	Note
31-0676	With 3/8" holes (A)
31-0677	With 1/2" holes (B)

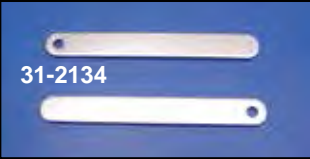

**Universal Chrome Straps** are sold in pairs.

VT No.	Length
31-2133	3"
31-2134	6"
31-2135	8"

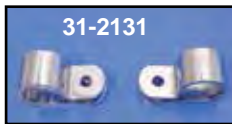

**Frame Mounting Clamp** is 1" clamp for mounting exhaust pipes or footpegs. Sold in pairs. Order bolts and nuts separately.

VT No.	Finish
31-2131	Chrome
31-0273	Black, P-Type Clamp



**Chrome Frame Clamp** to fit frame for exhaust bracket mounting, each.

VT No.	Size
30-0094	1"
30-0093	1 1/8"

# Exhaust Clamp

**Exhaust Mount Clamps (2" and under).**

VT No.	I.D. Size	Style	Length
31-3947	1"	"P" shape	Long
31-2100	1 1/2"	Hanger	Long
31-2101	1 3/4"	Hanger	Long
31-2146	1 3/4"	"P" shape	Short
31-1011	1 3/4"	"P" shape	Long
31-0816	1 7/8"	"P" shape	Short
31-2105	1 7/8"	Hanger	Long
31-2102	2"	"P" shape	Short



**Muffler Mount Clamps**

VT No.	I.D. Size	Style	Length
31-2120	2 1/2"	Hanger	Long
31-2106	2 1/2"	"P" shape	Short
31-2119	2 1/4"	"P" shape	Short
31-2108	3"	Hanger	Short
31-1977	3 1/2"	Hanger	Short
31-2107	2 3/4"	Hanger	Short



**Chrome Pipe Clamp** with angle.  
VT No. 31-2104



**Chrome Muffler End Clamps.** 1 5/8" for use when attaching muffler to 1 1/2" tubing.

VT No.	I.D. Size
31-0270	1 5/8"
31-2132	1 3/4"
31-2103	1 7/8"
31-2144	1 7/8" Heavy
31-1007	1 7/8" Super
31-9914	2"
31-0283	2 1/4" Narrow
31-2099	2 7/8"
31-2141	3"
31-1977	3 1/2"
31-2109	3 1/4"
31-4016*	3 1/4"
31-1012	3 1/2"
37-8683	Bolt Set



\*Note: Stainless steel sold each

# Baffle Set



Baffle	Length							
	8"	8.25"	8.5"	9"	10"	10 1/2"	11 1/2"	O.D.
30-1419								1 3/8"
30-1405								1 5/8"
30-1416				30-1410	30-1407	30-1411	30-1412	1 7/8"
						30-1434		2 1/16"
	30-1417	30-1414			30-1406			2 1/8"
30-1418					30-0351			2 1/4"
						30-1408	30-1409	2 1/4"
30-1415								2 7/8"





# Exhaust Baffle

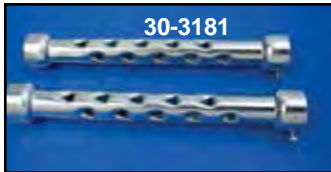

**Blunder Buss Pipe Baffle** is full 12" long steel, pair. Note: Baffle size denotes size of pipe into which it fits.

VT No.	Size	Length
30-3180	1 3/4"	12" long
30-3181	2"	12" long
30-1405	1 3/4"	Baffles are 8"
30-1407	2"	Baffles are 10"
30-1405	2 1/4"	Baffles are 8"

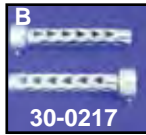
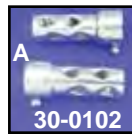

**Pipe Baffles** fit inside straight pipes, sold in pairs. Note: Baffle size denotes size of pipe into which it fits.



VT No.	#	Size	Length
30-0101	A	1 1/2"	4"
30-0102	A	1 3/4"	4"
30-0103	A	2"	4"
30-0216	B	1 3/4"	8"
30-0217	B	2"	8"
30-0372	C	2 1/4"	4.5"

## 1966-84 Exhaust Gasket



**Allen Bolt Exhaust Stud Kit** includes two allen bolts, gaskets and allen wrench. VT No. 37-7275



**Exhaust Stud Nut and Gasket Kit for 74" and 80"** prevents thread stripping in head using permanent studs. Includes two studs, two sure seal flange gaskets, two chrome nugget nuts and lock washers.

VT No.	Type
15-0615	1966-up Shovelhead
15-0195	Gaskets only, 10 pack



**Steel Core Exhaust Gasket** fits 1966-83 Shovelhead, 10 pack.

VT No.	Type	Brand
15-1074	Steel Case	James
15-1541	Steel Case	GB
15-1098	Donut	James
15-1237	Knitted	James



**Shovelhead Exhaust Port Flange Gasket** stock style replaces 65834-68. VT No. 15-0191



**Steel Core Exhaust Gasket.** VT No. 15-0889



**Chrome Sharks Teeth** cover exhaust flange on 1966-84 Shovel to dress up and reduce heat build up. Fits 1 3/4" pipes, sold in pairs.

VT No. 42-0024



**Exhaust Flange Mount Bolt.** Allen type replace 3201W on 1966-84 Shovelheads, 10 pack, black. VT No. 37-8854



**Exhaust Port Lock Kits.** Special bolt and lock tabs secure pipes for good. Fits 1966-84 Shovelhead

VT No. 37-8255



**"Fire-ring" Exhaust Gaskets** features a compressed outer portion and brass inner for maximum sealing

power. Gasket area keeps exhaust gases from escaping and the brass ring ensures a good seal between exhaust pipe and cylinder head. 1966-84 Shovel Big Twin.

VT No.	Type	Qty
15-0195	GB	10
15-0196	GB	50
15-1073	James	10



**James Shovelhead Exhaust Kit** includes four studs, two fire ring gaskets, and two chrome nuggets. VT No. 15-1075

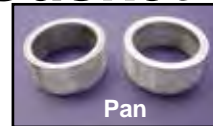

**Exhaust Port Replacement Service.** Available for both Pan and Shovelhead applications. Ship in old disassembled cylinder heads and the broken or stripped exhaust ports will be replaced with new factory style exhaust ports. Service includes ports as shown.

VT No. Replacement Service

60-0162 Panhead

60-0163 Shovelhead

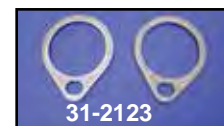

**Exhaust Repair Ports.** Aluminum castings to be welded on broken or damaged heads. B, pipe flange is steel and is to repair Shovel pipe flanges, pairs.

VT No.	Years	Models
30-0098	1948-65	Panhead
30-2104	As Above	Motor Shop
30-0105	1966-84	Shovelhead
31-2123*	1966-83	Shovelhead

\*Note: To repair pipe ends.



**Copper-Clad Exhaust Gaskets** for Shovelhead are heat proof material sandwiched between two sheets of copper, the ultimate sealing. Copper donuts are

compressible for better sealing on uneven pipe flanges.

VT No.	Type	Qty
15-0197	Copper Clad	10
15-0198	Copper Clad	50
15-0660	Copper Donuts	10



# Ignition Points Cover

Points Covers for Big Twin use, 1970-99 with horizontal holes.

Chrome	Black	Style
42-0748		Flame
42-0106		Live to Ride
42-0088		Live to Ride Gold Inlay
42-0035		V-Tech
42-0299		Domed
42-0662		Flat
42-5522		Flame
42-0956		Smooth with Hidden Screws
42-0065		Skull with flame
42-1078		Black Raised Skull
42-0081		3-D Skull
	42-0560	Skull
42-0162		Cross "Spins"
42-1970		Motor
42-0960		Cross
42-6100		Maltese
42-1110		Perforated
	42-1115	Ball Milled
42-1176		Skull with chain
42-1383	42-1384	Air Flow
42-1272		FLH, 1970-84, Horizontal
42-1148	42-1166	Grooved
42-0177		Baron
42-1058		Milled Skull
42-0155		Smooth
	42-1116	Smooth, Domed
	42-1125	Perforated
	42-1122	Alloy Flame
42-1095		Ball Milled
42-0581		Chrome Skull on Black
42-0474	42-0475	Flame
42-0198	42-0189	Smooth
42-0464		Black Mesh Skull
42-0465		Black Mesh Flame
8764-2		Allen Screws, 1970-78
8765-2		Allen Screws, 1978-up
8402-2		Acorn Screws
8492-2		Acorn Screws

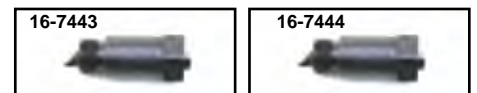
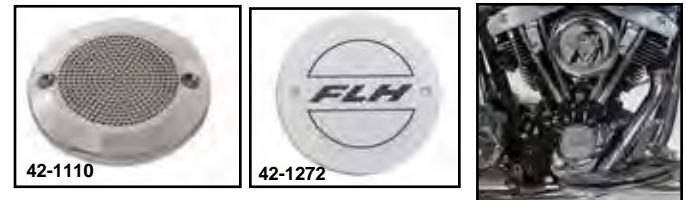

Clear Timing Plugs are available as a long optically clear type, or a short standard version with or without the internal hex.

VT No.	Item
16-1731	Long Type
16-0829	Hex Type
16-0099	Standard, 10 pack
16-0160	Standard, each



**Clean Time** pushes into timing hole and wipes flywheel clean for strobe timing.  
VT No. 16-0715

**Timing Tool.** Screws into timing hole to lock flywheel for timing.

VT No.	Type
16-7443	Slot
16-7444	Point

CLASSIC





# Ignition System



32-9500



32-9501



32-9503

**Volt Tech Ignition Systems** fit all 1970-98 carbureted models and requires sensor cup for 1982 and earlier applications. Order tach interface, sensor cup and screw separately if required. **Note: Order Coils When Required.**



32-0588

### VT No. Fits

- 32-9501** Dual Fire Ignition fits Evo, Shovel and Sportster through 1997. It can be set for Street or Race-Electric start or Kick Start includes 4000 to 8000 adjustable RPM limiter. Includes adjustment for rate of advance. This unit is compatible with stock dual fire coils.
- 32-9500** Single Fire Ignition fits Evolution, Shovel and Sportster through 1997. It can be set for Street or Race-Electric or Kick Starter includes rear cylinder timing adjustment for rate of advance. Compatible with single fire coils.
- 32-9503** Single Fire Ignition Kit fits As Above Includes coil and 8.5mm wires.
- 32-0588** 8.5mm Wire Set



16-7443



16-7444

**Timing Tool.** Screws into timing hole to lock flywheel for timing.

VT No.	Type
16-7443	Slot
16-7444	Point

### Crane Hi-4 Replacement Rotors.

- VT No. Item**
- 32-0588** 8.5 mm Wire Set
- 32-9087** Sensor Cup, replaces 32402-83
- 32-9052** Cup Screw, replaces 2611C
- 32-9292** Rotor



# Daytona Twin Tec



**Daytona Twin Tec Internal Ignition Kit** for 1984-99 Evolution Big Twin, 1970-84 Shovelhead Big Twin and 1971-97 Sportster models. Kit includes ignition, coil and spark plug wire set.

**VT No. 32-3015**



**Twin Tec Internal Ignition for 1970-99 models.** Two advance curve families with adjustable advance slope accommodate stock to highly modified engines. It features digitally set RPM Limit (100 RPM Steps) and selectable single or dual fire mode. Coil outputs are protected against short circuits.

VT No.	Item
32-1005	Ignition
32-2013	3 Ohm Coil Single Fire

## Timing Plugs



7106-1

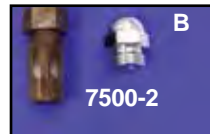

7500-2



9402-1



8610-1

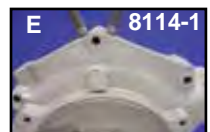

8114-1

**Timing Plugs** are available in stock size  $\frac{5}{8}$  — 18 thread unless noted as oversize (O.S) which is  $\frac{1}{16}$  — 16 thread.

**A.** Acorn style plug fits all models Big Twin models timing plug holes and oil tanks.

**VT No. Type**

**7106-1** Chrome

**B.** Acorn style plug with oversize thread and one tap for rethreading stripped out timing hole. Fits all timing holes.

**VT No. Type**

**7500-2** Plug and Tap (Oversize)

**7501-1** Plug Only (Oversize)

**9407-1**  $\frac{1}{16}$  — 16 Tap (Oversize)

**C.** Stock timing plug.

**8114-1** Chrome

**8115-1** Cadmium

**9404-1** Cadmium (Oversize)

**9304-1** Chrome (Oversize)

**9714-1** Parkerized (Oversize)

**9502-1** Chrome 1939-51

**9504-1** Parkerized as above,  $\frac{7}{8}$ " Hex

**9503-1** As above cadmium

**D.** Functional and custom design plug fits all Big Twin models and Sportster timing plug holes and oil tanks.

**8610-1** Chrome

**8611-1** Cadmium

**E.** Allen style plug use on all 1970-up replaces 720.

**9402-1** Chrome

**9403-1** Cadmium

**37-9206** Chrome by Gardner-Wescott

**9960-1** Chrome (Oversize)

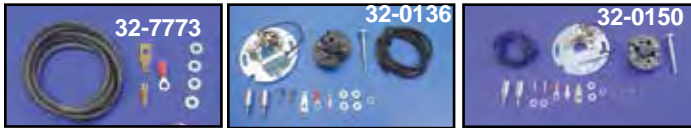

**Points Conversion Kit.** Both brands include everything necessary for direct replacement on 1970-78 Big Twin, 1971-78 Sportsters or for converting late model electronic-type back to points. Accel type available with microchip points, which will require a domed shaped points cover such as VT No. 42-0299 to accommodate taller points. The V-Twin unit includes stock style points and condenser and is available with stock needle bearing weights.

VT No.	Item	Type
32-7773	Accel with Microchip	Stock
32-0136	V-Twin with Points	Stock
32-0150	V-Twin/Points	Needle

Points Plate Screws.		
VT No.	Year	Type
32-0049	1982-up	Steel
32-0760	1982-up	Stainless
32-0051	1970-81	Steel
2743-2	1982-up	Oversize



**Tune-able Advance Unit** features stainless base, heat treated weights cam bolt and 3 different color coded spring sets which allows full advance at 1400, 2000, and 2600 RPM depending on which springs are selected. Can be used with all ignitions, points, single or dual fire types which utilize an advance unit. Springs also available separately.

VT No.	Type
32-9220	Stock
32-9261	Needle Bearing
13-0121	Stock Springs, Black
13-9246	Heavy
13-9247	Severe



**Competition Advance Unit** features machined stainless steel shaft and plate, metallic coated weights and special wound springs for exact advance. Replaces 32505-78A for 1970-up, mechanical advance applications. Center screw included.

VT No.	Item	Brand
32-9037	Competition Unit	Rivera
32-9220	Complete with tune-able springs	V-Twin

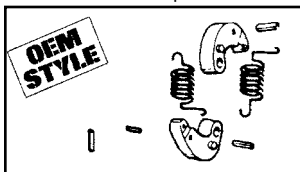

**Automatic Advance Rebuild Kit** includes two springs, two weights, and roll pins. For all 1970-78 Twins.

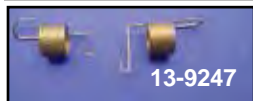

**1970-up Advance Weight Springs.**

VT No.	Fits
13-9247	Severe Duty Advance Weight Springs for all Hi-compression and heavily modified engines. Also useful for applications experiencing detonation (pinging) or very erratic idle, pair
13-9246	Heavy Advance Weight Springs for slightly modified stock, low compression or mild stroker application, helps cure minor idle problems, pr
13-0121	Original type replacement. Uses premium grade spring steel, 10 pack

Ignition Wire Chrome Clamps.		
VT No.	Type	
37-9014	Points	
37-9015	Electronic	

# Ignition Advance

**Blue Streak Sifton "Tune-able" Ignition Advance Assembly** includes stainless advance base, points plate with "Blue Streak" points and condenser with hardware and 3 pairs of color coated springs which allow full advance at 1400, 2000 and 2600 RPM depending on which spring is selected. **VT No. 32-0713**



**Points Plate Assembly** available as stock point and condenser replacement fits for 1970-78.

VT No.	OEM	Item
32-0549	32577-70	Point Plate Assembly
32-0042	32618-70A	Mount Plate Only
37-8809	1047	Point Mount Plate Screws with washer assortment
	7115, 6189W	



**Stainless Advance Unit** features stainless base, heat treated weights and cam center screw for 1970-up mechanical advance ignition. **VT No. 32-0178**



**Advance Units** feature heat treated weights and steelbase for 32-7510.

VT No.	Type	Type
32-7510	Advance	Steel
32-0168	Advance	Stainless without bolt
32-0055	Center bolt	Steel

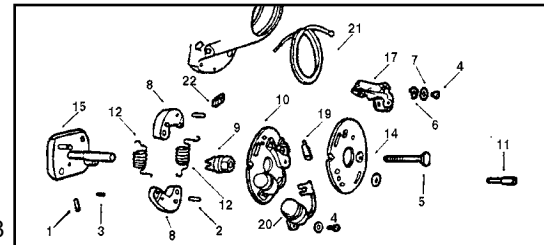

## Advance Unit Rebuild Parts.

VT No.	OEM	#	Item
32-7510	32505-78A		Rotor and Weight Assembly
12-1163	615	1	Roll Pin Breaker Plate
12-1164	620	2	Roll Pin Breaker Weight
12-1162	623	3	Roll Pin, Breaker Plate
12-1152	8699		Pop Rivet for Cover
37-8809	1047, 7115, 6189W	4	Point Mount Plate Screws with Washer Assortment
32-0055	3570	5	Timing Screw
32-0138	32522-70	8	Weight Set
32-0053	32542-70A	9	Cam only
32-0549	32577-70	10	Breaker Base Assembly
32-0051	32601-78	11	Plate Mount Stud 1970-81
32-0049	32606-82	11	Plate Mount Stud 1982-up
32-0054	As Above	11	Oversize with 1/24 threads for Stripped out Covers
13-0121	32605-70	12	Springs
32-0042	32618-70A	14	Mount Plate only
32-0118	32661-70	17	Point Set
32-0411	32670-70	19	Terminal Kit
32-0121	32726-30A	20	Condenser and Bracket
32-1316	5 pack	20	Condenser and Bracket
32-1557	70456-73	21	Point Lead Wire
37-8971	10046	22	Point Lead Wire Clamp





# Ignition Kit



**V-Tech Ignition Kits** are available in **dual fire** where there are 2 sparks at the same time and **single fire** where there is 1 spark for each cylinder when it is fired, (separate). Each kit includes a mechanical advance unit and all hardware. Order coil separately 32-0467 coil has 2 separate coils inside to fire independently.

VT No.	Item Type	Coil
32-0468	Kit Dual Fire	32-0511
32-0469	Kit Single Fire	32-0467



**Single Fire:** Just the spark plug for the piston that is in its compression stroke will be fired. The other piston, being in its overlap position will not be ignited.  
**Dual Fire:** Both spark plugs are fired simultaneously at the time only one piston is in its compression stroke.  
 This is the way the stock motor works on pre TC-88 motors.  
**Single Plug:** One spark plug in each head. Total of 2 spark plugs in one engine.  
**Dual Plug:** Two spark plugs in each head. Total of 4 spark plugs in one engine.

**Mallory Unilite Breakerless Ignition System** for 1970-99 all Twins. Dual fire unilite module features integrated photo coupler, signal processor and power switch. Requires mechanical advance assembly and ignition coil with 3.0 to 4.0 ohms.

VT No.	Item
32-5119	Ignition System
32-7510	Mechanical Advance



**Accel Single/Dual Fire Ignition Module.** Fits all carbureted 1970-2000(except TC-88) and all 1971-up Sportster models, works in both single or dual fire applications and features 14 tune-able advance curves from stock to full performance, adjustable rev limiter, VOES input, tachometer output and front cylinder static time LED. Requires sensor cup for installation.

VT No.	Item
32-0091	Accel S/D Fire Ignition Module
32-9087	Sensor Cup, 1983-94
32-9124	Sensor Cup, 1995-up

## Module



**Chrome Module Covers** fits 1980-up.  
 VT No. 42-0399



## Generator Rebuild



**Generator Rebuild Service** for labor only. We ask that all generators be shipped to us assembled and complete as possible, with or without gear installed. Our suggested dealer price is for labor only. All other parts required or specified will be billed separately.

VT No.	Generator	Volt	Brush	Fits
60-1932	32E	6	3	1936-51 W
60-1952	52K	6	3	1952-57 FL
60-1958	58	6	2	1958-64 FL
60-1965	65A	12	2	1965-69 FL



# DYNA Ignition



**Dyna 'S' Hi-Performance Ignition System** is self contained, fits behind ignition cover, uses magnetic rotor with the original spark advancer, so factory advance curve is maintained. Improves performance, extends spark plug

life, eliminates points and condensers.

**Note:** For dual plugged heads, on 1980-up use advance mechanism, VT No. 32-7510.

**VT No. 32-7778** (DS6-1)



**Dyna 'S' Single Fire Ignition** has the features of the Dyna 'S', but fires front and rear cylinders independently of each other which allows

accurate timing of each cylinder. Stock ignition systems fire both cylinders at the same time which has the wasted sparks on the exhaust stroke. This eliminates this inherent problem. For use with either dual or single plug heads. On 1980-up models, use VT No. 32-7510 Advance assembly.

**VT No. 32-7777** (DS6-2)

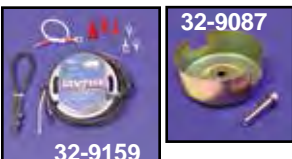
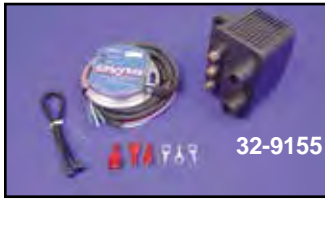

**Dyna 2000i Digital Ignition** available as a module only or complete kits that include correct coil. Features include single or dual fire operation, 8 advance curves, built in tach driver, adjustable RPM limit from 6000 to 7500 and easy static timing with built in timing indicator. Fits all 1970-98 carbureted models and requires 1983-up sensor cup for 1982 and earlier applications. Advanced Programming Software allows the mechanic or tuner the ability to fine tune 2000i Ignition but requires adapter.

VT No.	Item	Plug	Fire	Coil
32-9151	Kit	Single	Single	DC3-1
32-9152	Kit	Dual	Single	DC1-1
32-9153	Kit	Dual	Dual	DC2-1
32-9155	Kit	Single	Single	DC6-5
32-9159	Module Only			
32-9087	Sensor Cup			
32-9052	Cup Screw, 10 pk			
32-9120	Advanced Programming Software for Above Ignitions			
32-9121	Software Adapter Harness			



## Dyna S Performance Ignition Systems.

Available in dual or single fire for street applications only. Each kit includes sensor plate assembly and correct coil for each application. Single plug only. 1980-up applications require 32-7510 advance mechanism.

VT No.	#	Type
32-0800	DSK-6-2	Single Fire
32-0801	SDK-6-1	Dual Fire



## Replacement Rotor for Dyna Ignitions.

VT No.	Fits
32-9300	DS-6-1
32-9301	DS-6-2



**Dyna Coils.** 35,000 volt! Works with all points ignitions, aftermarket or factory electronic ignitions. Note: 32-7792 is electronic, 32-7793 is for points ignition.

VT No.	#	Volt	Ohm	Dyna	Type	U/M
32-7789	A	12V	3	DC-1	Angle, Dual	Pair
32-7790	A	6V	1 1/2	DC-2	Angle, Dual	Pair
32-7792	C	12V	3	DC-6	Stock, Dual	Each
32-7793*	C	12V	5	DC-7	Stock, Dual	Each
32-8055	B	12V	3	DC-3	Angle, Single	Pair
32-8086	A	12V	5	DC-8	Angle, Dual	Pair
32-9035	B	12V	5	DC-10-1	Angle, Single	Pair

**\*Note:** Use 2 for single fire ignition.

**K.V. Recommends the following coils for Dyna Ignitions:**  
**DS6-1 Ignition VT No. 32-7778**  
 Street, Single plugs use DC-7 or DC-8  
 Race, Single plugs use DC-1 or DC-6  
 Street/Race Dual plugs use 2 DC-2 or DC-5, wired in series  
**DS6-2 Ignition VT No. 32-7777**  
 Race, Single plugs use 2 DC-3  
 Street, Dual plugs use 2 DC-7 or DC-8  
 Race, Dual plugs use 2 DC-1 or 2 DC-6  
 Street, Single plug uses 2 DC10-1



**Dyna Electric Tach Adapter Kit** must be used with Dyna 'S' single fire ignition is installed on any twin when electric tach is used. **VT No. 32-7799**



**Dyna Ignition Booster** for single point systems only transforms inconsistent electrical surges into controlled bursts of energy to the coil, power is not wasted.

**VT No. 32-7787**





# Tune Up Components

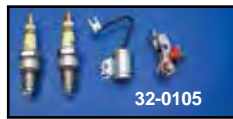

**Blue Streak Premium Parts**  
for 1970-78 Twins.

VT No.	Item
32-0156	Points
32-0157	Condenser

**Accel Performance Tune-Ups Kits** include replacement spark plugs, matched crown contact points, condensers, gap settings and point cam lube. Blister packed for display.

Plugs	Without Plugs	Fits
	32-0106	1970-74 FX-FL
32-0105	32-0106	1975-78 FX-FL



**Condensers.** Replaces 32726-30A 1948-Early78 FL, FLH, FX.

VT No.	Year	Brand
32-0137	1949-54	Delco
32-0121	1948-78	V-Twin



**Point Sets.**

VT No.	Year/Model
32-0117	1948-69 FL, FLH,each
32-0118	1970-E78 FL, FLH

## 1936-47

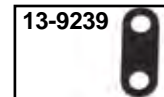
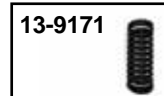

**V-Twin Tune-up Kits** include plugs, points and condenser. Also available as points and condenser kit only.

With Plugs	Without Plugs	Years	Fits
32-1113	32-0113	1930-47	45-FL-UL (Champion)
32-1145	—	1930-47	45 FL-UL
32-1745	—	As Above	Globe
32-1114	32-0114	1948-69	FL
32-0103	—	1948-67	FL
32-1115	32-0115	1970-74	FL-FX
32-1117	32-0115	1975-78	FL-FX

**1930-47 Points and Condenser Set** includes spring.

VT No.	#	Item
32-0113	A, B, C	Points, Condenser and Spring
32-0543	A, B, C	Replica Kit
32-0120	A	Points Only
32-0123	B	Condenser Only
32-0576	B	Delco Condenser
32-1762		Condenser
13-9171	C	Spring for Points (10 pack)
13-9239	D	Spring Plate Washer for Points
37-0736		Screws for Above
32-1287		Replica Points Kit
48-1477		Delco Remy Patch



**V-Twin Panhead Parts Dope Reference Guide** for 100% V-Twin restoration components and tips for 1948-65 Panhead models. 272 pages.

VT No. 48-1364



**Condenser Bracket** mount two condensers, not included, to coil mount bolts.

VT No. 31-9905



# Replica Distributor



**Electronic Distributor Top.**  
**Electronic Mechanical Year**  
**32-0821 32-0810 1930-47**



**Single Point Distributor Parts** for 1949-60 manual advance models.

VT No.	OEM	Item
37-9235	30507-47A	Eccentric Screw
8146-10	3779, 7035	Circuit Breaker Screws Cad
8145-10	3779, 7035	Circuit Breaker Screws Chrome
10-0717	32525-36A	Bushing
32-0198	32531-36	Timer Gear
32-0029	215	Gear Pin, 1940-65
32-0047	32579-49	Breaker Base Only
32-0134	32585-36	Base Retainer
32-1286		Base Retainer Kit
32-0046	32593-47	Adjuster Screw
2632-3	As Above	Colony
Kit	32594-47	and Plate Kit
32-0154	32676-49	Wire Stud
32-9265	32690-30	Distributor to Coil Wire
32-9340	32690-30	Distributor to Coil Wire, OE
32-0576		Delco Condenser

**Thrust Washer Timer Shaft** for 1948-64, 5 pack.

VT No.	OEM	Width
10-1269	32535-48	.062"
10-1270	32535-48	.066"
10-1272	32538-48	.076"



**Circuit Breaker Post Kits** replaces fiber bushings and pin, the 1948-69 type includes pin only. Both include installation tool.

VT No.	Fits	Wire
8848-6	1930-48 All Models	2542-10
8849-2	1948-69 All Models	2543-10

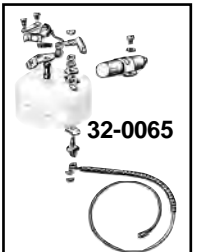
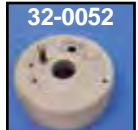
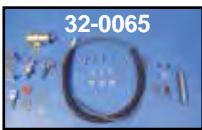

**Distributor Top Rebuild Kits** include points, condenser, wire, washers, bushings, studs, and hardware. Order breaker base separately.

VT No.	OEM	Years
32-0065	Kit	1936-47
32-0068	Kit	1948-60
32-0052	32575-37	1937-47 Base Only
32-1291	Kit	1937-47 Base Only
32-0047	32879-49	1948-60 Base Only
32-1312		Bare Assembly



**Circuit Breaker Screws** to mount distributors and relay on 1936-64, 61, 74 and 80 models, 10 piece.

VT No.	Finish
8146-10	Cadmium
8145-10	Chrome
9684-10	Parkerized
7130-10	Acorn

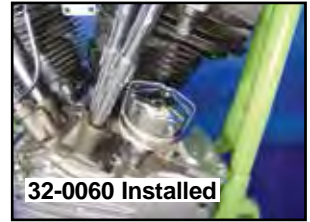
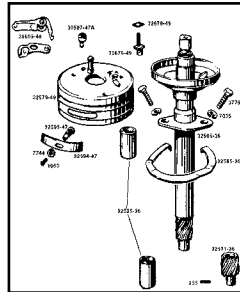
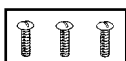

**Replica 1936-47 Complete Distributors** are fully assembled with natural alloy finish base with shaft and gear installed. Top housing includes early point set with spring and condenser. Stainless advance band, chrome top and clip, base retainer and points wire.

VT No.	Item
32-0060	Distributor
8146-10	Mount Kit
15-1030	Gasket

**Distributor** for 1936-48 45 and UL are two bolt manual advance style featuring natural alloy finish base with shaft and gear installed. Top housing includes early point set with spring and condenser. Stainless advance band, chrome top and clip, base retainer and points wire.

VT No.	Item
32-0061	Distributor Assembly, Complete
9414-8	Chrome Screw Kit
32-0045	Base with Gear
49-0214	Base Only
49-0895	OE Base Only
32-0134	Retainer
15-1031	Mount Gasket
15-0154	Mount Gasket

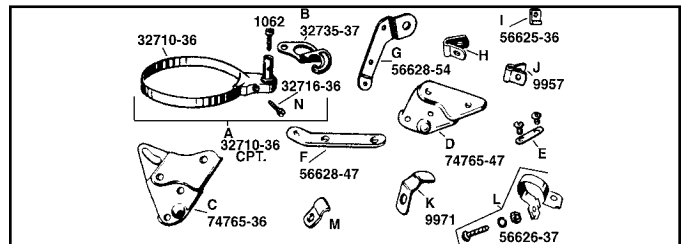
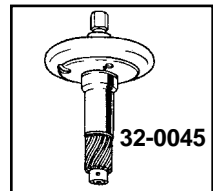

**Distributor Bands, Brackets and Relay Mount.**

45+	OHV	#	OEM	Item
49-0072		A	32710-36	Band Kit, All
49-0060		B	32736-37	Bracket 45 SV
	49-2010	B	32735-37	Bracket 74 & 80
	49-0216	C	74765-36	Relay Mt 1936-46
	49-2534	D	74765-47	Relay Mt 1947-64
32-1324	32-1324	E	32666-30	Relay Mt 1936-37
13-9239				Points Plate Spring
31-9904		F	56628-47	Washer, 5 pk
		G	56628-54	Spark Cable
31-5013		H	10046	Bracket, 1947-53
37-8971		I	56625-36	Horn Bracket
37-9154		J	9957	Breaker Wire Clamp
37-9155		K	9971	Clamp
2586-1		L	56626-37	Clamp
2587-1		M	As Above, Colony	Clamp
31-0276		N	4726-36A	Clamp
37-0268			9971	Wire Clamp
			56626-37	Timer Clamp
			74765-36	Timer Cable to
			56628-47	Frame Clamp 1937-46
			9971	Timer Cable to
			74765-47	Frame Clamp 1947-64
			9971	Timer Cable to
			56626-37	Frame Clamp 1947-64
			9971	Timer Cable to
			56609-52	Frame Clamp
			32716-36	Band Screw
			1634-36	Band Block
				Stud





# Auto Advance Distributor

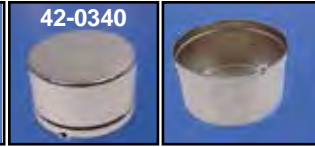

**Auto Advance Distributor** features a chrome body and top. These are completely assembled with gear and internal parts. VT No. 32-0546 unit uses stock hold down 32-0135 and fits all 1966-69 Big Twin Overhead Valve. The 32-7558 type fits 1930-73 45 and UL models and requires VT No. 31-3966 hold down clamp. Units require removal of front head for installation.

VT No.	OEM	Fits	Type
32-0546	32502-66A	1966-69 Big Twin	Complete
32-7558	32506-70	1930-73 Side Valve	Complete
42-0300	32589-65	Fits 32-0546	Top Only
32-0135	32516-66	1966-69 Big Twin	Clamp
13-0166	32604-64	1965-66	Spring (pair)
13-0162	32605-67	1967-69	Spring (pair)
31-3966	32515-66	1936-73 Side Valve	Clamp
32-0281	—	1966-69 Big Twin	Points Lead Wire with clamp

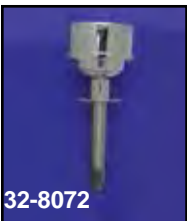

**32-8072 Installed**



**Auto Advance Distributor** features a chrome body and top. These are completely assembled with gear and all internal parts. Distributor has a two bolt mount flange to fit all 1936-64 Big Twin cases.

VT No.	Item
32-8072	Two Bolt Distributor Complete Kit
42-0340	Cover fits 32-8072
32-7797	Advance for 32-8072

Distributor Cover includes hold down clip. Use on 1936-64 45", 61", 74" 80". Also KH.		
Chrome	Cadmium	Item
42-0301	42-0533	Kit
42-0382		Kit, <b>Note:</b> Stainless
32-0133	32-1125	Clip

# Replica Distributor



**1948-69 Single Point Distributors** are two bolt manual advanced style featuring natural alloy finish base with shaft and gear installed. Top housing includes 1948-69 type single points, condenser, adjuster plate, chrome top, clip, base retainer and points wire.

VT No.	#	Fits
32-0039	A	1948-64 45's and UL
32-0038	B	1947-64 Big Twin
15-0153		Base Gasket

**32-0169 1966-69 Big Twin Distributor Mount Clamp Kit** includes zinc plated clamp, stud, O-ring and nyloc nut.

VT No.	Item
32-0169	Kit
12-0547	Stud only



**Electronic Ignition Distributor Complete** with billet chrome body and top features electronic internals with shaft and gear completely assembled. Fits 1936-69 Big Twin models. VT No Order mount clamp VT No. 32-0169 mount clamp separately.

VT No.	Item
32-1540	Distributor Kit
32-1498	Distributor
32-0072	Distributor, Complete
42-0563	Top
12-1497	Gear Reverse

**Accel Unilite Distributor** with billet aluminum housing is a dual fire type, includes gear and features 12 volt electronic performance. The electronic ignition module fits inside distributor, so no external box is required. There are no points to adjust or replace.



Spark plugs can use larger gaps up to .040. The top can be removed without the removal of front cylinder head.

VT No.	Item	Model	Year
32-0170	Mallory Distributor	Big Twin	1941-69
32-0135	Distributor Clamp	Big Twin	1966-69



**Electronic Advance Distributor** with rev limiting for 1936-69 Big Twins. Features adjustable electronic advance curves, single or dual fire modes, CNC machined billet housing, and can be installed without removing cylinder head. Use with a 3 ohm coil.

**VT No. 32-7803**



# Ignition Coil

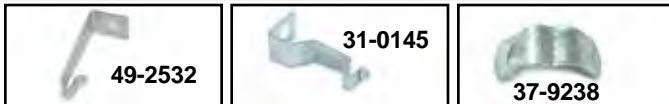
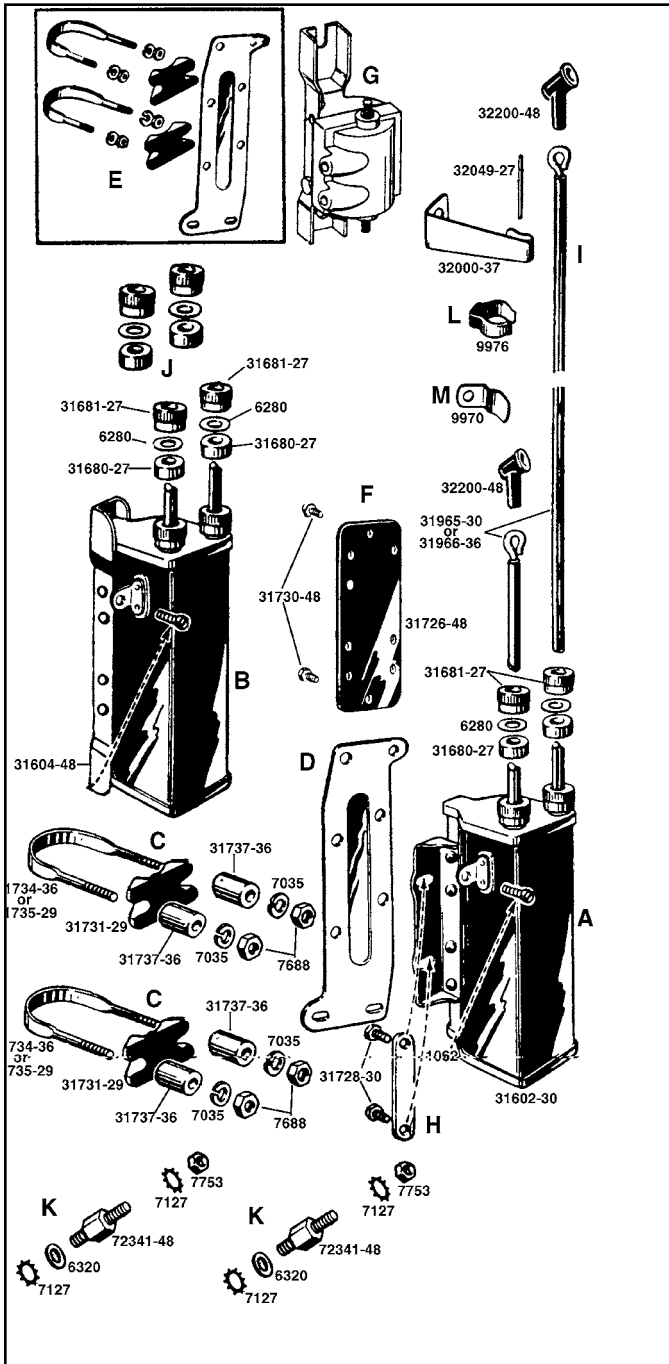

### Spark Cable Bracket.

VT No.	OEM	Year	Model
49-2532	32000-37	1937-63	45 Side Valve
31-0145	32000-37A	1937-60	74 Overhead Valve Rear
37-9238	4726-36	1936-64	74 Overhead, Front

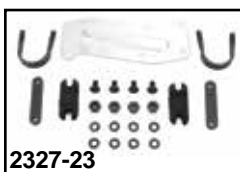

### Coil Mount Kits.

VT No.	Fits	Model
2327-23	1930-36 VL	1929-47 45
2281-18	1937-47	UL and Knucklehead

**Warranty**  
All Electrical Components sold as individual pieces or in kits are covered under our warranty "Replacement Only" Provision. All electrical related item part numbers begin with a 32 prefix. No credit will be issued for these items as they are exchange only.

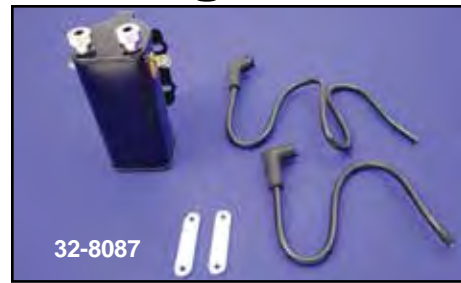

**Note:** All Early Coils are for "Points" only applications.

**V-Twin Replica Coils** are steel jacketed, include nuts, packing and wires. **Type A** replaces 31602-30 on 1930-47 and uses kits VT No. 49-0099 on Big Twin and 49-0100 for 45 models to clamp to frame tube. **Type B** replaces 37604-48 on 1948-60 and mounts to stud kits as listed.

VT No.	#	Volt	Item
32-8087	A	6	Black Coil
32-8088	A	12	Black Coil
32-8089	A	6	Chrome Coil
32-8090	A	12	Chrome Coil
32-7520	B	12	Chrome Coil
32-7523	B	12	Black Coil
32-7521	B	6	Chrome Coil
32-7522	B	6	Black Coil
32-0670	I		Wire Set
7804-6	J		Nuts with Packing
8823-10	K		Stud Set 1948-55
8824-8	K		Stud Set 1956-82

**45 Coil Mount Kit** fits 1930-52 45 Solo and Servi, includes two (2) U bolts, mount plate, two (2) U-straps and four (4) spacers, zinc plated.

VT No.	#	OEM	Item
49-0100	E		Complete Kit
37-8838	D	31726-30	Mount Plate
37-8814		31735-29	U Bolts, pair
37-8836		31731-29	U Bolt Strap, pair
31-0217	F	31726-48	Mount Plate to fit when using early coil 48-73 frames

31-0487	G	31725-48A	Bracket to mount late coil
32-0350	L	9976	Wire Clamp
37-9238	M	9970	Front Wire Clamp, OHV
2505-1	M	9970	As Above, Colony

**1936-47 Big Twin Coil Mount Kit** includes two U Clamps, four spacers and two bolt straps fits 74 and 80, zinc plated.

VT No.	OEM	Item
49-0099	Note C	Complete Kit
37-8816	31734-36	U-Bolts, pair
37-8836	31731-29	U-Bolt Strap, pair



### "Brass" Early Coils.

VT No.	Volt	Type
32-1136	6	B
32-1138	12	B
32-8110	6	A
32-8112	12	A





# Coil Cover



Chrome Coil Covers as noted.

VT No.	Style	Year
42-0415	Smooth	1965-99 BT, FX and FL
42-0417	Louvered	1965-99 BT, FX and FL
42-0215	Finned	1965-99 BT
42-0891	Finned	1961-64 Pan (Dual Coil)
42-9948	Teardrop	1965-99
42-5523	Skull	1965-99
42-1030	Flame	1965-99
42-1528	Skull	1965-99
42-1529	Flame	1965-99
42-9969	Eagle Spirit	1965-99

Coil Cover, Screw and Speed Nut for Big Twin.

VT No.	Years
37-7252	1965-77
37-8906	1978-84, Screw only, 3473



6 and 12 Volt Coils. A and B include clamp bracket.

VT No.	#	Volt	Finish	Year
32-7563	A	6	Black	1936-64
32-0127	B	6	Chrome	1936-64
32-0126	B	12	Chrome	1936-64
32-0189			Wire Set	All
32-0190			Nut	All

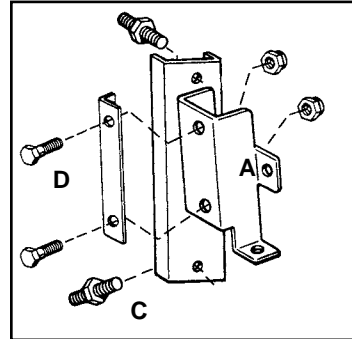
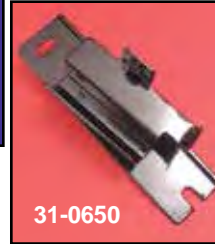
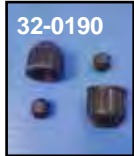

Big Twin Coil Brackets are stock style mount to existing studs for years listed. The 31-0127 black type includes outer strip 31-0422, all other numbers are updated one piece type. Order mount studs separately, includes nuts and washers.

VT No.	#	OEM	Finish	Years
31-0127	A	31724-65	Black	1948-77
31-0650		31728-78	Black	1978-83
31-1978		31728-78	Chrome	1978-83
8823-10	C	72341-48	Stud Set	1948-55
8824-8	C	72341-56A	Stud Set	1956-82
31-0551	D	Strap Only	Black	All
31-0422	D	Strap Only	Chrome	All



Dual Coil Brackets available in black steel mounts 2 Dyna coils VT No.'s 32-7789, 32-7790 or 32-8055.

VT No.	Year	Note
31-3971	1965-81	Mounts to stock coil mount holes.
31-3970	1982-85	Mounts to existing coil brackets.



Coil Mount for Dyna ignitions, allows 2 Dyna DC-1, 2, 3, and 8 on 1965-85 FL-FX, 1984-up Softails except FLT-FXR. Made of billet aluminum, black coated with stainless hardware. Accept stock coil cover VT No. 42-0415. VT No. 31-9923



**Single Fire V-Tech Hi Output Coil** features 45 kv with 1 spark for each cylinder as fired and will mount to stock bracket and accept stock cover.

**VT No. 32-0747**

1. 12 volt wire from ignition switch is connected to center post along with red wire from ignition.
2. Connect the black wire to outer post from front cylinder.
3. Connect the white wire to other outer post for rear cylinder.



**80 KV Dual Fire Coil** for 1965-99 mounts to stock locations.

**VT No. 32-0095**



**Black Andrews Black Dual Fire Coil** produces more voltage than stock coils.

VT No.	Ohm	Year
32-0709	4.8	1965-80
32-0712	2.8	1981-99



**Chrome Stock Style Dual Fire Coils** bolt to original brackets for exact fit.

VT No.	OEM	Year
32-0513	31609-65A	1965-79
32-0514	31609-80	1980-83



**Blue Streak 45,000 Volt Dual Fire Coils** provide more spark and energy than stock coil and the higher voltage eliminates spark deterioration at peak RPM.

VT No.	Years	Type	Ohms
32-0171	1980-99	Electronic	2.7
32-0172	1965-79	Point	4.6

**Single Fire:** Just the spark plug for the piston that is in its compression stroke will be fired. The other piston, being in its overlap position will not be ignited.  
**Dual Fire:** Both spark plugs are fired simultaneously at the time only one piston is in its compression stroke. This is the way the stock motor works on pre-TC-88 motors.  
**Single Plug:** One spark plug in each head. Total of 2 spark plugs in one engine.  
**Dual Plug:** Two spark plugs in each head. Total of 4 spark plugs in one engine.



**Accel Single Fire Super Coil** features ultra fast coil rise time with voltage output 45% higher than stock & 3.0 ohms of primary resistance. Mounts to stock coil bracket & fits under stock coil covers. Fits all Twins except TC-88.

VT No.	Type
32-0090	Yellow
32-7802	Chrome



**Accel Power Pulse 12V Dual Fire Coil** provides longer spark duration with a greater KV rating and faster rise time than stock coil. Molded in epoxy. for 1965-83.

VT No.	Epoxy Finish
32-0130	Yellow
32-1064	Black

# Ignition Coil



**Volt Tech Molded Dual Fire Coil** features black late shape with bobbin type windings.

VT No.	Year
32-7572	1965-79
32-7573	1980-82



**Volt Tech Stock Replica Dual Fire Coils** are factory replacement quality to fit stock brackets.

VT No.	Year	Volt	Color
32-0711	Pre1965	6V	Rust
32-0128	1965-79	12V	Black
32-1268	1965-80	12 V	Red (4.8 ohm)
32-0129	1980-83	12V	Black (2.8 ohm)

**Note:** 32-0129 for electronic ignition, top terminal mounting.



**Replica 1961-64 Big Twin 6 Volt Dual Coil** replaces 31604-61. Sold each.  
**VT No. 32-0131**

### Warranty

All Electrical Components sold as individual pieces or in kits are covered under our warranty "Replacement Only" Provision. All electrical related item part numbers begin with a 32 prefix. No credit will be issued for these items as they are exchange only.

# Coil

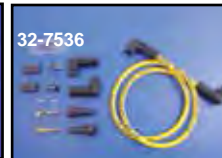

**Accel High Energy Dual Fire Coil** is a very high KV energy output requires that it be used with

our extreme service 8.8mm silicone racing wires. Each coil is complete with two 8.8mm wire leads and appropriate chrome brackets.

VT No.	Item
32-0132	Kit 1965-87
32-7536	Wires only



**Accel H.V. Dual Fire Super Coil** bolt on for points ignition systems. High-tech molding for 1965-99 with 4.7 ohms.

VT No.	Ohms
32-7771	Yellow
32-7800	Chrome





# Spark Plug Wire Sets & Clamp



**Vintage Style Braided Silicone Spark Plug Wire**, 7mm (inner copper core). Each kit is 40" long with two 90° angle boots.

**VT No. Color**

- 32-1212 Black/Pink
- 32-1213 Yellow/Blue
- 32-1214 Green/Yellow
- 32-1215 Blue/Pink
- 32-1216 Orange/Black
- 32-1217 Red/Black
- 32-1218 Black/Black



- 32-0670 Wire Set
- 7804-6 Plug and Packing Kit
- 32-0813 Plug Boot Set
- 32-0829 Wires Only
- 32-1108 Wire Set



**Replica Spark Plug Cable Set** replaces 31965-30 rubber molded ends for 1930-60 Twins. Order coil packing, nuts and washer kit separately.



**8 mm Blue Streak XXX Silicone Wire Sets** features quality construction of silicone throughout the jacket, insulation and core. This assures high temperature resistance and high durability. Silicone wire sets also offer maximum RFI suppression. Copper core wire sets are for point type

ignition systems only and feature a copper core wire to allow for special improved electrical conductivity and mechanical strength. All wire sets are supplied with electrical boots and OEM style terminals that lock onto the spark plug.

**Copper Core Sets**

- VT No. Fits**  
32-0252 1965-78 FL/FLH/FX/FXE

**VT No. XXX Silicone Sets**

- 32-0253 Universal Application Self Make Kit
- 32-0254 1980-84 FLH, 85-99 FXST, 91-98 FXD



**Spark Plug Wire Clamps** available in pair for 7 or 8mm wires.

- VT No. Size Finish**  
37-9062 7mm Chrome  
37-2911 8mm Chrome



**Accel Thundersport 5mm Ignition Wire** features half the diameter of stock wire and is extremely flexible. Easy to run through cylinder heads, rocker covers and frame tubes for a hidden look. Packaged with two 5 foot leads, coil ends and 90° spark plug end. Coil end must be terminated. These wires are a 5 mm high gloss silicone wire that is rated for over 550° F and 150 ohms per foot.

- VT No. Color**  
32-9360 Black  
32-9361 Yellow  
32-9362 Red  
32-9363 Blue



**Spark Plug Wire Tool** strips 7 and 8 mm ignition wire, crimps spark plug and distributor terminals.  
**VT No. 16-0514**



**Blue Lightning Bug Spark Wire Ends** are neon gas filled, glow as strobe lights. Fit plugs with screw terminal fittings only, pair.  
**VT No. 32-1552**

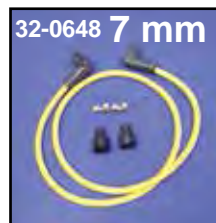
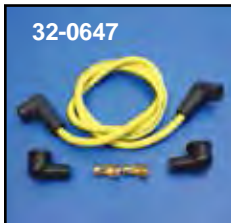

**Universal Wire Sets** are 40" long with double 90° spark boots. Simply cut to the desired length and install coil terminal clips supplied. Available in copper or suppression core.

- VT No. Color Type**  
32-0647 Yellow Suppression  
32-0648 Yellow Copper  
32-0650 Orange Copper  
32-0651 Black Suppression  
32-0696 Black Copper  
32-7133 Red Copper, 5 pack  
32-1123 Red Copper





# Spark Plug Wire Set

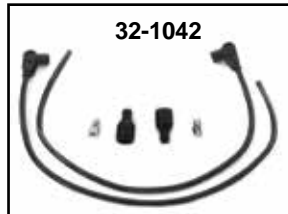

**Sifton 8 mm Universal Wire Set** feature suppression construction cut 40" to length style.

**VT No. Color**

**32-1041 Red**

**32-1042 Black**



**42" Accel 8.8 Wire Sets** have the ends terminated with a 90° or a variangle boot and come with a hardware kit which includes terminals, boots and instructions.

**VT No. Color Type**

**32-9248 Black Variangle Suppression**

**32-9250 Black 90° Suppression**

**32-9252 Yellow Variangle Suppression**

**32-9253 Yellow Variangle Copper**

**32-9254 Yellow 90° Suppression**

**32-7536 Yellow 90° Copper**



**Sumax Thunder Volt 50 Black Wire Sets** feature a ferrite spiral wound coated core that is a blend of copper/nickel alloy bonded by a conductive acrylic latex cover. This process is designed to reinforce and assist in holding core resistance to 50 ohms. The fat 10.4 mm (.409") wires also feature three layers of pure zimplex silicone, 600 degrees of heat protection, 102,000 volts dielectric strength with a tightly woven heat treated fiberglass braid and black pro boots bonded to the black with gold lettering wires. Available in 8.2 mm or 10.4 mm.

**8.2mm 10.4mm Fits**

**32-5202 32-0031 1971-84 FX**

**32-5208 32-5608 24" Universal two-piece with 90° boots**

**32-5206 32-0033 1980-84 FLT-FLTC-FLHT**



**Accel 8.8mm Custom-Fit Ignition Wire Sets** are available in 300+ or custom fit.

**300+ Custom Fit**

**Black Yellow Black Type/Fits**

**32-9100 32-0654 32-8043** Late 1978-84 FLH,  
Late 1978-84 FX-FXE-80,  
1983-84 FXWG

**32-9101 32-0653 32-8045** 1965-Early 78 FL-FLH,  
1971-Early 78 FX-FXE

**— 32-0657 32-8049** 1980-84 FLT-FLHT-FLHTC

**8mm V-Twin Wire Set**

**— 32-0660 — 1965-83 FL-FX**



**Vintage Wire Kit** includes brass eyelet ends. 40" overall length with coil terminals and boots.

**VT No. 32-0973**



**Sumax by Taylor Colored 8mm Plug Wires** are pre-cut and have the plug/coil boots and terminals already installed. Designed for electronic ignition, but work great on point types.

Color	1965-84 FX-FL	1982-94 FXR	1980-98 FLT
Red	32-7231*	—	32-7233
Blue	32-7631*	—	—
Black	32-7031*	32-7035	32-7033
Yellow	32-7431*	—	—

**\*Note:** with coil adjacent to oil tank on Dynaglide.

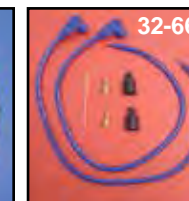
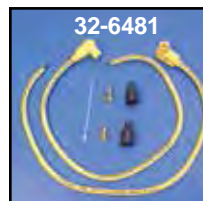
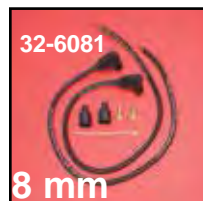

**Universal 8mm Pro Spark Plug Kits** feature 24" wire leads with either 90° or 180° molded plug boots and straight coil boots with brass terminals. Wires feature the Spiro-Pro design which provides ten times the firepower of carbon core wires and heat protection to 600F. Works with electronic or points style ignition. All wires have a resistance factor of 350 ohm/ft. Great for magnetos, distributors or dual plug heads.

**90° Kits Color 90° Kits Color**

**32-6081 Black**

**32-6681 Blue**

**32-6281 Red**

**32-6381 Purple**

**32-6481 Yellow**

**32-6085 Black (180° Kit)**





# Spark Plug

Champion Spark Plug Application Chart						
Engine	Fits	HD#	Gap	Copper Plus Champion	Qty	Copper Plus VT No.
Shovel 1340	1982-83 FL-FX	5RL	.040	RN13LYC	6	32-7541
	1980-81 FL-FX	5R6A	.040	RN12YC	4	32-7540*
	1984 FXE-FXWG	5RL	.040	RN13LYC	6	32-7541
Shovel 1200	1978-79 FL-FX	5R6A	.040	N12YC	4	32-7602
	1975-80 FL-FX	5R6A	.040	RN12YC	4	32-7540*
	1948-74 FL-FX	3-4	.025	RJ12YC	4	32-7543
	1948-74 FL-FX		.025	RJ14YC	4	32-8074**
Panhead	1948-65	3	.025	J-6-C	4	32-7603

**\*Note:** RN13LYC may also be used  
**\*\*Note:** One heat range hotter than stock replacement plug



**V-Twin Performance Spark Plugs** features a copper core electrode for a longer service life, nickel plated housing, 95% pure alumina insulator and a heat crimping process to ensure a leak free seal.

VT No.	Mfg#	Fits
32-6692	5R6A	1984-98 Evolution
32-6693		As Above One Heat Range Hotter
32-6694		As Above One Heat Range Colder
32-6695	3-4	1948-74 Pan/Shovelhead



**Accel Spark Plugs** are available in U-Groove or Platinum type. U-Groove features a U-shaped electrode, sintered alumina insulator and a copper/nickel alloy electrode. Platinum type features a platinum tip electrode and a pure copper center electrode.

Engine	Fits	Accel No.	Gap	Plug	U-Groove	Platinum
Shovel 1340	1982-84 FL-FX	2417	.040"	997	32-0148	32-9244
	1978-81 FL-FX Hotter	2410 2410A	.040"		32-0144	—
1200	1975-80 FL-FX-FXS with Electric Ignition	2410 2410A	.040"	496	32-0144 32-0146*	—
	1975-77 FL-FX-FXS without Electric Ignition (Hotter)	2403A	.025"	116		32-9237



**Bosch Spark Plugs** sold in pairs. Available in Super type. Features copper core, nickel, plated electrode and polished threads. Fits 1200 Engine, 1948-74 FL and 1971-74 FX. #3-4.

VT No. 32-1222



**SplitFire Spark Plugs** incorporate a patented Split -V Electrode which creates an aggressive flame kernel for improved combustion efficiency. Spark plug is for standard heat range. Fits 1948-74 Shovelhead.

VT No. 32-8923



**Spark Plug Indexer** fits 14mm plugs allows electrode to be placed for in proper position.

VT No.	Item
16-0623	Tool
16-0676	Index Washer, 30 Assorted



**Chrome Sparkies** to fit perfectly on a spark hex for Big Twin 14mm, pair.

VT No.	Fits
37-8952	1948-1999
32-1670	1999-2012



**Autolite Platinum Plugs**, sold as a pair.

VT No.	Autolite#	Fits
32-9231	AP4265DP2	1978-81 1340cc All Models 1975-80 1200cc FLH-FX-FXE-FXEF-FXF
32-9234	AP4275DP2	1948-74 1200cc All Models

**Autolite Standard Spark Plugs**

10 pack	Pair	Autolite#	H-D#Fits
32-9296	—	4275	3-4 1948-74 Panhead, Shovel
—	32-9298	4265	5RL 1975-84 Shovelhead 5R6 5A6A



**HeliCoil Sav-A-Thread** repairs spark plug holes for 14mm short or long reach plugs on aluminum heads. Includes items pictured. No drilling necessary.

VT No.	Item	U/M
16-0044	Complete Kit	Kit
16-0043	1/2" Insert	Each
16-0042	3/4" Insert	Each



**HeliCoil Spark Plug Insert** replace stock inserts in 1966-74 Shovelhead. Replaces 16725-66A, sold each.

VT No. 16-0043



# 18mm Plugs

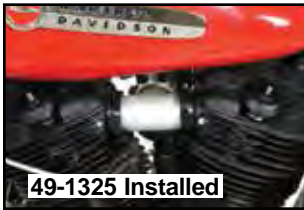
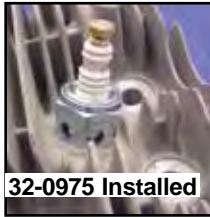

**49-0796**  
**Replica 18 mm Spark Plug Set Air Cooled Type** fits Side Valve 1936-47 Overhead Valve.  
**VT No. 49-0796**



**18mm Spark Plug Conversion Nipples** feature replica air cooled styling when used with standard D-16 inner plug, available separately. Pair.

VT No.	Item
32-1080	Kit/Plugs/Cool
32-0975	Kits with Plugs
49-0976	Conversion Set
32-7546	D-16 Plugs (6 pack)
49-1325	Shield Set

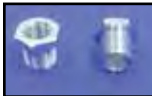

**Adapter Set** allows plugs to be used in earlier heads with spark plug threads.

VT No.	Adapts
32-0057	18mm to 14mm
32-0272	7/8" to 18mm



## 18mm Spark Plugs.

VT No.	Brand	U/M
32-7546	Champion	6
49-0796	Replica	2
49-0980	Globe	2
49-0878	VL-JD	2
49-0880	F	2
15-1376	Washer	5
32-1353	Nuts	2

## 18mm Spark Plug Tool

features a parkerized finish and is for use with OE Harley 18mm plugs. Designed to fit within the slots in order to disassemble the plugs.

**VT No. 16-1383**

**Spark Plug Holder** features original Atlas design to hold spark plugs. Bolts to replica battery top.

**VT No. MM**

49-0624	18mm
49-0733	14mm

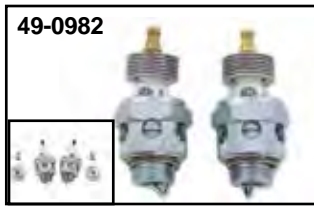

**49-0624 installed**



**Spark Plug Holder** clamps to the rear frame tube on Rigid Big Twins. Holds two spark plugs.

**VT No. Finish**

42-0318 Chrome

42-1537 Black

**Beck Patch.**

**VT No. 48-1642**



**48-1642**

## 18mm Plug Kit with tops.

VT No.	Tops	Top Set
32-1080	Alloy	49-0176
49-0982	Alloy fins	32-1231
49-0477	Brass fins	49-1325
49-0448	Black	
16-0372	Tool	







# Electric Start Kit

Electric Start Kits, V-Twin  
Original Development since  
1978!

**Electric Start Conversion Kits** fit Big Twin 4-Speed model 1965-84. Kits include Hitachi or Prestolite starter, chrome battery box, solenoid, starter housing, relay, related hardware and brackets. Existing clutch drum must have starter ring gear attached or purchased and installed separately. Battery side cover and top strap not included. Chrome kits include a chrome starter motor and a chrome solenoid.

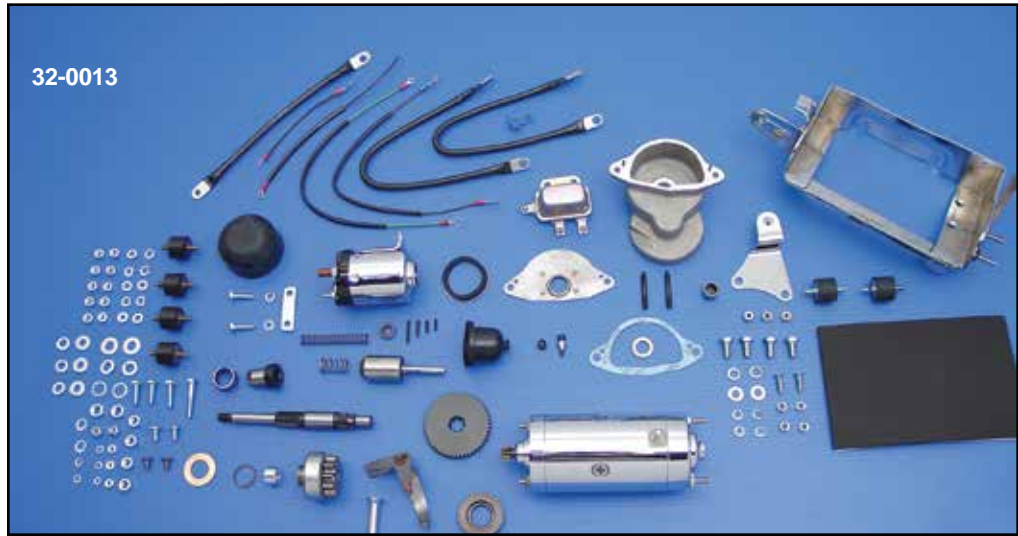

Standard	Chrome	Type	Model	Year
32-0005	32-0013	Prestolite	FLH	1965-69
32-0000	32-0007	Hitachi	FXE	1971-79
32-0014	32-0015	Hitachi	FXE	1980-84
32-0001	32-0009	Prestolite	FLH	1970-79
32-0016	32-0017	Prestolite	FLH	1980-81
32-0018*	32-0019	Hitachi	FLH (Belt)	1982-84
32-0004	32-0008	Hitachi	FXB	1980-84

\*Note Fit Belt/Chain Drive.



**Starter Ring Gears** for replacement on stock clutch drums only. Fits 1965-E84 Big Twin, 66T, Weld on. **Note:** Bevel edge is for welding (outside) teeth side.  
**VT No. 18-1135**

## Starter Cover

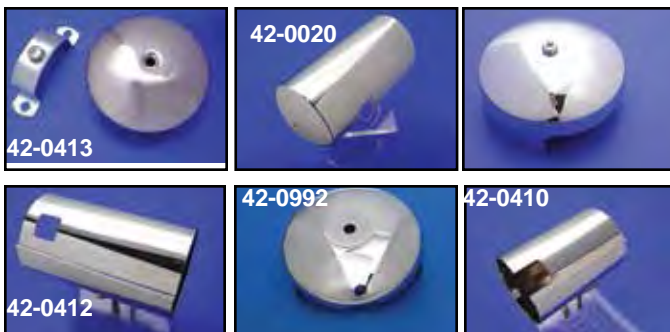

### Chrome Starter Covers.

VT No.	OEM	Type	Model
42-0413	31565-67	End	Prestolite 1967-80 FL Hitachi 1973-80XL
42-0872	31524-80	End	Prestolite 1981-85 FL
42-0992	31535-91	End	1991-up Big Twin
42-0020	31507-87T	Wrap	5-Speed 1984-88 FLT 1986-88 FXST, 83-88 FXR
42-0412	31350-83T	Wrap	Prestolite 1966-82 FL
42-0410	31351-83T	Wrap	Hitachi short 1974-E76 XLH



32-5122



32-5123

1.4 kw

**Hitachi Type High Torque Starter Motor** features 1.4 kw design that generates more power and shaft speed than original type .8 kw starter.

**VT No. Finish**  
**32-5122** Black  
**32-5123** Chrome



**Hitachi Starter Hardware Kit** includes brushes, holder, springs, thru bolts and insulator commutator end bushing for 1973-88 Big Twin.  
**VT No. 32-0553**



**Chrome Starter Motor Brackets.**  
**VT No. OEM Fits Year**  
**31-3948** 31479-83 FXR 1983-89  
**31-0233** 66098-82 FLH 1982-E84  
**31-0164** 66225-73 FXE 1973-84

# Hitachi Starter Motor



**Complete Hitachi Type Starter Assembly** available in black or chrome finish.



32-7761



**Hitachi Type Starter** is a replica for 1974-88 FXE, 1982-84 FL, 1983-88 FXR-FLT and 1984-88 FXST. Parts interchange with original, 5" overall body length.

**VT No. OEM Item**  
**32-7760** 31570-73 Complete, Black  
**32-7761** 31570-73 Complete, Chrome  
**32-1307** 31570-73 Complete, Black  
**32-0306** 31580-73 Armature  
**32-0307** 31582-73 Brush Set  
**32-0308** 31579-73 Field Coils  
**32-0059** 31576-73 Thru Bolts  
**12-0347** 31583-73 Bearing, Drive End  
**32-0553** Rebuild Kit



Includes Brushes, Holder, Springs, Thru Bolts, Insulator, Com. End Bushing



**Starter Brush Spring** for Hitachi Starter Motors 1973-80.  
**VT No. OEM Years**  
**13-0223** 31593-73 1973-80  
**13-9157** 31557-81 1981-up, Compression

# Prestolite Starter Motor



32-7525



32-7524

**Prestolite Type Starter Motor** replaces Prestolite starter used on 1966-81 FL models. Chromed unit is completely chromed. 6" overall body length.

**VT No. OEM Item**  
**32-7524** 31458-66A Complete, Chrome  
**32-7525** 31458-66A Complete, Black  
**32-1308** 31458-66A Complete, Black  
**32-0303** 31542-66 Armature  
**32-0680** 31540-66 Field Coil Set  
**32-0592** 31535-66 Thru Bolts  
**12-0325** 31539-66 Bearing

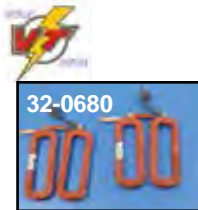

**Prestolite Starter Motor Repair Kit** fits L1966-82 FL (except 82 Classic), L1966-73 GE (servicar). Includes all parts pictured.

**VT No. OEM Item**  
**32-7539** Kit Complete.  
**32-0301** 31537-66 Brush Holder  
**32-0302** 31541-66 Brush Set  
**13-0120** 31534-66 Springs, 10 pack



32-5121

1.4 kw



32-5120

**Prestolite Type High Torque Starter Motor** feature 1.4 kw design that generates more power and shaft speed than the original type .8 kw starter. 32-0289 includes housing to mount to 1965-79 Big Twin.

**VT No. Finish**  
**32-5120** Black  
**32-5121** Chrome



**Chrome Starter Motor Bracket.** Replaces 31476-66. Fits 1966-84 Big Twin, Prestolite.  
**VT No. 31-0148**





# Starter Housing

1982-84 FLH Classic

1980-84 FXSB

1965-84 FLH-FXE 4-Speed

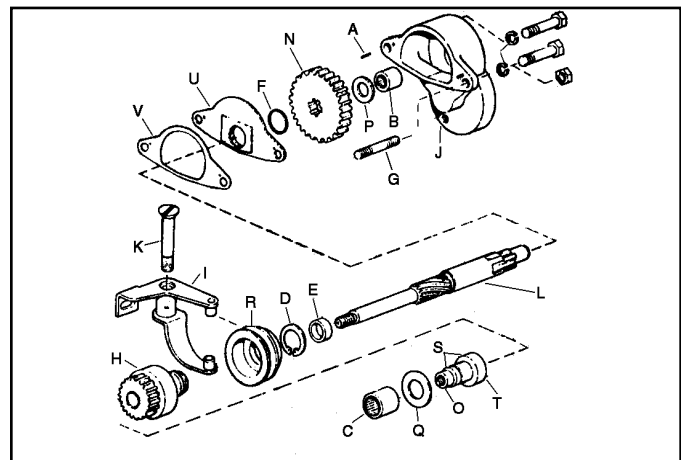
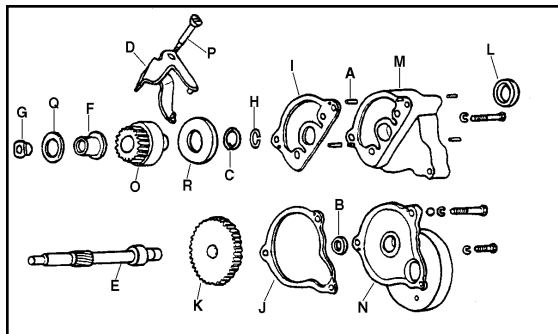

**Starter Shaft Related** for 1982-84 FLH classic, 1980-84 FXSB with Hitachi Starter.

**Starter Shaft Related Parts** fit 1965-84 FX-FLH 4 Speed model. Starter housing fits chain drive models only.

VT No.	#	OEM	Item
43-9153	A-R	Kit	1980-84 FXSB 1982-84 FLH
12-1174	A	334A	Roll Pin
12-0317	B	9062	Housing Needle Bearing
12-0934	C	11039	Retaining Ring
17-9991	D	31300-80A	Gear Shifter Lever
17-0019	E	31310-80A	Starter Shaft
17-9985	F	31311-80	Spacer, Shaft
12-0569	G	31312-80	Shaft Nut
12-9916	H	31313-80	Retaining Ring
15-0655	I	31320-80	Housing Gasket
15-0656	J	31321-80	Cover Gasket
17-9938	K	31340-80	Shaft Gear
14-0156	L	31341-80	Oil Shaft
17-9992	M	31387-80	Housing, 1982-84 Classic
17-9993	N	31397-80	Housing Cover
32-0639	O	31443-65A	Bendix Drive
17-1506	P	31478-65A	Pivot Bolt
17-1504	Q	31502-65	Thrust Washer
17-1502	R	31503-65	Shift Collar

VT No.	#	OEM	Description
43-9150		Kit	1965-69 Prestolite
43-9151		Kit	1970-84 Prestolite
43-9152		Kit	1970-84 Hitachi
12-1174	A	334	Roll Pin
12-0317	B	9062	Housing needle bearing
12-0318	C	9063	Cover needle bearing
12-0934	D	11039	Collar retainer ring
17-0088	E	11041	Shaft spacer
14-0501	F	11101	O-Ring deflector plate
12-2111	G	24811-59A	Housing Stud Stud, Pair
12-1147			Accel Starter Drive
32-0638	H	31443-65A	Gear Lever
17-1507	I	31445-65	Housing 1965-E79 FL Prestolite 1971-72 FX
43-9120	J	31465-65	1973-79 FXE Hitachi 1979-up FX Hitachi, 80-83 FLH L1979-84 FLH Prestolite
43-9121	J	31572-73	Pivot Lever Bolt
43-9122	J	31572-79	Pivot Lever Bolt, Chrome
43-9123	J	31465-79	Starter Shaft, 1965-69
17-1506	K	31478-65A	Starter Shaft, 1970-84
17-1511	K	31478-65A	Gear, Starter Shaft
17-9900	L	31482-65	Nut, Starter Shaft
17-0085	L	31482-70	Housing Thrust washer, 65-69
17-1508	N	31485-65	Thrust washer outer cover
17-0081	O	31493-67	Shifter Collar 1965-69
17-1503	P	31501-65	Shifter Collar 1970-84
17-1504	Q	31502-65	Nut/Spacer Left Hand 1965-84
17-1502	R	31503-65	Spacer 1965-82
17-1505	R	31503-70	Oil Deflector Plate
17-0084	S	31530-65A	Gasket plate
17-9936	T	31531-69	P, C, L, R, D, E, Q, G, S; 1965-69
17-0509	U	60516-65A	P, C, L, R, D, E, Q, G, S; 1970-84
15-1064	V	60559-80	
17-0237		Kit	
17-0238		Kit	



**Primary Case Saver** protects inner case and starter housing area which is damaged by drive chain. Reinforced nylon.  
VT No. 19-0415



# Starter Housing Kits

**Starter Housing and Hardware Kits** include housing, shaft, gear, arm, pin, starter drive and related mechanical hardware only. Note: Starter and electric components not included.

VT No.	Model	Type
43-9151	1970-84 Big Twin	Prestolite
43-9152	1970-84 Big Twin	Hitachi
43-9153	1980-84 FXSB	Hitachi
	1982-84 FLH	



## Starter Shafts and Spacers.

VT No.	OEM	Fits
17-0085	31482-70	1970-84 Big Twin
17-0019	31310-80A	1982-86 Big Twin with rear belt drive
17-9983	33120-79	1980-85 FLT-FXR
17-0084	31530-65A	1965-84 Big Twin, Nut/Space



# 1965-88 Housings



**Starter Shaft Housings** are available as kits that include bearing and mounting bolts or as  **housings only**.

Housing Only	VT No.	OEM	Starter	Model
Kit	32-0990	43-9120	31465-65	Prestolite 1965-Early 79 FLH, 1971-72 FX
	12-1147	—	Studs	As Above
	32-0991	43-9121	31572-73	Hitachi 1973-Early 79 FXE
	32-0992	43-9122	31572-79	Hitachi Late 1979-84 FXE, 1980-83 FXWG
	32-0993	43-9123	31465-79	Prestolite Late 1979-82 FLH

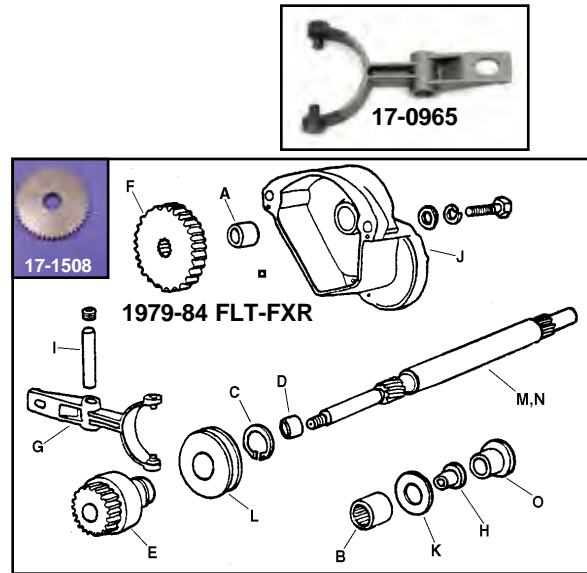

**Starter Drive** features high strength five roller clutch, stainless steel springs, hardened ramped clutch receivers, premium bronze bushing and factory pre-lubing. 1965-88 Big Twin. Replaces 31443-65A.

VT No.	Brand
32-0638	Accel Heavy
32-0639	Volt Tech
32-2506	Volt Tech Heavy Duty
32-1097	Drive Kit



**Starter Shaft Assemblies** include shaft, drive nut, collar, bearing and thrust washer. Drive not included. Order starter drive separately.

VT No.	Year	Model
17-0237	1965-69	FL
17-0238	1970-84	FLH
	1973-84	FXE
17-0239	1980-84	FXB
	1982-84	FLH
17-0240*	1985-88	FLT-FXR

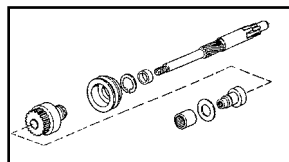

**\*Note:** Order appropriate housing to complete assembly  
**\*Note:** 5 Roller Starter Drive  
 17-0241 1984-85 FXST  
 17-0242 1986-88 FXST

## Starter Related Hardware.

VT No.	OEM	Item
43-9165*	Kit 1979-84	A, B, C, D, E, G, H, I, K, L, M
17-0240*	Kit 1985-88	As Above
12-0317	9062	A Housing Needle Bearing
12-0318	9063	B Cover Needle Bearing
12-0934	11039	C Starter Motor Retaining Collar
17-0088	11041	D Starter Shaft Spacer
32-0638	31443-65A	E Bendix Drive
17-1508	31485-65	F Gear, 1980-85
17-0965	Steel	G Shift Lever, Starter FLT-FXR
17-0081	31493-67	H Nut for Shaft
17-9987	31495-79	I Pivot Pin FLT-FXR
17-9988	31497-79	J Housing, 1980 FLT
17-9989	31497-81	J Housing, 1981-Early 83
17-9990	31497-83	J Housing, 1983-85
17-9995	31572-86	J Housing, 1986-88
17-1504	31502-65	K Thrust Washer
17-1502	31503-65	L Shift Collar
17-9983	33120-79	M Starter Shaft, 1979-84 FLT-FXR
17-9984	33121-79	O Spacer, Shaft, FLT-FXR
17-9985	31311-80	O Spacer FXST

**\*Note:** Order appropriate housing to complete assembly.

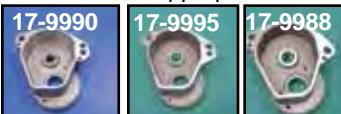

**FLT Starter Housing.** Order bearing separately.

VT No.	Year
17-9990	1983-85
17-9995	1986-88
17-9988	1980 only
12-0317	Bearing





# Starter Solenoid



**32-0697 Starter Solenoid Kit** fits 1965-84 FL-FX and 1984-88 FXST models. Kit includes chrome or zinc solenoid, outer and inner rubber boot, foam gasket, bolts and spacer.

VT No.	Finish
32-0697	Zinc
32-0698	Chrome



**32-0699 Starter Solenoid** replaces 71469-65 used on 1965-84 FL-FLH models.

VT No.	Brand	Finish
32-0699	Volt Tech	Zinc
32-0633	Accel	Zinc
32-0632	Accel	Chrome



**5-Speed Starter Solenoid** replaces 31489-79. Fits 1979-88 FLT's and 1982-88 FXR's.  
**Note:** 1984-88 5-Speed FXST use 4-Speed style solenoid.

VT No.	Finish	Brand
32-0636	Zinc	Accel
32-0637	Chrome	Accel
32-0986	Zinc	V-Twin
32-1055	Chrome	V-Twin

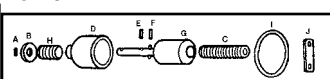

**32-7571 Solenoid Plunger Hardware** fits 1965-88 solenoids.

VT No.	#	OEM	Item
32-7571		Kit	All Listed
12-1176	A	255	Roll Pins
12-1177	F	600	Roll Pins
12-1178	E	601	Roll Pins
12-1180	E	614	Roll Pins
32-0590	G	31435-65A	Plunger
13-0118	H	31438-65A	Over-Run Spring
32-0591	B	31439-65	Retainer, 1965-84
13-0119	C	31440-65	Return Spring
28-1997	D	31441-65A	Plunger Boot
32-0318	J	31452-65	Spacer, each
15-0181	I	60645-65	Gasket



**Volt Tech Starter Drive Kit** includes snap ring, thrust washer, fork arm pivot bolt and high strength Volt Tech starter drive.  
**VT No. 32-1097**



**32-0956 Installed**



**The Lever Starter System** is made from CNC billet aluminum and assembled with accurate components. Unit fits 4 speed electric start models from 1965-88 with separate starter solenoid. This hand operated system will always work. It mounts in the place of the starter solenoid; just pull the lever and go.  
**VT No. 32-0956**

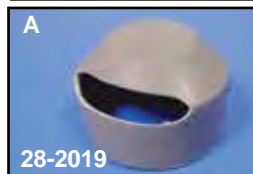
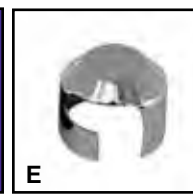
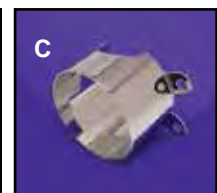
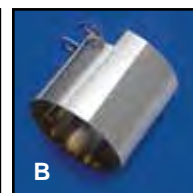

**Chrome Solenoid Body Covers.**

VT No.	#	OEM	Years/Models
28-0117	A	31475-77	1965-88 Big Twin, Black
28-2019	A	31475-77	1965-88 Big Twin, Grey
42-0401	B		1965-82 Big Twin
42-0089	C	94886-83TA	1965-84 FX-FL 4-Speed 1986-88 FXST-FLST 5-Speed
42-9928	D	94869-87	1980-88 FLT-FLHT-FXR 5-Speed
42-0400	E	End Cover	1965-88 FL-FXE-FXR-FLT
42-0025	F	31355-88	1979-88 5 Speed FXR-FLT



**Accel Solenoid Rebuild Kit.** provides complete overhaul for 71469-65 and 31489-79 solenoids, stock and aftermarket.  
**VT No. 32-0634**



# Starter Relay

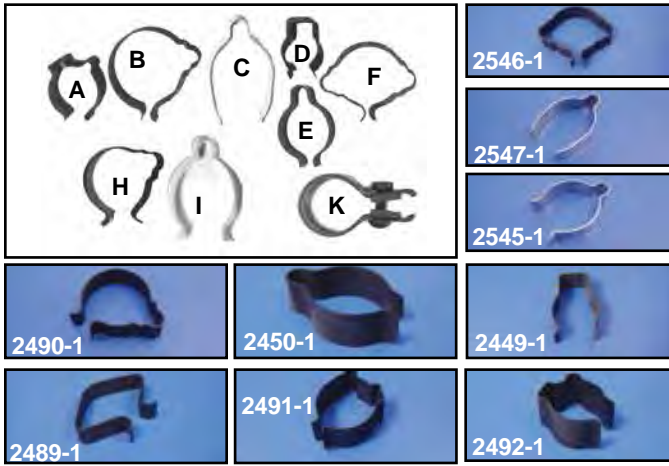

**Control Cable/ Wire Loom Clips** are of formed spring steel with parkerized finish, sold each. Check parts book for proper fitment.

Colony	VT No.	#	OEM	Fits
2546-1	32-0558	F	9977A	1950-60 Big Twin Neck
—	32-0347	B	9977	1936-49 Big Twin Neck
—	32-0351	C	9977-46	1946-47 Big Twin Bull Neck
2547-1	32-0361			1946-E47 Big Twin Bull Neck
2545-1	—	I	9977-46A	L1947 Big Twin Bull Neck
—	32-0348	A	9983	1936-57 Big Twin Taillight Left Upper Frame Tube
2490-1	—	H	4728-30A	Big Twin & 45 Center Post, 1 1/4"
2491-1	—	E		Brake Light/Battery
—	32-0350	G	9976	45 Rear Frame, 4 pack
—	32-0356	D	1602-30	1" Inner Diameter Handlebar
2450-1	—	E	9979	1936-69 Big Twin Front Frame Leg (Generator Wire)
—	37-0268	K	56626-37	Timer Cable 1937-46, 1 1/8" ID
2449-1	—		9976	Cable Clamp
2450-1	—		9979	Wire Clip
2489-1	—		10012	Frame Head 1961-84
2492-1	—		4727-23	Wire Clip

**37-8129 Vinyl Coated Cable Clamps** can be mounted to frame fork or fenders to help route cable wires or brake lines. Mount hole available in 1/4" or to fit #10 screws (.200).

VT No.	Qty	Inner Diameter	Mount Hole
37-8128	10	1/4"	1/4"
37-8129	10	3/8"	1/4"
37-8132	10	1/2"	1/4"
37-8904*	25	7/16"	.200"
37-0832	5	3/8"	.200"

\*Note: Uncoated.

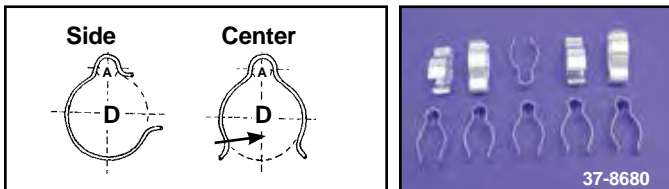

"D" is the diameter of the tube it fits. "A" is the size wire/loom that it secures.

**Control Cable Clamps** are zinc plated spring steel, pack of 10.

VT No.	D-Tube Size	A-Cable Size
37-8677	1" Side	3/16"-7/32"
37-8678	1 1/4" Side	3/16"-7/32"
37-8679	1" Center	3/16"-7/32"
37-8680	1" Center	5/16"
37-8681	1 1/8" Center	5/16"

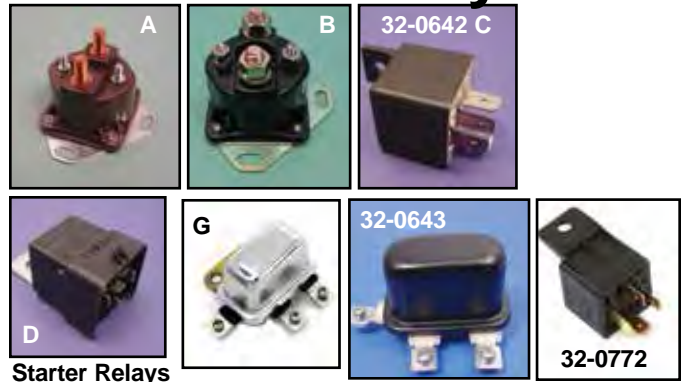

## Starter Relays

VT No.	#	OEM	Fits
32-0640	A	71463-73A Accel	1974-79 FL, 85 FX Late 84-E85 FLT-FXR
32-0641	B	71463-73A	As Above V-Twin, Replica
32-0642	C	31506-79	1980-90 All Accel
32-0738	D	—	As Above with Weather Proof Skirt
32-0643		71455-67	1967-E68, L71-74 XL
32-0185	G	71455-67	1967-E78 Replica

**Start Boost Relay** will boost voltage in single fire ignition applications during cranking will allow full battery voltage to the module and coil.  
**VT No. 32-3000**



## Starter Relay Connectors

VT No.	OEM	Fits
32-8036	72046-79C	1979-up All Twins
32-8041	4-lug	1973-78 All Twins when using 1979-90 type starter relay
32-8042	5-lug	As Above

**Note:** 32-8036 includes crimp style connector ends and 32-8041 and 32-8042 includes pigtail harness.

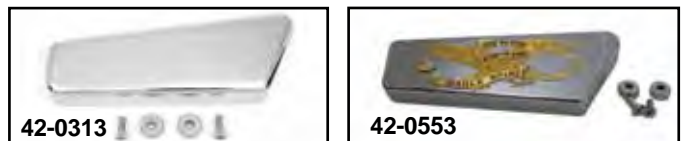

**Chrome Starter Relay Cover Kit** includes hardware. Replaces 66425-68. Use on 1965-84 FL-FLH.

VT No.	Style
42-0313	Smooth
42-0553	Gold Inlay Spirit

**Ground Clamp** attaches to oil line on 1936-40 models, each.  
**VT No. 31-0275**

**Zinc Plated Strap Clamps** with 3/32" hole, are sold in 10 pack.

VT No.	U Size
37-9141	9/16"
37-9139	7/16"
37-9142	5/8"





# Switch

## 1982-95 Switch Kit

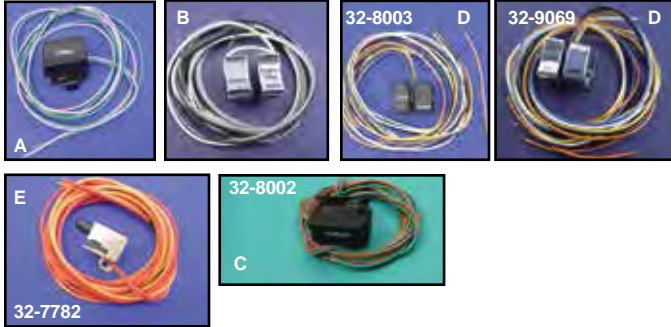

**1982-95 Handlebar Switch Kit** includes complete right and left switch assemblies, brake light switch, mounting screws and clips.

Black	Chrome	OEM	Item
32-8000	32-9070	71599-92	(A) Left turn signal
32-8001	—	71589-92	(B) Engine, Stop-Start
32-8002	—	71591-92	Right turn signal
32-8003	32-9069	71597-92	Dimmer and Horn
32-7782	—	71590-92	(E) Stop switch, front
32-8084	32-9208	Kit	1982-up Switch Kit includes A, B, C, D, E

**Hardware for Above, Note: Finish is not black**  
 37-8966 — 2907 25 screws pack, zinc

## 1972-81 Switch



**Handlebar Switches** for 1972-81 models. Available with or without wire. **\*Note:** 32-0395 is 5 pack.

W/o wire	W/o wire	With wire	OEM	Type	Style
10 pack	Each	Each			
32-0395*	32-0403	32-8933	71546-75A	Hi-Low	Rocker
32-0391	32-0404	—	71483-72	Plain	Rocker
32-0394	32-0402	32-8931	71547-75A	Run-off	Rocker
32-0392	32-0406	32-8930	72001-69B	Brake	Button
32-0393	32-0405	32-8919	71484-72A	Starter	Button
32-0393	32-0405	32-8920	71484-72A	Horn	Button
32-0408	—	—	71535-72	Long	Button
32-0407	—	—	71534-72	Short	Button

Cap 5/16" 1972-E1973  
 3/16" L73-81

**Switch Control Assortment** for 1972-81 models saves time and money on dimmer, starter-horn button hardware. Note quantities supplied. Included are the following:

**VT No. 32-0320 for entire assortment**

Qty	OEM	Switch	Qty	OEM	Switch
2	71546-75A	Hi-Low	10	71535-72	Long
6	72001-69B	Brake	10	71534-72	Short
2	71547-75A	Run-off	2	71482-72	Plain
6	71484-72A	Starter & Horn			



**Universal Toggle Switches.**  
**VT No. Type**  
 32-0423 On/off with leads  
 32-9030 Spotlamp On/off without leads

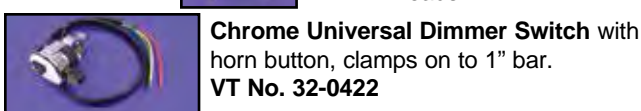

**Chrome Universal Dimmer Switch** with horn button, clamps on to 1" bar.  
**VT No. 32-0422**



**V-Twin Replica Handlebar Horn Dimmer and Directional Switches** feature cloth covered original style wiring, chrome plated housing and stainless screws. Army style are O.D. painted.

VT No.	Volt Tech	OEM	Type	Position/Style
32-1261	—	71800-26A	2 Wire	Tall
32-0574	—	71800-26	1 Wire Horn	Short
32-0554	—	71800-26A	2 Wire Horn	Short
32-0447	32-1263	71800-26	1 Wire Horn	Short
32-0542	—	—	Chrome Horn Button	—
32-0555	32-1262	74840-29	Dimmer	2
—	32-1354	74840-29	Dimmer, Army	2
32-0556*	32-1354	70058-50B	Directional	3
32-0573	32-1264	70058-50	Directional	3
32-0533*	32-1265	70058-50B	Dimmer	2

**\*Note:** With side exit wires. **\*\*Note:** Does not include wires.



**A-Chrome Button For Handlebar.** Use for horn and start switch with PVC wires. Replaces 71800-26A.

VT No.	OEM	Item	Wire
32-0400	71800-26A	Horn	2 wire
32-0557	71800-26A	Horn	1 wire
32-0344	71800-26A	Parkerized, Horn Button	2 wire
32-0442	71800-70	Starter	2 wire
37-0531	2626	Stainless Mount Screws for Above	—

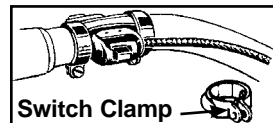

**Switch Clamp** replaces 10001, to attach switch to 1" handlebars.

**VT No. Item**  
 32-1354 Switch Kit  
 32-0397 Clamps



**Chrome Handlebar Switch** available in 2 or 3 position type with PVC covered wires. 2 position type used for Hi/Low beam. 3 position type features off in middle and can be used for Hi/Low beam or turn signal. **\*Note:** Has Side Exit Wires.

VT No.	Type
32-0401	2 Position without wires
32-8085	2 Position with wires
32-0398	3 Position
32-0370*	3 Position
32-9125*	2 Position
37-0531	Stainless Steel Mount Screws for Above

**\*Note** Has side exit wires.





# Switch



**6 Post FLH Cast Ignition Switches** include cover and two keys for 1973-84 FL's, cover installed as noted.

**VT No. Brand Top**  
**32-0419** VT Cast Top  
**32-8078** Replica Cast

**Hardware**  
**37-8917** 2625 Mount screw, 7015 washer, 24 pack



**5 Terminal Replica Switch** include a replica cover and Briggs and Stratton key set with corresponding number lock.

**VT No. Year Finish**  
**32-1635** 1936-46 Brass  
**32-1637** 1947-67 Brass  
**32-1510** 1947-67 Chrome  
**32-1524\*** 1936-46 Chrome  
**32-1511** 1968-72 Chrome  
**32-1426** Top Cover Chrome

\*Note: Early type fits 1936-46 cat eye dash base.

**Chrome Electronic Ignition Switch** has smooth action & dependability of electronic switching. Eliminates original pole to bar contacts found in original equipment switch. Helps withstand vibration and corrosion, 6-pole type. Replaces 71501-73. Includes two keys and chrome switch cover.  
**VT No. 32-8070**

**Hinge Switch** features round key set. Fits 6 post, 1973-95. Rear hinge.  
**VT No. Type**  
**32-0480** Contact  
**32-0482** Electronic

**Switch Covers** fit FLH dash switch, chrome finish.  
**VT No. Year/Type**  
**32-0396** 1936-67 Steel  
**32-1343** 1936-67 Chrome  
**32-1382** 1926-37 Brass  
**32-0399** 1967-up Diecast  
**49-0278** 1936-67 Pin

**Late Dash Plate Ignition Switch Spacers** for spacing dash base and switch in relation to tanks, packs of 10.

**VT No. Size Type**  
**39-0420** .030 Dash  
**39-0421** .060 Dash  
**39-0422** .120 Dash  
**39-0118** .040 Switch



**Chrome Switch Brackets.**

**VT No. Years Model**  
**31-0150** 1978-84 FXE-FXS  
**31-0151** 1936-84 Transmission Mount Big Twin  
**42-0525** 1982-90 FXR  
**31-0262** Universal



**Mechanical Switches.**

**Smooth Chrome Type Key Year**  
**ChromeSkull**

**32-0449 32-1191** 5 post Flat 1968-72  
**32-0481 32-1196** 5 Post Round 1947-72  
**32-0419 32-1192** 6 post Flat 1973-95  
**32-0480 32-1199** 6 post Round 1973-95



**Flat 6 Post Electronic**

**ChromeBlack**  
**32-8109 32-1193** Chrome 1973-95  
**32-9267** Smooth S.S. 1973-95  
**32-0482 32-1194** Round 1973-95



**Chrome Black**

**32-0241 32-1198**  
**32-0455\*4527-36** Replica 1936-46  
**32-0418** 71501-36 Steel type 1948-67  
**32-8077** 71501-36 VT 1948-67  
**32-0481** Side 1948-72  
**37-8916** 2589 Terminal wire screw and washer, 24 pack  
**32-1271** Component Kit 1936-67  
**32-1144** Key Lock Tumbler 1936-47  
**32-1147** Key Lock Tumbler 1948-67  
**37-8917** 2625 Bob Switch Mount Screws & 7015 Washers, 24 pack



**Chrome Stock Key Switch** for ignition and light switch for Super Glide. Used on all FX-FXS, 1982-94 all FXR. Includes two keys and mounting ring.

**VT No. Type Year**  
**32-0161** Replica 1977-98  
**32-0416** Stock Type 1977-98  
**32-0175** Replica 1973-76

**Universal Key Switch** includes mounting ring and two keys.  
**VT No. Type 32-0478** Off/On Start  
**32-0415** On-Off-On **32-1266** Off/On Start  
**32-0478** Off-On-Start  
**32-0479** Off-On-On

**Weld On Ignition Mount** accepts 32-0161 switch.  
**VT No. Item**  
**32-0180** Set  
**32-0820** Collar

**Hi-Low Beam Switch Relay** will allow the Hi-Low beam to be switched from one beam to another using one wire momentary horn type button.  
**VT No. 32-0448**





# Switch

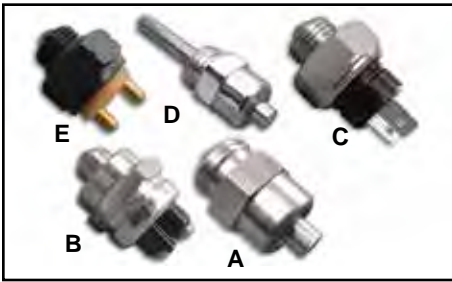

**Neutral Switches** are replica type, replaces the following FLH-FX models.

VT No.	#	OEM	Type	Fits	Speed
32-0417	A	33900-59	Stud	L1973-E79 1979-98	4 5
32-9065	A	As Above	USA		
32-0501	B	71507-64A	Replica	1965-70	4
32-0539		71507-64B		1965-70	4
32-0500	C	71507-71	Blade	1971-78	4
32-0043	D	33901-79	Plunger	1979-84	4
15-0685		34043-80	—	Gasket (10)	
15-0217		25811-11	—	Gasket (10)	



**Hydraulic Brake Switch** features heavy duty contacts and quality brass terminals.

VT No.	Type	Years	Brand
32-0425	Screw	1951-70	V-Twin
32-0434	Screw	1951-70	Accel
32-0426	Flag	1971-92	V-Twin
32-0435	Flag	1971-92	Accel



**Brake Light Switches** are pull type.

VT No.	OEM	Item	Years
32-0430	72003-34	Kit, chrome	1936-57 Big Twin Rigid
32-0438	72004-39	Kit, chrome	1939-52 45"
15-0378	72015-39	All	Gasket
13-0227	—	Pull Wire	1939-52 45
37-9013	42280-75 42284-35	Clamp and Pin	
2503-4	—	Mount Kit	All



**Replica Kits** fit Big Twin 1936-57.

VT No.	Finish
32-7604	Black
32-7605	Chrome
32-1230	Switch Only, Parkerized Partial
32-1179	Bracket
32-1188	Body/Bracket
32-1281	Body Complete
33-1179	Switch Bracket, Parkerized
33-1180	Housing Only

**Hi-Low Beam Switch Relay** will allow the Hi-Low beam to be switched from one beam to another using one wire momentary horn type button.

VT No. 32-0448

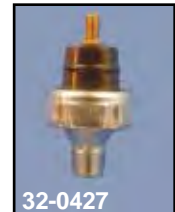

**Oil Pressure Switches** are precision calibrated.

VT No.	OEM	Year/Model
12-1401	26550-38A	1939-68 45
12-1402	26551-39	1939-68 Big Twin
32-0586	26551-39A	1952-58 Big Twin
32-0282	26557-39B	1958-69 Big Twin
32-0427	26552-72	1941-84 Big Twin
32-0818	Wire	1970-up Big Twin



**Oil Pressure Switch Fitting** replaces 26569-58 for Big Twins. Allows use of 1/8" NPT switch 32-0427 in early motors.

VT No.	Year/Model
12-1403	1958-64 FL
40-1421	1936-40 EL, Parkerized, extension

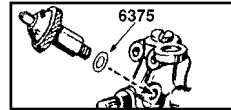

**Sealing Washers** for Oil Fitting, Pressure Switch, Relief Valve, Check Valve, and Tappet Oil Screen in brass

VT No.	OEM	Fits	Type
14-0031	6156	1941-69 Big Twin	Adjuster Screw
14-0032	6581	1954-78 Big Twin	Relief Valve Plug
14-0033	6377	1950-99 Big Twin	Oil Pump Seal Washer, 5 pk
14-0178	6375	1946-57 Big Twin	Pressure Switch and 45 Banjo line

# Flasher



**Flashers** for turn signal indicator lights.

VT No.	OEM	Item
33-0399	68543-64A	Round
33-0848	10 pack	Round
33-0916	68543-64C	Round Solid State
33-0397	68541-64	(4 way)
33-2198	As Above	Rectangle, Replica
33-2173	As Above	Rectangle, Plastic
33-0938	LED	12 volt
32-8925	Mount Flasher	
33-0398	68543-61A	6 volt
12 Volt 2 Pin Flasher Units		with built in bulb failure indicator.
33-2350		10 Watts
33-2351		21-23 Watts



# Circuit Breaker

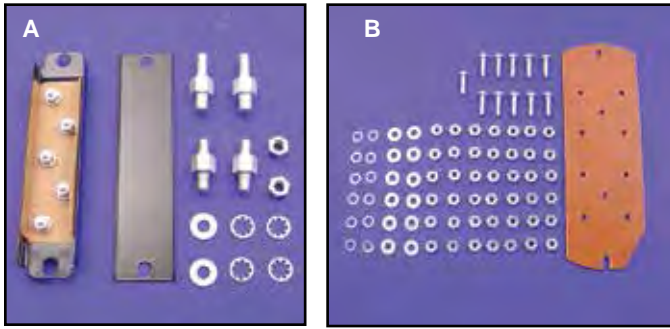

**Terminal Boards (A)** is preassembled, painted and properly insulated to eliminate grounding. Includes mounting studs. (B) Fiber terminal plate mounts to forks behind headlight on FLH.

VT No.	#	OEM	Fits
8005-12	A	72325-48	1948-69 Big Twin and 45
32-0321	B	72301-49	1949-57 Big Twin
32-0357	B	72301-49A	1958-69 Big Twin
8823-10*		72341-48	1948-55 Mount Studs
8824-8		72341-56A	1956-82 Mount Studs

\*Note: Studs attach terminal board and coil mounts. **8823-10**



**Frame Electrical Terminal Screws & Fittings** replaces 1523-26A on 1936-47 Big Twin and 45's. Includes insulators, screws and nuts. **VT No. 8942-14**

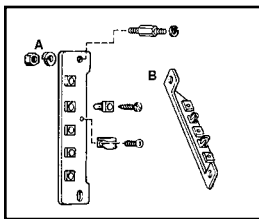

**Electrical Terminal Plates** are pre-assembled for main junction which includes studs for mounting coil and auxiliary junction for headlamp wiring.

VT No.	#	OEM	Type	Model
9639-22	A	72300-70	Main	1970-77 Big Twin
9817-15	B	72303-70	Headlamp	1970-74 FX

**Ground Clamp** attaches to oil line on 1936-40 models, each. **VT No. 31-0275**

## Terminal Board



**Terminal Blocks** with terminal studs. 10-24 thread.

VT No.	Terminals
32-0502	4
32-0880	8
32-0879	12
32-0878	16



Terminal Block fits 1973-84 FLH.

VT No.	OEM	Item	Year
31-0484	72310-70	Bracket	1970-84
32-9246	72312-73	Terminal Block	1970-84



**Shrink Wrap Tubing.** Cut to length, thread the wires, carefully apply heat and watch the insulation shrink to a perfectly fit around the wires. Easy to use, 4 foot length only.

VT No.	Inner Diameter	Length
32-0124	1/4"	4'
32-0125	3/8"	4'
32-8039	5/8"	4'

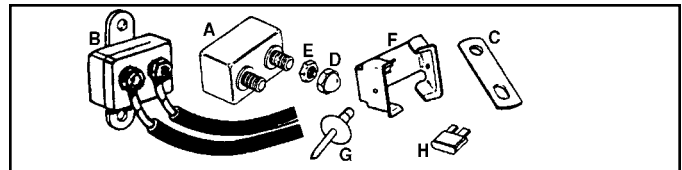

**Circuit Breaker** are stock replacements.

VT No.	#	OEM	Amp	Fits
32-0458		74586-70	30	1970-72 FL
32-0412	B	74594-71	20	1971-72 FX
32-0414	A	74589-73	15	1973-up FL, FX
32-0413	A	74559-77	30	1978-up FL, FX
32-8921	C	74598-73		Connector Bar, each
32-8922		69999-77		Connector Bar, each
32-8945		7/8" C/C		Connector Bar, pair
37-9069	D	7602		Nylon Nut, 1/32", 25 pack
12-0581	E	7629		Nut, 25 pack
31-9952	F	9952		Mount Clip, 10 pack secures breaker or flasher to fender
31-9964	G	8672		Rivet for Above



**Circuit Breaker Bracket** available for 2 or 3 circuit breakers, allows standard 15 or 30 amp breakers to snap firmly in place. Bracket has 1/4" holes 5" apart. Can be mounted to oil tank bracket or fender.

VT No.	Circuit Breakers
31-0493	2
31-0490	3



**In-Line Fuse Holder** has 6" long wire leads.

VT No.	Type
32-0410	Fuse
32-8946	ATC Type

### Warranty

All Electrical Components sold as individual pieces or in kits are covered under our warranty "Replacement Only" Provision. All electrical related item part numbers begin with a 32 prefix. No credit will be issued for these items as they are exchange only.





# Wiring



32-0715

**1970-up Wiring Kits** feature plastic wire in original factory color codes, with all terminals applied, in vinyl loom. Complete "Builders kits" include handlebar, taillight, coil and regulator wires, denoted by an \*. All other harnesses are

main harness only. Handlebar and taillight must be purchased separately for these kits. Main harness include the main turn signal wires.

## 1970-up PVC Covered Wires

### FL-FLH

VT No.	OEM	Application
32-0714*	70320-70	1970-72 FLH
32-0715*	70320-73A	1973-77 FLH
32-7569*	70320-78	1978-79 FLH
32-7568*	70320-80	1980-84 FLH

### FX-FXE-FXST-FLST

32-7550*	70326-71	1971-72 FXE
32-7551*	70326-73A	1973-74 FXE
32-7584*	70326-75	1975-77 FXE
32-9066	70353-78	1978-79 FXS
32-9074	70343-78	1978-79 FXE
32-8014	70214-80A	1980-85 FXWG
32-8091	69543-80	1980-84 FXS-FXB
32-1118	69545-82A	1982-Early 84 FXR-FXRS-RT



32-0705



32-7555

**Early Twins Wiring Harness Kits** are complete and feature cotton braided wire and asphalt loom.

VT No.	OEM	Application
32-7581	—	1916-28 JD Electric Model
32-0700	4735-30	1930-36 VL-RL
32-0701	4735-36	1936-37 WL-UL and FL
32-0703	4735-38A	1938-46 WL-UL-G and FL
32-7555	4736-42M	1942-45 Army 45
32-0704	70320-47	1947 WL-UL-G and FL
32-0705	70320-48	1948-57 UL-EL-FL-FLH & WL
32-0706	7032-58	1958-64 FL-FLH
32-0707	70321-65	1965-69 FLH

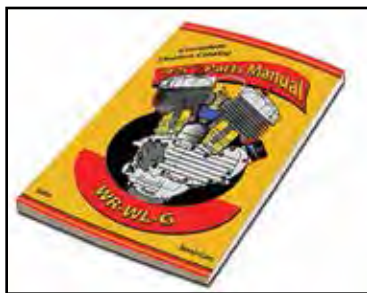

**45 Parts Book** is a 288 pages for 45 models. For WLA 1941-1944. VT No. 48-0488

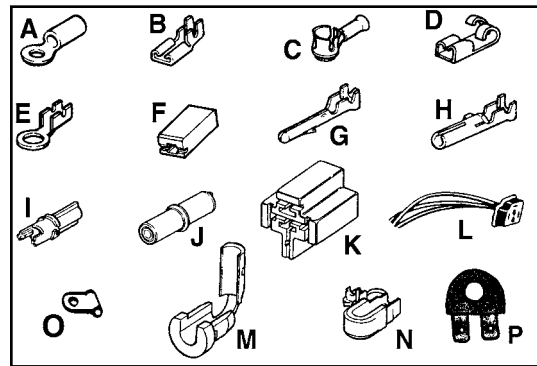

## Wire Terminal

### Ring Type Terminals.

VT No.	#	OEM	U/M	Item	Gauge
32-8015	A	9856	25	#6 eye	16-22
32-8016	A	9871	25	#6 eye	14-16
32-8017	A	9857	25	#10 eye	16-22
32-8018	A	9902	25	#10 eye	14-16
32-8019	A	9866	25	#10 eye	10-12
32-8020	A	9858	25	1/4" eye	16-22
32-8021	A	9862	25	1/4" eye	14-16
32-8022	A	9863	25	5/16" eye	14-16
32-8023	E	9945	25	5/16" eye	10-16
32-8101	A	9859	25	3/8" eye	16-22
32-8103	A	9868	25	3/8" eye	10-12
32-8104	A	9892	25	9/16" eye	14-16

### Flag Type Terminals

32-8025	B	9904	10	1/8" Female Spade
32-9303	C	9905	5	Big Twin Neutral Switch
32-8027	B	9914	10	1/4" Female Spade
32-8028	D	9925	10	1/4" Right Angle Female Spade
32-8026	B	9930	10	3/16" Female Spade
32-8029	F	71774-77	10	Female Spade Insulator
32-8024	O	9901	25	5/32" Flag
32-8106		9907	10	1/4" Spade Insulator 16-22 gauge
32-8107		9885	10	1/4" Spade Insulator 16-22 gauge

### Pins and Sockets

32-8030	G	72039-71	10	Pin
32-8031	H	72038-71	10	Socket
32-8032	I	72043-71	10	Single Pin Insulator
32-8033	J	72044-71	10	Single Socket Insulator
32-8036	K	72046-79	1	Starter Relay Connection
32-8037	L	72047-71	1	Head Lamp Connection
32-9333	M	72501-74	1	Harness Bushing Straight



32-8037

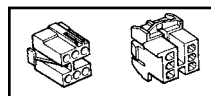

### Connector Blocks.

VT No.	OEM	Type
32-8032	72043-71	Single Pin Insulator
32-8033	72044-71	Single Socket Insulator
32-9095	72035-71	2 Pin Insulator
32-9094	72034-71	2 Pin Socket Insulator
32-8034	72041-71	6 Pin Insulator
32-8035	72037-71	6 Pin Socket Insulator
32-9097	70294-87	10 Pin Insulator
32-9096	70293-87	10 Pin Socket Insulator
32-9033	72276-74	12 Pin Insulator
32-9034	72278-74	12 Pin Socket Insulator



### Regulator Connector Fittings.

VT No.	OEM	Item
32-9092	72051-77	Regulator Plug
32-9090	74539-77A	Regulator Connector Socket



# Harness Component

**Replica Wiring Harness /Dash Base Assemblies** include complete harness pre-wired to dash base, five or six post key switch, terminal box, horn button, dimmer switch, headlamp connection, speed lamp socket and front terminal board when required. Switch and wiring are tested after final assembly.

VT No.	Type	Year/Model	Generator
<b>Generator Models</b>			
39-0190	2-Light	1947 Big Twin	3 Brush
39-0189	2-Light	1948 Big Twin	3 Brush
39-0182	2-Light	1949-57 Big Twin	3 Brush
39-0183	2-Light	1958 Big Twin Neutral	2 Brush
39-0181	2-Light	1959-61 Big Twin, Neutral	2 Brush
39-0188	3-Light	1962-64 Big Twin	2 Brush
39-0184	2 Light	1939-46 Big Twin	3 Brush

**Big Twin Electric Start Models**

39-0185	3-Light	1965-67	2 Brush
39-0186	5-Light	1968-69	2 Brush
39-0196	5-Light	1970-71	
39-0197	5-Light	1972 only	
39-0187	5-Light	1973-77	
39-0198	5-Light	1978-79	
39-0199	5-Light	1980-84	

**PVC Covered Taillight Wires** fit 1970-up.

32-9309	1970-72 FL, 1971-72 FX, 1973-77 FL
32-9310	1973-77 FX-FXE
32-9311	1978-84 FL
32-9313	1978-84 FX-FXE



**Accessory Kits.**

VT No.	OEM	Type
32-1078	70209-41	Ground Wire, BT
32-7549	—	1952-64 Turn Signal Kit, Cotton
32-0524	—	1958-84 Turn Signal Kit, PVC
32-9205	—	1965-84 Big Twin Small Starter Wire Set, PVC
32-0163	70165-58	Battery Box to Ground 1965-69 Big Twin
32-0323	70018-77	Relay to Solenoid Wire
32-0158	70169-70	Relay to Ground Wire



**Early Wiring Components** are cloth covered wire in 25 foot length and harness loom asphalt type in 10 foot length.

Wire	Color	Loom	VT No.	Size	Item
32-8094	Black	32-8098	3/16"	inner diameter	Loom
32-8095	Red	32-8099	1/4"	inner diameter	Loom
32-8096	Green	32-8900	3/8"	inner diameter	Loom
32-8097	Yellow				
32-1813	Set of 4				



**25 Feet of Braided Wire.**

32-8120	Pure Red	32-8125	Pure Yellow
32-8121	Pure Black	32-8126	Red with Yellow Dot
32-8122	Pure Green	32-8127	Red with Blue Dot
32-8123	Pure Blue	32-8128	Black with Red Dot
32-8124	Blue with White Dot	32-8129	White with Blue Dot
		32-8131	Yellow with White Dot



**Note: Order the appropriate factory service manual to facilitate wire harness installation.**

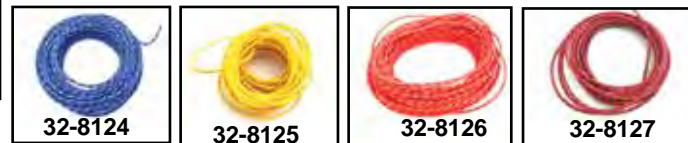

CLASSIC





# Alternator Kit



**22 Amp High Output Alternator Kits** fit all 1988 and earlier models. Stock on all 1983-88 models. Replaces 29982-81. **VT No. 32-7776**

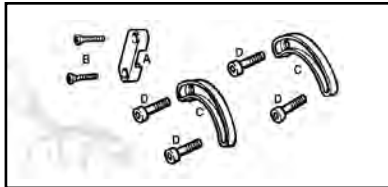

**Stator Assembly Kit** for Big Twins 1970-88 includes (2) 29988-73 locks, (1) 29954-71 retainer, (4) 2653 screws and (2) 2216W screws.

VT No.	#	OEM	Item
32-0598		Kit	Complete, all
32-0604	A	29954-71	Nylon Retainer, 10 pack
32-0603	B	2216W	Screw, 10 pack
37-8812	C	29988-73	Lock Plate, 10 pack
37-8811	D	2653	Screw, Fillister, 10 <sup>7</sup> / <sub>8</sub> "
37-9003	D	2712	Screw, with Lock Patch, 7 <sup>7</sup> / <sub>8</sub> "
37-9126		2720	Screw, with Lock Patch, 1"



Unmolded



Molded

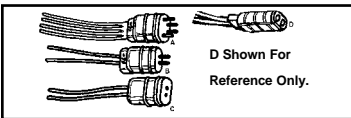

D Shown For Reference Only.

**Plug End & Wire Only.**

VT No.	#
32-0593	A

**Stators** replace stock units for models listed in molded (M) or unmolded (U) type.

VT No.	Brand	Pin	Type
<b>1970-75 Big Twin, Replaces 29965-70, 18 Amp</b>			
32-8082	Volt Tech	A	Unmolded
32-9039	Accel	A	Unmolded
<b>1975-80 Big Twin, Replaces 29965-75, 18 Amp</b>			
32-0601	Volt Tech	B	Molded
32-9040	Accel	B	Molded
<b>1981-88 Big Twin, Replaces 29965-81, 22 Amp</b>			
32-0602	Volt Tech	C (USA)	Molded
32-8081	Volt Tech	C	Unmolded
32-9042	Accel	C	Unmolded
32-9041	Accel	C	Molded

### Warranty

All Electrical Components sold as individual pieces or in kits are covered under our warranty "Replacement Only" Provision. All electrical related item part numbers begin with a 32 prefix. No credit will be issued for these items as they are exchange only.



32-7781



32-0776



32-0796



32-7500



32-7807



32-0775

**"Volt Tech" Alternator Kit** fits 1970-95 Big Twins. It includes stator, rotor with stainless liner "to seal magnets in place" except VT No. 32-7500 chrome regulator and mount kit.

VT No.	Stator	Amp
32-7781	Molded	18
32-0776	Open	22
32-0796	Molded	22
32-7500	Molded	22
32-7807*	Open	32
32-0775	Open	32

\*Note: Reinforced rotor spline



32-0758



32-0759

**Alternator Rotors** feature vibration proof magnet construction, as magnets are held in place by stainless steel non-magnetic insert for durability. \*Note: Reinforced Spline Area.

VT No.	Year	Model	Amp
32-0758*	1970-90	FL-FX	23/32 Amp
32-0759	1976-99	FL-FX	32 Amp



**Hobbs Meter** for calculating engine running time for 12 Volt 2 Cylinder applications.

**VT No. 32-1809**



# Regulator



Black



Alloy

32-0609

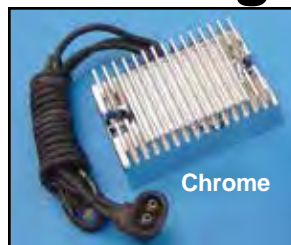

Chrome



32-0780



**Volt Tech™ And Accel Solid State Regulators** feature rugged aluminum alloy construction. Accel brand is available in chrome, alloy or black stock finish with polished top fins or Volt Tech is available in black or chrome finish. They provide more accurately regulated voltage under all electrical loads. All units listed carry the full replacement warranty by Accel or Volt Tech.

Accel Black	Accel Alloy	Accel Chrome	Volt Tech Black	Volt Tech Chrome	Replace OEM	Lead #	Fits
32-8060	—	32-0797	32-0614	—	74510-70A	38"	1 1200 1970-75 FL-FLH, 1971-75 FX-FXE 12V/15 Amp Alt.
32-8061	32-0609	32-0850	32-0615	32-0778	74512-79A	57"	2 1200/1340 1976-80 FL-FLH,-FLH 80 FLT Classic 1976-80 FX-FXE-FXS, 80-FXWG, 12V 17.8 Amp Alt.
32-8067	—	32-0852	32-0667	32-0780	74516-86	57"	3 1340 1981-84 FLH-80 Classic; 81-85 FX-FXE-FXEF-FXS-FXB, 81-88 FLT-FLHT Classic, 82-88 FXR, 1981-86 FXWG 22 Amp.
32-8064	32-0607	32-0857	32-0619	32-0989	—		All 12 Volt Generator Models



**Battery Eliminator** allows operation of Magneto models without battery, boosts spark voltage when starting and prevents light flickering at low engine speed.  
VT No. 32-0548

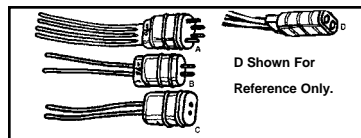

**Plug End and Wire Only.**  
VT No. #  
32-0593 A

# Bracket



**Chrome Die-Cast Regulator Plug Retainer** is for 1970-88 Big Twin models.  
VT No. 31-0737



**Plug Retainer** replaces 45095-85 on all Big Twin

1970-up 74-80 and Evolutions. It secures connector plug to alternator plug which is in engine case and prevents faulty contact.  
VT No. 13-0219



**1970-99 Chrome Die-Cast Volt Pak Cover** fits all stock rectifiers. It is engineered to improve cooling for extended regulator life. The chrome finish reflects engine and exhaust heat. Grooved to interlock with regulator and the regulation.  
Cover has 20% more fin area than stock.  
VT No. 42-0405



31-0857

**Chrome Alternator Plug Retainer** bolts to the front left engine mount bolt for 1970-up Big Twins.  
VT No. 31-0857

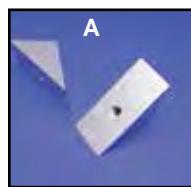

A



B

**Front Engine Mount Blocks** act as nuts for front bolts and will mount regulator.  
VT No. Type  
31-0739 A  
31-0635 B



31-0172



31-0784

**Regulator Mount Brackets** attach to engine mount.  
VT No. Type  
31-0172 Zinc  
31-0784 Chrome



2046-8-P

**Chrome Regulator Mount Hardware Kits.**  
VT No. Fits  
37-9257 76-95 FX-FL, FXST-FLST, Allen  
37-9258 80-95 FXR-FLHT, Allen  
2046-8-P 2000-up Softail, Polished Allen

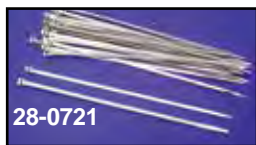

28-0721

Nylon Tie Straps.		Length
Chrome	Black	
25 pack	100 pack	
28-0720	28-0710	4"
28-0721		7"
	28-0711	7 3/4"
	28-0712	15 1/8"



28-0710



31-0168



31-0166



31-1070

**Rectifier-Regulator Bracket Mount.**

VT No.	OEM	Year/Model	Finish
31-0168	74533-75B	1976-86 FX-FL	Chrome
31-0166	74529-79	1979-89 FXR-FLT	Zinc
31-1070	74529-79	1979-89 FLT	Chrome

CLASSIC





# Alternator Generator Conversion

32-1672



COMPACT DESIGN REPLACES EARLY 6 OR 12 VOLT GENERATORS

### Alternator Conversion Kit.

VT No.	Finish	Fits
32-1672	Black	1948-69 FL
32-1675	Chrome	1948-69 FL

32-1675



32-0371



32-0372



**Alternator Conversion Kit** replaces original generator and regulator. Compact, high output alternator, is 3 1/4" long, weighs only 3lbs. Features include high power output, billet housing for strength and accurate alignment, stress proof shaft which is stronger than stock. The kit includes alternator unit in chrome or black, black voltage regulator and instructions. It fits 12 volt 1965-83 XL as well pre 1965 which have been converted to 12 volt electric. Kit can used on earlier models if generator bolt holes in case are drilled out to 5/16". Cannot be used with mini (12N55A-3B) battery.

### VT No. Item

32-7528	Black Alternator
32-0390	Chrome Alternator
32-0667	Replacement Regulator
32-0371	Black Alternator
32-0372	Chrome Alternator
32-1282	12V 32 E
14-0034	Seal

32-0371  
Installed



# Generator

32-0790



32-0787



32-0207



32-0967



**2-Brush Style Generators** with built-in regulators by Cycle Electric or Volt Tech brand. All styles fit 1936-69 FLH including Flatheads. On pre-1958 models, engine case must be drilled to accept 5/16" size mount bolts. Order gear kits separately. Order VT No. 32-0983 for gear kit to complete the installation. Units noted as low output are for use with VT No. 53-0505 mini 12 volt battery.

VT No.	Volt	Type	Finish	Brand
32-0212	12	Low Output	Black	Cycle Electric
32-0790	12	Low Output	Black	V-Twin
32-0787	12	Low Output	Chrome	V-Twin
32-9001	6	Standard	Black	Cycle Electric
32-1539	6	Standard	Black	V-Twin

32-0204 Big Twin Gear Kit 13 Tooth



**2 Brush Generator Gear Kit** is available as complete installation kit. Kit includes gear and deflector nuts. Fits 1958-69 74 FL. 13 Tooth.

VT No.	Item
32-0204	Kit
32-0220	Gear Only



**Solid State Generator Regulator** features die-cast chrome end cover which mounts to all 1965-77, 12 Volt, 2 brush generators. Small solid state regulators fits behind cover for a clean look.

VT No. 32-7757

**2-Brush Replica Generator** by Cycle Electric or Volt Tech. All styles fit 1952-81. Order gear kit separately.

VT No.	OEM	Volts	Type	Finish
32-8999	29975-65A	12V	VT	Black
32-8998	29975-65A	12V	VT	Chrome
32-7526	29975-65A	12V	CE	Black
32-0967	29975-65A	12V	VT	Black
32-0207	29975-65A	12V	VT	Chrome
32-0213	29975-61A	6V	CE	Black
32-0214	29975-61A	6V	VT	Black

**Mount Gasket** fits 1958-84 2 brush generator.

VT No. 15-0150

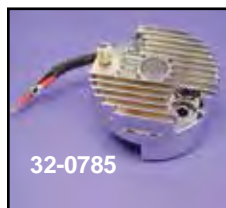

32-0785

**Regulator End Cover** features solid state components in generator end cover. Cover with needle bearing installed is black with fins for all 29975-65A 12 volt and 29975-61A generators.

VT No.	Volt	Type	Brand
32-7768	12	Black	Cycle Electric
32-0795	12	Black	V-Twin
32-0785	12	Chrome	V-Twin
32-9282	12	Low Amp for use with mini battery 53-0505	
32-0786	12	Chrome	V-Twin
32-7767	6	Black	Cycle Electric



32-7762

**Regulator End Cover** by Cycle Electric replaces the units on their generators, VT No. 32-0212, 12 Volt Low Output.

VT No. 32-7762

### Warranty Information

Volt Tech Brand Electrical Products Warranty claims are serviced through our Missouri Facility. Cycle Electric warranty claims are returned to Cycle Electric Co in Ohio. Allow extra time for claims. All electric items will be repaired and replaced at manufacturer's discretion, and no credit will be issued for these returns.



# Conversion System



**Generator-Regulator Conversion Electrical Kit** includes all necessary components to convert a 1936-69 Big Twin to a 12 volt system. Kit includes a 12 volt generator with a built in solid state regulator, mini 12 volt battery, battery box kit which fits in the original 6 volt battery compartment, 12 volt coil, auto advance distributor and generator screws.

**Black Chrome**  
32-0750 32-1165



**3-Brush Generator Gear and Tag Kit** includes gear, gear pin, gear end spring, oil deflector, and brass tag.  
VT No. 32-1877



**Generator-Conversion Kit** includes all parts illustrated including a "look alike" 12v regulator and automatic advance distributor. Converts 6 volt to 12 volt system.

**VT No. Fits**  
32-0766 1930-73 Side Valve  
32-0767 1936-65 Big Twin OHV



**Alternator 12V Conversion Kit** includes alternator and black solid state regulator. Fits 1941-1957 FL, 1936-1952 EL, 1936-1952 W. Order gear kit separately.

**VT No. Item**  
32-1282 Alternator  
32-0204 OHV Gear Kit  
32-1547 Gear Kit





# Regulator & Relay



32-0631



32-1079



32-1310

**Replica Delco Remy 1938-57 Brush Relay** features original internal points contact construction with embossed cover.

VT No.	Finish	Cover
32-1310	Black	Delco
32-0631	Black	Delco
32-0739	Chrome	Delco



**Delco-Remy™ are used under license from General Motors.**

### Wires

32-1079	Black	Delco Remy
32-1319	Wire	Positive
48-1477	Cloth Patch	Delco Remy



32-0056



32-0062

**6 Volt Solid State Relay** includes cover, and allows use of idiot light on all 3 brush generator applications 1926-57.

VT No.	OEM	Year	Brush	Terminals	Cover
32-0056	74750-38	1938-57	3	3	Chrome
32-2056	74750-38	1938-57	3	3	Black
32-0062	4785-26	1926-37	3	2	Black



32-0299



32-7750

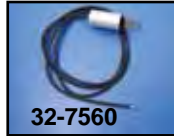

32-7560

**6 Volt Solid State Relay Eliminator** replaces mechanical regulator on 3 brush generators, 1937-57. No more sticking relays and moving parts to wear out. Instructions.

VT No.	Item/Finish
32-0299	Relay Black
32-7750	Relay Chrome
32-7560	Relay Only
32-1545	Replica Solid State Relay with Cover



32-1545



32-0071



32-0067



32-0267



**"Look-A-Like" Relay** is exact shape and size of 6 volt relay and will mount the same. Electronic design will function with 2-brush generators.

Chrome	Black	Volt
32-0071	32-1341	12
32-0067	32-0267	6



32-1341



**Relay Mount** is of cast aluminum to mount relay on 1936-57 Big Twin OHV. **Note:** Must be welded on, drilled and tapped.

VT No. 32-0063



32-1209



32-0623



32-0621



32-0626



32-0995

**Replica Mechanical Regulators** are for generator systems. Each unit features heavy duty shock mounted steel bases, vibration resistant internal wire connections, fiber and Mylar insulated pads and large diameter contact surfaces.

Black	Chrome	OEM	Brand	Volt	Type
—	32-0763	74510-47A	VT	6	2 Brush
32-1209	—	—	Delco	6	2 Brush
32-0623	32-0624	74510-47A	Volt Tech	6	2 Brush
—	32-1340	Kit	VT	6	2 Brush
32-0626	32-0627	74511-65	Accel	12	Bosch Type
32-0625	—	74511-65	Bosch	12	Bosch Zinc
32-0621	32-0622	74510-64	Accel	12	Delco Type
32-0995	—	74510-64	Delco	12	Replica

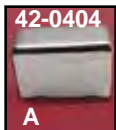

42-0404



42-0442



42-0403



42-0448



42-0058

### Relay and Regulator Covers.

VT No.	#	Type	Year	Finish
42-0404	A	Relay	1932-57	Chrome
42-0053*		Relay	1932-57	Black
42-0448*		Relay	1932-57	Chrome
42-0064*		Relay	1932-57	Chrome
42-0058*		Relay	1926-31	Black
42-0442	B	Regulator	1947-63	Chrome
42-1047*		Replica	1947-63	Black
42-0403	C	Regulator	1964-69	Chrome
42-0539		Replica	1964-69	Delco

\*Note: Replica Delco Remy Style



32-7757

**Solid State Generator Regulator** features die-cast chrome end cover which mounts to all 1965-77, 12 Volt, 2 brush generators. Small solid state regulators fits behind cover for a clean look.

VT No. 32-7757



31-0593

**Chrome Rectifier-Regulator Mount** for 12 volt. Bosch generator.

VT No. 31-0593



31-0207

**Chrome Solid State Regulator Mount** bolts directly to 2-brush generator housings on Big Twin and Sportster models. It fits Accel and V-Twin finned type regulators.

VT No. 31-0207



31-0184

**Replica 1958-69 FL Regulator Bracket** replace 74531-58.

VT No.	Finish
31-0171	Chrome
31-0184	Zinc

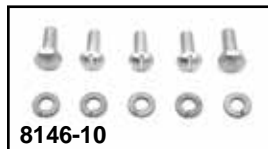

8146-10

**Circuit Breaker Screw** are used to mount distributors and relay on 1936-64, 61, 74 and 80 models, (10 piece).

VT No.	Finish
8146-10	Cadmium
8145-10	Chrome
9684-10	Parkerized
7130-10	Acorn



# 3 Brush Generator Repair

## Generator Cover



### Chrome Generator End Covers.

VT No.	Model	Years
42-0411	3-Brush	1932-57
42-0438	3-Brush	Black
42-1522	3-Brush	Stainless Steel



**Generator Hardware Kits** include gaskets and replacement hardware.

VT No. 32-0228



**Generator Positive Terminal Screw Kit** is a 3-brush type. Fits 1932-57.

VT No.	Brand
2126-12	Colony
32-1235	VT Complete



**Generator Gear Kit** is available as complete installation kit. Kits include gear, deflector nuts and proper pieces for application. 1932-57, 3-brush OHV, 14 teeth. VT No. 32-0205



**1937-57 45 and UL Generator Gear Parts.**

VT No.	OEM	Item
32-0550	31071-37	14 T Gear
12-1214	325	Gear Pin
32-0240	Kit includes Gear, Pin, Spring and Dust Shield	
32-0216	31035-31	Deflector



### Generator Gears Only.

VT No.	OEM	Tooth Use
32-0218	31070-30	14 Big Twin, 1936-57 Overhead Valve
32-0550*	31071-37	14 Big Twin, 1937-57 Side Valve
12-1185	327	Gear Pin
12-1214	325	Gear Pin, Replica
13-0165	31040-31	Gear Spring, 1930-57

\*Note: With Slinger



**Generator Gear Puller Center Cap** use with claw type pullers. OEM# 95636-46. VT No. 16-0638

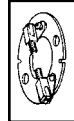

**Generator Brush Holder**  
VT No. 32-0211

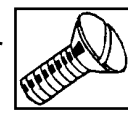

**Pole Screw**  
VT No. 9520-4

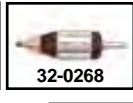

**Generator Brush Holder.** Includes springs.

VT No.	OEM	Item
12-0302	9005	Bearing, Rear
12-0303	9007	Bearing, Front
32-0191	—	Oil Retainer
12-0583	1210	10-32 - 5/8" Screw, 10 pk
32-0197	Positive	Brush Holder
32-0273	Negative	Brush Holder
32-0211	30385-32	Brush Holder, 3rd
2863-7	—	Negative Brush Holder
2126-12	—	Position Terminal Screw Kit
32-0166	30012-32	Frame Screw, pair
9520-4	30280-18	Pole Screw Kit
9520-4T	—	Pole Shoe Kit
12-0700	6743	.030 Armature Shim
12-0701	6743A	.060 Armature Shim
32-0216	31035-31	Oil Deflector
14-0112	30145-46	Seal
32-0223	30851-32	Armature (32E)
32-0268	—	Armature (32E)
32-0232	30425-32	Brush Set (32E)
32-0233	30425-51	Brush Set (52E)
32-1535	30206-32	Replica Field Coil Set (32E)
32-1852	30206-32	Field Coil Set (32E)
32-1237	—	Field Coil Set (32E)
32-1853	30201-52	Field Coil Set (52E)
32-0087	9900	Field Coil Wire Term.
32-0165	—	Generator Body
32-0831	—	End Housing
32-0834	—	Pole Shoe Set
32-0977	—	Pole Shoe Set
32-1538	Tag	Brass
<b>Kits</b>		
32-1878	—	Tag Kit
32-0275	Tag	With brushes
32-1546	—	Kit
32-0265	—	Bearing House Kit
32-0215	—	Complete Generator
32-0165	—	Bearing House Kit
32-1546	—	Kit
32-1119	12v	32 E Complete
32-8116	12v	Generator Bearing Housing
32-1148	—	Bearing End House
32-0088	—	Generator Strap
32-0089	—	Generator Strap Screw Set
32-0092	—	Generator Fram
32-0195	—	3-Brush Generator Inner Oil Retainer
32-0196	—	Positive Terminal Screw with fittings



**Installation instruction for VT No. 32-1852 3 brush 32E field coils.**  
**Regulating Coil:** Green and Black Wires. **Green Wire** to positive brush (relay) terminal. **Black Wire** to third brush swivel terminal.  
**Shunt Coil:** Red and Black Wires. **Red Wire** to negative brush terminal. **Black Wire** to light switch terminal.



### Generator Gaskets

VT No.	James	OEM	Item
15-0217	15-1143	25811-11	Generator stud washer for 1911-85 FL, XL
15-0226	15-1021	30138-30	1937-48 Generator End Cover
15-0287	15-1022	30143-30	1930-57 Generator to Case
15-0586	—	Pair	1930-57 Generator to Case



### Generator Mount Strap Chrome is for 3-brush type.

VT No.	#	OEM	Years	Model
31-3955	A	30025-30	1932-52	45 and Side Valve
31-3957	A	30025-36	1936-57	Big Twin Overhead Valve
49-0056	A	As Above	—	Parkerized
8214-7*	B	Mount Kit	All	Cadmium
9681-7*	B	As Above	—	Parkerized
31-1323	—	Kit	—	1936-57 OHV

\*Note: Includes screw, shims and washers.





# 2-Brush Generator Repair

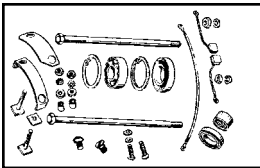

**Generator Rebuild Kit.** Complete as shown, all small parts necessary for rebuilding a 6 or 12 volt, 2-brush generator.

**VT No. 32-0431**

2-Brush Generator Components are available separately.

VT No.	OEM	Item
32-0164	30012-58	Bolt (2)
32-0234	30426-58	Brush Set
32-0231	29913-82	Brush Set, Hitachi
12-0581	7634	Terminal Nut
12-2120	30280-58	Pole Screw
32-0209	30350-58	6 Volt Brush Holder
32-0210	30450-66	12 Volt Brush Holder
13-0117	30453-58	Brush Spring, 10 pack
12-0303	9007	Gear End Bearing
12-0304	9007	Gear End Bearing (Open)
10-2553	30148-58	Brush End Cover Bushing
12-0319	9064	Brush End Cover Bearing
12-0902	11004	Front End Retaining Ring
14-0112	30145-46A	Shaft End Seal, 1958-81



**2-Brush Generator Gear Kit** is available as complete kit. Kits include 13-tooth gear, oil deflector, washer hex nut. Fits 1958-69 74 FL.

VT No.	Item	Fits
32-0204	Kit	BT
32-1363	Gear	Servi
32-0220	Gear	BT
32-1245	Spacer	5 pack



**Replica 2-Brush Field Coils** feature warp-free laminates and heavy copper core winding. Set is matched pair with lead.

VT No.	OEM	Type	Volt
32-0229	30201-58A	58/61	6
32-7599	30201-65	65	12
32-0434	2 Brush		12



**Generator Case Mount Gasket** fits 1958-69. 2-brush.

VT No.	Finish
15-0150	10
15-0565	2



**Generator End Brush Band** for 1966-80 2-Brush generators replaces 30475-66 with bolt.

VT No.	Finish
32-0199	Chrome
32-0200	Black



**Generator Parts.**

VT No.	Item	Years
32-0217	Oil Deflector	1958-81
32-0219	Washer	1958-69

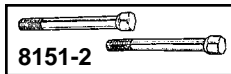

**Generator Mounting Screws.**

*For 1936-57 Big Twins Overhead Valves*

Chrome	Cadmium	Parkerized	Brush	Style
8151-2	8152-2	9679-2	3	Stock
8753-2			3	Allen

**Generator Screw Kit (Phillips) for 1950-54**

2097-2	2098-2	3	Stock
--------	--------	---	-------

*For Big Twin 1958-69 with Hex*

8153-2	8154-2	2	Stock
7113-2		2	Acorn
8754-2		2	Allen



**Replica Generator Armatures** feature heavy copper windings on precision shafts with solid copper commutator. \*Note: Replica style.

VT No.	OEM	Volt	Model	Brand
32-0224	30851-65A	12	1965-69 FL	V-Twin
32-0225	30851-61	6	1961-64 FL	Accel
32-0226	30851-58	6	1958-60 FL	V-Twin
32-0222*	30851-65A	12	1965-69 FL	V-Twin

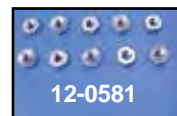

**Generator Terminal Nuts** replace 7634, on all generators 1930-up, (10 pack).

VT No.	Type
12-0572	Brass
12-0581	Steel with star washer



**Generator 2-Brush Hardware Kits** include gaskets and replacement hardware as shown.

**VT No. 32-0227**



**2-Brush Generator Terminal Kits** include nuts and insulators. Fits 1958-69.

**VT No. 2127-11**



**Generator 2-Brush Set** fits 1958-69 Replaces 30426-58.

**VT No. 32-0234**

## Tech Tip: 12 V Upgrade



Use HeliCoil 16-0920 kit to convert 12 volt generators with 5/16 - 24 thread to 1/4 - 24 thread to accept early mount bolt set.



# Battery Carrier



**Battery Carrier Kits** fit stock frames with bracket and Iso-Mounts included as required. All units are chrome except where noted. Order battery top cover and strap kit as noted separately.

VT No.	Model/Year	Cover Kit
42-9915	1965-69 FL	42-5516
42-9909	1965-69 Black	42-5516
42-9910	1970-79 FLH	42-5517
42-9911	1980-84 FLH	42-5517
42-9913	1971-78 FX, black	42-5515
42-9912	1973-79 FXE	42-5518
42-9917	1980-85 FXE	42-5518



Rubber Iso Mount has 1/4 - 20 threads on each end.

VT No.	Type	Quantity
28-0749	Hex	2
28-0636	Lord	2



**Chrome Battery Carrier Brackets.**

VT No.	Year	Model
31-0187	1965-84	FLH
31-0940*	1965-85	FLH
31-0164	1973-84	FXE
31-4186	1971-78	FX

\*Note: Bright finish

# Battery Box 1936-64

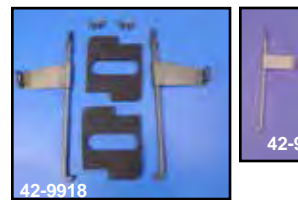
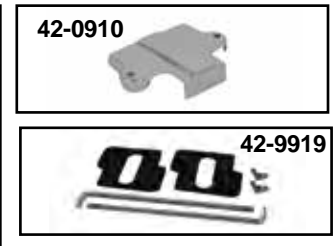
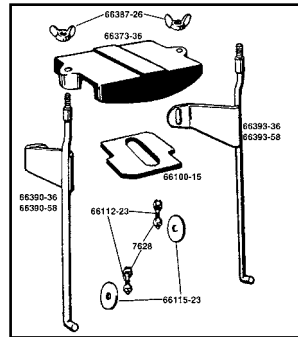

**Battery Extension Box** houses 12 volt mini battery raising it to the height of the H-2 6 volt battery. Use in wrap around oil tank to regain original height so battery rods may be used. Kit includes black box, rubber pads, rods and chrome top. Order battery separately

VT No.	Item
42-9987	Kit
42-9916	Battery Box only
53-0505	Battery only 12N5.5A-3B
42-0910	Chrome Battery Top Only
42-9919	Chrome Rod Set
53-0791	Battery Box Top

**Replica 6 Volt Battery Hardware** fits 1936-64 Big Twins.

VT No.	Item	Note
42-1056	1936-64	Complete Kit
		Includes rods, top, pads & terminal hardware
42-1143	1958-64	Complete Kit
42-0760	Top Cover	Black
42-0762	Top Cover	Chrome
42-9918	1936-57	Rod Kit with replica with flags & pads
42-9940	1958-64	Rod Set, Bare Metal
12-0538	Wing Nuts	10 pack
28-0545	Pad Set	Set, Rubber
28-0593	Pad Set	Set, Foam, 1929-64 Big Twin and 45
42-1375	Cover	1958-64 FL





# Battery Side Cover



## Battery Side Covers.

Chrome	Black	Fits/Type
<b>1965-84 FLH</b>		
42-0010		1965-69 FL-FLH Ribbed
42-0508		1970-84 FL-FLH Ribbed
42-0499		1970-84 FL-FLH Smooth
42-0507		1970-84 FL-FLH Louvered
<b>1973-85 FXE-FXEF-FXS-FXB-FXWG</b>		
42-0502		Square View Holes
42-0501		Single Slot View Hole
42-0500		Louvered
42-0097		Louvered with Square View Hole
42-0714		Embossed



**Chrome Battery Cover Kit** includes both top and side covers with correct stainless steel strap. Note style of side cover.

VT No.	Year	Model	Style
42-0542	1970-78	FX	Slotted
42-0543	1973-84	FXE-FXS	Square
42-0546	1970-84	FLH	Ribbed
42-0544	1965-69	FLH	Ribbed

42-1164 Embossed 1991-95 FXD  
42-0882 42-0569 Embossed 1991-95 FXD 6-7/8" long x 3-7/8"

## 1970-84 FX Kick Starter Only

42-0505	Single Slot View Hole
42-0003	Louvered

## Top Covers

42-0568 1997-2005 FXD

## Replacement Battery Straps

VT No.	Application
28-2217	1984-up FXST, FLST, 1980-up FLT, FLTC
42-0517	1970-85 FL, FLH
42-0515	1971-80 FX, Kick only
42-0524	1973-85 FXE, FXWG, FXSB, FXEF
42-0516	1965-69 FL, FLH

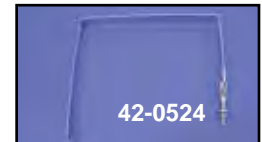

# Top Cover



## Battery Top Covers.

Chrome	Black	Year	Model
42-0510	42-0570	1965-84	FLH
42-0512	42-0571	1971-84	FX
42-0511	42-0566	1973-84	FXE



**Battery Pad Kits** include bottom and cover pads. Electric start.

VT No.	Fits	Battery
28-0624	FL-FLH	H-12
28-0623	FXE	12N164B

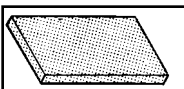

**Rubber Battery Pad Set** replaces 66103-74 on FXE. Set can be cut down for smaller applications. **VT No. 28-0539**



**Replacement Battery Top Foam Pads**, sold as a 10 pack. **VT No. 28-0626**



## Battery Top Cover and Strap Kit.

Save time by ordering the proper cover and hold down strap, display packaged.

VT No.	Year	Model	Type
42-5515	1970-78	FX	Kick
42-5516	1965-69	FLH	Electric
42-5517	1970-84	FLH	Electric
42-5518	1973-84	FXE	Electric



**Battery Terminal Hardware Kit** includes pieces to simplify battery installations on FXE and late XL models.

**VT No. 32-0235**



# Battery



Note: Do not over fill, fill to cover top of plates only as per instructions provided. This battery vents through the caps. There is No Warranty on Leakage due to over filling.

**Replica 6 Volt Batteries** feature black cases and correct size terminals as original. Batteries are stock style without vent.

VT No.	OEM	Fits
53-0521	66006-29	H-2 with small post, 3 <sup>7</sup> / <sub>8</sub> " x 4 <sup>1</sup> / <sub>2</sub> " x 8 <sup>1</sup> / <sub>2</sub> "
53-0507	66006-29	H-2 with small post, 3 <sup>7</sup> / <sub>8</sub> " x 4 <sup>1</sup> / <sub>2</sub> " x 8 <sup>1</sup> / <sub>2</sub> "
53-0500		H-2 with large post
53-0520	66001-47	H-3 measures 4 <sup>3</sup> / <sub>16</sub> " x 3 <sup>9</sup> / <sub>16</sub> " x 5 <sup>3</sup> / <sub>8</sub> " K and XL
53-0529	4303-26	1930-36 VL, H-1, 3 <sup>7</sup> / <sub>8</sub> " W x 6 <sup>5</sup> / <sub>8</sub> " L x 6 <sup>1</sup> / <sub>2</sub> " H



## AGM Mini 12 Volt Battery

- Measures 4<sup>1</sup>/<sub>2</sub>" Length x 2<sup>1</sup>/<sub>16</sub>" Width x 4<sup>1</sup>/<sub>4</sub>" Height.
- Factory Activated
- Maintenance Free

12 Volt	Item
53-0549	Battery
49-0795	Box Kit
6 Volt	Item
53-0570	Battery
49-1555	Box



All Batteries are dry charged and do not include electrolyte. Electrolyte (battery acid) is available at Tractor Supply stores.



**H-2 Battery** replaces 66006-29F for 1936-64 Big Twin 1929-63 45.

VT No.	Brand
53-0795	V-Twin Black does not include vent tube, vents through caps
53-0566	Plugs
32-1808	Ground Wire

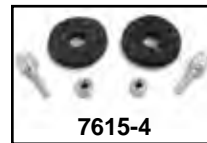

**1926-64 6 Volt Battery Terminal Bolt Kit** with felt washers.

VT No.	Item
7615-4	Kit
7615-4T	Kit with pads
48-0822	Caution Tag

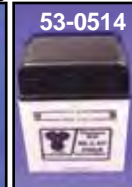

**6 Volt Universal Batteries.** Dry charged.

VT No.	Size	Length x Width x Height
53-0524	4 <sup>5</sup> / <sub>8</sub> " x 3 <sup>1</sup> / <sub>8</sub> " x 6 <sup>5</sup> / <sub>16</sub> "	
53-0514	4 <sup>3</sup> / <sub>4</sub> " x 3 <sup>1</sup> / <sub>2</sub> " x 5 <sup>5</sup> / <sub>8</sub> "	
53-0567	3 <sup>1</sup> / <sub>2</sub> " x 3" x 6 <sup>7</sup> / <sub>8</sub> "	
53-0849	214mm x 98mm x 114mm	

# Cables

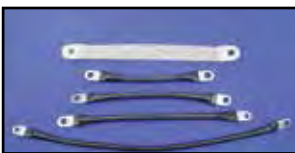

## Battery Cable Assortment.

Ground cable assortment is heavy duty replacement type, includes five pieces of the most popular numbers. **VT No. 32-0317**

**Replacement Battery Cables** are replacements of the originals with heat shielded terminal ends.

VT No.	OEM	Length	Fits/Ground
32-0311	70097-75A	10 <sup>3</sup> / <sub>4</sub> "	1982-84 FXR
32-0331	70186-82	8 <sup>1</sup> / <sub>2</sub> "	1982-92 FLT 1987-up FXR
32-0314	70209-65A	8 <sup>1</sup> / <sub>2</sub> "	1967-85 FL
32-0313	70313-71	10 <sup>1</sup> / <sub>4</sub> "	1971-78 FX
Positive			
32-0310	70069-65B	15 <sup>1</sup> / <sub>2</sub> "	Solenoid to Battery and Starter 1971-85 All FX, 1984-85 FXST 65-85 FLH Positive to Solenoid 82-88 FXR
32-0316	70069-83	15 <sup>3</sup> / <sub>4</sub> "	Solenoid to Starter 1983-84 all FX, 1984 FXST, 83-85 FLH

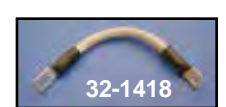
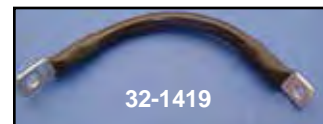

**Volt Tech Flexible Battery Cables** feature a 4 gauge cable manufactured with pure electrolytic-grade 36 gauge tinned copper strands for maximum current transfer and flexibility and a specially rated 125° C, oil and gas resistant, ultra-flexible translucent jacket in either black or clear.

Clear	Black	Length
32-1418	32-1419	7"
32-1400	32-1409	8"
32-1401	32-1410	10"
32-1420	32-1421	11"
32-1402	32-1411	12"
32-1403	32-1412	14"
32-1422	32-1423	15"
32-1404	32-1413	16"
32-1405	32-1414	19"
32-1406	32-1415	25"
32-1407	32-1416	30"
32-1408	32-1417	33"





# Battery

AGM's are:

- Completely Sealed
- Lock Bonded Plates
- Stainless Steel Terminal Bolts
- Exact fit



53-0547



53-0585



53-0536

**AGM Batteries.** The "Absorbed Glass Mat" Technology provides higher cold cranking amps, better rechargeability with longer overall life. Batteries are fully sealed for trouble free service in a black case.

**Note: 1998 and earlier FX models** require battery side cover, VT No. 42-0770 and a top cover, VT No. 42-0785 for FXD models.

VT No.	OEM	Years/Models
53-0547	65991-82B 65991-75C	1973-94 FX-FXR 1984-90 FXST-FLST 1983, 1999-2006, 1991-96 FXD, 1979-94 FXR, FX 1971-80 FLST, 1979-92 XLH
53-0585	65991-75	1973-84 FXE
53-0536	66010-82B	1980-96 FLHR-FLHT-FLT 1991-96 FLST 1997-99, 2007-2009 FLST 1998-2009 FL, FLH

**AGM Batteries Will Require Charging Before Installing.**

All Batteries are dry charged and do not include electrolyte. Electrolyte (battery acid) is available at Tractor Supply stores, nationwide.



**Battery Hardware**, bolt kit replaces 66000-80 bolt, nut, and spacer for 1973-up FXE-FXR.

VT No.	Item
37-8867	Nut, Bolt and Spacer, 5 pack
37-8933	Vent Clamp, 50 pack, 10067
32-0517	Vent Tube with Clamp

## Big Boar Battery



53-0700



53-0702

**Big Boar Batteries** have high cold cranking amps, and a replacement warranty. The 53-0700 battery is a totally sealed, maintenance free battery. Measuring 6<sup>7</sup>/<sub>16</sub> long x 6<sup>1</sup>/<sub>16</sub> high x 3<sup>5</sup>/<sub>16</sub> wide, and has been tested and proven on big inch and high compression engines. It has true 350 cold cranking amps.

VT No.	OEM	Fits	AMP
53-0700	65991-82	FX 73-86, FXR 82-94, Softail 94	350
53-0702		"Mini" 6" Length x 5 <sup>1</sup> / <sub>8</sub> " T x 3 <sup>1</sup> / <sub>4</sub> " Width	250

For custom application that have limited space. Starts larger engines but does not have a lot of reserve. Multi-positional.



53-0579



Champion

**H-12 Battery** fits electric start 1965-84 FLH, replaces 66006-65 and measures 8<sup>1</sup>/<sub>8</sub>" x 5<sup>1</sup>/<sub>4</sub>" x 6<sup>1</sup>/<sub>2</sub>"

VT No.	Brand
53-0532	Champion/Super Crank
53-0533	Champion (2)
53-0516	Yuasa
53-0579	Cap Set



53-0502



53-0517



53-0518



53-0505



53-0527

**12 Volt Battery** fits 1973-91 FXE-FXR, 1984-90 FXST-FXWG measures 7" x 4" x 6<sup>1</sup>/<sub>4</sub>".

VT No.	OEM	Item
53-0502	65991-75C	12N16-4B V-Twin, 16 amp
53-0517		Yuasa, Yumicron
53-0518		Yuasa CX 19 amp

**Custom application for Panhead-Knucklehead.**

4<sup>1</sup>/<sub>16</sub>" x 3<sup>9</sup>/<sub>32</sub>" x 4<sup>1</sup>/<sub>2</sub>". Fits in 42-9916 Box

53-0505	12N5.5A-3B	V-Twin
53-0527	12N5.5A-3B	Yuasa

**1970-79 Kickstarter models**

53-0504	12N7-4A
---------	---------

### Warranty and Adjustment Policy

This battery will be replaced without charge if found to be defective in materials or workmanship 6 months from date of over-the counter purchase. After 6 months but within 12 months of over-the counter purchase, the battery will be replaced and the purchaser charged only for the period of ownership based on the regular price at the time of return prorated over the number of months of warranty. This warranty is available through the dealer to the original retail customer and is not transferrable and is voided by the use of rejuvenators, improper electrolyte, neglect or abuse.

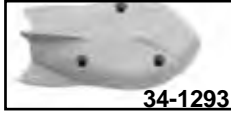
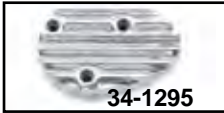
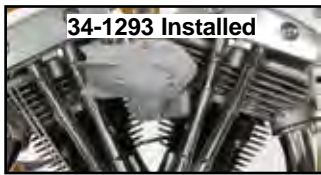
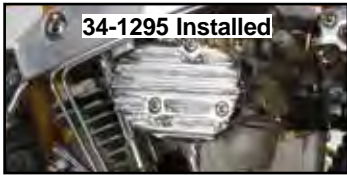

**Bendix/Keihin Carburetor Cover** is 3 bolt style and made of alloy.

**VT No. Style**  
**34-1293** Finned  
**34-1295** Rocket



**7" Round Air Cleaner Type. Chrome Black Type**  
**34-1372 34-0408\***Bendix/Keihin  
**34-0047** — Bendix  
 — **34-0407** 8"  
**34-0743** — Cover Only  
**34-0560** — Mount Bolts



**6" Chrome Dome**  
**34-0283** Keihin  
 \*Note: Features Bobber Style Cover



**Teardrop Air Cleaners.** Order bracket set separately.  
**Pre-1987**

VT No.	Style
<b>34-0199</b>	S&S
<b>34-0532</b>	Eagle Spirit, Chrome, Bendix Keihin
<b>34-0544</b>	Eagle Spirit Gold
<b>34-0516</b>	Smooth Chrome
<b>34-0515</b>	Smooth Polished
<b>34-0520</b>	Smooth Chrome Steel
<b>34-0527</b>	Smooth Chrome with Flames
<b>34-0528</b>	Finned Chrome
<b>34-0631</b>	Slotted Chrome

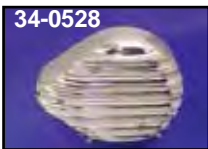

**Individual Parts For Above Units**  
**34-0518** Chrome Cover only  
**34-0519** Bendix Keihin Backing Plate  
**34-1320** Bendix Backing Plate  
**37-8556** Chrome Three piece screw kit  
**34-0545** Eagle Spirit Chrome Cover only  
**34-0905** Uni-filter Element only  
**34-0916** Foam Filter Element  
**34-0251** Filter

**Brackets For Tear Drop Air Cleaners.**  
**34-0202** 1974-80 Big Twin Shovel



**Chrome Velocity Stack Kits** include 2.5" chrome stack and chrome support bracket. Fit stock Keihin or Bendix carburetors. Does not have a breather kit. Fit 1978-84 Shovelhead.

**VT No. 34-1125**

# Air Cleaner



**Chrome Air Cleaner** with element fits Bendix and Keihin.  
**VT No. 34-1292**

**Chrome Air Cleaner Covers** fit S&S carburetor stock backing plate and filter, "bolt on" type.

Super E	Super B	Style
—	<b>34-0545</b>	Eagle Spirit Chrome
<b>34-0978</b>	—	Smooth (S&S)
<b>34-0707</b>	—	Skull
<b>34-0709</b>	—	Maltese



**Chrome S&S Super E Air Cleaners** are available as complete, or replacement covers only. Complete assemblies include backing plate which have built-in brackets to mount to Evolution heads.

VT No.	Item/Fits
<b>34-0978</b>	Assembly All Pre-Evolution engines
<b>34-1062</b>	As Above with Notched Cover for 5 Gallon Tanks
<b>34-0981</b>	Chrome Cover All Super 'E'
<b>34-1063</b>	As Above with Notched Cover for 5 Gallon Tanks
<b>34-1096</b>	S&S Backing Plate 1971-85
<b>34-0984</b>	Uni Filter Foam Air Filter Super 'E' Foam Type
<b>9980-3</b>	Chrome Allen Screw Set for S&S Covers



**S&S Air Cleaner.** Used on S&S Super 'B' or 'L' Series carburetor. Can be used on Tillotson Bendix, or Keihin carburetors for greater air flow.

VT No.	Item	Finish
<b>34-0039</b>	Air Cleaner complete	Chrome
<b>34-0519</b>	Backing Plate only	
<b>34-0905</b>	Uni-Element only	
<b>37-8556</b>	Cover screw set	Chrome
<b>34-0532</b>	Eagle Spirit Air Cleaner complete	Chrome
<b>34-0544</b>	Eagle Spirit Air Cleaner complete	Gold inlay
<b>34-0545</b>	Chrome Eagle Spirit cover only	



**Chrome Alloy Velocity Stacks.**

VT No.	Fits	Length
<b>34-1102</b>	S&S "E & G"	4"
<b>34-1107</b>	S&S "D"	4"
<b>34-1108</b>	S&S "E & G"	2.5"
<b>34-1103</b>	Bendix/Keihin	2.5"
<b>15-0885</b>	Bendix Gasket	
<b>34-1159</b>	Screen	





# Air Cleaner



34-1292  
Assembled



34-1318  
Assembled



34-0977

**Chrome Air Cleaner** fits pre-1989 Keihin and Bendix carburetors. Includes chrome cover, element and backing plate. Round type is 7" with center screw. Order brackets separately as required.

VT No.	Style
34-1292	Chrome Smooth
34-0977	Foam Element only
34-1318	Black, smooth

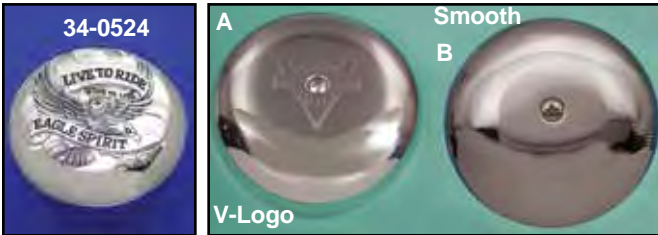

34-0524

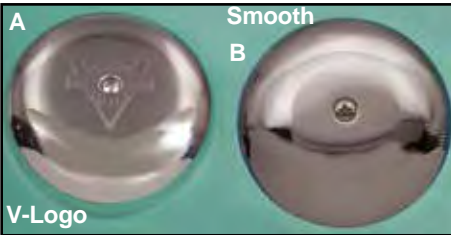

V-Logo



34-0555



34-0905

**7" Air Cleaner** with center screw available with cover fits Bendix, Tillotson, Keihin and CV carburetors. Features breather tube, backing plate and 3" thick foam element.

Bendix #	Item
34-0505	A Bendix-Keihin three bolt
34-0547	B Bendix-Keihin three bolt
34-1841	Keihin, Black
34-1043	Bendix Backing Plate Only
34-1841	Keihin
34-0905	Uni Filter foam filter
34-0916	V-Twin Foam Filter
34-1277	Washable Filter
34-1041	7" Smooth Air Cleaner Cover
34-1042	7" V-Logo Air Cleaner Cover
J Slot	
34-0555	Eagle Spirit Cover Only
34-1442	J-Slot, World's Fair
34-0524	A Chrome Eagle Spirit
34-0905	A Foam Element only fits A

7"



34-0432

**Black Oval Air Cleaner Insert.**  
VT No. 34-0432



34-0501



34-0040



34-0506

**Air Cleaners** include elements.

Chrome	Black	Element	Fits
34-0501	34-1325	34-0079	Bendix-Keihin
34-0733	—	34-0079	S&S "E"
34-0040	34-1370	34-0078	Bendix-Keihin
34-0506	—	34-0079	Bendix-Keihin with Chrome Mesh
34-0732	—	34-0079	Round
34-0906	Foam Element for VT No. 34-0506 type		
34-0711	Foam Element for VT No. 34-0501, 34-0733 type		



34-0510



34-0512

**5 3/4" Chrome Air Cleaners** are for all Bendix and Keihin three bolt carburetors. Includes foam washable element, 2 1/4" thick.

VT No.	Item
34-0510	Drilled
34-0512	Smooth
34-0915	Element Only



34-0526



8212-3



34-0475

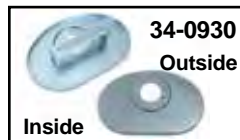

Inside

34-0930

Outside



8212-3



34-1248

**Original Style Oval Chrome Air Cleaner** includes element, cover, screws and backing plate, fits Bendix and Keihin carburetors only.

VT No.	Item
34-0526	Complete Assembly, Bendix
34-0924	Complete Assembly, Keihin
34-0900	Element (Uni)
34-1248	Element (V-Twin)
34-0559	Cover only
34-0930	Backing Plate Only, Keihin and Bendix
8212-3	Cover Screws Chrome
2323-6	Mount Kit
34-0560	Mount Kit



# Air Cleaner & Filter



**V-Charger™ Chrome Air Cleaner** features air scoop "blower" design and includes a built-in chrome screen and filter element.

VT No.	Type	Year	Model
34-0466	S&S	1966-91	Big Twin
34-0599	Bendix Smooth		
34-0620	S&S E Smooth		
34-1303	Skull		
34-1070	Filter		
34-0560	Mount Kit		

**Early Style Carburetor Breather Snoots** feature chrome cover without filter. Bendix Keihin and CV have three bolt pattern. CV requires use of 35-0125 for 2000-up Big Twins or 35-0122 for 1993-99 Big Twins.

VT No.	Type
34-1046	Bendix-Keihin
34-1081	CV
34-1253	S&S 1986-90
34-1254	S&S 1991-06
34-0659	Cover Only
34-0273	Bendix Plate



**Maltese Carburetor Cover and Backing Plate.** Center portion of cross has a matte finish. Order filter and brackets separately.

Chrome	Polish	Carburetor Type
34-0608		Bendix-Keihin
34-0610	34-0880	S&S 'E'
34-1168	34-1168	Filter only
34-1130	34-1112	Cover only



**Chrome Maltese Air Cleaner Kit** includes backing plate, filter, cover and bracket as required to fit stock original carburetor. The center portion of the cover is matte chrome finish. Fits 1966-85 Big Twin.  
VT No. 34-1149

## Replica Air Filter



**Replica Paper Air Filters** feature original shape and styling for exact fit. Washable construction.

VT No.	OEM	Fits
34-0903	29255-78	1982-83 FXR, 1980-82 FLT, 1978-84 FX, FL, FLH (Foam)
34-0900	29036-72	1967-E75 FL FX (Foam)
34-0935	—	S&S Type, Round B Series
34-1176	—	S&S 'E' & 'G'
34-0251	—	S&S 'E' & 'G'
34-1248	29036-72	Washable



**Air Filters** are available in three types; K&N paper, Uni Filter foam and Accel 2-stage foam. All have screen insert.

K&N	Accel	Uni-Foam	OEM	Fits
<b>For Aftermarket Models</b>				
34-0960	34-0975	34-0905	—	S & S Super 'B'
—	—	34-0916	—	As Above, Import, S & S & 7" Round Style
34-1010	—	34-0984	—	S & S Super 'E' & 'G'
—	—	34-0906	—	34-0506, 34-0508
—	—	34-0915	29085-81	34-0510
—	—	34-0977	—	New Era
34-1009	—	—	—	Mikuni HSR-40 smooth bore
34-1078	—	—	—	Mikuni HSR 42/45 smooth bore
34-1040	—	—	29055-89	Screamin' Eagle Round
34-1066*	—	—	29025-88B	As Above, Oblong *Note: OE Brand
34-1070	—	—	—	Hyper Charger
<b>For Big Twin Models</b>				
—	—	34-0912	29288-83	1983-85 FLT-FLHT
34-0954	34-0970	34-0903	29255-78	1982-83 FXR, Late 1978-81 FX-FL
34-0953	—	34-0902	29036-75	1977-E78 FX FL
34-0952	34-0967	34-0901	29036-73	Late 1976-78 FX-FL
34-0951	—	34-0900	29036-72	1967-75 FX-FL-FLH
34-1248*	—	—	69036-72	1967-75 FL-FX Paper *Note: Replica







# Super 'E' & 'G'



35-9355



35-0995

**S&S 1<sup>7</sup>/<sub>8</sub> & 2<sup>1</sup>/<sub>16</sub> Super 'G'** feature adjustable volume pump, enrichment device for ease of starting and a throttle spool assembly designed for late 2 cable operation. Supplied with tear drop air cleaner, mounting bracket and black fuel line. Super 'E' carburetor is approximately 1<sup>7</sup>/<sub>16</sub>" shorter than the Super 'B' carburetor, making installation length of the Super 'E' the same as stock. Can be used with 3.5 or 5.0 gallon Fatbob tanks. The 1<sup>7</sup>/<sub>8</sub>" is for street stock applications, 2<sup>1</sup>/<sub>16</sub>" for big bore and race use. Intake manifold clamps or flanges must be purchased separately when they are required.

### 1<sup>7</sup>/<sub>8</sub> 'E' 2<sup>1</sup>/<sub>16</sub> 'G' Fits

- |          |         |   |
|----------|---------|---|
| 35-0001  | —       | Panheads, Knuckleheads w/O-Ring Manifold                |
| 35-0002  | —       | Pre-78 Big Twin with O-Ring heads                       |
| 35-0003  | 35-9201 | 1978-84 Big Twin with Rubber band heads                 |
| 35-0013* | —       | As Above with Notched Air Cleaner for Five Gallon Tanks |
| 35-9355  | —       | Rebuild Kit   |
| 35-0995  | —       | Jet Kit   |
| 2596-13  | —       | Screw Kit   |

\*Note: Does not include intake manifold & can be use on 1966-82.



**Quick Change Float Bowl Screws** for S&S Super models to facilitate jet changes by easy bowl removal. Includes four knurled screws with large slots in satin finish.  
VT No. 37-8901



**Super E Carburetor Body Rebuild Kit.**  
VT No. 35-0850



**Carburetor Enricher** for S&S "B" carburetors.  
VT No. 35-0371



**Retrofit Fuel Line Kit** includes a pre-formed 17" x 5/16" black fuel line, needle and seat inlet assembly with 90° swivel fitting, hose clamps and a float bowl gasket. Fits Custom application for S&S Super E and G carburetors. VT No. 35-0548



35-0001

**S&S Super 'E'** fits 1970-84 Panheads and Knuckleheads with O-Ring manifold.

### VT No. Item

- 35-0001\*Kit  
35-0471 Carb Only  
35-1050 Carb, Black

\*Note: For plumber style heads use 7344-6



35-4571

**Fits S&S Super 'B'**



35-0362



**Accelo Bowls** for S&S carburetors. Accelo bowl accelerator pump/float bowl kits improve the performance of S&S Super B and D carburetors. Eliminates low end throttle hesitation & improves starting. **Note:** Some machining to carburetor body is required, complete instructions included.

### VT No. Use

- |         |   |
|---------|---|
| 35-4571 | Use on S&S Super 'B' & 'D' carburetors with two cable throttle control. 1982-up       |
| 35-4572 | Use on S&S Super 'B' and 'D' carburetors with single cable throttle control. Pre-1982 |
| 35-0203 | Pump for Above  |
| 35-0934 | Single Arm  |
| 35-0362 | Dual Arm  |
| 35-0864 | Bowl Only   |



**Replacement Float** fits all S&S Super B-E-G carburetors. For use with wire type needle and seat.

### VT No. Brand

- |         |     |
|---------|-----|
| 35-9189 | VT  |
| 35-9183 | S&S |



**Master Rebuild Kits.** Complete carburetor restoration for S&S Super B carburetors can be performed by using master rebuild kit. Float not included. Year refers to when carb was manufactured. 1983 and earlier has forked type floats.

### VT No. Year

- |         |                      |
|---------|----------------------|
| 35-9142 | 1983 and earlier S&S |
| 35-0204 | 1983-up V-Twin       |
| 35-0290 | 1983-up V-Twin       |



**Throttle Shaft Kit** includes shaft, spring and stop for S&S "B" series carburetors.  
VT No. 35-0981



35-0199

**Carburetor Body Rebuild Kit** is for 1-7/8" S&S Super B carburetors.  
VT No. 35-0199

## Support Brackets



**Chrome Air Cleaner Support Brackets** are for installing the custom round or teardrop air cleaners.

### VT No. Fits

- |          |                    |
|----------|--------------------|
| 34-0205* | 1967-84            |
| 34-0202  | 1966-84 Shovelhead |

\*Note: For S&S air cleaners and carburetor support.



31-9918



34-0336

**Air Cleaner Support Brackets** fit 1<sup>7</sup>/<sub>8</sub>" S&S Super 'B' carburetors.

### VT No. Fits

- |  |                     |
|--|---------------------|
| 31-9918  | All Adjustable type |
| <b>Air Cleaner Support Bracket</b> fits S&S Super 'E' & 'G' 1966-82 FL-FX. |                     |
| VT No. 34-0336   |                     |



**FX-FLH Air Cleaner Support Bracket** replaces 29018-71A. Fits 1971-84 FX-FLH Shovelhead models.

VT No. 31-0128



# 7" Linkert Air Cleaner

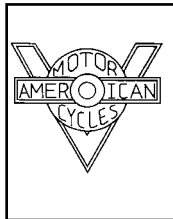

V-Logo



Logo Detail for NYWF



34-1359



34-1049



34-1034



34-0907

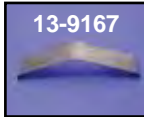

13-9167



34-1247



34-0624



34-1233

**Chrome J-Slot Air Cleaners** feature a unique four pin cover mounting, with internal spring to fit four bolt linkert types and include copper element. Available with smooth, V-Design or 1939 World's Fair logo from original 1939-40 accessory design to commemorate the fair.

7"

### 7" Type

- | VT No.  | Item                    |
|---------|-------------------------|
| 34-1049 | Smooth, complete        |
| 34-1359 | Bird, complete, left    |
| 34-1323 | Smooth, Raw             |
| 34-1531 | Bird, Right             |
| 34-1034 | NYWF, Complete          |
| 34-1442 | SS Complete             |
| 34-0499 | Backing Plate only      |
| 34-0907 | Copper Mesh only        |
| 13-9167 | Spring only, Flat       |
| 34-0624 | Backing Plate (Linkert) |

### Covers Only

- |         |                              |
|---------|------------------------------|
| 34-1233 | Bird Cover, Right            |
| 34-1308 | Smooth Cover, Right and Left |
| 34-1333 | World's Fair, Right and Left |
| 34-1247 | Bird, Left                   |
| 49-8320 | Raw, Indian                  |
| 34-1342 | SS Cover                     |



34-1308



34-1333



34-1531



34-1563

**Mesh Element.** Original type of woven copper replaces 29036-41, spring replaces 29040-41 on J-slot type.

- | VT No.  | Type                       |
|---------|----------------------------|
| 34-1563 | Copper Mesh Kit            |
| 34-0907 | Copper Mesh Only with Core |
| 34-0907 | Copper Mesh Element        |
| 13-9167 | Spring each                |



49-0377

**7" Air Cleaner Instruction Tag** fits round air cleaner covers.

VT No. 49-0377



49-0657



**Air Vortex** fits 4-bolt Linkert J Slot backing plates. Use smoother air flow. VT No. 49-0657

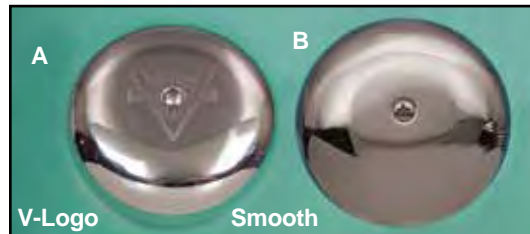

V-Logo

Smooth

**7" Center Screw Air Cleaner** for Linkert features steel backing plate with four mounting holes, chrome cover and foam element.

VT No.	#	Style	Type
34-0513	A	V-Logo Air Cleaner	Complete
34-1025	B	Smooth Air Cleaner	Complete
34-0543		Backing Plate Only	
34-1041		Smooth	Cover Only
34-1042		V-Logo	Cover Only
34-1380		Black Cover	Cover Only
34-0497		H-D	Complete
34-0712		Backing Plate	Replica
37-2096		Screws, 5 Pack	Chrome

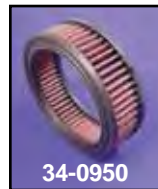

34-0950



34-0904



34-0916



34-1277

### Filters Only

- |         |           |
|---------|-----------|
| 34-0950 | K&N       |
| 34-0904 | Uni       |
| 34-0916 | Foam      |
| 34-1277 | Cycovator |
| 34-1679 | Foam      |



34-1679



34-1045 Installed



**Early Style Carburetor Breather Snoots** feature chrome cover without filter. Linkert four bolt types for Side Valve for Left Side mounting, Right Side, OHV Mount.

- | VT No.  | Type   |
|---------|--------|
| 34-1079 | SV     |
| 34-1045 | OHV    |
| 34-0659 | Cover  |
| 2611-8  | Screws |

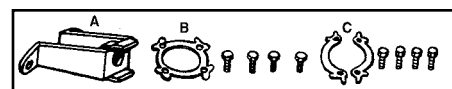

34-0271

**Linkert Air Cleaner Mount Hardware Kits** include steel locks. Support bracket secures center screw cover to 4 bolt backing plate.

VT No.	#	OEM	Item	Year
34-0206	A	29050-56	Support Bracket	All
9017-5	B	29155-36	Screw Kit	1936-55
9682-5	B	29155-36	As Above, Parkerized	1940-55
9682-5T	B	29155-36	As Above, Parkerized	1940-55
7821-6	C	29060-56	Screw Kit	1956-65
7821-6T	C	29060-56	Screw Kit	1956-65
34-0271		Kit	Mount	1956-65
15-1581			Gasket	





# 6" Air Cleaner



34-1033



34-1050



34-1049



34-1055



34-1004



34-0580



34-0282



34-1465

## 6" Type Air Cleaner

- | VT No.   | Item                                   |
|----------|--|
| 34-1033  | NYWF, complete                         |
| 34-1050  | Smooth, complete                       |
| 34-1055  | Smooth, complete (raw)                 |
| 34-1004  | Backing Plate only                     |
| 34-1680  | Backing Plate only, parkerized         |
| 34-1003  | Copper Mesh Roll                       |
| 34-1465  | Copper Mesh Roll (4)                   |
| 34-1840  | Copper Mesh Insert                     |
| 13-9245  | Spring only, Coiled                    |
| 34-0580  | Replica Backing Plate with Copper Mesh |
| 34-1530  | Smooth Cover Only                      |
| 34-0462  | World's Fair Cover                     |
| 34-1886  | Smooth Chrome Cover                    |
| 34-0047  | World's Fair, Raw                      |
| 34-0945S | Smooth, Raw                            |
| 34-0778  | Smooth Dome Cover                      |
| 34-0282  | 1936 Complete                          |
| 34-1297  | Rusty Kit                              |



34-1297



49-0834



49-0834  
Installed

**Linkert Choke Cable Assembly** includes cable, knob and cable bracket, carb arm for carburetor and hardware. Fits cat-eye, two and three lite dash panels. Order **35-1065** choke shaft for OHV application.

VT No. 49-0834

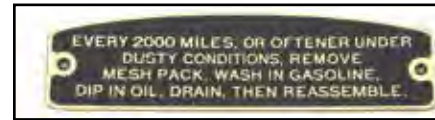

**6" Air Cleaner Instruction Tag** fits round air cleaner covers.

VT No. 49-0643



6" Smooth J Slot Cover  
VT No. 34-0778



Raw World's Fair Cover  
VT No. 34-0047



Close-Up of "1939 World Fair" Logo



**Retro Oval Air Cleaner.**  
Fits 1971-1977 FX, 1971-1984 FL.

VT No. 34-0961



34-1388 Installed



34-1388



34-1396

**34-0956** Linkert Air Cleaner Adapter Plate  
FL 1941-1965

**34-0990** Linkert Air Cleaner Backing Plate  
Fits: EL 1936-1952, FL 1941-1965, W 1941-1952

**34-1312** Raw 6-1/2" Air Cleaner Cover "World's Fair"

**34-1351** Linkert Air Cleaner Adapter Plate  
Fits: FL 1941-1965, W 1941-1952

**34-1388** Linkert Teardrop Cover  
Fits: FL 1941-1965, W 1941-1952

**34-1396** Linkert Diamond Air Cleaner Cover Kit  
Fits: FL 1941-1965

**34-1397** Rodan Linkert Carburetor Cover Fits 1941-1965 FL.

**34-1884** Parkerized Replica Linkert Backing Plate FL 1941-1955

**34-1885** Parkerized Replica Linkert Backing Plate FL 1956-1965



# Linkert



49-0631



49-0631



49-0633



49-0633

**Got a Bare Brass Linkert Body  
We Can Rebuild It!**



**Watch Our Video!**  
[http://www.youtube.com/  
user/TeddCycle](http://www.youtube.com/user/TeddCycle)

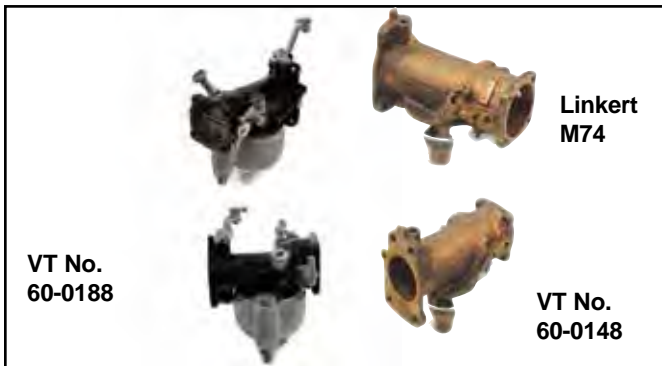

Linkert  
M74

VT No.  
60-0188

VT No.  
60-0148



**Linkert Rebuild Service.** Parts  
billed separately as required.



**Linkert Hand Tool Tap,** sold each.

Thread	VT No.
10-32	16-1400
12-24	16-1401
1/4 x 40	16-1402
5/16 x 18	16-1403
5/16 x 32	16-1404
Kit	16-1405



49-0635



49-0635



35-0082



49-0398



49-0635

**Replica Linkert Carburetor** is completely assembled with all  
internals with brass body. **\*Note:** Without throttle arm.

VT No.	Model	Type	Year
49-0631	M88	45 SV	1941-52
49-0266*	M88	45 SV	1941-52
49-0633	M51L	Big Twin SV	1937-48
49-0398*	M51L	Side Valve	1936-48
35-0082	M74	Big Twin	1948-65
49-0635	M51	Big Twin SV	1937-48
35-1350	Bonn	Indian Chief	1935-53
48-0926	Can		



49-0635 Installed on Knucklehead Motor



29-1115  
Installed





# Linkert

## Linkert Stuff Cad!



### Linkert Throttle Levers.

Brass	Cadmium	OEM	Fits	Year
35-0795	35-9081	27252-37	SV	1936-52
35-0796	35-0784	1238-36	OHV	1936-47
35-0797	35-0780	27260-40	OHV	1941-47
	35-9081		OHV	1941-47
	35-0753	27260-48	Throttle Lever	
	35-0984	27260-37	Throttle Lever	
35-0341			Screw Kit	

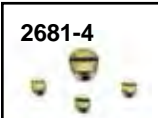

### Cadmium Plated Linkert Components.

VT No.	Item
8902-4	Carburetor Bowl Lock Nut
2681-4*	Plug and Screw Kit <b>Note:</b> Brass finish
2658-5	Carburetor Throttle Lever Wire Block
35-0781	Needle Valve Lever
2598-1	Needle Valve Lever Screw
2695-5	Low Speed Needle
2643-2	Needle Valve Lever Spring with collar
35-0782	High Speed Needle Valve, 27297-27
35-0781	Needle Valve Lever, 27395-27
<b>Linkert Carburetor Parts.</b>	
35-0345	Nylon Bushing Kit
35-0474	Throttle Shaft
35-0582	Float Bowl with flat top
35-0693	Throttle shaft
35-0723	Manifold Spigo
35-0746	Bombsight Venturi
35-0829	Throttle Disc
35-0836	1-1/2" Bombsight Venturi Kit
35-0925	Hardware Kit
35-0936	DC-2 Carb
35-1000	Needle Valve Lever
35-1287	SV Choke Disc Kit
35-9114	Linkert Choke Lever
35-0016	Flanders Linkert Carb Bracket
15-0298	S&S Float Bowl Gasket
15-0453	Linkert Carb to Manifold Gasket
15-0547	Carburetor to Manifold Gasket
15-1294	Linkert Carburetor Gasket Kit
35-0283	L'Series Carburetor Assembly
34-1352	Backing Plate



Linkert Patch.  
VT No. 48-1343



### Linkert Snap Throttle Kit.

VT No.	Kit	Throttle Only
36-0934	1/4 Turn	35-0782
36-0947	Standard	35-0071

# "L" Series

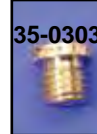
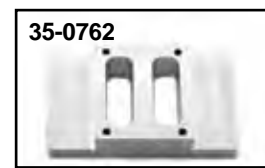
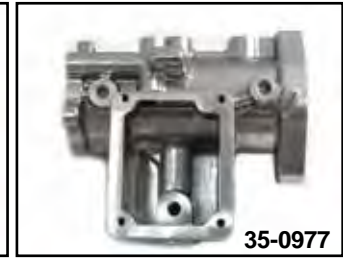

### "L" Series Parts.

VT No.	Item	35-0788	35-0840
13-0932	Idle Screw	Bowl Dual Kit	Sub Assembly Kit
35-0287	Jet Kit	35-0977	Body
35-0303	Air Bleed Jet	35-0980	Bowl
35-0656	Throttle Shaft	35-0981	Carb Throttle Return Spring Kit
35-0657	Throttle Door	35-0998	Throttle Arm & Door
35-0658	Spring	35-1673	Choke Door Kit
35-0659	Kit	35-1703	Fixed Jet
35-0660	Screw	35-0965	Jet Kit
35-0663	Main Nozzle Dis. Tube	35-1280	Complete Carb "L"
35-0752	Arm	35-0939	Shaft
35-0762	Dual Bowl Mount		
35-0664	Throttle Arm		

# Mikuni Carb



**45" Mikuni Carburetor Kit** includes 34mm Mikuni Carb, Adapter Flange to fit 1936-52 Stock Manifold 27024-36, Anderson style 1" twist grip assembly, air cleaner and cable. Order VT No. 49-0207 manifold separately.

VT No.	Item
35-0107	Carburetor Complete Kit
49-0207	Replica Manifold
34-0534	34mm Air Cleaner
34-0521	Cleaner Adapter
48-0671	Mikuni Parts and Information Manual



48-0671



# Linkert Carburetor



**Linkert Overhaul Kit** is complete with hardware. Includes needle and seat, float, bushings, springs, float pin and gaskets for 1933-65 models.

- | VT No.  | Item                          |
|---------|-------------------------------|
| 35-0563 | Kit with cork float           |
| 35-0501 | Kit with Linkert M foam float |
| 35-0552 | Kit with black foam float     |
| 35-0666 | Kit with foam float           |
| 35-9175 | Kit with brass float          |
| 35-0790 | Kit                           |
| 35-8009 | Kit without float             |
| 35-4573 | Brass float only              |
| 35-0514 | Cork Float Only               |
| 35-0745 | Foam Float Only               |
| 35-0502 | Needle and Seat (Viton)       |
| 35-0545 | Needle and Seat (Steel)       |
| 14-0926 | Gasket for Above              |
| 15-0622 | Gasket Kit, 3 and 4 Bolt      |
| 15-0545 | Gasket Set                    |
| 15-0420 | Gasket Set, 3 Bolt            |
| 15-1102 | As Above, James               |
| 15-0629 | Gasket Kit, 3 Bolt            |
| 15-0304 | Bowl Gasket, 1936-51, 5 pack  |
| 15-0321 | Bowl Gasket 1952-65           |
| 15-0232 | Bowl Nut Gasket               |
| 15-0262 | Spacer                        |
| 35-0341 | Screw Kit                     |

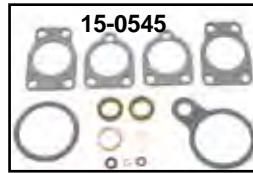

**Linkert Bomb Site Venturi** fits all 1 1/2" brass Linkerts. Venturi press tool. VT No. 16-1037 included.  
**VT No. Type**  
35-0851 Alloy  
35-1070 Brass



**Linkert Venturi Press Tool Kit** to remove and install Venturis in brass Linkert carburetor bodies.  
**VT No. Brand**  
16-1037 VT  
2701-6 Colony  
16-1405 Tool Set



**Linkert Carb Black Paint.** VT No. 41-0144



**1957-66 Linkert DC Carburetor Gasket Set** includes bowl and body gaskets, sealing washer, small springs and screws.  
**VT No. 15-0628**



**Linkert Complete Carburetor Hardware Assembly Kit** includes all parts except body. Kit includes parts pictured.

VT No.	Model/Size	Rebuild Service
35-0079	M74 1 1/2"	60-0148
35-0078	M88 1 1/4"	60-0188
35-0342	M88	60-0188
35-0081	M88I 1 1/4"	60-0147
35-0045	M51L 1 1/4"	60-0144
35-0046	M51	60-0143
35-0049	M35 1 1/2"	60-0146
35-0190	M18 1"	60-0145
35-0038	M18	
35-1941	M41 1 5/16"	60-0188
<b>Bore Service</b>		<b>60-0122</b>
60-0195		
60-0345		



**1933-65 Linkert Foam Float and Needle Valve Assembly.**

- | VT No.  | Needle          |
|---------|-----------------|
| 35-0537 | Viton Tip       |
| 35-0000 | Stainless Steel |
- Linkert Carburetor Overhaul Kit.**  
**VT No. Item**  
35-0873 1 1/4" (Nitrophenyl float)  
35-9194 1 1/2" (Brass float)  
35-0553 1 1/2" Kit  
35-0944 3 Bolt Type  
35-0341 Screws



**Early Float** features full Armstrong Foam Construction and original shape which accepts stock screw and shoulder nut. They cannot leak and are not affected by leaded or unleaded gas. **VT No. 35-0745**



**Replica Cork Float** includes bolt. **VT No. 35-0514**



- | VT No.  | Item  |
|---------|---|
| 35-0223 | Kit   |
| 35-0229 | Kit with Accelerator Pump, Intermediate Adjuster Screw, Needle and Seat |
| 35-0226 | Needle and Seat   |
| 35-0224 | Intermediate Adjuster Screw   |
| 13-9215 | Inlet Valve Lever Spring  |
| 13-9216 | Idle Adjuster Spring  |
| 13-9217 | Throttle Lever Stop Screw Spring  |
| 13-0230 | Throttle Shaft Spring   |
| 35-0262 | Adjustable Jet Kit  |
| 35-0225 | Pump Assembly Kit   |







# Linkert



**Float Bowl Assembly** includes bowl, foam, nitrophyl float, arm and needle seat.

VT No.	Item	Fits
35-1452	Kit	OHV
35-1460	Kit	OHV
35-1455	Kit	Side Valve
35-0281	Brass Bowl	
35-0551	Lock Nut	Chrome
35-0853	Lock Nut	Zinc

**Linkert Choke Rod Kit.** Choke rod and lever assembly used on all Overhead Valve Big Twins with linkert style carburetor.



VT No.	OEM	Year
35-0872	Lever	1936-37
35-0534	Kit	1938-47
35-0506	Kit	1948-65
35-9138	27244-48	Rod 1948-65
35-0486	27244-40	Rod 1941-47



### Choke Lever.

VT No.	OEM	Item
35-9134	27235-33	Lever, Side Valve
35-9323	27288-33	Lever, WLA
35-9135	27251-24	Screw
35-0952	49-4133	Thumb
49-4133		Indian



**1941-65 Overhead Valve Big Twin Carburetor Support Brackets** are replica for linkert carburetors. Replace 27431-41.

VT No.	Year	Finish
31-0194	1941-53	Chrome
9009-5	1941-53	Parkerized
9010-5	1954-65	Parkerized (Pictured)



### Float Bowl. Oversize Bean Pot Style.

VT No.	Fits
35-0281	1936-52 W
35-1286	1948-65 FL, EL



### Throttle Doors.

VT No.	OEM	Fits	Size
35-0958	27280-34	1"	STD #12
35-0492	27280-51	M74 1 1/2"	STD #9x
35-0827	27280-51A	M74 1 1/2"	.005 O.S.
35-0828	27280-51B	M74 1 1/2"	.010 O.S.
35-0862	27280-51C	M74 1 1/2"	.030 O.S.
35-0679	27280-40	1 1/2"	STD #12
35-0861	27280-40A	1 1/2"	.035 O.S.
35-9061	27280-24	1 1/4"	STD #13
35-0860	27280-24A	1 1/4"	.030 O.S.



**Linkert Venturi Tool.**  
VT No. 16-1037

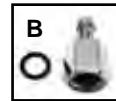

**Linkert Carburetor Parts.** 15-0262 is a 4 bolt insulator spacer. The 35-0504 throttle conversion kit fits 1941-65 Overhead Valve models to use snap throttle. The 7158-2 adapts flexible hose to carburetor fitting.

VT No.	#	Note	Item
35-0504	A	—	Throttle Conversion Kit
7158-2	B	—	Carburetor Fitting
15-0262	C	4-Hole	Carburetor Spacer
35-0885	C	3-Hole	Carburetor Spacer



**Carburetor Cable Block** attaches inner choke or throttle cable to throttle arm. Includes throttle cable block, screw and cotter pin.

VT No.	Type
35-0207	Replica
2658-5	Cadmium
2664-5	Oversize

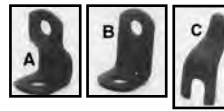

**Parkerized Carburetor Support Brackets** are replica for linkert carburetors.

VT No.	#	OEM	Year/Model
9011-5	A	1110-33	1930-38 SV Big Twin
9012-5	B	1110-39	1939-48 SV Big Twin
9013-4	C	27432-36	1936-55 45



**Venturis for Linkert.** These precision machined aluminum venturis are made to exacting tolerances.

### VT No. Venturi Model/Size

#### 1" Carburetor Bore Series

2328-1 7/8" M4, M11, M16, and M18

#### 1 1/4" Carburetor Bore Series

2332-1 1 1/16" M2, M5, M21, M51, M52, M55, M58, M64, M65, M84, M97

2822-1 As Above but .025" O.D.

2334-1 1 1/8" M41L, M51L

2340-1 1 5/16" M88, M90

M641

35-0479 1 5/16" M88

35-1395 1 1/8" M51-L

35-1391 1 1/16" M51

#### 1 1/2" Carburetor Bore Series

2336-1 1 1/8" M61B, M61, M36A, M36, M35 and M35T

2710-1 As Above but .025" O.D.

2338-1 1 5/16" M74B, M74, M45A, M45

2818-1 As Above but .025" O.D.

35-0949 1 1/2" Bomb Site

35-0734 1 1/2" M51 Bomb Site Alloy

35-0491 1 5/16" M74B

35-0953 1 1/4" Bomb Site

35-0884 1 1/8" Special

**Venturi for Linkert Carbs, Indian models**

2465-1 41-48 Chief M-6, M-341, M-343, and M-34

2467-1 Chief 80" M-350, M-352 and M-Bonn



# Bird Deflectors



**34-1883  
Installed**



**Linkert Bird Deflectors.**  
**VT No. Type**  
 34-0443 Rocket  
 34-1203 Antique chrome  
 34-1240 Oval Bronze Shield  
 34-1341 Teardrop  
 34-1381 Roth, smooth  
 34-1383 Oval Finned  
 34-1384 Roth Style Fins  
 34-1883 Spoon  
 34-0649 Set of 6



**Carburetor Turbulator or Atomizer for Linkerts bolts to 4 bolt brass carburetors.**  
**VT No. Item**  
 35-0469 Turbulator  
 35-0954 Atomizer

**Carburetor Scoop Bolts to 4-Bolt Linkert Carburetors.** Fits 1941-65 FL, 1936-52 EL, 1936-52 G.  
**VT No. Finish**  
 34-1360 Polished Kit  
 34-1296 Polish  
 15-0145 Gasket Kit



**34-1301 installed  
with 34-1341 chrome 1940 style plain emblem**



**Linkert Teardrop Carburetor Cover Kit** includes a mount base with hardware and tank emblem shaped cover. As seen on 1947 Knucklehead!  
**VT No. Item**  
 34-1301 Complete Kit  
 34-1341 Mount

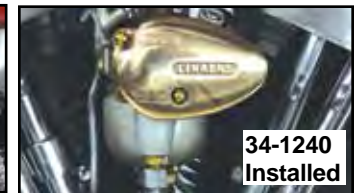
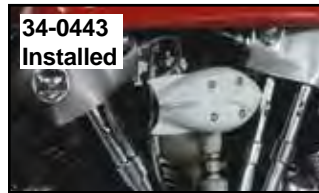
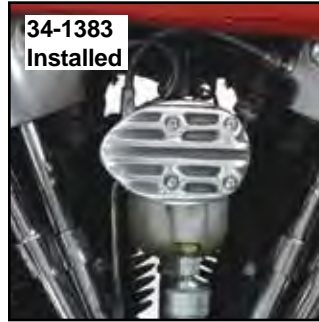

**Linkert Detent Ball Tool** will fix ball and spring for detent on needle and choke. **VT No. 16-0564**

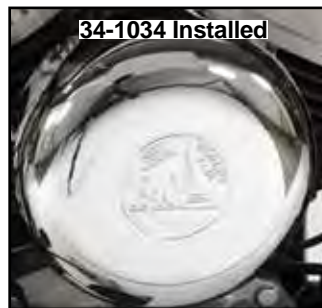

**Chrome Air Cleaner Assembly** includes backing plate and element for left side.

VT No.	Item	Side
34-1034	Assembly	World's Fair
34-1359	Assembly	Bird
34-0907	Copper Mesh Element	
34-0499	Backing Plate	
<b>Cover Only</b>		
49-8320	Smooth, Raw	Right and Left
34-1333	World's Fair, Chrome	Right and Left





# Replica Linkert Carburetor Hardware

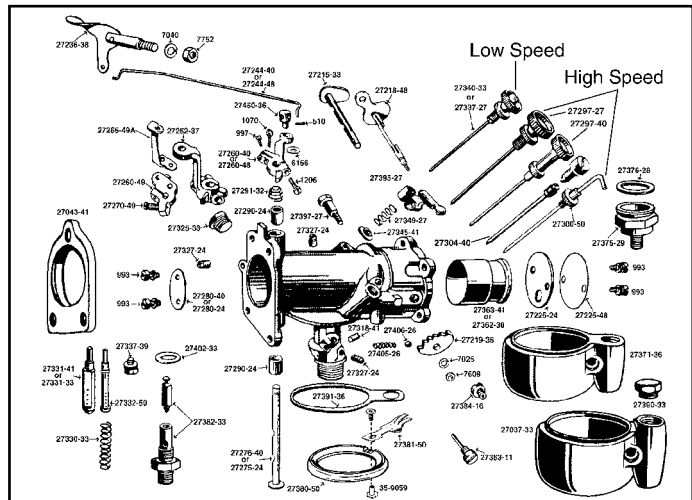

VT No.	OEM	Item
35-0482	27037-33	Early Float Bowl
35-0541	27043-41	45" WLA Spacer
35-0511	27215-33	Choke Shaft, 45" and SV BT
35-1254	27218-36	Choke Shaft OHV
35-1065	27218-48	Choke Shaft OHV
35-0488	27218-36	Choke Shaft BT 1936-47 All
35-0493	27219-36	Air Intake Shaft Stop
35-0940	1232-24	Choke Disc
35-9251	27225-24	Choke Disc, 1930-47 1 1/2"
35-0489	27225-48	Choke Disc Big Twin
N/A	1238-33	Lever VL 1933-36
35-9081	27252-37	Lever, ULH and 45", 1935-48
35-0483	27260-40	Lever, 1940-47 Overhead Valve
35-0797	27260-40	Lever, 1940-47
35-0445	1238-36	Lever, 1940-47
35-0784	27260-40	Lever, 1940-47
35-0495	27260-49A	Throttle Lever Bracket BT
	27265-49A	With arm, Set
31-1257		Arm Only
13-9241	27270-49	Lever Screw Spring
35-9062	27275-26	Throttle Shaft, 1"
35-9060	27275-24	Throttle Shaft, 1 1/4"
35-9152	27276-40	Throttle Shaft BT, 1 1/2"
35-9192	27276-40A	Throttle Shaft BT, 1 1/2"
35-0958	27280-34	Throttle door, 1" #12
35-9061	27280-24	Throttle door, 45", 1 1/4" #13
35-0860	27280-24A	Throttle door, 45", 1 1/2" O.S. +0.30
35-0679	27280-40	Throttle door, 61", #12
35-0861	27280-40A	Throttle door, 61", 1 1/2" O.S. +0.25
35-0492	27280-51	Throttle disc (9-X) BT 1 1/2"
35-0862	—	Throttle disc Oversize +.030
10-0742	27290-24	Shaft Bushing Set
35-0473	—	Nylon Shaft Bushing Set
13-0157	27291-32	Shaft spring
35-0999	27297-27	HS Needle Valve
35-9098	27297-27	HS Needle Valve, 45", BT
35-9109	—	As Above, Oversize
35-9045	27297-30	HS Needle M-18
35-0460	27298-40	HS Needle, WLA, Fixed
35-0475	27297-40	HS Needle Valve 1940-49 Big Twin
35-9055	27300-50	HS Needle Valve 1950-65 Big Twin
35-0395	27304-40	Linkert Needle Valve Lock Screw
35-9121	27318-41	1941-43 45", 1941-54 Big Twin Fixed Jet
35-9122	27318-50	1951-65 Big Twin Fixed Jet #18
35-9125	27318-51	1951-65 Big Twin Fixed Jet #19
35-9064	27325-33	Idle Body Plugs 5/16", 5 pk
2681-4	27325-33	Idle Body Hole Plug Kit, Brass finish
35-0524	27327-24	Idle Passage Plug, 5 pk
35-0554	27327-24	Idle Passage Plug Set
13-0156	27330-33	Nozzle Spring, 10 pk
35-0481	27331-33	Main nozzle SV 1933-53

35-0478	27331-40	Main nozzle OHV 1940-51
35-0494	27332-50	Main nozzle Big Twin, 74B
35-1066	—	Main nozzle, Bomb site
35-9056	27337-27	Low Speed Needle Valve, All
2695-5	27337-27	Low Speed Needle Valve
2695-5T	—	As Above, V-Twin
2696-5	27337-27	Low Speed Needle Valve
35-0477	27340-33	1" Low Speed Needle Valve
2707-5	27340-33	1" Low Speed Needle Valve
2708-5	27340-33	1" Low Speed Needle Valve
35-9051	27345-41	Spring collar
13-0158	27349-27	Needle Valve Spring
35-0479	27362-30	1 1/8" Venturi (45's)
35-0491	27363-41	1 5/8" Venturi (M74B)
35-1452	—	Kit
35-0546	27371-36	Bowl Assembly
35-0490	27371-36	Bowl (Late)
35-0482	27037-33	Float Bowl
35-0824	—	Early Float Bowl
35-0825	—	Float Bowl, Early
35-0241	—	Float Bowl, Late
8901-4	27375-29	Late Float Bowl Pins
8902-4	27375-29	Lock Nut, Chrome
15-0232	27376-28	Lock Nut, Cadmium
35-9065	27377-39	Nut Gasket
15-0761	—	Bowl Drain Screw
35-4573	27380-50	Washer for Above
35-9153	27381-50	Brass Float
35-9053	27381-50	Replica Float Lever
35-9059	—	Float Lever
35-0502	27382-33	Nut Plate and Screw
35-0545	—	Needle and Seat
35-0822	27382-33	Needle and Seat
35-0833	—	Needle and Seat Replica
35-9063	27383-11	Viton Needle and Seat Replica
35-9326	27383-11A	Float Pivot Pin with Caps
35-9047	—	Float Pin with Caps
35-0250	27390-33	Float Pin and Cap Set
15-0534	—	Bowl Valve Cover Cap
15-0304	27391-36	Cap Gasket
35-9052	27395-27	Bowl Gasket
35-0781	27397-27	Needle Valve Lever
35-9054	27397-27	Needle Valve Lever
13-0159	27405-26	Valve Lever Shoulder Screw
35-9070	27406-26	Choke Detent Ball Spring
35-0207	27450-36	Detent Ball
		Cable Block End

## Linkert Choke Shaft Kits.

VT No.	Fits
35-1281	1 1/2" M74B
35-1282	1 1/4" M51, M88
35-1285	1 1/2" SV



VT No. 35-0220 Installed



**Keihin and CV Idle Screw** allows for easier adjustment by hand. VT No. 35-0220



**Keihin Allen Screw Kit** includes chrome allen screws as required on 1976-89.

VT No. 35-0206

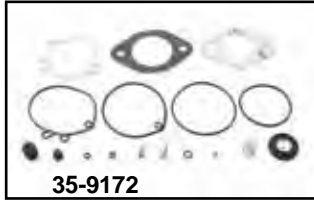

35-9172



35-9176



35-9279

**Deluxe Carburetor Kits** include pieces shown for 1976-89 Keihin carbs.

VT No. Type

35-9172 Stock

35-9176 Viton

35-9279 Replica



**Plastic 90° Keihin Carburetor Fitting** replaces 27371-76. VT No. 40-0534



**Accelerator Pump Kit** improves throttle response on 1979-88 type Keihin carburetor models with a greater volume of fuel from the pump circuit. VT No. 35-9050



**Keihin Adjustable Main Jet.** Fully adjustable for maximum tuning efficiency. VT No. 35-0369



**High Flow Fuel Inlet** replaces broken fuel inlet to the carburetor bowl for modified engines. Fits all Keihin carburetors (Butterfly and CV) 1976-up Shovelhead, Evolution and TC-88.

VT No. 35-0134



**Slow Jet Screw Driver** facilitates removal of Keihin slow jets with no damage to jet.

VT No. 16-0546

# Keihin Carburetor



35-1972



35-0179

**ThunderJet Accelerator Jet and Accessories** mounts in all Bendix-Keihin, S&S, Flowmaster, Tillotson, and CV carburetors. Choke must be deleted for use. Works on Venturi vacuum principle as third jet. Extra jets included.

VT No. Type

35-1972 ThunderJet Bendix Keihin, S&S E series

35-0179 ThunderJet for S&S G and D carburetor

35-9244 Replacement Fuel Tube



**Keihin Low Speed Jets** fit 1976-89 Keihin carbs, except CV.

VT No. OEM MM

35-0297 27896-79 .65

35-0294 27894-78 .68

35-0296 27897-78 .72

35-0295 27382-77 .75

35-0299 27348-77 .88

35-0298 27348-76 1.00



**Keihin Main Jets.**

VT No. OEM MM

35-0357 27419-76 1.65

35-0358 27418-76 1.70

35-0359 27417-76 1.75

35-0361 27416-76 1.80



**Needle Jet Seat Cutter** eliminates gasoline seepage from around the needle jet. Creates a smooth and concentric seat. VT No. 16-0095

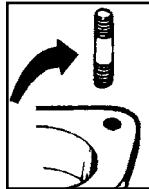

**Carburetor Mount Stud Sets.**

VT No. OEM Years Size

12-2099 33298-65 1965-77 5/16 x 1 1/2

12-2126 24824-67 1967-70 3/8 x 2

12-2110 29254-78 1978-89 5/16 x 1 1/4

## Carb Kit



**Eliminator II SU Carburetor Kit** includes upswept polished manifold and float bowl and a shortened dome to fit Evolution engine with a 3.5 or 5 gallon tank. Upswept manifold design creates as much as 20% horsepower gain while smoothing out performance over the entire RPM range. Also allows leg clearance when using 5 gallon tanks because the carburetor is tucked in close. Kits include chrome leveling bracket, manifold, necessary mounting bolts, push pull throttle bracket and installation instructions. Fits 1966-84 Shovelhead.

VT No. 35-0050



**Mikuni HSR 42 Carburetor Kit** for 1970-84 Big Twin models. \*Note: Includes carburetor, manifold and air cleaner assembly. VT No. 35-9118

**SU Carburetor Replacement Parts**

VT No. Application  
35-4551 Rebuild kit for Eliminator SU carburetor  
35-4554 4 1/2 oz piston return spring (red)  
35-4555 8 oz piston return spring (silver)  
35-4556 12 oz piston return spring (green)  
35-4557 Standard (BBX) tapered needle  
35-4558 Slightly leaner (BBT) tapered needle







# Bendix Carburetor Kit



**Bendix Carburetor Kit** fits Shovelhead engines 1966-84 FX and FL. Kit includes 38 mm Bendix carburetor with adjustable main jet, throttle handle with grips, cable with bracket and 7" round logo air cleaner with support. Kit also includes seal adapters to use on pre-1978 O-ring heads.



**Bendix Carburetor** has 38mm Venturi and 40mm throat. Complete with choke, accelerator pump, and built-in return spring. This complete unit bolts onto all Big Twins from 1971-75 as stock replacement.

VT No.	MM	Type	Cable	Finish
35-0021	38	Fixed	Single	Cast
35-0060	38	Adjustable	Single	Cast
35-0022*	40	Adjustable	Dual	Cast

\*Note: A new choke cable bracket and cable/knob assembly will need to be fabricated for installation on Big Twins 1983-88 and 1986-89 XL.

### Bendix Carburetor Replacement Parts.

VT No.	OEM	Item	Brand
35-0507	27630-71	Float	Facet
35-4577	27645-71	38mm Float bowl	Facet, Plain
35-9250	—	40mm Float bowl	Facet, Plain
15-0147	27646-71	Bowl gasket	10 pack
35-0203	27762-71A	Pump	V-Twin
35-9132	27389-71	Pump boot	Accel
13-9242	27659-71	Float Pin Spring	10 pack
35-0424	—	Float Needle	38mm
35-0425	—	Float Needle	40mm
35-0533	—	Idle Jet Tube	
12-2557	27271-71	Throttle Stop Screw	
13-9223	27613-71	Throttle Stop Screw Spring	



**Idle Adjusting Screw** allows for the ease of adjustment with the "T" handle design. VT No. 35-0221



**Dell'Orto Pumper Air Cleaner Flat Adapter** allows use of Bendix air cleaners. VT No. 34-1060



**Dell'Orto Spigot Carburetor Adapter** has an O-Ring seal with steel flange. VT No. 35-9076



**38 mm Dell'Orto Spigot Carburetor** has an o-ring seal on spigot. VT No. 35-0238

VT No. Year Model  
35-0099 1966-84 Shovel  
**Carburetor Flange Gaskets**

VT No.	Type	Fits
15-1092	Flange	1965
15-1085	Flange	1971-1973



**Bendix Repair Kit** is complete as shown including accelerator-pump for all 38 and 40mm, stock or adjustable jet carburetors. replaces 27132-71.

VT No.	MM	Brand
35-4570	38	Facet
35-0201	38	V-Twin
35-9164	40	Facet



**Adjustable Main Jet Conversion Kit** fits all Bendix carburetors.

VT No.	Item
35-0202	Jet Kit
16-0865	Jet Tap 3/32" — 32, Some early carburetors require drilling and tapping for jet installation.

### Bendix Main Jets.

VT No.	OEM	Size
35-9143	27651-75	.095
35-9144	27652 75	1.00
35-9145	27653-75	1.05
35-0198	27654-75	1.10
35-9146	27655-75	1.15
35-9147	27656-75	1.20
14-0520	O-ring	10 pack



**Chrome Allen Screw Kit** is for Bendix 38 and 40mm carburetors. Includes bowl screws. VT No. 37-0506



**Air Cleaner Support Brackets** to fit S&S Super 'E' and 'G' on 1966-82 FL-FX. VT No. 34-0336

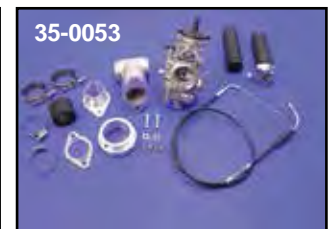

**Dell'Orto Pumper** features adjustable accelerator pump and choke. Kit includes throttle assembly, cable, grips, air cleaner adapter and carburetor adapter to fit side valve three bolt manifolds.

VT No.	Item	Model
35-0059	38mm Kit	Side Valve
35-0053	38mm Kit	Panhead
35-0030	38mm Kit	Shovelhead
35-0031	40mm Kit	Shovelhead
36-2550	Replacement Throttle Cable	for 38 and 40mm
35-0386	Primary Jet	#45
35-0945	Emulsion Tube	#262



# Linkert Intake Manifold

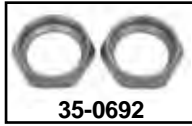

**Complete Manifold Kit** fits 1955- 65 BT. VT No. 35-0373



**1940-54 Big Twin Overhead Manifold Kit** is constructed of cast iron and includes brass seals, nuts, screws and gaskets to fit Knuckle and Panhead models.

- |                           |                                |
|---------------------------|--------------------------------|
| <b>VT No.</b>             | <b>Item</b>                    |
| 35-0043                   | Replica Kit, Complete          |
| 7104-2                    | Seal Set                       |
| 35-0826                   | Kit Nut/Seal                   |
| 2905-2                    | Brass OS Seal Set              |
| 7103-2                    | Chrome Nut Set                 |
| 7614-4                    | Cadmium Nuts, with Seals       |
| 9718-4                    | Parkerized Nut Set             |
| 9718-4T                   | Nuts                           |
| 10-0471                   | Inserts                        |
| 15-0262                   | Insulator Only                 |
| 35-0692                   | Intake Manifold Nut Set        |
| 35-0735                   | Intake Manifold Brass          |
| 15-0535                   | Gasket                         |
| <b>1936-39 61" 3 Bolt</b> |                                |
| 35-0064                   | Manifold Only 1936-39          |
| 35-0547                   | Manifold Only, Nickel          |
| 35-0048                   | Nickel Manifold Kit            |
| 35-0346                   | Cadmium Manifold Kit           |
| 35-0863                   | Brass Seals/Parkerized Nut Kit |
| 15-0539                   | Insulator Kit                  |
| 35-0885                   | Spacer                         |



<b>Nuts</b>	<b>Finish</b>	<b>Seals</b>
8012-2	Chrome	8006-2
9702-2	Parkerized	8006-2
8007-2	Cadmium	8006-2
9702-2T	Parkerized	8006-2T

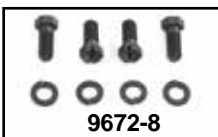
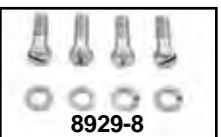

**Linkert Carburetor Mount Screws.** Carb to manifold, 4 pack.

<b>Cadmium Chrome</b>	<b>Prkrzd</b>	<b>OEM</b>	<b>Type</b>
8159-8	8158-8	9672-8	27422-39 Short
8930-8	8929-8	9664-8	47248-48 Long

**Note:** Long is for use with insulator block



**Manifold Wrenches** large type, heavy duty for shop use.

<b>VT No.</b>	<b>OEM</b>	<b>Size</b>	<b>Use</b>
16-0110	94537-26	1 7/8"	45" Manifold
16-0112	94538-30	2"	SV Manifold
16-0109	94538-48	2 1/8"	BT Manifold

**"Rubber Band" Type Intake Manifold Conversion Kit** for 1940-54 Knucklehead and Panhead eliminates troublesome intake manifold leaks common to Knucklehead and Panheads with worn and distorted "plumber" style manifold components.

- |               |   |
|---------------|---|
| <b>VT No.</b> | <b>Item</b>   |
| 7314-9        | Complete Kit contains cast manifold, two conversion nipples, two nipples to cylinder head seals, two nipple to manifold seals, two rivets and four carburetor mounting screws |
| 7315-3        | Manifold only (Colony Alloy)  |
| 35-0124       | Manifold only (Replica Steel)   |
| 7344-6        | Steel Conversion Nipple Kit, 1940-54 OHV 74   |
| 7627-4        | Aluminum Weld-in Nipple Kit only  |

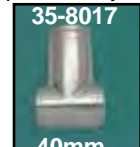

**Panhead Manifolds.**

- |               |               |
|---------------|---------------|
| <b>VT No.</b> | <b>Type</b>   |
| 35-0106       | S&S           |
| 35-0941       | 1 7/8"        |
| 35-8017       | Spigot        |
| 35-0103       | Bendix-Keihin |



**Intake Manifold Nipples** have threaded inserts, sold each. Screws into head.

- |               |             |                         |
|---------------|-------------|-------------------------|
| <b>VT No.</b> | <b>Fits</b> | <b>Models</b>           |
| 7119-2        | 1940-54     | Overhead Valve 74       |
| 10-0471       | 1940-47     | Overhead Valve 74, pair |
| 10-0472       | 1948-54     | Overhead Valve 74, pair |
| 2230-6        | 1948-54     | Overhead Nipple Bolts   |
| 2636-10       | 1937-47     | Nipple Pin              |
| 11-1211       | 1948-54     | Nipple Pin              |



**Linkert to Bendix Adapter** mounts to 3 or 4 bolt stock manifold to allow use of Bendix or Spigot carb.

- |               |             |                      |
|---------------|-------------|----------------------|
| <b>VT No.</b> | <b>Type</b> | <b>To</b>            |
| 35-0113       | 4 Bolt      | Bendix               |
| 35-0216       | 3 Bolt      | Adapter Kit          |
| 35-0117       |             | Spigot Rubber        |
| 35-0234       |             | Carb Needle and Seat |
| 35-0343       | 3 Bolt      | Spigot               |
| 35-0344       | 4 Bolt      | Spigot               |
| 35-0271       |             | 3 Bolt Kit           |







# Intake Manifold 1966-84



35-0085



35-0084

**Stock Intake Manifolds** are of cast alloy as original.

VT No.	Fits	Type
35-0085	1966-77 FX	O-Ring
35-0084	1978-84 FX	Flat Seal



35-8016



35-9136

**Spigot Manifold** for 1966-84 Shovelhead, and 1957-84 XL for accepting 38-40mm Mikuni or Lectron carburetors. Order rubber adapter separately.

VT No.	Item
35-8016	Manifold
35-9136	Rubber Adapter

**S&S Manifolds** are replacements for all S&S B& E 1 $\frac{1}{8}$ " Super carburetors or can be used as stock replacements.

VT No.	Year	Type
35-0101	1966-77 Big Twin	O-Ring
35-0109	1966-77 Big Twin	.200 longer cylinder
35-0102	1978-84 Big Twin	Flatseal
35-9184	1978-84 Big Twin	.200 longer cylinder



**CV Carburetor Adapter** adapts HSR-42 Mikuni or CV carburetor to two bolt manifold. Use spigot seal VT No. 14-0180. Fits two bolt early style. **VT No. 35-9150**



35-0140

**CV Carburetor Adapter and Bracket Kit** with choke mount cable for 1971-84 Shovelhead. Includes necessary hardware for installation. Fits 38 or 44mm.

**VT No. 35-0140**



**Linkert Drill Service Kit** as original. Full instructions for this on our website.

VT No.	Item
16-0563	Kit
16-1406	Linkert Carburetor Idle Slot Tool

## Dash Mounted Choke Control



Taps used on Linkert.  
Taps for Body are:

1. #10-32
2. #12-24
3. 1/4 -40
4. 5/16-18
5. 5/16-32



15-0141

**Manifold Spacer** replaces 29250-78 on 1971-88 models.  $\frac{3}{8}$ " thick.

VT No.	Item
15-0141	Stock Spacer, each
15-0142	Gaskets, Non-beaded
15-1144	Gaskets, Beaded
15-1019	Spacer Kit, James (1 $\frac{3}{4}$ " inner diameter) Stock
15-1162	Spacer Kit, James (1 $\frac{3}{16}$ " inner diameter) Custom



**Carburetor Spacers** for S&S are available in 1" or  $\frac{3}{8}$ " thickness for spacing out 1 $\frac{7}{8}$ " carburetors on models with five gallon tanks.

VT No.	Size
35-0105	1"
35-0086	$\frac{3}{8}$ "
14-0957	Super 'E' Carburetor Base, O-Ring



35-9136



35-0117



35-0194



35-4574



35-9162



35-0098



35-0088

## Carburetor Adapters.

VT No.	Carb Size	Type
35-9136	36-45 mm	Spigot Rubber
35-0117	42-42 mm	Spigot Rubber
35-0194	40-44 mm	Spigot Rubber
35-4574	36-38 mm	Flange Adapter
35-9162	40 mm	Flange Adapter
35-9340	42 mm	Flange Adapter
35-9341	46 mm	Flange Adapter
35-0098	38 mm	2 Bolt Adapter with rubber
35-0088	38 mm	2 Bolt Adapter



35-0411

**1966-77 Intake Manifold Rings** update early style O-Ring intake manifolds or cylinder heads to late style flat band type seals. Available for stock or stroker .200 taller cylinders. Set includes four standard and two stroker rings.

VT No.	Type	Quantity
35-0411	Adapter Rings, Stock	10
35-0412	Stroker Rings	10
35-0429	Set	

YouTube



Watch Our Video!  
<http://www.youtube.com/user/TeddCycle>



# Mikuni Carburetor



**Mikuni HSR 42 Carburetor Kit** for 1970-84 Big Twin models. \*Note: Includes carburetor, manifold and air cleaner assembly. **VT No. 35-9118**



**Mikuni Carburetor Kits** 38mm for all FL-FX. Includes air cleaner, carburetor, manifold adapter, hose clamps, main and pilot jet assortment and throttle cable. Fits 1966-up Shovelheads, 1957-up Sportster, Note: 1948-65 must use VT No. 35-0103 Manifold not included in kit.

- VT No. Item**  
**35-0010** Complete Kit  
**34-0567** Air Cleaner  
**36-0105** Cable  
**35-0071** Throttle Handle Assembly

## Intake Manifold Clamp



**V-Twin's 360° Power Intake Clamp** is full stainless steel which features a "floating bridge." Closes the gap under the "T" bolt for total 360° wrap around seal. The best available sold as a set with O-Rings or seals.

VT No.	Power	Type	U/M
<b>35-0415</b>	<b>35-0449</b>	1955-77	O-Ring Kit
<b>35-0409</b>	<b>35-0448</b>	1978-84	Flat Seal Kit
<b>14-0519</b>		1957-77	O-Rings 10 pack
<b>14-0113</b>		1978-85	Flat Seals 10 pack



**Intake Clamp Update Kit** for 1967-84 models. Kit includes manifold rings, Silicone seals and stainless clamps. Use to update early intakes to late style seals or when intake flanges are damaged on early heads.

**VT No. 35-0436**



**1978-84 Intake Clamp Set** includes four pieces of single use clamp, installed by VT No. 16-0050 tool.

**VT No. 35-0419**



**Stock Style Intake Clamp Sets** include O-ring or seals for proper year and feature fillister or allen screws as original. Available in chrome or stainless.

VT No.	Year	Finish	Screw
<b>35-0408</b>	1955-77	Chrome	Allen
<b>35-9177</b>	1955-77	Stainless	Fillister
<b>35-0410</b>	1978-84	Chrome	Allen
<b>35-0418</b>	1978-84	Stainless	Fillister



**Polished Stainless Intake Manifold Clamps** are strong yet easy to install. Fit all 74" 1955- Early 78 and Sportster 1957 Early 1978 models with O-rings.

- VT No. Item**  
**35-0407** Clamp Kit  
**14-0519** O-Rings 10 pack



**V-Twin Style Intake Clamps** are two piece type polished brass or chrome.

VT No.	Years	Type	Finish	Note
<b>35-0406</b>	1955-77	O-Ring	Chrome	No Seals
<b>35-8026</b>	1978-84	Flat Seal	Chrome	No Seals
<b>35-0193</b>	1957-77	O-Ring	Brass	Seals
<b>35-0192</b>	1978-84	Flat Seal	Brass	Seals

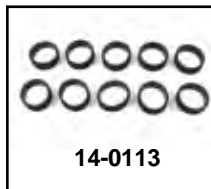

**Intake Manifold O-Rings and Seals.**

James	VT No.	Year	Type
—	<b>14-0519</b>	1955-77 FL	O-Ring
<b>14-0626</b>	<b>14-0113</b>	1978-85	Flat Seal
—	<b>14-0924</b>	1978-85	Flat Seal Red Silicone

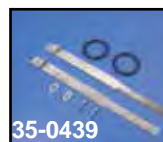

**Replica Intake Clamp Set** features fillister head screws.

VT No.	Year	Finish
<b>35-0417</b>	1955-56	Cadmium
<b>35-0439</b>	1957-76	Cadmium
<b>35-0443</b>	1957-76	Zinc
<b>35-0440</b>	1977-84	Zinc





# Internal Throttle Part

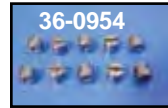
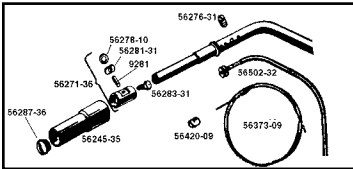

Throttle Control Parts listed fit 1936-48, except noted.

VT No.	OEM	Item
49-0150	56271-36	Plunger, Complete Kit, each
9505-2	3316-36	36-48 Big Twin Plunger only, pair
49-2005	56245-31	Spiral
49-0956	56276-31	Screw, 10 pack
7626-2	56287-36	Cadmium End Nut, pair
7626-2T	56287-36	Cadmium End Nut, pair
7625-2	3330-31	Cadmium End Nut, pair
8923-8	9261	Pin
	56281-31	Kit for
	56278-10	Two Sides
12-1156	9281	Throttle Pin, 4 pack
49-0240	56278-10	Collar, Throttle
49-2049	56278-10A	Collar, Throttle, 1910-72
36-0950	56502-32	Outer
36-0953	56379-09	Wire
49-0156	56283-31	Wire Screw, 10 pack
49-0950		Throttle Wire End, 1936-48
36-0954	56420-09	Wire End, 10 pack

## Inner and Outer Throttle Spark Casing Assembly.

VT No.	OEM	Years	Type
49-0801	Set	1932-48	Replica Set
36-0907		1936-48	54" includes inner
36-0950	56502-32	1932-48	Outer, Vinyl
36-2579	56502-32	As Above	Cotton braid
36-2578	—	1909-31	Outer Nickel Plated
36-0958	3743-09	1909-31	Nut for Above
36-0951	56528-49	1949-53	Outer Vinyl
36-0956	—	As Above	Cotton braid
36-0979	—	1949-53	Cotton braid Set
36-0960	Set	1954-59	Cotton braid Set
36-0952	56502-54	1954-72	Outer Vinyl
36-0953	56373-09	1917-72	Inner Wire Set
36-0954	56420-09	1909-48	Wire End
36-0139	—	1936-71	Wire Pull



**Carburetor Cable Block** attaches inner choke or throttle cable on Linkert and Bendix carburetors. Includes screw and cotter pin.

VT No. 35-0207

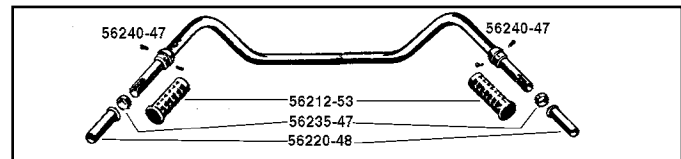
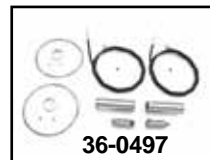
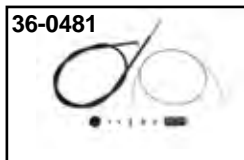

Throttle Control Parts range from 1917-72.

VT No.	OEM	Item
49-0650	56220-48	Grip Spiral
49-0651	56235-47	Grip Retainer, 2 pack
49-0652	56240-47	Grip Screws, pair
49-0653	56391-49	Plunger, each
36-0951	56528-49	Outer Control Casing
49-0956	56276-31	Cable Plug Screws, 10 pack
36-0953	56373-09	Inner Wire Set
36-0497	Kit	Above Parts, both sides
36-0073		Inner Wire Set

**Throttle Spirals and Cable Kits** include all internal parts for years listed. The 1936-48 type features chrome throttle spirals. Grips are not included.

VT No.	Years	Sides	Throttle Type
36-0481	1936-48	2	None
36-0498	1936-48	2	Push
36-0497	1949-53	2	Push
36-0499	1954-73	2	Push
36-2551	1954-73	1	Push
36-2574	1954-73	1	Pull



## Handlebar Spirals.

VT No.	OEM	Years	Type
49-0227	3312-16	1916-34	Push, Chrome
49-2005	56245-35	1935-48	Push, Chrome
49-0857	Set	1935-48	Push, Chrome
49-2065	—	1935-48	Push, Oversize
49-1571	1/2 Turn	1935-48	Push
49-0087	—	1936-48	Pull
49-0650	56220-48	1949-53	Push
49-0662	—	1949-53	Push, Oversize
49-0158	56220-53	1954-70	Push
49-0911*	56220-58	1971-74	Throttle Pull
49-1324	Flanders		Push
49-1371	Flanders		Pull
49-1578	1/2 Turn		Pull

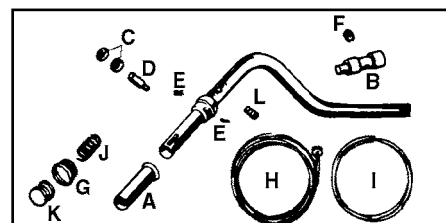

Throttle Control Parts range from 1917-72.

VT No.	#	OEM	Item
49-0158	A	56220-53	Spiral, Push
49-0911	A	56220-58	Spiral, Reverse, Pull
49-0159	G	56288-53	Zinc Plug, pair
9214-2	G	56288-53	Cadmium Plug, pair
8924-8	C and D	56278-10	Roller and Pin
		9261	Kit
49-0161	E	2594	Screw
49-0162	F	3207	Screw
49-0163	B	56400-53A	Plunger
9514-2	B	56400-53	Plunger
36-0952	H	56528-49	Outer Casing
36-0953	I	56373-09	Wire
13-0215	J	56216-53	Spring
28-0625	K	56239-53	Grip End Plug, Zinc, pair
49-0956	L	56276-31	Screw, Handlebar Plug
36-0499			Kit includes All Parts Above for Both Sides

\*Note: Reverses direction on 1954-70 throttle



# Throttle Cable

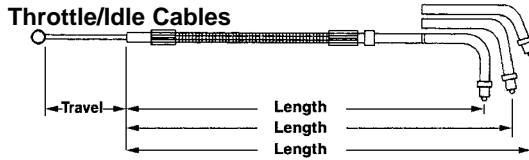

**Big Twin Throttle/Idle Cable Assemblies** Throttle/Idle Cable Assemblies are available in black vinyl or braided stainless covering with correct end fitting for each application, also available in overstock length. Assemblies unless noted.

V-Twin Stainless	V-Twin Black	Barnett Stainless	Barnett Clear	Barnett Black	OEM	Length/Fits
—	—	36-1500		36-2460	56389-74	Stock 1974-75 All
—	—	36-1501		36-0107	—	+6" Extension As Above
36-0901	36-0102	36-1502		36-2461	—	+8" Extension As Above
—	36-0103	—		36-2462	56313-76	Stock 1976-80 All
—	36-0357	36-1503		—	—	+6" Extension As Above
—	—	—		36-2463	—	+8" Extension As Above
36-0903	36-0101	36-1504		36-0948	—	+12" Extension As Above
—	—	36-1505		36-2464	56324-81	Stock 1981-89 FX-FLH-FXST-FLST Throttle Cable
—	36-2558	—	36-0636	36-2465	—	+8" Extension As Above
36-0902	36-0100	36-1506		—	—	+12" Extension As Above
—	—	36-1507		36-2466	56323-81	As Above, Stock Idle Cable
—	36-2557	—		36-2467	—	+8" Extension As Above
—	—	—		—	—	+12" Extension As Above
—	—	—		36-2468	56328-81	Stock 1981-89 FLT-FLHT Throttle Cable
—	—	—		36-2469	56327-81	As Above, Stock Idle Cable



**Barnett Carburetor Conversion Throttle/Idle Cables.** Order by carburetor and throttle type. For use with stock type Push-Pull Throttle handles except as noted.



Mikuni Carburetors, 38 and 40mm	Stainless	Stainless	Black	Length	Cable
—	—	36-1542	36-2493	38"	Throttle Unv., Single
—	—	36-1543	36-2494	46"	Throttle Unv., Single
—	—	36-1544	36-2476	38"	Throttle 1976-80 Single
—	—	36-1545	36-2541	43"	Throttle 1981-95 Single
<b>Mikuni HS40</b>	—	36-1546	36-2543	41"	Throttle 1981-95
—	—	36-1547	36-2542	41"	Idle 1981-95
<b>Mikuni HS 42/45</b>	—	36-1550	36-2585	36"	Throttle 1981-95
36-0667	36-1551	36-2586	37"	Idle	1981-95
<b>Keihin</b>	—	36-1554	36-2477	38"	Throttle Unv., Single
—	—	36-1555	—	46"	Throttle Unv., Single
<b>S&amp;S Super 'B' or Bendix</b>	—	36-1556	36-2474	37"	Throttle 1976-80
<b>S&amp;S Super 'E' &amp; 'G' and Screamin' Eagle</b>	—	36-1563	36-2545	38"	Throttle 1981-95
—	—	36-1564	36-2544	38"	Idle 1981-95
<b>Dell'Orto Pumper</b>	36-0670	—	36-2550*	40"	Throttle Unv, Single
<b>Dell'Orto Dual Throat</b>	—	—	36-2581	39"	Throttle 1981-95
—	—	—	36-2582	39"	Idle 1981-95
<b>Universal Throttle Cables by V-Twin</b>	36-0905	—	—	30"	Ball and Barrel Ends
—	—	—	36-0104	43"	Barrel End
—	—	—	36-0112	60"	Barrel End
—	—	—	36-0105**	38"	38mm Mikuni Ball End

\*Note: Two elbows

\*\*Note: 90 degree elbow fitting



**Chrome Throttle Cable Support Bracket.** for all Twins with Bendix carburetor. Replaces 27459-74.  
VT No. 35-0208



**Clear Coated and Stainless**  
**Black Matched Stock and Idle Cable Assemblies** with 45 degree elbow fittings for Big Twins.

Stock	+8"	Years	Model
36-0860	36-0863	1981-89	Softail, FLH



**Stainless Steel Braided Cable Set** by M&M features clear coating for throttle and idle applications and 45 degree elbow fittings.

VT No.	Year	Model	Length
36-0855	1981-89	FX-FLST	Stock
36-0868	1981-89	FX-FLST	+8"
36-0114	1982-95	S&S	42"
36-0115	1982-95	S&S	54"



**Spiral Chrome Throttle Cable** in stock length. Fits 1976-80 throttles.  
VT No. 36-0511



**Clear Coated**



**Barnett Clear Coat Braided Stainless Throttle Cable Sets** include throttle and idle cable.

VT No.	Year	Model	Length
36-0832	1981-95	S&S Super E,G, Screamin' Eagle	33"
36-0830	1981-95	S&S Super E,G, Screamin' Eagle	38"
36-0832	1981-89	FX, FLH, FXST, FLST	Stock
36-0833	—	As Above	+8"



**60" Chrome Cable Wrap** is a classic 1950's style dresser trim item. Inner diameter size noted. Sold each.

VT No.	Size
36-0520	5mm
36-0521	6-7mm
36-0525	8-11mm





# Clutch Cable

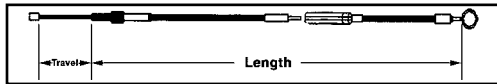

Clutch Cable



**Big Twin Clutch Cable Assemblies** feature heavy duty construction designed for reliability and longer service. Assemblies are available by V-Twin or Barnett in black vinyl or braided stainless covering.

V-Twin Stainless	V-Twin Black	Barnett Stainless with Clear Coat	Barnett Black	OEM	Fits	Length
36-0500	36-0400	36-1526	36-2355	38618-52	Stock 1952-67 Big Twin with mousetrap	31"
—	36-0401	—	—	—	+4" Extension. As Above	35"
—	—	36-1527	36-2356	—	+8" Extension. 1952-67 Big Twin	39"
36-0502	36-0402	—	—	38618-68	Stock 1968-83 Big Twin, 1984-85 FXST, 1986 FXWG	52.56"
—	36-0403	—	—	—	+4" Extension. As Above	56"
36-2521	—	—	—	—	+8" Extension. As Above	60"
—	36-2536	—	—	—	+12" Extension. As Above	64"
—	36-0411	36-1528	36-2496	38618-68	Stock 1968-83 Big Twin, 1984-85 FXST, 1986 FXWG	51.625"
—	—	—	—	—	Nylon Lined Small Diameter Casing	—
—	—	36-1529	36-2497	—	As Above	59.75"
—	36-0398	—	—	38618-68	Stock 1968-83 Big Twin, 1984-85 FXST, 1986 FXWG	52.25"
—	—	—	—	—	Extreme duty 1/2" diameter type	58.25"
—	36-0399	—	—	—	+6" Extension As Above	—
—	—	36-0692	36-2359	38599-80A	Stock 1980-82 FLT-FXR-FXRS 1/8" Cable	57.75"
36-8058	—	—	—	38599-80B	Stock 1980-82 FLT-FXR-FXRS	55.44"

# Handle Assembly



**Clutch and Brake Lever Assemblies** include cable pin. Available chrome or polished with 3/8" or 5/16" hole sizes for cable entry. **Note:** VT No.



26-2167 and 26-2168 accept front brake switch.  
**Chrome Polished OEM Hole Fits**  
**26-0523 26-0524** 38608-68 3/8" 1968-72 Big Twin Clutch  
**26-0525 26-0526** 45002-65 5/16" 1941-68 Big Twin Brake  
 1952-67 Big Twin Clutch  
**26-2167 26-2168** 45002-69 5/16" 1969-72 Brake Big Twin



**Complete Replica Lever Assemblies** include slotted lever bushing as original with small hole for brake or clutch.  
 Complete **VT No. OEM Finish**  
**26-0954 26-2127** 45002-41 Chrome Complete, Brake  
**26-0953 26-2126** 45002-41 Polish Complete  
**26-0950** Polish Brake  
**26-0951** Chrome Brake  
**26-0957** Polish Brake

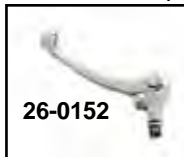

### Ball End Stainless Style Assemblies

**26-0522** Ball End 5/16" Complete  
**26-0152** Screw Polish  
**26-0779** 3/8" Hole Polish

### Lever Components

**26-2192** — Chrome Stock Lever Only  
**26-0542** — Lever Clamp Strap  
**8819-4** 45031-41 1941-64 Pin and Nut, Cadmium  
**26-0506** 45033-49 1949-64 Lever Bushing with cotter

### Hand Lever Pivot Pins for brake and clutch sides.

**VT No. OEM Item**  
**8819-4** 45031-41 1941-64 Pin and Nut, Cadmium **26-2129**  
**26-0507** 45031-65 1965-81 Pin and Clip, 10 pack  
**26-0544** — 1965-81 Pivot Pin Set with grease fitting  
**12-0939** 11036 Retaining Ring for Above, 10 pack  
**26-2129** 45032-82 Pin, each  
**12-0944** 11143 Retaining Ring for Above, 10 pack



**Chrome Clutch Cable Bracket** bolts to engine bolt to route cable away from cylinder heat, and align cable to clutch arm. Fits 1980-86 5-speed.  
**VT No. 31-4040**



**Brake Cable Clamp** is a universal style clamp.  
**VT No. 26-0508**



**Cable Clamps** are to hand lever for emergency or permanent use. Easy to install .460" diameter. (Pair)  
**VT No. 26-0509**

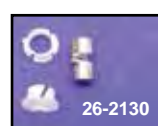
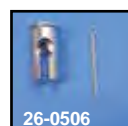
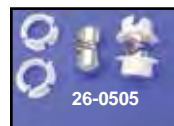

**Lever Pins/Bushings**  
**VT No. OEM Item U/M**  
**26-0505** 45036-68 1965-72 with bushings 10  
**26-2138** 45039-68 Nylon bushing 25  
**26-0506** 45033-49 1949-64, with cotter 5  
**26-2130** 45036-82 1982-87 10



**Throttle and Cable Kits** include grips, throttle idle and Barnett throttle cable with ends attached as pictured for S&S 'E' and 'G' carburetors.

- VT No. Item**  
**35-9246** 38" Complete Kit  
**35-0212** Handle and Grips only

**S&S Super 'E' & 'G' and Cables for Dual Stock Type Throttle Handles.**

Stainless	Black	Length	Type	Years
—	<b>36-2464</b>	33"	Throttle	1981-95
<b>36-0635</b>	<b>36-2466</b>	33"	Idle	1981-95
—	<b>36-2545</b>	38"	Throttle	1981-95
—	<b>36-2544</b>	38"	Idle	1981-95



**Chrome Throttle Clamp and Tube Sets** feature smooth design, upper and lower pieces with screws and nylon throttle tube, for single or dual cable applications. Sets are for use with 1982-up type cables.

- VT No. Type**  
**35-0253** Single  
**35-0254** Dual

**Radii Billet Throttle** accepts single 1982-95 throttle cable.  
**VT No. 35-0255**

**Chrome Throttle Housing** custom design for single cable operation.  
**VT No. 36-0151**

**Dual Billet Throttle Housing** for use with idle and throttle cable.  
**VT No. 36-0564**

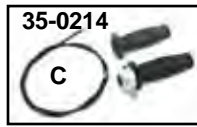

**Universal Throttle Sets** feature chrome housing with adjuster and metal twist tube. All use universal single cable.

- VT No. # Item**  
**35-0232** Single Handlebar Throttle without grips  
**35-0213** B 1" with plastic grips and cable  
**28-0215** Barnett left side grip  
**36-0104** Cable only, barrel end only, 43"  
**36-0112** Cable only, barrel end, 60"  
**36-2538** Handle ferrule with nut  
**35-0071** A 1" with Anderson rubber grips  
**28-0116** Grips for above  
**35-0347** Anderson Kit"  
**35-0779** ¼" Turn Throttle  
**35-0214** C 7/8" with Plastic grips and cable

# Throttle Cable Kit



**Throttle Kits** available in single or dual units with or without grips and chrome end plugs.

- VT No. OEM Type**  
**Single 1974-80**  
**35-0215\*\*** 36500-74 Kit with two grips  
**35-0700** Single Throttle Cable Assembly  
**35-0070\*\*** As Above As above with bracket  
**35-0211\*** 56500-74 Throttle only  
**35-0210** 56397-74 Adjuster only  
**35-1364** Black Housing

\*Note: Includes nylon tube with chrome clamps

\*\*Note: Includes chrome end plug.



**Dual 1981-up (Push-Pull).**

- VT No. OEM Item**  
**35-0237** 56395-81 Kit with grips  
**35-0212\*\*** 56395-81 Kit with grips  
**35-9352\*\*** 1981-89 Kit with black cables  
**35-9350** 1991-95 Kit with black cables  
**35-9149\*** 56324-81A Throttle Handle Only  
**35-9218** 56396-74 Friction Spring for above

\*Note: Includes nylon tube with chrome clamps.

\*\*Note: Includes chrome end plugs.



**Nylon Throttle Tubes.**

- VT No. Type Year**  
**35-9073** Single 1976-81  
**28-1981** Dual 1982-95  
**35-9870** Dual 1996-up  
**35-9871** Throttle by Wire 2008-up





# Choke Cable

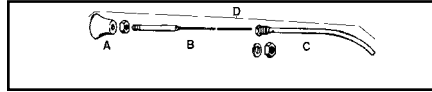

**FLH-FXST-FLT Choke Cable.**  
Complete assemblies include knob, casing and inner wire.

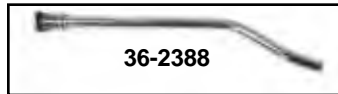

VT No.	OEM	Item	Fits
36-0989		Assembly	1967-70 FLH
36-0993	29212-71	Assembly	1971-78 FLH
36-0523	29213-79 29211-86	Casing & Wire	1979-84 FLH, 1984-89 FXST 1985-86 FXWG
36-0517		Inner wire	1971-78 FLH
36-0995	29214-71	Chrome Knob	1971-89 FLH-FXST
28-2117	27451-82	Rubber Grommet	1982-89 FLH-FXST
12-0576	27450-82	Nut	1982-89 FLH-FXST
12-1190	11013	Retaining Ring	1979-89 FLH-FXST-FLT

**FX-FXR Choke Cable Assemblies** are for years listed.

VT No.	#	OEM	Fits
36-2389	D	Kit	1973-78 FX-FXS
36-2390	D	Kit	1978-84 FX-FXS
36-0987	C	29220-67	1967-70 FL
36-2386	C	29221-73	1973-78 FX-FXS
36-2388	C	29215-78	1978-84 FX-FXS
36-2387	B	29216-73	1973-84 FX-FXS 29219-78 1979-E80
36-0994	A	29214-67	1971-84 FX Knob (Black plastic)



**Chrome Choke Cable Bracket** is for use on 1966-70 Shovelheads.  
**VT No. 31-4188**



**Chrome Throttle Cable Bracket** fits all Twins with Bendix type carburetors. Bracket replaces 27459-74.  
**VT No. 35-0208**

**Replica Cables** for stock length application. Include braided steel inner with spiral wold outer covers with black braided cotton as original Crafted in USA. Restoration quality!

VT No.	Fits	Type
36-0688	1952-64	Mousetrap
36-0545	1950-52	Brake

**Choke Cable Nut Kit** includes nut 7638, and seal 27451-82 for dash mounted choke on FL-FXWG-FXST models. **VT No. 37-8942**

# Throttle and Spark Cable Bracket



**Throttle and Spark Cable Brackets** have parkerized finish and mounting hardware as original.

## Overhead Valve (OHV)

VT No.	#	OEM	Year	Model	Type
9005-4	A	3371-36	1936-48	OHV	Throttle
31-0537	E	56605-49	1949-53	OHV	Throttle
31-0973		Parkerized	1949-53	OHV	Throttle
31-0787			1948	OHV	Throttle
2041-7	F	45218-52	1968-72	OHV	Throttle
37-9028	G	56609-52	1957-65	OHV	Throttle

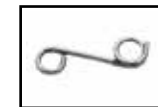

**Control Cable Guide Hook** replaces stock 45092-66 Stock on all 1966-84 FL, 5 pack  
**VT No. 31-0193**



## Braided Cable Heat Shrink Tubing.

Clear heat shrink tubing is for use on all braided stainless steel cables to prevent cable from scratching painted or chromed surfaces while still keeping that braided steel look. Kit contains four 16" long heat shrink tubes to cover two throttle cables, one clutch and one speedometer cable. Bulk tubing is in a 10 foot roll.

VT No.	Item
40-0015	Cable Sleeve Kit
40-0019	3/8" x 10' Roll
40-0020	1/2" x 10' Roll
40-0021	3/4" x 10' Roll



# Speedometer Cable



Transmission Drive Speedometer Cables					
Black Vinyl	Stainless	Metal	OEM	Length	Top Nut
<b>1980-83 FXWG, 1971-72 FX, 1962-80 FL-FLH-FLHS.</b> <i>Note: 36-2524 is chrome.</i>					
36-0621		36-2524	67026-62	35"	5/8"
36-2604			Cadmium	39"	5/8"
36-2429			As Above	39"	5/8"
		36-2576	67026-62 Zinc, Thin	35"	5/8"
	36-0125		Clear Coat	35"	5/8"
		36-2590	Barnett	36"	5/8"
		36-2554	Thick Type Zinc .420 O.D.	35"	5/8"
<b>Mini Speedo Kit 1936-85 Big Twin for 39-0316, 39-0314 and 39-0365.</b>					
36-0512	Custom	—	—	50"	12mm
36-0417	FXST Rear Wheel		67401-97	75"	12mm



**Replica Style Early Cables** feature original style housing, .42" thick, for early FL transmission drive, 45" rear wheel drive. All cable have female fitting at drive end and nut on speedometer end as noted.

Black	Zinc	Chrome	Item	Fits	Nut
—	36-2540	—	67026-36A	1936-61 BT	Male
36-0451	—	—	CAD	1936-61 BT	Male
36-0531	36-2554	36-2524	62026-62	1936-80 BT	Female
36-2604	—	—	CAD	1936-80 BT	Female
—	36-2571	—	62025-37	1937-52 45"	Male
—	36-2572	—	Custom	1937-52 45"	Female
—	36-2598	—	67028-62	1962-73 Servi	Female



**Speedometer Cable Clamps** note cable size of fitment.  
**Big Twin Overhead Valve**

Colony	VT No.	#	OEM	Fits/Type
9646-1	—	A	67075-36	1936-56, Thick
—	37-9025		67075-36	1936-56, Zinc
—	37-0589*	A	67074-57	1957-61 Zinc
9652-1	39-0337	G	67074-57A	1957-61, Zinc
9650-1	—	E	67075-52	1952-56
9651-1	—	F	67074-57	1961-90
9649-5	37-9234	D	67086-39	1937-48 Big Twin

\*Note: Sold in 5 pack



**Male to Female Speedo Adapter**  
Bushings fits late speedometers to accept early cable. **VT No. 36-0897**

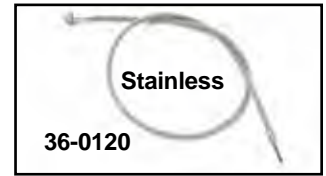

Front Wheel Drive Speedometer Cables.				
Choose by application or by length and top nut size. Available in black vinyl, stainless or clear coated stainless.				
Black Vinyl	Stainless	OEM	Length	Top Nut
<b>1987-94 FXR-FLXR, 1984-86 FXRS, 1984-86 FXSB, 1973-82 FX-FXE, 1981-82 FXB, 1983-85 FXR. Replaces OEM 67078-85A, 67051-73 and 67052-78A.</b>				
36-0606	36-2528	See Text	40"	16mm
36-0813	—	Barnett	40"	16mm
—	36-0120	Coated	40"	16mm
<b>1980-85 FXRT, 1983-85 FXE.</b>				
36-2414	36-2529	67048-83A	43"	16mm
—	36-0121	Coated	43"	16mm
36-0815	—	Barnett	42"	16mm
36-0608	—	67052-78B	49"	16mm
<b>1973-78 FX.</b>				
36-0601	—	67051-73	42"	16mm
36-0602	—	+4"	44"	16mm
<b>1981-84 FLH. Replaces OEM 67026-81 and 67072-87B.</b>				
36-0627	—	See Text	35"	12mm
36-0817	—	Barnett	35"	12mm
<b>1980-86 FLHT-C/P, 1980-86 FLT, 1989-93 FLHS, 1982-83 FXR-FXRS.</b>				
36-2412	—	67072-79A	40"	12mm
—	—	67072-87B		
—	36-0127	Coated	40"	12mm



Transmission Drive Speedometer Cables. All have female nuts at transmission end and top nut as noted.				
Black Vinyl	Metal	OEM	Length	Top Nut
<b>1936-61 FL-FLH Models.</b>				
36-0620	—	67026-36A	35"	5/8" M
<b>1952-56 K Trans Drive Models.</b>				
36-2570	36-2577	67051-52A	46"	5/8" F
Black	Zinc			

**Cable Adapter** allows use of 5/8" cable on 12mm threaded speedometers.  
**VT No. 36-0507**

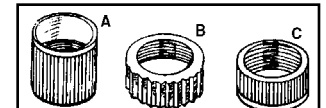

**Replacement Speedometer Cable Nuts** for front wheel drive cables and are available in 5 packs.

VT No.	#	Type	Model
36-0397	A	12mm	1981-94 FXR
36-0396	B	16mm Fine	1973-77 FXE
36-0515	C	16mm Course 5/8" NPT	Fat Bob





# Speedometer Drive Kit

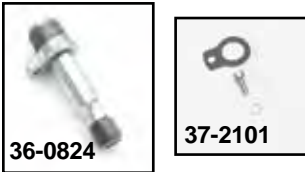

**Speedometer Drive Units** include housing and gear as OEM replacement, for transmission drive. 45" types are for the rear wheel.

VT No.	OEM	Teeth	Fits
36-0810	67130-36	11	1936-61 Big Twin
36-0811	67130-61	13	1962-67 Big Twin
36-0812	67130-69	23	1968-80 Big Twin
36-0824	67130-69	23	1968-80 Big Twin
17-0094		7	1968-80
36-0094		7	1968-80
37-2101	Screw Kit		1936-80 Big Twin

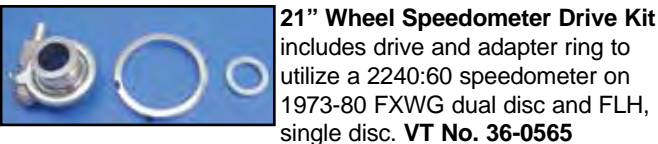

**21" Wheel Speedometer Drive Kit** includes drive and adapter ring to utilize a 2240:60 speedometer on 1973-80 FXWG dual disc and FLH, single disc. **VT No. 36-0565**

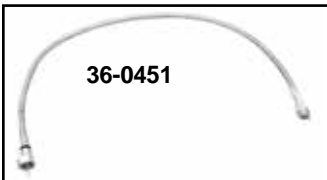

### Replica Cadmium Speedometer Cables.

VT No.	Year	Fitting
36-0451	1936-61	Male
36-2604	1962-80	Female
36-0938	1936-80	Inner

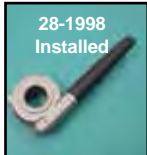

**Speedometer Cable and Cable Mount** for front wheel drive models 1973-up are available in a 5 pack.

VT No.	OEM	Item
31-0149	38623-68	Chrome Bracket
28-1998	66996-85	Cable Boot



**Grease Fittings.** Special thread.

VT No.	Year	Type	U/M
8770-6	1909-38	Nickel	6 pack
49-0595	1909-38	Nickel	10 pack
44-0533	1938-up	Zinc	10 pack
9864-6	1938-84	Cadmium	6 pack
9897-6	1938-84	Chrome	6 pack
44-0558	1938-up	Nickel	10 pack
37-0511	1938-up	67.5°, Zinc	5 pack
37-0521	1938-up	90°, Zinc	10 pack
49-0636	Cadmium	Straight	10 pack
49-0687	Cadmium	Set	20 Piece Set
49-0637	1936-38	67.5°	10 pack
49-0688	1936-37	90°	5 pack

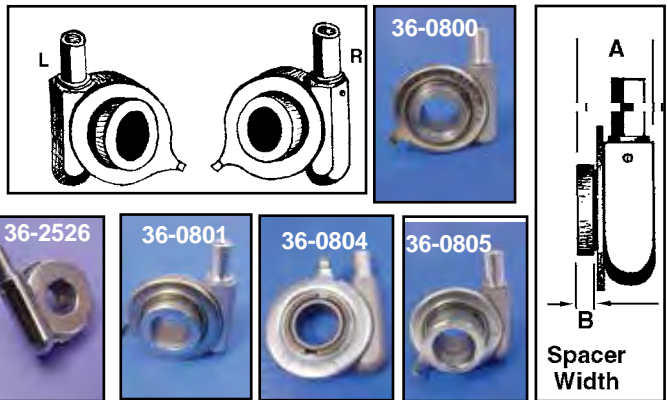

**Speedometer Drive Units** fit front wheel only and have .750 axle hole, for right and left side as noted, spacer length note. (A) Overall length (B) Spacer length.

VT No.	OEM	Spacer Length (B)	Overall Length (A)	Ratio	Fits
36-0800	67127-73	.268	.789	2.1	1973-84 All FX's
36-2526	Chrome	.268	.789	2240:1	As Above
36-0804	67073-81	Flat	.532	2.1	1981-84 FLH 1984-86 FLT
36-0805	67071-79	.586	1.114	2240:1	1980-83 FLT



**Speedometer Drive Spacers** replace drive units. Fits 1973-83 FX. **VT No. 44-0390**



**Chrome Speedometer Drive Covers** fit over the existing drive units. Fits 1973-83 FX-FXR (35mm) and 1981-84 FL, 1982-86 FL (41mm) **VT No. 42-0435**



**Block Off Plate for Speedometer Drive Hole Plug** includes plate, gasket and lockwasher. Zinc plated. Fits 1936-84 Big Twin. **VT No. 17-0119** Kit **15-1047** Gasket

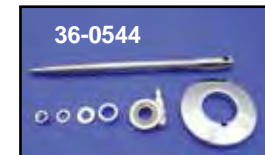
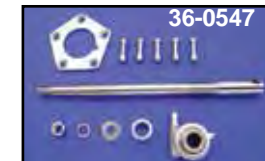

**VT No. 36-0544 shown on FLH**

**1973-80 Right Hand Speedometer Drive Adapter Kits.** **FLH kit** includes 2:1 right side speedo drive, chrome hub cover and chrome axle with nuts. For single disc FL spoke hubs and cast wheels 1981-85 style. **VT No. 36-0544** **FXST-FXWG kit** includes adapter flange, 2:1 ratio left side speedo drive and axle to fit 1980-83 FXWG or 1984-99 dual disc spoke hubs. **VT No. 36-0547**

# Snap Cap™ • Snap On

- Tight Fit
- Easy Installation
- Universal Use

*Yacht Stuffing*



**Chrome Cap Assortment** includes 100 pieces each 1/4", 5/16" and 3/8" caps.  
VT No. 37-1505

## 300 Piece Assortment!

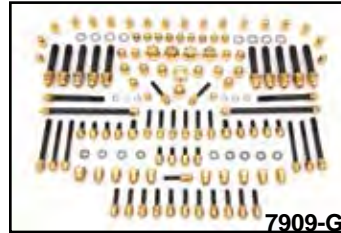

**Show Bike Kits** are original chrome detailing by Colony for models listed. Includes acorn or cap nuts for motor and transmission area.



Cap Acorn



**Chrome Caps** snap on outside knurled allen screws for ease of installation. Packs of 100.

VT No.	Fits
37-1502	1/4"
37-1503	5/16"
37-1504	3/8"

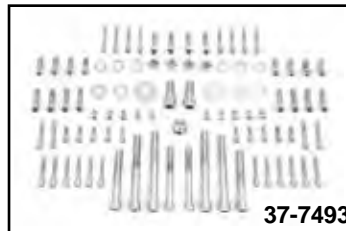

### Panhead Allen Screw Sets.

VT No.	Year	Type
37-7492	1965	Engine Set (Short Panhead Screw)
37-7493	1958-64	Engine Set (Short Panhead Screw)
37-7494	1948-57	Engine Set (Short Panhead Screw)
37-8507	1936-64	Cam, Primary Cover Set
37-9181	1948-84	Engine Mount, Lower

## Allen Screw Kit



### Gardner-Wescott Builder Chrome Fastener Sets

are the perfect combination of allen screws and acorn nuts. Contains timing plug, oil pump, left and right side covers, clutch and chain cover, top front and rear engine mount with stabilizing

link fasteners and regular bracket mount on FXR-FLT lifter base, point cover, header mount, casing and inner primary to casing, rocker box, cylinder base, engine case, transmission cover and washers supplied where needed. Where there is a bolt you get an allen screw. Where there is a nut you get an acorn. All heads **polished chrome**, smooth without knurls.

VT No.	Fits
37-0082	1982-83 Shovelhead 5 Speed FXR-FXRS-FXRT
37-0088	1979-84 Shovelhead 4 Speed models
37-0089	1977-78 Shovelhead
37-0091	1966-69 Shovelhead
37-0092	1965 only Panhead



**Cam and Primary Cover Chrome Screw Sets** for transmission, chain, clutch or derby provided where applicable. By Gardner- Wescott. Fits 1970-84 FLH-FX All 4-Speed models.

VT No. 37-8505

Cap	Acorn	Acorn	Year	Model
—	—	7909-G	1936-39	Knucklehead
8505	—	7905-G	1936-39	Knucklehead
—	7915	—	1976-77	Shovelhead



### Chrome Polished Allen Head Show Bike Kits.

VT No.	Year	Model
1010-P	1978-84	Shovelhead
1009-P	1979-84	FLT



### Big Twin Polished Chrome Engine Sets

include all side covers, lifter base, timing plug, inner primary mount, top, front, and rear engine mounts with stabilizing link fasteners on FXR and FLT models. Sets also include rocker box cov-

ers, header mount and points cover or generator mount where applicable with washers and nuts where needed on 4 Speed Shovelheads.

VT No.	Year
37-7489	1977-84
37-7490	1970-76



**Chrome Engine Case Allen Bolts** fasten engine case halves together on 1979-82 Big Twins.

VT No. 37-9190



**Chrome Allen Screw Kit** connects engine mounts, front, top and rear to frame on models listed below. Knurled.

VT No.	Fits	Speed
37-9181	1948-84 Big Twin	4
37-9183	1982-83 FXRS	5





# Full Hardware Kit



Replicas!!

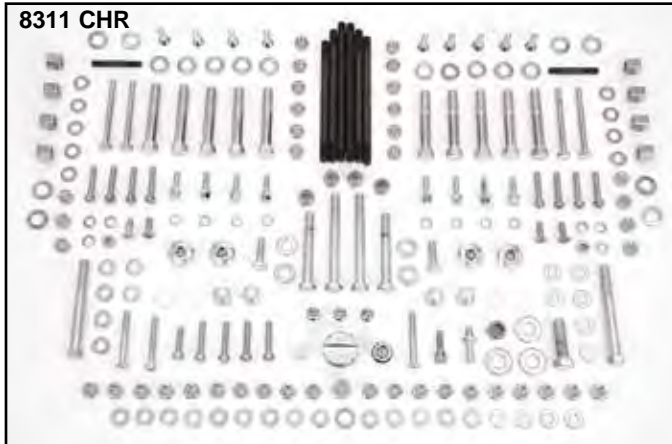

**Stock Style Hardware Kit** contains all the stock engine nuts, bolts, washers and studs for your engine in choice of chrome or cadmium plating. Kit includes primary cover screws, lifter base screws, circuit breaker screws, case studs and nuts, timing plug, cam cover screws, cylinder base nuts and washers, oil pump nuts and bolts, trans side cover nuts and washers, transmission top screws, transmission fill plug, generator screws, head bolts and washers. For 1948-64 Panhead Kits, order proper length Panhead cover screws separately.

Chrome	Cadmium	Year	Model
8311 CHR	8311 CAD	1970-75	Shovelhead
8312 CHR	8312 CAD	1976-78	Shovelhead
8313 CHR	8313 CAD	1979-80	Shovelhead
8314 CHR	—	1981-84	Shovelhead
8302 CHR	8302 CAD	1948-57	Panhead
8303 CHR	8303 CAD	1958-65	Panhead
8307 CHR	8307 CAD	1966-69	Shovelhead



**Replica Eaton Style Gas Caps** with correct knurls, depth and markings.



**Replica Chrome Caps** are the taller profile for the authentic look replacing 61103-36. VT No. 38-7004 vented fits right and left 36-64 FL-FLH stock tanks.

VT No.	Item	Year
38-7034	Vented Cap Set	1936-38
38-7004	Vented Cap	1939-64 Chrome/Each
38-7054	Vented Cap	1939-64 Brass/Each
38-7036	Vented Cap Set	1939-64
38-7051	Vented Cap, Parkerized	
38-7055	Cap Set, Parkerized	
38-7030	Vented Cap Set	1965-72
	Vented/Non-Vented	
38-7017	Non-Vented Cap	1965-72
38-7033	Vented Cap	1965-72
38-0435	Vented Cap Set	1936-41
38-0440	Vented Cap Set	1953-64
38-0535	Vented Cap Each	1965-82
38-0751	Black	1936-52



**Battery Top Kit** include top, spark plugs and rod kit.  
**VT No. Year**  
**42-1275** 1936-47  
**42-1276** 1948-57

# Bobbed Gas Tank 1936-84



**Bobbed Gas Tanks** fit 1936-84 FLH-FXE with Bobbed tank type mounts for years listed not FXR or FLT models. Use 1975-up petcocks with nut. Tanks accept stock dash and speedometer. Order cap set separately.

VT No.	Gal	Cap Type	Caps
38-0816	3.5	Bayonet	38-0312
38-0100	3.5	Bayonet	38-0312
38-0101	5.0	Bayonet	38-0312
38-0542	5.0	Bayonet	38-0312
38-0852	3.5	Bayonet	38-0312

VT No.	Gal	Cap Type	Caps
38-0112	3.5	Screw Bung	38-0321
38-0113	5.0	Screw Bung	38-0321
38-0165	6.0	Screw Bung	38-0321

**With Welded On Emblem Mounts to accept 1966-72 emblems**

38-0546*	5.0	Bayonet	38-0312
38-0543	5.0	Bayonet	38-0312

\*Note: Use pre1975 Petcock Right Side

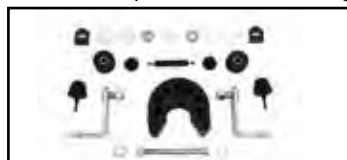

**Gas Tank Mounting Kit** includes spring and clip, large horseshoe mount, rubber bushing, and cup bumper.  
VT No. 38-0204



**Gas Tank Mount Kit** includes 3 tank mounts, brackets, shifter tube, 2 bayonet filler bings, lower threaded fitting insert, right side fuel nipple and top threaded insert for the fuel rod.

VT No.	Fits	Year
38-1644	BT	1936-65
38-1645	45	1941-73

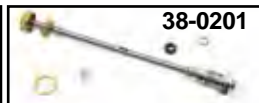

**Shut Off Kits** include rod and seat for Big Twin.

VT No.	Year	Type
38-0419	1941-49	VT
38-0232	1941-49	Replica
38-0201	1950-65	VT
38-0537	1950-65	VT
38-0231	1950-65	Replica



**Shift Mount Tab Kit** includes two brackets and tube for shift and 3 tank mounts for use on Big Twin hand shift tanks, must be welded on. VT No. 38-0226

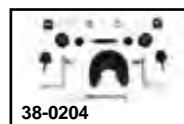

**4.5 Gallon Quickbob Gas Tank** is a one piece tank to fit 1948-84 Big Twin frames and features 1983-up filler necks. Mounts with stock hardware and uses 1975-up type petcock, VT No. 38-0204 required for installation.

VT No.	Item
38-0115	Tank
38-0204	Mount kit
38-0321	Cap Set



**Gas Tank Repair Pieces** include fillers, four piece tab set for top, bottom, right and left. Can be welded on stock and after-market tanks.

VT No.	Item
38-0208	Tab Set
40-1255	Filler Neck, Bayonet
38-0206	Filler Neck, Late Bung type, right and left, pair
38-0221	Petcock Fitting, male, 1975-up
38-0309	Petcock Fitting, female, 3/8 NPT
38-1644	1936-65 Kit
35-0871	Oil and Gas Fittings, Raw, old

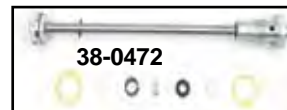

**Shut Off Kits** include rod and seat for Big Twin.

VT No.	Year	Type
38-0470	1941-49	BT
38-0471	1941-49	45"
38-0472	1955-65	BT



35-0291 Viton Tip

**Important Gas Tank Information:** All tanks are shipped unpainted unless otherwise noted. Caps and petcocks are not included. Carefully check the new tank for flaws and fit before painting. Do not grind or sand the seams or joints. Clean the inside of the tank and it is suggested to pressure test and use a tank sealer. Check petcock openings, making sure the petcock can be easily installed. Use proper hardware to mount tank, including correct bushings, brackets and spacers required for assembly. Tedd Cycle, Inc. is not liable for paint work or labor claims of any kind. Tedd Cycle, Inc. is not the manufacturer of the gas tanks.





# 1936-69 Big Twin Bobbed Gas Tank



**1948-65 Big Twin Bobbed Gas Tank Set** features provisions to accept early caps, reserve shut off rod and 2 or 3 lite dash. Set also available with shifter gate mount holes and lower shift lever mount tab. Order shift gates and mounting hardware separately as required. VT No. 38-0130 requires use of VT No. 7807-3 gas line fittings. 38-0130 includes chrome shift handle.

**\*Note:** Custom Appearance



VT No.	Gallon	Reserve	Shift
38-0796	3.5	Yes	No
38-0797	3.5	Yes	Yes
38-0119*	3.5	Yes	Yes
38-0142	3.5	Yes	No
38-0787	3.5	No	No
38-0130	5.0	Yes	Yes
38-0131	5.0	Yes	No

**\*Note:** All Pre1965 tanks use two vented caps.



**Flathead Big Twin and Knucklehead 3.5 Gallon Bobbed Gas Tank Set.** 1940-46 features handshift mounts and shut off rod provision, order shut off rod and seat kit separately. 1936-40 features handshift mounts and accept petcock VT No. 35-0497. Tanks are also available with 3 mount strips welded to each side to attach 1940-46 emblems and stainless trim. Order emblems and trim separately.

VT No.	Item	Year
38-0531	TT Tank Set	1936-57
38-0183	Tank Set without trim mounts	1936-39
38-0140	Tank Set without trim mounts	1940-46
38-0136	Tank Set with trim mounts	1940-46
38-0414	Tank without trim mounts replica	1940-46
38-0469	Tank Set with caps	1940-46
38-6696	Emblem Set	1941-46
38-6679	Four Piece Stainless Trim Set	1941-46

**Note:** All Pre 1965 tanks use two vented caps.

**\*Note:** All tanks with shut off rod provisions may require fuel rod alignment before installation of shut off assembly.

**Important Gas Tank Information:** All tanks are shipped unpainted unless otherwise noted. Caps and petcocks are not included. Carefully check the new tank for flaws and fit before painting. Do not grind or sand the seams or joints. Clean the inside of the tank and it is suggested to pressure test and use a tank sealer. Check petcock openings, making sure the petcock can be easily installed. Use proper hardware to mount tank, including correct bushings, brackets and spacers for assembly. **Tedd Cycle, Inc.** is not liable for paint work or labor claims of any kind. **Tedd Cycle, Inc.** is not the manufacturer of the gas tanks.

3.5 Gallon Tank w/shut off provision and emblem mount	3.5 Gallon Tank w/emblem mounts and shut off rod provisions	3.5 Gallon Handshift Tank Kit with emblems and cap	Year	Emblems
	38-0136	38-0469	1940-46	38-6696
38-0830			1947-50	38-6699
38-0831	38-0896	38-0574	1951-54	38-6699
38-0817	38-0890	38-0569	1955-56	38-7022
38-0818	38-0891		1957-58	
38-0819	38-0892	38-0570	1959-60	38-6670
38-0820	38-0893	38-0571	1961-62	38-6162
38-0821	38-0893	38-0572	1963-65	38-6695
<b>5 Gallon Handshift Tanks with emblem mounts</b>				
		38-0546	1966	38-6682
		38-0543	1967-72	38-6682



**Louvered Dash Plates** are chrome steel with protective foam strip backing for easy installation. Fits 1967-84 FLH Cast Dash.  
**VT No. 39-0404**



**Black Rubber Tank Filler Strip** fits 1979-81 FLH models.  
**VT No. 28-0715**



**Plastic Panel** replaces 61125-72 on 1971-72 FX Nitetrain or can be used on FX-FL models with die cast dash and frame mount seat. **VT No. 28-1990**



**Rubber Tank Divider** fits between three or five gallon bobbed tanks when seat T bar is not used.  
**VT No. 28-0652**



**Black Replica Tank Divider** replaces 61122-39 when a seat "T" bar is used.  
**VT No. 28-0653**



**Chrome Panel Edging** slips on sheet metal dash panels, hub cap edges for decorative use, 10 foot roll. **VT No. 37-8943**

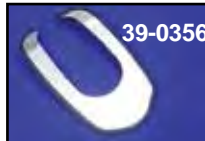

**Chrome Dash Aprons** are for Big Twins when plunger type seat is used with T-Bar.

VT No.	Fits	Dash No.
39-0355	Cateye Type Dash	39-0112
39-0356	Lowrider Type Dash	39-0117

# Tank Divider



**Chrome Die Cast Tank Trim Panel** replaces existing rubber divider on 1968-84 FL with die cast dash. Replaces 61142-82, attaches by supplied rubber ring.  
**VT No. 39-0343**



**Chrome Tank Panels** fill the gap between 3 and 5 gallon Bobbed type tanks.

VT No.	Years	Type	Style
39-0108	Custom	Full	Plain
39-0106	1947-84	FLH	Plain
39-0104	1977-84	FXS	Plain
39-0478	Hooks		Set

**Note:** VT No. 39-0106 style mounts under steel dash panel two and three light and with large O-Ring. VT No. 39-0108 and VT No. 39-0104 mount on front tank bolts and frame tube.

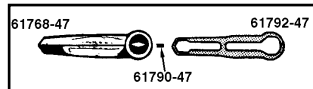

**Tank Emblem Mount Screws** for years listed.

VT No.	Years	Type
37-8829	1940-46 EL, FL	Stainless
37-8828*	1947-50 EL	Stainless
37-9504	1951-56 EL	Stainless
37-9505	1951-56 FL	Chrome
37-8826	1959-62 FL, FLH	Stainless

\*Note: Use with 38-0109 mounts

# Emblem Mounts

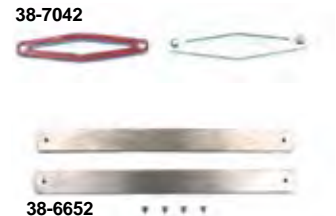

**Weld On Emblem Mounts** can be spot welded or blazed to Bobbed Tank sets. Order emblems and screws separately.

\*Note: Denotes Adhesive Mounts. NOS = New Old Stock

38-0108	1940-46 NOS	38-7024*	1955-56	38-7072	1959-60	38-0111	1966-71
38-7011*	1940-46	38-7071	1957-58	38-7013*	1959-60	38-7042*	1966-71
38-0109	1947-50	38-7005*	1957-58 Curved	38-7073	1961-62	38-6652	1979-84 Thick
38-7007*	1947-50	38-7006*	1957-58 (Original Flat)	38-6701*	1961-62		
38-6703	1951-54	38-6669	1959-60 NOS	38-7008*	1963-65		
38-7012*	1951-54						





# 1948-84 Tank Mount



**Mounting Kit for 1936-84 Big Twin with Bobbed Style Tanks** includes special washers, studs, and bolts. VT No. 38-0200 includes spacers.

VT No.	Type	Finish
38-0200	Stock	Zinc
9891-18	Stock	Chrome
9892-18	Stock	Cadmium
9893-18	Stock	Parkerized
2524-2	Allen	Chrome
12-2123	Rear Mounting Stud Only 1936-84	

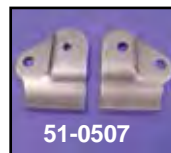

**Mounts for Bob Tanks.** "Our Original Frame Saver Kit" may be welded to all 1936-84 Big Twin frames, stock or custom, to replace original brackets.

VT No.	Item
51-0100	Complete Kit, 1936-47
51-0121	Complete Kit, 1948-84
51-0507	Rear Mount Clips, pair



**Speedometer Mount Frame Casting** must be welded.

**Note:** Casting has provision for steering damper pin. Fits 1948-84 FL.

VT No. 51-0067



**Small Type Gas Tank Mount Horseshoe** can be used on 1 piece FX or quick bob tanks. Stock OE replacement type. Rubber measures 2 $\frac{7}{8}$ "W x 2 $\frac{1}{2}$ "H. OEM No. 61139-73A. Fits 1973-84 FX. VT No. 28-0644

**Frame Saver Gas Tank Mount Kit** includes front and rear tank mounts. to mount Bobbed tanks to custom or original frames. Temporarily attach one tank piece by clamping bracket for a quick check of tank placement on custom applications. Bracket assembly can then be welded in place.

VT No.	Year	Type
51-0521	1936-84	Stock
51-0674	1936-84	Stock
51-0615	1985-99	Flat Side
38-0240*	1985-99	Flat Side

\*Note: 1958-84 when installing flat side

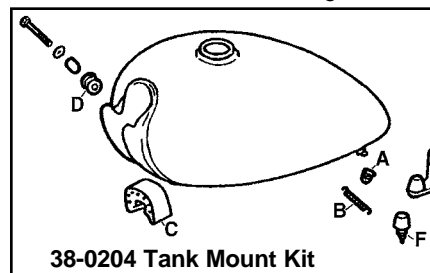

38-0204 Tank Mount Kit



**FX Tank Mount Kit** mounts one piece FX or Quick Bob tanks on 1973-84.

VT No.	#	OEM	Item
38-0204	A-F	—	Complete Kit
38-0220	A&B	—	Spring and Clip Kit
38-0205	A	61546-74	Spring Clip
13-0155	B	61550-73A	Spring
28-0614	C	61139-73	Horseshoe, Large
28-0615	D	61152-65P	Rubber Bushing
28-0617		62123-66	Button Bumper
28-0618	F	61562-66	Cup Bumper

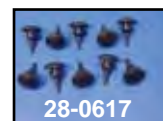



# Dash Assembly

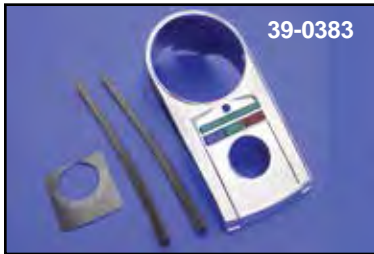

**Chrome Cast Dash Panel** includes lens set for 1968-90 models.  
VT No. 39-0383



**Chrome Long Rider Dash Panel** is constructed of ABS plastic and fits bobbed tanks on 1968-95 FLH-FXWG-FXST models. Rubber strip included.

VT No. 39-0450



**Long Rider Dash Kit** with speedometer and switch for 1948-95 Big Twins.

VT No.	Ratio
39-0973	2:1
39-0974	2240:1

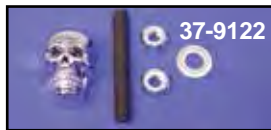
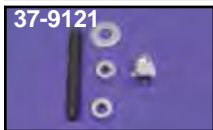

**Chrome Dash Mount Stud Kit** includes stud, nuts, nylon washer and either skull or acorn nut kit. Fits 1968-up cast dash panels on FXST-FL-FXWG when choke cable is not used.

VT No. Type

37-9121	Acorn
37-9122	Skull
37-0573	Stud only



**Choke Cable Nut Kit** includes nut, and seal for dash mounted choke on FL-FXWG-FXST models.

VT No. 37-8942



## 5" Fat Bob Speedometers

Unassembled	Assembled	Face	Glass	Needle	Ratio	MPH
39-0480		White	Flat	Black	2:1	120
39-0487		White	Dome	Black	2:1	120
39-0481		Bull Eye	Dome	White	2:1	120
39-0482		White	Dome	Orange	2:1	120
39-0862		Police	Flat	Red	2:1	100
39-0868	39-0070	Police	Flat	Red	2:1	120
39-0864	39-0072	Police	Flat	Red	1:1	120

\*Note: Personalized by Motor Shop



**FLH Dash Kit** features chrome cast dash with lens and hardware, 6-post switch, choke cable and knob, all mounting hardware and trim strips. Stock on 1968-84 FLH. Can be adapted to all 3.5 or 5.0 gallon tanks. Dash base has wiring and sockets. Choose the proper speedometer cable for each application.

VT No.	Type
39-0913	1:1 Ratio
39-0914	2:1 Ratio
39-0972	As Above without Speedometer
39-0967*	As Above without Speedometer
39-0919	1:1 Ratio with Tach
39-0920	2:1 Ratio with Tach

\*Note: Includes plain unwired dash base.



**Speedometer Adapter Ring** adapts to late model speedometer into FLH style steel dash cover. FLH Dash is shown with adapter ring installed VT No. 39-0130, adapter ring must be affixed with an industrial adhesive for a leak proof seal. VT No's 39-0124 and 39-0192 include chrome ring and bracket to mount electronic speedometer in FLH style dashes.

VT No. 39-0130

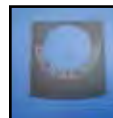

**Dash Panel Decal** fits 1979-93 FL-FXH-FXWG models. Has a black matte finish, and an adhesive back, 5 pack.

VT No. 48-0423



**1975-95 Dash Hardware Kit** includes parts pictured to fit the FLH-FXWG-FXST cast type dash, stock or 39-0383.

VT No. 39-0382

**Late Dash Parts.** Pieces fit late cast dash panel 1968-95 FLH-FXWG-FXST.

VT No.	Item
39-0345	Support
39-0347	Retainer
39-0348	Lens clip



**Chrome Billet Clock Assembly** fits 7/8" or 1" handlebars.

VT No.	Item
39-0785	Clock
53-0871	Battery





# Dash Kit



V-Twin Original Dash Kits First Offered in 1984!

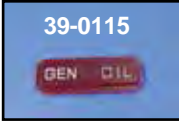
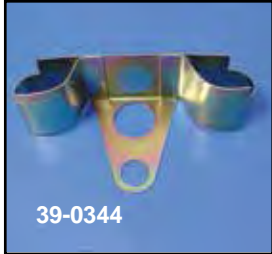
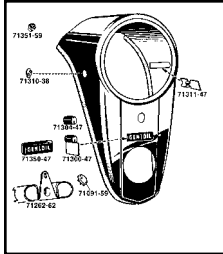

### Steel Dash Panel Components

VT No.	OEM	Item	Light
39-0349	71300-47	Lens Holder	2
39-0115	71350-47	Lens	2
39-0354	71310-38	Cover Plug, 1939-67	All
39-0353	71311-47	Cover Side Plate	2
39-0344	71292 62	Shield	3
39-0114	71091-59	Lens Set	3
	71351-59	2 Red, 1 Blue	3



**Two and Three Light Dash Panels.** Two light fits 1947-61 Big Twin and 45 models. Three light type fits 1962-67 Big Twin.

VT No.	Item	Item	Finish
39-0111	2-Light Dash	Dash	Chrome
39-0953	2-Light Dash	Dash	Raw
39-0952	3-Light Dash	Dash	Raw
39-0110	3-Light Dash	Dash	Chrome
28-0542	Strip		Rubber
39-0144	Without key switch hole		Chrome
39-0459	Rail Kit	Deco	Chrome

**Two or Three Light Dash Kit** is complete as illustrated. Includes either 1:1 or 2:1 ratio speedometer and the correct five post key switch with two keys. Order Plainbase dash kit when it is not desired to rewire harness for dash lighting. Choose proper cable for each application. Nothing else to buy! 3 light dash kit pictured. Can be mounted on 1947-84 FL Big Twin models.

VT No.	Type
39-0904	3 Light Plain Base 1:1
39-0951	3 Light Plain Base without Speedometer
39-0905	2 Light Plain Base 1:1
39-0906	3 Light Plain Base 2:1
39-0907	2 Light Plain Base 2:1
39-0908	3 Light Wired Base 1:1
39-0909	2 Light Wired Base 1:1
39-0910	3 Light Wired Base 2:1
39-0911	2 Light Wired Base 2:1
33-0534	Bulb Socket, pair



**V-Twin Dash Kits** are available with the popular tachometer-speedometer combination included. Can be wired to 1978-up FX-FL models with a tach that is triggered by coil impulse. See instructions for tach wiring. Wired base includes light sockets and all hardware for installation.

VT No.	Type	Ratio
39-0915	2 lite	2:1
39-0916	3 lite	2:1
39-0917	2 lite	1:1
39-0918	3 lite	1:1



**Dash Panel Mounting Stud and Center Screw** features chrome domed center screw, stud and lock nuts to mount two light steel dashes to 1947-67.

VT No.	Item
7716-2	Kit, Colony
39-0123	Kit, V-Twin
39-0226	Center Stud
8483-2	Center Screw only
39-0155	Lock Tab only



**Chrome Dash** with 91.5 mm speedometer hole accepts electronic speedometer from XL-FXD models.

VT No.	Type
39-0892	Smooth
39-0893	3-Light

**Dash Insulator and Bolt Hardware Kit** is sold in three pack, for dash rebuilding.

VT No. 32-8013

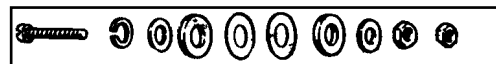

# Cateye Dash

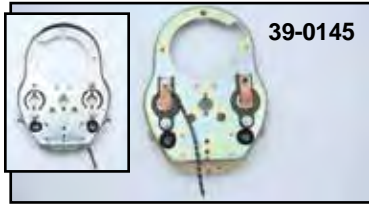

**Cateye Dash Kit** is complete as illustrated. Packaged on 18" x 24" board for point of purchase display. Can be ordered with either plain (39-0129) base, with sockets and bulbs. Includes either 1:1 or 2:1 ratio speedometer and the correct five post key switch with two keys. Order VT No. 39-0129 "Plain Base"



dash kit when it is not desired to rewire harness for lighting base. Order cable separately. Can be mounted on 74 and 80 Big Twins 1936-84 models, 1936-73 45 models fitted with 1947-up style tanks.

VT No.	Type
39-0900	1:1 With Plain Base
39-0901	2:1 With Plain Base
39-0902	1 1 With Wired Base
39-0903	2:1 With Wired Base
39-0899	Without Speedometer with Plain Base



**Dash Plate Mounting Kit** contains all hardware required to properly install the dash plate & cover on all 1936-46 BT.



VT No.	Item
7715-6	Stud Kit
39-0201	Switch/Stud Kit
39-0523	Lens Kit
39-0232	Lens Kit

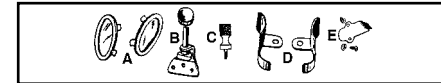

**(A) Cateye Dash Lens Kit** replaces 71340-39 and 71341-39. Sold in a set.

VT No.	Finish	39-0230	39-0225
39-0113	Chrome		
39-0206	Parkerized		
39-0208	Zinc		

**(B) Dimmer Switch.** Cateye dash mounting plate dimmer switch with knob. Replaces 71600-39.

VT No	Item	Year	Finish
39-0119	Complete Switch	1939-46	Chrome
39-0225	Complete Switch	1936-38	Replica
39-0230	Complete Switch	1939-46	Replica
2560-2	Knob	1943-46	Chrome
2561-2	Knob	1943-46	Parkerized
2562-2	Knob	1939-43	Chrome
39-1529	Knob	1936-38	Alloy
2610-1		1937-38	Knob
2609-4		1937-46	Contact Springs
39-0448	Knob Kit	1939-46	

**(C) Early Reset Knob.** Original knurled type, clear stamped two and three, and cateye dashes on early models.

VT No. 39-0336

**(D) Panel Lamp Shields**

VT No. 39-0359(E) Panel Side Plate. VT No. 39-0350

2810-13	Switch	1937-38
2811-13	Switch	1937-46

**1937 Style Skull Dash** fits most cateye dash bases. Uses rubber plug 4519-36 on side hole. Includes two red lenses and retainer rings. Can be mounted to 1948-95 tanks by use of VT No. 39-0591 base.

VT No.	Item	39-0035
39-1530	Black	
39-0414	Raw Dash with Red Lenses	
39-0415	Chrome Dash with Red Lenses	

49-0747	Dash
39-0747	1938 Only
39-0419	Red, Clear and Green Lens Set

28-2007	Rubber Speedometer Plug
39-0591	Skull Dash Panel Mount Kit
39-0994	Speedometer Adaptor Ring
28-2020	Parts Kit
39-0030	Dash Lens Tunnel Set
39-0035	Frame for Lenses
39-0033	Dash Lens Panel Rim, Raw

## Cateye Dash Base

VT No.	Fits	Type
39-0159	1939-46	Cateye Rebuild Kit
2714-36	Restoration Hardware Kit	
39-0156	1936-37	Skull
39-0455	1938	Skull
39-0145	1939-46	Replica Kit
39-0229	1939-46	V-Twin
39-0408	1939-46	Base
39-0127	1936-46	Custom
39-0129	1936-84	Custom
39-0128	1939-46	Wired
39-0184	1936-46	Replica Complete with harness
39-0408	1939-46	Bare Dash
39-0241	1939-46	Dash Assembly



39-0184



## Replica 1939-46 Cateye Dash Base Parts.

VT No.	Item
2714-36	Mount Kit
33-2046	Bulbs
2862-2	Contact Spring, cad
2609-4	Contact Spring Kit

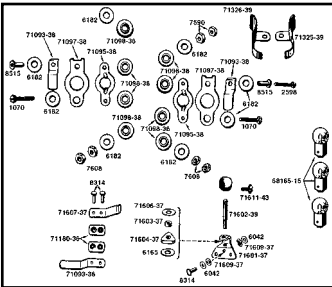

**Cateye Dash Cover** fits 1939-46 Big Twin and 45 models. Includes lenses and rubber trim.

VT No.	Finish
39-0360	Raw
39-0446	Black
39-0898	Black
39-0447	Chrome
39-0112	Chrome
<b>Pre-War 1939-41 V-Design</b>	
39-0863	Black
39-0894	Chrome V
28-0541	Rubber Trim
39-0831	Raw Oiled







# Wiring Harness/Dash Base Assembly



Replica Dash Bases feature correct shape and bulb sockets.

VT No.	Year	Type
39-0958	1948-58	2-Light
39-0963	1959-61	2-Light
39-0959	1962-67	3-Light
39-0960	1968-95	Cast
2713-42	1947-95	Insulators

Replica Wiring Harness /Dash Base Assemblies include harness pre-wired to dash base, five or six post key switch, terminal box, horn button, dimmer switch, headlamp connection, speedometer lamp socket and front terminal board when required. Switch and wiring tested after final assembly.

VT No. Type Year/Model Generator

VT No.	Type	Year/Model	Generator
39-0190	2-Light	1947 Big Twin	3 Brush
39-0189	2-Light	1948 Big Twin	3 Brush
39-0182	2-Light	1949-57 Big Twin	3 Brush
39-0183	2-Light	1958 Big Twin Neutral	2 Brush
39-0181	2-Light	1959-61 Big Twin, Neutral	2 Brush
39-0188	3-Light	1962-64 Big Twin	2 Brush
39-0184	2 Light	1939-46 Big Twin	3 Brush
<b>Big Twin Electric Start Models</b>			
39-0185	3-Light	1965-67	2 Brush
39-0186	5-Light	1968-69	2 Brush
39-0196	5-Light	1970-71	ALT
39-0197	5-Light	1972 only	ALT
39-0187	5-Light	1973-77	ALT
39-0198	5-Light	1978-79	ALT
39-0199	5-Light	1980-84	ALT

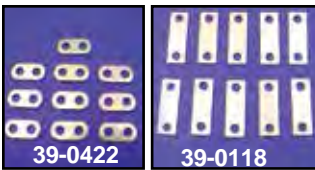

Late Dash Base/Ignition Switch Spacers for spacing dash base and switch in relation to tanks, packs of 10.

VT No.	Size	Type
39-0420	.030	Dash
39-0421	.060	Dash
39-0422	.120	Dash
39-0118	.040	Switch



Dash Mount Hardware includes bolts, spacers and hardware to install 1948-98 type dash mount bases on 1984-98 FXST-FLST models with flat side tanks.

VT No.	Item
39-0209	Kit
39-0210	Spacer, Front
39-0214	Spacer, Rear
28-0403	Rubber Strip
28-0562	Rubber Bushing

Dash Base Boot fits 1965-95 models.

VT No. 28-0412



Skull Dash Kit includes cover and base.

VT No. 39-0615



Light Sockets available with a steel or plastic body. Bulbs are included.

VT No.	Item
33-0129	1 wire, 3 pack
33-3065	1 wire, 3 pack
33-1983	2 wire, 3 pack, plastic
<b>Note:</b> Bulbs not included	
33-2007	2 wire, 3 pack, steel
Socket has ground wire	
33-0534	2 Wire, Insulated type, pair
33-0531	Speedometer socket
33-0136	12V Bulb
33-0244	6V Bulb

39-0591 Dash Mount Kit used on FXDWG one piece gas tank. Order dash, speedometer and switch separately.

Skull Dash Mount Kit will install dash and electronic speedometer to 1996-up FXDWG, FXST, FLST stock tanks. Kits include bracket set only. Order dash switch separately.

VT No.	Item
39-0591	Dash Base Kit
39-0594	Mounting Ring
39-0596	Dash Plate
39-0994	Speedometer Ring



Dash Mounting Plates available plain.

VT No.	Fits	Year
39-0138	2 and 3	1948-95
39-0207	All	1948-95
39-0944	Cast	1973-95



# FX-FXRS Gauge



**Speedometer Heads** fit front wheel drive.

VT No.	Type	Model
39-0335	0-140 MPH	1976-83 FX-FXE-FXS 1981-84 FX-FXE-FXS
39-0389	10-120 MPH	1973-83 FX
39-0319	10-150 MPH	1973-83 FX
39-0933	10-120 MPH	1983-94 FXRT



**Replacement Electric Tachometer** reads 0-8000 RPM. Order lamp separately. Replaces 92042-78A. Fits L1978-84 FX-FXE-FXS. The bezel has an outside diameter of 3.42".  
**VT No. 39-0318**

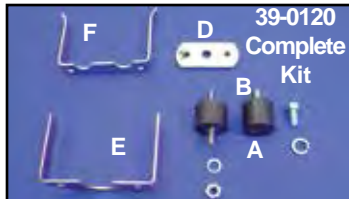

**FX Dash Mount Hardware** for 1977-84 gauges on FX-FXE or use speedometer and tachometer brackets 38-0212, 38-0213 to mount gauges in other types of housing.  
**VT No. 39-0120**

VT No.	#	Item
28-0619	A	Iso Mount 5/16
28-0546	B	Iso Mount 1/4
38-0212	E	Speedometer Bracket
38-0213	F	Tachometer Bracket
39-0120	A-F	Dash Mount Kit



**Complete Dash Assembly** for 1977-84 FXS includes chrome cover, electric tachometer, speedometer drive, trip cable, indicator lamps, mount hardware and cable.  
**VT No. 39-0177**



**FX Gauge Housing** fits 1977-84 FXS-FXEF-FXB models. Order rubber gap seal separately.  
**VT No. 39-0117**

VT No.	Item
39-0117	Chrome Dash
28-0540	Black Gap Seal
37-9063	Dash Cover Plug, chrome



**FXS Chrome Dash Screws** fit 1977-85 low rider models, four piece sets are available in acorn or allen type screws.

Acorn	Allen	Acorn Allen
8016-4	37-0441	8775-4 8775-4T



**Chrome Dash Dress Up Kit** includes dash, panel, rubber strip and chrome allen screws. Fits 1977-84 FXE-FXS.  
**VT No. 39-0912**

Re: 2:1 and 2240:60 MPH Speedometer

**The Difference is in the RPM.**

For example, 2:1 is 60MPH = 2000 RPM and 2240:60 is 60 MPH = 2240 RPM



**Replacement Clear Lens** replaces fogged, cracked or broken lenses on stock gauges for 1982-83 FXR models. Cut off old lens and plastic-seal new one in place. Sold each.  
**VT No. 39-0391**



**Speedometers** are the black plastic style. Complete units include brackets. Brackets replacement plastic lens, and fork tube plugs to accept bracket mountings are sold separately.

VT No.	Fits/Item
39-0372	10-150 MPH 1982-83 FXR-FXRS Speedometer
31-3964	Chrome speedometer
39-0391	Lens only, each
33-0133	12V Bulb



**Tachometer and Speedometer Covers** are formed to fully cover plastic encased instruments on 1982-83 FXR models.  
**VT No. 42-0350**



**Speedometer and Tachometer Brackets.**

VT No.	Use
39-0143	Single Gauge Housing for 1973-up FX
39-0139	Speedometer & Tachometer Housing for 73-82 FX
39-0140	Cup for Speedometer and Tachometer, 1973-82 FX-FXE
31-3963	Chrome Tachometer Bracket, 1974-84

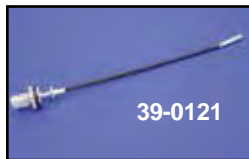

**Reset Cable and Knob** replaces 67210-73. Used on all 1973-up FX except 1981-82 FXWG and late 1984-up FXE-80 models.  
**VT No. 39-0121**

**High Beam Blue Indicator Lamp** with two wire leads. Use on all 1977-up FXS, all FX models, 1980-82, FXE-80 and 1980-up FXWG.  
**VT No. 39-0122**

**Red Generator Lamp** with two leads fits 1972-74 FX, 1977-85 FXS.  
**VT No. 33-1962**



**Chrome Center Tank Panel** for the split tanks of 1977-84 FXS-FXSB-FXEF-FXB models.  
**VT No. 39-0104**





# Mini Gauge Kit

## 48mm Deco or 60mm Mini Speedometer and Tachometer

Kits include gauge, chrome bracket and rubber handlebar clamp and proper cable which can be installed without any adapters or modifications.

48mm 60mm

Deco Mini Ratio Model/Years

### Speedometer

39-0365	39-0314	2:1	1936-67 FL
39-0368	39-0315	2:1	1973-95 FX, 1981-84 FL
39-0370	39-0371	2240:60	1981-96 FXST-FLST
—	39-0316	1:1	1968-80 FL, 1971-72 FX, 1980-83 FXWG

### Tachometer

39-0367	39-0392*	Electric three wire type
31-9997	Fits All	Chrome Y mount
33-2008	Fits All	Light socket with bulb
33-2047	Fits All	12 Volt bulb, 10 pack

**Note:** For use on 1978-up models with coil triggered tachometer. Green Negative wire goes to negative side of coil. Red wire goes to ignition side of key switch. Tachometer head must be grounded by black wire.

Cable 36-0512 fits 39-0314 and 39-0316 kits.

Cable 36-0603 fits 39-0315 kits.

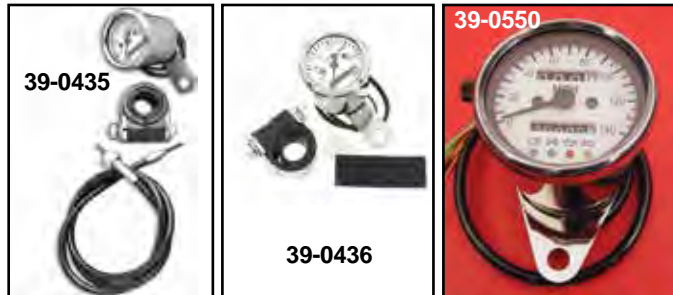

**Mini Gauges** include cable and mount clamp and 4 LED indicators. **Note: 60 mm size gauges feature four LED lights. 48 mm have three LED lights.**

- Blue-High Beam
- Green-Neutral
- Red-Oil
- Yellow-Turn Signals

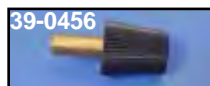

48 mm	60 mm	Ratio	Item	Year
39-0435	39-0550	2:1	Speedometer	1973-94
39-0436	39-0561	2240:60	Speedometer	1981-94 Softail
39-0438*	39-0576*	1978-up	Tachometer	Electric
39-0456	39-0456	Knob	Speedometer	

\*Note: Does not have LED indicators.

**39-0435, 39-0436, 39-0550, 39-0561 have turn signal lights.** Pre1990 models tap into orange wire exiting turn signal flasher, 1991-up models signal indicator light cannot be used

**60mm Electronic Tachometer/Speedometer** fits 1978-up models. Unit includes gauge, bracket and clamp.

VT No.	Item
39-0392	Tachometer
39-0203	Housing

**80mm Electronic Tachometer** features stainless housing and Y bracket. Fits 1978-up.

VT No. 39-0563



**Chrome Clamp** includes molded rubber insert to attach mini gauges to handlebars for less vibration. VT No. 28-0325



## 60mm Mini Electronic Speedometer and Tachometer.

Speedometer features easy push button recalibration and re-setable trip meter, with LED lighting. 8000 RPM Tach has LED lamp. All units have black face and include clamp. Order 12mm speedometer cable separately.

Three functions are (1) accumulated mileage (this can not be reset), (2) Trip One (can check total mileage for one full gas tank, can be reset to zero), (3) Trip Two (calculate mileage from A to B destination, can be reset to zero).

VT No.	Ratio	Item
39-0858	2:1	Speedometer
39-0860	0-8000 RPM	Tachometer

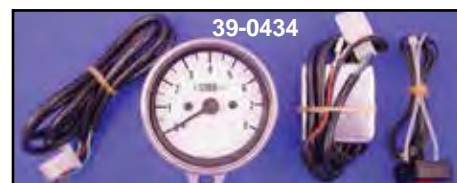

**Multi-Colored Mini Gauges.** 60mm gauge features a 2.4" polished stainless body with a white face, total length of 2.7". Units include a chrome bezel with choice of red, orange, blue, yellow, white, green or purple by the push of a button. Works on 12v systems. Tachometer adapter required for use with single fire ignition. Speedometer accepts 12 mm drive cable. Order clamp separately.

VT No.	Gauge	Ratio
39-0417	Speedometer	2:1
39-0434	Tachometer	Electric



**Chrome Billet Gauge Holder** fits 48mm or 60mm gauges.

48mm	60mm	Holes	Type
39-0602		None	Single
39-0603		2	Single
39-0604	39-0613	None	Dual
39-0605	39-0614	2	Dual

FLH Speedometers have 5/8" male fitting to attach cable as listed.

# Replica Speedometer



**39-0328** 1936-39 White features long style early needle, accepts reset knob VT No. 39-0134.  
**VT No. Ratio**  
**39-0305** 1:1  
**39-0328** 2:1  
 Replica Speedometer Production since 1983!  
 Over 50,000 Served!

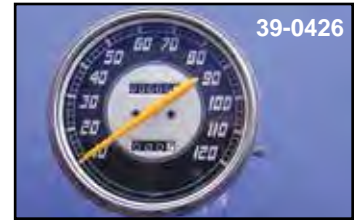
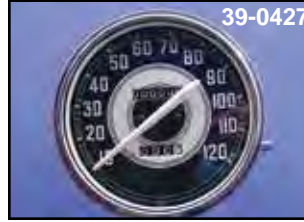
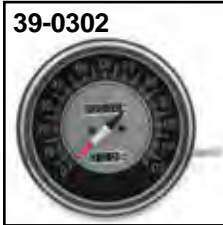
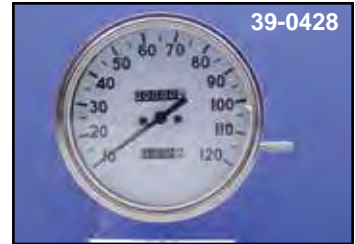
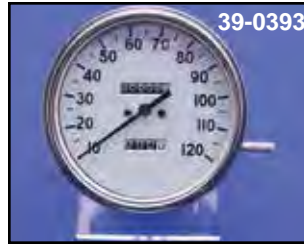

Replica Speedometers feature glass lens with stainless narrow bezel in 2:1 ratio with a 5/8" male cable fitting. Reset knob included.

VT No.	Year	Needle Type	Glass	Unassembled	Assy
39-0393	1936-39	Black Thin	Flat	39-0480	
39-0428	1936-39	Black Thin	Dome	39-0487	
39-0427	1940-45	White Airplane	Dome	39-0481	39-4045
39-0426	1946-47	Orange Airplane	Dome	39-0482	39-4647

### Silver and Black

VT No.	Ratio
39-0302	1:1
39-0313	2:1
39-0769	1:1
39-0770	2:1

Silver-Black (1-12) with silver numerals 1962-67.

VT No.	Ratio
39-0306	1:1
39-0326	2:1

### Speedometer Rim and Lens Installation.

VT No. 60-0743



A-Black 0-120 MPH and replaces 67004-68A, accepts reset knob 39-0134.

VT No.	Ratio	Face
39-0307	1:1	0-120 MPH
39-0329	2:1	0-120 MPH
39-0375	2240:60	0-120 MPH

B-Police Special Speedometers feature white numerals and needle.

39-0671	1:1	0-120 MPH
39-0932	2:1	0-120 MPH
39-0327	2:1	10-100 MPH
39-0862	2:1	0-100 MPH
39-0303	1:1	10-100 MPH
39-0322	1:1	0-120 MPH
39-0375	2240:60	0-120 MPH, 1980-84 FLH
39-0864	2:1	0-100 MPH, Police
39-0857	1:1	0-100 MPH, Police
39-0021	2:1	0-100 MPH, Police

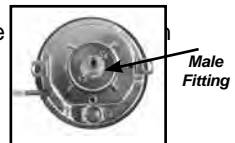

1948-61 Type Green features gold backing with green and black. VT No. 39-0301 is green and black on a glass face. VT No. 39-0374 and VT No 39-0993 have a red face.

VT No.	Unassembled	Ratio	MPH
39-0304		1:1	10-120 MPH
39-0861		2:1	10-120 MPH
39-0865		1:1	1-12 MPH
39-0998		1:1	1-12 MPH
39-0301	39-0525	2:1	1-12 MPH
39-0993		2:1	1-12 MPH



Speedometer Lamp Socket with bulb replaces 71151-48.

VT No.	Type
33-0531	Vinyl Wire
33-0529	Cloth Wire
33-0133	12 V Bulb
33-0132	6V Bulb
33-3065	Vinyl Wire

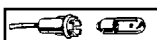

Bob Dash Speedometer Cable adapts to speedometer with 5/8" large male thread, as used in kits to transmission or front wheel drive.

VT No.	Length	Type	Fits
36-0607	39 1/2"	Front Wheel	All
36-2444	39 1/2"	As Above with Stainless Steel	
36-0126	39 1/2"	As Above with Stainless Clear Coat	
36-0610	42 1/2"	Front Wheel	All
36-2548	42 1/2"	As Above with Stainless Housing	
36-0621	35"	Transmission	1936-80 Big Twin
36-0897		Adapter	Male to Female

**Ratios**  
 2:1 Ratio Bob Speedometers fit 1936-61 Big Twin transmission drive type 1936-61 45 models and Servi-Car models  
 1:1 Ratio is for 1962-73 Servi-Car, 1962-80 FL-FLH 2240:60 1980-84 FLH





# Speedometer

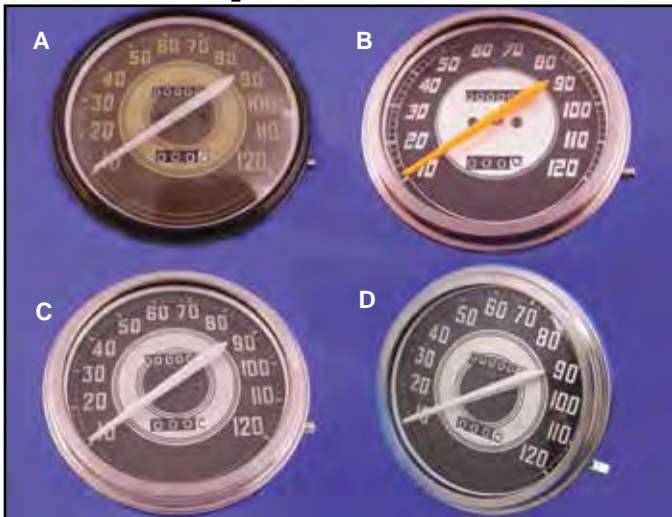

**Replica Speedometers** are for FL models. Features orange or white airplane style needles with silver numerals over black background. Great for restoration of 1941-47 models. Reset knob not included.

VT No.	#	Ratio	Needle
39-0298	A	2:1	Army graphics
39-0534	A	1:1	Army graphics
39-0308	B	1:1	Orange needle
39-0300	B	2:1	Orange needle
39-0976		2:1	Orange needle
39-0299	C	2:1	White needle
39-0410		—	Orange needle only
39-0477		—	White needle only
39-0458	D	2:1	White (Dome Glass)

**Ratios**  
**2:1 Ratio Bob Speedometers** fit 1936-61 Big Twin transmission drive type, 1936-67 45 and Servi-Car models.  
 1:1 Ratio is for 1962-73 Servi-Car, 1962-80 FL-FLH



**Reset Knobs.** Order for proper applications.

VT No.	OEM	Years/Type
39-0336*	—	1968-84 Knurled
39-0406*	—	1981-98 FL-FXST
39-0134	67215-68	1968-up FL with screw
39-0211	67217-68	Screw for Above, 10 pack
39-0403	67215-89	1981-95 FXST-FXWG
37-0519	67117-85	Screw for Above, 10 pack
39-0338	Alloy	All/Female
39-0121	67210-73	1973-84 FXE, Chrome
39-0764		1936-52

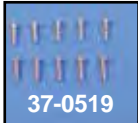

\*Note: Knurled type fits most aftermarket FLH gauges

**Speedometer Adapter Stud** will allow the use of 39-0134 later knob in speedometer with alloy knob. **VT No. 39-0173**



**FLH Speedometer Isolation and Mount Kit** mounts speedometers with 3/8" holes. Replaces 67066-76. Kit includes two pins, clips, bushings and molded outer ring.

VT No.	Item
28-1952	Kit
12-0594	Snap Ring Only
28-0155	Kit
28-2115	Rubber Ring
2629-4	Bolt Set, Cadmium
28-0157	Pin Kit

744



**Multi-Ratio Speedometers** are programmable for 1:1, 2:1 or 2240:60 ratio and feature a LED odometer readout or full digital readout. Will accept 12 or 16mm (5/8") cable ends.

VT No.	Type	Style
39-0731	Speedometer	LED
39-0730	Tachometer/Speedometer	LED
39-0609	Tachometer/Speedometer	Digital
39-0979	Speedometer	Digital



**Replica Speedometers** are original "Beck" aftermarket designs of the 1950's with red and white graphics on glass.

VT No.	Ratio
39-0993	2:1
39-0998	1:1

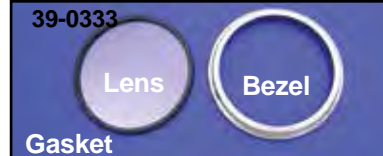

**Bezel/Lens Kit** fits FL speedometers kit, include stainless bezel, glass lens and sealing gasket.

VT No.	Years	Lens Type
39-0333	1948-84	
39-0451	1936-40	Flat
39-0452	1941-47	Dome

**Glass Speedometer Lens and Parts.**

VT No.	Fits	Type
39-0330	1936-40, 1948-up	Flat Glass
39-0331	1936-46, 1941-47	Domed Glass
39-1722		Green Glass
15-0681	1948-up	Lens Gasket

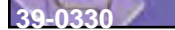



# Police Speedometer

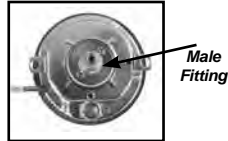

39-0932



39-0862



39-0303



39-0070



39-0071



39-0322



39-0375



39-0072



39-0073

Stewart Warner Police Speedometers for FLH models. Features a red needle.

VT No.	Ratio	Face
39-0070	2:1	39-0059
39-0071	2:1	39-0067
39-0072	1:1	39-0059
39-0073	1:1	39-0067

Police Special Speedometers feature a black face with white numerals and needle.

39-0671	1:1	0-120 MPH
39-0932	2:1	0-120 MPH
39-0327	2:1	10-100 MPH
39-0862	2:1	10-100 MPH
39-0303	1:1	10-100 MPH
39-0322	1:1	0-120 MPH
39-0375	2240:60	0-120 MPH, 1980-84 FLH
39-0864	2:1	0-100 MPH, Police
39-0857	1:1	0-100 MPH, Police



39-0871



39-0872

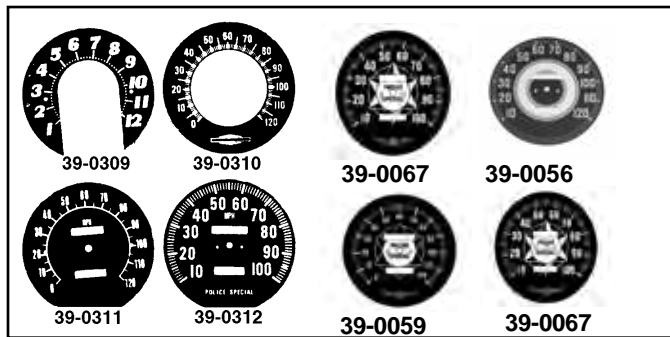

39-0309

39-0310

39-0067

39-0056

39-0311

39-0312

39-0059

39-0067



39-1126



39-1127

Police Special Speedometers.

39-0871 1:1

39-0872 2:1

Vintage Face

39-1126 1:1

39-1127 2:1

Speedometer Tins.

VT No. Type

Ratio

39-0017 Black Tin

39-0018 Black Tin

39-0019 Black Tin

39-0021 White Tin

39-0053 Olive Tin

39-0054 Black Tin

39-0055 Black Tin

39-0060 Cream Tin

39-0068 Black Tin

FLH Speedometer Tin Faces. Speedometer must be disassembled to install.

VT No.	Year	Models
39-0309	1962-67	FL
39-0310	1968	FL
39-0465	1968	FL
39-0311	1968-80	FL
39-0312	1968-80 Police	FL
39-0067	Police	100 MPH
39-0053	Army	
39-0056	Black	
39-0057	Cream	
39-0058	Bull's Eye	
39-0069	White	
39-0082	Police	
39-0021	White Tin, 0-100 MPH	
39-0067	SW Police 0-100 MPH	



39-0465



39-0021





# Wrap-Around Oil Tank



40-0424  
1936-57



40-0489



40-0480



40-0279



40-0280



40-0426



40-0472



40-0473

**Replica Oil Tank** features wrap around type construction, including seam-welded edges which show weld marks as on original tanks. The 1958-64 type has battery rod tab supports. All have screw in dipstick except side fill, which has a rubber plug.

VT No.	Finish	Type	Years
40-0424*	Black	Stock	1936-57
40-0432*	Chrome	Stock	1936-57
40-0489*	Raw	Stock	1936-57
40-0996	Black	Stock	1958-64
40-0426	Chrome	Stock	1958-64
40-0429	Chrome	Side Fill	1936-64
40-0280	Pcs	Raw	1936-64
40-0428	Chrome	Dipstick Cap	1936-64
40-0444	Zinc	Dipstick Cap	1936-64

\*Note: 1936-57 without battery rod tabs.



40-0475

**Replica Oil Tanks** include original style and accoutrements in chrome or gloss black finish.

Black	Chrome	Year
40-0480	—	1936
40-0472	40-0279	1937
40-0473	40-0475	1938-39
40-0623	Fitting	1937
40-0835	Fitting	1937
40-0614	Kit	1940-57
40-0617	Kit	1938-39
40-0328		Liner

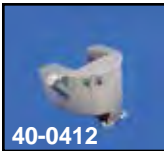

40-0412

**Three Quart Kick Start Oil Tank** is for swingarm frames with aluminum inner primary covers on 1965-84 models. Use 12N55A-3B VT No. 53-0505 battery, clamps for battery must be fabricated.

Chrome	Item
40-0412	Side Fill Oil Tank
37-9242	Drain Plug
53-0505	Battery



40-0809

**Wyatt Chrome Horseshoe Tank** is a 3½ quart replacement for 1936-64 rigid or swingarm frames. Accepts stock 6 Volt battery and original or custom braided oil lines. Fits with tin inner primary only.

VT No.	Item
40-0809	Center Fill/Smooth
40-0811	Side Fill/Smooth
31-0192	Rigid Bracket
37-0098	Drain Plug



40-0488



40-0493

**Replica "Bobber" Rigid Frame Oil Tank** fits 1936-57 Big Twins. Tank is 1½" shorter

to accommodate a raised position for chain alignment. Tank will accept mini 12 volt battery.

Chrome	Black
40-0488	40-0493
37-1018	Spacers

**Stainless Oil Tank and Battery Cover.**  
VT No. 42-0322

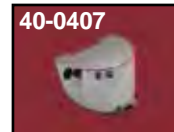

40-0407

**Chrome Magneto Oil Tank** fits Big Twin rigid or swingarm frames 1936-84. It has a 5 quart capacity for big incher. It is not designed to hold battery. Use with tin primary or open belt drive only. Order rear bracket separately.

VT No.	Item
40-0407	Tank
31-0192	Rigid Rear Bracket
31-0191	Swingarm Rear Bracket, zinc
37-9242	Drain Plug



49-7577

**Replica Dipstick** includes a copper washer.

VT No.	Item
49-7560	1936-40
49-7577	1941-64
40-0630	1941-64
15-0192	Copper Washer
2903-2	1936-40 Cadmium
2907-2	1936-40 Parkerized
2908-2	1941-64 Parkerized
2904-2	1941-64 Cadmium



**1937 Oil Tank Kit** fits 1937-47 EL & 1941-47 Knuckle. Chrome seamless tank includes cadmium lines and fittings. Early banjo bolt configuration has a great retro look. VT No. 40-0281



# Oil Tank

CLASSIC



40-0417



40-0413,  
40-0417



40-0406



40-0455



40-0414



40-0405



40-0405



**FX-FL Chrome Oil Tank** for 1965-84 models. Includes filler plug. Cap and filter not included. VT No. 40-0455 kit includes

chrome tank, cap, oil filter and mount kit.

VT No.	Finish	Item
40-0417	Chrome	Tank
40-0626	Primer	Tank
40-0410	Black	Tank
40-0455	Chrome	Kit
40-0413*	62483-81	1981-82
40-0414**	62504-82	1982-86



40-0626

will not accept internal canister

**\*Note:** Fits up to 1985, accepts Internal Canister.

**\*\*Note:** Requires battery carrier bracket 42-9912 for FX models and 42-9910 for FL models



**Chrome Edging for Oil Tank** is for use on FLH-FXE 1965-84 model, and is fastened by stock screws. Replaces 62534-65.

VT No. 42-0506

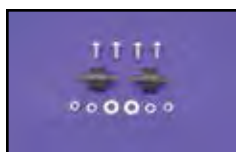

**Oil Tank Mount Kit** is 1965-84 FXE-FLH. Includes zinc plated bolts and hardware as illustrated to mount tank to frame and battery box.

VT No. 40-0320

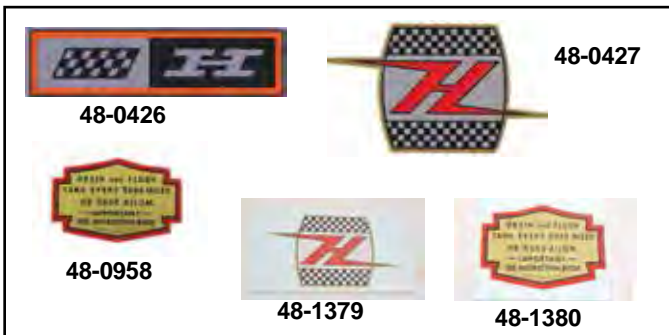

**Oil Tank Decals** are FLH style. (5 pack except where noted)

Adhesive	Water Based	OEM	Style
48-0426	—	62535-65	H, Long
48-0427	48-1379	62535-61A	H, Lightening
—	48-0439	—	Decal "V"
48-0958	—	Pair	3 <sup>9</sup> / <sub>16</sub> " x 1 <sup>3</sup> / <sub>8</sub> "
—	48-1380	Each	3 <sup>9</sup> / <sub>16</sub> " x 1 <sup>3</sup> / <sub>8</sub> "



40-0406  
Installed

**Chrome Smooth or Hex Wrap Around Oil Tank** installs on stock FX-FL swing arm frames 1965-84 and houses the stock FXE battery, VT No. 53-0518 and allows removal of battery without removing the tank from the frame. All fittings exit from the bottom of the tank on 3<sup>1</sup>/<sub>2</sub> quarts.

VT No. Type

40-0406 Smooth, Can only be used w/Hitachi type starter motor

40-0405 Hex Type

37-9242 Drain Plug



40-0408

**Chrome Electric Start Wrap-Around Oil Tank** with four quart capacity, fits 4-Speed stock rigid and swingarm frames pre-1984 Big Twins, not FXR. It features built in battery box for VT No. 53-0518 battery, FXE type. 4 quarts.

VT No. Item

40-0408 Oil Tank

31-0191 Rear Bracket

37-9242 Drain plug





# Oil Cap



40-0503



40-0495

Oil Temperature Dipstick for 1965-84.

VT No. Style

40-0503 Temperature

40-0495 Stock



Oil Tank Plug is constructed of rubber with chrome cap for tanks which accept a push in plug. VT No. 28-0219



40-0504

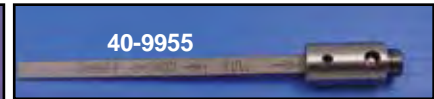

40-9955



40-0845

Chrome Oil Tank Cap fits the stock type oil tanks on 1965-84 FX-FL models. Replaces 62610-52A.

VT No. Item

40-0504 Cap includes gasket and retaining ring assembled

40-0845 Cap with filter

15-0329 Gasket

40-9955 Dipstick

12-0970 Retaining Ring

# Oil Tank Mount Hardware



Domed Round Tank fits Softail models, center fill.

VT No. OD Finish

40-0479 5.5" Raw

37-8961 Drain Plug



31-0733



31-0734



42-9919



42-9918

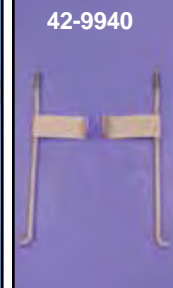

42-9940



31-0190



31-0192



31-0191



42-9920



42-0877



42-0537

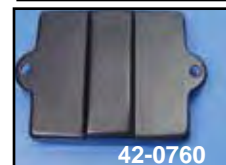

42-0760



42-0762

Oil Tank Hardware. Items are plated as noted to fit wrap-around oil tanks for 1936-64 models.

VT No. Item

42-9919 Rod Set with pads

31-0190 U-Clamps

42-9918 1936-57 Replica Rod Set w/pads & flags

42-9940 1958-64 Replica Rod Set

31-0192 1936-57 Rear Bracket

31-0544 1936-57 Rear Bracket

31-1055 1936-57 Rear Bracket

49-0846 1936-57 Rear Bracket, replica

31-0191 1958-64 Rear Bracket

42-9920 Lower oil tank plate

42-0877 Replica Oil Tank Plate

42-0867 Replica As Above

42-0537 Battery Top

42-0760 Battery Top, Replica

42-0762 Battery Top, Replica

42-1275 Top Kit

42-1276 Top Kit

Finish

Chrome

Chrome

Parkerized

Parkerized

Chrome

Parkerized

Raw

Parkerized

Chrome

Chrome

Black

Chrome

Chrome

1936-47

1948-57

Oil Tank Brackets.

VT No.

Frame

Fits

31-0733

All Front

Both

31-0734

Swingarm

Rear



51-0150



51-0516

Oil Tank Repair Kit can be welded on to replace broken bracket on original 1936-64 oil tanks. Full kit includes three pieces. Chain guard tab set sold separately.

VT No.

Item

51-0150 Kit

51-0516 Chain Guard Tabs

40-0280 Tank Pieces

31-0355 Rear Brackets



1936-57



1958-64

Oil Tank Mounting Kit includes fasteners and spacers to mount oil tank on Big Twin.

1936-57 1958-64 Finish

8213-8 9206-12 Cadmium Kit

8213-8T Cadmium Kit, VT

9602-8 9205-12 Chrome Kit

9667-8 Parkerized Kit

37-9087 Spacer, Zinc

37-9332 Spacer, Parkerized

748



8213-8



# Steel Oil Line Set

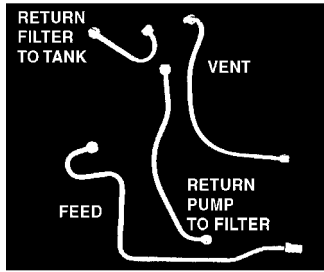

**Steel Oil Lines** are replacements for 1936-64 Big Twin Overhead Valve models. Lines come in chrome or cadmium for restoration. Supplied with nipple nuts already attached to fit wrap-around and stock oil pumps on Big Twin models listed below. Order oil pump fittings separately.

**Swingarm Frame With Filter** for 1958-64 models.

VT No.	Item	Pieces
40-0103	Chrome Set	4
40-0377	Cadmium Set	4
40-0106	Chrome Filter, Line Set only	2
40-0371	Cadmium Filter, Line Set only	2

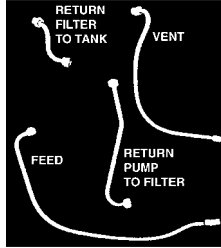

**Rigid Frame With Filter** for 1936-57 models.

VT No.	Type	Pieces
40-0101	Chrome Set	4
40-0375	Cadmium Set	4
40-0107	Chrome Filter Line Set only	2
40-0370	Cadmium Filter Line Set only	2

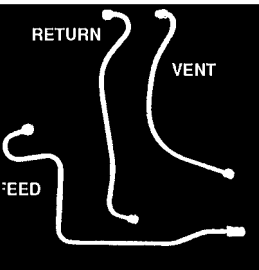

**Swingarm Frame without filter** 1958-64 models.

Chrome	Cadmium	OEM	Type
40-0102	40-0376	3 Piece	Set
40-0110	40-0133	63511-58	Feed
40-0131	40-0134	63572-58	Vent
40-0165	40-0166	63506-58	Return



**Oil Line Fitting Kit** includes four cadmium plated fittings for use with stock lines when an external oil filter is used.

VT No.	Fits
40-0505	1940-57 Rigid
40-0506	1958-64 Swingarm

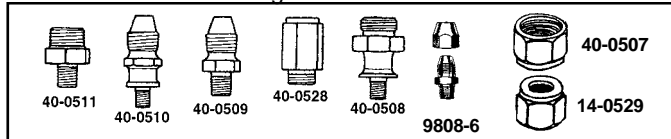

**Big Twin Oil Pump and Filter Fittings** in cadmium.

VT No.	OEM	Years	Application
40-0509	63533-15	1936-64	Oil Pump to Line
40-0510	26424-50	1950-64	Oil Pump Cover to Line
40-0508	63526-50	1950-57	Oil Pump Cover to Filter Line
40-0511	63525-50	1940-64	Oil Filter Line Connector
40-0528	63524-50	1951-64	Oil Filter Line Connector
40-0507	63527-50	1950-64	Oil Filter Line Nut
40-0605	63871-50	1941-64	Oil Filter Cap Adapter

**Oil Nipple Cap** is cadmium plated. Replaces 3583-15 to cap oil fitting during storage. (Pack of 6).

VT No. 9808-6

**Oil Line Nut, Oil Line Sleeve Nut** replaces 63527-50. Cadmium plated.

VT No.	Item
40-0507	Nuts, pair
14-0529	Rubber Seal, 63529-50T



**Oil Tank level gauge** is for wrap around oil tanks original and aftermarket type. This is an accurate reproduction of the original factory accessory. Installation requires drilling of tank body. Fits 1936-1952 EL, 1941-1964 FL.



VT No. 40-0269



**1936-57 Overhead Valve Chrome Steel Oil Lines** fit S&S or Sifton™ Cast Pumps when engine is installed in a rigid frame with stock wrap-around oil tank.  
VT No. 40-0171

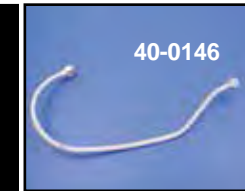
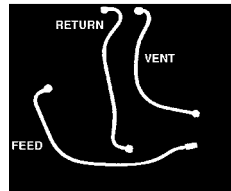

**Rigid Frame without filter, OHV models.**

Chrome	Cadmium	OEM	Type	Year
40-0099	40-0374	Set	3 Piece	1941-48
40-0163	40-0164	Set	3 Piece	1949-57
40-0111*	40-0144	63506-41	Return	1949-57
40-0108	40-0142	63572-38	Vent	1938-57
40-0109	40-0143	63511-38	Feed	1938-57
40-0132	40-0135	63506-38	Return	1941-48
—	40-0145	3571-36	Feed	1936 only
—	40-0146	3571-37D	Feed	1937 only
—	40-0147	3572-36	Vent	1936-37
—	40-0148	3571-36A	Return	1936-37
—	40-0149	3571-38C	Return	1938-40

\*Note: Cross over to inside of tank for 1949-57 use.

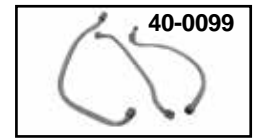
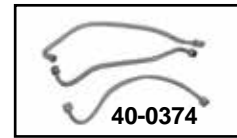
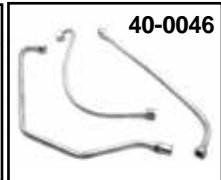
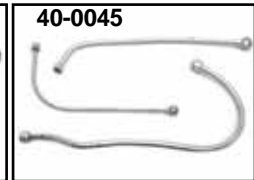
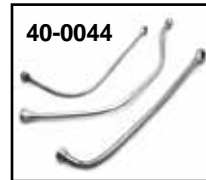

**Oil Line Set.**

40-0044	1936	Cadmium
40-0045	1937	Cadmium
40-0046	1938-40	Cadmium
40-0374	1941-47	Cadmium
40-0099	1941	Chrome

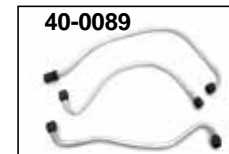
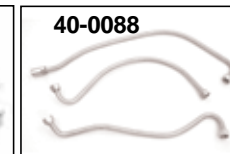
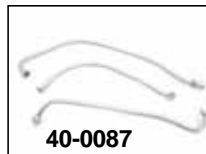

**Aluminum Oil Line Kits** for OHV Knuckleheads.

VT No.	Year
40-0087	1940 EL
40-0088	1941 EL, FL
40-0089	1943-45 EL, FL Cadmium with parkerized nuts



**1936 Knucklehead Oil Line and Gauge.**

VT No.	Item
40-0896	Line
40-0844	Gauge
32-1633	Amp Gauge





# Oil Line Fitting



**Chrome Oil Line Fittings** for 3/8" hose. Thread is 1/8" NPT.

VT No.	OEM	Type	U/M
40-0566	63533-41	Straight, Replica	5
2070-1	As Above		Each
40-0521	Barbed	Straight	5
40-0519	26496-75B	90 degree angle	5

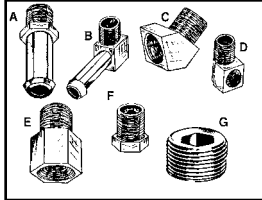

**Chrome Male Fittings** for gas and oil measured in NPT thread and inner diameter of line.

A-Straight	B-90°	Size
40-0525	40-0532	1/8" NPT - 5/16" Hose
40-0526	40-0529	1/8" NPT - 1/4" Hose
40-0566	40-0519	1/8" NPT - 3/8" Hose
40-0608	—	1/4" NPT - 1/4" Hose
40-0527	40-0530	1/4" NPT - 5/16" Hose

**Chrome Male Female Fittings.**

VT No.	#	Type/Size
40-9990	C	45° 1/8" NPT - 1/8" NPT, Street Elbow
12-1416	D	90° 1/8" NPT - 1/8" NPT
12-1419	E	Straight 1/8" NPT - 1/8" NPT

**Male Plugs.**

VT No.	#	Size
23-0611	F	1/8" NPT, Chrome
40-0531	F	1/4" NPT, Chrome
37-8777	G	1/8" NPT Hex Socket Plug, Plain
40-0609	H	1/4" to 1/8" NPT



**Oil Tank Drain Plug** in stock chrome, cadmium or parkerized finish.

VT No.	Finish	Type
8114-1	Chrome	Stock
8115-1	Cadmium	Stock
9404-1	Cadmium	Oversize
9304-1	Chrome	Oversize
9714-1	Parkerized	Oversize
9502-1	Chrome 1939-51	Stock
9504-1	Parkerized as above, 7/8" Hex	Stock
9503-1	As above cadmium	Stock
37-9067	Washer	25 pack

**Banjo Bolts and Washers.**

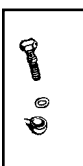

VT No.	OEM	Item
40-0518	63678-36	Vent Line Banjo Bolt
40-0670	63577-36	Vent Banjo Fitting
14-0154	6440	Washer, Vent Lines, 10 pack
40-0156	3520-36A	Bolt, Feed and Return, each
40-0157	3570-36B	Washer, Feed, 10 pack



**Oil Line and Vent Line Fittings** replace type used on 1936-64 Big Twins. For braided stainless steel or stock rigid steel oil lines, three pieces.

VT No.	Type
7612-3	Cadmium
7148-3	Chrome
40-0514	Chrome
40-0297	Zinc



**Magnetic Drain Plugs** prevent metal particles from circulating through engine and transmission cases and oil tank.

VT No.	OEM	Size	Use
37-0096	707	1/2" - 13	74 and XL Transmission
37-0097	700	3/8" - 24	Big Twin Case Plug 74 & 80
37-0095	60348-65A	1/2" - 20	74 & 80 Inner Primary
37-0098	720, 706A	5/8" - 18	Oil Tank and Timing Hole
37-0099	739A	1/8" - 27	NPT 1990-up BT Trans
37-9242		1/8" - 27	As Above with Hex
37-8961	718	1/4" - 18	NPT Chain Cover



**Drain Plug Washer** for use on 1952-up brass crush-seal factory type. Replaces 62702-52. (10 pack). **VT No. 15-0194**

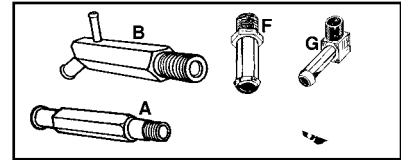

**Oil Fittings** for Big Twin.

VT No.	#	OEM	Item
40-0566	F	63533-41	Straight
12-1412	A	63533-65	Oiler Return
40-9982	B	63541-70	Oiler T, Rear Chain
40-0579	G	Chrome	As Above
40-0549	G	16305-99	Elbow, 1999-up
40-0552	F	26314-99	Straight 1999-up
17-0519	G	62375-57	Elbow
40-0553	G	63554-90	Elbow



**Chrome Oil Line Fitting Set** includes the necessary plugs and fittings for Shovelhead. Fits 1970-81.

**VT No. 40-0560**



**Oil Vent "T"** fits 71-84 Big Twin. **VT No. 40-0559**



**Cadmium Oil Nipple Cap** replaces 3583-15 to cap oil fitting during storage. Pack of 6. **VT No. 9808-6**

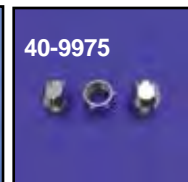
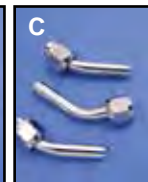
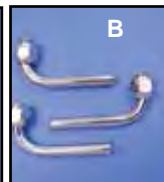

**Nipple Nuts and Tube Ends** will attach to tapered tank 63533-15 type fittings and will accept braid or rubber hose. Available straight, 90° or 45°, with chrome finish.

VT No.	#	Item
40-9975		Nut, 3 pack
40-9992	A	Straight Tube, with nut
40-9993	B	90° Elbow, with nut
40-9994	C	45° Elbow, with nut
40-0514	D	Fittings





**Fuel-Oil Hose** in black or clear. Sold in shop rolls.

Black	Clear	Size
40-9999	—	1/8" x 25' long
40-0117	40-1250	3/16" x 25' long
40-0118	—	1/4" x 25' long
40-0119	40-1252	5/16" x 25' long
40-0254	—	5/16" x 6' long
40-0120	—	3/8" x 25' long
40-0253	—	3/8" x 6' long
40-0126	—	1/2" x 25' long



**Stainless Hose Clamps** are available in Worm Gear type or Torro drive type. Torro drive clamps feature pressed tooth and raised band edges to prevent damage to hose.

Worm Gear	Size	Type
35-0413	7/32"-5/8"	Fuel
35-8031	3/8"	Oil



**Russell Endura Fittings** feature compression end and

tapered internal nut. For 3/8" inner diameter braided oil hose.

VT No.	Angle
40-0537	Straight
40-0538	45°
40-0539	90°
40-0541	Adapter Fitting



**Braided Stainless Hose** in bulk length and can be cut to length as needed.

Use econo-seal ends or hose clamps to attach to fitting. **Warning:** Not for use in brake systems.

VT No.	Size	Length (Ft)	Brand
40-0202	1/4"	10	V-Twin
40-0200	5/16"	5	V-Twin
40-0245	5/16"	25	V-Twin
40-0276	5/16"	25	Sifton
40-0210	3/8"	10	V-Twin
40-0244	3/8"	25	V-Twin

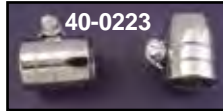

**Chrome Econo-Seal Hose Ends** act as clamp and finished end when stainless jacket rubber hose is cut. Micro clamp is hidden under chrome end.

Smooth	Hex	Fits	Qty
40-0222	40-0213	1/4	6
40-0248	—	5/16	6
40-0223	40-0214	3/8	6
40-0224	40-0218	1/4	2
40-0249	—	5/16	2
40-0225	40-0219	3/8	2
—	40-0220	13/16 ID	1
—	40-0591	15mm	2
—	40-0592	17mm	2



**Radii Polished Stainless Steel Hose Lock** is a compression fitting that replaces

conventional hose clamps. Feature a cleaner appearance and superior sealing performance.

Pair	Each	Size
35-0180	35-0175	1/4"
35-0181	—	5/16"
35-0183*	—	5/16"
35-0182	—	3/8"



\*Note: Fits S&S Super "E" carburetor fitting.



**Oil Line Fitting Kit** includes four cadmium plated fittings for use with stock lines when an external oil filter is used. Fittings will work with aluminum cover oil pump only.

VT No.	Fits
40-0505	1940-57 Rigid
40-0506	1958-64 Swingarm

# Oil Line & Fitting



**Chrome Oil Line Fitting Set** allows use of 3/8" braided steel lines. Set has built in compression fittings, so no need for clamps. Reusable three piece set.

VT No.	Thread	Fits
40-0583	1/8" NPT	Early



**Oil Hose Supports.**

VT No.	Style
31-0124	With hole
31-0125	Stock



**Chain Oiler Fitting** replaces 60549-70 on 1970-84 FL-FX models. It attaches to inner primary cover. Sold each.

VT No.	Type
40-0524	Stock
40-9976	Side Hole for Extra Chain Oil



**Cadmium Plated Straps** used on 1952-67 clutch booster cable, 1965-71 FX, FL models oil tank feed line hose and 1958-71 sidecar brake tube.

VT No. 2753-5

## Panhead 1963-65



**Replica Panhead Y Oil Line Kit** for use on stock 1963-65 heads or on STD heads for outside oiling. Timing cover must be drilled for oil feed to this line. \*Note: Has elbowed fittings

VT No.	Finish/Item
40-0179*	Steel, Chrome
40-0113	Chrome
40-0129	Tin Plate
40-0128	Elbow, brass
40-0230	Elbow, zinc

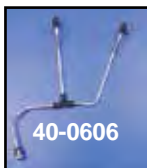

**Chrome Y Oil Line.** Updated design allows even flow to both hands on external oil Panheads when installed on Shovelhead lower ends.

VT No. 40-0606





# OHV Oiler Shovelhead 1966-84

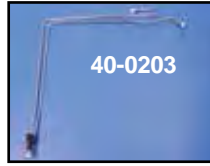
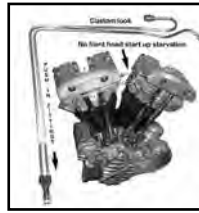

**Chrome Oil Line Sets** for rocker boxes which include fittings and seals.

VT No.	Years	Model	Finish
40-0114	1966-84	Shovelhead	Chrome
40-0127	1966-84	As Above	Zinc
40-0130	1966-84	Stroker	Chrome
40-9986	Fittings 4 pack, for Above		
14-0147	63529-57 Seals only, 100 pack		
14-0189	63529-57 Seals only, 50 pack		
14-0930	As Above Red Silicone, 50 pack		



**Shovelhead Chrome Rocker Box Lines** for 1966-84 Big Twin by Sifton™. Feature an updated fitting design for ease of installation.

VT No.	Type
40-0180	Stock
40-0130	Stroker Extended

**Rocker Box Line Kit** includes "T". Fits 1966-84 Shovelhead.

VT No.	Finish	Size
40-0203	Chrome	3mm
40-0235	Brass	6mm
40-0237	Chrome	6mm



**Overhead Stainless Steel Braided Rocker Arm Oil Lines** fits 1966-84.

VT No. 40-0241



**Top End Oil Restrictor for Shovelhead Engines.**

Special fitting that uses a #100 jet to control oil flow on 1966-84 Big Twins. Installs in engine case where the top end oil line feeds.

VT No. 40-0050



**Russell Universal Pro System Oil Lines** features a unique compression fit sealing system which ensures a positive seal on 3/8" barbed type oil pump or oil tank fittings. Lines are covered with braided stainless steel wire which is crimped on the chrome ends. Sold each. Use with 40-0566 fitting.

VT No.	Length	VT No.	Length
40-5010	8"	40-5018	16"
40-5011	9"	40-5019	17"
40-5015	13"	40-5020	18"
40-5016	14"	40-5021	20"
40-5017	15"	40-5022	22"
		40-5024	26"



**Oil Pump/Tank Fitting.**

VT No. 40-0566



**Compression Fitting and Hose Kit** includes six reusable compression fittings with 1/8" NPT threads for oil pumps and tanks, and ten feet of 3/8" stainless steel braided hose.

VT No. 40-0459

**Oil Line Without Elbows** fit Big Twins with wrap-around oil tank and tin primary covers. Order VT No. 40-0514, 3 piece fitting set to connect lines to oil pump or tanks that have 1/8" NPT threaded inserts.

VT No.	U/M	Type
40-9928	Set	Without Elbow
40-9997	Set	With Elbow



**Stainless Oil Line Kit** includes one 10' 3/8" braided hose, six chrome econo-seal hose ends.  
VT No. 40-0418

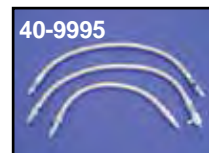

**Chrome Steel Braided Oil Line Sets** are complete lines for Big Twin models.

VT No. Description

40-9995	Set without elbows fits 1968-80 Shovelhead 4-Speed models, with stock oil tank and inner primary without elbows
40-9996	Set with elbows 1968-80 Shovelhead wrap-around oil tank and stock inner primary



**Nugget Oil Gauge Kit** has original hex design to place oil gauge at rocker box level on 1966-84 Shovelheads. Sold as kit with 60 lb. liquid filled gauge. Hex dome matches our rocker shaft end plugs late 7142-4, early 7143-4.

VT No.	Item
40-9987	1957-70 Complete Kit
40-9988	1971-85 Complete Kit
40-0359	1957-70 Fitting only
40-0358	1971-85 Fitting only
40-0010	1971-85 Fitting Only Knuckle Nut Style
40-0500	60lb Gauge only, liquid



**Liquid Filled 1 1/2" Oil Pressure Gauges** feature weather resistant sealed lens, stainless steel case, chrome rim and extra heavy mechanism. Liquid filled face eliminates needle bounce giving a constant reading. All gauges have 1/8" NPT male rear fitting.

VT No.	#	Pounds	Face	Brand
40-9906		0-30	Black	V-Twin
40-0500	A	0-60	White	AEE
40-0569		0-60	Silver	Sifton
40-0571		0-60	Blue	Sifton
40-0382	B	0-60	Black	Accel
40-0386		0-60	Black	V-Twin
40-9907	B	0-100	Black	Accel
40-0385		0-100	Black	V-Twin

## Oil Gauge



**1 1/2" Deluxe Liquid Filled Oil Gauge Kit.** Liquid filled face eliminates needle bounce giving a constant reading. Gauge features weather resistant sealed lens with chrome rim & extra-heavy mechanism, stainless steel case. Includes chrome fittings for bolt-on installation.

VT No.	Years
40-0517	1941-69
40-0516	1970-84



**Mini Oil Gauge Kit** for 1971-84 Big Twins. Includes 1" oil pressure gauge and chrome rocker box fitting.

VT No.	Item
40-0878	Kit
40-0589	1/8" NPT Gauge Only



**Oil Gauge Fittings** accept standard oil gauge with 1/8" NPT, each.

VT No.	Years
12-1414	1968-84
12-1413	1941-69



**Sifton Big Twin Oil Pressure Gauge Kit** includes chrome fittings and oil filled 0-60lb gauge. Fits 1970-84.

VT No. 40-0572



**Chrome Oil Gauge Cover** is machined of alloy, with square hole in bottom.

VT No. 40-0448



**Chrome Billet Clock Assembly** fits 7/8" or 1" handlebars. VT No. 39-0785

## Oil Cooler



**Oil Coolers** feature multipass oil flow configuration, specially designed turbulators in each oil passage way, highly concentrated mini-louvered air fins.

### Sifton

40-1516	1982-84 FXR, 1984-99 ST-FLT, 1955-83 FL, 1971-83 FX
40-1518	1982-84 FXR, 1957-up XL, 1980-99 FLT, 1980-99 FLT, 1984-99 FLST, 1955-83 FL, 1971-83 FX

### Vertical Mount by Jagg

### Deluxe Chrome Fits

40-1510	40-1512	1955-83 Panhead/Shovelhead, 1982-94 FXR
---------	---------	---



**Sifton Oil Cooler** replica style in black or chrome.

VT No.	Finish
40-0305	Black
40-0306	Chrome



40-0306



**Oil Cooler Brackets** will mount 40-0305 and 40-0306 Sifton Coolers on Big Twin 1955-84.

VT No.	Item
31-0154	Bracket
31-1253	Kit





# Oil Filter



**Oil Filter Canister Assembly** replaces 63800-48 on 1948-64 BT models and will accept replica brackets as listed with stock steel oil line and fitting sets. Order brackets, lines and fittings separately from this page. Features slip on hose fittings which can be substituted with screw in fittings to accept metal lines.

- VT No. Finish**
- 40-0095** Chrome
- 40-0090** Chrome with Polish Top
- 40-1948** Polished "1948"
- 40-0982** Top Fitting
- 40-0873** Fitting

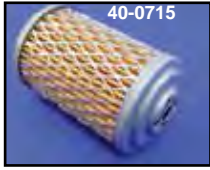

- 1948-64 Canister Filter.**
- VT No. Type**
  - 40-0712** OE
  - 40-0715** Metal Perforated
  - 15-0099** Seal (40-0715)

**Oil Canister Rebuild** includes small parts and gaskets for rebuilding.

- VT No. Item**
- 15-0616** Small Parts Kit
- 40-0501** Center Stud Set
- 12-0164** 1/4" Steel Ball
- 15-1378** As Above Molded Rubber
- 15-1160** Filter Gasket
- 15-0099** Gaskets
- 14-0529** Oil Line Seals, 10 pack
- 40-0943** Complete Rebuild Kit with filter



**Finned Oil Filter Canister.** Original design by George Smith, Sr. in the 1950's at S&S Cycle for external filter assemblies.

**VT No. 40-0201**



**Oil Line Fitting Kit** includes four cadmium plated fittings for use with stock lines when an external oil filter is used. Fittings will work with aluminum cover oil pump only.

- VT No. Fits**
- 40-0505** 1940-57 Rigid
- 40-0506** 1958-64 Swingarm

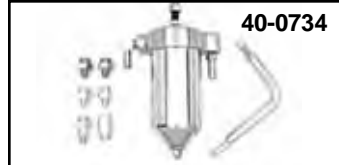

### Oil Filter Kits.

- VT No. Year**
- 40-0564** 1936-47  
Includes oil filter assembly with polished top and chrome canister body and zinc plated mount bracket.
- 31-1256** 1936-47
- 40-0846** 1948-57
- 40-0613** 1936-47
- 40-0734** 1958-64

**1940-47 Knucklehead Oil Filter and Bracket Kit.** Order oil lines and fittings separately.

- VT No. Item**
- 40-0370** Oil Line Set, Cadmium
- 40-0107** Oil Line Set Chrome
- 40-0505** Fitting Set
- 40-0201** Finned Body
- 31-1256** Bracket
- 31-1281** Bracket, 1936-47

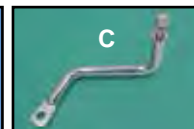
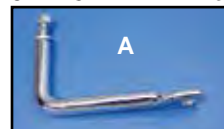
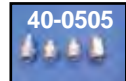

### Big Twin Chrome Oil Canister Mount Brackets.

- | VT No.   | # | Year    | Model    | Finish |
|----------|---|---------|----------|--------|
| 31-4001  | B | 1948-57 | Rigid    | Chrome |
| 31-4002  | A | 1958-64 | Swingarm | Chrome |
| 31-4003* | C | 1965-84 | FX, FL   | Chrome |
| 31-4004  | B | 1948-57 | Rigid    | Zinc   |
| 31-4181  |   | 1958-64 | Swingarm | Zinc   |
| 31-1281  |   | 1936-47 | Bracket  |        |

\*Notes: Oil lines must be fabricated.

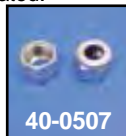
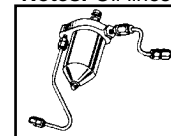

**Oil Filter Canister Line Set** is a two piece line with nuts for rigid and swingarm frames.

- VT No. Item**
- 40-0106** Chrome Swingarm Line Set
- 40-0371** Cadmium Swingarm Line Set
- 40-0107** Rigid Chrome Line Set
- 40-0370** Rigid Cadmium Line Set
- 40-0507** Nuts only, pair, cadmium
- 14-0529** Rubber Seal, 63529-50
- 40-0761** 1948 Line



# Oil Filter



**Early Style Oil Filter** features a chrome spin on filter.  
**VT No. 40-0796**

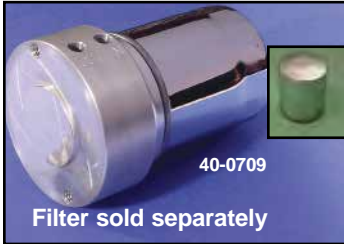

40-0709  
 Filter sold separately



40-0316

**Generator Oil-Filter Adapter** bolts in place of 2 brush generator or alternator generator Big Twin case conversions, use 40-0709 filter.

VT No.	Item	Finish
40-0315	Adapter	Alloy
40-0316	Adapter	Chrome
40-0709	Chrome Filter	



40-0100

**FXST Style Oil Filter Kit** features bolt on mounting behind shift plate. Big Twin frames with 1970-up Shovel or Evo engines. Can be used as an easy access auxiliary unit in addition to

filter in tank. Bracket is replica of 1984-99 FXST type replacing 63802-84. Oil spigots are copper, brazed in a vacuum for lasting durability. Includes chrome filter and 6 feet of rubber hose with clamps.

VT No.	Item
40-0100	Complete Kit
40-0709	Chrome filter
40-0708	Black filter



40-0100



40-0091

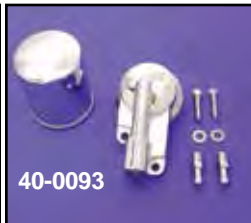

40-0093

**Oil Filter, Housing and Bracket Kit** features 92-up style location, to fit 70-84 Big Twins nose cone motors when using an outside frame front pipe. Mounts under front motor mount.

VT No.	Item
40-0091	Kit
40-0093	Housing



**Pura-Flo Universal Clamp on Oil Filter Kit** includes filter and hose.

VT No.	Item
40-0850	Kit
40-0709	Filter



40-0098



40-0952

**Universal Oil Cooler-Filter Kit** includes chrome spin on filter, finned mount flange, with hose and clamps.

VT No.	Item	Finish
40-0098	Filter Kit	Alloy
40-0952	Filter Kit	Chrome
40-0709	Filter only	Chrome
40-1270	Nipple	Raw
31-2131	1" Frame Clamps	



40-1257  
 Installed



**Front Mount Filter Unit** incorporates filter and regulator mount for 1975-99 Big Twins and 1986-99 FXST-FLST models. Includes filter, chrome billet base and hose fittings.

VT No.	Item
40-1257	Complete Kit
40-0711	Chrome Filter
40-0798	Kit with Filter
37-0966	Bolt Set



40-0798

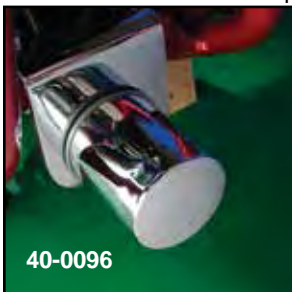

40-0096



40-0096

**Pura-Flow Chrome Oil Filter Kit** for 1936-99 Big Twins.

VT No.	Item
40-0096	Kit
40-0709	Replacement Filter



40-0748

**Transmission Mount Oil Filter** fits 4 speed models. Black bracket and chrome filter included.

**VT No. 40-0748**





# Spin On Filter



**Spin-On Oil Filters** replaces stock units. Perf-form or V-Twin brand. All filters listed are low restriction type.

Perf-form	Hex	VT No.	OEM	Finish	Length
<b>1982-84 FL-FX except FXST</b>					
40-0363	40-0857	40-0711	63782-80T	Chrome	2.5"
40-0379	—	40-0710	63810-80T	Black	2.5"
<b>1980-98 FLT, 1982-94 FXR, 1984-98 FXST</b>					
40-0378	40-0860	40-0708	63805-80T	Black	3.75"
—	40-0872	40-0709	63796-77T	Chrome	3.75"



**K&N Spin-on Oil Filters** feature hex nut end for easy removal and installation, improved pressure relief valve, anti-drain back valve and heavy duty base plate.

Chrome	Black	Fits	Length
40-1720	—	1982-84 FLH & FXE	2.5"
40-1710	40-1711	1982-94 FXR, 1984-98 FXST	3.75"



**Oil Filter Wrench** fits all spin-on filters 3/8" drive. Fits all models including TC-88.  
VT No. 16-0743

**Motor Shop™ Brand Filter Packs** include 6 pc of individually wrapped and numbered chrome filters with 3" outside diameter and length as listed.

Chrome	Black	OEM	Type	Length
40-0198	40-0836	63782-80T	1982-84 FL-FX	2.5"
40-0199	40-0838	63796-77T	1980-up 5 Speed	3.75"

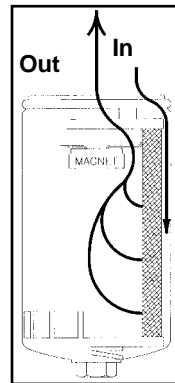

**Oil flows in around the outer diameter, through the filter media and out passing by the magnet. The magnet captures particles less than 10 microns which could have escaped through the filter wall.**



**Magnetek™ Oil Filters** feature a magnetic ring in center tower to trap particles less than 10 microns which could have escaped thru the filter wall.

Hex	VT No.	OEM	Fits	Length
40-0865	40-0851	63782-80	1982-84 FX	2.5"
40-0864	40-0852	63796-77	1980-up 5-Spd ST	3.75"



**2.5" Chrome OE Spin-on Oil Filters** feature a cured black resin impregnated paper that will remove foreign particles from oil. Replaces 63782-80, fits 1982-84 FLH.  
VT No. 40-0753

# Pre 1984 Oil Filter



**Drop In Filter Unit** includes spring, O-ring and one piece filter.

VT No.	Item
40-0172	Filter
14-0582	O-Ring
40-0251	Filter, 6 pack

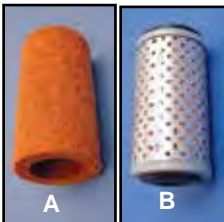

**Oil Filter Elements** replace 63839-53 for 1965-84 BT.

VT No.	#	Type	Fits
40-0700	A	Felt	12 pack
40-0701		Felt	Case of 25
40-0702		Felt	Case of 50
40-0705	B	As Above	Metal Perforated, Sold Each Includes Seals

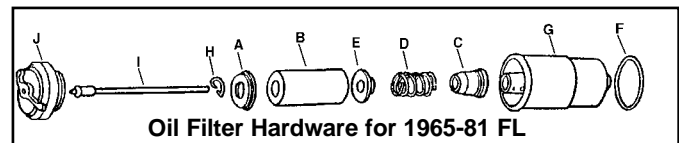

VT No	#	OEM	Item	U/M
40-0714	Kit	A-B-C-D-E-F-H	Complete Kit	Kit
40-9953			As Above with cup (G)	Kit
40-9954	G	63826-53	Cup	Each
40-0700	B	63839-53	Filter Element	12
40-0122	E	63846-67	Lower Retainer	Each
13-0207	D	63831-67	Spring	10
40-0125	A&C	63881-67	Upper Seal Kit	Kit
		63882-67	Lower Seal	
14-0526	F	63879-53	O-Ring	10
12-0940	H	63878-53	Clip	10
40-9955	I	63885-65	Dipstick	Each
40-0504	J	62610-52A	Chrome Cap Assembly	Each



**Perf-Form Filter Unit** is a complete drop-in replacement. 1965-81 FX-FL. Spring included.

VT No. 40-0380

# Outer Primary Cover



Floorboard Tab  
for 1970-84 FLH  
models



**Big Twin Outer Primary Covers** are from new die cast tooling to replace stock parts. Kits include chrome primary cover, chrome allen screws, outer cover starter bearing and gaskets for derby, inspection and outer cover. All other covers are sold as cover only. Part number for screw kit given for reference only.

#	VT No.	OEM	Finish	Fits/Type	Chrome Allen Screw Kit
<b>4 Speed Chain Drive</b>					
<b>A</b>	43-0201*	60508-70	Chrome	1970-84 FLH, with tab and chain final drive	8762-17
	43-0458	60508-70	Chrome	1970-84 FLH with tab	8762-17
	43-0231*	Kit	Chrome	As Above	
	43-0208	60508-70	Polished	1970-84 FLH, with tab	8762-17
	43-0354*	Kit	Polished	1970-84 FLH with tab	
<b>B</b>	43-0200*	60547-77	Chrome	1970-82 FXE, 8 hole with chain final drive	8762-17
	43-0256	60547-77	Chrome	1970-82 FXE, 9 hole with chain final drive	8762-17
	43-0230*	Kit	Chrome	As Above	
<b>C</b>	43-0169*	—	Chrome	1970-84 FX with milled slots for venting on belt drive models, 8 holes.	8762-17
<b>4 Speed Rear Belt Drive</b>					
<b>A</b>	43-0140	60525-82	Chrome	1982-85 FLH, 9 hole	8762-17
	43-0349	Kit	Chrome	1982-85 FLH, 9 hole with belt final drive	
	43-0243	60525-82	Chrome	1982-85 FLH, Note: Partially drilled 9th hole	8762-17
<b>B</b>	43-0348	60531-83B	Chrome	1983-85 FX, 9 hole	9959-38
	43-0217	Kit	Chrome	1982-85 FXB 9 hole with belt final drive	9959-38
	43-0242*	60498	Chrome	1980-82 FX, 8 hole	8762-17
<b>5 Speed FXR-FLT</b>					
<b>D</b>	43-0204	60605-79	Chrome	1982-84 FXR, 1980-84 FLT	8763-20
	43-0339	Kit	Chrome	1982-84 FXR, 1980-84 FLT	

\*Note: Partially drilled 9 hole



**Outer Primary Cover Kit** includes polished or chrome outer primary cover, chrome derby cover, chrome inspection cover, starter shaft extension, gaskets and screws. Fits 1965-69 FL.  
**VT No. Finish**  
**43-0045** Polished  
**43-0046** Chrome

**Steel Inner Primary Covers** to fit 1970-84 without electric start.

VT No.	Type
42-0617	Inner
42-0612	Outer





# Chrome Customizer

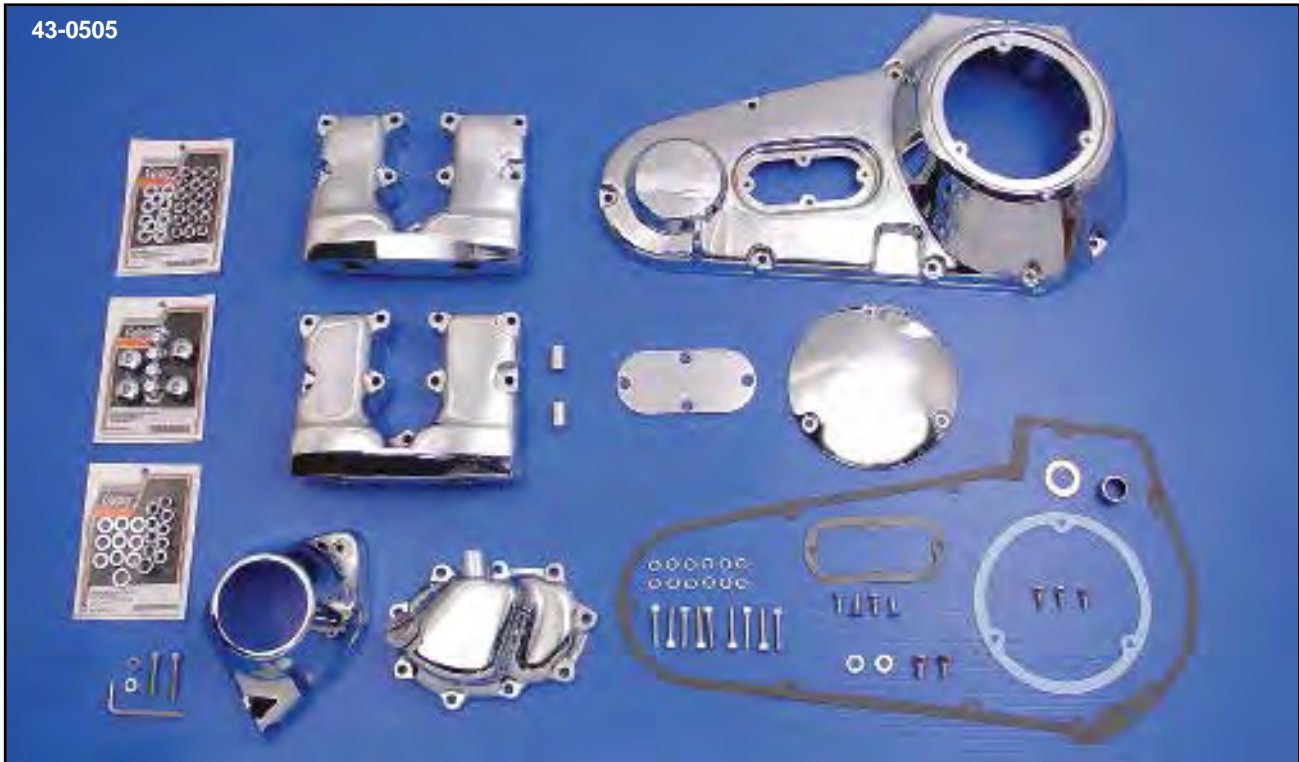

**V-Twin™ Chrome Customizer Kits** include chrome parts and hardware for installation as pictured. Kits require removal of engine to install rocker box covers. All kits for electric start models unless noted as kick and electric. Smooth derby and inspection covers are included on FXST kits. Inspection cover on FXR, FXE, FLT and FLH applications must be purchased separately. **\*Note:** Does not include gasket. 1980-84 kits do not include trans top cover.

**VT No. Year Model**  
**Shovelhead 4-Speed Chain Drive Models**

- 43-0505\*** 1970-84 FLH
- 43-0506\*** 1970-84 FLH, Kick and Electric
- 43-0507\*** 1970-84 FXE, Kick and Electric

**Shovelhead 4-Speed Belt Drive Models**

- 43-0510\*** 1982-85 FLH, Kick and Electric

**Shovelhead 5-Speed Belt Drive Models**

- 43-0508\*** 1979-82 FLT, Chain
- 1980-84 FLT, Belt
- 1981-84 FXR, Belt



**GB Primary Cover Gasket Kit** contains all the necessary gaskets and hardware when making inner primary repairs, primary chain, clutch hub, clutch or left side transmission repairs. One part number covers all necessary parts. Fits 1965-88 4-5 Speed FXST. **VT No. 15-0888**

**GB Primary Cover Gasket Kit** contains all the necessary gaskets and hardware when making inner primary repairs, primary chain, clutch hub, clutch or left side transmission repairs. One part number covers all necessary parts.

VT No.	Fits	Speed
<b>15-0621</b>	1965-E82 FL-FX	4
<b>15-0670</b>	L1982-84 FL-FX	4
<b>15-0623</b>	1980-84 FLT-FXR	5



**James Primary Kits**

include beaded outer gasket.

VT No.	Year	Model
<b>15-0865</b>	1965-84	FX-FL No Seals
<b>15-0866</b>	1965-84	FX-FL
<b>15-1335</b>	As Above	with Foamet®
<b>15-0869</b>	1980-84	FXR-FLT

# Inner Primary Cover 1965-84

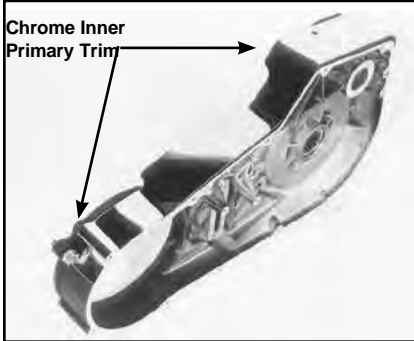
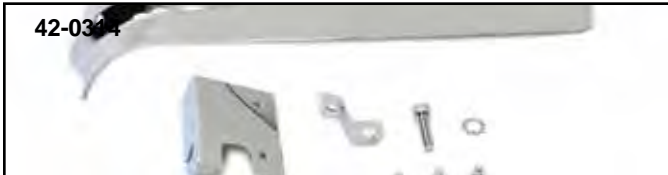

**Chrome Inner Primary Trim** easily adapts to stock cast inner primary without complicated disassembly. Fits 1970-84 FX-FL.  
**VT No. 42-0314**



**Inner Primary Assembled with all components pictured!**

**1970-85 FX and 1970-84 FL Complete Inner Primary Housing Assembly** for 4 Speed models includes die cast inner cover in chrome or polished finish, bearing, seal, chain tensioner, detent plate, vent tube, chain oiler tube, and drain plug. **Assembled.** Note: Use starter 43-9122 housing for Hitachi and 43-9123 for Prestolite applications.

Polish	Chrome	Year/Model
43-0352	43-0350	1970-85 FX
43-0353	43-0351	1970-84 FLH

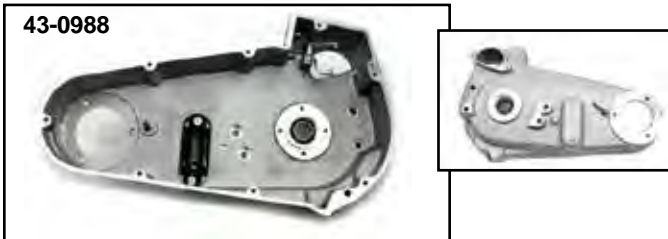

**Inner Primary** is cast construction with natural finish as stock replaces 60617-65A. Order mounting hardware & bearing separately. Fits 1965-69 Big Twin.

VT No.	Item
43-0988	Replica Inner
17-0510	Inner Bearing



**With Shift Shaft Hole**



**43-0137**



**43-0146**



**43-0195**



**Without Shift Shaft Hole  
 43-0147 FL Type**

**FX-FLH 4 Speed Cast Inner Primary Cover** available in chrome, cast or polished.

VT No.	OEM	Finish	Fits
43-0202	60441-82A	Chrome	1970-84 FX-FXE
43-0137	60441-82A	Polished	1970-84 FX-FXE
43-0146	60619-70	Polished	1970-84 FL-FLH
43-0195	W/sealed bearing	Polished	1970-84 FL-FLH
43-0147	60619-70	Chrome	1970-84 FL-FLH

Die Cast Primary Covers are manufactured from a casting process. It is the nature of parts produced from this process to have small random subsurface imperfections that can be uncovered during the polishing process. These may appear as very small cosmetic imperfections after chrome plating. We also do not polish in areas that are not readily visible once assembled on the motorcycle or by polishing machines such as small depressions or tight corners. As these conditions are common in polished and chrome-plated castings, a reasonable standard of acceptability has been established to bring you the highest quality product at an affordable price. This part meets Perma Chrome™ cosmetic standard. The aforementioned cosmetic conditions are considered reasonable for this part and are not considered warrantable.





# Inner Primary Bearing

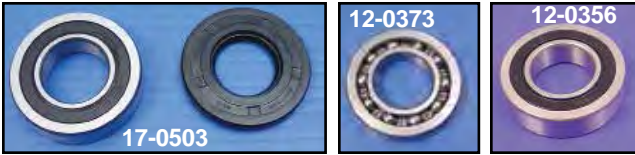
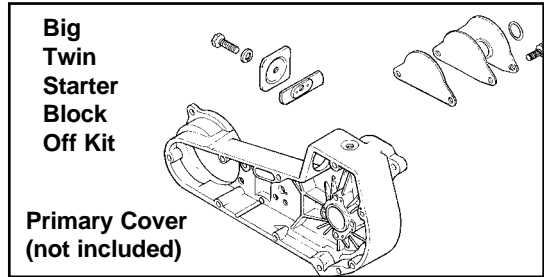
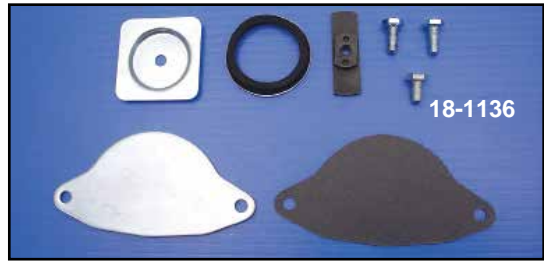

Inner Bearing and Seal Kit for Big Twin models.

VT No.	OEM	Fits
17-0510	9037	1965-69 4-Speed
17-0511*	9040	1970-84 4-Speed
17-0503*	DbI Seal	1970-84 4-Speed
12-0373	9040	1970-78 4-Speed without seal, thin
12-0356	9061	Late 1979-Early 84 4-Speed
14-0104	12018	1970-84 Seal, 5 pack

\*Note: Includes bearing seal

**Bearings Only, Number of Shields Noted.**

12-0373	9040	1970-78 thin, no shield
12-0313	9061	1970-84 Sealed, 2 shields
12-0340	8975	1980-84 5-Speed FXR-FLT

**V-Twin Inner Primary O-Ring** fits 1970-82. Replaces 11125. VT No. 14-0511



**Outer Primary Cover Needle Bearing** presses in outer primary cover to secure end of starter shaft. Fits 1965-88. Replaces OEM# 9063.

VT No.	Brand
12-0318	12-0395 VT
	12-0318 Torrington

**1970-85 GB Inner Primary Repair Gasket Kit** includes gasket to replace O-Ring seal when the lip of the motor is partially or entirely broken off. To avoid machining & welding, grind the partially broken lip smooth and install the gasket. Special lock and bolts included.

VT No. 15-0223

**Inner Primary O-Ring Saver Kit** for 1970-84 Big Twins. Replaces stock type O-ring with a gasket. Used for repairing damaged crankcase O-ring sealing lip. Available with a silicone beaded metal gasket or a foam rubber coated gasket. Includes lock tab.

VT No.	Item	Brand
15-1280	Metal Beaded	James
15-1299	Metal Beaded	GB
15-1281	Metal Foam Rubber	James

**Big Twin Starter Block Off Kit** for use on all 1965-84 4-Speed Big Twin models. VT No. 18-1136

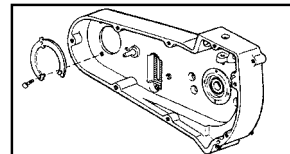

**Aluminum Inner Primary Mounting Kits** contain all stock type hardware for mounting aluminum inner chain housing on all Big Twin.

VT No.	Years
8798-12	1965-69 Colony Lock Ring with Bolts
17-0942	As Above Lock Ring Only
37-8666	1970-79 Kit with Studs and Bolts
9868-26	As Above, Colony
37-8667	1980-85
9869-24	As Above, Colony
37-8803	1971-up Bolt with Wire Hole
12-2113	1980-84 Stud Trans Ear
17-9222	1980-83 FLT-FXR, Lock Tab



**Primary Case Saver** protects inner case and starter housing area which is damaged by drive chain. Reinforced nylon.

VT No. 19-0415



**1970-up Big Twin Inner Primary Lock Tab.** One piece design eliminates need for safety wire, 5 pack. VT No. 17-0937

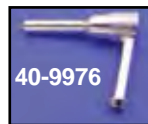

**Chain Oiler Fitting** replaces 60549-70 on FL-FX 1970-84, attaches to inner primary cover, each.

VT No. Item

40-0524 Oiler

40-9976 Side hole for extra oil

**Primary Baffle Plate** replaces 60556-74 on all 1970-84 FX-FL. Helps keep oil out of clutch pack. VT No. 12-1519

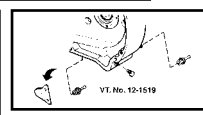
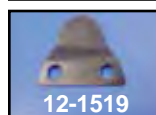

Chrome Derbys are 3 bolt type for 1970-98 Big Twins.  
Order gaskets separately.

# Derby Cover



CLASSIC



<b>VT No.</b>	<b>Type</b>	<b>42-0747</b>	Flame	<b>42-1118</b>	Contour, black	<b>42-1150</b>	Grooved, black
<b>42-0605</b>	Chrome Dome (Kit)	<b>42-0958</b>	Maltese	<b>42-1090</b>	Perforated, chrome	<b>42-1061</b>	Mesh Skull, black
<b>42-1029</b>	Chrome Dome	<b>42-6070</b>	Iron Cross	<b>42-1142</b>	Grooved, chrome	<b>42-1258</b>	Bad Skull, black
<b>42-0102</b>	Finned 80" Polished	<b>42-0107</b>	Eagle Spirit	<b>42-1150</b>	Grooved, black	<b>42-1257</b>	Bad Skull, chrome
<b>42-0036</b>	Chrome Button Allen	<b>42-9944</b>	Eagle Spirit	<b>42-7101</b>	Domed skull	<b>42-7102</b>	Smooth, ring
<b>42-0616</b>	Chrome Ventilated	<b>42-0632</b>	Black Finned	<b>42-7100</b>	Domed skull	<b>42-0108</b>	3-D spinner
<b>42-9965</b>	Early Style Bird	<b>42-1073</b>	Lady	<b>42-0195</b>	Smooth, chrome	<b>42-1086</b>	Ball Milled
<b>42-0578</b>	Bonehead	<b>42-1075</b>	Flame	<b>42-0194</b>	Smooth, black	<b>42-0195</b>	Smooth, black
<b>42-0579</b>	Cross	<b>42-1265</b>	Skull, black	<b>42-0131</b>	Raised, skull	<b>42-0194</b>	Smooth, chrome
<b>42-0091</b>	Skull	<b>42-0470</b>	Flame	<b>42-0580</b>	Big skull		
<b>42-0558</b>	Skull, black	<b>42-0471</b>	Flame, black	<b>42-1380</b>	Air Flow, black		
<b>42-0991</b>	Red Baron	<b>42-1087</b>	Contour, chrome	<b>42-1379</b>	Air Flow, chrome		

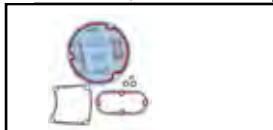

**Primary Derby Gasket Kit** used to replace gaskets and seals after clutch and primary chain adjustment on Big Twins, FLT, FXD or ST models. Fits 1970-98, 3-Hole.  
**VT No. 15-1506**

## Screws



**Chrome Screw Kits** for Big Twin primary covers.

Acorn	Allen	Year	Speed
<b>7350-15</b>	<b>8762-17</b>	1970-84 FX-FL4	
		1984-85 FXST 5	
<b>8481-20</b>	<b>8763-20</b>	1980-84 All	5



**Stock Primary Cover Screws** are plated original type fasteners to mount outer aluminum primary and inspection covers on Big Twin 4-Spd.

Chrome	Cadmium	Fits
<b>8799-12</b>	<b>8800-12</b>	1965-69
<b>9307-17</b>	<b>9308-17</b>	1970-80





# Derby Kit



**Chrome Flame Derby and Inspection Oval Set.** Screws included. Fits 1965-98 FL and Softail.  
VT No. 42-0817

42-0817 Installed

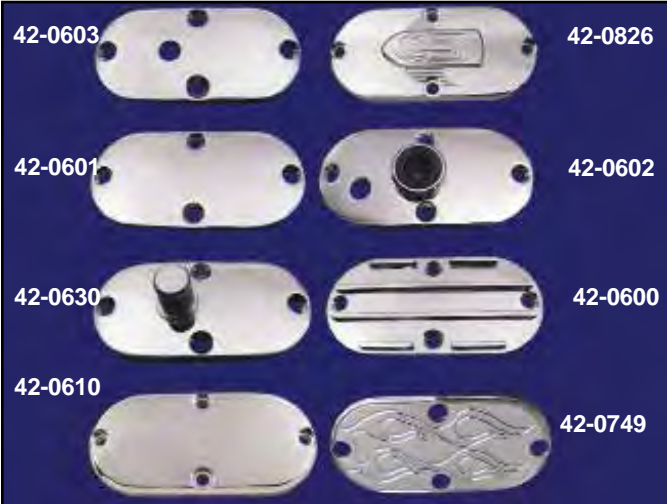

42-0603 42-0826  
42-0601 42-0602  
42-0630 42-0600  
42-0610 42-0749

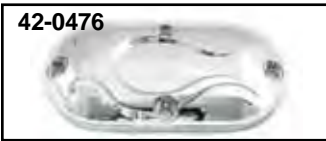

42-0476

42-0477



42-0188

42-0187

**Chrome Inspection Ovals** for 1965-up Big Twin alloy primary covers. \*Note: Unless noted.

VT No.	OEM	Type
42-0603	60513-71	1971-73 FX with hole
42-0601	60572-78	1965-84 FLH
42-0630	60574-65	FX-FL with Peg Stud
42-0602	60579-74	1974-82 FX with bushing
42-0324		Bushing Cover
42-0600	Die cast	Finned
42-1105	Skull	1965-84 FLH
42-0610	Billet	
42-0826	Flywheel	
42-0749	Flame	
42-1008	Bonehead	
42-1267	Skull	
42-0476	Flame	
42-0477*	Black Flame	
42-1136	Flame	
42-0188	Chrome	
42-0187	Black	
42-0478	Chrome with gold wings	



42-0324



42-0747

**Flame Covers.**

VT No.	Item
42-0747	Derby, 3-Hole
42-0748	Points Cover



42-1226



42-1225

**Chrome Ventilated Oval and Derby Kit** for 1970-98 primary covers.

VT No. Style  
42-1226 V-Twin Vented  
42-1225 Billet Vented



42-0035



42-0040



42-0036



42-0002

**V-Tech Covers** feature allen screw styling in deluxe chrome die cast metal.

VT No. Item  
42-0036 Derby  
42-0035 Points  
42-0002 Oval  
42-0040 Oval with shift, FXE hole

**Chrome Shifter Lever Cover** replaces 60400-74. Use on all 1974-up all FX models except FXWG and FXR.



VT No. Item  
42-0324 Cover  
10-0743 Bushing  
10-0749 Bushing .015



42-0604

42-0629



42-0049

**Chrome 5-Speed Inspection Covers** are available with or without shifter hole.

Without Shift Hole	Years	Model
42-0604	32519-80	1982-84 FXR-FLT
With Shift Hole		
42-0629	60642-82	1982-Early 84 FXR
42-0049	—	1985-94 FLT



15-1506

**Primary Derby Gasket Kit** used to replace gaskets and seals after clutch and primary chain adjustment on Big Twins.

VT No.	Derby	Year	Holes
15-1507	15-0562	1999-up	5-Hole
15-1506	15-0563	1970-98	3-Hole

# Outer Primary Cover 1936-64

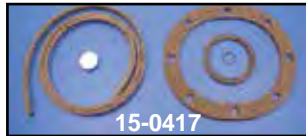

**V-Twin™ Replica Outer Primary Cover** for 1955-64 Big Twins, order plug separately.

VT No.	Finish	Item
42-0880	Black	Cover
42-0881	Chrome	Cover
42-0385	Chrome	Cover Kit
37-8349	Plugs	
14-0542	O-Ring	
15-0417	Primary Gasket and Plug Kit	



**1936-64 Big Twin Inner Primary Cover Screw Kits** include screws for outer cover, derby and inspection cover.

VT No.	Finish	Type
7414-20	Chrome	Acorn
8756-30	Chrome	Allen
8155-30	Chrome Screw	Stock
8156-30	Cadmium Screw	Stock
9724-30	Parkerized Screw	Stock



**Chrome Steel Outer Primary Cover** for Big Twins. Early type is shallow in sprocket area. Compensator type is deeper for sprocket clearance.

VT No.	Type	Years	Finish
42-0613	Comp	1936-64	Chrome, Smooth
42-0611	Early	1936-54	Chrome
42-0595	Early	1936-54	Black
42-0612	Comp	1955-64	Chrome
42-0594	Comp	1955-64	Black
42-0391	SS	1936-64	Kit



**V-Twin™ Replica Outer Primary Covers** for 1936-54 Big Twins are produced with new tooling for accurate fit and shape.

VT No.	Finish	Year
42-3754	Black	1941-54
42-4154	Chrome	1941-54
42-0372	Black	1941-54 Kit
42-3640	Black	1936-40

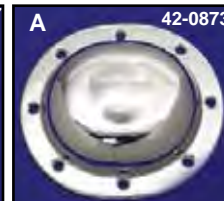

**Derby Covers** for tin outer primary.

VT No.	#	Type/Finish
42-0627	A	Dimple/Chrome
42-0642	A	Dimple/Black
42-0870	A	Dimple/Replica Black
42-0873	A	Dimple/Chrome
42-0875	A	Dimple/Replica SS
42-0614	B	Chrome
42-0628	C	Bird/Chrome
42-1577		World's Fair

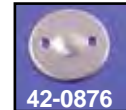
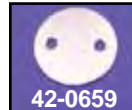

**Chrome Inspection Covers** for Big Twin.

VT No.	Type	VT No.	Type
42-0871	Black, Replica	42-0659	Flat
42-0874	Chrome, Replica	42-0626	Dimpled
42-0876	Stainless, Replica	42-0641	Black





# Inner Primary Cover 1936-64



Oil Guard Detail



**Replica Inner Primary Covers** with drain fitting installed. 42-0699 includes sprocket oil guard. Oil guard may have to be removed on some foot shift applications.

Black	Chrome	OEM	Year
42-3654	—	60626-36	1936-54
42-0644	42-0643	60626-36	1936-54
42-0646	42-0645	60620-55	1955-57
—	42-0862	60620-58B	1958-64
Raw			
42-1212		60626-36	1936-54
42-1213		60620-55	1955-57
42-1214		60620-58	1958-64



42-1872

**Steel Inner Primary Covers** for 1936-54 has small hole at motor end, 1955-69 has large hole for splined sprocket shaft. The 42-0623 is slightly deeper to mount to 1965-69 engine cases.

Chrome	Black	Years	Item
42-0621	42-0619	1936-54	
42-1139	42-1138	1955-57	
42-0622	42-0620	1958-64	
42-0623		1965-69	Chrome
42-0617*		1970-84	Alternator type
	42-3654	1936-52	Black
Bracket			
49-1152		1936-57	Lower and Upper
49-1153		1958-64	Upper
42-1521		1939-57	Rebuild Kit
42-1872			Tab Kit

\*Note: Allows use of 1955-64 type compensator outer covers on alternator, electric start must be sacrificed.



**Inner Primary Mounting Kits** contain all hardware to mount tin inner primary to engine on Big Twins.

VT No.	Years
7811-14	1936-54
7812-12	1955-64



**Inner Primary Mount Kit** includes hardware to mount inner to oil tank and frame.

VT No.	Finish
9601-10	Parkerized
2071-10	Chrome

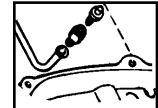

**Inner Primary Cover Drain Tube** for sheet metal early Big Twin primary. Tube with nut.

VT No.	OEM	Year/Type
40-9983	60546-36	1937-58 Rigid
40-9984	60546-59	1959-64 SAF
40-0835		Fitting

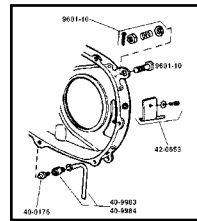

**1954-64 Rear Chain Oiler Kit** replaces 63591-62 to fit on rear of inner primary cover includes screw.

VT No.	Item
42-0653	Rear Chain Oiler
40-9983	Oil Drain 1936-57
40-9984	Oil Drain 1958-64
42-0589	Oil Guard

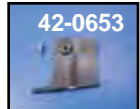

**Chain Oil Kit.** Cad plated oiler body, 63607-54, oiler adjusting screw, 63610-53, nut and brass washer used on 1954-62 Panheads.

VT No. 2321-4

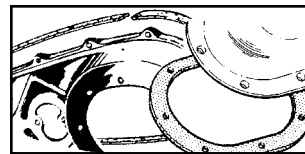

**Primary Gasket Kit** includes 3 cork gaskets for 1936-64 Big Twin outer primary covers, includes 60540-36, 60567-36 and 60565-36.

**Cork Primary Cover Gaskets** for 1936-64 Big Twin.

James	GB	OEM	Item
15-0905	15-0175	60540-36	Primary
15-0919	15-0177	60565-36	Clutch Cover
15-0920	15-0178	60567-36	Inspection
15-0180	15-0408	60629-55	Inner Primary, 1955-64
15-0844	15-0642	—	Kit Complete, 1936-54
—	15-0417	—	Kit Complete, 1936-64

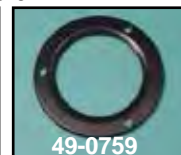

**Reinforcement Ring** fits inner primary.

VT No.	Year
42-0618	1936-54
49-0759	1955-64



# Spoke Set Chart



**Flat Flanged Hubs.** Front and rear hubs (45-0317, 45-0670, 45-0330, 45-0306 with horizontal flanges) including 1936-84 FL-FLH front and rear, 1973-84 FX-FXE rear, 1954-99 XL Rear, 1984-95 FLST-FXST-FXDWG front or rear, 1996-up FLST-FXST alloy rear, 1986-up FLT rear, 2000-up XL alloy rear and 1996-up Dynaglide alloy rear. **All Spokes Listed Are 6-8 Gauge with short shank.**

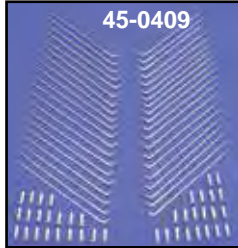

SPOKE SETS FOR FLAT FLANGE HUBS									
Chrome V-Twin	Chrome Buchanan	Chrome Twirled V-Twin	Chrome Twirled Buchanan	Stainless Twirled V-Twin	Stainless Twirled Buchanan	Chrome Diamond V-Twin	Chrome Diamond Buchanan	Size	Rim Note Type*
45-0620								15"	DC
45-0621	45-0720	45-0703	45-0675	45-0709			45-0682	16"	DC 3
45-0762		45-0765						17"	DC 4
45-0601	45-0721							18"	C
45-0610								18"	DC
45-0602			45-0727		45-0729			19"	C
45-0767	45-0728		45-0730					19"	DC 1
45-0603	45-0723	45-0706	45-0677	45-0726	45-0700	45-0716	45-0684	21"	DC/C

SPOKE SETS FOR FLAT FLANGED HUBS						
Chrome Rippled Buchanan	Stainless V-Twin	Stainless Buchanan	Cadmium Plated V-Twin	Rim Size	Rim Type*	Note
45-0731	45-0409	45-0651	45-0710	16"	DC	3
	45-0748	45-0652	45-0798	18"	C	
		45-0656		18"	DC	
		45-0653		19"	C	
	45-0764	45-0654		19"	DC	1
	45-0768	45-0674		19"	DC	2
	45-0713	45-0655		21"	DC/C	

**Notes:**

1. Fits Disc Type Spool Hub Only
  2. Fits Drum Type Spool Hub Only (Cross 3)
  3. VT No.45-0409 is Hand Polished
  4. Use with rim 52-0435
  5. Fits 1995-up FXD-XL Applications.
- \*Note: Rim Type Drop Center = DC or Conventional = C

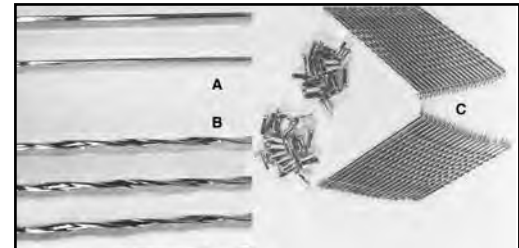

**Twirled-Diamond-Stock**

are noted as the following:

- B Twirled Buchanan
- B Twirled v-Twin
- A Diamond Buchanan
- C Ripple Style

**All Spokes Listed Are 6-8 Gauge**

**1973-up Alloy Hub Spoke Sets** with single or dual disc with vertical flanges to house spokes. Sets include 20 long and 20 short shank spokes. Shank is 8 gauge portion which fits in hub flange with 40 nipples.

SPOKE SETS FOR ALLOY FRONT DISC SPOOLS											
Perma Chrome	Cadmium V-Twin	Chrome V-Twin	Chrome Twirled V-Twin	Chrome Twirled Buchanan	Stainless Twirled Buchanan	Chrome Diamond Buchanan	Chrome Rippled Buchanan	Stainless V-Twin	Stainless Buchanan	Size	Rim Type
		45-0606							45-0661	19"	C
45-0631	45-0155	45-0623	45-0705	45-0676	45-0699	45-0683		45-0714	45-0660	19"	DC
		45-0751	45-0686	45-0701	45-0687		45-0755	45-0612	45-0662	21"	DC/C
	45-0611							45-0612		21"	DC/C/ Note: 5

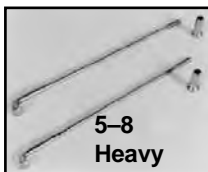

16" Heavy 5-8 Gauge Spoke Set in stainless finish.  
VT No. 45-0738



6/8 Gauge Nipple 40 Piece Set.  
VT No. Type  
45-0626 Standard, Chrome  
45-0160 Standard, Cadmium  
45-0680 Standard, Stainless  
45-0749 Standard, Chrome  
45-0750 Extended, Stainless  
45-0521 Extended, Chrome  
45-0781 Extended, Chrome  
45-0782 Extended, Stainless





# 1936-66 Replica Wheels



52-0100



52-0800



52-0876



52-1252

1936-66 Big Twin Star Hub Type Wheel includes chrome hub, chrome rim and choice of chrome or stainless spokes. Fits front or rear and hub and is assembled like stock with loose type roller bearings. All wheels include rubber rim strip installed.

Chrome	Stainless	Diameter	Width
52-0100	52-0800	16" F & R	3.00"
52-0876	52-0877	18" F & R	2.15"
52-0831	52-0832	16" Rear	4.00"
52-0115	—	18" Rear	4.25"
52-0102	—	19" Front	1.85"
—	52-0801	19" Front	2.15" (Drop Center)
52-0103	52-0802	21" Front	2.15"
52-0487	—	21"	3.25"
52-0796	—	16"	3.00", Timken
52-0797	—	21"	3.00", Timken

Replica Wheel Assemblies include the black "step" style hub.

VT No.	Rim	Spoke	Size
52-1253	Black	SS	16"
52-2047	Chrome	Cad	16"
52-2050	Black	SS	16"
52-1271	Black	Cad	18"
52-1252	Black	SS	18"

All Wheels include V-Twin's Replica Star Hub which will accept original type axles and sleeves.



52-2046



52-0847



52-0866



52-0880



52-0796



52-0878



52-0881 18"



52-0644



52-0886



52-0887



52-0889



52-1017

1936-66 Big Twin Star Hub Type Wheel includes black hub with choice of chrome replica rim and chrome spokes or black replica rim and stainless steel spokes. All wheels include rubber rim strip installed. \*Note: With stainless steel spokes.

Chrome Rim	Chrome	Black Rim	Diameter	Spoke	Width
Stainless Spokes	Spokes & Rim	Stainless Spokes			
52-2046	—	—	16"	Zinc Spokes	3.00"
—	52-0847	52-0866	16"		3.00"
52-0880*	—	—	16"		3.00"
52-0796	—	—	16"		3.00"
—	52-0878	52-0881	18"		2.15"
—	—	52-0644	18"	Cadmium	2.15"
52-0886*	—	—	18"		2.15"
—	52-0887	52-0889	19"		2.15"
—	52-1017	—	23"	Front	3.00"

# Front Wheel Assembly 35 & 41 mm Fork



Chrome Spokes Chr. Hub	Stainless Spokes Chr. Hub	Rim Diameter	Rim Width	
<b>1973 Only XL w/single disc. Fits 35mm forks.</b>				
52-0158	—	19" Drop Center	2.50"	
52-0174	—	21"	1.85"	
<b>1974-77 XL Clover Type with single disc. Fits 35mm forks.</b>				
52-0165	52-0817	19" Drop Center	2.50"	
52-0161	—	21"	1.85"	
<b>1974-77 XL Clover Type with single disc satin hub. Fits 35mm forks.</b>				
52-0187	52-0188	19" Drop Center	2.50"	
52-0189	—	21"	1.85"	
<b>1978-83 XL with dual disc. Fits 35mm forks.</b>				
52-0155	52-0818	19" Drop Center	2.50"	
52-0151	52-0819	21"	2.15"	
<b>1980-83 FXWG with dual disc. 5/16" rotor mount holes. Fits 41mm forks.</b>				
52-0131	52-0132	16"	3.00"	
52-0821	52-0822	19"	1.85"	
52-0128	52-0820	19" Drop Center	2.50"	
52-0127	52-0181	21"	2.15"	
52-0490	—	21"	3.25"	
<b>1973-84 FL with 3/8" disc mount holes</b>				
52-0129	52-0179	16"	3.00"	
52-0863*	52-0864**	16" Deluxe	3.00"	
52-0814	52-0812	19"	2.50"	
52-0815	52-0813	21"	1.85"	
52-1026	—	23"	3.00"	

\*Note: Deluxe rims are OE style



Since 1969

## Wheel Rim



**Drop Center Chrome Rims** features drop center design for bead and 40 spoke holes. All are chrome unless noted. **Note:** Large hole accepts rubber valve stem tube. Small hole accept metal stem tubes.



VT No.	Width	Brand
52-0226	3.0"	Perma Chrome
52-0699	3.0"	As Above Raw
52-0692	3.0"	Black Powder
52-0433	3.0"	Black Police
52-0223	4.0"	V-Twin
52-0432	—	Chrome
52-0303	4.0"	Replica
52-0381	4.0"	VT

18" Rim with Small Center Hole	17" Rim with Small Center Hole
52-0707 2.5" V-Twin	52-0435 4.5"
52-0229 4.25" Perma/Chrome	52-0896 6.0"
52-0229 4.5"	52-0229 4.5"



16" Rim w/Small Side Valve Stem Hole
52-0230 3.0" Center Valve
52-0222 3.0" Perma Chrome
52-0691 3.5" Perma Chrome
52-0228 4.5" Perma Chrome
52-0233 3.0" Black, Center Valve

16" x 3.00" Police Rims.	Chrome	Black
52-0379	52-0376	
19"		
52-0700	2.50"	Perma Chrome 43018-73
52-0977	2.50"	V-Twin, 43002-70
52-1208	2.15"	Black
52-1209	2.15"	Black

## 1967-72 Wheels



**1967-72 Big Twin Wheel Assembly** fits front or rear includes lock, screw, seal spacer, tube spacer and a bearing.

Chrome Spokes	Stainless Spokes	Width	Diameter
52-0146*	52-0745*	3.00"	16" Front or Rear
—	52-1039**	3.00"	16" Front/Rear
52-0106	52-0803	3.00"	16" Front or Rear
—	52-0804	4.00"	16" Rear
—	52-0124	2.50"	19" Front
52-0123	52-0806	2.15"	21" Front

\*Note: Assembled with black finish hub.

\*\*Note: Black Rim and Hub



**Internal Bearing & Hardware Kit** for 1967-72 front and rear hubs. All parts necessary to build or rebuild a bare hub. Includes 3 bearings, tube spacer, seal, seal sleeve & hub lock (Left Hand Thread). Complete. **VT No. 44-0410**





# Big Twin Rear Wheel



**Complete Wheel Assembly** features the following:

- Chrome Rim
- Chrome or Stainless Spokes
- Chrome Hub with Internals
- 40 Spoke Style.



**18 x 4.25" Rear Wheel** includes chrome steel hub and spokes. Accepts 150 thru 180 series tires. Fits 1973-84 FX-FL.  
**VT No. 52-0776**

## Wheels with Twirled Spokes



**Twirled Spoke Detail**

Chrome Spokes	Stainless Spokes	Rim Diameter	Rim Width
1973-82 FX-FXE Rear, 1973-84 FL-FLH Front or rear, 3/8" disc Mount Holes with Internals.			
52-0129	52-0179	16"	3.00"
52-0863*	52-0864*	16" Deluxe	3.00"
52-0126	52-1094	16"	3.50"
52-0937	52-0938	16"	4.00"
52-2043	—	16"	4.50"
52-2034	—	17"	4.50"
52-0776	—	18"	4.50"
1982-84 FXE, 1982-86 FXWG, 1982-85 FXR, 1984-85 FXST			
52-0168	52-0809	16"	3.00"

\*Note: Deluxe rims are OE style



**Chrome Wheel Assembly** features chrome 3.00" x 16" profile "Smoothie" rim for 1973-84 front or rear FLH.  
**VT No. 52-0546**



**Chrome 16" x 3.0" Wheel Assembly** fits 1973-84 Big Twin FX-FL. Laced and trued with bearings installed and includes drilled steel rotor and chrome 51 tooth sprocket. Chrome bolts are supplied for each side.  
**VT No. Disc**  
**52-0428** 10"  
**52-0429** 11 1/2"



**Replica Racing Hubs**

VT No.	Disc	Finish	Axle
45-0108	Spool	Chrome	5/8"
45-0102	Spool	Nickel	3/8"
45-0106	Spool	Alloy	9/16"
45-0105	Spool	Alloy	3/4"
45-0109	Spool	Nickel	3/8"
45-0107	Rear	Alloy	9/16"



**Wheels with Twirled Spokes** include chrome hubs with internals, rim and twirled chrome spokes assembled.

VT No.	Fits	Type	Width
<b>FRONT</b>			
52-0844	1980-83 FXWG	21" Dual	2.15"
52-0860	1974-77 XL-FX	19" Single	2.50"
52-0846	1977-83 XL-FX	19" Dual/Single	2.50"
52-0944	1977-83 XL-FX	21" Dual/Single	2.15"
<b>REAR</b>			
52-0841	1973-82 FXE-FLH	16" Rear & Front	3.00"
	1973-82 FLH		
52-0850	1973-82 FXE-FLH	16"	4.00"
52-0177	1982-85 XL	16"	3.00"
	1982-84 FXE		
	1982-86 FXWG		
	1984-85 FXR		
52-0865	1954-78 XL	16"	3.00"
52-0883	1979-81 XL	16"	3.00"

# Wheel Rim

See page 471 for Complete Rim Listings.

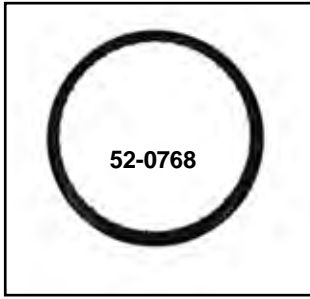

Replica™ Early Steel Wheel Rims feature OEM style bead construction. **Note:** Spoke nipple holes may require enlarging before assembly with aftermarket spoke sets.

VT No.	OEM	Fits	Finish	Size	Model
52-0947	43004-35	Front & Rear	Black	18"	Big Twin
52-1019	43004-35	Front & Rear	Black	18"	Big Twin
52-0768	Powder	Front & Rear	Black	18"	Big Twin
52-0785	Powder	Front & Rear	Black	18"	Big Twin
52-1018	43005-35	Front & Rear	Chrome	18"	Big Twin
52-0961	3940-30	Front & Rear	Black	19"	VL
52-1016	Powder	Front & Rear	Black	19"	VL
52-0962	—	Front & Rear	Chrome	19"	VL
52-0946	43003-30	Front	Chrome	18"	45"
52-0963*	—	Front & Rear	Black	18"	
52-0964*	—	Front & Rear	Chrome	18"	
52-0025	—	Front & Rear	Alloy	18"	
52-0999	—	Front & Rear	Black	19"	
52-1034	—	Front	Black	19"	
52-0946	43003-30	Front	Chrome	18"	K
52-0969	—	Front	Chrome	19"	1952-63
52-0965	43002-64	Front	Chrome	19"	1964-72
52-0967	—	Front	Black	16"	45 Solo
52-0966	—	Front	Chrome	16"	45 Solo
52-0762	—	Front	Black	18"	Indian
52-0433	Replica	Front & Rear	Chrome	16"	Police
52-0434	Replica	Front & Rear	Black	16"	Police

\*Note: Features reverse roll and deep dish spoke area to fit models with integral 1/2 brake drum.

Note: 45 Solo Replica Front Rims VT No. 52-0966, 52-0967, and 52-0996 require OE style rim spokes.



Conventional Rims are flat style. Fits front tires only and has 40 holes for custom applications.

Chrome	Black	Size	Width
52-0208	52-0234	18"	2.15"
52-0202	—	19"	1.85"
52-0203	—	21"	1.85"

# Spoke

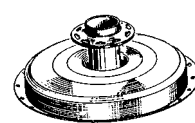
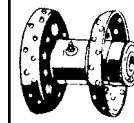

(A) 1936-up Big Twin, Side Valve, OHV  
 (B) 45" Solo Front Hub 1938- K and XL 1/2  
 (C) 1952-63 52. Sets include Drum Front Valve, 20 short and 20 long spokes.  
 Order spokes by hub style as shown.

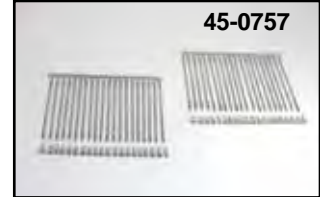
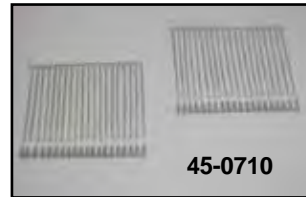

1936-up Big Twin, Side Valve, Overhead Valve (A)

VT No.	Finish	Size	Rim
45-0710	Cadmium	16"	Drop Center
45-0757	Zinc	16"	Drop Center
45-0651	Stainless Steel	16"	Drop Center
45-0409	Stainless Steel	16"	Drop Center
45-0720	Chrome	16"	Drop Center
45-0621	Chrome, V-Twin	16"	Drop Center
45-0743	Parkerized	18"	
45-0744	Cadmium	18"	
45-0652	Stainless Steel	18"	
45-0748	Stainless Steel, V-Twin	18"	
45-0721	Chrome	18"	
45-0601	Chrome, V-Twin	18"	
45-0653	Stainless Steel	19"	
45-0602	Chrome V-Twin	19"	Conventional
45-0160	Cadmium		Nipple Set

1938-53 45" Solo Front (B)

VT No.	Finish	Size	Rim
45-0664 <sup>1</sup>	Stainless	18"	Conventional
45-0783	Stainless	18"	OE
45-0697	Stainless	18"	OE Style
45-0663 <sup>1</sup>	Stainless	16"	Drop Center
45-0752	Stainless	16"	Drop Center, OE Style
45-0877	Stainless Steel, Replica	16"	Drop Center, OE Style

1952-63 XL-K Front (C)

VT No.	Finish	Size	Rim
45-0708	Stainless	18"	Conventional
45-0707	Stainless	19"	Conventional

Note 1: Cross One Pattern on Brake Drum Side



1930-36 VL  
 Front and Rear

Stainless Spokes for 1930-36 VL Front and Rear. Drop center.

VT No.	Size	Rim
45-0735	18"	OE Style
45-0736	19"	OE Style



Chrome Spoke and Rim Set includes chrome rim with 40 chrome 6-8 gauge spoke and nipple set. Fits 1936-up Big Twin, 16" x 3.0".

VT No. 52-0300





# Front And Rear Wheel Hub



All Hubs include bearings, races, seals, seal spacers and are assembled and chromed except where noted.

## Rear Hubs

VT No.	OEM	Fits
45-0317	43540-73A	1973-E82 FX-FL-FXE 3/8" and 7/16" Holes
45-0303		1973-82 without bearing set
45-0670	40952-82A	1982-85 FXE-FXWG-FXR, 84-85 FXST

## Front Hubs

VT No.	OEM	Fits
45-0317	43540-73	1973-84 FLH-80 3/8" Disc Mount Hole
45-0297	43600-73	1973 only FX
45-0307	43600-74	1974-77 FX, Single Disc
45-0310	43600-78	1978-83 FX-FXE- FXEF- FXEF-80-FXE-80 1982-83 FXR-FXRS Dual Disc
45-0311*	—	As above, Satin
45-0294	43663-80A	1980-83 FXWG Dual Disc 5/16" Disc Bolt Holes

\*Note: Internals not included, order separately

## Hub Rebuild

VT No.	OEM	Item
12-0922	11027	Snap Ring
44-0501	43559-73	Washer

1973-83 Hub Hardware.

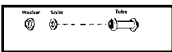

FLT Wheel Hub Hardware fit 1982-99 models, 1982-99 FXR models.

VT No.	OEM	Item
44-2024	43613-92	2.424" Spacer for narrow hub
44-2025	43608-82	4.308" Spacer for wide hub
44-2026	43650-82	Spacer Washer
44-2027	43290-82	.032" Shims, 10 pack
44-2028	43291-82	.016" Shim
44-2029	43292-82	.008" Shim
44-2030	43293-82	.004" Shim
44-2031	43294-82	.002" Shim

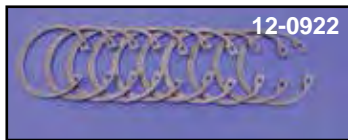

Wheel Seals. Note: VT No.14-0139 and 14-0658 feature metal housing all others are rubber covered.

James	VT No.	OEM	Fits
14-0659	14-0140	47519-83A	83-99 FX, 85-99 FLST, Front/Rear Wheel Double Lip
—	14-0182	47519-83	1983-84 As Above
14-0657	14-0138	47519-58	1973-82 FX Rear Wheel 1973-82 FL Front/Rear Wire Double Lip
14-0658	14-0139	47519-72	1972-82 FX Front Wheel 1973-82 FL Front/Rear Mag Wheel
14-0622	14-0171	25414-82	Enclosed Chain Housing Seal for 1984 FXRT, 1982-84 FLT-FLHT
14-0664	—	12047	1980-81 FLT
—	12-0922	11027	Snap Ring

## Hub Internal



Inner Hub Bearing Tube Spacers may be used in some cast mag wheel applications, when flange is removed. Check for proper length fit.

VT No.	OEM	Model/Year	Front/Rear
44-0309	43549-36	1935-66 Big Twin	Front and Rear
44-0310	43549-67	1967-72 Big Twin 1971-72 FX	Front and Rear Rear
44-0315	41185-63	1963-78 XL	Rear
<b>Steel Dual Flange Hub Spacer, Front &amp; Rear</b>			
44-0338*	43601-78	4.420"	Orange
44-0336*	43602-78	4.434"	Yellow
44-0337*	43603-78	4.448"	White
<b>Cast Wheel Hub Spacer, Front &amp; Rear</b>			
44-2032*	43604-78	4.420"	Red
44-2033*	43605-78	4.434"	Yellow
44-2034*	43606-78	4.448"	White

## Front Laced

44-0237 43668-82 FLT-FLST-FXST-WG

## Aluminum Hub Spacer, Front

44-0311	43740-64	1954-72 XL 1971-72 FX
44-2035*	43635-74	2.148" Gold/Violet
44-2036*	43633-74	2.162" Red/White
44-2037*	43745-73	2.166"
44-0312*	43634-74	2.177" Green/Orange
44-1981*	43625-78	2.536" Gold
44-1980*	43624-78	2.550" Pink
44-0313*	43623-78	2.564" Violet
44-0362	43613-00	Front, XL-FXD

\*Note: Choose proper length.



Adjustable Inner Hub Spacer for 1973-99 wire wheels and most custom wheel application.

VT No. 44-0639



3/4" Axle Spacer Saver use to hold axle spacers in place during rear wheel installation.

VT No. 16-0335



**44-0426 Deluxe Rear Hub Rebuild** contains all internal parts including longest length inner spacer (white 4.4480). Spacer can be cut down or collar removed for some applications. Fits 1973-82 FL-FX.

**VT No. Bearing**  
**44-0426** Timken  
**44-0428** Peer



**44-0418 Rear Wheel Bearing Race and Seal Kit.** Three kits available for mag and wire wheel applications. Each kit includes two each bearing, race and proper seals.

**VT No. Fits**  
**44-0418** 1982 FXR laced wheel  
 1973-82 All FX-FL models with Laced wheel and 1980-82 FL cast wheel  
**44-0419** 1973-84, All FX models with laced wheel and 1973-79 FL cast wheel  
 1979-82 XL cast or wire wheel



**1973-up Big Twin Hub Rebuild Kits** contains bearings, races, seals, snap rings, seal retainer washers and seal spacers. Hub and internal bearing spacer not included.

**VT No. Fits**  
**44-0450** 1973-79 FL Cast Wheel Front/Rear  
 1973-83 All FX's Cast Wheel Rear Only  
**44-0451** 1973-83 FL Laced Wheel Front & Rear  
 1980-83 FL Cast Wheel Front & Rear  
**44-0409** 1973-82 FX-FXE-FXEF-FXEF-80-FXE-80  
 FXWG Laced Wheel Rear Only  
**44-0452** 1982-83 FXWG, 1982 only FXS-80 Laced Wheel  
 1982-84 FXR-FXRS Laced Wheel Rear Only  
**44-0454** 1982-83 FXR-FXRS Cast Wheel only

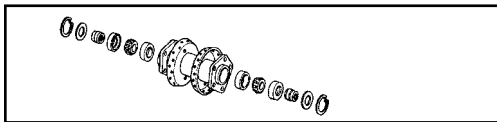

**Front Wheel Assembly Kit** for steel hubs only. Contains two each, bearing, race, seal and one each correct seal spacer. Also included for certain applications only are two each snap ring and seal retainer washers. Not included in this kit is the internal bearing spacer. This may be ordered separately. Check listing.

**VT No. Wheel Fits**  
**44-0450** Cast 1973-83 FLH  
**44-0451** Wire 1973-83 FLH  
 Cast 1980-83 FXWG



**Sealed Bearing Kit** will replace tapered bearing and races on 1973-85 Big Twin rear, all 1973-84 FLH front.  
**VT No. 44-0930**

# Hub Rebuild



**44-0415 Front Wheel Bearing, Race and Seal Kit** contains two each, bearing, race and proper seals. Three kits available.

**VT No. Fits**  
**44-0415** 1980-83 FXWG laced  
 1973-83 FLH laced  
 1980-83 FLH cast  
**44-0416** 1973-79 FLH cast  
 1973-83 FX-XL cast or wire  
 1982-83 FXR cast or wire

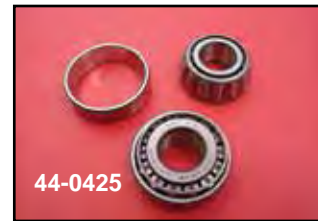

**44-0425 Bearing Kit** includes two tapered bearings and two races replacing 9052 for wheel 1973-99 Big Twin swing arm 1958-85.

VT No.	Item	U/M
<b>44-0425</b>	Four Piece Kit	Kit
<b>44-0405</b>	Race and Bearing	Pair
<b>44-0406</b>	Bearing Only	Each
<b>44-0407</b>	Race Only	Each



**44-0403 FX-FXE-XL FXR Front Internal Hub Kit** includes all internal parts for complete rebuilding of all alloy front hubs. Includes inner spacer, bearings, races seals and seal spacer matched for each year group. Hub is not included.

VT No.	Type	Fits
<b>44-0403</b>	Drum	1964-72 XL-XLH, 1971-72 FX
<b>12-0906</b>	Drum	Snap Ring for Above
<b>44-0402</b>	10" Disc	1973-only FX-XL
<b>44-0401</b>	11" Disc	1974-77 FX-FXE-XL
<b>44-0400</b>	Dual Disc	1977-83 FX-FXR-XL



**44-1976 Wheel and Swing Arm Bearing and Seal Kit** is a deluxe kit which includes 2 of each type of seal for 1958-71, 1972-82, 1983-99 year group of swing arm and wheel bearing application, with two tapered cone bearing assemblies.

VT No.	Item
<b>44-1976</b>	Deluxe Kit
<b>12-0382</b>	Bearing Only
<b>12-0381</b>	Race Only
<b>12-0393</b>	Bearing and Race Kit, Two piece
<b>12-0787</b>	Bearing and Race Kit, Four piece

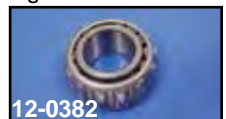





# Star Hub Rebuild



**1936-66 Internal Star Hub Component Kit** includes internal rebuilding parts to assemble a bare hub. Everything pictured except hub. Includes standard rollers. Fits all interchangeable wheels 1936-66 if oversize 9220 series in .0002 to .002.

rollers are needed order from our  
**VT No. Years Finish**  
**44-0413** 1955-66 Chrome  
**44-0431** 1936-54 Parkerized



**Deluxe Star Hub Rebuild Kit** fits 1936-66 interchangeable hubs, includes inner and outer stars, screws, gaskets, thrust washers, outer bearing

sleeve, snap rings, cork retainer washer and standard rollers.  
**VT No. 44-0414**

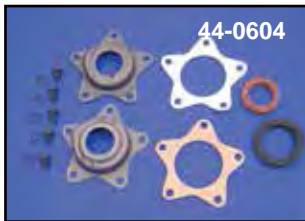

**Hub Thrust Plate Kit** includes inner star, grease fitting, and outer chrome or parkerized star. Replaces 43569-55.

**VT No. Finish Fitting**  
**44-0535** Chrome With fitting  
**44-0559** Parkerized With fitting  
**44-0604** Parkerized Without fitting  
**44-0924** Gasket Hardware

## 1967-72 Hub

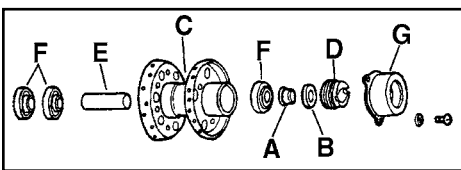

**Internal Hub Parts** for 1967-72 interchangeable hubs FL-FLH models.

**VT No. # OEM Item**  
**44-0392** A 41196-55 Seal Spacer  
**14-0131** B 41210-55 Seal 5 pack  
**45-0673** C 43540-67C Chrome Hub, Complete  
**45-0306** C 43540-67C Chrome Hub, Bare  
**45-0758** C 43540-67 Black Hub, Bare  
**44-0526** D 43542-67 Locknut (Left Hand)  
**44-0310** E 43549-67 Inner Spacer  
**12-0331** F 43577-67 Bearing, each  
**44-0505** G 43592-70 Cover, Chrome  
**1967-72 Lock Nut and Seal Kit** includes A, B and D.  
**VT No 44-0408**

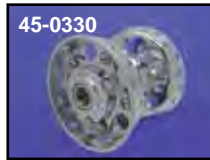

**Replica Star Hubs** include all internal parts, completely assembled, for front and rear. 45-0799 is bare without internals.

**VT No. OEM Year Finish**  
**45-0330** 43540-36 1941-66 Chrome  
**45-0323** 43540-36 1941-66 Black  
**45-0789** 3958-36 1936-40 Black  
**45-0799** Bare 1936-40 Parkerized  
**45-0806** Chrome 1936-40 Timken  
**45-0807** Black 1936-40 Timken

*V-Twin replicated the "Star" Hub in 1980 with over 11, 000 being produced. All internals interchangeable with original and replaceable with components from our list.*

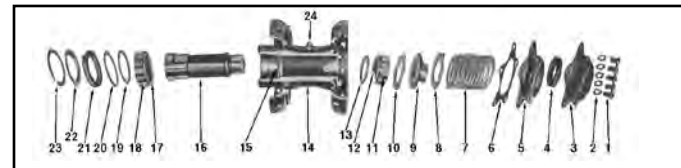

**Star Hub Components.** Available in packs for 1936-66 hubs. See complete kits on this page for rebuilding.

Index	Application	VT No.	OEM
1 & 2	Thrust Bearing Cover Screws & Lock washers	<b>8200-10</b> <b>8201-10</b> <b>9670-10</b>	Chrome Cadmium Parkerized
3 & 5	Hub Thrust Plate Kit	<b>44-0535</b>	43569-55
3	Star Outer Cover, Chrome	<b>44-0527</b>	43566-35A
3	As above, parkerized with hole	<b>44-2050</b>	43566-35
3	As above, chrome	<b>44-0465</b>	43566-35
	Chrome Star	<b>44-0458</b>	Without hole
4	Small Cork	<b>15-0350</b>	43570-35
4, 6 & 21	Gasket and Seal Kit	<b>15-0630</b>	
4, 6 & 21	As Above GB	<b>15-0637</b>	
6	Star Gasket	<b>15-0173</b>	43576-35
6	Star Gasket	<b>15-1054</b>	James
7	Thrust Bearing		
	Adjustment Shims (10)	<b>12-0708</b>	43560-35
	.002 Shim	<b>12-0720</b>	
7	.015 Shim	<b>12-9917</b>	(10pc)
8 & 10	Thrust Washer (2)	<b>44-0524</b>	43563-35
9	Thrust Bearing Sleeve	<b>44-0530</b>	43556-35
11 & 18	Bearing Roller Set, 26 required Std. Size	<b>10-0319</b>	9220
	.0002	<b>10-0320</b>	9221
	.0003	<b>10-0339</b>	
	.0004	<b>10-0321</b>	9222
	.0006	<b>10-0322</b>	9223
	.0008	<b>10-0323</b>	9224
	.001	<b>10-0324</b>	9225
	.002	<b>10-0325</b>	
12	Roller Retainer, Small	<b>44-0531</b>	24721-30
13	Roller Retainer Thrust Washer, 1 used, each	<b>44-0523</b>	43552-39
	Wheel Hub Chrome	<b>45-0330</b>	43540-36
	Wheel Hub Black	<b>45-0323</b>	Assembly
14*	Thrust Collar (for aftermarket hub)	<b>44-0534</b>	43561-39
15	Inner Sleeve 1939-up	<b>44-0309</b>	43549-36
16	Roller Retainer, Large	<b>44-0532</b>	43578-35
17	Roller Retainer Washer		
19	1 used, 10 pack	<b>44-0522</b>	43558-39
20 & 23	Lock Ring, 2 used 10 pack	<b>12-0921</b>	43554-35
21	Large Cork	<b>15-0631</b>	43571-35
21	Large Cork, James	<b>15-0231</b>	43571-35
22	Retainer, Cork Washer		
	1 used	<b>44-0521</b>	43564-35
	Grease Fitting 10 pack	<b>44-0533</b>	9851

**Note:** 14, Hub is assembled with all internal parts.



**Internal Bearing and Hardware Kit** for 1967-72 front and rear hubs. All parts necessary to build or rebuild a bare hub. Includes three bearings, tube spacer, seal, seal sleeve and hub lock (Left Hand Thread).  
**VT No. 44-0410**



# Rear Axle Parts

First Offered by V-Twin in 1981!

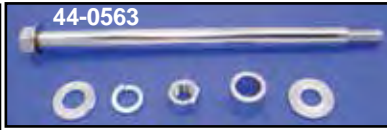
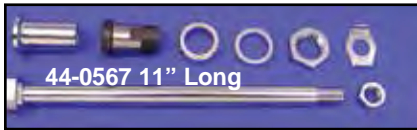
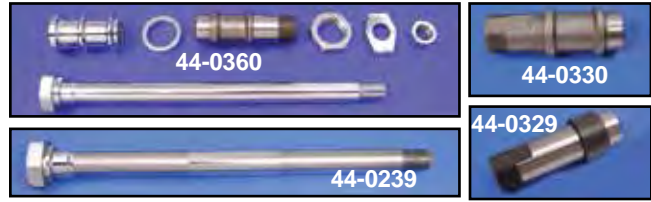
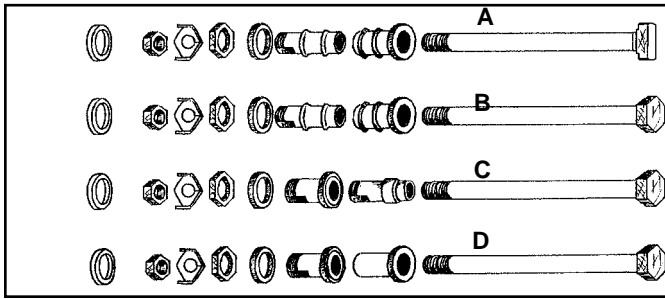

Rear Axle Kits include chrome axle, nuts, sleeves and spacers for each application. Nut kit includes outer sleeve and axle nuts chrome. Sleeve is included on types A, B, C and D.

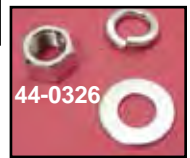

Kit Cpt	Spacer	Sleeve	Axle only	Nut Kit #	Model/Year
44-0561	44-0343	44-0331	44-0216	9688-4	B 1941-52 45 Solo ,Black
44-0349	44-0323	44-0331	44-0347	8832-4	B 1941-52 45 Solo, chrome
44-0360	44-0322	44-0330	44-0226	8160-4	B 1936-57 Rigid Big Twin (Hex)
44-0377	—	—	44-0231	9692-4	B 1936-57 Big Twin Hex Parkerized
44-0382	—	—	44-0721	9692-4	1941-57 Big Twin Hex Parkerized
—	—	—	44-0239	8160-4	1936-57 Big Twin Hex Chrome
44-0560	44-0322	44-0330	44-0215	8160-4	A 1936-57 Rigid Big Twin (Flat)
—	—	—	44-0272	8160-4	1936-57 Big Twin Hex Chrome
44-0348	44-0344	44-0330	44-0346	9692-4	A 1936-57 Rigid Big Twin (Flat) Parkerized
—	—	—	44-0272	9692-4T	1936-57 As Above
44-0562	44-0321	44-0329	44-0214	8160-4	C 1958-62 FL Big Twin
44-0508	—	—	—	—	As Above Parkerized
44-0582	44-0321	44-0355	44-0214	8160-4	C 1963-66 FL Big Twin
44-0509	—	—	—	—	As Above Parkerized
44-0567	44-0353	44-0327	44-0213	8160-4	D 1967-72 FX-FL
44-0510	—	—	—	—	As Above Parkerized
44-0563	44-0325	—	44-0212	8715-4	1973-85 FX-FL, Chain
44-0564	44-0340	—	44-0218	8715-4	1982-84 FXWG, FL, Belt

**Chrome Rear Axle Nut and Washers for 1936-73 Big Twin, 5/8" x 18.**

VT No.	Item
44-0326	Nut with washer kit
37-8127	Nyloc-Nut, 10 pk
37-0963	Flange Nut, Each

**Rear Axle Kit** replaces 41552-73 on 1973-84 chain drive FLH-FX, includes axle, pyramid adjuster blocks & chrome nuts. **VT No. 44-1957**

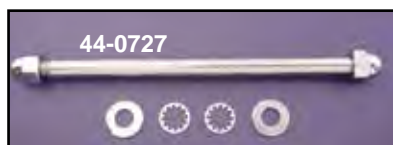

**Chrome Rear Axle Kits** fit 1973-84 FX & FL models. Kits include acorn or pike nuts.

VT No.	Type
44-0727	Acorn
44-0728	Pike



**Rear Axle Seal Spacer Sets.**

VT No.	Application
44-0411	1973-82 FX-FXE-FXEF-FXEF-80 FXE-80, FXWG, Wire Wheel 1973-83 All FL's Cast or Wire Wheel 1973-86 All FX's except FXWG
44-0421	1982-86 FXR's Cast/Wire Wheel pairs 1984-86 FXST Wire Wheel 1982-86 FXWG Wire Wheel 1982 only FXS-80, Wire Wheel 1982-86 FXB-FXSB Cast Wheel
44-0423	1983-86 FLH-80 Wire Wheel, each
44-1944	1982-84 FXR with Flange

**Rear Axle Spacers.**

Chrome	Zinc
44-0325	44-2051



**Application**

44-0325	1984-86 FXST Cast/Wire Wheel
44-0325	1973-82 All FL's Left Cast/Wire,
44-0325	1973-83 FX-FXE-FXEF-FXEF-80-FXWG Left Wire Wheel
44-0325	1981-86 FXE-80 Wire Wheel
44-0325	1973-86 All FX Cast Wheel
44-0655	1982 only Classic 1983-up FLH-80 Cast or Wire, 1984-86 FXWG Wire
44-0655	1980-86 FXB-FXSB Cast Wheel

**Chrome Rear Axle Nut & Washer Kit** includes 2 extra thick washers, nut and lock washers for 1973-up, on square swing arms.

VT No.	Brand
8715-4	Colony
44-0520	V-Twin



**Axle Protector Plates** prevent axle nuts from scratching painted finish. Sold in pairs, polished stainless. 51-0680 fits Replica Rigid frames with forged rear axles plates.

VT No.	Fits	Type
37-8882*	Rigid Frame	Custom
51-0680	Rigid Frame	Replica

**\*Note:** Requires drilling & tapping at axle area. Drill and tap not included, screws included.





# Axle Adjuster

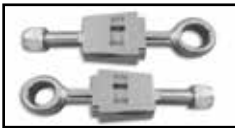

**Calibrated Rear Wheel Adjusters** feature chrome pyramid blocks with sight indicator to view calibrated adjuster bolt, for accurate and easy wheel alignment.

Adjuster bolt is chrome heavy duty 1/2" rod with micrometer markings, nut is stainless steel. Fits 1973-85 FX-FLH, 1984-86 FXST. **VT No. 44-2011**



**Complete Rear Wheel Adjuster Kit** for 1973-85 Big Twin models includes pull adjusters, chrome end plates, plated hex nuts and chrome plated tapered lock nuts. End cover and nut kit also available.

VT No.	Item
8100-8	Complete Kit
8101-6	End Cover Kit



**Pyramid Adjuster Block Kit.** Die cast chrome pyramid end caps with solid block type pull adjusters.

VT No.	Item	Model
44-0365	Kit	1973-85 FX-FL
44-0963	Kit	1973-85 FX-FL
44-0366	Blocks	1973-85 FX-FL
44-0485	Nuts	1973-85 FX-FL
44-0541	Adjusters	1973-85 FX-FL



## Rear Axle Adjuster Sets.

VT No.	Models
44-0334	1973-84 FX-FL w/chrome end caps
44-2009	Chrome End Cap only
44-0333	Adjuster Pull only, pair
44-0600	1981-94 FXR, 1979-83 FLT Zinc
44-0603	End Cap Outer for Above

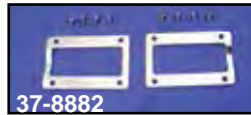

**Axle Protector Plates** prevent axle nuts from scratching painted finish. Sold in pairs, polished stainless.

VT No.	Fits	Type
37-8882*	Rigid Frame	Custom
51-0680	Rigid Frame	Replica

\*Note: Requires drilling & tapping at axle area. Drill and tap not included, screws included.



**Axle Locator Set** allow use of 3/4 axle in stock Rigid frames with 7/8" axle slots.  
**VT No. 44-1946**

# Rear Axle Hardware 1930-72



**Rear Axle Nut and Lock Kit** includes sleeve nut, collar, axle nut and lock clip.

## Big Twin 1936-72

VT No.	Type	Finish
8160-4	Kit	Chrome
8160-4T	Kit	Chrome
44-0316	Collar Only	Chrome
8161-4	Kit	Cadmium
9692-4	Kit	Parkerized
9692-4T	Kit	Parkerized
37-8791	Lock Clip	Parkerized

VT No.	Type	Finish
45 1930-52		
8832-4		Chrome
8832-4T		Chrome
9688-4		Parkerized
9688-4T		Parkerized
44-0662	Lock Clip	Black

## VL 1930-36

9610-5		Chrome
9611-5		Parkerized

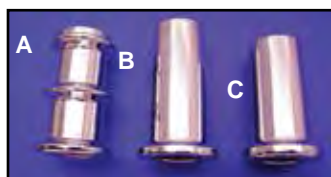

**Outer Rear Axle Spacers** for Big Twin.

Chrome	Zinc	OEM	#	Year
44-0322	44-0344*	41595-36	A	1936-57
44-0321	44-0339	41595-58	B	1958-66
44-0353	44-0354	41595-67	C	1967-72

\*Note: Parkerized

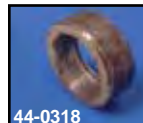

**Rear Axle Sleeves** for mechanical and hydraulic rear brake backing plates. \*Note: Fit between back plate & swing arm.

VT No.	OEM	Year	Model	Item
44-0331	41718-41	1941-52	45"	Sleeve
44-0330	41600-36	1936-57	Big Twin	Sleeve
44-0864		1936-57	Big Twin	Sleeve
44-0329	41600-58	1958-62	Big Twin	Sleeve
44-0319	41596-58	1958-62	Big Twin Side Plate	Spacer
	Chrome			
44-0355	41600-63	1963-66	Big Twin	Sleeve
44-0318*	41596-63	1963-72	Big Twin Side Plate	Spacer
	Zinc			
44-0378*	Chrome	1963-72	Big Twin Side Plate	Spacer
44-0327	41600-67	1967-72	Big Twin	Sleeve
44-0949		1937-57	Big Twin	Sleeve Kit



**Rear Chain Adjuster Sets** are heat treated.

Available in pairs with plated lock nuts assembled to insure proper fitting threads.

Chrome	Cadmium	Parkerized	Fits
7704-2	8014-2	9629-2	1936-72 Big Twin
7814-2	8479-2	9628-2	1930-52 Solo 45
9500-4	—	9506-4	1932-73 Servi Car



# Front Axle Kit

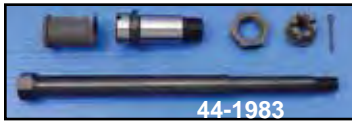

44-1983



44-0568



44-0225



44-0581



44-0570

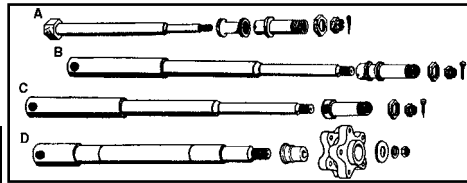

**Front Axle Kits** include plated axle, nuts, spacer and hardware. Axle sleeve included when required.

Year/Model	Kit	Spacer	Nut Kit	Axle	Axle OEM	Finish	#
1936-48 BT Spring Fork with Sleeve 44-0300	44-0581	44-0304	8162-3	44-0209	43872-36	Chrome	A
1948-66 FL Glide, with Sleeve 44-0301	44-1983	44-0111	9406-3	44-0085	43875-48	Parkerized	B
1967-71 FL Glide, 1967-71 FL Glide, with Sleeve 44-0302	44-0568	—	8162-3	44-0200	43875-48	Chrome	B
1972 only FL Glide with spacer and flange	44-0225	—	8163-3	44-0224	43875-48	Zinc	C
1973-80 FL Glid, 1980-83 FXWG	44-0569	—	8162-3	44-0201	43875-67	Chrome	C
1981-85 FLH	44-0569	—	8162-3T	44-0201	43875-67	Chrome	C
1970-72 FX (Zinc)	44-0240	44-0397	8769-3	44-0228	43875-72	Chrome	D
1973-77 FX	44-0570	44-0303	8769-3	44-0202	43875-73	41	
1977-83 FXE	44-0383	—	—	—	43875-73	Zinc	
	44-0571	44-0303	8769-3	44-0203	43867-81	41	
	44-0573	—	44-0308	44-0204	43871-52	33	
	44-0574	—	8768-3	44-0205	43871-73	35	
	44-0576	—	8768-3	44-0206	43883-77	35	

**Axles** have chrome plated ends, except as noted. Order nut kit separately.

VT No.	OEM	Fits	Finish
44-0209	43872-36	1932-47 Springer Type Fork	Chrome
44-0085	43872-36	1932-47 Springer Type Fork	Parkerized
49-1963	43871-30	1930-52 45" Solo	Black
49-0260	—	1941-44 WLC	Black
44-0200	43875-48	1948-66 FL	Chrome
44-0224	43875-48	As Above	Zinc
44-0228	43875-72	1972 only	Chrome
44-0201	43875-67	1967-71 FL	Chrome
44-0202	43875-73	1973-80 FL, 1980-83 FXWG	Chrome
44-0222	43875-73	As above	Zinc
44-0203	43867-81	1981-85 FLH	Chrome
44-0208	43346-83	1983-86 FXWG, 1981-85 FLH-80, 1984-99 all FLT, 1984-up FXST	Chrome
44-0204	43871-52	1952-72 XL 1970-72 FX	Zinc
44-0205	43871-73	1973-77 XL-FX	Chrome
44-0206	43883-77	1978-83 XL's 1977-83 All FX except FXWG	Chrome



44-0240

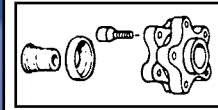

12-0331

**Left Side Disc Hub Flange** is used when large type disc caliper is mounted to glide FL fork on 1972 only.

VT No.	Type
44-0240	Complete Hub Flange Kit with axle
45-0314	1967-72, Flange only
44-0397	Spacer Left
44-0228	Chrome Axle Only
12-0331	1967-72, Flange Bearing only
23-0440	Chrome Lug Bolt Set



2263-2 Installed

**Pike Front Axle Nut Kit** fits 1972-up WG, 1984-up ST models and 39mm FXR and FXD.

VT No. 2263-2

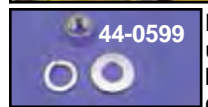

44-0599

**Front Axle Nut Kits** are chrome or cadmium finish. Models which require sleeve nut, brake drum models, it is included along with castle nuts and cotter pins.

Chrome	Cad	Parkerized	Model
8162-3	8163-3	—	1946-71 Big Twin
9405-3	—	9406-3	1930-36 VL, 1936-45 Big Twin
8852-4	8853-4	9689-4	1929-36 45 Solo
—	8855-4	9690-4	1929-36 45 Solo
8162-3	8163-3	—	1930-71 Servi
—	8163-3	—	1930-71 Servi
44-0308	—	—	1971-72 FX (Nut Only)
8768-3	—	—	1973-up FX-XL
8769-3	—	—	1972-up FLH & WG
44-0599	—	—	1972-up WG



44-0397



44-0303



44-0295

### Front Axle Spacers

Chrome	Zinc	OEM	Side	Application
—	44-0397	43885-72	Left	1972 only 74 FLH
44-0653	44-0303	41594-73	Left	1973-86 FL, FLH, FLH-80, Classic 1980-82 FXWG
44-0657	44-0295	41607-83	Right	1983 FXWG



**Speedometer Drive Spacer** replaces drive units. Fits 1973-83 FX. VT No. 44-0390

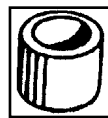

**Front Wheel Seal Spacers** sold each, except noted.

VT No.	OEM	Side	Application
44-0391	43548-73	Left	1973 XLH-XLCH-FX-FXE
44-0305	43548-74	Left	1974-77 XLH-XLCH-FX-FXE
44-0306	43488-77	Left	1978-95 XL-XLS-FX-FXE-FXEF FXEF-80, 1982-83 FXR-FXRS-FXRT
44-0411	41196-78	R-L	1973-84 FL-FLH-FLH-80 1980-86 FXWG, pair
44-0299	41196-83	R-L	L1983-84 FLH-80



**Cadmium Front Axle Nut** replaces 7734W, 1/2 - 20 threads, zinc.

VT No.	Type
44-0307	Each
44-2013	5 pack

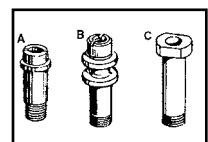

### Front Axle Sleeves.

VT No.	#	OEM	Fits
44-0300	A	43882-36	1937-48 Big Twin
44-0301	B	43882-48	1949-66 FL-FLH
44-0302	C	43882-67	1967-71 FL-FLH
12-0537	—	43886-30	Sleeve Nut



44-0111

**1936-47 Big Twin Front Axle Spacers.**

VT No.	OEM	Finish
44-0304	43884-36	Chrome
44-0111	43884-36	Parkerized





# Front Hubcap

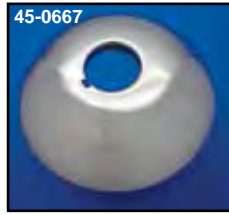
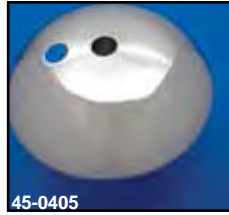

**Chrome FL-FLH Front Wheel Hubcaps.** Full 8" dresser hubcap for wire wheels to fit between hub and axle without additional hardware.

VT No.	OEM	Years	Model
49-1998	43330-48	1936-57	Springer
45-0405	43303-49	1948-66	FLH
45-0406	43304-67	1967-72	FLH
45-0666	43304-73	1973-80	FLH
45-0667	44463-82	1981-84	FLH
37-8349	Fits	45-0405	Plug



**1973-95 Chrome Mini Cap** fits between swing arm and axle spacer.

VT No. 45-0692



**1936-48 Big Twin "Atlas" Front Hubcap** is of alloy or chrome construction and acts as a hub cap and axle spacer on Big Twin Spring Forks.

VT No. Finish

49-0968 Alloy

49-0977 Chrome



**8" Spring Fork Hubcap** in chrome, replaces 43000-48. Fits all 1936-48 74", 1941-57 Servi-car front wheel. VT No. 49-1998



**Rear Hub Cap** fits 1936-57 Rigid Big Twin. VT No. 45-0669



**Wheel Cover Sets.**

VT No.	Year	Fits	MM
49-0299*	1949-66	Front	221
	1941-57	Rear	
49-0291	1941-48	Front	194



**4 1/2" Front Chrome Hubcaps** fit between hub and axle without additional hardware. Fits 1981-84 FLH.

VT No. 42-0668



**Left Side Hubcap** fits 1936-57 Spring Forks, OE covers, backing plates and rivets.

VT No.

49-0968 Left Side

49-1924 Set



**Replica Chrome Hubcap** replaces factory accessory 11260-46 to fit 1936-66 front and rear Big Twin. VT No. 45-0400

**\*Note:** For Rigid Rear application right hand spacer must be turned down to fit into cover.



49-0299  
Installed

# Axle Cap

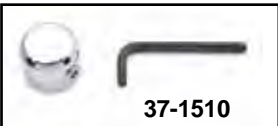
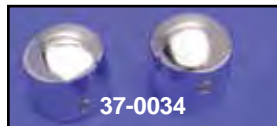

**Chrome Rear Axle Nut Caps Set** for both axle nut and axle head where required, set screws and hex key wrench. Each cap has an internal hex to allow more thickness for the set screws thread to eliminate thread stripping.

**Note:** These axle caps will not work on late model rear axles with cotter key locking devices.

VT No.	Fitment
37-8885	1982-86 FXWG
37-8884	1980-81 FXWG
37-8885	1981-85 FX, Except FXWG-FXST
37-8884	1973-80 FX, Except FXWG
37-8886	1971-72 FX
37-8885	1980-94 FLT
	Does Not Fit Rear 1989-94
37-8885	1981-84 FLH
37-8884	1973-80 FLH
37-8886	1972 FLH
37-8885	1981-84 FLH
37-8884	1973-80 FLH

**Big Twin Front Axle Cap Sets** include right and left caps with set screws for glide type forks. Cap included for anchor stud on 37-0035 only.

VT No.	Type	Year/Model/Type
37-0035	3 pieces	1949-71 FLH, Axle and Anchor Stud Caps
37-1510	1 piece	1949-71 FLH, Anchor Stud Cap
37-0034	2 pieces	1949-71 FLH, Axle Caps
37-0036	2 pieces	1972-84 FXWG-FLT-FXST, Axle Caps FLH and XL-FX with 39mm



**Solo Seat Kit** includes leather seat and mount kit for 1965-84 FL-FXE.  
**VT No. 47-0120**

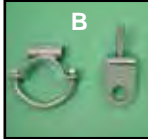
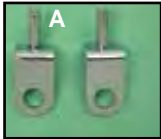

**Chrome Spring Mount Kit** includes mounts for spring perch which attach to top shock studs and front clamp for nose bracket. Fits 1958-84 FX-FL.

**VT No. Type**

**31-0502** A and B Complete Kit

**31-0174** B Front U Clamp Only



**FLH Seat Bracket** attaches frame mount seat to 1958-84 FLH. Bolts to stock fenders 1976-84, Zinc plated.

**VT No. 31-4005**



**Solo Seat Mount Kits** for 1936-84 Big Twin include nose bracket, chrome springs and rear brackets to mount small type solos only such as 47-0089. To mount larger Police seats purchase cross bar separately VT No. 31-0473. To mount K-model type solo order 31-0478 cross bar. Fits 1973-84 FX.

**VT No. 31-4010**



**Police Type Solo Seat Mounting Kits** for 1958-84 Big Twin. Include nose bracket, chrome springs and rear mount

**VT No. Spring Type**

**31-0580** 2" Coil

**31-0606** 2" Hair Pin



## 1958-84 Seat

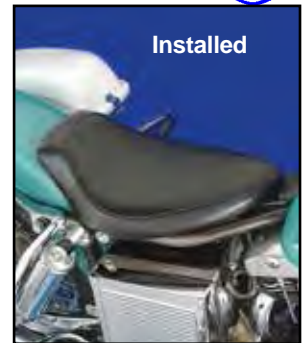

**Solo Seat** fits 1958-84 FX/FL.

**VT No. 47-0599**

## Seat Bracket



**Chrome Seat Mount Tab** use 31-4018 rear on 1981-84 models when installing a one piece seat. Use 31-4018, on 1979-up XL Seat, VT No. 31-0413 1973-up rear. Use nylon washer under seat tab.

**VT No. Fits**

**31-4018** Rear FXR

**31-0413** Rear FXST-FLST

**31-0653** Rear Tab Kit, 2000-up FXST, FLST

**37-8858** Nylon Washer, 25 pieces



**Rear Seat Mount Tab Kit** allows removal of seat without reaching under fender. Kit includes black bracket, nylon washer, knob, 1/4 x 28 x 1/4 x 20 flathead allen screw and 1/4" well nut, to place in fender if stock 1/4 x 28 hole is stripped. Purchase rear seat tab separately.

**VT No. 31-0176**



**Rear Set Bracket** fits 1972-84 FXE.

**VT No. 31-4014**



**Passenger Pad** fits stock seat rails on 1977-85 FLH-FLT- FLHT. Available in pillow style Naugahyde to match factory style seats. Includes mount, 13" tall. Passenger pads will fit seat rail shown.

**VT No. 47-8654**



**Chrome Seat Rails** for 1977-84 FLH Includes clamp, 13" tall.

**VT No. 31-0518**





# Replica Bubble Bag Set



**Replica Plastic Bubble Bag Sets** with 1958-84 brackets, supplied for Swing Arm Big Twin models. Bags include locks, chrome band, lids and inner chain.

VT No.	Type	Item
49-2499	Black	Bags Only w/lock set installed, no brackets
49-2498	White	Bags Only w/lock set installed, no brackets
49-2450	White	Bag Set with brackets and latches
49-2451	Black	Bag Set with brackets and latches
49-0381	Lock Set	One Side Only
49-2621	Bracket Set	1958-84 Big Twin
49-2634	Bracket Set	1941-57 Rigid

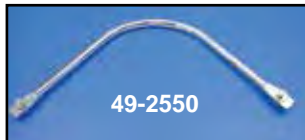

## Saddlebag Mount Bracket Sets

are to fit fiberglass bags.

VT No.	Fits	Item
49-2418	1963-77 FLH	Set
49-2754	1978-84 FLH	Set
49-2758	1978-84 FL	Set
49-2548	1978-84 FLH	Right
49-2549	1978-84 FLH	Left
49-2550	1963-84 FL	Rear Bracket, Each

# Saddlebag Hardware

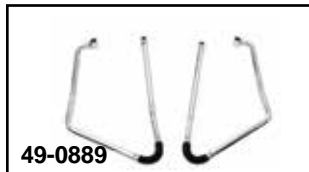
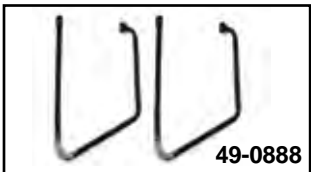
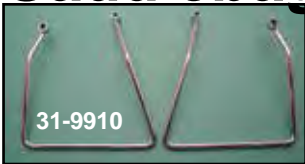

**Chrome Saddlebag Supports** are designed to fit the contour of the fender struts and protect your bags from the brake caliper and swing arm. Fits 1971-85 FX-FXE.

VT No.	Type
31-9910	2-Bolt
31-9911	1-Bolt
49-0888	Black, Adjustable
49-0889	Chrome, Adjustable



# Saddlebag Set



**Glide Sets.** Black cowhide measure 21" x 14" x 6" feature chrome buckles, spots, conchos and Neoprene back to hold shape. Designed to replace the stock fiberglass saddlebags on 1958-84 FLH, by mounting

to existing pins on stock bag supports or VT No.49-2418 which are available separately. Also included are plate brackets which may be mounted to fenders or most struts.

VT No.	Item
48-3132	Bag Set Only
<b>Chrome Saddlebag Mount Bracket Sets</b> fit VT No. fiberglass bags.	
VT No.	Fits
49-2418	1963-77 FLH
49-2754	1978-84 FLH



Bertha FL  
1964-84 Bags

**Bertha Bag Sets** measure 20" x 14" x 7". Feature full leather construction, with fringe and 1/2" chrome spots. 1964-84 FL fit stock fiberglass saddlebag brackets.

VT No.	Item
48-3184	Bertha Bag Set
49-2418	Bracket Set



**Large Three Buckle Thro-Over.** All bags glued, sewn and riveted. Available black only. Measures 13" Long x 5" Wide x 12" High.

**VT No. 48-3128**



**Black X-Large Three Buckle Thro-Over** measures 14 1/2" Long x 6" Wide x 12" High.

**VT No. 48-3127**



**Caliper Guard** mounts to axle and keeps saddlebags out of wheels on 1973-85 FX-FL, 1986-99 ST zinc plated. **VT No. 48-0177**

VTNo.	Item
48-0175	White Saddlebag Set
48-0376	OE Gas Tank Decal

# Saddlebag Rail Kit and Hardware



49-2668



49-2050



49-2051

**White or Black Fiberglass Saddlebag Set** includes left and right sides. Including tops, latches, keys and brackets for mounting.

**VT No. Item**  
**Bag Set Only**

49-2050 White Bag Set

49-2051 Black Bag Set

**1977-84 with brackets**

49-2668 White

49-2669 Black

**1958-76 with brackets**

49-2800 White Bag Set

49-2612 Black Bag Set

**Components**

49-3510 White Bag Lid

49-3511 Black Bag Lid

49-3512 Black Bottom, right side

49-3513 Black Bottom, left side

49-3514 White Bag Bottom, right side

49-3515 White Bag Bottom, left side

37-0545 Spacer Set to fit Saddlebags with luggage rack

(A) Saddlebag tops sold each. Direct replacement for 1970-78 models. Can be used on 1979-80 models with hinge kit 49-2506.



49-3510



49-3511

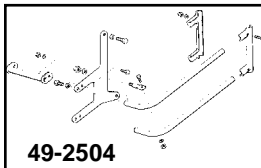

49-2504

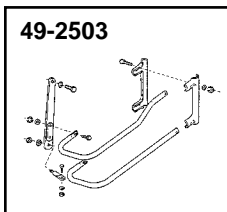

49-2503

**Saddlebag Guard Chrome Kit** includes right and left chrome rail set for protecting fiberglass FLH bags.

**VT No. OEM Years**  
49-2504 90800-68 1968-77 FL-FLH  
49-2503 90800-78 1978-84 FL-FLH



37-9113



15-0733

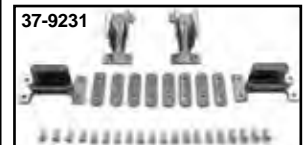

37-9231

**Saddlebag Hardware Kit** fits one side of 1970-80 fiberglass Saddlebags. Includes parts pictured with lock and keys.

**VT No. Item**  
37-9113 Hardware, Left or Right (One side only)  
37-9231 Lower Clip Kit, 12 piece  
37-9311 Lower Clip, Backing Plate  
15-0733 Cover Rubber Gasket, each



**Saddlebag Lock and Hook Kit** fits 1970-81 FLH bags, sold per bag.  
**VT No. 37-8375**

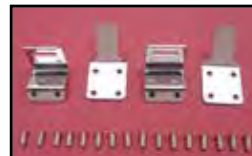

**Style Hinge Kit** fits 1969-84 FLH saddlebags for both sides.  
**VT No. 49-2506**

## FLT



49-2701



15-0580

**FLT/FLHT Saddlebag Lids** have a primed finish. Hardware and gaskets are not included. Lids are sold each.

**VT No. OEM Side Fits**  
49-2700 90756-79A Right 1979-84  
49-2701 90757-79A Left 1979-84  
49-0025 Set Right & Left 1979-84

**Gaskets**

15-0580 90633-82A Both Late 1980-92

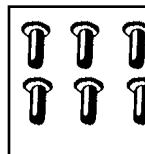

**Fiberglass Saddlebag Rivets**, pack of 50.

**VT No. OEM Length**  
37-0566 90965-63 5/16"  
37-0567 90966-67 1/4"  
37-0568 90967-64 3/8"

**VT No. 37-0545** Spacer Set to fit Saddlebags with luggage rack (A) Saddlebag tops sold each. Direct replacement for 1970-78 models. Can be used on 1979-80 models with hinge kit 49-2506.



**1964-67 Chrome Saddlebag Rail Kit** includes right and left rails. Mounting kit is available separately.

**VT No. Item**  
49-2502 Complete Rail Kit  
37-0874 Mounting Kit





# Saddlebag Set



## Loctite Style



**Loctite Saddlebag Sets** recreated as on 1946-48 models, include chrome plates to fit all rigid frames. Replaces 11785-43 in heavy black leather with orange rosettes. Unique design lid keeps bags closed and in shape. Measure 16" L x 5" W x 14" H.

**VT No. 48-3156**

## 1936-37 Big Twin



48-3146

## 48-0317



**Black Trim Bag Sets** are recreated with piping as the factory accessory of the 1940's. Rigid frame sets fit Big Twin 1936-57. Swing arm sets fit 1958-76 FLH. Heavy leather construction and stitching, includes chrome spoons, spots, heavy buckles and stainless steel mounting plates.

VT No.	Year	Trim
48-3146	1936-57	Black
48-0317	1936-57	Red



## Speed King

**Speed King Saddlebag Set** recreated in black leather featuring bright speed-ball wing emblems with chrome angle buckles and black piping. Available with chrome steel mounting plates for Rigids 1936-57. Rigid bags require 8205-8 mount kit. **VT No. 48-3151**



48-3144

**1936 Style Knuckle Saddlebag Sets.** Conchos and a five strap closure decorate these bags which are restoration quality for all 1936-46 Rigid. Include chrome mounting plates. Measure 14 $\frac{3}{8}$ " length x 5" width x 12" height.

**VT No. Color**

**48-3121** Black

**48-3144** Brown



48-3120

**Black Leather Saddlebag Sets** is complete with chrome mounting plates, for rigid or swing arm mounting, conchos, fringe and chrome rivets. Bags are suited for a later 1950's restoration or for a nostalgic late model dress up on 1936-57 Rigid models. Measure 19" long x 5" width x 12" height.

**VT No. 48-3120**



48-0176

48-0189

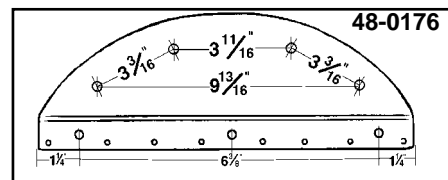

48-0176

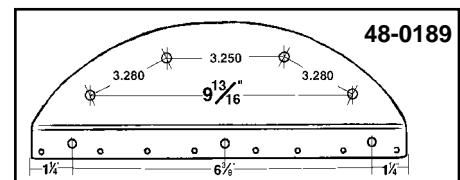

48-0189

**Saddlebag Mounting Plates** are chrome for 1936-57 rigid rear fenders, exact stamped as original. Order chrome acorn mounting bolts separately.

**VT No. Type**

**48-0176** Mount Plate Set

**48-0189** Mount Plate Set

**8205-8** Bolt Kit



**Saddlebag Mount Bars**  
include four bar sets with stan-  
tions.  
VT No. 2634-12T



**Saddlebag Plate Rail Set.**  
VT No. 50-1562



**Krommets** are available in traditional gold, chrome type or 10 point, 10 pack, 1/4" - 20 thread.

- |               |   |
|---------------|---|
| <b>VT No.</b> | <b>Item</b>                                   |
| 37-1954       | Star Washer                                   |
| 37-0869       | 1 3/8" Outer Diameter Rubber Washer for Above |
| 37-0503       | Chrome Rocket with Fins                       |
| 37-0501       | Chrome Krommets                               |
| 37-0502       | Gold Krommets                                 |
| 48-0074       | Chrome Star, 5 pk                             |
| 48-1433       | Chrome Concho                                 |

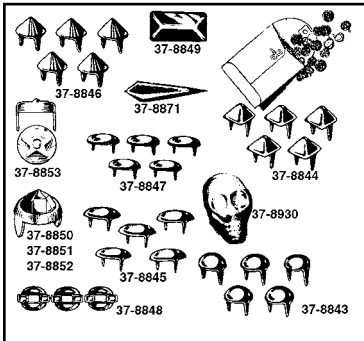

**Bright Nickel Spots.**  
Original styles of the 1940's to dress up riding belts, saddlebags, seat skirts, leather or vinyl. All shapes have two fastening tabs for mounting. Order the hand spot tool for exact spacing and ease of installation. Dealer packs of 50 pieces per type except VT No. 37-8930 sold as pack of 10.

- | Bright Nickel Spots. | VT No.  | Size  | Shape         |
|----------------------|---------|-------|---------------|
|                      | 48-1196 | 5/8"  | Flower        |
|                      | 37-9299 | 1/4"  | Round         |
|                      | 37-8843 | 3/8"  | Round         |
|                      | 37-8883 | 7/16" | Round         |
|                      | 37-9036 | 1/2"  | Round         |
|                      | 37-9345 | 1/2"  | Round (Clear) |
|                      | 37-9346 | 1/2"  | Round (Pearl) |
|                      | 37-9037 | 3/4"  | Round         |
|                      | 37-8847 | 7/8"  | Round         |
|                      | 37-8844 | 3/8"  | Pyramid       |
|                      | 37-9038 | 1/2"  | Oval          |
|                      | 37-8845 | 5/8"  | Oval          |
|                      | 37-9039 | 3/4"  | Oval          |
|                      | 48-1893 | 5/8"  | Star, 5 pack  |



**Hand Spot Tool** replaces factory accessory tool 98930-46 to install spots evenly spaced.  
VT No. 16-0966



**Black Genuine Leather Conchos** feature nickel plated disc with leather tails. 5 pack. VT No. 48-0122

# Decoration



38-6674



38-6675



38-6676



38-6680



38-6555



38-0923

**Emblem Sets** attach to fender as original accessory, but can be mounted to fenders and saddlebags, sold as pair.

- | VT No.   | Finish | Type                     |
|----------|--------|--------------------------|
| 38-6674  | Nickel | Deluxe                   |
| 38-0923  | Chrome | Deluxe, each             |
| 48-1646  | Chrome | Deluxe 2.5"              |
| 38-6675  | Nickel | O.H.V. (Over Head Valve) |
| 38-6676  | Chrome | Hydra-Glide              |
| 38-6680  | Chrome | Duo-Glide                |
| 38-6555  | Chrome | Electra-Glide            |
| 37-8842* | —      | Speed-Nuts, 10 pack      |

\*Note: For VT No. 38-6680, 38-6673 and 38-6671



**Nickel Spoons** for dress up or replacement on saddlebags. Sold in pairs.  
VT No. 37-8927



**Speed Ball Wings** are polished stainless steel as original, attaches to leather by prong tabs or studs.

- | VT No.  | Type          |
|---------|---------------|
| 48-0031 | Tab Type      |
| 48-0032 | Stud Type     |
| 48-1647 | Stud, Mini    |
| 48-0932 | Cast Wing Set |



**Skull Krommets** feature LED eyes, pair.

- | VT No.  | Color           |
|---------|-----------------|
| 33-0856 | Amber           |
| 33-0857 | Red             |
| 37-9076 | Chrome (no LED) |
| 37-9077 | Gold (no LED)   |



48-1656



**Deco 2" Set** with stud back.

- | VT No.  | Item                     |
|---------|--------------------------|
| 48-1656 | Star                     |
| 48-0133 | Silver Dollar 1921 style |



48-0133

48-0133 Installed



**Star Stud** with stud back.

- | VT No.  | Item              |
|---------|-------------------|
| 48-1893 | 5 pieces, small   |
| 48-1652 | 3.75" large, pair |





# Replica Windshield



**Beaded Windshields** fit 1960-84 FLH Wide Glide forks. Lower window can be changed to Hydraglide style by purchasing 51-0267 window separately to fit 1949-59 models with chrome 7" headlight. Purchase of bracket kit 31-9953 may be necessary if the FL is not already equipped with spotlamps

VT No.	Color of Lower	Type
51-0279	Clear	Assembled
51-0257	Clear	National
51-0303	Black	National
51-0267	Clear	Lower Windshield Window



**1949-59 Replica Windshield** for Hydraglide features pointed beaded edge top, unit fits Big Twin with Hydraglide tins, fork covers and 7" chrome headlamp. Top replaces 58020-49 for all Police style windshields and fits VT No. 51-0303, 51-0257.

VT No.	Item
51-0238	Shield, Assembled
51-0268	Top Only
49-0167	Bracket Set, 1960-84



## Products Installed on FLH Model Replica.

VT No.	Item
24-0501	Cowl Kit Polished
24-0500	Cowl Kit Chrome
33-2028	Spotlamp Kit

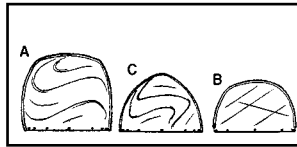

**Adjustable Windshield** fits 1960-84 FLH type.

VT No.	Color	Brand
51-0264	Clear	V-Twin
51-0310	Black	National

## Luggage Rack



**Chrome Tour Pack Luggage Rack** includes mounting hardware. Fits 1965-70 FL. Measures 10" x 7" x 2".  
VT No. 50-2048



**Beaded Top Shield Only.** Available as short type, 1949-up FL or taller type stock for fairing.

VT No.	#	OEM	Height
51-0270	A	58164-69	Tall-18", Fairing
51-0269	B	58020-49A	Short-15", Shield
51-0268	C	58020-49	Short-15" Shield with peak

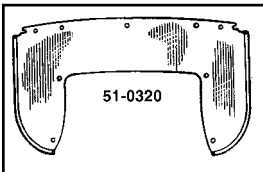

**Lower Windshield.** Adjustable type, stock replacement for all 1960 and later beaded windshields by National Cycle.

VT No.	Type
51-0320	Clear
51-0318	Black



**Cigarette Lighter** for Glide models fits 1949-59 FL stock riser top cap studs.  
VT No. 32-1725



48-0582



48-0583



48-0812



48-0813

**Replica FLH Windshield Bag.**  
**Gold Trim Silver Trim Color**  
 48-0582 48-0812 White  
 48-0583 48-0813 Black



**FLH Windshield Pouch.**  
 Windshield bag. Heavy oily leather, glued, sewn, riveted. Black, 9" x 3" x 6".  
**VT No. 48-3125**

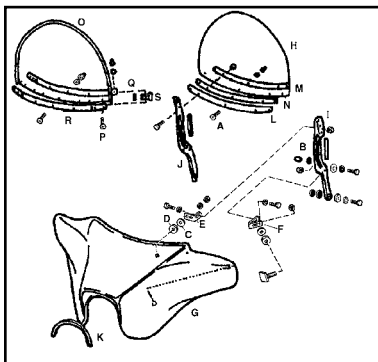

**Chrome Windshield Trim**  
 fits Big Twin shields on fairing models. Utilizes stock mounting hardware. Foam backed to prevent scratching shield. Fits Late 1977-85 FLH not FLT.  
**VT No. 42-0339**

**Fairing and Hardware Lexan Type for 1969-84 FLH.**

VT No. #	OEM	Item
37-0678	D 6261	Neoprene Washer
51-0271	H 58181-78	Lexan Windshield only
<b>For Beaded Type</b>		
51-0270	O 58164-69	Beaded Shield
9201-33	P Kit	Mount Bolt Set
31-3985	S 58048-50	Clamp Windshield Molding
51-1281		Brace Set

## Windshield for FLH



51-0271 Installed



51-0271



51-0270

**FLH Replacement Screens** fits 1969-84 FLH with fairing 4 or 5 Speed.

VT No.	Type
51-0271	Clear 18"
51-0272	Tint 18"
51-0274	Tint 7"
51-0270	Beaded 18"

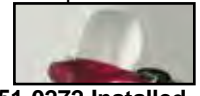

51-0272 Installed



51-0274 Installed

**Universal Windshield.**  
**VT No. 51-0291**



**Chrome Windshield Mount Kit** fits 1949-84 FL.  
**VT No. 31-9933**



**Chrome Wind Deflectors**, mount onto fork brackets. Fits 1960-84 FL. Replaces 58123-77. **VT No. 50-1007**



31-9953



49-0167



49-0170



31-9955

**FLH Shield Hardware** includes 58107-60, right and left extension, 58095-49 R, 58096-49 L fork brackets, for mounting shield on all 1949-up Glide forks. If spot light brackets are installed, 58095-49 R, 58096-49L must be omitted (4 pc kit).

VT No.	Year	Item
49-0167	1960-84	Complete Kit, 4 piece
31-9953	1949-59	Complete Kit, 4 piece
31-9954	1949-84	Pair
49-0170	1949-59	Extensions, pair
31-9955	1960-84	Extensions, pair
37-8793	1949-84	Mounting Hardware



9200-33

**Windshield Hardware Bolts** feature chrome acorn nuts and Phillips screws to secure FL Beaded and Lexan Police shields. Stainless molding clamps are a longer version to attach top to center of beaded shields, replaces 580408-50.

VT No.	Item	U/M	Type
31-3985	Clamps	Pair	
9200-33	Screw	Set	Chrome
9201-33	Screw	Set	Cad



31-3985

## Windshield for Spring Fork



49-0250



49-0858

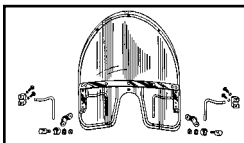

**1936-57 Spring Fork Clear Windshield Complete** includes zinc plated fittings for mounting to handlebars. Mount kit is included with shield.

VT No.	Item
49-0250	Shield Complete
49-0257	Top Shield and Lower
49-0264	Top Shield Only
49-0858	Clamp Set Only



49-0251



49-0262



49-0265

**Summer Windshield** for Spring Fork models 1936-48, includes lower apron as noted. Replaces 11292-36. Includes zinc plated clamp set for mounting to handlebars.

VT No.	Type
49-0251	Black
49-0262	Army
49-0265	Silver





**national  
cycle**

# Windshield



**Deflector Screen LX.** Features Rake Adjust and Quickset hardware. Super tough Lexan hardcoated polycarbonate. Light or medium tint. DOT and TUV approved. Hardware packaged with windshield.

**VT No. 51-0244**

Medium Tint

**VT No. 51-0245**

Light Tint

**Size:**

**H:** 14 $\frac{3}{4}$ "

**W:** 15"

**Fits all:**

1970-85 FX  
1960-84 FLH  
1977-83 FLHS



51-0243

**Flyscreen LS.** Small windshield with a very custom appearance. Triple chrome front plate. Flush counter sunk hex bolts. Light Tint. DOT and TUV approved. Approved for night use. Hardware packaged with windshield.

**VT No. 51-0243**

**Fits all:**  
1970-85FX  
**Size:**  
**H:** 8 $\frac{1}{2}$ "  
**W:** 9.75"

# Streetshield

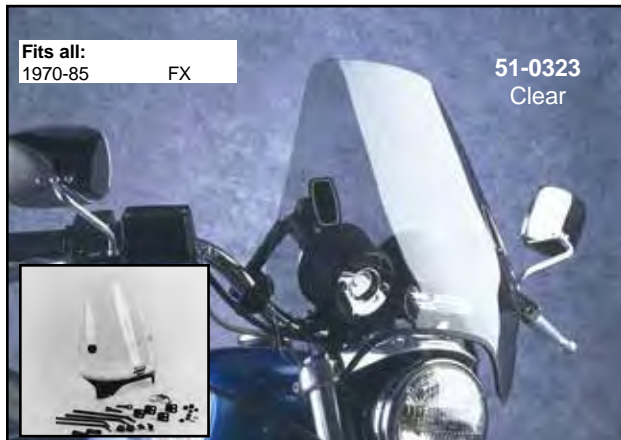

**Fits all:**  
1970-85 FX

51-0323  
Clear



**Chopped Heavy Duty.** Wide screen look with low profile. A preferred choice for many.

**Size:** H: 14 $\frac{1}{2}$ " to 17 $\frac{1}{4}$ " W: 22 $\frac{1}{2}$ "

**Light Tint, DOT and TUV approved. Approved for night use. Hardware sold separately.**

**VT No. 51-0301 Mount**

**Kit Required**

**Fits all:**

1960-84 FLH

**VT No. 51-0302**

**Fits all:**

1977-93 FLHS

**31-9933**

**Mount Kit Required**

**31-0438**

**Streetshield.** Contoured to enhance wind protection. Features 4 point ball socket mount.

**Size:**

**H:** 17"

**W:** 16 $\frac{1}{2}$ "

**DOT and TUV approved. Hardware packaged with windshield.**

**VT No.**

**Color**

51-0323

Clear

51-0324

Smoke



**Streetshield Ex.** Features 4 point ball socket mount with Quickset hardware.

**Size**

**H:** 18"

**W:** 19 $\frac{1}{4}$ "

**DOT approved.**

**VT No. 51-0325** Smoke

**Fits all:**

1970-85 FX

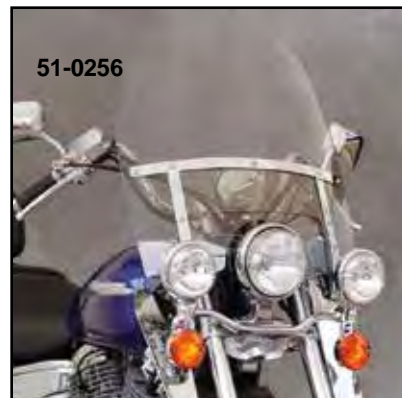

51-0256



51-0256

**Touring Heavy Duty** for 1960-84 FLH.

**Size:** H: 19 $\frac{1}{2}$ " to 22 $\frac{1}{2}$ " W: 22 $\frac{1}{4}$ "

**Light Tint, DOT approved. Approved for night use.**

**Hardware sold separately.**

**VT No.**

**Fits**

**Mt Hardware**

51-0256

1960-84 FLH

31-9933

51-0248

1980-84 FXWG

31-9931

51-0242

1984-up FXST

31-9932



# Replica Spring Fork

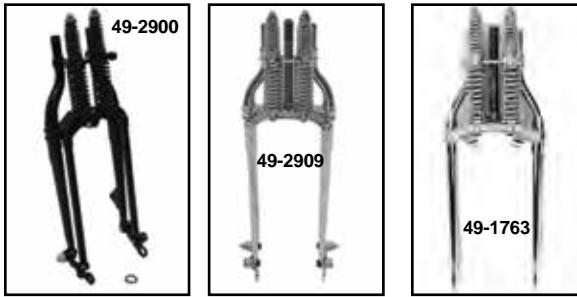

74" Offset Style



49-2407



49-2413

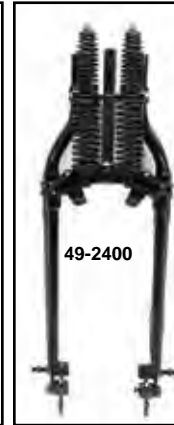

49-2400



OAL

49-2420

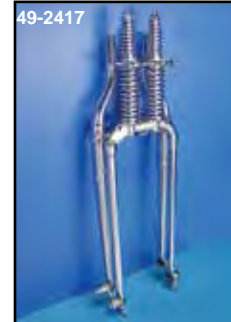

49-2417



49-2400



49-0062



45" Inboard, with 3/8" axle holes

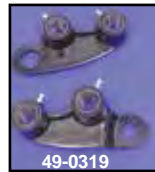

49-0319

Note: Big Rockers have offset rocker on the right side.

## Big Twin

Complete Assemblies, Big Twin.

Black	Chrome	Type
49-2900	49-2909	Inline
49-2407	49-2412	Offset
49-2408	49-2410	Inline 2"
49-2420	49-2417	Inline 4"

45" has same rockers on each side, with the small 3/8" hole.

49-2400, 45" Style for 1930-52 has inboard rockers which accept a 3/8" axle

- Forks will accept all original style components and accessories for the detailed replica look.
- These forks are replicas of the stock units with electric welded and brazed construction.
- The chrome units are unpolished at the rear fork stem cross plate and at the front spring fork rod forging.
- Note OAL measurement points.

## 45"

Powder Black	Full Chrome	Model/Type
49-2400	49-2413	Solo 45"
49-2415	49-2416	Solo 45-XA, 2"
49-2402	49-2414	Trike, 45 Servi-Car
49-2606	49-2512	Fender and Horn Bracket 2"
49-1762	49-1763	45" without rockers

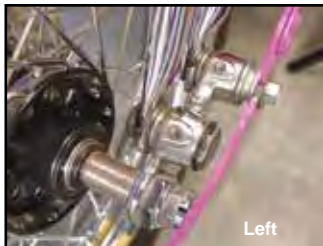

Left



Right

Note: Big Twin forks have offset rockers on right side.



49-2422

36"



49-2430

Components for extended forks with rake.

VT No.	Item	Type
49-0676	Long Rocker Set	Chrome
37-1016	Riser Stud	1/2 - 13



Longer Rocker Detail



**Spring Fork Assembly** includes a full set of springs (inner and outer), front and rear legs, rocker set studs and bushings, and spring rods with bushings. Chrome unit has both front and rear legs in chrome and also chrome springs and rockers. Top clamp, neck races and cone nut not included. Units feature 1" inline stem and outside rockers which utilize interchangeable star wheel with lug bolt type brake drum and mechanical front brake drum. Overall length top to axle as noted. 36" and up lengths have built in 3° rake. Black units have chrome springs and black rockers. (Stock springer fork length is 28").

Chrome	Black	Length	Chrome	Black	Length
49-2410	—	30"	—	49-2950	28", Offset
49-2417	49-2420	32"	49-2955	—	28", Offset
49-2422	49-2478	36"	49-2401	—	28", Front
—	49-2427	40"	49-2406	—	28", Offset, Black Rear Leg
—	49-2428	44"	—	—	—
—	49-2429	48"	—	—	—
—	49-2430	52"	—	—	—
Offset	—	—	—	—	—
49-2431	—	36"	—	—	—





# Spring Fork Legs



49-0830



23-1207

**Lug Bolt Kit** includes 5 lug bolts and "T" wrench.

**VT No. Lugs**

49-0830 Parkerized

23-1207 Chrome



**Springer Brake Kit.** Early style with finned brake drum. Exact for 1938-39 UL and EL.

**VT No. 22-0740**



**Wheel Cover Set** for glide fork applications on a 16" star hub wheels with brake drum.

**VT No. Fits**

49-0299 1949-66 FL

Front

49-0291 1941-48 FL



37-8675



23-0440



37-8691



37-8919



49-0457



23-0090

**Wheel Lug Bolts** for brake drums. Use tap 16-0807 for  $\frac{3}{8}$ " — 20.

Black	Chrome	OEM	Years	Fits
37-8675	23-0440	43530-35A	1936-72	$\frac{3}{8}$ " — 20
37-8691	—	43530-35A	1936-72	$\frac{3}{8}$ " — 20
—	37-8919	43531-35	Oversize	$\frac{7}{16}$ " — 20
49-0457	—	43531-35	1936-37	$\frac{3}{8}$ " — 20
23-0090	—	43631-35	1936	$\frac{3}{8}$ " — 20

786

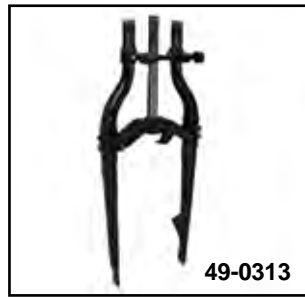

49-0313



49-0342

**Inline Fork Legs** fit 1936-52 45" and 1936-48 Big Twin models.

**Rigid Rear Springer Fork Leg**

Black	Chrome	Fits
49-0384	49-0386	1941-45 Big Twin
49-0313	—	1940-57 45 Solo
49-0388	49-0342	1940-57 45 Solo



49-0408

**Front Springer Fork Leg.**

Black	Chrome	Fits
49-0408	49-0409	Spring Fork w/Rods, Big Twin
49-0332	49-0343	45" Front Leg
49-0421*	—	Stud Hole 45"/74" Adapters
7707-4	—	Spring Rods, pair
49-0337	—	45 Servi-Car Rear Leg Inline

\*Note: Allows installation of Big Twin Rockers on 45" fork.



49-1172



49-1312

**Spring Components.**

VT No.	Item
49-1312	Fender Mount Tab
49-1172	Sleeve Set
49-0029	Front Tubes, Raw
49-0051	1" Stem
49-0374	7/8" Stem for 45"



**Brake Tab** fits 1936-57 Spring Fork. Must be welded on.

**VT No. 49-2655**



**Spring Fork Front Brake Anchor Stud Kit**

includes raw steel stud and parkerized adjuster screw. Brake cable anchor stud for front backing plate was used until 1940 on Knucklehead VL, UL, RL, and WL 45". You can also use this stud to make a 1941 and up backing plate into an early style backing plate. Must be peened over or welded into place after installation.

**VT No. 49-1742**

# Shock and Ride Control



49-1942

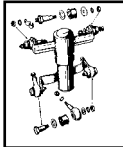

49-1954

**Replica Spring Fork Shock Assembly** replaces 54200-45, includes all shock and mounting hardware for 1946-57 Spring Fork.

**VT No. Item**

- 49-1942 Complete Kit, Black
- 49-1313 Shock Only
- 49-1954 Replica Hardware Only
- 49-1775 Weld On Brackets
- 28-1951 Bushing set (14002-45) 4 pieces
- 49-0241 Loom Clip (9973)



49-1313



49-1985

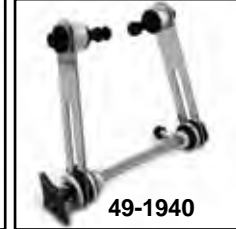

49-1940

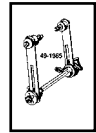

**Replica Ride Control** is reproduced as original to control the action of the Spring Fork. Features steel side bars with black control knobs. Replaces 11250-36 on 1937-48 61", 74" and 80", 1940-57 45" models.

VT No.	OEM	Item	Bars
49-1985	11250-36	Complete Unit,	Chrome
49-1940	11250-36	Complete Unit	Stainless
49-1775		Bracket Set	Raw Steel
49-0139	13440-33	Includes the following:	
	13444-33	Knob, Collar and	
	13442-33	Spring Clip	

49-1680 Strap Set Stainless

49-0140 13431-33 Friction Disc (4 pack)

49-0142 54051-33 Rubber Bushing (2 pack)

49-1678 Kit Rebuild

## Fender



50-0176

**Chrome Billet Fender Clamps** will mount 50-0176 fender to spring forks with 1" outside diameter front leg.

**VT No. Item**

- 50-0176 Fender
- 31-0864 Clamp Set, 1"
- 31-0861 Clamp Set, 3/4"
- 31-1009 Clamp Set, 1"



31-0861



**Spring Style Front Fender** fits 18", 19", and 21" wheels. Brackets must be fabricated.

**VT No. 50-0780**



49-1675



49-1677

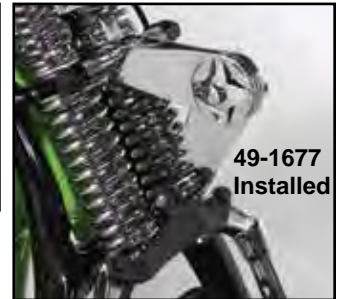

49-1677 Installed



49-1557

**Scissor Type Fork Damper** fits 1936-48 Spring Forks on Big Twin and 45".

**VT No. Item**

- 49-1675 Parkerized Scissor
- 49-1677 Chrome Scissor
- 49-1554 Mount Kit
- 49-1557 Bracket
- 49-1577 Kit Parkerized
- 49-1563 Chrome Kit

**Front 3/4" Axle** fits 1936-57 Replica Spring Forks or OE Big Twin with offset rockers.

**VT No. Item**

- 44-0752 Axle
- 44-0307 Nut



49-1554



44-0752

**Grease Fittings. Special thread.**

VT No.	Year	Type	U/M
8770-6	1909-38	Nickel	6 pack
49-0595	1909-38	Nickel	10 pack
44-0533	1938-up	Zinc	10 pack
9864-6	1938-84	Cadmium	6 pack
9897-6	1938-84	Chrome	6 pack
44-0558	1938-up	Nickel	10 pack
37-0511	1938-up	67.5°, Zinc	5 pack
37-0521	1938-up	90°, Zinc	5 pack
49-0636	1936-38	Straight	10 pack
49-0637	1936-38	67.5°	10 pack, white zinc
49-0688	1936-37	90°	5 pack
49-0628	1936-38	Straight	Each
49-0629	1936-38	67.5°	Each
49-0687	1936-38		20 pieces



44-0533



37-0511



9929-1T

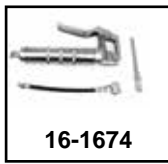

16-1674

**Flat Top Alemite Grease Fitting Adapter** is designed to be used on alemite grease fitting, 0340. Tapped 1/8" NPT to use with standard grease gun.

**VT No. Brand/Item**

- 9929-1T VT/Adapter
- 16-0594 500 CC Oil Can
- 16-1674 Kit



16-0594



**Springer Fork Rod Shock Set** fits 1944-48 BT.

**VT No. 49-0498**





# Spring Fork

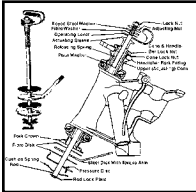

**Steering Damper** for Spring fork, available as a complete kit with all items illustrated or a component parts.

VT No.	OEM	Year/Model	Item
49-1955	2776-36	1937-40 Big Twin	Complete assembly
49-1951	46700-41	1940-45 Big Twin	Complete assembly
49-1952	46700-46	1946-48 Big Twin	Complete assembly
49-1953	46701-40	1940-57 45"	Complete assembly
49-1700	46717-30	All Models	Steel disc
49-0607	46717-30	All Models	Steel disc, cadmium
49-1701	46727-30	All Models	Fibre disc (2 pieces)
49-1702	46746-30	All Models	Adj nut
37-0709	7789	All Models	Lock nut, 5 pack
49-1716	46755-36	All Models	Lever chrome
49-0059			1" Stem
49-1704	46757-36	1941-48 BT	Stem screw
49-1705	46758-37	1940-57 45"	Stem screw
49-1706	46758-40	1940-57 45"	Bracket
49-0026	46758-40	1940-57 45"	Bracket, Cadmium
49-0049	2792-36	1936-40 BT	Bracket, Parkerized
49-0024	2792-36	1936-40 BT	Bracket, Cadmium
49-0362	2792-36	1936-40 BT	Bracket, Zinc
49-0863	46760-41	1941-45 BT	Bracket, Cadmium
49-0864		1946-48	Bracket, Cadmium
49-1708	46760-46	1946-48 74/80"	Bracket, Parkerized
49-1709	46765-40	1940-57 45"	Rod
49-1719	2779-36	1937-40 BT	Rod
49-0512	2779-36	1937-40 BT	Rod, Cadmium
49-1710	46766-41	1941-45 BT	Rod
49-0513	46766-41	1941-45 BT	Rod, Cadmium
49-1711	46766-46	1946-48 74/80"	Rod
49-1712	46775-30	All Models	Adj washer, 5 pack
49-1713	46777-30	All Models	Release spring
49-1714	46779-30	1930-48 All	Fibre washer
49-1715	88936-18	1930-48 All	Spider washer, 5 pack



## Damper Rod Handle Kits.

VT No.	Year	Handle
2584-7	1936-47	Chrome
2585-7	1937-52 45"	Parkerized
	1953-57 Solo	Parkerized
49-0732	1936-47 BT	Chrome
49-1505	1936-57 BT	Chrome



## Damper Handles.

VT No.	Fits	Finish
49-0517	1937-42	Chrome
49-1503	1937-42	Parkerized
49-1716	1943-48	Chrome
49-0538	1936	Chrome

# Hub Cap



49-1924 Installed

**1936-48 Big Twin "Atlas" Hub Cap** is of alloy construction and acts as a hub cap and axle spacer.

VT No.	Type	Finish
49-0968	Right Side	Alloy
49-0977	Right Side	Chrome
49-0973	Left Side	Chrome
49-1924	Left and Right	Chrome



**8" Spring Fork Hub Cap** in chrome, replaces 43000-48. Fits all 1936-48. Fits all 1936-48 74", 1941-57 Servicar front wheel.

VT No. 49-1998

49-1998 Installed



**Springer Dress Up Kit** includes a top "bridge" with 2 chrome cap nuts and a 4 piece spring cover set.

VT No. 49-1330



**Chrome Springer Spring Cover Set** fits 1936-57 forks. Includes four piece set for upper and lower.

VT No. 49-2651



49-2651 Spring Covers Installed



**Chrome Spring Covers** available to fit upper and lower springs and rocker studs on Big Twins. Order as required for 1936-57 Spring Forks.

VT No.	Type	Style	U/M
49-2564	Rocker	Tear Drop	2
49-2565	Rocker	With Bird	2



# Spring Fork Stud

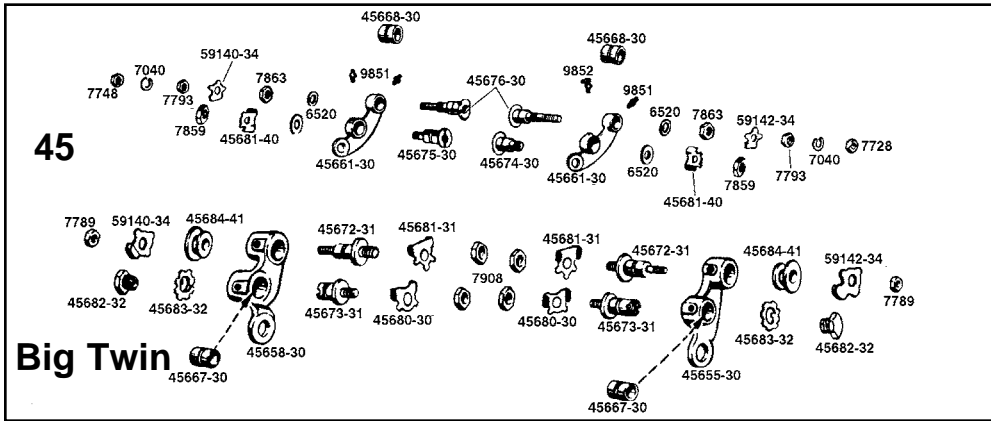

**Fork Rocker Rebuilding Kits** include the components shown except rockers, lock tabs, front and rear stud nuts and enough bushings from a complete rebuild of both rockers. All parts are interchangeable with original factory hardware.

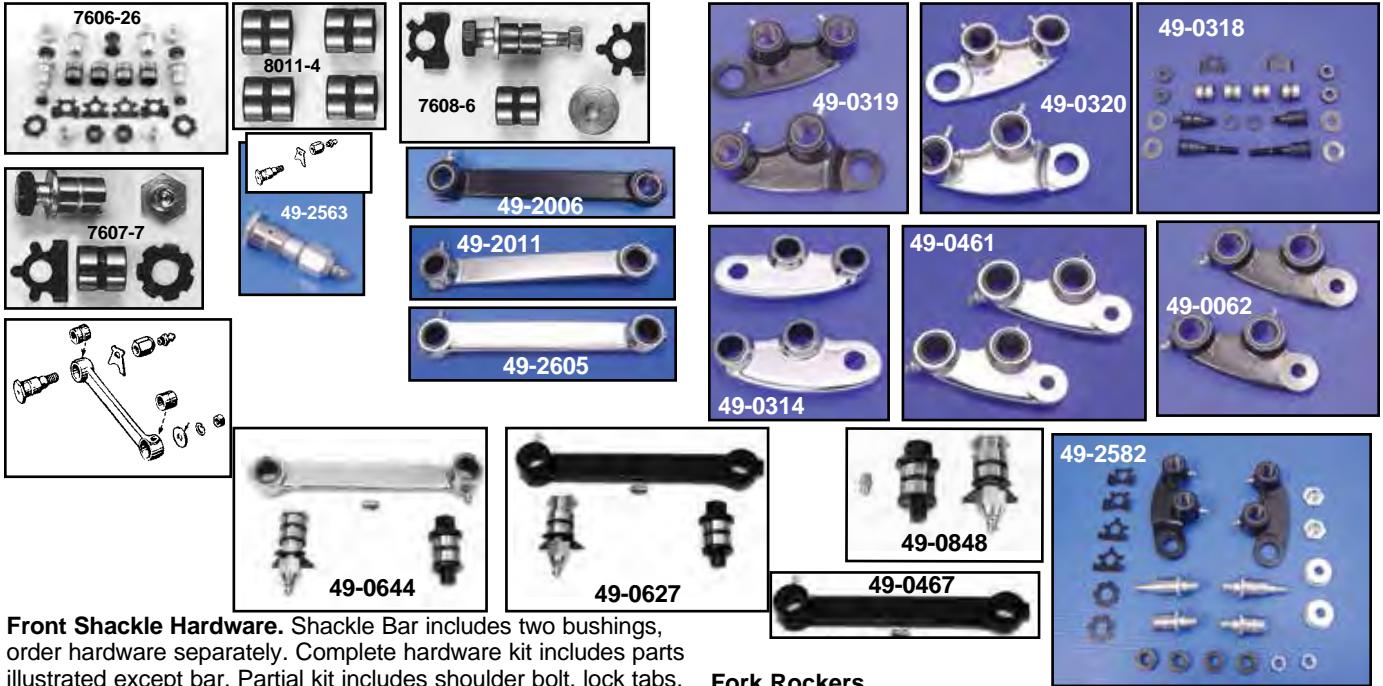

**Front Shackle Hardware.** Shackle Bar includes two bushings, order hardware separately. Complete hardware kit includes parts illustrated except bar. Partial kit includes shoulder bolt, lock tabs, and special nut/grease fitting only.

VT No.	Item	Fits	Finish
49-0467	Shackle Bar	1936-38 BT	Black
49-2006	Shackle Bar	Big Twin	Black
49-0627	Shackle Kit	1941-48 BT	Black
49-0644	Shackle Kit	1941-48 BT	Chrome
49-2011	Shackle Bar	Big Twin	Chrome
49-2605	Shackle Bar	45	Chrome
8010-10	Full Rebuild Kit	All	Cadmium
8010-10T	Full Rebuild Kit, Zinc	All	Zinc
49-0848	Shackle Bar Hardware Kit	1941-48 BT	-
49-2563	Stud w/Lock and Nut Kit	All	Zinc
37-9152	Lock Tab, 5 pack	All	-
49-2012	Bushing, pair	All	-
49-1742	Anchor Stud		

### Fork Rockers.

VT No.	Item
7606-26	Complete Hardware Rebuild Kit
	1941-57 Servi-Car, 1941-48 BT
49-0235	As Above, by V-Twin, less bushings
7608-6	Rear Rocker Stud Kit
7607-7	Front Rocker Stud Kit
7610-4	Bushing set four 4 piece, (45667-30)
7610-4T	Bushing set four 4 piece, (45667-30)
49-2582	Rocker Kit, Black
49-2745	Rocker Kit, Chrome
49-0319	Rocker Set 45655-30, (45658-30)
49-0320	As Above, Chrome
7609-6	Lock Tab Kit, 6 pc.
49-0571	Lock Tab Kit, 6 pc.
49-2584	45684-41 Spacer
2913-2	Spacer, Parkerized
2914-2	Spacer, Cadmium
49-2635	Locktab Front Rocker Stud



### Rebuild Kit for Shackle Bar for Spring Brake.

VT No.	Year	Model
49-0848	1936-57	Big Twin
8010-10	1939-57	Big Twin
8010-10T	1939-57	Big Twin
2299-10	1936-38	Big Twin
2299-10T	1936-38	Big Twin
2651-10	1939	Big Twin and 45



**Spring Fork Rocker Bushing Remover-Installer Tool** will replace stock steel bushings on 1930-57 Spring Forks.

VT No. 7611-2

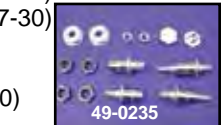

VT No.	Item
1930-52	45 Solo Model
49-0318	Kit Complete Hardware
9216-22	Colony, Kit
8011-4	Stud Bushing Set
8011-4T	Stud Bushing Set
49-0314	Chrome Rocker Set w/ 5/8" axle hole
49-0062	Rocker Set, Stock, (45661-30) black
49-0461	As Above chrome
49-0335	As Above with Studs, black
9019-2	Lock Tab
49-0460	Stud Set (Solo)
2773-1	Shackle Fitting





# Spring Fork

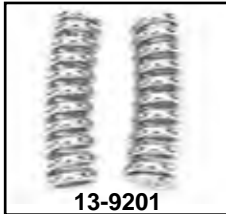
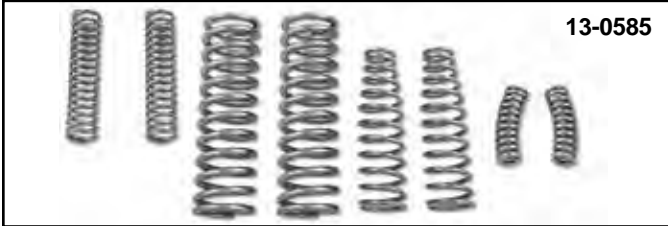

Spring Fork Springs fits 1937-57 45" and Big Twin.

### Outer Springs

VT No.	OEM	Finish/Type	U/M	Item
13-0585	Set	Chrome	8	Set
13-0589	Set	Parkerized	8	Set
13-1937	46055-30	Chrome Upper	2	Set
	46056-37	Chrome Lower	2	
13-0787	As above	Nickel	4	Set
13-1936	As above	Parkerized	4	Set
13-1944	1936-57	Parkerized	8	Set
13-1935	1930-36	Raw Set/VL	4	Set

### Inner Springs

13-1939	46059-39	Black Lower	2 Note (A)	Pair
13-9200	As above	Chrome Lower	2 Note (A)	Pair
13-0225	46058-36	Black Lower	2 Note (B)	Pair
13-0226	As Above	Chrome Lower	2 Note (B)	Pair
13-1968	46057-30	Black Upper	2 Note (B)	Pair
13-9201	As above	Chrome Upper	2 Note (B)	Pair

Note:(A) Long type for side car and servi-car. (B) Feature bend to prevent rattle.

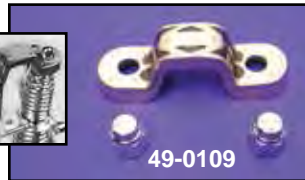

Spring Rod Stabilizer, includes two chrome cap nuts.

VT No.	Item
49-0109	Stabilizer, Brass
49-0993	Replica Stabilizer
49-0611	Cross Strap
8420-1T	Cap Nuts (Pair)
8420-1	Cap Nuts (Each)

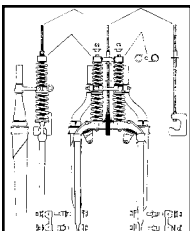

Spring Fork Assembly Clamp facilitates building of stock type forks by compressing upper and lower spring.  
VT No. 16-1003

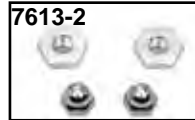

Spring Fork Acorn Nut and Retainer Set feature cadmium plated spring retainers and appropriate acorn nut finish.

VT No.	Year	Model	Finish
9417-4	1930-35	VL-RL	Parkerized
7613-2	1936-57	Big Twin and 45	Chrome
7613-2T	1936-57	Big Twin and 45	Chrome
49-0573	1930-57	All	Top Acorn Nut Kit
49-0516	1936-57	All	OE Type, Parkerized
49-0526	1936-57	All	OE Type, Chrome
49-0524	1936-57		Chrome/Zinc

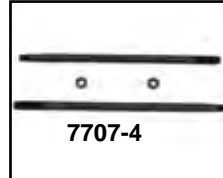

Spring Fork Rod Kit. Rods are heat treated for wear resistance and parkerized as original.

VT No.	Fits
9862-8	1931-36 VL
7707-4	1936-47 Big Twin and 45's



Spring Fork Rod and Bushing Set includes 2 rods 45614-36 with nuts and 2 bushings for 1936-57 Big Twin and 45 Springers.

VT No.	Item
49-2602	Kit
49-0473	Rod Set Only
49-0661	Top Nut Set
49-0570	Hex Nuts

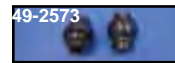

### 1946-57 Rod Bushings and Plate

VT No.	OEM	Item
49-2573	45643-45	Ball Bushing
49-2572	54230-45	Retainer Plate

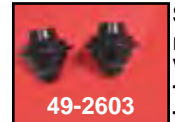

Spring Fork Spring Rod Bushings are replacements. Sold in pairs.

VT No.	Finish
7706-2	Cadmium
7706-2T	Cadmium
49-2603	Black
49-0393	Zinc



Early Spring Fork Rebuilds. Send us your early springer fork (pre1958) any model and we will rebuild it completely. Includes new bushings, studs, bearings, locks and washers. Rockers and powder coating available at an additional cost and spring inspection assessment done replaceable at an additional cost.

VT No.	Item
60-0190	Complete Spring Fork Rebuild
60-0191	As Above with New Rockers
60-0192	As Above with Powder Coating (Black Only) Strip/Phosphorize/Coat
60-0193	As Above with Powder Coating and New Rockers
49-0546	Rocker Stud Set



Square Springs. OE type springs wound with square wire with AEE chopper style!

VT No. 13-0960



# Spring Fork



**Complete Spring Fork Installation Kits** include plated neck cups, ball bearings, upper and lower races, nut with dust cover pressed on and top nut.

VT No.	Years	Model	Finish
24-0655	1939-57	45" and Servi-car	Zinc
24-0656	1936-48	Big Twin	Zinc
24-0661	1936-48	Big Twin	Chrome
24-1373	1939-57	Big Twin	Zinc
49-0034	1936-48	Big Twin	Cadmium

\*Note: Big Twins use 34 balls, 45" use 30 balls.



**Knucklehead Spring Fork Bearing Assembly** includes cadmium plated neck cup set, cadmium stem nut, nickel plated cone nut with integral upper race, lower race and balls.

VT No. 49-0034



**Spring Fork Conversion Kit** allows installation of 45" type small post rear forks to be installed on Big Twin 74" frames. Includes parts shown, available zinc and black oxide finish.

VT No. 49-0086

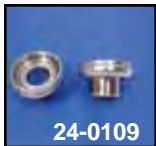

**Ball Bearing Neck Cups** available in pairs as cadmium plated cups only or chrome kit with races and ball bearings.

VT No.	OEM	Years	Use	Finish
24-0109	48311-36	1936-47	74" and 80"	Zinc Cups Only
24-1763		1936-47	74" and 80"	Raw
24-1780	Cadmium	1936-47	74" and 80"	Cadmium
24-0134	Kit	—	74" and 80"	Chrome
24-1078	Kit	1936-53		Parkerized

**Note:** Order neck cups separately.

24-0110	48310-30	1930-52	45"	Zinc Cups Only
24-0093	Kit	1939-57	45"	Chrome
12-0157	8860	5/16"	Balls	50 pcs
12-0128	8860	5/16"	Balls	30 pcs



**Ball Bearing Races** fit Big Twin Spring Fork and 1952-77 Sportster type, 1929-57 45's. Sold each.

VT No.	OEM	Years	Use
24-0099	48346-39	1929-57	Upper and Lower 45"
24-0100	48345-36	1936-48	Upper and Lower 74" and 80"
49-1507		1936-38	Lower
24-0638	Special	1936-37	45" Stem fits Big Twin
24-1078	45"	1929-57	Kit
24-1749	VL	1930-36	Race Set



**Lower Bearing Guard** centers lower race on stem.

VT No.	OEM	Fits
49-2000	48361-38	1936-48 Big Twin
49-2001	48363-40	1936-57 G 1936-52 W



## Spring Fork Stem Nut

Colony	VT No.	Finish	Fits
8484-1	8484-1T	Chrome	1936-48 Big Twin
8485-1	8485-1T	Cadmium	1936-48 Big Twin
9720-1		Parkerized	1936-48 Big Twin
8486-1	8486-1T	Chrome	1929-57 45"
8487-1	8487-1T	Cadmium	1929-57 45"
9713-1		Parkerized	1929-57 45"

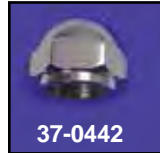

**Chrome Stem Nut.** The shoulder on its base fits into the top triple clamp for positive alignment.

VT No.	Fits
37-0442	Big Twin
7802-1	Big Twin, Colony
24-1459	Big Twin, Early Years
8008-1	45" Model, Colony
49-0059	Stem, BT
49-0028	Stem 45"



**Replica Spring Fork Cone Nut** is gear type with dust shield pressed on.

VT No.	OEM	Fits	Year
24-1415	2753-31	61"	1936 only
24-1370	Nickel		1936 only
24-1313	2753-36	74-80"	1937-39
24-0150	48327-36	74-80"	1936-47
24-0679	48327-36	74-80"	1936-47
24-0151	48335-40	45"	1940-47
24-1373	Kit		1936-48
24-0156	Conversion	45" to 74"	Nut, 7/8" thread
24-0638	Conversion	45" to 74"	Race Only



**Cone Nut Wrench** features pins to turn cog style cone nut 3/8" drive. VT No. 16-0178



## Tapered Bearing Conversion Kits.

VT No.	Years	Model
24-0230	1936-48	Big Twin
24-0245	1939-57	45" and Servi





# Spring Fork Top Tree and Riser

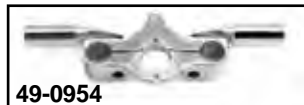
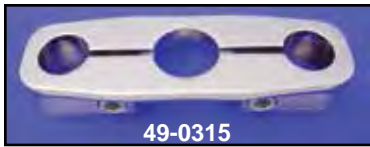

**Riser Station** fits Spring Fork top trees with 1" ears to allow rubber mounted glide riser to be fitted with 1 piece for handlebars.

- | VT No.  | Item                          |
|---------|-------------------------------|
| 25-2117 | 3" Glide Risers, chrome, pair |
| 26-2169 | Riser Posts, pair             |
| 37-8820 | Bolt Set, pair                |
| 25-1166 | 3.5" Offset Riser Kit         |
| 49-0093 | Inline Riser Kit              |



**Chrome Dog Bone Steel Paugcho Riser** is machined from solid steel.

- | VT No.  | Rise |
|---------|------|
| 25-2158 | 3"   |
| 25-2159 | 5"   |



**Flanders Triple Tree Kit** includes zinc plate tree and dog bones.

- | VT No.  | Item                       |
|---------|----------------------------|
| 49-0044 | Inline, brass 4" dog bones |
| 49-0997 | Offset, 5.5"               |

**Spring Fork Top Tees and Risers.** Order pinch bolts for trees separately.

- | VT No.  | Item                                  | Finish      |
|---------|---------------------------------------|-------------|
| 25-2217 | Dog Bone 5.5"                         | Chrome/Zinc |
| 25-0950 | Dog Bone Riser Kit, 5.5"              |             |
| 25-2219 | Dog Bones 3"                          | Chrome/Zinc |
| 25-2249 | Dog Bones 4"                          | Brass       |
| 25-2124 | Dog Bones 4"                          | Chrome      |
| 25-2253 | Dog Bones 4"                          | Cast Brass  |
| 49-0944 | Top Tree with Ears Inline             | Chrome      |
| 49-0939 | Top Tree with Ears Inline             | Zinc        |
| 49-0954 | Top Tree with Ears Offset             | Chrome      |
| 49-0955 | Top Tree with Ears Offset             | Satin       |
| 25-2127 | Flanders Risers 4"                    | Chrome      |
| 25-0785 | Flanders Risers 5.5"                  | Chrome      |
| 28-0910 | Flanders Rubber Bushing Set for Above |             |
| 49-0315 | Machined Tree without Ears Inline     | Chrome      |
| 49-0371 | Top Tree without ear Inline           |             |
| 9217-4  | Pinch Bolts                           | Chrome      |
| 9217-4T | Pinch Bolts                           | Chrome      |
| 9218-4  | Pinch Bolts, 6033-30                  | Cadmium     |
| 2749-4  | Pinch Bolts, 6033-30                  | Parkerized  |
| 9508-4  | Pinch Bolts                           | Parkerized  |
| 9508-4T | Pinch Bolts                           | Parkerized  |
| 2750-4  | Pinch Bolts                           | 1937-39 WL  |

*These solid brass risers start out as a raw forgings and generally have imperfection on the surface, like forgings voids or pits. These will dull with age, but can be re-polished to a high luster. Brass is soft so be careful, not to dent them with a wrench or hammer.*



**Screw In Riser Stud** installed by threading the I.D. of the upper fork tubes. Use  $\frac{3}{16}$  x 16 tap to thread top spring fork holes. Riser studs are  $\frac{1}{2}$  x 13 thread to accept riser and  $\frac{3}{4}$  x 16 to thread into fork.  
**VT No. 37-1016**  $\frac{1}{2}$  x 13

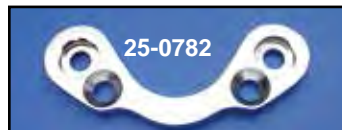

**T-Bar Clamp** is used in mounting handlebars with built in risers to custom Paugcho or Wyatt Gatling springers. Use on top of existing top clamp. For replica forks use with top tree 49-0371.

- | VT No.  | Item                  |
|---------|-----------------------|
| 25-0782 | T-Bar Clamp           |
| 25-0783 | Mounting Hardware Kit |
| 49-0043 | Kit                   |



**37-1016 Installed** by threading upper tubes on forks



**Riser Kit** Stud Set is installed by tapping top of fork with 20mm original tap. to mount top plate to Springers. install riser bars.  
**VT No. 49-0763**



**Chrome Top Tree** fits inline forks, allows use of post risers with  $\frac{1}{2}$ " mount bolts. Order acorn separately.  
**VT No. 49-0371** Top Tree  
**37-0442** Acorn Nut



# Riser



### 5 1/2" Dog Bone Kits.

- VT No. Type**  
**25-0800** Inline, Complete Assy  
**25-2255** Offset, Complete Assy  
**49-0997** Offset, 5 1/2" chrome risers  
**49-0093** Inline, 2 1/2" brass risers  
**49-0861** Inline Kit



48-1476



48-2289



### Stelling & Hellings.

- VT No. Style**  
**49-1927** Riser Set, Stainless Steel  
**49-1163** Offset Tree  
**49-0825** Inline Tee



### Stelling & Hellings Kits.

- VT No. Type**  
**49-0290** Inline  
**49-0289** Offset



### Stellings Riser Stems and Clamps

- | VT No.  | Height | Item                  |
|---------|--------|-----------------------|
| 25-1275 | 1 1/8" | Riser Stems           |
| 25-1753 | 3"     | Riser Stems           |
| 25-1751 | 5"     | Riser Stems           |
| 49-0489 |        | Brass Riser Tops      |
| 25-1253 |        | Bolt Set              |
| 25-1254 |        | Hex Type Bolt Set     |
| 25-0984 |        | 4" Flanders Riser Kit |
| 25-0361 |        | Nut Set               |



Forged

**Brass Risers are machined from forged shape billet. V-Twin Exclusive!**

*These solid brass risers start out as a raw forgings and generally have imperfection on the surface, like forgings voids or pits. These will dull with age, but can be re-polished to a high luster. Brass is soft so be careful, not to dent them with a wrench or hammer.*

### Flanders Risers.

- | VT No.  | Finish          | Size |
|---------|-----------------|------|
| 25-1271 | Brass, Polished | 3.5" |
| 25-1946 | Chrome          | 3.5" |
| 25-1755 | Brass, Polished | 2"   |
| 25-0944 | Brass, Polished | 5.5  |

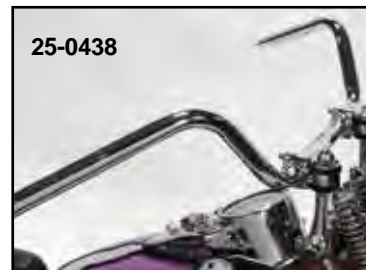

**Replica Style Bars.**  
 Original Buco style of the 1950's, for use with a dog bone style triple tree set up.  
**VT No. 25-0438**



**Flanders' Replica** of the fabulous 1950 accessories, use with dog bone trees and risers.

- VT No. Item**  
**25-0438** Bars 5 1/2"  
**25-0785** Riser Set  
**25-0800** Handlebar w/Flanders Risers and Dog Bone Tree  
**25-0834** Replica Flanders Handlebar, chrome





# Handlebar for Springer

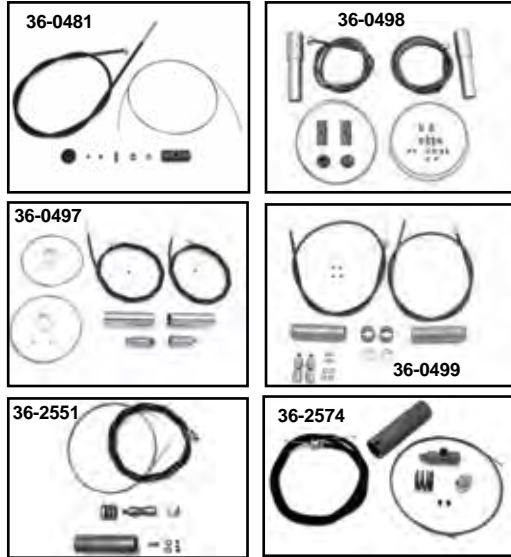
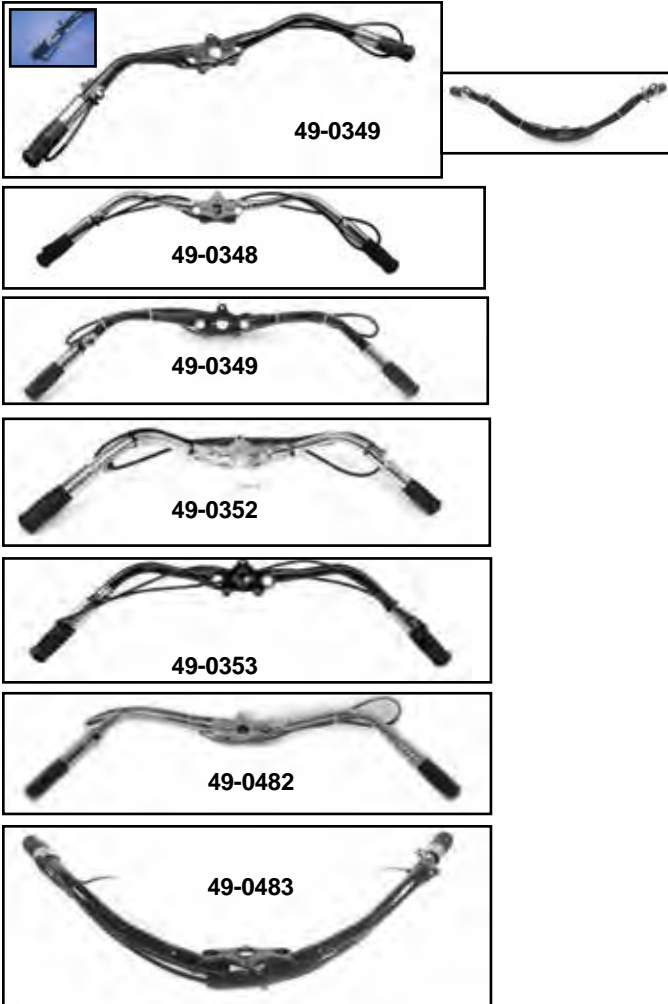

**Throttle Spirals and Cable Kits** include all internal parts for years listed. 1936-48 style features chrome spiral sleeves.

VT No.	Years	Sides	Throttle
36-0481	1936-48	2	None
36-0498	1936-48	2	Push
36-0497	1949-53	2	Push
36-0499	1954-64	2	Push
36-2551	1965-70	1	Push
36-2574	1971-73	1	Pull

36-0073 Inner Throttle and Spark Wire Set  
 36-0907 54" Replica Throttle Or Spark Cable  
 36-1457 Cable Kit for Throttle and Spark Controls



**Chrome Handlebar Cross Bar** includes stainless clamps to bridge most wide bars used on spring fork models. Replaces 56575-26.

VT No.	Item
49-0153	Kit
31-0530	Clamp Set Only
37-1969	Bolt Set



**Handlebar Cross Bar** fits 1936-57 Spring Fork bars. Features a curved bar made of 1" tubing with milled ends, which fit perfectly on the handlebars include 2 chrome clamps. An early aftermarket accessory originally by Atlas Products.

VT No. 49-2607

**Complete Handlebar Assembly for Spring Fork** is available with chrome or black finish. Units are fitted with all internal throttle components, including cables and grips, chrome horn and dimmer switches are installed with proper cloth covered wires.

VT No.	Finish	Type	Style
49-0090	Black	Inline	Speedster
49-0092	Chrome	Inline	Speedster
49-0348	Chrome	Inline	Speedster
49-0349	Black	Inline	Speedster
49-0352	Chrome	Offset	Speedster
49-0353	Black	Offset	Speedster
49-0482	Chrome	Inline	Buckhorn
49-0483	Black	Inline	Buckhorn

## Grip Sets



**1909-34 Vintage Style Grip Set** replaces the 1909 version 3310-09 for restoration on 1909-34, inner diameter 1 1/8" on both sides.

VT No.	Color
28-0104	Black
28-0105	White
28-0106	Red
28-0179	Grey
28-0481	Black



**Replica Short Stock Grips** replace 3310-35B. Fits 1935-48 with stock controls.

VT No.	Color
28-0101	Black
28-0102	White
28-0178	Grey



**Beck Handlebar Grip Set** features the original 1940's design for Spring Fork handlebars. Grips have an inner diameter of 1 1/8" on both sides.

VT No. 28-0480

# Spring Fork Handlebar

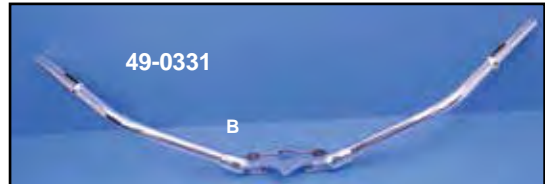
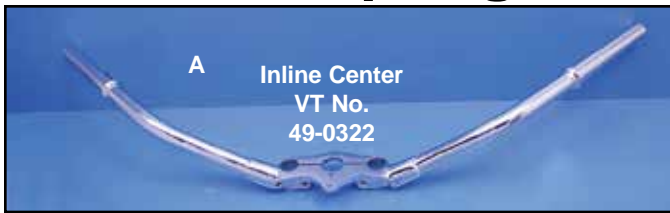

**Black Spring Fork Bars** feature 1" ends to accept late control handles.

**VT No. Style**

- 49-0897 Offset Black
- 49-0896 Offset Chrome

**Handlebar End Nuts.**

VT No.	Years	Type
9114-2	1910-21	Nickel Plated Hex
7625-2	1931-35	Oxide, Screw
7626-2	1936-48	Oxide, Screw
49-0957	1936-48	Parkerized, Screw
16-1262	1936-42	Tap



**Upper Head Cone Lock Plate** acts as lock and top tree cover, polished stainless steel has pin installed.

**VT No. Center**

- 49-0941 Inline
- 49-0942 Offset



**Spring Fork Triple Tree.** Raw for handlebars.

- 49-1024 Offset
- 49-1029 Inline
- 49-1104 Inline
- 49-0022 Black, without ears

**Spring Fork Handlebars** fit inline stem models 1936-57 45, 74 and 80 models, offset 1946-48 Big Twin. Available in black or chrome finish. Order pinch bolts and head cone lock plate as listed. See web for measurements.

**Chrome Black Type # Style**

49-0322	49-0321	Speedster	A-Inline
—	49-0510	Speedster	Brazed
—	49-0038	TT	Brazed Inline
49-0742	49-0741	Speedster	A-Inline
49-0762	49-0761	Speedster	Offset
49-0331	49-0330	Standard	B-Inline
49-0323	49-0324	Buckhorn	C-Inline
49-0484	49-0485	Buckhorn	C-Offset
49-0334	49-0325	Speedster	A-Offset
49-0327	49-0326	Buckhorn	C-Offset
49-0346	49-0345	Standard	B-Offset
36-0498	—	Internals	For Above
9217-4	—	Pinch Bolts	Chrome
9218-4	—	Pinch Bolts	Cadmium
9508-4	—	Pinch Bolts	Parkerized
9508-4T	—	Pinch Bolts	Parkerized



- 49-3461 Inline Speedster
- 49-3463 Inline Speedster

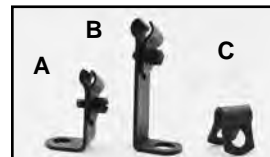

**Throttle and Spark Cable Brackets** have parkerized finish and mounting hardware as original.

**Overhead Valve (OHV)**

VT No.	#	OEM	Year	Model	Type
9005-4	A	3371-36	1936-48	OHV	Throttle
31-0537	E	56605-49	1949-53	OHV	Throttle
31-0973		Parkerized	1949-53	OHV	Throttle
31-0787			1948	OHV	Throttle
2041-7	F	45218-52	1968-72	OHV	Throttle

**Side Valve (SV)**

9006-4	B	3371-37	1937-48	SV Big Twin	Throttle
49-0553	—		1936-48	—	Clamp
9007-2	C	9967	1930-73	45"	Throttle & Spark
9008-5	D	55627-38	1930-48	SV Big Twin	Spark
2627-4		56626-37	1937-46	Big Twin	Spark
49-0533			1937-46	SV	Clip

Do you have the OEM number? Check our data base from over 15,000 part numbers referenced by Factory OEM numbers.

www.vtwinmfg.com





# Hollywood Bar

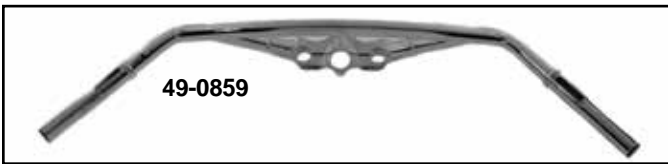
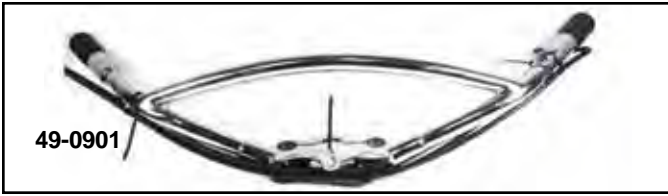

**Hollywood Handlebars** feature cross brace for added rigidity.

Black Bars	Chrome Bars	Type
49-0372	49-0860	Inline
49-0373	49-0859	Offset
Assembled		Type
49-0487	49-0901	Inline
49-0486	49-0902	Offset

# Brazed Bars for Springer



**Springer Handlebars** feature Speedster design as original with full brazed construction as the triple tree and throttle & spark collars.

VT No.	Type	Finish	Type
49-0017	Speedster	Black	NL
49-0015	1936 EL	Black	NL
49-0018	1936 EL	Chrome	NL
49-0013	1945-48	Raw	OS



**Bobber Fender** is 6" wide without holes. Order bracket to mount to spring fork rear leg tabs. Fits 1936-57 Spring Forks.

VT No.	Item
50-0883	Fender
50-1566	Bracket
50-1577	Kit

**Tracey's Bars** are taller than the Speedster as developed by John 'Jack' Tracey of Yonkers, New York in 1940's. Bars accept small Stellings throttle and spark spirals.

VT No.	Type	Size
49-0726	Inline	4"
49-0727	Offset	4"



**Raw Bobber Front Fender** is a bobbed shorter version of an OE fender. The fender is supported on top by Spring Fork rear leg tabs and lower rear brackets. Fits 1936-48.

VT No. 50-0474

# Flanders' Handlebar



**Replica 1" Spring Fork Flanders' Handlebar.**  
Fits 1941-52.  
VT No. 25-0823



**Flanders' Handlebar Kit** for Spring Fork models includes inline dog bone triple tree, triple tree cover, chrome 5.5" Flanders style risers. Features bars that are specially knurled in the proper position for Flanders risers. Fits 1941-52.

VT No. 25-0850



# Brake for Springer



**Spring Fork Front Brake Kit** includes cable end, shackle adjuster, cable, backing plate, brake shoes, springs, drum, lugs arm, cam, pivot stud and grease seal. Available in chrome or black finish. Fits 1936-57 Spring Forks with offset Big Twin Rockers and star hub wheel. Order brake handle, axle kit and hub separately.

VT No.	Item	VT No.	Item
22-1083	Chrome Kit	26-2134	Early Chrome Handle
22-1084	Black Kit	26-2126	Polished Handle
44-0581	Axle Kit	26-2127	Chrome Handle
22-0776	Black, Fin Kit		
22-0780	Chrome, Fin		



26-2126

**1936-48 Big Twin Dual Cam Brake Backing Plate** includes shoes, springs and arm assembly to fit stock spring fork front brake drum. Order drum separately.

VT No.	Finish
49-0852	Chrome
49-0853	Black
49-0464	Shoes
22-0987	Kit
13-0562	Springs



**Finned Brake Drum** for 1936-48 EL and 1941-48 FL. Features a cast iron construction as original!

VT No.	Finish
23-1250	Chrome
23-1255	Black



**1941-48 Big Twin Front Brake Shoe Kit** includes shoe set, washer with square, springs, cam, arm, lockplate, nut, pivot pin, adjuster, and cam shim. Shoes have linings riveted as on original. Fits 1941-48 BT and 1941-57 G.  
VT No. 49-1673

CLASSIC



80"

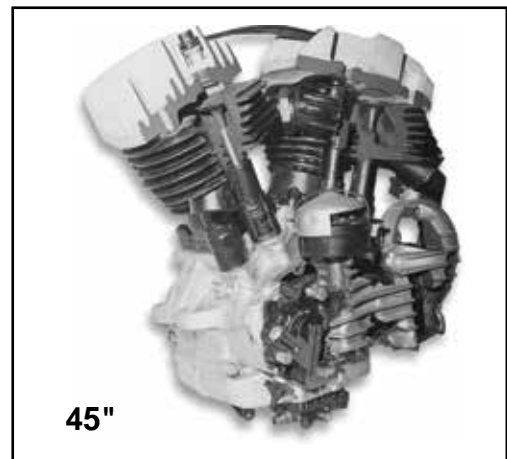

45"

**80" Motor All Internals**  
Available in our catalog





# Big Twin Spring Fork Brake

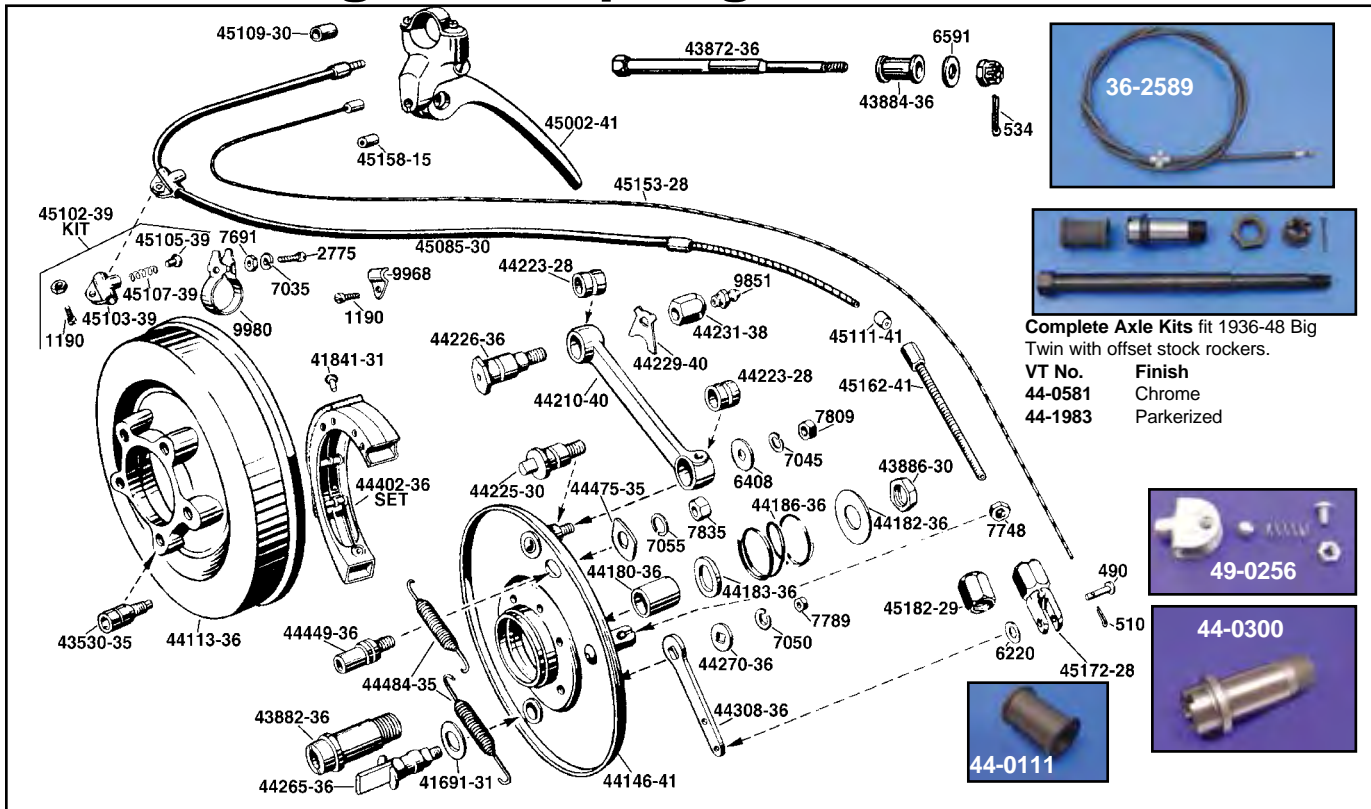

**VT No. OEM**

VT No.	OEM	Item
37-8661	534	Cotter Pin
N/A	6591	Washer, 10 pk
8163-3	7845	Cad Nut, Kit
37-8865	7923	Chrome Nut, each
44-0307	7923	Cad Nut, each
37-9027	9968	Clamp Cable for Fork, Top
2627-4	56626-37	Spark Control Coil Clamp, Parkerized
2628-4	9986	Front Brake Cable Handlebar Clip, Parkerized
37-8776	9980	Front Brake Cable Clamp
37-9312	9980	Front Brake Cable Clamp, Chrome
23-1990	41691-31	Copper Cam Shim
44-0085	43872-36	Front Axle, Parkerized
44-0209	43872-36	Front Axle, Chrome
44-0300	43882-36	Front Axle Sleeve
44-0304	43884-36	Spacer, Chrome
44-0111	As Above	Spacer, Parkerized
8162-3	43886-30	Chrome Nut Kit
23-0974		Black Brake Drum, 1936-39
23-1770	44113-36	Black Brake Drum
23-1771	44113-36C	Chrome Brake Drum
23-3077	44146-41	Black Backing Plate
49-1010	4108-36	Front Backing Plate, 1936-37, Black
49-1015		Front Backing Plate, 1938-40, Black
23-3076	44146-41	Chrome Backing Plate
49-1010	4108-36	Black Backing Plate, 1936-37 BT
49-1015		Black Backing Plate, 1938-40 BT
10-0737	44180-36	Bushing for Back Plate Big Twin
2641-3		Grease Fitting
23-0416	44475-35	Lock Plate
8617-4	44183-36	Grease Seal Kit includes Spring
8617-4T	44183-36	As Above
—	44186-36	44182-36 Gasket, Washer
49-2012	44223-28	Shackle Bushing, pair
49-2006	44210-40	Shackle Bar, Black 1940-48 Big Twin
49-2011	—	Shackle Bar, Chrome 1940-48 Big Twin
8010-10	44226-36	44223-28 Shackle Rebuild Kit,
	44231-38	44225-30 including 2 studs,
	44229-40	44231-38 2 bushings, lock, grease fitting and hardware.

23-3075	44265-36	Brake Cam, Big Twin
37-8941	44270-36	Shaft Washer
49-0064	44308-36	Operating Arm, 1936-48 Big Twin, Parkerized
23-1993	44402-36	Shoe Set Complete Big Twin
23-1652		Replica Shoe Set Complete, BT
23-1707		O.S. Linings Only, (.020)
23-0516	44433-39	Linings Only, Big Twin
23-0128	44449-36	Stud and Lock Plate
13-0209	44484-35	Shoe Springs
26-2126	45002-41	Lever Assembly Polished
26-2127	45002-41C	Lever Assembly Chromed
36-1994	45085-30	Brake Cable Inner/Outer 1941-57
36-2580	—	Brake Cable Housing only 1928-56
49-0422	45085-30	1930-57 Inner and Outer Brake Cable
		Includes the following: (replica)
	45102-39	Cable Oil Cup Kit and
	45109-30	Cable Ferrules
36-2589	45085-30	As Above
36-2567	45153-28	Inner Cable only
49-0256		Oiler Cup
8624-2	45162-41	Cable Adjuster 1941-57
9739-2	45162-41	As Above, Chrome
9630-2	45162-41	As Above, Parkerized
8938-2	45162-41	Cable Adjuster 1928-40 Cadmium
9683-2	4165-28	As Above, Parkerized
9740-2	4165-28	As Above, Chrome
37-8773	45172-28	Lower Cable Clamp
49-0213	45172-28	As Above Chrome
2593-5	45172-28	Lower Cable Clamp, Black
2593-5T	45172-28	Lower Cable Clamp, Black
22-1083	Kit	Chrome Big Twin Brake Kit
22-1084	Kit	Black Big Twin Brake Kit
49-0063		Arm, Cadmium

**23-1993**



**44-0304**



**49-1010**



**49-1015**



**37-8773**

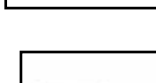

**49-0213**



**Springer Cable**

Kit includes replica outer cable with oiler cup, inner cable, and lower cable cinch.  
**VT No. 49-0171**



# Spring Fork Brake

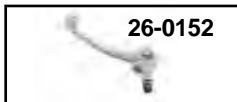

## Ball End Stainless Style Assembly.

- 26-0522 Ball End 5/16" Complete
- 26-0152 Polished, Screw In Type
- 26-0779 3/8" Hole Polished
- 26-2192 — Chrome Stock Lever Only
- 26-0542 — Lever Clamp Strap
- 8819-4 45031-41 1941-64 Pin and Nut, Cadmium
- 26-0506 45033-49 1949-64 Lever Bushing with cotter

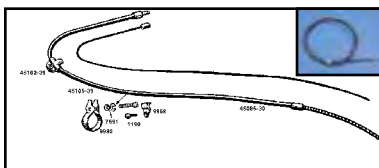

**Replica Brake Cable Assembly** for 1930-57 Spring Fork, Big Twin and 45". Includes housing with end ferrules, oil cup kit and inner cable. Replaces 45085-30. Order clamps separately.

**1941-64 Replica Brake Clutch Handle** features accurately formed clamp and cadmium plated hardware. Replaces 45002-41.

VT No.	OEM	Item/Fits	Year
49-0432	45085-30	Cable Housing only, 45"	1930-40
49-0422	45085-30A	Cable Assembly, Big Twin and Servi-Car	1941-57
36-2567	—	Inner Cable, All	
49-0256	45103-39	Oiler Cup	
37-9027	9968	Clamp to attach to fork, All	
37-0752	1190	Screw for Above	
37-8776	9980	Clamp to attach to bars, All	

- VT No. Item**
- 26-0541 Lever Assembly
  - 26-2143 Lever Assembly, Forged
  - 26-0950 Lever Assembly, 5/16" O.D.
  - 26-0948 Front Parking Lever, Assembly
  - 26-0946 Lever with ratchet plate
  - 26-0947 Hardware Kit
  - 13-0845 Spring
  - 26-0821 Handlebar Lever Mount
  - 26-0950 Lever Assembly, Polish, 1941-48
  - 26-0951 Lever Assembly, Chrome, 1941-48
  - 26-0953 Lever Assembly, Polished, 1949-64, brake
  - 26-0954 Lever Assembly, Chrome, 1949-64, brake
  - 26-0957 Lever Assembly, Polished, 1941-43, brake



**1941-48 Big Twin Spring Fork Cable and Handle Kit** includes replica style cable with oiler fitting and end ferrules, polished or chrome handle and clamps to attach cable to bars and fork leg.

VT No.	Type	Year
36-0414	Polished	1941-48
36-0775	Replica	1941-48
36-0418	Chrome	1941-48
36-0775	Replica	1941-48
49-0894	Chrome	1936-48

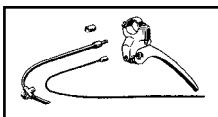

**Replica Lever Assemblies** include slotted lever bushing as original with small hole for brake or clutch.

- VT No. # OEM Finish**
- 26-2127 A 45002-41 Chrome Complete
  - 26-2126 A 45002-41 Polished Complete
  - 26-0583\*A Parkerized \*Note: Bushing is not included.
  - 26-0510 Ball End Polished, Lever Only
  - 26-0581 Ball End Polished, Stainless

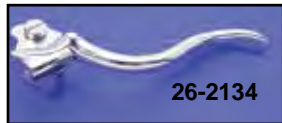

**Replica Brake Lever** is an authentic reproduction, complete as pictured for 1928-40 Spring Fork models.

VT No.	OEM	Item
26-2134	Chrome	Complete Assembly
26-0945	Parkerized	Complete, Assembly
37-8775	4154-28	Screw Set
49-0975	Parkerized	Screw Set
26-2150	4150-28	Handle only
26-2151	4153-28	Lower Clamp
49-0422	45085-30A	Cable Assembly, Replica
36-2580	4143-30C	Cable Housing, Black Cotton
36-2578	—	Cable Housing, Nickel Only
36-2567	—	Inner
49-1523	—	Pivot Screw
26-0949	Kit	Screw and Clamp
49-0975	Kit	Parkerized Screws

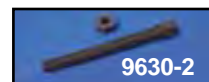
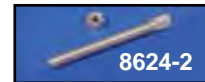
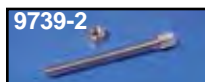
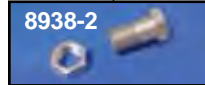
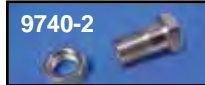

**Front Brake Cable Adjuster.** One or two locknuts included depending on application.

VT No.	Year/Model	Finish
9740-2	1928-40 All	Chrome
8938-2	1928-40 All	Cadmium
9683-2	1928-40 All	Parkerized
9683-2T	1928-40 All	Parkerized
9739-2	1941-48 BT, 1941-57	Servi-car Chrome
8624-2	1941-48 BT, 1941-57	Servi-car Cadmium
9630-2	1941-48 BT, 1941-57	Servi-car Parkerized

**Brake Cable Cadmium Plated Brass Coupling and Oiler** includes the dust cover 4142-30. 1930-38.

**VT No. 9004-2**





# 45" Solo Brake

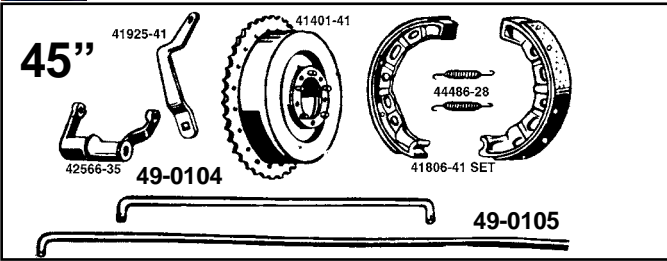

45 Rear Brake Parts for 1941-52 Solo models.

VT No.	OEM	Item
23-1740	41401-41	Drum Complete, Black
23-1769	—	Drum Complete, Chrome
23-1017	—	Black Drum
49-0638	—	Black Backing Plate
49-0903	—	Backing Plate, Chrome
49-1875	41647-41	Backing Plate Assembly
49-2555	41652-37	Backing Plate, Black
49-0520	—	Backing Plate, Chrome
23-0760	41692-36	Brake Cam Shim
19-0010	41474-35	Sprocket Kit with Ring
19-0089	41421-35	Dust Ring only
23-1751	41806-41	Shoe Set Complete
49-1240	—	Shoe Kit
13-0208	44486-28	Spring Set
23-0736	41849-41	Linings, pair
49-0077	4054-35	Rear Cam
49-0655	—	Rear Cam, Wide
49-2574	41876-41	Pivot Stud
49-2575	44476-35	Lock Plate
49-0914	42566-35	Bell Crank
49-0179	41925-41	Rear Arm
49-2598	41925-41	As Above, Chrome
49-0104	4073-39	Front Rod, Parkerized
49-0105	4065-35	Rear Rod, Parkerized
2502-12	—	Clevis Pin Kit
49-0239	69129-37	Speedo Drive, Zinc
49-0210	69129-37	Speedo Drive, Chrome
49-1745	—	Speedo Drive, Parkerized
49-0261	Kit	Drive Rebuild
49-0209	67080-37	Lock Tab
49-0097	—	Gear
49-1746	—	Speedo Drive

## Rear

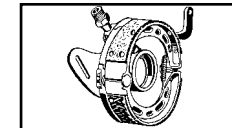

**Backing Plate Assembly** includes backing plate, arm, shoes, springs, speedometer drive and cam completely assembled.

VT No.	Item
49-0960	Backing Plate Kit, Black
49-0520	Backing Plate Kit, Chrome
49-1875	Backing Plate Kit, Parkerized
49-2629	Complete Brake Kit

**45" Solo Brake Rods** in chrome or parkerized.

Chrome	Parkerized	OEM	Year	Type
49-2553	49-0104	4073-39	1939-52	Front
49-2554	49-0105	4065-35	1935-52	Rear

## 45" Solo Front Wheel

**45" Solo Front Wheel Assemblies** include rim, replica original fin-sh hub and bearings laced with stainless steel spokes.

VT No.	Size	Rim	Rim Only
52-0755	16"	Chrome	52-0966
52-0756	16"	Chrome	52-0966
52-0757	16"	Black	52-0967
52-0758	18"	Black	52-0785
52-0759	18"	Chrome	—
45-0877	16"	Spokes	—
44-1941	—	Bearing Kit	—
49-1379	—	Shoe Kit	—



**45" Front Brake Drum/Wheel Hub** available in black, chrome or military olive drab finish and does not include internals.

VT No.	Finish
49-1275	Black
49-1277	Chrome
49-1276	Olive Drab
49-0845*	Olive Drab
49-1941	Hub Internal Assembly Kit
12-0128	Ball Bearings

\*Note: Includes internals, axle and nuts.



VT No.	Item
49-2576	Kit
49-1516	Kit, Chrome
2637-3	Fitting
2599-6	Stud Set
49-1311	Kit
49-0544	Washer Kit
49-0621	Parkerized Cover
49-0622	Chrome Cover

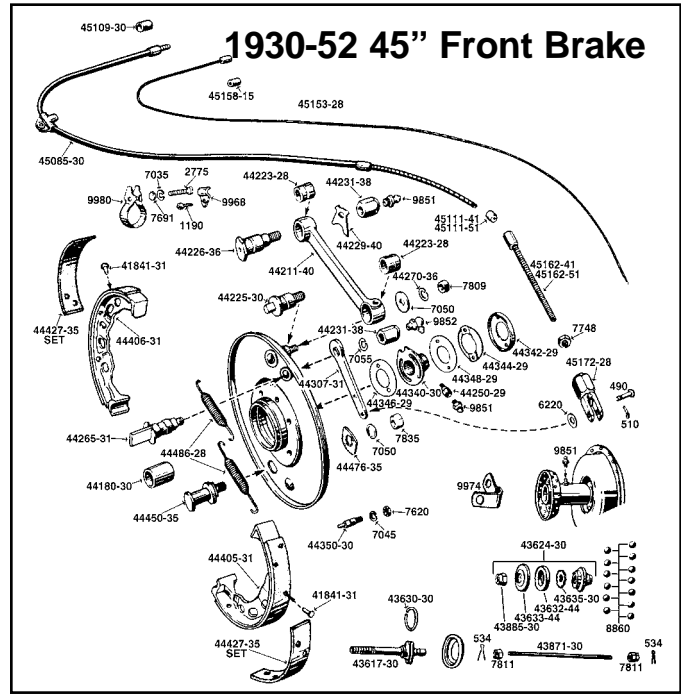

**45" Front Axle and Brake Hardware** fits 1930-52.

VT No.	OEM	Item
9690-4	7811	Axle nuts, parkerized
8854-4	7811	Axle nuts, chrome
8855-4	7811	Axle nuts, cadmium
12-0157	8860	Balls, 50 pack
44-0533	9851	Grease Fitting, 10 pack
37-0511	9852	90° Grease Fitting, 5 pack
37-9027	9968	Early Frame Mount Cable Clamp
37-9289	9974	Lower Cable to Fork Clamp
37-8776	9980	Front Brake Cable Clamp
44-2005	43617-30	Axle Sleeve
44-2006	43630-30	Retaining Ring, 5 pack
44-2002	43632-44	Cone Seal, 5 pack
44-2003	43635-30	Lockwasher, 5 pack
44-2004	—	Bearing Cone and Nut for Sleeve
44-2417	—	Cone Nut
44-0938	—	Cone Nut
44-2077	—	Bearing Cone Set
44-2007	43640-30	Left inner dirt guard
49-1963	43871-30	Axle
2897-5	Kit	Axle and Nuts
9302-2	43885-30	Nut and Oil Seal
Includes	43633-44	Retainer, chrome
9303-2	As Above	Cadmium
9743-2	As Above	Parkerized
49-0200	44145-41	Backing Plate 1941-52
49-0041	Chrome	Backing Plate 1941-52
10-0736	44180-30	Backing Plate Bushing
49-2012	44223-28	Springer Fork Brake Bushing
49-2563	44226-36	Stud
8010-10	44229-40	Lock Tab
49-2604	44231-38	Nut
49-0245	44226-36	44223-28 Shackle Rebuild Kit, included 2 studs, 2 bushings, lock, grease fittings, and hardware.
2637-3	44231-38	Shackle Bar, Black
49-0211	44229-40	Fitting Extension
37-8941	44265-31	Grease Fitting
49-0063	44270-36	Brake Cam
49-0245	44307-31	1936-48 Brake Cam Washer
49-0211	44211-40	Front Brake Operating Arm
37-8941	44250-29	Shackle Bar, Black
49-0063	44265-31	Fitting Extension
49-2576	44270-36	Brake Cam
49-1516	44270-36	1936-48 Brake Cam Washer
49-1553	44307-31	Front Brake Operating Arm
37-9290	44346-29	45 Front Brake Plate Cover Kit
23-1992	44340-30	Black Powder Coated
23-0518	44348-29	45 Front Brake Plate Cover Kit
49-0212	44344-29	Chrome
49-2575	44342-29	Chrome Cover
13-0208	44405-31	Wheel Cover Plate Stud
26-2126	44406-31	Shoe Set
26-2127	44405-31	Brake Lining Only
36-1994	44427-35	Brake Shoe Pivot Stud
36-2580	44450-35	Locking Plate
49-0422	44476-35	Spring Set
Includes	44486-28	Lever Assembly Polished
36-2567	45002-41	Lever Assembly Chromed
8624-2	45002-41C	Brake Cable Inner/Outer 1941-57
9739-2	45085-30	Brake Cable Outer 1928-40
9739-2T	45085-30	1930-57 Brake Cable, Inner /Outer
9630-2	45102-39	Cable Oil Cup Kit
8938-2	45085-30	Cable Ferrules 1941-57
9683-2	45153-28	Inner Cable only
9740-2	45162-41	Cable Adjuster, 1941-57
37-8773	45162-41	As Above, Chrome
49-0519	45162-41	Cable Adjuster, 1941-52, Chrome
2647-3	45162-41	As Above, Parkerized
44-0926	4165-28	Cable Adjuster 1928-40 Cadmium
44-0543	4165-28	As Above, Parkerized
2897-5	4165-28	As Above, Chrome
	45172-28	Lower Cable Clamp, Black
	Kit	Backing Plate
		Shifter Rod Clevis Pin Kit
		Grease Tube
		Axle Kit
		Axle Kit

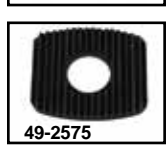
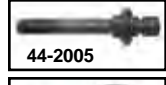



# Side Valve Models Flat Head Parts



Fit Big Twin 1930-48 45" models 1929-73.



49-0908

**45" Aluminum Head Set**  
replaces front and rear on 1941-73. Order bolts and washers separately. Replaces 16683-39 & 16681-39.

**VT No.**      **Compression**  
49-0908      Low  
49-0945      High  
15-0449      Base Gasket



49-0945      45"



BT

**Aluminum Head Set** for all 1936-48 74 and 80 Side Valve engine, deep fin, medium compression. Replaces front and rear 16670-36F, 16673-36R. Sold as pairs.

**VT No.**      **Type**  
49-0909      Head Set  
15-0228      Copper Gasket Set  
**Copper Head Gaskets**  
15-0739      1930-35 VL  
15-0185      1939-73 45"



15-0531

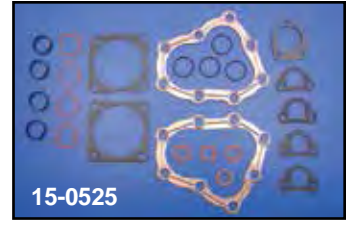

15-0525

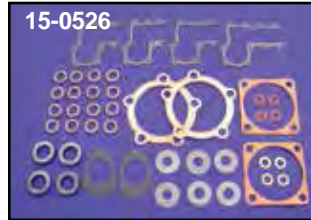

15-0526



15-0515

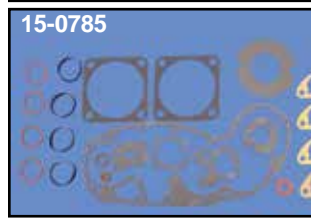

15-0785

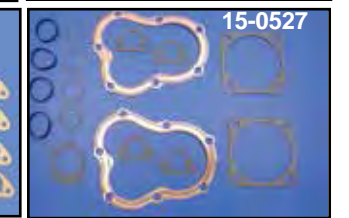

15-0527

**Complete Engine Sets For Flathead (Side Valve) Models.** Order head gaskets separately.

GB No.	James No.	OEM	Years	Fits
15-0531	15-0505	17026-40	1940-73	All 45" Side Valve
15-0515	15-0506	17027-36	1936-48	74" and 80" Side Valve
15-0785			1930-36	VL

**Early Top End Kits.**

GB No.	James No.	Years	Fits
15-0525	15-1182	1940-73	45
15-0527	—	1930-36	VL
15-0528	15-1183	1936-48	UL/ULH



**Original V-Twin Replica since 1977!**

## Headbolts



**Head Bolts, Head Nut and Washer Kits. Flat Heads**

Cadmium	Chrome	Parkerized	Item
—	—	—	Stud Set (1929-50) 16 piece
7709-32	—	—	1932-40 45" Head bolt nut with washer
7711-18	8216-18	9727-18	74 and 80 with Aluminum Heads, order washers separately
9889-16	9888-16	—	1951-73 45" WL and G
7711-18-45	8217-18-45	9705-18-45	45" with Aluminum Heads
7712-36	8218-36	9728-36	45, 74 and 80 with Cast Iron Heads
—	2055-1	—	1965-73 45" Head Bolt for Alternator Mount
—	—	49-0276	45" Bolt only, 14-40MA (NOS)
7710-18	8215-18	9698-18	Aluminum Flathead Washer Kit

**Studs for 1929-50 45" VT No. 2183-16**



**1937-48 Big Twin Side Valve Upper and Lower**

**VT No.**      **Type**  
9521-22      Chrome  
9522-22      Cadmium  
9723-22      Parkerized  
**45" Lower Only**  
9625-16      Chrome  
8825-16      Cadmium  
9626-16      Parkerized

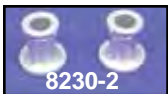

8230-2

**1932-up Upper Only**

9779-5      Chrome  
9780-5      Cadmium  
9781-5      Parkerized

**45 Top Motor Mount Spacers** for spacing out the two longest head bolts on aluminum head models. 1941-73.

8229-2      Chrome      8230-2      Cadmium  
9721-2      Parkerized



**Side Valve ULH Headbolt Wrench.**  
VT No. 16-0067



**Engine Case Bolt Kit** includes the necessary hardware to bolt together the motor cases of the years listed.



Acorn	Chrome	Cad	Fits
8121-34	8122-34	8123-34	1936-39 Flathead Big Twin
8124-34	8125-34	8126-34	1940-48 Flathead Big Twin
—	8619-17	8620-17	1937-73 45's
—	—	9697-17	1937-73 45's Parkerized

## Side Valve Mount

**Side Valve Engine Mounts** fit engines by head type cast iron or aluminum. Ends of mount are attached by bolts in head bolt set.

Zinc	Chrome	OEM	#	Type	Fits
31-0108	—	16851-37	A	Both	1936-48 BT
49-1932	—	2806-40	B	Alum.	1936-73 45"
31-0211	—	16855-51	C	Iron	1932-73 45"
—	31-3993	16851-37			







# Side Valve Flywheels



**Stock Replacement Rod Sets** for Flathead. Includes new rods, crank pin, nuts, cages and standard rollers. Rollers are fitted and assembled. Piston pin bushings are installed and honed for stock wrist pin.

**V-Twin Complete Stock Flywheel Assembly** is shipped complete, assembled, balanced with V-Twin Mfg. standard piston and trued with shafts included.

VT No.	Year	Model
10-1035	1929-73	45" Side Valve
10-1013	1937-48	74" Side Valve



**Connecting Rod Race Sets** made from 52100 steel and hardened.

VT No.	Model	Years
10-0139	Flathead 45"	1929-54
10-0143	VL	1930-36
10-0138	UL	1936-48



**TRUETT & OSBORN**

**Truett and Osborn Flywheel Sets** feature original weight right and left sides.

**Bare Flywheels Only**

VT No.	Fits
10-1049	45"
10-1027	74" & 80" Side Valve
10-1068	K Model

## Crank Pin

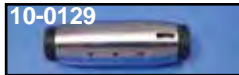

**Crank Pin Lock Kits** include two nuts, two locks and mount screws. Nuts and locks are also available separately.

**Crank Pins** available from Eastern, Jims and V-Twin. Pins are made of 8620 steel with .062 heat penetration.

Model	Years	Jims 3 Hole	Jims 1 Hole	Eastern 3 Hole	V-Twin 2 Hole	OEM
74 OHV	1941-47	10-8356	—	10-0129	10-0135	23961-41
Big Twin UL (Step Pin)	1940-52	—	10-8363	10-0131	—	—
K Model	1952-53	10-0132	—	10-8371	—	23960-52
45's	1929-73	—	—	10-0365	10-0127	23960-29
Early-Twin	1930-34	—	—	10-0394	—	348-30
45" WR	1941-52	—	—	10-0381	—	—

Model	Item	VT No.	OEM	Year
10-0335	Kit	1936-52	61" & 80"	Kit
10-0336	Kit	1941-53	74" Big Twin	Kit
10-0338	Kit	1929-73	45"	Kit
12-0535	23966-36	1936-52	61" and 80"	Eastern
12-0602	23966-36	1936-52	61" and 80"	Jims
12-0573	—	23967-41	1941-53	74" Big Twin
12-0520	8010	1929-73	45"	Nut Set



**Connecting Rod Roller Sets.** Each set supplies enough rollers for that application only. For Flat Head 45" 1929-54.

VT No.	Size
10-0168	Standard
10-0169	.0006 oversize



**Sifton Steel Rod Cage Set** includes 4 cages and standard Torrington Roller Set.

VT No.	Type	Year	Size
10-2522	Big Twin	1936-85	Standard
49-0058	45"	1929-73	Cage Set
10-8753	45" WR	1936-53	Cage Set
10-0940	W	1929-73	Kit
10-1297	WR	Roller Set	

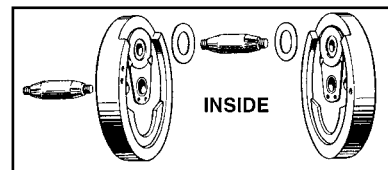
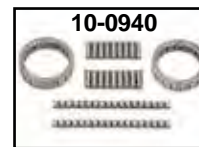

**Bronze Wrist Pin Bushings, pairs.**

VT No.	OEM	Application/Side	Year	U/M
10-0756	24334-36	Big Twin Side Valve	1936-48	Standard
10-0757	—	Big Twin Side Valve	1936-48	.002
10-0758	—	Big Twin Side Valve	1936-48	.005
10-0759	24335-36	Big Twin Side Valve	1936-48	.010
10-0760	24331-36	45" Side Valve	1930-73	Standard
10-0762	—	45" Side Valve	1930-73	.005
10-0763	29332-36	45" Side Valve	1930-73	.010

**Steel Crank Pin Flywheel Washers** sold in pairs.

Inside	OEM	Year	Model	Size
10-1284	23972-36	1936-52	Big Twin 61" OHV	Standard
		1937-48	Big Twin Side Valve 74" and 80"	
10-1217	77972-21	As Above	—	.005
10-1162	23972-21	1929-73	45" Side Valve	Standard



# Side Valve Case Races

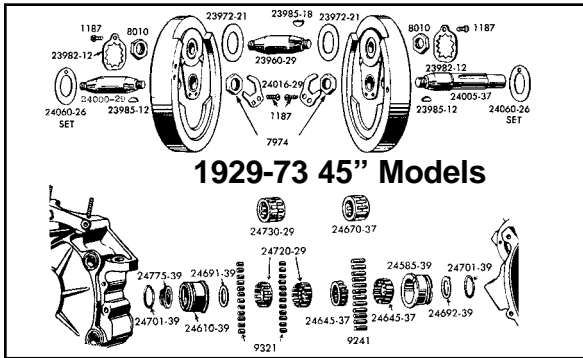

1929-73 45" Models

## 45" Engine Components for 1929-73.

VT No.	OEM	Item
12-0560	7974	Shaft Nuts, 5 pack
10-0337	8010A	Crank Pin Nut Kit
10-1162	23972-21	Inside FW Washer, 2 pack
17-0922	23982-12	Crank Pin Lock, 10 pack
12-0200	23985-12	Shaft Key, 10 pack
12-0201	23985-18	Crank Pin Key, 10 pack
10-0417	24000-29	Sprocket Shaft
10-0406	24005-37	Gear Shaft
17-0929	24016-29	Shaft Nut Lock
10-1161	24060-26	Flywheel Washer Set
10-0218	24585-39	Right Case Race Standard
10-0219	24585-OS	.002 As Above
10-0220	24585-OS	.005 As Above
10-0221	24610-39	Left Case Race
10-0222	24610-OS	.002
10-0223	24610-OS	.005
10-1165	24691-39	Left Side Washer, 5 pack
10-1166	24692-39	Right Side Washer, 5 pack
12-0975	24701-39	Right and Left Retainer, 10 pack
10-0430	24775-39	Left Oil Slinger, each

## CASE ROLLERS

1937-48 SV Big Twin Right Side replaces 9261, 12 per set.

Size	12-Piece	100 Pack	OEM
Standard	10-0307	12-4523	9261
.0002	10-0308	—	9262
.0004	10-0309	12-4525	9263
.0006	10-0310	12-4526	9264
.0008	10-0311	—	9265
.001	10-0312	12-4528	9266

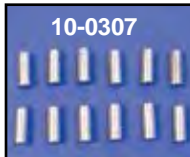

45" Right Crankcase Rollers, 12 piece.

Size	12-Piece	100 Pack	OEM
Standard	12-4573	12-4593	9241
.0002	12-4602	—	9242
.0004	12-4575	12-4595	9243
.0006	12-4574	12-4594	9244
.001	12-4604	12-4605	9246

All Rollers by TORRINGTON®

45" Left Crankcase Rollers, 24 set for 1924-73.

Size	24-Piece	100 Pack	OEM
Standard	—	—	9321
.0006	12-4597	12-4571	9324
.0008	—	12-4614	9325
.001	12-4598	12-4572	9326

1940-54 Big Twin Left Side Case Rollers, 24 per set.

Size	24-Piece	100 Pack	OEM
Standard	10-0300	—	9220
.0002	10-0301	—	9221
.0004	10-0302	12-4512	9222
.0006	10-0303	—	9223
.0008	10-0304	12-4514	9224
.001	10-0305	12-4515	9225

## Bulk Pack Rod Rollers

1929-73 45" Flathead

Size	Long	OEM	Short	OEM
Standard	12-4593	9241	12-4599	9301
.0002	12-4503	9242	—	9302
.0004	12-4595	9243	12-4615	9303
.0006	12-4594	9244	12-4600	9304
.001	12-4605	9246	—	9306

VT No. 12-4616 is a set of long and short

J Model Left Case (Sprocket Shaft) and Male Rod or J and VL models.

Standard size is .250 x .350

Size	OEM	VT No.
Standard	9281	12-4570
.0006	9284	12-4571
.001	9286	12-4572



1936-47 OHV, 1930-48 Side Valve 74 and 80" Case Races.

Note: VT No. 10-2498 is a bronze bushing.

Jims	VT No.	OEM	Years	Side	Size
—	10-2498	413-30	1930-36	Right	Standard
—	10-2519	416-30	1930-36	Left	Standard
—	10-0226*	413-36	1936-39	Right	Standard
—	10-0228*	416-36	1936-39	Left	Standard
—	10-2521*	—	1936-39	Left	.002
10-0257	10-0224	24595-40	1940-48	Right	Standard
10-0258	10-0225	24597-40	1940-48	Right	.005
—	10-0264	As Above	1940-48	Right	.010
10-0235	10-0208	24621-40	1940-54	Left	Standard
—	10-0209	24623-40	1940-54	Left	.005
—	10-0210	—	1940-54	Left	.010
—	10-0211	—	1940-54	Left	.015

\*Note: Fits 1937-39 Big Twins, 1936 Overhead Valve

Case Race machined & ground to factory specifications.

## Sprocket Left Side Case Race

Jims	Eastern	OEM	Size	Year/Model
10-0238	10-0221	24610-39	Standard	1939-73 45"
—	10-0222	24611-39	.002	1939-73 45"
10-0239	10-0223	24612-39	.005	1939-73 45"

## Pinion Right Side Case Race

10-0255	10-0218	24585-39	Standard	1939-73 45"
—	10-0219	24586-39	.002	1939-73 45"
10-0256	10-0220	24587-39	.005	1939-73 45"

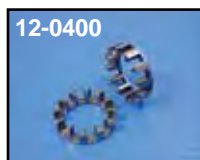

## Steel Roller Retainer Cages.

VT No.	OEM	Application	U/M
<b>Rod</b>			
12-0404	24366-51	74 and 80	4
12-0412	24366-51	As Above, Jims	4
49-0058	—	45" SV	4
12-4616	—	45" Roller Set	24 pc
12-1942	.0006	45" SV Roller	Kit
12-1941	.0008	45" SV Roller	Kit

## Big Twin Right Pinion

12-0400	24646-36	1936-54 Big Twin	2
12-0413	24646-36	As Above, Sifton	2

## Big Twin Left Side Sprocket

12-0401	24721-30	1930-54 Big Twin	2
12-0414	24721-30	As Above, Sifton	2

## 45" Left Sprocket

12-0424	24720-29	1929-73	
---------	----------	---------	--







# SV Pinion Hardware

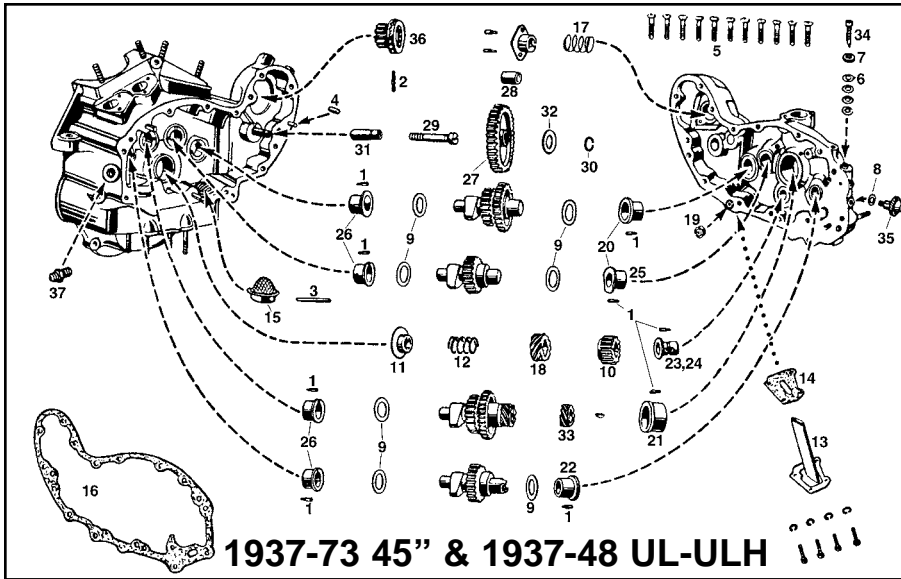

**Replica ULH Cam Cover** includes bushings installed, features smooth natural finish. As used on 74 and 80 cubic inch 1937-40 ULH. **VT No. 10-1937**

**1930-36 Big Twin and 45" Timer and Cam Bushings.**

- VT No. OEM Fits**
- 10-8524** 662-29 Timer Shaft
  - 10-8525** 662-30 Cam Gear Shaft
  - 10-8526** 662-34 Oiler Drive Shaft

**VL Cam Shims for 1930-36.**

- VT No. OEM Size**
- 10-8521** 663-26 1/64"
  - 10-8515** 664-26 1/32"

45" SV	Big Twin SV	OEM	#	Item	45" SV	BT SV	OEM	#	Item
12-1175	12-1175	271	1	Bushing Pin	10-2976	10-2977	Set		Cam Set, 4 pieces
12-1185	12-1185	327	2	Gen Gear Pin	10-8379	10-8380	Kit		Bushing Kit
12-1173	12-1173	333	3	Strainer Pin	10-0709	10-0709	25586-37	20	Cam Gear Cover Bushing
—	12-1166	377	4	Dowel Pin	10-2540	10-2540	As Above		.005 Oversize
9668-19	9668-19	2341	5	Cam Cover Screw, parkerized	10-0731	10-0731	25588-37	21	Cam Gear Cover Bushing
9413-19	9413-19	2341		Cam Cover Screw, cadmium	10-2507	10-2507	25590-37	22	Cam Gear Cover Bushing
9412-19	9412-19	2341		Cam Cover Screw, chrome	10-2512	10-2512	25591-37	23	Pinion Bushing
9985-24	9985-24	6150W	6	Adjuster Washer	10-2503	—	25593-37	24	Pinion Bushing
37-0737	37-0737	6182	7	Adjuster Washer	10-2506	—	25595-37	25	Cam Gear Cover Bushing
14-0154	14-0154	6440	8	Oil Switch Washer	10-2504	10-2504	25599-37	26	Cam Gear Cover Bushing
12-0705	12-0705	6769	9	Shim	10-2495	—	25601-37A	26	Cam Gear Cover Bushing
—	12-1474	24010-37	10	Pinion Gear	—	12-1475	25775-37	27	Idler Gear
12-1473	—	24011-37	10	Pinion Gear	12-1259	—	25776-37	27	Idler Gear
12-1526	—	24696-39	11	Seal Ring	10-0716	10-0716	25785-30A	28	Idler Gear Bushing
—	12-1527	24696-40	11	Seal Ring	12-0197	12-0197	25794-30	29	Idler Gear Stud Screw
13-0105	—	24699-37	12	Pinion Spring	12-0915	12-0915	25810-15	30	Idler Gear Retaining Ring
—	13-9202	24700-37	12	Pinion Spring	10-0805	10-0805	25788-30	31	Idler Gear Stud
12-1424	12-1424	24912-37	13	Relief Pipe	10-0806	10-0806	Kit	31/28	Stud and Bushing Kit
15-0334	15-0277	24921-37	14	Relief Pipe Gasket	15-0217	15-0217	25811-11	32	Idler Washer
12-1512	12-1512	24975-37	15	Oil Strainer	—	12-0419	25851-37	33	Circuit Breaker Drive Gear
15-0879	—	25226-37	16	Cam Cover Gasket	12-1404	12-1404	26383-32	34	Adjuster Screw
—	15-0407	25227-37	16	Cam Cover Gasket	12-1401	12-1401	26550-38A	35	Oil Pressure Switch
13-0106	13-0106	25287-37	17	Breather Spring	32-0550	32-0550	31071-37	36	Generator Drive Gear
49-0654	49-0654	25281-37	17A	Seal Ring Plate	7612-3	7612-3	63533-15	37	Oil Fitting, Cadmium
49-1016	49-1016	Kit		Breather Kit	7612-3T	7612-3T	63533-15	37	Oil Fitting, Cadmium
—	12-1378	25302-37	18	Oil Pump Drive Gear	40-0514	40-0514	63593-15	37	Oil Fitting, Chrome
12-0421	—	26318-37	18	Oil Pump Drive Gear					
49-2562	49-2562	25350-37	19	Breather Valve					

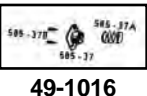

# Valve Covers

**Valve Spring Cover Set Screw type.** Use on all 1930-38 Flathead. Set of four.

VT No.	Year/Model	Type
49-0119	1930-36 VL	Zinc Set
49-0113	1930-36 VL	Zinc Set
49-0192	1937-38 UL	Zinc Set
49-0243	1937-38 UL	Chrome Set
14-0173	1930-38 VL and UL	Seal for Above



**\*Note:** Feature chrome lower portion only.

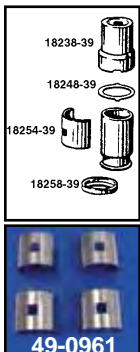

**Late ULH Valve Cover Set** includes 4 sets of all parts shown, for 1939-48 UL-ULH models.

VT No.	OEM	U/M	Item/Finish/Use
49-1965	18236-39	4	Complete, Chrome
49-0967	18236-39	4	Complete, Zinc
49-0961	18254-39	4	Clips, Chrome
49-0962	18254-39	4	Clips, Zinc
49-0963	18248-39	4	Locks, Zinc
49-2580	18258-39	4	Retainers, Zinc
13-0103	18247-39	4	Springs
15-0281	18245-39	10	Cork Gasket, Upper
49-1968	18246-39	4	Cork Retainer, Upper
15-0282	18257-39	10	Cork Gasket, Mid
15-0283	18259-39	10	Gasket, Lower

**45" Valve Cover Sets for 1929-73.**

VT No.	OEM/Model	Item	Finish	Set
49-0938	45" Kit	Complete Set (Less Seals)	Zinc	Set
49-0700	45" Kit	Complete Set (Less Seals)	Chrome	Set
2722-20	45"	Set	Parkerized	Set
14-0785	Seals	Kit	—	8
15-0255	18630-26	Washer	—	10
14-0170	18260-29	Flat Seal Ring	—	5
14-0621	18260-29	Flat Seal Ring (James)	—	5
14-0510	11123	O-Ring	—	10
15-0256	18198-38	Guide Seal	—	2

# SV Pinion-Sprocket Shafts



Pinion Shafts						
Side Valve	Year	OEM	Jims	Eastern	V-Twin	Motor Shop
45"	1929-73	24005-37	10-0406	10-0449	10-0433	
Big Twin UL	1937-48	24006-37	10-8331	10-0407		
F, J, JD	1915-28	355-15				
VL	1930-36	355-30		10-0395	15-0382 Gasket	
W, K, XLR	All	24005-67R				
XR 750	All	24007-69R	10-0392	10-0392		
Sprocket Shafts						
Big Twin 61 and 74	1930-54	24001-30	10-8314	10-0410	10-0456	10-0469
45"	1929-73	24000-29	10-0417	10-0437	10-0479	10-0475
Early Twin	1925-29	352-25			10-0397	



## Pinion



**Pinion Shaft Nut, Taper End, 5 pack.**  
**VT No. OEM Fits**  
**12-0532** 24023-36 1936-81 Big Twin  
**12-0560** 7974 1923-73 45"



**Lock Plate, Pinion Shaft Nut, 10 pack.**

**VT No. OEM Fits**  
**17-0913** 24015-36 1936-80 Big Twin  
**17-0929** 24016-29 1929-73 45"



**Taper Pinion Keys** sold in ten packs. Fits 1941-81 Big Twin, 1929-73 45", replaces OEM 23985-12.  
**VT No. 12-0200**



**Engine Sprocket Nut Kit** for 1930-54 Big Twin includes correct nut, key retaining ring and left bearing oil slinger.  
**VT No. 12-0620**

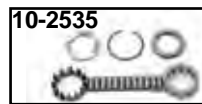

**Pinion Bearing Sets** for right side includes rollers and cages. Washers and snap rings included when required except where \*noted.

**VT No. Year Model**  
**10-2535** 1936-54 Big Twin 74 & 80  
**10-1204\*** 1929-73 45" Standard



**Side Valve Pinion Kit** includes parts for the years of application.  
**VT No. Fits Model**  
**12-0103** 1937-73 All 45"  
**12-0107** 1940-48 74" & 80"

**Pinion Shaft Seal Ring.**

**VT No. OEM Year Model**  
**12-1526** 24696-39 1937-73 45" Twins  
**12-1527** 24696-40 1940-48 74" and 80" Side Valve

## Sprocket



**Left Sprocket Shaft Bearing & Hardware Kit** includes loose rollers, cages and end slinger.

**VT No. Model Item Year**  
**12-0409** Big Twin Kit 1941-54  
**12-0410** 45 Kit 1929-73

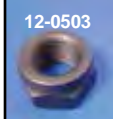
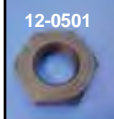

**Nuts, Motor Sprocket**  
**VT No. OEM Fits Years**  
**12-0501** 7991 45" 1929-73  
**12-0503** 24003-30 Big Twin & 61 1930-54



**Motor Sprocket Kit** includes 23 tooth sprocket, nut, key, dust ring and retainer. Parkerized BT 1936-48. **VT No. 19-0137**

**Nut, Sprocket Shaft Taper End. 5 packs.**

**12-0560** 7974 1929-73 45" Side Valve  
**12-0532** 24023-36 1936-71 Big Twin



**Motor Sprocket Nut Kit** includes correct nut, key retaining ring and left bearing oil slinger.  
**VT No. Fits**  
**12-0620** 1941-54 Big Twin  
**12-0619** 1929-73 45"



**Left Bearing End Oil Slinger.**  
**VT No. OEM Year/Model**  
**10-0430** 24775-39 1939-73 45"  
**10-0429** 24776-40 1941-54 Big Twin



**Sprocket Shaft Seal and Snap Ring.**  
**VT No. OEM Year Model**  
**7411-2** 24776-40 1936-54 61"-74"-80"  
**8211-2** 24775-39 1939-73 45" Model





# Cam Sets



Replica Cam Sets by Sifton (with original manufacturer specs).

VT No.	Type	Year
10-2976	45"	1936-73
10-8183	45" WLDR	1936-73
49-8554*	WR	1936-73
10-2977	Big Twin UL-ULH	1936-48
10-2982	ULH	1937-48
10-2981	Side Valve	Shafts

\*Note: Requires 49-8552 lifter tappet kit



**Unilite Distributor** with billet aluminum housing is a dual fire type, includes gear and features 12 volt electronic performance. The electronic ignition module fits inside distributor, so no external box. Fits 1930-73.  
**VT No. 32-0174**



**Accel Electronic Advance Distributor** with rev limiting for 1930-52 45, 1936-47 Side Valve Big Twin and 1952-70 XL models. Features adjustable electronic advance curves, single or dual fire modes and CNC machined billet housing. Use with a 3 ohm coil.  
**VT No. 32-7804**



**Distributor Hold Down Clamp** fits 1957-70 XL and SV 1936-73.  
**VT No. 31-3966**

# Side Valve Oil Pump Parts

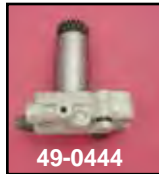
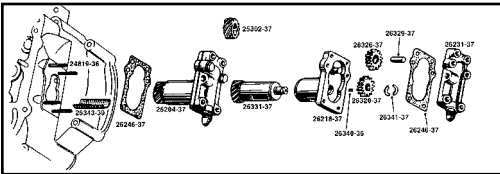

## Side Valve Scavenger Pump Parts

VT No.	OEM	Item
49-0626	Complete	Scavenger Pump
49-0444	Complete	Scavenger Pump
49-0836	Cover	Scavenger, Pump
49-0444	Complete	Pump Assembly
9408-22	Chrome	Bolt Kit
9409-22	Cadmium	Bolt Kit
9663-22	Parkerized	Bolt Kit
12-1378	25302-37	Breather Spiral Gear
15-0649	26246-37	Gasket
12-1257	26331-37	Scavenger Gear
12-0204	26340-36	Key
12-0214	26341-37	Key Halves
12-0153	26343-39	Screen
12-1465	23383-32	Oil Adjusting Screw Kit
12-1446	26218-37	Body Only
12-1504	Kit	Rebuild Kit
12-1505	Kit	Rebuild Kit

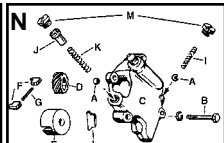
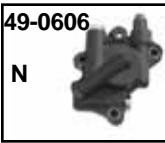

45 Feed Pump Parts for 1937-73.

VT No.	OEM	#	Item
49-0606	Complete		Pump Assembly (N)
49-0639			Feed Pump
12-1478	Kit		A, M, J, K, I
12-0110	Kit		Complete Speed Pump Assembly Kit
12-0158	8816	A	Balls (25)
9408-22	Chrome	B	45's 1937-73 Bolt & Nut Kit
9409-22	Cadmium	B	45's 1937-73 Bolt & Nut Kit
9663-22	Parkerized	B	45's 1937-73 Bolt & Nut Kit
12-0421	26318-37	D	Oil Pump Drive Gear
12-1483	26270-37	E	Holder, Pump Vane 1937-73
12-1442	26284-37	F	Vane, pair
13-0161	26286-37	G	Spring, Vane
49-0094			Upgrade Vane Holder
9523-1	26362-36	H	Check Valve Plug, Chrome
9524-1	26362-36		As Above, Cadmium
9525-1	26362-36		As Above, Parkerized
13-0114	26363-56	I	Check Valve Spring
12-1444	26369-41	J	Adjust Screw
12-1476	26383-32	J	Replica Screw
13-0160	26373-41	K	By-Pass Spring
15-1185	—		Gasket Kit

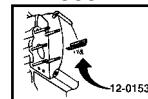
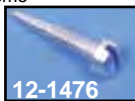

**Breather Screen** replaces 26343-39 on SV's.  
**VT No. 12-0153**

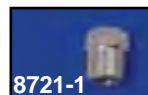
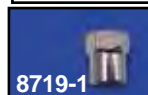

**A-Long Oil Pump Nut** with 1/4-24 thread for 1941-48 74 and 80 SV, 1941-54 45's.

VT No.	Finish
8719-1	Chrome
8721-1	Cadmium
9631-1	Parkerized

## B-Standard 1/4 x 24 Hex Nut

VT No.	Qty	Finish
8110-12	12	Chrome
8111-12	12	Cadmium
9673-12	6	Parkerized

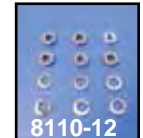

**Oil Strainer** fits 1937-73 Flatheads. Kit includes strainer, gasket and pin.

VT No.	OEM	Item
12-1542		Kit
12-1512	24975-37	Oil Strainer
12-1173	333	Pin, 10 pack
15-0214	24973-57	Gasket, 10 pack

Oil Strainer



**Flathead Relief Pipe** replaces 24912-37 on 1937-52 45's and 1937-48 Big Twin Side Valve.  
**VT No. 12-1424**



**Oil Pump Fitting** replaces stripped or broken fitting in cast iron SV feed or scavenge pumps fittings has 7/16" UNF thread with internal hex for installation.  
**VT No. 40-0512**



**Oil Pump Adjusting Screw Kit** Side Valve, include screw, shims and washer.  
**VT No. 12-1465**

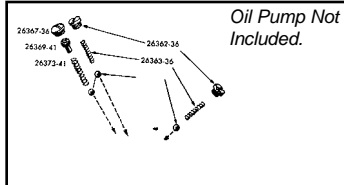

**1937-73 Side Valve Feed Pump By Pass and Check Valve Kit** includes (3) springs, (3) caps, (3) balls and a check valve.  
**VT No. 12-1478**

- 35-0165 Zinc Gas Strainer Filter
- 35-0497 Petcock Left, Zinc



# Side Valve Piston Kits



11-0404

**V-Twin Piston Kits** include 2 Cast Alloy Pistons, Ring Set, 2 Wrist Pins and 4 Circlips. All Flathead Pistons have a steel expansion control strut cast as original. All 74/80" Flat Heads have steel expansion strut as original.



11-2561

One Piece Cast Iron Ring Sets for two pistons with one piece oil ring.

Model	45 SV	45 SV	74" SV	80" SV
Comp	2.745"	2.745"	3 <sup>5</sup> / <sub>16</sub> "	3 <sup>7</sup> / <sub>16</sub> "
Ring	1 <sup>1</sup> / <sub>16</sub> "	3 <sup>3</sup> / <sub>32</sub> "	3 <sup>3</sup> / <sub>32</sub> "	3 <sup>3</sup> / <sub>32</sub> "
Oil Ring	3 <sup>1</sup> / <sub>16</sub> "	1 <sup>1</sup> / <sub>8</sub> "	3 <sup>1</sup> / <sub>16</sub> "	3 <sup>1</sup> / <sub>16</sub> "
Standard	—	—	11-2537	11-2545
.010	11-2561	—	11-2538	11-2546
.020	11-2562	11-2523	11-2539	11-2547
.030	—	—	11-2540	11-2548
.040	11-2564	—	11-2541	11-2549
.050	11-2565	—	11-2542	11-2550
.060	11-2566	11-2527	11-2543	11-2551
.070	11-2567	11-2528	11-2544	11-2552
.080	—	—	11-2553	11-2554

Flathead Size	45" SV 3 <sup>3</sup> / <sub>32</sub> " Top	45" SV 1 <sup>1</sup> / <sub>16</sub> " Top	74" SV 3 <sup>5</sup> / <sub>16</sub> " Bore	80" SV 3 <sup>7</sup> / <sub>16</sub> " Bore
STD	11-0400	—	11-0415	11-0408
.010	11-0401	11-0466	11-0416	11-0409
.020	11-0402	11-0467	11-0417	11-0410
.030	11-0403	11-0468	11-0418	11-0411
.040	11-0404	11-0469	11-0419	11-0412
.050	11-0405	11-0398	11-0420	11-0413
.060	11-0406	11-0399	11-0421	11-0414
.070	—	11-0472	11-0422	11-0424
.080	—	—	11-0423	11-0425



The Ring Leader<sup>®</sup>

45" Hastings Rings.		
Model	45" & 55"	45"
	1952-73 G & K	1937-52 G & W
	2 <sup>3</sup> / <sub>4</sub> "	2 <sup>3</sup> / <sub>4</sub> "
Comp Ring	1 <sup>1</sup> / <sub>16</sub> "	3 <sup>3</sup> / <sub>32</sub> "
Oil Ring	3 <sup>1</sup> / <sub>16</sub> "	1 <sup>1</sup> / <sub>8</sub> "
Mfg.#	4244	5044*
Standard	11-0144	11-2529
.010	11-0145	11-2530
.020	11-0146	11-2531
.030	11-0147	11-2532
.040	11-0148	11-2533
.050	11-0149	11-2534
.060	11-0150	11-2535
.070	11-0151	11-2536

\*Note: Features One Piece Oil Control Ring

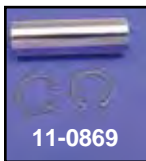

11-0869

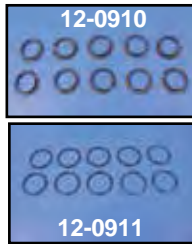

12-0910

12-0911

### Wrist Pin and Lock Kits.

VT No.	OEM	Year/Model
49-7606	22775-36	1936-48 Big Twin Side Valve
49-7608	.002 Oversize	1932-51 45 SV
11-0869	22719-52	1952-73 45 SV
<b>Wrist Pin Locks, 10 packs.</b>		
12-0910	22581-32	1932-53 All Twins
12-0911	22582-52	1952-77 All Twins



A

B

**Cylinder Base Nuts** include washers.

Chrome	Cadmium	Parkerized	Fits
7017-16			1936-78 Big Twin, Acorn (A)
8104-16	8105-16	9623-16	1936-78 Big Twin (B)
8106-16	8107-16	9624-16	45's (B)
9715-8	8171-8	9716-8	7 <sup>1</sup> / <sub>16</sub> " Lockwashers (B), 8 pack



49-0685

49-0686



**Cylinder Base Studs** feature heat treating and interference thread at cylinder base. Sets of eight.

VT No.	OEM	Year	Fits
8856-8	16831-30	1930-77	74" and 80"
12-2100	16831-30	1930-77	74" and 80"
12-1192	16830-29	1929-73	45"

**Big Twin Side Valve Cylinder Sets** are available to fit both 74" and 80" side valve motors. Sold in sets only. These cast iron cylinders are ready to be fitted with pistons. Thirteen fin style cylinders that have valve guides and intake manifold nipples installed. Kit includes standard piston kit pre-fitted to cylinder bore size.

Set	Size	Kit
49-0685	74"	49-1385
49-0686	80"	49-1386



49-0378



49-0193

**Replica Cylinder Sets** include front and rear cylinders. 49-0378 WL includes pistons and rings.

VT No.	Type	Guides
49-0378	WL	Yes
49-0193	W	No, Front



**45" Top End Kit** includes 45 valve cover kit, 45 lifter kit, valve spring kit, front & rear 45 cylinder, 2 Sifton intake valves, 2 Sifton exhaust valves, high compression head, gasket kit, headbolt kit, and washer kit.  
VT No. 49-0865

CLASSIC





# Side Valve Valves and Guides



11-0600

Valves			
Model and Year	Type	OEM	Steel
VL-74	Intake	163-30	11-9647
UL-ULH-74 & 80	Intake	18070-37	11-0600
1937-48	Exhaust	18082-37	11-0611
45 cubic inch	Intake	18070-32	11-0601
1932-73	Exhaust	18080-32	11-0612



11-0792

Cast Iron Guides			
Model and Year	Intake	Exhaust	
45" Flathead 1929-73			
Standard	11-0792	11-0792	
+002	11-0822	11-0822	
+004	11-0823	11-0823	
UL & ULH Flathead 74" & 80"			
Standard	11-0793	11-0793	
+002	11-0825	11-0825	



**GB Valve Guide Gaskets**, 20 pack. Replaces 18198-38. Fits Side Valve/1929-73.  
VT No. 15-0256

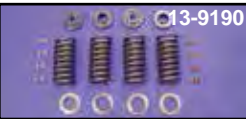

**Valve Spring Kits** include all springs, collars and keepers necessary for each application.

VT No.	Model	Year	Item
13-9188	45"	1932-40	Kit
13-9189	45"	1941-73	Kit
13-9190	74-VL	1930-36	Kit
13-9191	74 and 80 UL-ULH	1937-48	Kit
11-0657	UL	1930-48	Collar Kit Only

## Valve Spring Sets Only, Set of 4

VT No.	Year	Model
13-9153	Big Twin Side Valve	1930-48
13-9155	45 Side Valve	1941-73
13-9214	45 Side Valve	1930-40

## Bolt Kits

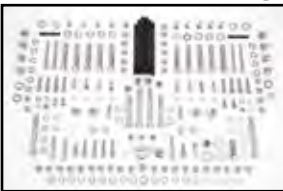

Chrome

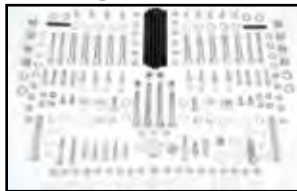

Cadmium

**Stock Style Hardware Kit** contains all the stock engine nuts, bolts, washers and studs for your engine in choice of chrome or cadmium plating. Kit includes primary cover screws, lifter base screws, circuit breaker screws, case studs and nuts, timing plug, cam cover screws, cylinder base nuts and washers, oil pump nuts and bolts, trans side cover nuts and washers, transmission top screws, transmission fill plug, generator screws, head bolts and washers. For 1948-64 Panhead Kits, order proper length Panhead cover screws separately.

Chrome	Cadmium	Year	Model
8304 CHR	8304 CAD	1936-39	74 and 80 Side Valve with Cast Iron Heads
8305 CHR	8305 CAD	1940-48	74 and 80 Side Valve with Cast Iron Heads
—	8306 CAD	1940-48	74 and 80 Side Valve with Aluminum Heads
8308 CHR	8308 CAD	1937-73	45 with Cast Iron Heads
8309 CHR	8309 CAD	1937-73	45 with Aluminum Head



**Tappet Set** with lifter bases fits 1929-73 45's.  
VT No. 49-0850

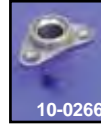

10-0266



49-0797

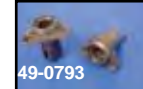

49-0793

## 45 and Big Twin Side Valve Steel Lifter Base.



VT No.	Fits	Type	Qty
49-0793	Front	Thread	Set
49-0797	Rear	Thread	Set
10-0234	Rear 45"	Thread	Each
9622-16	Screw	Parkerized	Set
8103-16	Screw	Cadmium	Set
8102-16	Screw	Chrome	Set



10-0567

**Side Valve Tappet Assemblies** to fit 45, UL and K-Model Side Valves. Include roller assembly installed. Choose Jims or Sifton "Lightning brand". Jims does not include adjuster screws or nuts where necessary.

Replaces 18490-29.10-0567 does not include screws.

Big Axle Jims	Standard Sifton	Size	U/M
—	10-0567	Standard	Set
10-0651	10-0506	Standard	Each
10-0652	10-0507	.005	Each
—	10-0528	.010	Each
—	10-0989	.005	Set
—	10-0990	.010	Set



10-0543

**1930-73 Side Valve Tappet Adjuster Screw Kit** for Flathead includes 4 screws and 4 matching lock nuts.

VT No.	OEM	Item
10-0543	Kit	V-Twin
12-0523	18570-38	Nut (10)
10-0519	18556-40	Screw (4)
2779-8	Kit	Colony
10-0519	18556-40	Screw (4)



**45 Wrap Around Tank.** Front mounts to clutch cable frame mount and rear frame fender cross brackets.  
VT No. 40-0964



**Tappet Roller Repair Kit** includes 4 pins and 4 roller assemblies. Use tool VT No. 16-0874 for accurate removal and reassembly.

VT No.	Type
10-0520	18534-29A, 1929-84
12-1179	Pins Only, 10 pack



**Set of 45 Frame Castings** includes all drop forged frame parts to build your own WL model race frame. Fits 1936-1952 W.  
VT No. 49-2522



# Fender

Note: All Items Shipped with a Raw Finish may have some oxidation (rust on surface)!

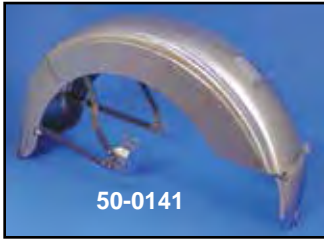

50-0141



50-0179



50-1053



50-1159



50-0168



**Rigid Rear Fender Mounting Kit** includes hardware to install rear fender on 1929-52 45's.

**45 Solo Finish**  
 9791-15 Cadmium  
 9790-15 Chrome  
 9792-15 Parkerized

## 45" Solo Fender.

VT No.	Item
50-0141	1936-52 with Narrow Braces
50-0179	1936-52 with Narrow Braces
50-0168	1936-52 Skirt Set Only
50-1053	1949-57 only
50-1159	1936-52 Bobbed
50-0771	Army Rear
50-0931	Hinge and Pin
37-8840	Pin
50-0553	1934-46 Rear Tail Bracket
50-0557	Rear Brace V
50-1207	Fender Pieces



50-0914

**Stainless Fender Trim** for 1939-48 Big Twin and 45", 1940-49 Spring fork front Includes clips.

VT No.	Fits
50-0914	Front
37-8458	Clips, 25 pack



37-6368

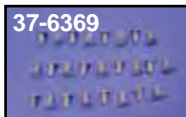

37-6369



37-6370

**Replacement Fender Rivets** fit all FL front and rear fenders and FX front fenders, pack of 25.

VT No.	Fits
37-6368	Big Twin Fender Brace
37-6369	Big Twin Fender Top
37-6370	FX Front, 1973-up Stainless

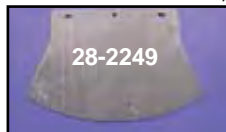

28-2249

**Early Mud Flap** replaces 59235-26 in rubber with laminated cloth construction.

VT No.	Item
28-2249	Mud Flap
49-0425	Mount Hardware



45-0102

**WR Spool Front Wheels** available in 18" and 19" with 2.15" width rim and 6-8 gauge spokes. Hub is nickel plated, spokes are stainless, rim is black. Hub has retro fitted with sealed ball. Bearings to accept a 3/8" axle.

WR Front Spool Wheel.	52-0305	18" Rim
VT No.	Size	52-0025 18" Rim
52-0013	18"	45-0107 Hub Rear
52-0014	19"	
45-0102	Hub Front	

# Case

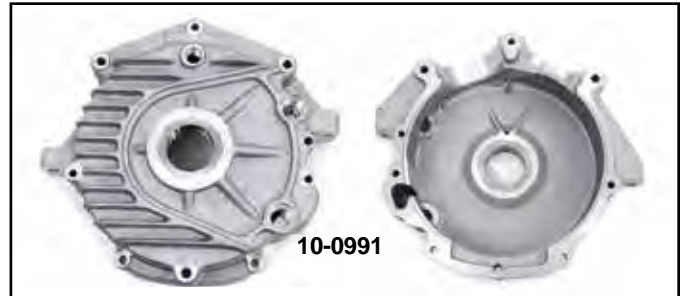

10-0991



10-0879



10-0879



10-0953

**Left Cases** are without serial numbers.

VT No.	OEM	Fits
10-0991	406-37A	WL
10-0879	24536-37	UL
10-0953	Set	UL



50-0144



50-0778



50-0454



50-0750



50-0523

**Spring Fork Front Fenders** are 7½" wide for 16" or 18" wheels with riveted on wide braces. The 45" type fits with rockers inside the fork. Big Twin fits with outside rockers.

VT No.	Year/Model
50-0144	1936-48 Big Twin
50-0750	1936-46 Big Twin
50-0778	1936-52 45"
50-0454	1936-52 45"
50-0523	1949-52 45"
50-0643	1934-35 VL
50-0463	1934-35 DL





# 45 Gas and Oil Tanks



**45 Tank Set** features oil and gas set. Fits 1936-73 Solo and Servi-car.

VT No.	Item	Year
38-0480	WR (5 gallon)	1947-52 (Gas Both Sides)
38-0488	WR (Narrow)	1936-54
	Right Side Oil, Left Side Gas	
38-0492	WR (3)	1947-52
38-0595	Tank 5 Gallon	1936-46
38-0114	Tank Set	1936-46
38-0594	Tank Set	1947-73
38-1645	Brackets	1941-73

**\*Note:** All tanks with shut off rod provisions may require fuel rod alignment before installation of shut off assembly.

**38-7018** **Early Chrome 45 Gas Oil Cap Set** fits 1936-73 models, oil cap says "OIL"

VT No.	Item
38-7018	Set
49-0108	Oil Only

**38-7009** **38-0198**

**Viton Tip**

**Fuel Shut Off Rod Kits.**

VT No.	Fits	Type
38-7009	1941-49	Stock
38-0198	1950-57	Stock
38-0971	1941-49	Viton
38-0431	1941-54	Viton
38-6653	1941-65	Stock
38-1135	1950-65	Stock
38-0418	Rod Only	Viton
35-0291	Viton Tip	



**Gas Valve Shut Off Tool** replaces 96365-42 to correct alignment of bottom and top holes of 1940-65 gas tanks.

VT No.	Item
16-0615	OE Style
16-0182	Shop



**Top of Tank Screw and Washer Kit** mount tank to frame on 1918-36 45's. Includes paper gasket to avoid paint chipping.

VT No.	Item
8821-18	Nickel Plated
8822-18	Cadmium Plated



**45 Solo and Servi-Car Gas/Oil Tank Mount Bolt Kits** includes special washers, studs, and bolts.

Chrome	Parkerized
9894-12	9896-12



**45 Tank Filler Strip** replaces 3502-37B on 45's and Servi-Car 1937-1973.

VT No.	Item
49-0121	Zinc
49-2526	Chrome



**Oil Dip Stick** replaces 62631-37 on all 45's 1937-73. VT No. 49-0084



**Cables** fit 1937-52 45" Solo models.

VT No.	Type	OEM	Length	End
36-0622	R. Wheel	67023-37	50"	5/8" M
<i>Fits 1937-52 45" Solo Models fit late type VT Speedo.</i>				
36-0624	R. Wheel	—	50"	5/8" F
<i>Fits 1937-61 Servi-Car Models.</i>				
36-0600	Rear End	67028-51	54 1/2"	5/8" M
<i>Fits 1962-73 45" Servi-Car Models.</i>				
36-0626	Rear End	67028-62	54 1/2"	5/8" F



**Side Valve Speedometer Cable Clamps** note cable size of fitment.

Colony	VT No.	#	OEM	Fits	Type
9649-5	37-9234	D	67086-39	1937-48 UL	Mid
9647-1	—	B	67074-37	1937-53 45	Mid
9648-1	37-9219	C	67076-41	1937-53 45, rear	Mid



# Carburetor



**45 Mikuni Carburetor Kit** includes 34mm Mikuni carb, adapter flange to fit 1936-52 Stock Manifold 27024-36, Anderson style 1" twist grip assembly, air cleaner and cable. Order VT No. 49-0207 manifold separately.

VT No.	Item
35-0107	Carburetor Complete Kit
49-0207	Replica Manifold
34-0534	34mm Air Cleaner
34-0521	Cleaner Adapter

**Mikuni Carburetor Parts and Information Manual.**  
VT No. 48-0671



**Three Bolt Mikuni Adapter** will adapt a 34-36mm Mikuni or VT carb to large three bolt 45 and 74-80 side valve manifold. Includes two clamps and rubber coupling.

VT No.	Item
35-0216	Kit
35-0841	34 mm Carb Only
37-0812	Clamps
35-0116	Spigot
35-0117	Rubber



## Flathead Intake Manifolds.

VT No.	OEM	Fits
49-0207	27011-36	1936-73 45" WLA Kit
35-8019	27012-37	1937-48 74 and 80 ULH Kit
35-0541	27043-41	Spacer Block
15-0420	—	Gasket Kit, 3 Bolt
15-0629	—	Gasket Kit, 3 Bolt
35-0885	—	Insulator Spacer
49-2516	—	Manifold Only WL
35-0282	—	OEM Manifold, WL
49-2517	—	Manifold Only U
35-0286	—	Manifold K, WR
35-1707	—	Inserts
35-1952	—	Nut Set
35-0937	—	WR Kit
35-0117	—	Intake Spigot Rubber Adapter
35-0957	—	Seal Set WR
15-0420	—	Gasket Set

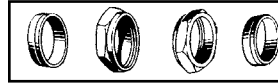

**Intake Manifold Nuts and Brass Seals** are available in pairs. Order seals separately.

1930-48 U-ULH, & 1940-46 WLD Models

Nuts	Finish	Brass Seal
8012-2	Chrome	8006-2
9702-2	Parkerized	8006-2
8007-2	Cadmium	8006-2
—	—	35-0285

1937-73 45" Models

8227-2	Chrome	7356-2
8228-2	Cadmium	7356-2
9703-2	Parkerized	7356-2



**Intake Manifold Nipples** have threaded inserts, sold each. Screws into cylinder.

VT No. Fits Models

9422-1	1937-73 45 WL and G
9423-1	1930-48 Side Valve 74 and 80, WLD



32-1282



32-1547

**Generator 12V Conversion Kit** includes alternator and black solid state regulator. Fits 1936-1952 W and 1936-73 G. Order gear kit separately.

VT No.	Item
32-1282	Alternator
32-1547	SV Gear Kit



32-1781



32-1785

**Alternator Conversion Kit** includes 12 volt alternator, correct gear with slinger deflector, oil gasket, nut and finned solid state chrome regulator. Fits 1937-73 45" models.

VT No.	Finish
32-1781	Chrome
32-1785	Black



Stock Generator Mounting Screws.	Chrome Cad	Parkerized	Brush
For 45" 1937-57			
8207-2	8208-2	9712-2	3
For 45" 1958-73			
8209-2	8210-2		2
For 74" and 80" ULH 1930-48			
9108-2	9109-2		3





# 45" Parts



**V-Twin 45" Model Primary Belt Kit** includes steel front pulley and clutch drum for 1929-73 45" model kickstart only and 1 1/2" wide belt. For open primary use only.

VT No.	Item
20-0524	Complete Kit
20-0034	Belt



**1941-64 45 Primary Chain Drive System.** Kits include 96 or 100L Diamond primary chain, clutch drum and hub with steel and fiber clutch plates with pressure plate assembly. Front motor sprocket and nut included.

VT No.	Links	Model
18-0115	100	45 Solo
18-0116	96	Servi-Car
18-0782		Clutch Pak



## Brake and Foot Clutch Control Kits.

VT No.	Item	Year
49-1272	Clutch Pedal Kit	1941-73
49-1278	Jockey Pedal Kit	
22-1970	Brake Pedal Assembly	1936-51
22-1971	Chrome Foot Clutch Assembly	1936-52
22-1972	Parkerized Foot Clutch Assembly	1936-52



**45 Hand Clutch Kit** fits 1941-73 models, includes cable, cable bracket and handle. Zinc plated.

VT No.	Item
22-0808	Hand Clutch Kit
49-0275	Cable Bracket

# 45 Foot Clutch

## 45 Clutch and Brake Lever Parts

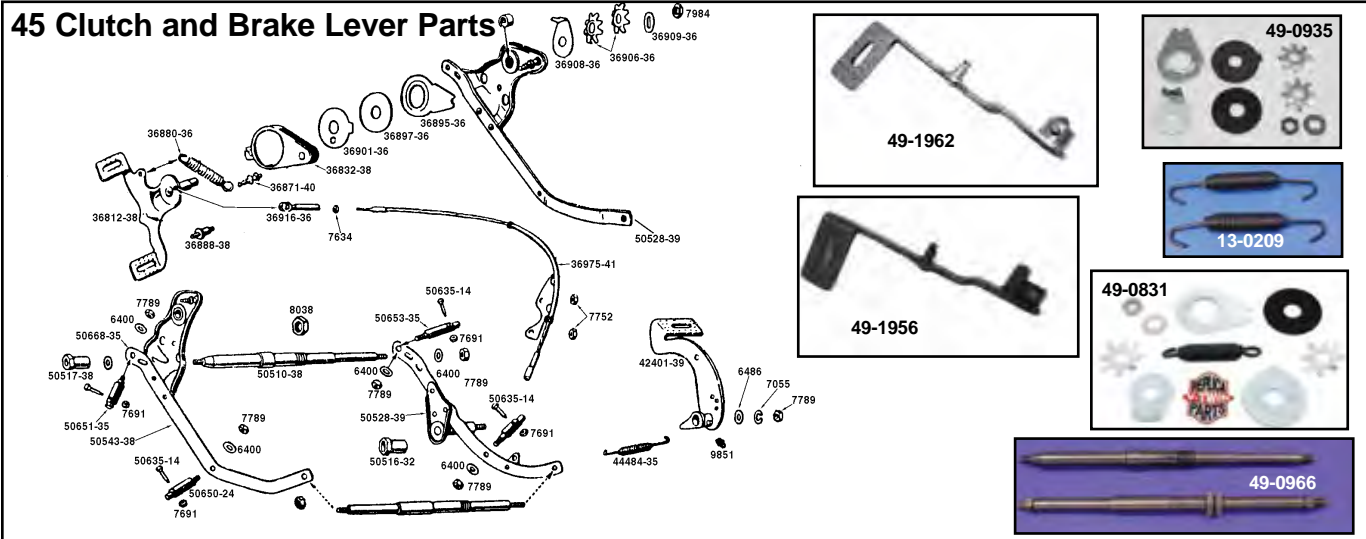

### 45" Clutch and Brake Lever Parts 1941-52 Solo models.

VT No.	OEM	Item
49-2002	36812-38	Rocker Lever, Chrome
49-0932	36812-38	Rocker Lever, Parkerized
49-1962	Chrome	Jockey Pedal
49-1956	36813-47A	Jockey Pedal
2351-2	—	Lever Pivot Shaft
2654-6	—	Servi-Car Lever Stud
2669-6	—	Servi-Car Lever Stud
49-0934	36832-38	Cover, Chrome
49-0943	36832-38	Cover, Black
49-0663	2409-39	Cover, 1936-39
10-2508	36857-36	Brass Bushing for Bracket
13-0170	36880-36	Spring, Chrome
13-0743	36882-47	Cable Spring
2353-2	36871-41	Spring Stud
37-8956	36895-36	Bracket Friction Disc, each
37-8955	36897-36	Fibre Washer, 5 pack
37-8957	36901-36	Steel Disc 45, each
37-8937	36906-36	Spider Washer, 5 pack
37-8958	36908-36	Washer Disc, each
37-8954	36909-36	Lock Plate, 5 pack
49-0933	36916-36	Cable End, 10 - 32, Zinc
49-1723	—	Cable End, Servi-Car
49-0160	36975-41	Cable Assembly, Parkerized 1941-46
49-1732	36975-41	Cable Assembly, Chrome 1941-46
49-1668	36975-47	Cable Assembly, Parkerized 1947-52
37-8959	7984	Rocker Pedal Nut, 5 pack
49-0831	—	Friction Kit (9 Piece)
49-0935	—	Kit, Eight piece. Friction Set includes: 36901-36, 36897-36, 36895-36, 36908-36, 2 (36906-36), 36909-36, 7984 Nut (8 pcs.)



**Foot Clutch Bracket Bushing Installation Tool** fits Big Twin and 45.  
VT No. 2550-2

### Continued 45 Clutch and Brake Lever Parts Listing

VT No.	OEM	Item
49-2008	42401-39	Brake Pedal, Black
49-2009	42401-39	Brake Pedal, Chrome
49-1274	42401-39	Brake Pedal, Black
49-1374	Kit	Brake Pedal, Black
49-1375	Kit	Brake Pedal, Chrome
13-0209	44484-35	Brake Return Spring, pair
13-0213	44484-35	As Above, Chrome, each
13-0275	44484-35	Brake Spring, Parkerized
49-0965	50510-38	Front Support Rod, Black
49-0966	Set	Front and Rear Support Rod
37-9247	50516-32	Rear Rod Nut, each
37-9246	50517-38	C-Front Rod End Nut, 5 pack
9802-14	Kit	Rod End Nut Kit, Parkerized
<b>Footboard Mount Straps</b>		
49-2080	Clutch	Strap, Solo, Left, Chrome
49-2064	Clutch	Strap, Solo, Left, Parkerized
49-2067	Strap	Brake Pedal Strap, Solo, Left & Right, 2 pk
49-2066	Strap	Clutch, Parkerized, Servi-Car, Left
27-3600	Kit	Footboard Supports
8773-12	50635-14	Footboard Hinge Bolt Set
49-2064	Strap Solo,	Left, Black
49-1956	Pedal	Servi-Car, left clutch
49-1962	Pedal	Servi-Car, Chrome
27-0600	Kit	Footboard Supports, Black
23-0936		Servi-Car Brake Pedal Kit





**1940-46 Shifter Gates** for 45 models. Pattern is noted from top to bottom.  
**Gear from Top to Bottom**

VT No.	OEM	Speed	Type	Pattern
49-0107	33785-40	3	Black	1N23
49-0073	33790-39	3	Chrome	1N23
49-1317		3	Black	Smooth (No Number)
49-0040	33785-40	3	Chrome	1N23
49-0042	Army	3	Black	1N23
49-0027	33786-47	3 & R	Chrome	
49-0147	33786-40	3 & R	Chrome	R1N23
8212-3	33822-36	3 & 4	Gate screws (3)	Chrome
37-9026	1940-46		Gate screws (2)	Chrome

**Shift Gate** for late type for Big Twin, 1947-65.

VT No.	OEM	Fits	Speed
49-0074	33785-47	1941-51 FL	3 32NI
49-0111	33791-47	1947-65 FL	3 32NIR
		1947-48 EL	

## Rubber Pad Sets



Left Side



Right Side

**Clutch and Brake Pads** in a three piece sets unless noted.

VT No.	Color
28-0301	Black
28-0302	White
28-0551*	Black 1 piece *Note: Oval Pad only
28-0312	Black, Replica

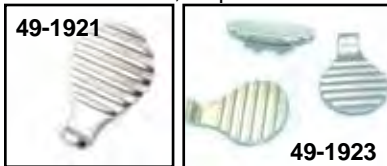

**Rocker Clutch Petal Pads.** Cast original style with nickel plating.

VT No.	Type
49-1921	Toe
49-1923	3 Piece Set

## Side Valve Line Set

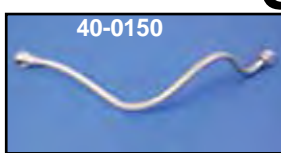
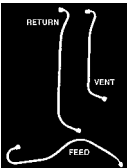

**Flathead 74 and 80 Oil Line Sets** VLs are two piece sets, in cadmium. UL-ULH are three piece sets.

VT No.	OEM	Type	Years	Model
40-0369	—	Set	1930-33	VL
40-0368	—	Set	1934-36	VL
40-0373	—	Set	1937-48	UL-ULH
40-0105	—	Set	As Above	Chrome
40-0150	3571-37	Feed	1937	UL
40-0151	3571-38	Feed	1938-48	
40-0152	3572-37	Vent	1937	UL
40-0153	3572-38	Vent	1938-48	UL
40-0154	3571-37B	Return	1937	UL
40-0155	3571-38B	Return	1938-48	UL

## 45" Hand Shifter

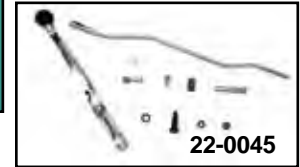

**Shifter Lever Kit** includes correct gate, rod, end, pivot bolt and shift lever in chrome for left side mounting. Note: Pattern from front to rear.

VT No.	OEM	Type	Pattern
1936-46			
22-1098	45 Servi	3-Speed and Reverse	R1N23
22-1079	45 Solo	3-Speed	1N23
1947-73			
22-1080	45 Servi	3-Speed and Reverse	32N1R
22-0045	45 Servi	3-Speed and Reverse	32N1R
1947-52			
22-1081	45 Solo	3-Speed	32N1
1938-73			

21-1938	33675-37A	Chrome Lever	
21-1937	33675-37A	Painted Lever	
21-0157	33675-37B	Chrome Lever	
21-0187	33675-37	Chrome Lever	
7818-5	33775-37	Pivot Bolt Kit	
<b>45 Shifter Rods</b> with hook end.			
21-1939	33859-41	Cadmium	
21-2043	33859-41	Chrome	
21-2069	33859-41	Parkerized	
21-0946	33851-47	Zinc, Servi-Car	
21-0976		Chrome Servi-Car	
2647-3		Pin	
21-0475		Pin threaded	
21-0231		Rod End Kit	



**45 Jockey Lever Kit** fits 1941-73 Solo and Servi-car, rod must be fabricated.  
**VT No. 49-1941**



**Shifter Lever Stud and Bushing Kit** to mount shifter lever on 1936-54 Twins with handshifter.

VT No.	Finish
7818-5	Cadmium
9711-5	Parkerized
9018-5	Chrome



**1938-73 45 Flathead and Servi-car** available in chrome or cadmium, Sold in sets or individual pieces.

Chrome	Cad	OEM	Item
40-0372	40-0104	3 piece	Set
40-0136	40-0139	63510-37	Feed
40-0137	40-0140	63570-37	Vent
40-0138	40-0141	63507-38	Return
—	40-0522	25235-36	Vent Nipple
—	40-9998	63590-41	Rear Chain Oiler
—	40-0518	63573-36	Banjo Bolt
—	14-0154	6440	Washer, 10 pk
—	40-0670	63577-36	Banjo Only
—	40-0157	3570-36B	Feed Washer



**Ground Clamp** attaches to oil line on 1936-40 models, each.  
**VT No. 31-0275**

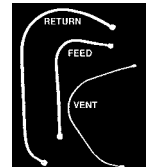







# 45" Transmission

45" Transmission Hardware for 1938-73 3-Speed and 3-Speed with reverse models.

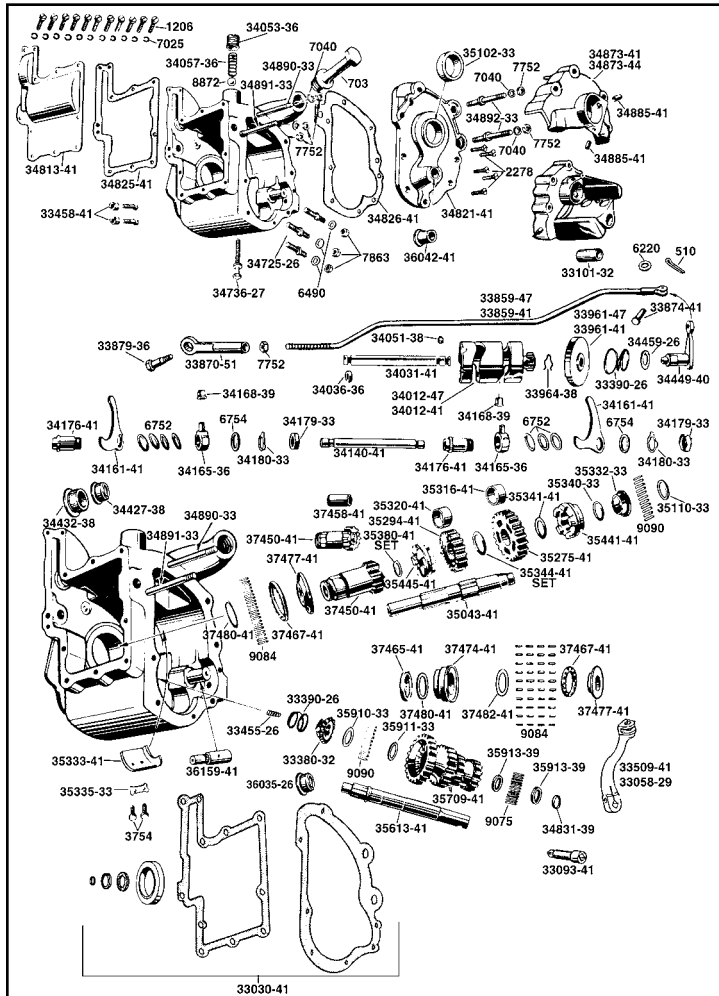

VT No.	OEM	Item
8610-1	704	Fill Plug to 1940, Chrome
8611-1	704	Fill Plug to 1940, Cadmium
8631-1	703	Fill Plug, 1941-73 Chrome
2655-1	703	Fill Plug
9411-27	1206	Top and Side Cover Screw Kit, 1941-73 Cadmium
9410-27	1206	As Above, Chrome
9666-27	1206	As Above, Parkerized
2655-1	2326-35	Transmission Fill Plug
15-0607	33030-41	Gasket Kit
49-2581	33058-29	Kick Arm, Servi-Car, Black
13-9248	33084-41	Kick Spring, Black
13-0122	33084-41	Kick Spring, Chrome
9754-1	33088-41	Kick Stud, Chrome
9755-1	33088-41	Kick Stud, Cadmium
9756-1	33088-41	Kick Stud, Parkerized
49-1999	33093-41	Kick Shaft, Extension, Servi-Car
10-2493	33101-32	Bushing Starter Shaft
17-9867	33380-32	Starter Clutch
13-0167	33455-26	Countershaft Spring
37-8256	33456-26	Tripper Screw, 2 pack
9761-4	33456-26	Tripper Screw and Nuts
8628-6	33458-41	Nut, 6 pack
49-1931	33509-41	Arm, Black
37-9171	33874-41	Clevis Pin
49-1032	33961-47	Shift Gear
17-9772	34051-38	Lock Screw
17-0134	34031-41	Shifter Shaft Cam
49-0082	34140-41	Shifter Fork Shaft
49-0203	34161-41	Shifter Fork
17-0097	34165-36	Shifter Finger
17-0117	34168-39	Shifter Finger Rollers, pair
17-0049	34176-41	Shifter Finger Bushing
10-2518	34427-38	Shifter Shaft Small Bushing
10-2514	34432-38	Shifter Shaft Large Bushing
17-9832	34449-40	Inner Shift Lever
49-1671	34449-52	Inner Shift Shaft
17-0983		Shifter Lever Clip
14-0633	34459-26	Shift Leather Seal
49-0172	34702-41	45 Transmission Case
49-0269		Case
9837-10		Transmission Mount, Chrome
9838-10		Transmission Mount, Cadmium
8625-1	34736-27	Gear Box Adjusting Screw, Cadmium
9693-1	34736-27	As Above, Parkerized
9729-1	34736-27	As Above, Chrome
49-0080	34821-41	Side Cover
49-0205	34813-41	45" Trans Access Cover
14-0634	34831-39	Case Rubber Oil Seal, James
49-0419	34873-41	Sprocket Cover 1941-43 WL
49-0427	34873-44	Sprocket Cover 1944-53 WL
49-1722		Set
8621-16	34892-33	Chrome Sprocket Cover Stud Kit
8622-16	34892-33	Cadmium Sprocket Cover Stud Kit
9686-16	34892-33	Parkerized Sprocket Cover Stud Kit
N/A	2272-33	Main Shaft, 1933-40
49-0201	35043-41	Main Shaft, 1941-73
17-0821	35102-33	Replica Mainshaft 1941-73
17-9868	35102-33A	Main Shaft Outer Race
17-9884		As Above .005
17-9864	35110-33	Main Shaft Thrust Washer, 5 pack
12-0211	35195-26	Transmission Sprocket Key
19-0062	35204-41	17 tooth Countershaft Sprocket
17-0933	35216-26	Sprocket Lock Tab
14-0176	35221-36	Main Shaft Sprocket Seal
49-0414	35275-41	Main Shaft 1st Gear
17-9916	35284-41	Reverse Gear
17-9917	35294-41	2nd Gear
10-2515	35316-41	Low Gear Bushing
10-2517	35320-41	2nd Gear Bushing
10-2523	35326-33	Reverse Gear Bushing
17-9823	35332-33	45" Spacer Collar
2734-3		Lock Tab
17-9866	35340-33	Reverse Gear Thrust Washer, 5 pack
17-9865	35341-41	Low Gear Thrust Washer, 5 pack
17-9824	35344-41	Low and Second Gear Thrust Set
17-0149	33349-41	.040 to .075, 8 piece
17-9835	35380-41	Low and Second Gear .050 washer
49-0415	35441-41	Spacer Set
49-2004	35442-41	45" Low Gear, Shift Clutch
17-9834	35445-41	Shifter Clutch, Low and Reverse
49-0937	35612-64	45" Shifter Clutch, 2nd and 3rd
49-0202	35613-41	1964-73 45" Countershaft Elec Start
49-0204	35709-41	45" Trans Countershaft
49-0936	35709-64	45" Trans Cluster Gear 1941-63
17-9836	35910-33	1964-73 Electric Start
17-9837	35911-33	45" Outer Thrust, 5 pack
17-9838	35913-39	45" Inner Thrust
10-2547	36035-26	45" End Washer
10-2490	36042-41	Left Countershaft Bushing
17-9839	36141-41	45" Countershaft Bushing
8410-8	37077-44	Reverse Idler Gear
8411-8	37077-44	Clutch Arm Rebuild Kit 1944-52 Solo, Chrome
8904-6	37077-44	Clutch Arm Rebuild Kit 1944-52 Solo, Cadmium
8903-6	37076-41	Cadmium Clutch Arm Rebuild Kit 1941-43 Solo
8412-1	37287-41	Chrome
14-0126	37335-41	45" Throw Out Bearing Assy 1941-73
49-0413	37450-41	45" Clutch Pushrod Seal 1941-up, 5 pack
10-0553	37458-41	45" Transmission Clutch Gear
12-0556	37460-41	Clutch Gear Bushing
9533-2	37460-41	Clutch Hub Nut
17-0925	37460-41	Clutch Hub Nut Kit
14-0169	37462-41	45" Clutch Hub Lock Tab
14-0642	37460-41	Clutch Gear Oil Seal
12-0343	37465-41	Clutch Gear Oil Seal, James
17-9926	47467-71	Thrust Bearing
17-9841	37474-41	45" Roller Bearing Race
17-9842	37477-41	45" Clutch Gear Bearing Race
17-9915	37480-41	Clutch Gear Thrustwasher, Left Side
	37482-41	Countershaft Washer

**45" Mainshaft Transmission Rollers set of 24.**

24 Pack	100 Pack	OEM	Size
17-9211	12-4581	9075	Standard
17-9212	12-4582	9076	.0004
17-9213	12-4505	9077	.0008

**45" Countershaft And Mainshaft Rollers set of 40.**

40 Pack	100 Pack	OEM	Size
17-9214	12-4584	9090	Standard
17-9215	12-4585	9091	.0004
17-9216	12-4586	9092	.0008

**45" Mainshaft Roller Set (44 Pieces Required)**

44 Pack	100 Pack	OEM	Size
17-9217	12-4576	9084	Standard
17-9218	12-4577	9085	.00044
17-9219	12-4578	9086	.0006
12-4609	12-4579		.0008
17-9220	12-4580		.0010

**4-Speed 45" Transmission Kits for 1941-63 Kick Start**

VT No.	Type	Complete
49-0871*	3 Speed	Complete
17-0731*	4 Speed	Complete
49-0851*	3 Speed and Reverse	Complete
49-0649*	4 Speed Gear Kit	3-Speed

Converts 3-Speed to 4-Speed  
Door 4-Speed

\*Note: Clutch lever and housing not included.  
\*\*Note: Requires VT No. 49-0455 door



WR 3rd Gear includes bushing and washer.  
VT No. 49-0598

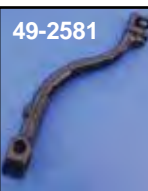
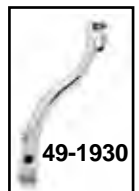

**45" Kicker Arms.**

VT No.	OEM	Type/Finish
49-1931	33509-41	Solo/Black
49-1930	33509-41	Solo/Chrome
49-2581	33058-29	Servi-Car/Black
49-2600		Servi-Car/Chrome
17-0283		45 Kick Pedal

**45" Kicker Arm Bolt Kit**

Parkerized	Chrome	Model
2792-3	2784-3	WL
2797-3	2798-3	Servi-Car



**45" Transmission Shifter Drum** is rolled and formed as original and allows 1947-up forward shift patterns on 45 transmissions.  
VT No. 49-1028

CLASSIC





# 45" Solo



**32-0704** Early Twins Wiring Harness Kits are complete and feature cotton braided wire and asphalt loom.

VT No.	OEM	Application
32-0700	4735-30	1930-36 RL
32-0701	4735-36	1936-37 WL
32-0703	4735-38A	1938-46 WL
32-7555	4736-42M	1942-45 Army 45"
32-0704	70320-47	1947 WL-G
32-0705	70320-48	1948-57 WL



**45" Speedo Cables** are 50" long.

Zinc	Chrome	Nut
36-2571		Male
36-2572	36-0935	Female

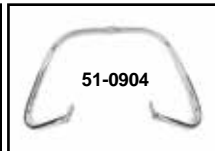
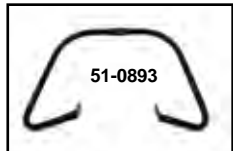

Rear Frame Bars fit Rear 45" Solo 1929-52.

VT No.	OEM	Finish
51-0893	13030-39	Black
51-0904	13030-39	Chrome



**Weld On Frame Hardtail** features raw forged rear axle plates as original.  
VT No. 51-0465

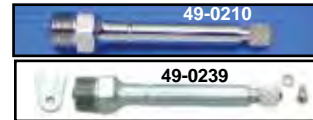

**Speedometer Drive Units** include housing and gear as OEM replacement, for transmission drive. 45" types are for the rear wheel. Fits 1937-52 45" Solo.

VT No.	OEM	Teeth	Finish
49-0210	67129-37	8	Chrome
49-0239	67129-37	8	Zinc
49-1745	Kit		Parkerized
49-1746	Each		Parkerized
49-0209	67080-37		Retainer for Above
15-0184	67141-36		Mount Gasket



Watch on YouTube!  
<https://www.youtube.com/watch?v=NX00E7eLxS0>



**49-2501** Luggage Carrier fits 45" Rigid frames only. Includes military saddle-bag mount bracket fastened in place army finish.

VT No.	Item
49-2501	Carrier
2541-19	Bolts Big Twin

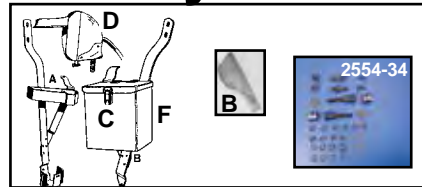

**45" Military Replicas** in primer finish, mounts to front spring forks.

VT No.	#	Item
49-0127	A	Machine Gun Bracket
49-0915	B	Machine Gun Leather Scabbard
49-0399	C	Ammunition Box
49-2571	D	4" Blackout Spotlight with visor (NOS)
49-0194	F	Blackout Box
2554-34		Mount Kit, Gun Bracket
2590-13		Skid Mount

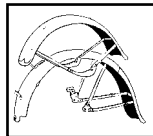

**45" Military Fenders** are skirtless Army style of 1940's for 45" Solo models with Spring Forks 1937-52.

VT No.	OEM	Type
50-0771	3710-41A	Rear
50-0772	3702-41	Front



**Wiring Harness Kits** feature cotton braided wire with asphalt loom and handlebar and tail lamp wires included. Replaces 4736-42M, fits 1942-45 Army 45."

VT No.	Item
32-7555	Harness
2618-12	Switch Spacers



**Army Brake Handle**, Cast iron parkerized.

VT No.	Item
26-0583	Handle
49-1327	Tab
49-0035	Clutch Pedal
16-0341	Rivet Tool

### WLA Components (NOS)

VT No.	Item
49-0496	Main Switch
49-0019	Army OE Ignition Switch



**Hand Lever Lock Tab**.  
VT No. 49-1327



**Kick Starter Flat Rubber Pedal Assembly** includes mount bolt pin kit with bushing for one piece kick starter arms 1936-76 models.

VT No.	Item	Color/Style
17-0283	Complete Pedal	45"
28-0341	Rubber	Black, 45"

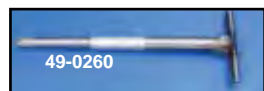

### WLC Military Axles.

VT No.	Type
49-0260	Front
49-0057	Rear



**Army Saddlebags** are constructed of brown leather. Replace 11786-43 and include mount strap with pins to attach to luggage carrier.

VT No.	Item
48-3164	Bag Set
49-0985	Ammunition Box
49-0986	Cast Luggage Rack



**45" WLA Repair Manual**.  
133 pages, color diagrams.  
VT No. 48-0521



**45" WL Patch**.  
VT No. 48-1637



**45 Gift Set**  
VT No. 48-0522

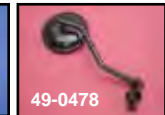

**Military Mirror** features black finish with adjustable stem and clamp set. Replaces 11350-41M.

VT No.	Type
49-0138	V-Twin
49-0478	Replica Black
49-0274	Replica Military Style
49-0952	Black Face Only



### 45" Air Pump and Clamps.

VT No.	Item
49-2539	45 Tire Pump
	11553-41M

**49-2536** Clamps, 11557-40M



**Oil Bath Bracket** fits Army 45" replaces 1430-41M.

VT No. 49-0166



**Army 45 Shifter Gate**.  
VT No. 49-0014

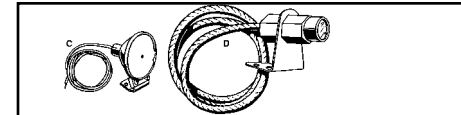

**Military Lamps** for WLC. 1942 unless noted.

VT No.	#	Type
49-7682	C	Front Marker
49-7683	D	Front Marker



**Military Fork Guard** fits between top fork springs and replaces 11305-36N.  
VT No. 49-0440



**Army Rocker Clutch Pedal** to fit 19836-52. May have rust. 70 year old part.  
VT No. 49-0035



**Seat "T" Bar** to fit Army 45" models. Includes front bushing.  
VT No. 31-0620



**45 WR Exhaust Drag Pipe Set** features a radius that bends for better exhaust flow and a chrome finish. Fits 1936-1952 W.

VT No.	Finish
30-1306	Chrome
30-1310	Black



# Servi-Car



**Front Axle Nut Kits** include sleeve nut, along with castle nuts and cotter pins. Fits 1930-71 Servi-Car.

VT No.	Finish
8162-3	Chrome
8162-3T	Chrome
8163-3	Cadmium



**1939-57 45" and Servi-Car Complete Spring Fork Installation Kits** include zinc plated neck cups, ball bearings, upper and lower

races, black nut with dust cover pressed on and parkerized top nut.

VT No.	Type
24-0655	Ball
24-0245	Timken



**Wiring Harness Kits** feature cotton braided wire and asphalt loom. Kits include all low tension wires. Order tail lamp and handlebar harness separately.

VT No.	OEM	Application
<b>Servi-Car-G-Models</b>		
32-0705	70321-48	1948-57 G
32-0706	70321-58	1958-64 G
32-0720	—	G Model 1966-70
32-7582	70272-71	G Model 1971-73

### Handlebar Wires

32-9315	1936-64
32-9332	1965-69

### 1934-69 Servi-Car and Sidecar

**Tail Lamp Cotton Braided Wires.** VT No. 32-7553

**Servi-Car Front Fender for 1949-57.**

VT No. 50-0739



50-0739



**Servi-Car Rear Hub Caps** in chrome for three wheel rears. Each.

VT No.	OEM	Years	Finish
49-0916	83960-37	1937-50	3 prong, raw, pair
49-0157	83915-51	1951-73	Baby moon, chrome
49-1997	83960-37	1937-50,	chrome



**Servi-Car Rear Trim** is stainless fender trim with clips. Replaces 85102-39, 85101-39. for 1939-54.

VT No. 49-0395



**Servi-Car Box Handle Sets** in black or chrome.

VT No.	Year	Finish
49-0837	1932-39	Raw
49-2567	1939-65	Black
49-2586	1939-65	Chrome



**12 Volt Generator Gear** for 1958-73 G, with built in oil slinger.

VT No. 32-1363



**Servi-Car Arm.**  
VT No. 49-0148



**Solid State 6 Volte Relay** with replaces mechanical relay and includes a Replica black Delco Remy cover. Unit does not allow for use of the charge indicating lamp on the dash. Mounts as original relay, hardware is not included. Solid State relay is shipped loose with base and cover.

VT No. 32-1545



**Complete Axle Kits** fit 1936-48 Big Twin with offset stock rockers.

VT No.	Finish
44-0581	Chrome
44-1983	Parkerized



**1937-50 Servi-Car Rear Wheels** include hub with key way. Laced and trued, pairs.

VT No.	Spokes	Hub	Rim
52-0984	Chrome	Chrome	16" Chrome
52-0985	Stainless	Black	16" Black
52-0986	Stainless	Black	16" Chrome
52-0987	Chrome	Chrome	18" Chrome
52-0988	Stainless	Black	18" Black
52-0989	Stainless	Black	18" Chrome
2399-6	Set, Axle	Nut	



### 1951-73 Servi-Car Rear Brake Components.

VT No.	OEM	Item
23-1757	83350-51	Shoe Set (each)
23-9168	83355-51	Lining Set (each)
23-0747	83500-51	Master Cylinder Complete
23-2269	83460-51	Wheel Cylinder Complete (each)

### Servi-Car Clutch Cables with 1/2" - 24 threads.

VT No.	Item	Finish
49-1668	Cable	Parkerized
49-1723	End	Parkerized
49-0904	End	Zinc



### 54.5" Long Rear End Transmission Drive Speedometer Cables fit 1937-73 Servi-Car Models.

VT No.	OEM	Fitting	Type	Year
36-0600*	67028-37	5/8" Male	Black	1937-61
36-0616*	62028-37	5/8" Male	Replica	1937-61
36-0626	67028-62	5/8" Female	Black	1962-73
36-2598	67028-62	5/8" Female	Replica	1962-73

\*Note: Fits OE speedometers with female fitting, 1936-61 style for aftermarket speedo use 62-73 cable

**Servi-Car Speedometer Drive Units** include housing and gear as OEM replacement for rear end.

VT No.	OEM	Teeth	Fits
36-0496	67131-38	8	1938-61
36-0495	67131-62	13	1962-73

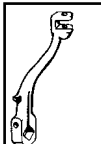

### 45" Kick Starter Arms.

VT No.	OEM	Type/Finish
49-1931	33509-41	Solo/Black
49-2581	33058-29	Servi-Car/Black

### 45" Kicker Arm Bolts

Parkerized	Chrome	Model
2792-3	2784-3	WL
2797-3	2798-3	Servi-Car



**45" Servi-Car Spring Fork Assembly** includes full set of springs, inner and outer, front and rear legs, rocker set with all studs and bushings, spring rods with bushings. Chrome units feature front legs and outer springs in chrome. Full chrome units have both front and rear legs in chrome with chrome springs and rockers. Top clamp, neck races and cone nut not included.

For 1936-57.

Powder	Full
Black	Chrome
49-2402	49-2414



**Servi-Car Rear Sprocket** fits 1932-73, heat treated sprocket has 37 teeth.

VT No. 19-0013

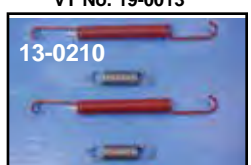
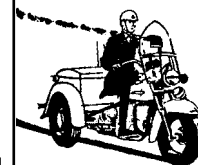

VT No.	OEM	Year	Item
23-1993	44402-36	1936-49	Front Shoe Set
13-0209	44484-35	1935-49	Front Shoe Springs
49-0182	7238-39	1930-51	Rear Brake Rod
9500-4	82906-32	Chrome	Axle Adjuster
49-0184	83057-34	1940-50	Brake Adjuster Kit
	83691-40		Mechanical Type,
	83692-40		Sold each
23-1993	44402-36	1936-50	Rear Shoe Spring
13-0209	44484-35	1936-50	Shoe Spring
23-1757	83350-51	1951-73	Rear Shoes, sold pair
13-0210	83373-51	1951-73	Rear Shoe Springs, sold pair
	83375-51		
23-9243	83560-51	1951-73	3 Piece Rear Line Set
	83562-51	1951-73	Includes Left and 2
	83564-51	1951-73	Right Side Pieces
23-0709	83566-51	1951-73	Brake Line Tee
49-0184	83055-34	1940-50	Adjuster
49-0183	83697-51	1951-73	Rear Brake Rod
2092-12*		1932-42	Rear Axle Clamp Bolt
2093-12*		1943-73	Rear Axle Clamp Bolt
49-0337	45527-41	1941-57	Rear Fork Leg Black
49-0422	45085-30A	1941-57	Front Brake Cable Assy
13-1939	46059-39	1941-57	Lower Inner Fork Spring
			Black
			Chrome

13-9200 As Above

\*Note: Sold per side two kits required



### Servi-Car Rear Frame Parts

VT No.	OEM	Item
49-2741	84640-42	Coil Spring Set
54-1531	85202-42	Shock Set
<b>Outer Chain Guard Mount Kit for Servi-Car.</b>		
VT No. 2431-9		



**Siren Cover.**  
VT No. 49-1676

**Replica Brake Handle** with ratchet plate. Fits 1941-57.

VT No. 26-0946





# 45" Parts



**51-1017** 45" Solo Frame is the single tube design.  
**VT No.** **Item**  
**51-1017** Frame Only  
**51-0465** Hard Tail  
**51-0824** 45" Magnum Solo Frame  
**55-1941** Rolling Chassis

**45 Replica Stock Style Rigid Frame** features forged components in neck, motor, transmission, seat post and rear axle plates. Frame accepts original components for 1936-1952. Order neck cups separately.

**VT No.** **Item**  
**51-0436** Cross Brace  
**51-0456** Rear Axle, Plate  
**51-0458** Seat Post Mount  
**51-0460** Fork Neck  
**51-0461** Front Mount



**Toolbox and Bracket for 1941-52 45" Solo.**

VT No.	Item	Finish	50-0615	Toolbox	Raw
50-1538	Kit	Chrome	31-0526	Bracket	Zinc
50-1543	Kit	Black	31-0928	Bracket	Black
50-0600	Toolbox	Chrome	9669-9	Hardware Kit	Parkerized
50-0601	Toolbox	Black	9669-9T	Hardware Kit	Parkerized



**Chrome Chain Guards.** Order hardware separately.

VT No.	OEM	Year	Model
27-0251	60303-36	1936-52	45" Solo
27-0114	60303-36	As Above	Black Powder WR Guard
27-0487			
13-9187	60350-36	Spring	45", 10 pack



**Rear Chain Guard Mount Kits** include bolt, nut, spring, washers and cotter pin for Big Twins and 45's.

VT No.	Finish	Fits
9744-7	Chrome	1936-52 Solo 45" and Servi-car
9745-7	Cadmium	As Above, Kit
9746-7	Parkerized	As Above, Kit
13-9186	Black	1936-57 Spring
2283-12	Parkerized	1929-40 All

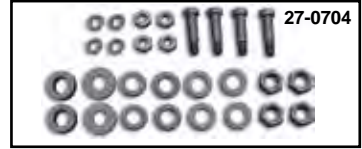

**Footboard Mount Bracket Kit.** 45" four piece set fits 1929-52 Solo and 1933-73 Servi-car.

VT No.	Finish	Item
27-0600	Black	Kit
2579-18	Black	Kit
8773-12*	Cadmium	Bolt Set, Hex
9685-12*	Parkerized	Bolt Set, Hex
9886-12*	Parkerized	Bolt Set, Slot
27-0704	Parkerized	Bolt Set

\*Note: Mounts footboards to brackets

## Primary Cover



**45" Inner Primary Cover** is available for 1937-63 Solo and Servi-Car. Chrome or raw for painting.

VT No.	Finish	Year
49-0590	Black	1937-63
42-0597	Chrome	1937-63
49-1027	Black	1964-73
49-1031	Chrome	1964-73
8627-9		Inner/Outer Primary Mount Kit
2521-4		Inner Primary Mount Kit

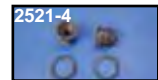

**45" Outer Primary Cover** is available original or with accessible clutch area for 1937-63 Solo and Servi-Car. Both may be cut out for electric start. Chrome or raw for painting.

VT No.	Finish
42-0599	Chrome
42-0234	Black
42-1113	Kit, chrome
42-1114	Kit, black
40-9968	Chain Oiler
8627-9	Hardware Kit

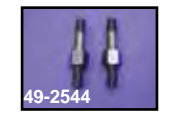

**45" Replacement Battery Box** for Solo or Trike. Top is included. Order mount plate VT No. 49-2543 separately and hardware separately. Items noted as black are black powder coat.

VT No.	OEM	Years/Model	Note
49-0301	66202-29	1929-53 Solo	Raw
49-0300	66202-29	1929-53 Solo	Chrome
49-0307	66202-29	1929-53 Solo	Black
49-0308	66203-40B	1940-63 Servi	Black
49-0302	66203-40	1940-63 Servi	Raw
49-0311		1932-39 Servi	Black
49-0310	66377-29	Top Only	Black
49-0303	66377-29	Top Only	Raw
49-0206	66377-29	Top Only	Chrome
12-0546	66387-24	Top Wing Nut	10
49-2543	66302-29	1929-53 Mt Plate	Each Chrome
49-2544	49180-36	1929-53 Mt Stud	Pair



**Inspection Covers.**  
**VT No.** **OEM** **Model** **Type**  
**42-0051** 60569-29 45" Flat  
**49-0190** 60569-29 As Above Army  
**42-1542** Black Powder, pair

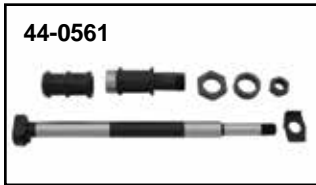

44-0561



44-0349

Fits 1941-52 45" Solo.

Kit Cpt Spacer Sleeve Axle only Nut Kit Model/Year

44-0561 44-0343 44-0331 44-0216 9688-4 Black

44-0349 44-0323 44-0331 44-0347 8832-4 Chrome



**Rear Chain Adjuster Sets** are heat treated. Available in pairs with plated lock nuts assembled to insure proper fitting threads.

Chrome Cadmium Parkerized Fits  
7814-2 8479-2 9628-2 1930-52 Solo 45"

## Primary Chain



19-0367

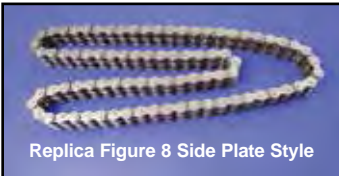

Replica Figure 8 Side Plate Style



19-0360



19-0364



19-0363

**Diamond Endless Primary Chains.**

VT No.	Size	Fits
19-0367	428x2-82	1936-64 Big Twin 74 and 80, Figure 8
19-0360	428x2x82	1965-84 Big Twin (Oval)
19-0791	428x2x80	Duckworth
19-0392	428x2x80	Special Length
19-0363	35x3-92	1952-56 K-Model
19-0364	35x2-96	1938-73 Servi-Car
19-0365	35x2-100	1929-52 Solo
19-0366	428x2-88	1930-36 VL
19-0380	428x2-90	1930-36 VL Solo



**Primary Chain Connector Links.** Sold each.

VT No.	Type	Model
19-0356	35 x 2 Chain	45" Side Valve
19-0377	428 x 2 Chain	1936-85 Big Twin



**TYK Primary Chain** has shot-peened, heavy-duty side plates and solid roller construction.

VT No.	Fits	Links	Style
19-0876	1930-64 Big Twin	82	Oval
19-0934	1936-64 Big Twin	82	Fig 8
19-0877	Chrome	82	Fig 8

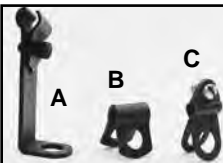

**Parkerized Throttle & Spark Cable Brackets.**

VT No. #	OEM	Year	Model	Type
9006-4	A 3371-37	1937-48	SV BT	Throttle
9007-2	B 9967	1930-73	45"	Throttle & Spark
9008-5	C 55627-38	1930-48	SV BT	Spark

## Side Valve Sprocket



**45" Engine Sprockets** for 1929-73 all Solo and Servi-car.

VT No.	Kit	Item
19-0388	19-0870	22 Tooth
—	19-0871	27 Tooth
—	19-0872	30 Tooth
—	19-0874	31 Tooth
19-0387	19-0873	33 Tooth
—	19-0680	33 Tooth

12-0200 Key  
12-0501 Nut

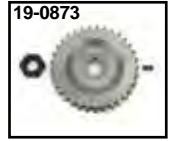

19-0873

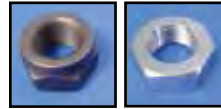

12-0503 12-0504

**Motor Sprocket Nuts** sold each.

VT No.	OEM	Fits
12-0501	7991	1929-73 45"
12-0503	24003-30	1930-54 Big Twin
7101-1	Colony	As Above
7101-1T	V-Twin	As Above
7620-1	Colony	1955-up
12-0504	V-Twin	1955-up



**JD Motor Sprocket** fits 17 tooth 1915-29 F. VT No. 19-0160



19-0062

**45" Transmission Sprocket** is 17 tooth with built in seal.

VT No.	Item
19-0062	Sprocket
19-0328	Sprocket
12-0520	Nut
12-0211	Key
19-0074	Sprocket Kit
14-0176	Seal
14-0183	Seal, OE

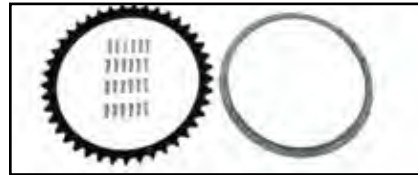

**Rear Sprocket.**

VT No.	Item
19-0010	Sprocket Kit
19-0089	Splash Ring
16-0341	Rivet Tool



13-0123



13-0122



42-0217



13-9249

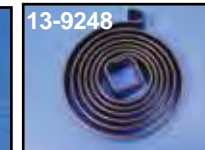

13-9248



13-0945

**Kickstarter Return Spring** for all 1936-85 Big Twins and all 1941-63 45" models.

VT No.	OEM	Model	Finish
13-0123	33085-36	Big Twin	Chrome
13-9249	33085-36	Big Twin	Black
13-0945	33085-36	Big Twin	Parkerized
13-0122	33084-41	45"	Chrome
13-9248	33084-41	45"	Black
42-0217	33150-59	Big Twin	Chrome Cover

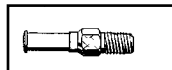

**Kick Spring Studs** fit 1941-63 45" kick starter. Replaces 33088-41.

VT No.	Finish
9756-1	Parkerized
9755-1	Cadmium
9754-1	Chrome





# 45" Side Valve Exhaust

30-0640

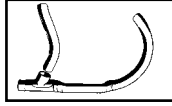

**45 Cubic Inch 2 Piece Header Set** for 1937-73 Solos and Servi-Cars.

Replica	Type	Model
30-0640	Kit	Solo
30-0622	Black/Raw	Solo
30-0630	Chrome	45"
30-1273	Black/Raw	Servi-Car
30-1274	Chrome	Servi-Car
30-0459	Flex Tube	All
30-1399	Chrome	Rear Pipe
30-0671	Black	Servi Car

30-0936



**Black Turnout Pipe.** Fits 1930-52 WR.

VT No.	Item
30-0936	Exhaust Pipe End
30-0937	WRTT Long Style Exhaust Extension

30-0937



**45 Military Stock Replacement Muffler** fits 1940-45.

VT No.	Finish
30-0184	Black
30-0862	Chrome



**45 Civilian Muffler.**

VT No.	Year	Finish
30-0185	1950-52	Black
30-0192	1950-52	Chrome

30-3100



**32" Chrome 1 1/2" Drag Pipes.** Order P-Clamps separately. Fits 1929-73 45" S.V. Pipe P-Clamps 30-3100 31-2100

30-0183



**45 Civilian Stock Replacement Muffler** replaces 1035-41. Stock on 45's 32-49.

VT No.	Type
30-0182	Black
30-0183	Chrome

30-0251



**Servi-Car Muffler** for 45" Servi-Cars.

VT No.	Type	Year
30-0186	Black/Raw	1936-73
30-0251	Chrome	1936-73
30-0020	Black Replica	1936-73
30-0418	Black	1932-35

Antique Pipe Sets sold as raw or painted with black primer as a rust preventative measure only after manufacturing. We do not guarantee black finish for surface finish or ability to withstand heat. We suggest that the pipes be repainted with our heat proof VHT finish.



**Batique Pipe End** fits over 1 3/4" exhaust tube. Sold each. VT No. 30-0793

# Big Twin Side Valve



29-1103

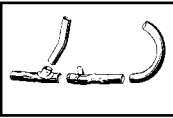

29-1103 Installed



**UL-ULH Exhaust System** available in 3 or 4 piece. The 3 piece style uses the muffler with built-in "Y" (30-0165, 30-0166), the 4 piece style uses standard 1 3/4" inlet mufflers (30-0163, 30-0164). The three piece is stock on 1937-40, four piece on 1941-48.

VT No.	Finish	Pieces
30-0167	Black	3
30-0168	Chrome	3
29-1103	Black	4
29-1104	Chrome	4

**Note:** Three and Four Piece Replica Exhaust Systems require hand fitting during final assembly. We suggest to loosen motor mount bolts during installation to allow pipes to adjust to motor position then re-tighten engine bolts.



30-0164



30-0880

**Replacement Muffler** replaces 65251-41. Fits all 1941-49 FL, EL, UL.

VT No.	Finish	Bolt Kit
30-0163	Black	2719-22
30-0164	Chrome	2772-22
30-0880	Black, Replica	
30-0884	Chrome, Replica	

30-3125  
Big Twin SV 1 3/4"



**36" Chrome 1 3/4" Drag Pipes.** Order P-Clamps separately. Fits 1936-48 Big Twin Side Valve.

Pipe	P-Clamps
30-3125	31-2101

**Side Valve J.D. Exhaust Parts**

VT No.	Item	Year
9209-1	Nipple	1924-29
9210-1	Nut	1921-29
49-0168	Header Pairs	1915-24
49-0169	Header	1925-29



30-0166



**UL Stock Replacement Muffler With Built-In Y-Pipe.** Replaces 65201-37. Used on all 74-80 side valves 1937-40 and 1936-40 Knucklehead.

VT No.	Type
30-0995	Black, Replica
30-0165	Black
30-0166	Chrome
30-0995	Replica
30-0996	Replica, Chrome

**Exhaust Pipe Clamp Sets** complete in black

or chrome for single exhaust. Number of clamps in each kit shown.

Chrome	Black	Year	Model	#
31-3950	31-2125	1936-40	Knucklehead	3
31-3953	31-2128	1937-40	ULH	3
31-9003	31-9004	1941-48	ULH	4
31-3956	31-2130	1936-51	45's	4
2772-22	2719-22	1936-57	BT Bolts	
31-9010		1951-73	Servi Car Clamp	
31-9011		1951-73	Servi Car Bracket	
31-1261		1951-73	G Clamp	

31-3950

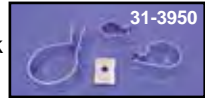

49-2579

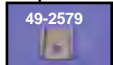

**Rear Hanger Reinforcement Clip** braces rear muffler clamp at mount bolt. Body clamp not included.

VT No.	Fits	Finish
49-2578	1936 EL, 1937-40 UL	Black
49-2591	1936 EL, 1937-40 UL	Chrome
49-2579	1065-41 1941-47 FL	Black
49-2592	1065-41 1941-47 FL	Chrome



### Jiffy Stand Parts for 1929-52 45 Solo models.

VT No.	OEM	Item
13-0189	—	Replica Spring
13-0171	50012-30	Black Spring
13-0177	50012-30	Chrome Spring
49-1161	—	Spring Kit
49-0964	50035-30	Spring Plate, Zinc
49-0023	—	Long Spring Plate
49-2381	—	Parkerized Leg Only
49-0065	50060-30	Jiffy Leg, Black
49-2003	50060-30	Jiffy Leg, Chrome
49-2068	Kit	Chrome Leg
49-0066	50092-30	Leg Bushing
49-0089	50110-30	U Bolt Kit, Chrome
37-8819	50110-30	U Bolt Kit, Black
2653-5	50110-30	U Bolt Kit, Parkerized
49-2547	50002-32	Complete Assembly, Black Leg
49-0246	50002-32	Complete Assembly, Chrome Leg
49-1871	50002-32	Jiffy Stand Assembly, Black

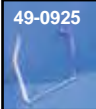

**Rear Frame Stands** for 1936-52 45 models. Order stand catch and mounting hardware separately. Replaces 49502-36

VT No.	Finish
49-1936	Black
49-0925	Chrome
27-1454	45 Rear Peg Yokes



**Black Rear Stand Catch.** Fits 1936-52 45" solo. Replaces 49581-36. VT No. 31-3994

**Mounting Hardware,** Parkerized finish except where noted.

VT No.	Year	Models
8840-10	1930-35	All with bolts and washers
8841-10	1936-37	All
8015-4	1938-57	All
9616-4	1938-57	All, Chrome
35-0165		Zinc Gas Strainer Filter
35-0497		Petcock Left, Zinc

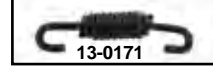

### 45 Solo and Servi-Car Front Engine Bar.

VT No.	OEM	Years	Finish
51-0892	49035-35	1929-73	45 Solo Servi, Black
51-0884	49035-35C	1929-73	As Above Chrome
49-0143	49061-32		U Bolts Zinc
2767-10	Kit		U Bolts Parkerized
2768-10	Kit		U Bolts Chrome



**Rear Frame Bars** fit Rear 45" Solo 1929-52.

VT No.	OEM	Finish
51-0893	13030-39	Black
51-0904	13030-39	Chrome

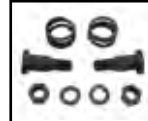

**45 Rear Bar Mount** for solo models 1938-52.

VT No.	Item
49-2543	Mount Plate
49-2544	Stud Set
2682-17	U Bolt Kit

## VL 1930-36

Side Valve Big Twin 74" and 80" Side Valve Components that are interchangeable for 1936-48 are listed for the Big Twin Section.



**28 Tooth Transmission Sprocket** replaces 2034-15 on JD models 1915-29, VL models 1930-36. Drilled. VT No. Item 19-0065 Sprocket 17-1761 3rd Gear



**VL Top End Engine Gasket Set.** VT No. 15-0527

**JD and VL Gas Caps.** Caps are screw in type.

VT No.	OEM	Item
49-0136	3507-16	Gas Cap, 1916-34
49-0137	3507-35	Gas Cap, 1935-36
49-0178	4521-26	Ignition Key Set 1923-36



**Brake Rods** in parkerized. Fit 1930-35 VL replaces 4063-30.

VT No.	Type
49-0078	Front
49-0079	Rear

**VL Chains, Endless.** VT No. Links 19-0380 90



**VL Spring Set** fits 1930-36. VT No. 13-1935



**Shifter Gate Nuts** fasten the shifter gate to the tank. VT No. 8846-2



**VL Transmission Gaskets** for 1930-36 Side Cover. VT No. Type 15-0379 Side 15-0411 Top



**1915-35 JD-VL Transmission Gear.** VT No. Item 49-0272 2298-15 Slider Gear 17-1761 Drive Side Gear

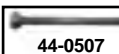

**VL Axle.**

VT No.	Fits
44-0507	1930-36 Rear Only, Parkerized
44-0481	1930-36, Parkerized
44-0717	Sleeve

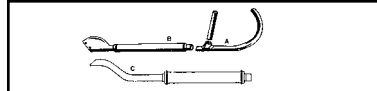

**Clamps Not Included With Header Sets.** VT No. # Item Finish 30-0171 A Header Set Black 30-0172 A Header Set Chrome 30-0169 B Muffler Black 30-0170 B Muffler Chrome 30-3212\* C Muffler Black 30-3213\* C Muffler Chrome

**VL Exhaust Parts** for 1930-36 Side Valve models. \*Note: Features an upsweep Tail Piece for 1934 only. Note: 3 and 4 Piece Replica Exhaust Systems require hand fitting during final assembly. We suggest to loosen motor mount bolts during installation to allow pipes to adjust to motor position then re-tighten engine bolts.

VT No.	#	Item	Finish
30-0171	A	Header Set	Black
30-0172	A	Header Set	Chrome
30-0169	B	Muffler	Black
30-0170	B	Muffler	Chrome
30-3212*	C	Muffler	Black
30-3213*	C	Muffler	Chrome

**Exhaust Pipe Clamp Sets** complete in black or chrome for single exhaust. Number of clamps in each kit shown. Fits 1930-36 VL. Chrome Black Item 31-3954 31-2129 Clamp 49-2590 49-2577 Tab



**Exhaust Pipe Clamp Sets** complete in black or chrome for single exhaust. Number of clamps in each kit shown. Fits 1930-36 VL.

Chrome	Black	Item
31-3954	31-2129	Clamp
49-2590	49-2577	Tab



**Side Valve Transmission Mainshafts** VT No. OEM Model Year 49-0201 35043-41 45 1941-73

**Clutch Components** 1936-40 Big Twin. VT No. OEM Item 12-0626 2275-38 Clutch Hub Nut Kit, 3 piece 2548-36 2471-36

VT No.	OEM	Model/Year
13-0234	2511-36A	Clutch Spring Set
49-0366	Tool	Clutch Hub Nut Install

**Clutch Spring Sets** VT No. OEM Model/Year 18-2324 2508-30 Collar for Above 13-0234 2511-36A UL, EL, FL 1937-40 13-0139 38077-41 UL 1941-48 45 Side Valve 1941-73

**26-0930** Lever and Screw Kit  
**3 Bolt Linkert Carburetor Gasket Kit** includes 3 bolt gaskets for 1 1/4" 3 bolt Linkerts, and 2 insulator gaskets. VT No. 15-0420

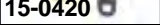

**Rear Frame Stands** for 1930-36 VL. Order stand catch and mounting hardware separately. 49-0601 features channel shape design. Replaces 3051-30.



VT No. Item 49-0601 Stand Black 49-0623 Stand Chrome 8840-10 Mount Bolts Parkerized  
**Handlebar Spiral** features nickel plated threaded sleeve. Each. VT No. 49-0459



**VL Clutch Plate Set** for 1930-36. VT No. Year 49-1155 Plate Set 18-2324 Collar Set 49-0603 Screw Set 13-0232 Spring Set

**Clutch Brass Rivets.** 100 pack. VT No. OEM Type 37-8807\* 8226 Short 7-4

\*Note: For clutch hub friction disc.  
**Rear Axle Adjuster Kit** includes cad plated bolts, parkerized collar and parkerized nuts fit 1930-1936 74" and 80" Twins.



VT No. 2069-5  
**JD Model Rear Sprocket** features holes as original in black finish with 48 teeth. Replaces 2049-30. VL bolt kits for 1930-36 VL.

VT No.	Item
19-0389	Flat Sprocket
19-0390	Dish Sprocket
2069-5	Adjusters
8318 CAD	Motor Kit
2604-12	Footboard Bolts

**Footboard Mount Kit** fits 1930-36 VL models, parkerized. VT No. 2604-12



**1930-36 VL Front and Rear Stainless Steel Spokes.** VT No. Size 45-0735 18" 45-0736 19"



**VL Fork Cone Pieces.** VT No. Item 24-1454 Neck Cups 24-1465 Lock Nut 24-1749 Lower Race 24-1469 Upper Race 24-1569 Kit





# K-Model Motor Parts



**Head Bolts Kits.**  
**Cad Chrome Fits**  
 9641-16 9640-16 1952-57K-KR-KK  
 9643-16 9642-16 1954-56 KH

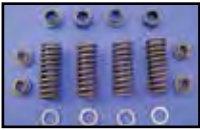

**K-Model Valve Spring Kits**  
 include springs collars and keepers.

**VT No. Year**  
 13-9205 1952-53  
 13-9206 1954-56



**Valve Springs.**

VT No.	OEM	Year	Model
13-0221	18201-52	1952-53	K Model
13-0222	18200-32	1953-56	KH Models

**Primary Chain**

19-0363 35 X 3 -92 1952-56 K Models



**Pinion Right Side Case Race fits**  
 1954-56 K-KH. Replaces 24585-54.

**VT No. Size**  
 10-0276 .005 Oversize

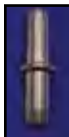

**1952-56 K-Model Guides.** Use the same guide on intake or exhaust.

**VT No. Size**  
 11-0792 Standard  
 11-0822 +.002  
 11-0823 +.004



**V-Twin Piston Kits** include 2 Cast Alloy Pistons, 1-Piece Ring Set, 2 Wrist Pins and 4 Circlips. Rings also available separately.

Size	Flathead	K-Model Side Valve Rings
Standard	2.745 Bore	
.010	11-0438	11-2530
.020	11-0431	11-2523
.030	11-0432	11-2523
.040	11-0433	11-2532
.050	11-0434	
.060	11-0435	11-2534
.070	11-0436	11-2535
Wrist Pin	11-0437	
	11-0869 each	



**K-Model Valve Cover Sets** for 1952-56 KH + K-Model. Replaces 18239-54 and 18255-52A.8 pc. Set, zinc  
 VT No. 11-0911



**1952-56 K-Model Gasket Kit** does not include head gaskets as none are used on K-Models.  
 VT No. 15-0699



**Crank Pins** made of 8620 steel.

Model	Years	OEM	Jims 3 Hole	Eastern 3 Hole
K Model	1952-53	23960-52	10-0132	10-8371
KR-XR 1 1/2"	All	23960-55R	—	10-0383

**Steel Valve Collars.**

VT No.	OEM	Use	Year	Model
11-0660	18220-30	Upper	1930-73	45 SV +K
11-0812	18165-41	Collar	1954-56	K-Model
11-0813	18223-53	Spacer	1952-53	K-Model

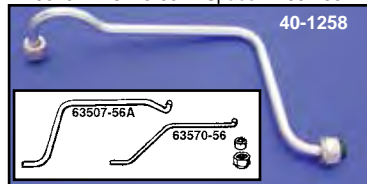

**XLH and K Oil Lines** are cadmium plated, includes nuts and seals.

VT No.	OEM	Item
40-1262	63507-52	Return Line 1952-55
40-1258	63507-56B	Return Line 1956-64
40-1263	63570-52A	Vent Line 1952-55
40-1259	63570-56A	Vent Line 1956-64



**Truett and Osborn Flywheel Sets** feature original weight right and left sides. Fits K models.  
**Bare Flywheels Only**  
 VT No. 10-1068

# Hummer Parts



**Hummer Solo Seat** features steel ribbed baseplate with nose bracket. Genuine black leather construction replaces 52001-50. Measuring 13.5 x 13.5. Order springs separately.

**VT No. Item**  
 N/A Seat  
 13-9252 Springs



**Hummer Tail Lamp** is a replica version of a black tail lamp with chrome bullet hood and glass lenses. Mounts to fender and includes license plate mount slots. Replaces 68001-47.

**VT No. 33-2160**



**Hummer Petcock** replaces 62125-50, die cast with threaded end for line.

VT No.	OEM	Item	Year
35-0650	62125-50	Petcock	1950-58
49-0187	62358-50	Gas Line	1953-58



**Note:** Do not over fill, fill to cover top of plates only as per instructions provided. This battery vents through the caps. There is No Warranty on Leakage due to over filling.

**H-3 Battery** features black construction as original replaces 66001-47.

**VT No. 53-0520**

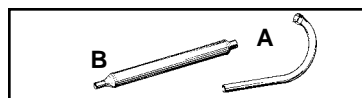

**Hummer Chrome Replica Header Sets.** Muffler sold separately.

VT No.	#	OEM	Item/Type
30-3192	A	65439-51A	Header 47-54
30-3194	B	65241-47A	Muffler, Black
30-0252	B	As Above	Chrome
31-0402		65521-47A	Muffler Body
			Clamp
31-0227		65290-51	Clamp 51-62
31-0403		As Above	Chrome
31-0308		65523-57	Front Muffler
			Clamp Stainless
			Steel

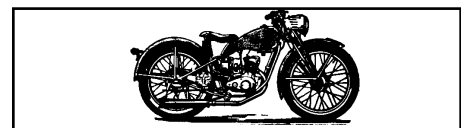

**Hummer Parts** fit 1947-65 Model 125 and 165.

VT No.	OEM	Item	Fits
32-8092	70322-55	Wire Harness	Magneto
32-8093	70332-53	Wire Harness	Battery
32-0058	29580-55	Points 1955-up	Magneto
28-2134	50940-55	Peg rubbers	All Driver
8310 CAD	—	Hardware kit	Both Engine
9215-2	702	Oil Fill Plug	All Engine
		Drain Plug, Pair	
49-2545	68040-55	Taillight Bracket	
27-1709	50006-52	Kick Stand	All, Zinc
13-0174	50001-49	Kick Stand Spring	All, Black
23-0327	42256-47	Brake Rod	1947-62
23-0328	42256-63	Brake Rod	1963-up



**Spare Parts Books.**

VT No.	Year
48-0981	1948-55
48-0982	1956-65

# 1952-71 K and XL Fork Parts



**Chrome Top Fork Tube Plug** replaces 45756-59. Sold each.  
VT No. 7621-1

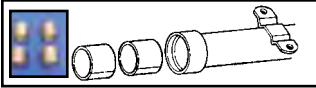

**Slider Bushing** set of 4, replaces 45818-52.

Use on 1952-72 XLH-XLCH models with steel lower sliders.

VT No. 24-0145



**Fork Tube Spring Retainer and Pin Wrench Kit** includes 2 retainers for 1952-72 Sportster and pin wrench for installation and removal of retainers.

VT No. 7700-3



**K and XL Early Fork Cover Set** is constructed of chrome plated steel and includes all panels pictured, replacing

46298-52A, 46269-52 46292-52 and 46291-52. The 46298-52A top panel does not have key switch holes covers or provisions for them.

VT No. 24-0261



**Clutch and Brake Lever Assemblies** include cable pin. Available chrome or polished with 3/8"

or 5/16" hole sizes for cable entry. VT No. 26-2167 and 26-2168 accept front brake switch.

Chrome Polished	OEM	Hole	Fits
26-0520	26-0521	38604-65A	7/16" 1965-70 Clutch
26-0525	26-0526	45002-65	5/16" 1952-68 Brake
			1952-67 Clutch
26-2167	26-2168	45002-69	5/16" 1969-72 Brake



**1952-56 K Model Clutch Cable** with adjuster.

VT No.	Item
36-0406	Cable Assembly
37-8460	Adjuster Only



**Rubber Cable Oiler Boot** replaces 38690-55, for XL 1955-80. 5 pack.

VT No. 28-0401



**1952-67 XLCH Cast Sprocket Cover** features early rib design, includes worm and hardware, replaces 34874-52A.

VT No. 43-0133

**Stock Sprocket Cover Screws.** for K-Model 1952-53.

VT No.	Finish
8882-2	Chrome
8883-2	Cadmium

**1952-57 K-Model Primary Cover Screw Kit.**

VT No.	Finish
9852-5	Chrome
9853-5	Cadmium

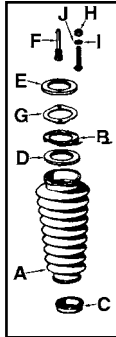

**1954-70 XL Fork Boots and Hardware Kit** includes gaskets, felts, retainers, washers, vent tubes and clamps.

VT No.	OEM
28-1994	46001-54
37-9016	Hardware
37-9017	46007-54A
24-0680	10006
15-0668	46009-54
31-9019	46010-54
37-9020	46020-57
15-0669	46021-57

Item
A-Boot set, pair
Kit Without Boots
B-Boot retainer upper, pair
C-Boot Clamp
D-Washer, boot retainer, 10 pack
E-Disc, boot retainer, pair
F-Boot vent, pair
G-Gasket, boot vent, 10 pack



**1952-72 Damper Tube Assembly** includes all

components for both sides on XL and FX forks. This is a direct replacement for 1952-67 models by drilling the lower leg center hole to 7/16" to allow use of larger mount screw. Order spring set if required.

VT No.	Item
24-0454	Internal Kit
24-0900	Fork Springs
12-0908	Lower Snap ring
15-0327	Tube Gasket



**Barnett Clutch Lever Assemblies.** Heavy chrome steel levers with ball end. Assembly has mounting hole for mirror.

VT No.	Application
26-0500	1952-70 Left side



**Front Brake Cable.** Replacement core and casing for 1952-72 Sportster models. Replaces 45073-51 60" long, must be cut to proper length.

VT No.	Type
36-2385	Stock Type, V-Twin
36-2565	Stock Type, M & M
36-0501	Stock Type, Barnett
36-2489	Braided Steel



**Replica Clutch Adjuster Sleeve.** Fits 1954-71, 7/16" hole levers.

VT No.	Finish
37-8460	Zinc
2576-1	Cadmium



**K Mufflers** have 2 3/8" body diameter, 1 3/4" inlet.

VT No.	OEM	Fits	Type
30-0742	65231-52	1952-56 K-H	21 1/2" Replica
31-0231	65279-52	1952-55 K	Body Clamp
31-0226	65519-52	1952-56 K-H	Header Clamp, pair
30-0742	Replica	1952-56 K-KH	21 1/2"



**Wire Harness** for 1952-58 K-Model. 6 Volt. Replaces 70320-56.

VT No. 32-7552



**Speedometer Drive Units** include housing and gear as replacement, for transmission drive. 11 Teeth for 1952-72.

VT No.	Item
8900-1T	Drive
15-0216	Gasket
15-1071	Gasket

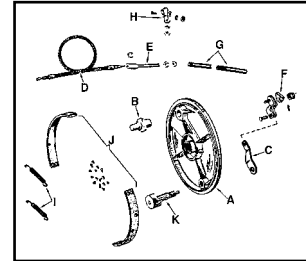

**Front Brake Parts** fit 1952-72.

VT No.	#	OEM	Item
N/A	A	44148-64	Polished Backing Plate
24-0116	B	44156-64	Pivot Stud, 1964-72
24-0609	C	44307-52	Chrome Lever
36-2385	D	45060-54	Cable Assembly
8818-3	E	45159-50	Adjuster, zinc
8818-3T	E	45159-50	Adjuster, zinc
9741-2	E	Chrome	As Above
37-8676	F	45174-64	Zinc Clevis
24-0095	G	45203-52	Chrome Front Brake Tube
24-0646		As Above	Cadmium
2041-7	H	45218-53	Zinc Cable Tube Clamp
13-0146	I	41835-69	Spring Set
23-0505	J	44432-54	1952-63 Linings
23-0450	J	O.S.	1952-63 Linings
23-0506	J	41848-64	1964-72 Linings
23-0525		41849-64	Shoe Set
23-0519	K	44264-64	Brake Cam, 1954-72



**Brake Cable Clamp** cinches cable to brake arm.  
VT No. 26-0508



**Cable Clamp** is fitted to hand lever for emergency or permanent use. Easy to install. .460" diameter, pair  
VT No. 26-0509



**Tool Box Wing Nuts** are zinc plated, replace 64500-52A, pair.  
VT No. 37-6136



**Tool Mount Kits** are cadmium, replace 64500-52A, pair.  
VT No. 2005-9

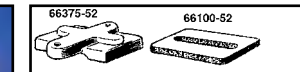

**K Battery Top** replaces 66375-52 on 1952-64 6-Volt models, in chrome finish.

VT No. 42-0732



**Transmission Drive Speedometer Cables.** All have female nuts at transmission end and top nut as noted. Fit 1952-56 K Trans Drive models.

Black	Zinc	OEM	Length	Top Nut
36-2570	36-2577	67051-52A	46"	5/8" F





# K and XL Parts



**1952-78  
Replica Style  
3.5 Gallon  
Tank for XL's.  
VT No.  
38-0038**



**Replica Leather WR Model Solo Seat** is covered with genuine leather on a stock formed steel ribbed baseplate, constructed as original with rolled sewn edge with riveted under strip, replaces 52000-40. Available in black which bolts to any stock seat tee as custom or stock replacement.

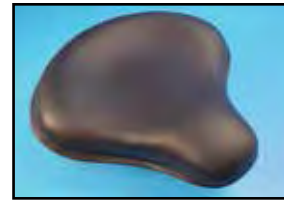

**Leather XLCH  
Seat** measures  
13.5" x 13.5" fits  
31-0512 seat tee.  
**VT No. Color**  
47-0158 Black  
47-0164 Brown



**1952-70 XL Large Cap** replaces 61103-52.  
**VT No. 38-0329**



**1952-54 K-Petcock** replaces 62125-50, die cast with threaded end for line.  
**VT No. 35-0650**

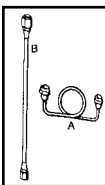

**K-Model 1952-54 Steel Gas Lines.**  
**VT No. # OEM Line Finish**  
40-1261 A 62355-52 Cross Cad  
40-1264 A As Above Cross Chrome  
40-1260 B 62357-52 Gas Cadmium



**33-2120**



**33-2120A**



**33-2254**



**33-0072**

**7" K Headlight** features oil/generator lamps and sockets, replaces 67704-52. Unit includes chrome rim and 6 volt sealed beam.

**VT No. Finish**  
**33-2120** Chrome, Complete  
**33-2120A** Shell  
**33-2254** Black, Shell  
**33-0072** Black 7" Headlamp with rim



**Replica Steel Rear Fender** features full length style with rear flare, without taillight cut. Mount for 1955-72 type must be cut in.  
**VT No. 50-1068**

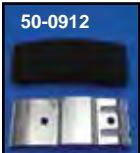

**50-0912 Chrome Rear Fender Bracket** fits 1954-78, reduces vibration between fender and frame, includes foam pad, replaces 59795-52A.  
**VT No. Item**  
**50-0912** Bracket with pad  
**28-2246** Foam pad only



**33-2151**

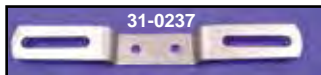

**31-0237**

**1952-54 Early Tail Lamp and Parts.** Note: Lenses are made of glass.

**VT No. OEM Item**  
**33-2151** K Tail Lamp Complete Kit with chrome hood  
**31-0237** 59991-52 K Model license plate bracket

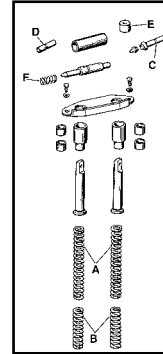

**31-4024**



**31-4083**

**Seat Plunger Kit** includes all parts pictured for 1954-70 KH-XL-XLCH-XLH Sportster models, to spring mount solo seat on stock frames. Some frames may require honing to fit bushing housing.

**VT No. Item**  
**31-4024** Complete Kit, All  
**13-1952** 4 Springs, Set (A and B)  
**13-9173** Swivel Springs, Pin, (F)  
**37-9114** Tee Bolt, (C)  
**10-2564** Bushing, (D)  
**10-2563** Spacer, (E)  
**31-4083** Kit with Tee

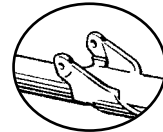

**Seat Mount Tabs** fit 1952-79 XL may be welded on for custom application, pair.  
**VT No. 51-0539**



**Coil Mount Studs** replace 64611-55, 64612-55 models, pairs. Fits 1955-67 XLH.  
**VT No. 37-9156**



**Chrome Shock Spring Covers** is replica type for shocks which disassemble at lower eye. Fit 1957-70 XL, 10 3/4".  
**VT No. 54-0402**



**K-Model Parts Books.**  
**VT No. 48-0525**

# Rim and Spoke



**52-0946**

**18" Chrome Replica™ Early Steel Wheel Rim** features conventional bead construction. Spoke nipple holes may require enlarging before assembly. Fits K Models.  
**VT No. OEM Fits**  
**52-0946\*** 43003-30 Front  
**\*Note:** Features reverse roll and deep dish spoke area to fit models with integral 1/2 brake drum.

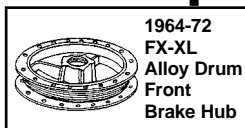

**1964-72  
FX-XL  
Alloy Drum  
Front  
Brake Hub**

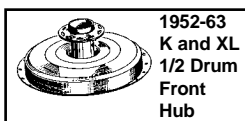

**1952-63  
K and XL  
1/2 Drum  
Front  
Hub**

Above Hubs are shown for reference only

**Spoke Sets** available for conventional or drop center rim type.

Chrome V-Twin	Chrome Buchanan	Stainless Buchanan	Rim Size	Rim Type*
<b>1964-72 XL-FX Front Drum</b>				
		45-0658	19"	Conventional
45-0622	45-0724	45-0657	19"	Drop Center
		45-0659	21"	Drop Center
<b>1952-63 XL-K Front</b>				
		45-0708	18"	Conventional
		45-0707	19"	Conventional

# News Flash!

After 93 years, Harley-Davidson has discontinued the sidecar as of August 2010 as told by Sarah Harley, granddaughter of William Harley, cofounder of Harley-Davidson.

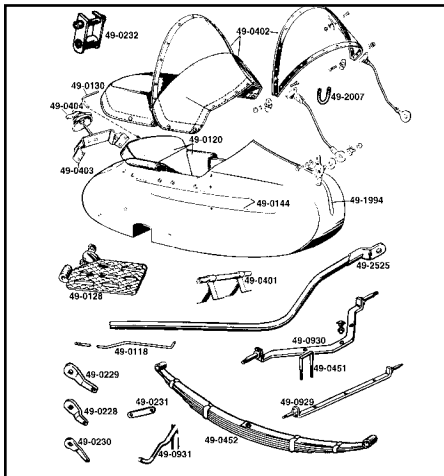

## 1936-65 Sidecar Body and Accessories

VT No.	OEM	Item
49-0118	87732-41	Brake Rod
49-0788	87750-58	Side Car Wheel Cylinder with inverted flare fits 1958-79 Side Car Brake
2663-7	Parkerized	1936-40 Step U Mount Bolts
2661-7	Parkerized	1947-64 Step U Mount Bolts
2616-4		Step Bolts, 1941-64
2617-3		Step Bolts, 1936-40

**Sidecar Wrenches** are heavy duty for shop use. 1 1/4".  
VT No. 16-0111

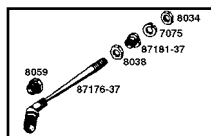

**Sidecar Mounting Fittings** are precision machined fittings that are replicas of the original.

VT No.	OEM	Application
49-1945	87176-37	Front Tie Rod
49-0999	87254-24	Nut and Ball Stud Set
49-1977	87254-24	Ball Stud
49-1979	87135-36	Upper conn. bolt
49-1980	87265-24	Joint Lock Nut
49-1981	87197-36	Rear frame mount 1936-57
49-0134	87267-24	Joint Lock Nut
49-1947	87181-37	Tie Rod Spacer
49-1949	8034	Tie Rod Outer Nut
49-1950	8038	Rod End Nut
49-1948	8059	Tie Rod Nut
49-1996	—	Threaded Ball Socket

**Lower Front Mount Tie Bar Assembly.** Parkerized reproduction of fasteners used 1924-84 Sidecars.  
VT No. 2692-5



**Lower Front Mount Tie Rod Ball Joint.** Exact reproduction of ball joint used on 1924-84 Sidecars. Replaces OEM 87254-34.  
VT No. 2690-1



**Sidecar Support Rod Bushing and Stud Kit.**  
VT No. 2433-18



# Sidecar



**Replica Sidecar Fender Lamp** fits 1934-65 models.  
VT No. 33-0406



**Fender Lamp.** OEM# 59260-68.  
VT No. 33-0402

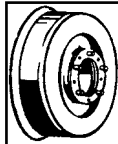

## Sidecar Brake Drum and Shoes.

VT No.	OEM	Item	Year
23-1993	44402-36	Shoes	1936-57
23-1770	44113-36	Drum	1936-48
23-0501	41801-58A	Shoes	1958-79
49-0788	87750-58	Wheel Cylinder	1958-79



50-0524



**Sidecar Fender** assembled with brackets for 1936-65 Early 67 Sidecars. Stainless trim with clips,

VT No.	Item
50-0773	1936-Early 67
50-0524	1967-09
49-0405	1936-Early 67 Trim
51-0295	Windshield
31-1642	Bracket

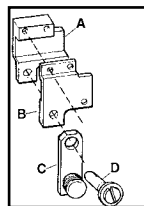

## Rear Clamp Connector

VT No.	#	OEM
49-1986	A	87083-87
	B	87084-73
49-0135	D	87192-73

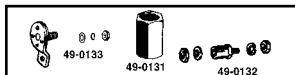

## Sidecar Axle Hardware for 1936-65.

VT No.	OEM	Item
2614-7		Axle Mount Kit
2622-5		Longer Axle Extension
2621-5		Axle Extension



## Sidecar Spring Bushing Kit.

Reproduction of 88174-37 bushings used on 1937-84 Sidecars.  
VT No. 2766-4



## Lower Front Mount Tie Rod Ball Joint Nut and Lock Nut Kit.

Reproduction of OEM 87265-24 nut and 87267-24 locknut. Used on 1924-84 Sidecars.  
VT No. 2691-2



**Sidecar Step to Fender Mounting Kit.** Parkerized reproduction of original fasteners.  
VT No. 2617-3



**Axle Extension Nut Kit.** Exact reproduction of fasteners used on 1930-early 1967 Sidecars.

VT No.	Year
2621-5	Standard length 87438-30 nut
2622-5	Extra long 87438-30 nut

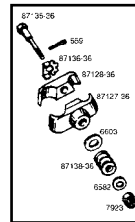

**Upper Connection Parts** are available separately for 1936-up sidecar.  
VT No. OEM Item  
49-1995 87127-36 Clamp  
87128-36  
49-1979 87135-36 Bolt  
49-2531 87136-36 Lock tab, 5 pack  
49-1156 Kit



**Sidecar Connector Kit** comes complete with upper, front and lower for the years listed for 74" and 80" Big Twins.

VT No.	OEM	Fits
49-1990	87082-36	1937-57 Rigid
49-1991	87082-58	1958-72 SA
49-1992	87082-73	1973-79 S



**Clamp Bracket Set** includes 87205-58, 87206-58 with four U-Bolts.

VT No.	Item
49-1989	Bracket Set
21-0315	U-Bolt, each
2705-5	Parkerized, each



## Rear Connector.

VT No.	OEM	Item	Type
49-1981	87197-36	Mount only	1936-57 Rigid
49-1983	87197-58	Mount only	1958-72 SA
49-0154	87192-58	Stud only	1958-72
49-0135	87192-73	Stud only	1973-80

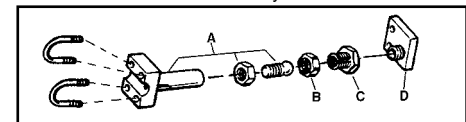

**Clamp On Rear Mount** for mounting side cars on 1979-84 Classic & FLH models.

VT No.	#	OEM	Item
49-1988	A	87106-79	Connection Fitting
49-0134	B	87267-24	Joint Lock Nut
49-1980	C	87265-24	Joint Nut



**Sidecar Frame Brace Upper Connection Kit.** Parkerized accurately duplicated fasteners used on 1937-1979 sidecars.  
VT No. 2620-7



**Spring to Frame Mounting Kit.** Correct parkerized reproductions of 88172-25 U-bolts, 88170-24 shims, washers and nuts used on 1925-84 Sidecars.  
VT No. 2716-8



## Emergency Brake Kit

VT No.	Year	Type
23-1949	1936-73	Foot
49-0934	1941-74	Front
26-0948	1951-64	Front

23-1949 Installed





# Parts for Indian

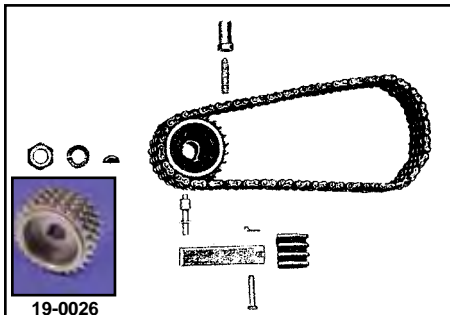

### Primary Components.

VT No.	Item
19-0393	Primary Chain, 35 x 4 x 76
19-0026	Engine Sprocket
49-3075	Primary Chain Tensioner with shoe

**Front U Bolts.** Sold in pairs.  
VT No. 37-8815



**Top Motor Mount.** Order shims and spark tube bracket separately.

VT No.	Item
49-3019	Top Mount Zinc
49-3073	Spark Tube Bracket



**Sheet Metal Parts.** Painted in primer finish, belt guard also available in chrome.

VT No.	Item
49-4048	Belt Guard, Primer
49-3052	Belt Guard, Chrome



### Sprockets for Indian

VT No.	Tooth	Type
19-0017	22	Countershaft
19-0018	23	Countershaft
19-0019	24	Countershaft
19-0016	43	Rear
19-0025	21	Front Countershaft with holes

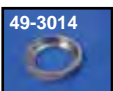

### Clutch and Related Hardware.

VT No.	Item
49-0050	Pedal heal pad, zinc
49-0051	Release arm, zinc
49-3014	Chrome release knurled nut

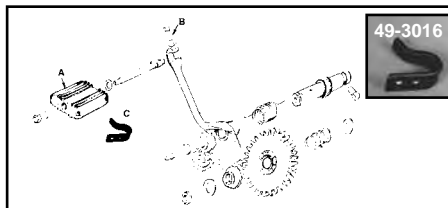

### Kick Starter Parts.

VT No.	#	Item
49-3071		Shaft
49-4012	A	Pedal
37-0057	B	Pedal Bolt
37-0993		Kick Bolt, Black (5 Pieces)
49-3016	C	Stop



### Chrome Plated Steel Replicas.

VT No.	Item
49-3006	Front Bumper Loop
49-3089	Brace Set, 75599R, 55600L
49-3010	Handle Assembly

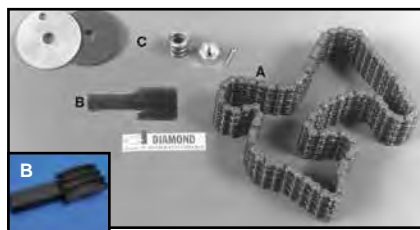

### Clutch Friction Kit and Primary Chain by Diamond USA.

VT No.	Item
19-0393	(A) 76 link Primary Chain, Chief
49-3075	(B) Primary Shoe Tensioner with shoe
19-0435	Gen Chain 741
49-3012	Fiber disc, 5 pack
49-3013	Steel disc, each
49-3011	Spring, each

### Parts for Indian.

VT No.	Item
49-3093	Air Cleaner Assembly Chrome
49-3984	1946-53 Front or Rear Hub, Black
49-4022	Face Lens Plastic
49-3034	Terminal Black Stud with insulators



**Linkert Choke Lever for Indian.**  
VT No. 49-4133



**Linkert Choke Door Kit for Indian.**  
VT No. 35-1674

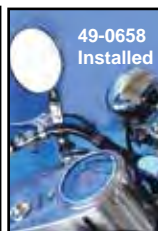

### Mirrors for Indian.

VT No.	Style	Finish
49-0658	Left	Black
49-0660	Replica	Chrome



**Magneto fits 1936-53 Indian with all models with distributor.**  
VT No. 32-1741

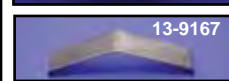

### Replica Chrome Air Cleaner and Parts.

**49-3093** Air Cleaner, Original Style for 1940-50 includes chrome outer cover screw with collar and zinc back. Element sold separately.

**34-0499** Backing Plate

**13-9167** Mesh Spring

### Parts for Air Cleaner

VT No.	Item
34-0907	Element
34-0499	Backing Plate



**Handlebar Cross Bar** fits 1936-57 Spring Fork Bars. Features a curved bar made of 1" tubing with milled ends, which fit perfectly on the handlebars include 2 chrome clamps and bolts. An early aftermarket accessory originally by Atlas Products.

VT No. 49-2607



**Dash Base 1938-47.**  
VT No. 49-3018

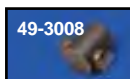
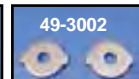
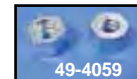

### Handlebar Components.

VT No.	Item
49-4059	Cable Nuts, pair
49-3002	Cable Stops, pair
49-3005	Sleeve Collar Chrome, each
49-3004	Right Spiral
49-3003	Left Spiral
49-3008	Throttle Driver, each 135B4534



**Replica Indian Face Lamp** is constructed with chrome die cast body mounted to original style base with wire fitting.



**VT No. Item**  
**49-4021** Lamp  
**33-1182** Lamp with red lens  
**49-4123** Red Lens  
**33-0828** Base



**Quality Reproductions.**

**VT No. Item**  
**49-4017** Front shock rubbers, pair  
**49-3036** Front mount plates without bolts  
**49-0052** Large hole adjuster plate, pair  
**49-0053** Small hole adjuster plate, pair  
**49-0054** Medium hole adjuster plate, pair



**Replicas for Indian.**

**VT No. # Item**  
**49-3023** E Ignition Wire Conduit with Clamp, Chrome  
**49-3063** F Carburetor Support Bracket  
**49-3073** G Wire Conduit Bracket  
**53-0514** I 6 Volt Mini Battery

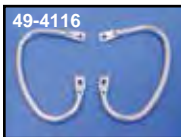

**49-4116 Indian Chrome Rail Hand Set** fits 1922-53 Chief seats without brackets.  
**VT No. 49-4116**



**45" Engine Plaque**  
**VT No. 48-1824**



**Indian Reproduction Rear Fender**  
**VT No. 49-5004**



**Linkert Carb** for Indian. 1 1/4" linkert carburetor assembly features 3 bolt mounting for Indian Chief. Fits 1935-1952.  
**VT No. 35-1350**



**Battery Box and Top** accept 6 amp battery inside. Original black finish and size for Chief including terminals. Order harness separately.

**VT No. Item**  
**49-0458** Battery Dummy  
**28-0072** Battery Pad  
**53-0524** 6V Battery for Above measures 4 3/4 x 3 1/8 x 6 1/16  
**49-4079** 1944-47 Harness  
**49-4078** 1948-53 Harness  
**53-0528** 6 Volt, 29 amp

**Panel Gasket** fits 1947-53 Indian.  
**VT No. 49-4020**

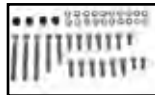

**Zinc Plated Cam Cover Screw Sets** includes breather tube and oil pump in fillister type with washers. Early kit includes pipe plugs.  
**VT No. 49-3047**



**V-Twin Piston and Ring Kits** for Indian Chief, 74" (3.25 bore) include Hastings Ring Set with 3 compression rings (3/32" and a 1 piece oil ring, 5/32") and wrist pin with locks for 2 pistons.

Set	Ring Set Only	Size
—	<b>49-7009</b>	Standard
<b>49-7001</b>	<b>49-7010</b>	.010
<b>49-7002</b>	<b>49-7011</b>	.020
<b>49-7003</b>	<b>49-7012</b>	.030
—	<b>49-7013</b>	.040
<b>49-7005</b>	<b>49-7014</b>	.050
<b>49-7006</b>	<b>49-7016</b>	.060

**Indian Chief Piston Pin** includes locks, pair.  
**VT No. 49-7017**

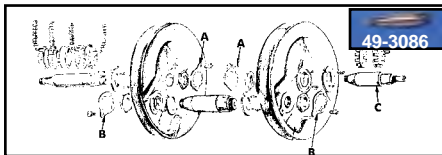

**Chief Flywheel Group.**

**VT No. # OEM Item**  
**17-0939** A D200 Pinion/Sprocket Nut Lock Tab  
**17-0938** B 22B23 Crank Pin Nut Lock Tab  
**49-3086** G 39586 Pinion Shaft

**Parts for Indian**



**Battery** is dry charged and 29 amp. Fits Indian.  
**VT No. 53-0528**  
**Note: Do not over fill, fill to cover to of plates only as per instruction provided. This battery vents through the caps. There is NO Warranty Leakage due over filling**

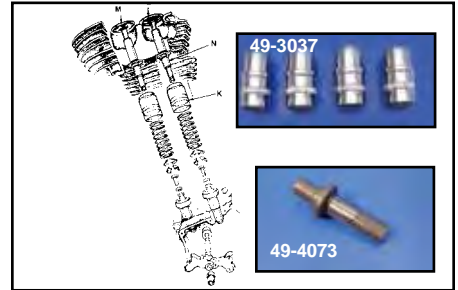

**Top End Components for Chief**

**VT No. # Item/Use**  
**49-3037** K Chrome Valve Spring Cover Set  
**49-4073** N Valve Guide, Standard  
**49-1326** Spring Set



**Head Sets for Chief.**

**VT No. Item**  
**49-0055** Washer Set  
**49-7676** Head Bolt Kit for Chief  
**49-3060** Cylinder Base Studs (8)  
**49-3009** Cylinder Base Nut Set, Zinc



**Gaskets for Indians.**

**VT No. OEM Item**  
**15-1400** 91800 Valve Guide to Spring Cover  
**15-1401** 22B655 Chief Base Gasket with Metal  
**15-1404** 74051-X3 Cam Cover, Chief .025  
**15-1407** 75378B Chief Head, Blue Teflon  
**15-1410** 85283-X Trans Top Cover, Chief



**Sifton Cam Set** without shafts fits 1936-46 .415 lifts.  
**VT No. 49-8550**



**Linkert Needle and Seat** for Indian.  
**VT No. 35-0997**



**Plug** fits top and side of primary case, set, zinc plated.  
**VT No. 49-7557**





# Parts for Indian

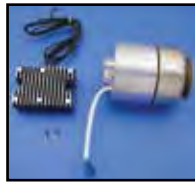

**12 Volt Alternator Conversion** installs where stock generator fits into stock clamp. Use stock belt 12V solid state regulator included.  
**VT No. Item**  
 49-0383 Kit  
 32-0667 Replacement Regulator Kit



**Replacement Parts.**  
**VT No. Item**  
 49-0174 Brake Switch  
 49-0175 Switch Cover, Chrome



**Linkert Parts for Indian.**  
**VT No. Item**  
 35-1350 Complete Carb  
 2465-1 Venturi 1941-48 Chief  
 M-6, M341, M-343, M-34  
 2467-1 80" Chief M-350-M-352  
 M-Bonn  
 35-0621 Nozzle  
 35-0622 Idle Plug  
 35-0997 Needle/Seat  
 49-4133 Choke Lever  
 35-1674 Choke Kit  
 35-0482 Float Bowl  
 35-0281 Float Bowl



Detail

**Replica 16" Indian Wheel** fits front and rear on 1947-up Chiefs. Includes correct rim with stainless large diameter spokes and nipples with black hub.

VT No.	Type	Rim Finish
52-1036	3 Cross	Chrome
52-1038	3 Cross	Black

**Fender Accessories.**  
**VT No. Item**  
 49-4047 Rear Tip  
 49-0304 Polished Rack  
 49-0926 Chrome Rack  
 49-0951 Chrome Rack Replica  
 37-2096 Screw Set

**Replica Indian Shock** includes bushings. Sold as each.  
**VT No. Finish**  
 49-4075 Black  
 49-3032 Chrome

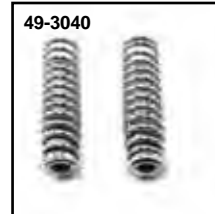

**16" Spoke Sets** with nipples for Indian.

VT No.	Item	Pattern	Rim
45-0678	1935-46	4	
45-0679	1947-53	3	
45-0753*	1936-46	4	52-0786
	1947-53	4	52-0786
45-0344	1947-53	4	52-0786

**18" Spoke Sets** with nipples for Indian.

45-0734	1935-46	4	
---------	---------	---	--

\*Note: To fit OE style rim. Large nipples



**1946-53 Wheel Hub.** Black finish.  
**VT No. 49-3984**



**Brake Handle Assembly Replica** for Indian in chrome.  
**VT No. 49-3010**



**16" x 3" Chrome Rim** with large holes. Fits Indian.  
**VT No. 52-0786**



**Thor Rear Hubs.**  
**VT No. Year**  
 49-5511 1911  
 49-5513 1912-1913



**20ft 520 Chain.**  
**VT No. 19-0679**



**Nickel Plated Eclipse Front Hub** accepts 3/8" axle and includes cones and balls. Fits 1910-1915 F.  
**VT No. 45-0453**

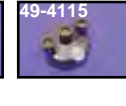
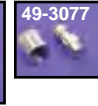
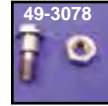
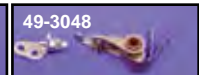
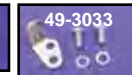

**Ignition Hardware.**  
**VT No. Item**  
 49-3022 Distributor cable clamp  
 49-3033 Points angle bracket  
 49-3048 Points Set  
 49-4115 Distributor Cap  
 49-3077 Distributor Grease Cup  
 49-3078 Distributor Lock Shoulder Bolt



**Taillight Related Accessories.**  
**VT No. Item**  
 49-4025 Lens Retainer  
 49-4008 Lamp Pad  
 49-0175 Switch Cover, Chrome  
 49-4049 License Plate Bracket, late  
 49-0821 Damper Knob



**7" Headlights** includes 12V seal beam unit and high beam indicator with stud type mount as early spring fork style.  
**VT No. Item**  
 33-2156 12V Complete  
 33-0123 12V Beam

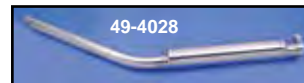

**Chrome Chief Exhausts.**  
**VT No. Item**  
 31-0270 Muffler Clamp 1 1/2"  
 49-4028 Muffler



**Replica Ignition Switch** fits 1937-up Indian with 2 keys.  
**VT No. 49-0253**



**Replica Air Intake Snoot** fits 1908-15 Indian Twin.  
**VT No. 49-0959**



**Oval Mats.**  
**VT No. Item**  
 28-0932 Henderson "X"



**WR Spool Front Wheels** available in 18" and 19" with 2.15" width rim and 6-8 gauge spokes. Hub is nickel plated, spokes are white zinc, rim is black. Hub has retro fitted with sealed ball. Bearings to accept a 3/8" axle.

**WR Front Spool Wheel.**  
**VT No. Size**  
 52-0013 18"  
 52-0014 19"  
 45-0102 Hub

**Parts for Indian.**  
 49-3007 Large Auxiliary Seat Spring Chrome  
 49-3024 Front Axle 1946-48  
 49-3025 Front Axle 1950-53  
 49-3026 Front Axle Sleeve 1946-48  
 49-3027 Front Axle Sleeve 1950-53  
 49-3040 Small Auxiliary Seat Spring  
 49-3042 1946-53 Front Brake Shoe Spring  
 49-3043 Auxiliary Spring Stop

# XL 1957-UP INDEX

<b>A</b>	
ADVANCE UNIT.....	954
AIR CLEANER.....	971-974
AIR FILTER.....	971,972,973,975,976,977
ALTERNATOR.....	959
Conversion.....	959
Rotor.....	959
AXLE.....	1005,1006,1007
<b>B</b>	
BACKREST.....	919
BAFFLE.....	943,944,947
BATTERY.....	844
BEARING.....	916
Cam.....	844
Fork Stem.....	916
Pinion.....	844,845
Wheel.....	1007
BELT DRIVE.....	889
Belt.....	888
Guard/Dress Up.....	889,920
BOLT LIST.....	1319
BOOK.....	1268-1270
BIKE KIT.....	932
<b>BRAKE</b>	
Banjo.....	892,904,905
Cable.....	898
Caliper Front.....	899,900,901
Caliper Rear.....	894,895
Disc.....	900,901,902,903
Disc Brake Pad.....	903
Drum Brake.....	896
Forward Control.....	891-892
Hose.....	904
Lever(Handle).....	896
Line.....	894,905,906
Master Cylinder(Front).....	1052-1053
Master Cylinder (Rear).....	897
Mechanical.....	898
Pedal.....	893,894
Pedal Pad/Peg.....	893,1069
Rod.....	891
Rotor/Disc.....	900,901,902,903
Spring Fork.....	1219,1220
Sprocket.....	886,889
Switch.....	898
Tee/Tube/Fittings.....	904,905
Wheel/Drum Brake Kit.....	896
<b>BREATHER.....</b>	
Upgrade Kit.....	840
Valve Service.....	1265
<b>BUCKLES.....</b>	<b>853,938,963,1325</b>
<b>BUSHING LIST.....</b>	<b>1307</b>
<b>C</b>	
<b>CABLE</b>	
Battery.....	969
Brake.....	988
Choke.....	999
Clamp.....	988
Clutch.....	987
Fittings.....	1200
Idle.....	986
Speedometer.....	988
Oiler Boot.....	987
Spark Plug.....	952,953
Tachometer.....	990-991
Throttle.....	986
Wrap.....	987
<b>CALIPER</b>	
Front.....	899-901
Inserts.....	894
Rear.....	894,895
<b>CAM.....</b>	
Bearing.....	844
Bushing Kit.....	844
Bushing Replace.....	1264
Bushing Service.....	844
Cover.....	839,847
Cover Bushing Service.....	844
Follower.....	874
Gasket/Sealer.....	845
<b>CAPS(Chrome).....</b>	<b>834,841,853</b>
Axle.....	1005

<b>CAPS CONTINUED</b>	
Engine.....	834
Gas.....	996
Oil.....	1000
<b>CARBURETOR</b>	
Bendix.....	980
CV Keihin.....	981
Dell'Orto.....	980
Jet.....	981-984
Mikuni.....	983
S&S.....	984
<b>CASE</b>	
Bolts.....	842
Race/Rollers.....	843
<b>CHAIN</b>	
Adjuster/Tensioner.....	887
Guard.....	889
Primary.....	885
<b>CHARGING SYSTEM.....</b>	
<b>CHOKER CABLE.....</b>	<b>989</b>
<b>CIRCUIT BREAKER.....</b>	<b>967</b>
<b>CLAMP</b>	
Brake.....	988
Cable.....	988
Header.....	946
Intake Manifold.....	978
<b>CLEANERS/POLISH.....</b>	
<b>CLUTCH.....</b>	<b>880-894,929</b>
1971 and earlier.....	881,882
1971-84.....	881,882
1985-90.....	880
1991-up.....	880
Cable.....	882,987
Control(Lever).....	1041,1042,1043,1044
.....	1045,1046,1047,1048,1049
Earlier.....	882
Forward Control.....	890-893
Hub.....	884
Pressure Plate.....	883,884
Shifter Lever.....	890
<b>COIL.....</b>	
<b>COIN HOLDER.....</b>	
<b>CONDENSER.....</b>	<b>951</b>
<b>CONNECTING ROD.....</b>	<b>842</b>
<b>CRANKCASE.....</b>	<b>842</b>
<b>CRANKPIN.....</b>	<b>843</b>
<b>CRANKSHAFT.....</b>	<b>844</b>
Balance Service.....	1263
<b>CYLINDER</b>	
Big Bore Kit.....	857
Gasket.....	858,861,863,864
Head.....	858,859
<b>D</b>	
<b>DERBY.....</b>	<b>834</b>
<b>DIAGNOSTIC.....</b>	<b>958</b>
<b>DIPSTICK.....</b>	<b>999</b>
<b>DISTRIBUTOR.....</b>	<b>961</b>
<b>DOWEL PIN LIST.....</b>	<b>1316</b>
<b>DRAIN PLUG</b>	
Engine.....	874
Fork.....	914
Oil.....	1000
Transmission.....	874
<b>DRESS UP KIT.....</b>	<b>831-834</b>
<b>E</b>	
<b>ELECTRICAL</b>	
Battery.....	969,970
Charging.....	859
Circuit Breaker.....	967
Regulator.....	960
Spark Plug.....	952,953
Starter.....	965-966
Switch.....	967
Terminal.....	968
Wiring.....	968
<b>EMBLEM.....</b>	<b>1206,1208-1209</b>
<b>ENGINE</b>	
Bar/Guard/Peg.....	925
Bushing List.....	1307
Drain Plug.....	874
Flywheel.....	843
Gasket.....	864

<b>ENGINE CONTINUED</b>	
Heads.....	857-859
Mount.....	948,949
Race/Roller.....	843
Seal List.....	1315,1316
Sealant.....	1271
Spacer List.....	1320
Sprocket.....	886,889
Trim/Cover.....	838
<b>EXHAUST.....</b>	<b>935-947</b>
Baffle.....	947
Clamp/Bracket.....	938-942,946
Coating.....	938
End Tips.....	935
Enrichment Device.....	933,936
Flange.....	947
Header Clamp.....	946
Heat Shield.....	945
Port Replacement.....	1265
Taper Valve.....	947
Torque Kit.....	942,944
<b>EXTENDED REACH.....</b>	<b>891</b>
<b>F</b>	
<b>FENDER.....</b>	<b>921,922,923</b>
Lamp.....	922
Mud Flap/Extension.....	921,923
Spring Fork.....	921
Struts/Bolts.....	924
Trim/Tip.....	921
<b>FILTER</b>	
Air.....	971,972,973,975,976,977
Fuel.....	1199-1200
Oil.....	1002,1003
<b>FLASHER.....</b>	<b>1166</b>
<b>FLYWHEEL.....</b>	<b>842,843</b>
<b>FOOTPEG</b>	
Mount.....	918
Relocation.....	942
<b>FORK.....</b>	<b>907-916</b>
Boot/Cover.....	910-915
Brace.....	908
Conversion Kit.....	910
Damper.....	914
Leg Bushing.....	1265
Leg Internal Conversion.....	914
Lock Tab Listing.....	1317
Neck.....	916
Oil.....	1027-1040
Plug(Top).....	913
Riser.....	1034-1040
Seal.....	915
Slider.....	912
Spring.....	913
Spring Fork.....	1219
Spring Fork Rebuild.....	1265
Stabilizer.....	909
Stem Nut/Cover.....	911
Triple Tree.....	909,911
Tube.....	912
<b>FORWARD CONTROL.....</b>	<b>891-893</b>
<b>FRAME.....</b>	<b>931-934</b>
<b>G</b>	
<b>GAS TANK.....</b>	<b>996,998</b>
Cap.....	996,1202-1207,1232
Emblem/Decal.....	1207-1208
Filter/Shut Off.....	1199
Line.....	1200,1201
Mount.....	996
Petcock.....	1196-1198
Tank/Dash Kits.....	993-995,997
<b>GASKET</b>	
Cam Cover.....	1309
Carburetor.....	1313
Derby Cover.....	1310
Exhaust.....	1310
Gas Tank Cap.....	1312
Manifold.....	1313
Master Cylinder.....	1312
Oil Pump.....	866,1313
Primary.....	836,1309,1313
Tail Lamp.....	1313
Transmission.....	1311,1313

<b>GASKET CONTINUED</b>	
Removal.....	1284
Sealant.....	1271
<b>GAUGE</b>	
Covers.....	992
Oil.....	999,1004
Speedo/Tachometer.....	989-991
<b>GENERATOR.....</b>	<b>961</b>
<b>GOGGLES.....</b>	<b>1271</b>
<b>GRIP.....</b>	<b>1083-1090</b>
<b>H</b>	
<b>HANDLEBAR</b>	
Control.....	1044,1045,1046,1047
.....	1048,1049
Damper.....	1039,1040
End Plug.....	1090
Throttle Kits.....	995
<b>HANDLEBAR GRIP.....</b>	<b>1083-1090</b>
<b>HARDTAIL.....</b>	<b>934</b>
<b>HARDWARE KIT.....</b>	<b>841</b>
<b>HEAD.....</b>	<b>856,861,863</b>
Gasket.....	863
Remanufacture.....	1264
Resurfacing.....	1261
<b>HEADLAMP.....</b>	<b>1091-1093,1095-1109</b>
Bates.....	1099
Bracket.....	1101,1104,1108,1109
Bulb.....	1093,1100,1106,1107
Connector.....	1096
Cowl.....	1091,1095
Cycle Ray.....	1105
Fork Cover Set.....	1095
HID.....	1109
Spotlamp.....	1110-1115
Spring Fork.....	1104
Trim/Visor/Ring.....	1094,1095,1101
.....	1102,1106,1107,1152,1165
<b>HEATSHIELD.....</b>	<b>996</b>
<b>HELICOIL</b>	
Installation Service.....	1264
<b>HORN.....</b>	<b>1173</b>
Bracket.....	1173
<b>HOSE/LINE.....</b>	<b>1200-1201</b>
<b>HUB.....</b>	<b>1005,1007</b>
<b>I</b>	
<b>IGNITION.....</b>	<b>954-958</b>
Advance Unit.....	954
Booster.....	951
Coil.....	950,957,958
Condenser.....	951
Controller.....	951,958
Cover(Points).....	955
Kits.....	956,957
Magneto.....	1294-1296
Module.....	956-958
Points.....	951,954,955
Spark Plug.....	952,953
Timing Plug.....	842,955
Tune Up.....	951
Vacuum Switch.....	958
Wire.....	953,966
<b>INDICATOR LAMP.....</b>	<b>992</b>
<b>INSPECTION TAG.....</b>	<b>1100</b>
<b>INSPECTION COVER.....</b>	<b>832,834,836</b>
<b>INTAKE MANIFOLD.....</b>	<b>978</b>
EFI.....	978
<b>J</b>	
<b>JETS.....</b>	<b>982-983</b>
<b>K</b>	
<b>KEY CHAIN/KEY HOLDER.....</b>	<b>1324</b>
<b>KEY.....</b>	<b>1325</b>
<b>KICKSTAND.....</b>	<b>917</b>
<b>KICKSTART.....</b>	<b>877-879</b>
Conversion Kit.....	878
Pedal/Arms.....	878
Ratchet.....	877
Wiring.....	969
<b>KROMMET.....</b>	<b>1145,1146,1147,1316</b>
<b>L</b>	
<b>LAPEL PINS.....</b>	<b>1324,1327</b>
<b>LENS.....</b>	<b>1136,1137,1139,1153</b>



<b>LEVERS</b>	
Pin & Bushing.....	997
<b>LICENSE HOLDER.....</b>	<b>1142-1144</b>
<b>LIFTER BASE.....</b>	<b>857</b>
<b>LIFTS.....</b>	<b>1273,1274</b>
<b>LIGHTS</b>	
Bar.....	1153
Bulbs.....	1106,1107,1114,1140-1141
Fender.....	1129,1131-1132,1169
Gasket.....	1165
Headlamp.....	1091-1093,1095-1109
Indicator.....	1101,1168
Marker.....	1148-1151,1150,1154
Reflector.....	1166
Signal.....	1154-1164,1220
Spotlamp.....	1110-1115
Tachometer/Speedometer.....	1168
Tail Lamp.....	1116-1138
Turn Signal.....	1154-1164
<b>LOCK TAB LIST.....</b>	<b>1317</b>
<b>LOWERING KIT.....</b>	<b>927</b>
<b>LUGGAGE RACK.....</b>	<b>919,1013</b>
<b>M</b>	
<b>MAGNETO.....</b>	<b>1294-1296</b>
<b>MAINSHAFT.....</b>	<b>867</b>
<b>MANIFOLD.....</b>	<b>978,979</b>
<b>MANUALS.....</b>	<b>1268-1269</b>
<b>MASTER CYLINDER</b>	
Cover/Gasket.....	897
Front.....	1052-1053
Rear.....	897
Rebuild.....	897
<b>MIRROR.....</b>	<b>1176-1195</b>
<b>MODULE.....</b>	<b>958</b>
<b>MOTOR SHOP SERVICES</b>	
Cam Bushing Service.....	844,1264
Alternator Ring Replacement.....	1263
Cam Bushing XL.....	844,1264
Crankshaft Balance.....	1263
Cylinder Boring.....	1260
Cylinder Slewing.....	1260
Flywheel Balancing.....	1262
Flywheel Remanufacture.....	1261
Fork Leg Bushing Install.....	1265
Fork Leg Internal Conversion.....	1265
5 Speed Rebuild.....	1265
Generator Rebuild.....	1263
Head Remanufacture.....	1269
Head Resurface.....	1264
Mainshaft Assemblies.....	1267
Magneto Rebuild.....	1294
Spark Plug Helicoil Service.....	1264
Valve Seat Service.....	1265
Wheel Truing/Build.....	1265
<b>MOTORCYCLE COVER.....</b>	<b>1266</b>
<b>MUD FLAP.....</b>	<b>923</b>
<b>N</b>	
<b>NECK CUP KIT.....</b>	<b>916</b>
<b>NUT LIST.....</b>	<b>1321,1322</b>
<b>O</b>	
<b>OIL</b>	
Cap.....	1000
Cooler.....	999
Cover(Tank).....	1000,1001
Dipstick.....	999
Filter.....	1002,1003
Gauge.....	994
Line.....	866
Pressure Switch/Pressure.....	865,866
Pump.....	866
Seal List.....	866
Tank.....	932,1000-1001
<b>P</b>	
<b>PATCHES (CLOTH).....</b>	<b>1323</b>
<b>PARTS MANUAL.....</b>	<b>1268-1270</b>
<b>PEGS.....</b>	<b>1062-1073</b>
<b>PETCOCK.....</b>	<b>1296-1298</b>
<b>PILLION PAD.....</b>	<b>844,845,929</b>
<b>PIN LIST.....</b>	<b>1318</b>
<b>PINION.....</b>	<b>844,845,929</b>
<b>PIPES.....</b>	<b>945-946</b>
<b>PISTON.....</b>	<b>960-961</b>

<b>PLUGS</b>	
End Plug (Handlebar).....	1090
Fork.....	913
Magnetic.....	874,1000
Oil Tank.....	999,1000
Spark Plug.....	952,953
Timing.....	955
Transmission.....	869,874
<b>POINTS.....</b>	<b>954</b>
Cover.....	935
<b>POLISH/CLEANERS.....</b>	<b>1271</b>
<b>PRIMARY</b>	
Chain.....	885
Cover/Trim.....	832-834
Derby.....	834
Dress Up Kits.....	834-835
Inspection (Cover).....	832
<b>PULLEY</b>	
Cover.....	888,920
Guard.....	889
<b>PUSHROD.....</b>	<b>848</b>
Cover.....	849
Engine.....	848
<b>R</b>	
<b>RACE.....</b>	<b>844</b>
<b>RAIL.....</b>	<b>919</b>
<b>REGISTRATION HOLDER.....</b>	<b>1120</b>
<b>REGULATOR/RELAY.....</b>	<b>960</b>
Covers.....	960
<b>RINGS.....</b>	<b>862</b>
<b>RISER.....</b>	<b>1034-1040</b>
<b>ROCKER</b>	
Arm.....	850
Cover/Trim.....	840,850
End Caps.....	850
Gasket.....	864
<b>ROD</b>	
Brake.....	891
Connecting.....	842,843
Clutch.....	842
<b>ROLLER PIN LIST.....</b>	<b>1316</b>
<b>ROLLER.....</b>	<b>843</b>
<b>S</b>	
<b>SADDLEBAG.....</b>	<b>1011</b>
<b>SCREW LIST.....</b>	<b>1322</b>
<b>SEAL LIST.....</b>	<b>1315,1316</b>
<b>SEALANT.....</b>	<b>1271</b>
<b>SEAT</b>	
Rigid.....	1010
Solo.....	1011,1012
<b>SERVICE MANUAL.....</b>	<b>1268,1269,1270</b>
<b>SHAFT</b>	
Motor Sprocket.....	887
Pinion.....	844,845,929
Rocker Arm.....	850
Shift Fork.....	874
<b>SHIFT.....</b>	<b>874</b>
Cam Follower.....	874
Fork.....	874
Lever.....	890
Linkage/Rod.....	891
Peg.....	890
Shaft.....	873
<b>SHIM LIST.....</b>	<b>866,1307</b>
<b>SHOP SERVICES.....</b>	<b>1261-1265</b>
<b>SHOW BIKE BOLT KIT.....</b>	<b>847</b>
<b>SISSY BAR/PAD.....</b>	<b>919,1240</b>
<b>SLIDER.....</b>	<b>912</b>
<b>SOLENOID.....</b>	<b>965</b>
<b>SKULL STUFF.....</b>	<b>1017-1022</b>
<b>SPACER LIST.....</b>	<b>1320</b>
<b>SPARK PLUG.....</b>	<b>953,967</b>
Helicoil Replacement.....	1265,1306
<b>SPEEDOMETER.....</b>	<b>990,991</b>
Brackets.....	982
Cable.....	988
Drive Unit.....	988,989
Sensor/Sending.....	989
<b>SPOKE.....</b>	<b>1009</b>
<b>SPOOL WHEEL.....</b>	<b>1218</b>
<b>SPOTLAMP.....</b>	<b>1110-1115</b>
<b>SPRING FORK.....</b>	<b>1217-1221</b>
<b>SPRING FORK REBUILD.....</b>	<b>1265</b>

<b>SPROCKET</b>	
Chain Conversion.....	889
Compensating.....	887
Cover.....	878,875,886,892
Drive.....	886
Motor.....	887
Offset.....	886,889
Rear.....	886
Shaft.....	846
<b>STARTER.....</b>	<b>963,964,966</b>
Cover.....	963,965
Drives.....	966
Housing.....	965
Relay.....	964
Solenoid.....	965
<b>STATOR.....</b>	<b>959</b>
<b>STRUT.....</b>	<b>924</b>
<b>STUD LIST.....</b>	<b>1312</b>
<b>SUSPENSION.....</b>	<b>926-928</b>
<b>SWING ARM.....</b>	<b>930,931</b>
<b>SWITCH</b>	
Brake.....	898
Handlebar.....	1047
Ignition.....	967
Oil Pressure.....	866
Repair.....	1051
Vacuum.....	958
<b>T</b>	
<b>TACHOMETER.....</b>	<b>990-991</b>
Cable/Gear.....	1296
<b>TAIL LAMP.....</b>	<b>1116-1138</b>
Assemblies.....	1116-1138
Bulb.....	1141
Connector.....	1141
Fender Mount.....	1117,1129,1131,1132
Lens.....	1137-1138
License Bracket.....	1137-1139
Side Mount.....	1121-1128
Tombstone.....	1134,1135
Vintage.....	1132-1134,1136,1137
Wiring.....	1128
<b>TAPPET.....</b>	<b>835,848,851</b>
Base Cover.....	835,852
<b>THROTTLE.....</b>	<b>985</b>
<b>TIMING.....</b>	<b>832,955</b>
<b>TIRE.....</b>	<b>1210-1217</b>
Tube.....	1217
Valve Stems.....	1217
<b>TOOL</b>	
Box.....	1013
Kit.....	1267
XL.....	929
<b>TRANSMISSION.....</b>	<b>868-870,873</b>
Countershaft.....	872
Door.....	874
Drain Plug.....	869
Mainshaft.....	871
Pawl.....	874
<b>TRIPLE TREE.....</b>	<b>909</b>
Conversion Kit.....	910
Spring Fork.....	1219
Stem Nut.....	921
<b>TUBE (Tire).....</b>	<b>1217</b>
<b>TUNE UP.....</b>	<b>951</b>
Advance Unit.....	954
<b>V</b>	
<b>VALVE.....</b>	<b>852,853</b>
Guide.....	854
Keepers.....	855
Seal.....	855
Seat Service.....	1264
Springs/Collar/Key.....	855
<b>VELOCITY STACK.....</b>	<b>972</b>
<b>VOLT REGULATOR.....</b>	<b>960</b>
<b>W</b>	
<b>WHEEL.....</b>	<b>1008,1009</b>
Adjuster.....	1007
Axle.....	1005,1006
Building and Truing.....	1265
Hub.....	1005
Rim.....	1009
Spoke.....	1009

<b>WHEEL CONTINUED</b>	
Spool.....	1218
<b>WINDSHIELD.....</b>	<b>1014</b>
<b>WIRING</b>	
Enrichment Device.....	935
Fuse.....	967
Handlebar.....	969,1049,1050,1061
Harness.....	968,969
Shrink Wrap.....	967
Spark Plug.....	953
Switch.....	960
Terminal/Connectors.....	968
Tail Lamp.....	968
Tie Strap.....	968
<b>WRIST PIN.....</b>	<b>843,860,861</b>
<b>X</b>	
<b>XL TOOLS.....</b>	<b>929</b>



# Dress Up Kit

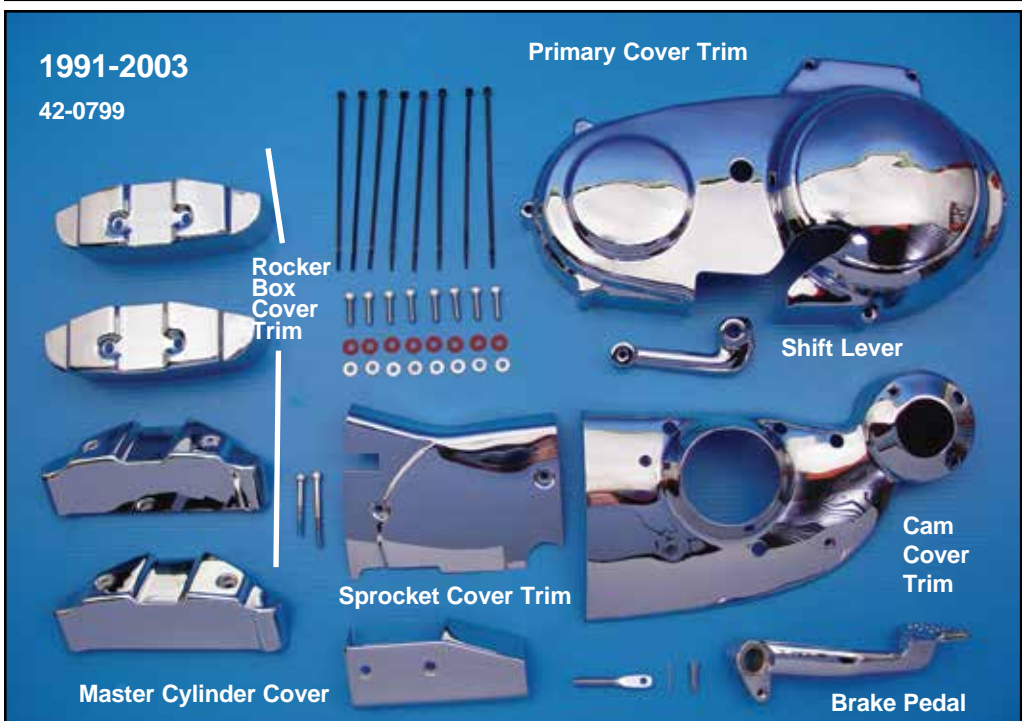

XLCH Motor Plaque features 1971 style Ironhead Sportster.  
VT No. 48-0372

**V-Twin Chrome Dress Up Kits** include chrome primary cover trim, cam cover trim, rocker box cover trim, master cylinder cover and chrome sprocket cover. Also included is chrome brake pedal and chrome shift lever to add a finished touch. **Note:** 2004-up models require purchase of primary derby cover available separately.

VT No.	Item	Year
42-0799	With Brake/Shift Pedal	1991-03
42-0846	Without Brake/Shift Pedal	1991-03
42-0947	Without Brake/Shift Pedal	2004-up



1991-2003 Right Side



Left Side

XL





# 1991-2003 Primary Cover



Easy Installation!



Form Fitting Chrome Steel Covers fit over stock primary covers to mirror the contour for a skin tight fit. Covers are held in place by existing hardware. Installation takes less than 10 minutes.



V-Twin Cover Trim

42-0750 Installed



42-0750



42-0996

Chrome Primary Cover Trim fully covers the existing aluminum primary and is secured in place by the 5 of the existing screws. 1994-2003 type available as cover with choice of derby as listed on this page. 42-0996 requires the re-installation of clutch cable for installation and purchase of derby.

VT No.	Year	Type
42-0750	1991-2003	Full
42-0996	1994-2003	Open Derby



1994-2003 Kit  
43-0235

Outer Primary Covers available as cover only or kit which includes cover, allen screw set, inspection covers and gasket.

Chrome Cover	Black Cover	Kit	OEM	Year
43-0221	—	43-0234	25430-89	1991-1993
43-0220	43-0375	43-0235	25460-94	1994-2003

Chrome Inspection Cover Set for 1991-93 models.

VT No.	Item
37-8992	Cover Set
42-0868	Cap, each
14-0917	O-Ring for Cover
37-8701	Screws, chrome
14-0547	O-Ring for Screws

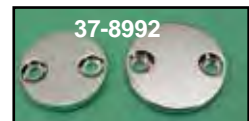

37-8992

Chrome Chain Inspection Cover fit 1994-2003 models.

VT No.	OEM	Item
42-0756	34761-94	Chain Cover Inspection
14-0917	11188	O-Rings for Above
42-0756	37-8701	41191-74 Screws for Above

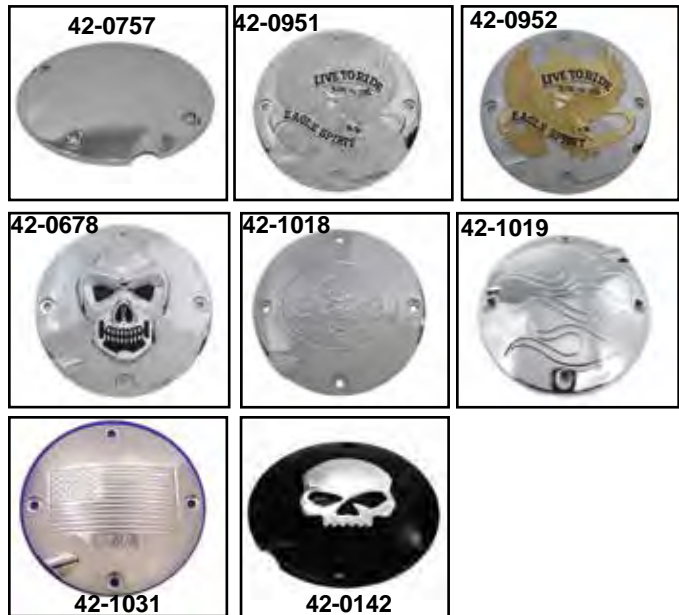

42-0757

42-0951

42-0952

42-0678

42-1018

42-1019

42-1031

42-0142

Clutch Inspection Covers

Chrome	Black	Finish/Style
42-0757		Smooth, 1994-2003
42-0951		Eagle Spirit, 1994-2003
42-0952		Gold Eagle Spirit, 1994-2003
42-0678		Raised Chrome Skull, 1994-2003
42-1018		Skull, 1994-2003
42-1019		Flame, 1994-2003
42-1031		USA Flag. 1994-2003
14-0570		O-Ring For Above, 25463-94
	42-0142	Raised chrome skull 1993-2003



# Primary Covers



**Outer Primary Cover** for XL. Order hardware, derby cover and gaskets separately.

**Chrome Black Fits**

**43-0220 43-0375** 1994-03

**43-0287** 2004-06

**43-0285 43-0372** 2007-up

**42-0996 42-0360** Primary Cover Trim, 1994-2003

**42-0939 42-0359** Primary Cover Trim, 2004-up



**Chrome Black Item**

**42-0933 42-0357** Cam Cover Trim

**42-9975 42-0358** Cam Cover Trim

**43-0185 43-0329** Sprocket Cover

**43-0149 43-0330** Sprocket Cover

**42-0845 42-0383** Transmission Sprocket Cover Trim

**42-0930 42-0384** Transmission Sprocket Cover

Die Cast Primary Covers are manufactured from a casting process. It is the nature of parts produced from this process to have small random subsurface imperfections that can be uncovered during the polishing process. These may appear as very small cosmetic imperfections after chrome plating. We also do not polish in areas that are not readily visible once assembled on the motorcycle or by polishing machines such as small depressions or tight corners. As these conditions are common in polished and chrome-plated castings, a reasonable standard of acceptability has been established to bring you the highest quality product at an affordable price. This part meets Perma Chrome™ cosmetic standard. The aforementioned cosmetic conditions are considered reasonable for this part and are not considered warrantable.



**Rocker Box Top Cover** includes D-ring kit.

Black	Chrome	Fits	Pieces
<b>42-0362</b>	<b>42-0789</b>	1986-1990	4
<b>42-0363</b>	<b>42-0946</b>	1986-2003	4
<b>42-0352</b>	<b>42-1063</b>	2004-2006	4
<b>42-0353</b>	<b>42-0364</b>	2007-2012	4



**Black Wrinkle Finish Outer Primary Cover**

VT No.	OEM	Fits
<b>43-0463</b>		2004-05
<b>43-0464</b>	25307-06	2006-up

## Engine Dress Kit



**Dress Kits** for XL's include all die cast replacement parts as pictured.

VT No.	Year
<b>42-0690</b>	1994-03
<b>42-1055</b>	1991-93

XL





# 2004-up Primary Cover



Form Fitting Chrome Steel Covers fit over stock primary covers to mirror the contour for a skin tight fit. Covers are held in place by existing hardware. Installation takes less than 10 minutes.



Outer Primary Covers available as chrome cover only or kit which includes chrome cover, chrome allen screw set, inspection covers and gasket. **\*\*Note:** Black Wrinkle Finish.

Chrome Cover	Black Cover	Kit	OEM	Year
43-0263	—	43-0275	25460-04	2004-05
43-0287*	—	—	25460-04	2004-05
43-0462	43-0464**	—	25460-06	2006-up
43-0285*	—	43-0284	25539-06	2006-up
—	43-0372	—	—	2007-up

\*Note: Perma Chrome Brand

2004-up XL Trim bolts over existing stock primary cover. Order inspection and derby cover separately. Clutch cable must be removed and reinstalled for installation.

Chrome	Black	Item
42-0939	42-0359	Cover
37-1201	—	Screw Set

## Snap Cap™

Easy to Install!

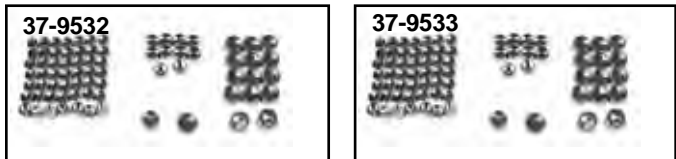

Chrome Bolt Cap Cover Kit for Sportster.

VT No.	Model	Kit Quantity
37-9532	2004-up	77
37-9534	2004-up Engine	63
37-9533	1984-03	74

These bolt cover kits will make any bike look great and are also for custom builders use. Easy to install these new kits have beautifully designed pieces to cover the raw OE bolt heads on engine, transmission, primary and more, each kit includes detailed instruction for installation on each model as listed, all covers in each kit are individually packed and numbers for identification. Installation has never been easier.

2004-up Derby Covers are chrome except 42-0713 which is gold inlay.

VT No.	Style
42-0713	Eagle Spirit, Gold
42-0728	Eagle Spirit, Chrome
42-0967	Smooth
42-1017	Flame
42-1045	USA
42-0141	Skull
42-1266	Chrome skull
42-0192	Chrome, smooth
42-0193	Black, smooth
42-0468	Chrome with chrome flame
42-0469	Black with chrome flame
42-1251	Black with chrome skull
42-1255	Chrome with chrome skull
42-1256	Chrome with black skull
42-0968	Inspection Cover
42-1374	Chrome Air Flow
42-1378	Black Air Flow
42-1278	Black with chrome skull

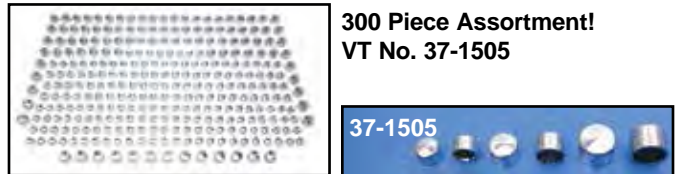

Chrome Caps snap on knurled allen screws for ease of installation. Packs of 100.

VT No.	Fits
37-1502	1/4"
37-1503	5/16"
37-1504	3/8"
37-1505	Assortment

- Snap On
- Tight Fit
- Easy Installation
- Universal Use



# 1986-90 Dress Up Kit

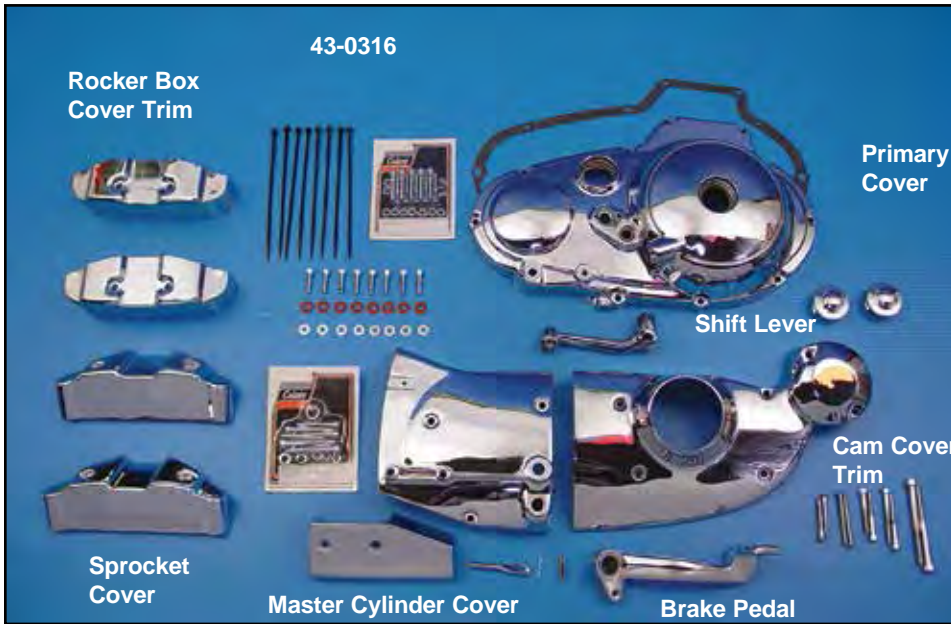

Left Side



Right Side

V-Twin Chrome Dress Kits for 1986-90 XL models includes chrome primary cover with inspection covers, cam, rocker box, master cylinder and sprocket covers. Also included is chrome brake pedal and chrome shift lever to add a finished touch. Hardware for installation included.

VT No.	Type
43-0316	With brake/shifter pedal
42-0847	Without brake/shifter pedal
42-8690	With brake/shifter

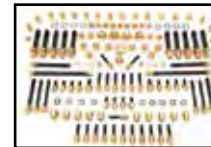

**1986-90 Gold Show Kit** includes all acorn nuts for engine.  
VT No. 7919-G

Die Cast Primary Covers are manufactured from a casting process. It is the nature of parts produced from this process to have small random subsurface imperfections that can be uncovered during the polishing process. These may appear as very small cosmetic imperfections after chrome plating. We also do not polish in areas that are not readily visible once assembled on the motorcycle or by polishing machines such as small depressions or tight corners. As these conditions are common in polished and chrome-plated castings, a reasonable standard of acceptability has been established to bring you the highest quality product at an affordable price. This part meets Perma Chrome™ cosmetic standard. The aforementioned cosmetic conditions are considered reasonable for this part and are not considered warrantable.

## Tappet Base Cover



**Chrome Cylinder Base Cover** fits the area cylinder base on left side of engine. Fits 2004-up.  
VT No. 42-1171



42-1171 Installed



**Chrome Tappet Covers** fit 1986-90, four piece. Presses onto tappet block.  
VT No. 42-0113



**Chrome Tappet Base Cover** is die cast one piece covering the area from the pushrod tube base to the cam cover. Fits 1991-2003.  
VT No. 42-0447



**Chrome Tappet Bar Base Cover.** Fits 2004-up XL.  
VT No. Item  
10-0565 Base Set  
2224-8 Screw Set  
15-1273 Gasket and Pushrod Tube O-Ring Kit



**Chrome Tappet Block Cover Set** features contour for perfect fit over existing stock style lifter blocks, securely held in place by 4 chrome allen screws supplied. Pushrods must be removed for installation. Original design by Motoy-Cycle™ Accessories. 1957-85 XLH-XLCH.  
VT No. 42-0115





# 1986-90 Primary Cover



**Chrome Outer Primary Covers** available as chrome cover only or kit which includes chrome cover, chrome allen screw set, inspection covers and gasket. Replaces 25430-86.

VT No.	Item
43-0128	Chrome
43-0371	Black
43-0236	Chrome Kit



**Chrome Inspection Cover Set** for clutch and chain on primary cover for 1986-90.

VT No.	Colony	U/M	Style
37-8690	—	Pair	Stock
37-8991	—	Pair	Hex
8776-2T	8776-2	Each	Hex
	2558-1	Each	Allen



**Primary Cover Gasket Kit** includes gaskets and small parts for left side repairs.

## Primary Hardware Screw Sets for Sportsters



Stock Screw



Acorn Screw



Allen Screw

**Primary Screw Sets for Sportsters.**

Chrome	Cadmium	Type	Years	Model
9852-5	9853-5	Stock	1952-56	K
—	9851-5	Stock	1957-66	XL-XLH
8890-20	8891-20	Stock	1964-69	XLCH
8892-12	8893-12	Stock	1967-70	XLH
9753-9	—	Allen	1957-69	XLCH
8785-12	—	Allen	1971-76	XLCH-XLH
8785-12T	—	Allen	1971-76	XLCH-XLH
8788-11	—	Allen	1977-85	XLCH-XLH
8788-11T	—	Allen	1977-85	XLCH-XLH
9749-11	—	Allen	1986-90	XL
9749-11T	—	Allen	1986-90	XL
9767-15	—	Allen	1991-93	XL
9767-15T	—	Allen	1991-93	XL
9769-17	—	Allen	1994-2003	XL
9769-17T	—	Allen	1994-2003	XL
2220-24	—	Allen	2004-up	XL
7149-11	—	Acorn	1971-76	XLH, XLCH
9768-15	—	Acorn	1991-93	Evolution XL's

GB No.	Fits
15-0624	1967-76 XLH 1971-76 XLCH
15-0625	1977-79 All
15-0627	1980-89 All
15-0674	1990
15-0698	1991-2003 All
15-0880	2004-up

James	Fits
15-1428	1967-76 XL
15-0873	1977-90 XLH-XLCH
15-1429	As Above Foamet® with Silicone Bead
15-0874	1991-2003 All XL
15-1427	As Above Foamet® with Silicone Bead
15-0881	2004-up

**Primary Cover Gaskets.**

GB No.	James	OEM	Fits
15-0388	—	34955-04	2004-up Primary Cover
15-0056	—	As Above	Metal with foam rubber coating
15-0307	—	34955-89A	1991-2003 XL Primary Cover
15-0769	—	Pair	1991-2003 XL Primary Cover
15-0647	15-1154	34955-89X	1991-2003 XL Primary Cover with Bead (.030")
15-0057	—	As Above	Metal with foam rubber coating
—	15-1423	As Above	Foamet® with Bead
15-0646	15-1153	34955-75X	1977-90 XL/XR 1000 Primary Cover with Bead (.030")
15-0170	15-0912	34955-75	1977-90 Primary Cover
15-0058	—	As Above	Metal with foam rubber coating
—	15-1425	As Above	Foamet® with Silicone Bead
15-0211	—	34624-77	1977-90 Footpeg Stud
15-0169	15-0911	34955-67A	1967-76 XL Primary Cover
15-0406	—	As Above	With Silicone Bead
—	15-1424	As Above	Foamet® with Silicone Bead
15-0168	15-1042	34952-52A	1952-69 XL Primary Cover
15-1215	—	—	52-69 XL Primary Cover Thick
15-1540	—	34986-04	2004-up Inspection Cover
15-0190	15-1046	35169-52	1952-84 Mainshaft Plate
15-0212	15-1053	37762-52	1954-70 Clutch Cover
15-0178	15-0920	60567-36	1958-69 Inspection Cover
15-0663	—	63858-49	1984-98 Evolution Rocker Cover Bolt Washer



# 1971-85 Dress Up Kit



## V-Twin Dress Up Chrome Engine Dress Up Kits for XL's.

1971-83 type kits include primary cover with plugs, sprocket/kicker cover and cam cover trim. Chrome hardware is included to facilitate assembly. Rocker boxes are not included.

VT No.	Years	Model	Starter
43-0310	1971-76	XLCH	Kick
43-0311	1971-76	XLH	Kick and Electric
43-0312	1977-78	XLCH	Kick
43-0313	1977-78	XLH	Kick and Electric
43-0317	1979	XLH	Kick and Electric
43-0314	1980	XLH	Electric
43-0315	1981-82	XLH	Electric
43-0318	1984-85	XLH	Electric with Alternator

# 1971-85 Primary Cover Kit



XLH-XLCH Outer Primary Covers available as cover only. VT No. 43-0328 fits Iron Head models with alternator in clutch drum.

VT No.	OEM	Finish	Fits
43-0227	34949-75A	Chrome	1977-83
43-0105	34949-75A	Polish	1977-83
43-0328	25430-84	Chrome	1984-85
43-0225	34949-71	Polish	1971-76
43-0226	34949-71	Chrome	1971-76



Chrome Primary Cover Kits for 1971-83 XLH-XLCH models. Kits include chrome die cast outer primary cover with bearing installed, inspection cover, clutch adjuster cover, gasket and chrome allen screw set.

VT No.	Years	Fits
43-0237	1971-76	Generator
43-0238	1977-83	Generator
43-0254	1984-85	Alternator

## Inspection Plugs

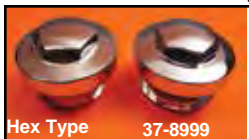

Primary Cover Chrome Caps for 1971-84. Available as sets or each, in stock, slotted or hex design.

**Hex Type.**

Set	Each	Year	Fits
37-8999	—	1971-76	Filler Cap and Clutch Adjuster
—	7600-4	1971-76	Filler Cap
—	7600-4T	1971-76	Filler Cap
—	2559-1	1971-76	Filler
—	7601-2	1971-76	Clutch Adjuster
—	7601-2T	1971-76	Clutch Adjuster
37-8989	—	1977-84	Filler Cap and Clutch Adjuster
—	2557-1	1971-76	Clutch Adjuster
—	7809-2T	1977-84	Filler Cap
—	2879-1	1971-76	As Above

**Chrome Stock Style.**

Set	Each	Year	Fits
37-0050	—	1971-76	Filler and Clutch Adjuster
37-7176	—	1971-76	Set
37-7784	—	1977-84	Filler and Clutch Adjuster
—	37-0451	1952-70	Filler, Alloy
—	37-0452	1952-70	Filler, Chrome

Die Cast Primary Covers are manufactured from a casting process. It is the nature of parts produced from this process to have small random subsurface imperfections that can be uncovered during the polishing process. These may appear as very small cosmetic imperfections after chrome plating. We also do not polish in areas that are not readily visible once assembled on the motorcycle or by polishing machines such as small depressions or tight corners. As these conditions are common in polished and chrome-plated castings, a reasonable standard of acceptability has been established to bring you the highest quality product at an affordable price. This part meets Perma-Chrome™ cosmetic standard. The aforementioned cosmetic conditions are considered reasonable for this part and are not considered warrantable.



Primary Cover Inserts feature adhesive back. Fits 1971-76. VT No. 48-1985



Inserts for 1971-76 Primary are chrome steel with double-stick adhesive strip to fit in recess in aluminum primary cover, sold each. VT No. 42-0609



Primary Cover is constructed of stamped steel. Inspection cover included. Replaces 34949-64. Fits 1958-69 XLCH. VT No. 42-0700

XL





# Dress Up Kit



42-0932 Installed



42-0932  
2004-up Electric



42-0680,  
42-0658

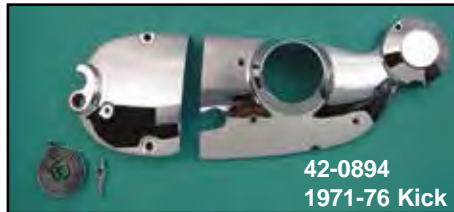

42-0894  
1971-76 Kick



42-0896  
1977-78  
Kick

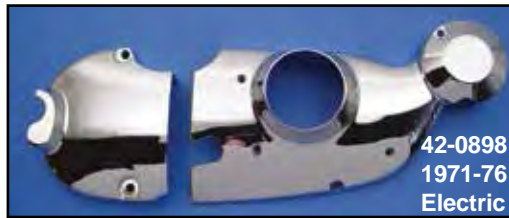

42-0898  
1971-76  
Electric



42-0895

**V-Twin™ Dress Up Kit** fits right side on XL models. **1983-03 kits** include chrome steel cam cover trim, chrome die cast sprocket cover, chrome master cylinder cover and hardware. **1980-82 kits** include chrome sprocket cover, chrome master cylinder and cam cover trim with hardware. **1971-78 kits** include chrome sprocket cover and cam cover trim with hardware. **2004-up kit** includes chrome dress trim to fit over sprocket and cam cover.

VT No.	Year	Model	Type
42-0894	1971-76	Chain	Kick
42-0898	1971-76	Chain	Electric
42-0895	1971-76	Chain	Kick and Electric
42-0896	1977-78	Chain	Kick
42-0899	1977-78	Chain	Electric
42-0897	1977-78	Chain	Kick and Electric
42-0914	1979	Chain	Kick and Electric
42-0680	1980	Chain	Electric
42-0658	1981-82	Chain	Electric
42-0650	1983-90	Chain	Electric
42-0651	1991-2003	Belt and Chain	Electric
42-0932	2004-up	Belt	Electric



42-0899  
1977-78  
Electric



42-0914  
1979  
Kick and Electric



42-0650,  
Electric

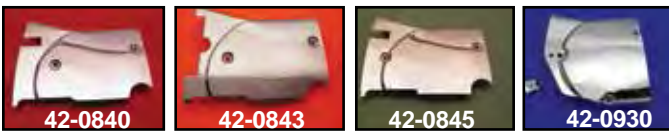

42-0840

42-0843

42-0845

42-0930

**Sprocket Cover Trim** fits over existing cover for XL's as noted.

Chrome	Black	Years
42-0840		1986-90
42-0843		1981-85
42-0845	42-0383	1991-2003
42-0930	42-0384	2004-up



42-0383

42-0384



42-0651



# Chrome Trim



**Dress Up Set** features brilliant chrome covers to fit over original aluminum covers which are formed to mirror the contour for a skin tight fit. Order derby, and points cover separately for 42-1052 and 42-1051.

**VT No. Year**  
**42-1050** 1991-03  
**42-1052\*** 1991-03  
**42-1051** 2004-up  
 \*Note: Open Derby Access



**Sprocket Cover Kit and Belt Guard.** Fits 2004-up XL.  
**Chrome Black**  
**43-0388 43-0389** Outlaw Sprocket Cover Kit  
**27-0832 27-0833** Outlaw Belt Guard

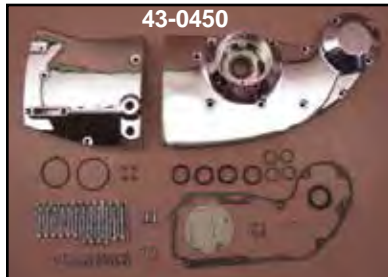

**Chrome Right Side Cam Cover/Sprocket Cover Set** for XL's includes both pieces with gasket and chrome allen screws for assembly.

**VT No. Year**  
**43-0449** 1986-90  
**43-0450** 1991-2003



**Cam Cover Trim** installs over original cover for 2004-up XL.  
**VT No. Finish**  
**42-0138** Alloy  
**42-0137** Black

# Cam Cover Trim



**Form Fitting Chrome Steel Covers** fit over stock cam cases on XL models. No need to remove cam case or disturb cams or gears. Covers held in place by existing screws and related hardware as supplied. Note: 42-9962 is kickstart only. All other numbers are for electric start.

**VT No. Fits**  
**42-9961** 1971-78  
**42-9962** 1971-78  
**42-9968** 1979-80  
**42-9963** 1981-82  
**42-0110** 1983-90  
**42-9975** 1991-2003  
**42-0933** 2004-up







# 1986-up Rocker Covers



Rocker Box Top Cover includes D-ring four piece kit.

Chrome	Black	Fits
42-0789	42-0362	1986-1990
42-0946	42-0363	1991-2003
42-1063	42-0352	2004-2006
42-0364	42-0353	2007-up



2004-up Top  
Rocker Cover  
Set.  
VT No. 10-0566



Chrome Lower Rocker Box  
and Gasket Set fits 1991-03  
models.  
VT No. Item  
42-0220 Kit, 1991-03  
43-0165 Lower Only 1999-03



Chrome Rocker Cover Screw Kits in acorn or allen type for 1986-up.

VT No.	Type
8868-16	Acorn
8931-16	Allen
9788-24	Button Head Allen

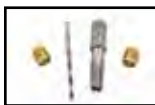

Sifton Rocker Box Breather Upgrade Kit  
includes tap, drill bit, breather tubes and  
instructions. Fits 1992-03 Evolution.  
VT No. 16-0916

# Rocker Box Dress Cover Set



Chrome Rocker Box  
Dress Cover Sets  
fits over rocker box  
assembly without dis-  
assembly of engine.  
Chrome allen screws  
included. Fits 1986-up.  
VT No. 42-0796

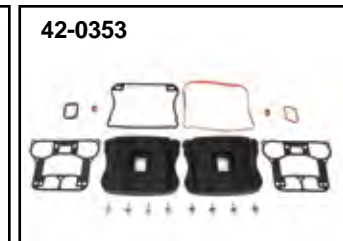
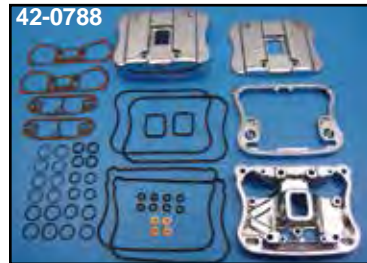

Rocker Cover Sets. Kits include gaskets for both heads.

Chrome	Black	Fits	Pieces
42-0788	—	1986-1990	6
42-0792	—	1991-2003	6
42-5520	42-0352	1986-2006	4
42-5524	42-0353	2007-up	4

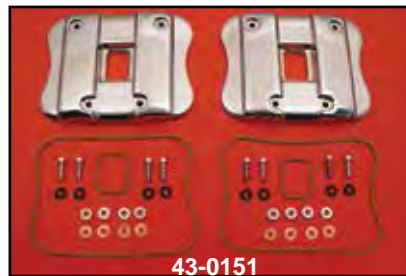

Chrome Rocker Box Covers for 1986-up models.

VT No.	OEM	Item	Finish	Fits
43-0151	17501-86	Top Cover	Smooth	1986-03
10-0566	17551-04	Top Cover	Finned	2004-up
10-0579		Top Cover	Smooth	2004-up
11-0585	17533-90	D-Ring		1986-03



# Hardware Kit



**Stock Style Hardware Kit** contains all the stock engine nuts, bolts, washers and studs for the engine in choice of chrome or cadmium plating. Kit includes primary cover screws, lifter base screws, timing plug, cam cover screws, cylinder base nuts and washers, generator screws, head bolts and washers as required for each application.

Chrome	Cadmium	Fits
	<b>8315 CAD</b>	1957-66 XLH
<b>8316 CHR</b>	<b>8316 CAD</b>	1957-69 XLCH
<b>8317 CHR</b>	<b>8317 CAD</b>	1967-70 XLH, 1970 XLCH
<b>8319 CHR</b>	<b>8319 CAD</b>	1971-73 XLH-XLCH
<b>8320 CHR</b>	<b>8320 CAD</b>	1974-76 XLH-XLCH
<b>8321 CHR</b>	<b>8321 CAD</b>	1977-80 XLH-XLCH
<b>8322 CHR</b>	—	1981-86 XLH

## Gardner and Wescott Allen Sets



**Sportster Polished Chrome Motor Sets** include side covers, generator, rocker box, top motor mount, lifter base and point cover.

VT No.	Fits
<b>37-8092</b>	1991-up Evolution XL
<b>37-2087</b>	1986-up Evolution XL
<b>37-2088</b>	1984 <sup>1</sup> / <sub>2</sub> -85 Iron Head Alternator
<b>37-2089</b>	1977-84 <sup>1</sup> / <sub>2</sub> Sportsters
<b>37-2090</b>	1971-76 Sportsters
<b>37-2091</b>	1957-69 XLCH



**Chrome Allen Screw Sets** fit 2004-up XL's.

VT No.	Fits
<b>37-1201</b>	Primary-Derby
<b>37-1202</b>	Timing Cover
<b>2226-4</b>	Sprocket Cover
<b>37-1204</b>	Tappet Blocks
<b>37-1205</b>	Rocker Box



**Factory Type Studs** for stock applications.

VT No.	OEM	Fits
<b>12-2117</b>	24751-75	1975-up XL Right Front Peg
<b>12-0552</b>	24752-75	1975-85 XL Left Front Foot Peg
<b>12-2111</b>	24811-59A	1965-72 Starter
<b>12-1151</b>	24817-52	1952-81 XL Right Case
<b>8814-15</b>	24819-52	1954-76 XL Oil Pump Set
<b>12-1150</b>	24825-82	1982-up XL Right Case
<b>18-3123</b>	37584-67	1952-70 XL Clutch Hub
<b>12-1186</b>	40018-77	1977-up XL Adjuster Shoe, each
<b>8813-4</b>	45840-48	1949-76 Glide Leg, pair
<b>8826-6</b>	45998-73	1977 up Glide Leg, pair
	72341-48	1973-up FX Leg Stud, pair



- Snap On
- Tight Fit
- Easy Installation

*Wescott*

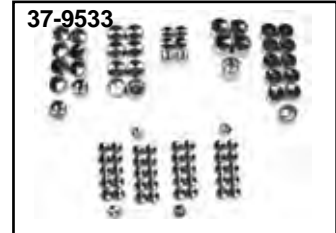

### Chrome Bolt Cap Cover Kit for Sportster

VT No.	Model	Kit Quantity
<b>37-9532</b>	2004-up	77
<b>37-9534</b>	2004-up Engine	63
<b>37-9545</b>	2004-up	109
<b>37-9533</b>	1984-03	74

These new bolt cover kits will make any bike look great and are also for custom builders use. Easy to install these new kits have beautifully designed pieces to cover the raw OE bolt heads on engine, transmission, primary and more, each kit includes detailed instruction for installation on each model as listed, all covers in each kit are individually packed and numbers for identification. Installation has never been easier.



### Show Kits.

Allen	Gold	Year
—	<b>7900-G</b>	1957-64
—	<b>7901-G</b>	1965-70
—	—	1971-73
—	<b>7903-G</b>	1974-76
—	—	1977-84
—	<b>7919-G</b>	1986-90
—	—	1991-2002
<b>1014-P</b>	—	1991-93
—	—	1994-2003



**COLONY**

**Caps Show Bike Kits** in chrome finish.

VT No.	Fits
<b>8517</b>	1984-86 Evo 4 Speed
<b>8518</b>	1985-86 Evo 5 Speed



**Cam and Primary Chrome Screw Sets** include inspection and sprocket screws. By Gardner Wescott.



VT No.	Year
<b>37-8508</b>	1991-up
<b>37-8509</b>	1986-90
<b>37-8510</b>	1977-85
<b>37-8511</b>	1971-76

XL





# Flywheels



**Complete Flywheel Assembly** is shipped complete, assembled and trued with shafts.

VT No.	OEM	Fits	Type
10-1130	23900-57A	1957-76 XL	Motor Shop
10-1010	23900-75	1977-80 XL	S&S
10-1131	As Above	Motor Shop Ready	
10-1132	23900-75B	1981-85 XL	Motor Shop Ready



**Truett & Osborn Flywheel Sets** feature original weight right and left sides.

VT No.	Fits
10-1012	1957-80
10-1030	1981-85

**TRUETT & OSBORN**

## Case Bolts



**Engine Case Bolt Kit** includes the necessary hardware to bolt together the motor cases of the years listed in cad plated finish.

VT No.	Fits
9878-13	1957-76
9879-31	1977-90



**S&S Rods** are heavy duty replacement rod sets included wrist pin bushings, rod races, matched rods, pins, rollers-cages, and nuts, for stock or stroker use. Use "Heavy Duty" or "Supreme" which is recommended for drag strip applications.

Heavy Duty	Supreme	Fits
10-0179	10-0191	1957-81 XL
10-0180	10-0194	1981-85 XL
10-0187	—	1986-99 XL-Evolution 883-1200

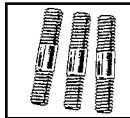

**Rear Engine Case Studs.** Set of 3.

VT No.	OEM	Years
12-1151	24817-52	1952-81
12-1150	24825-82	1982-90



**Chrome Engine Case Allen Bolt Kit** fasten engine case halves. Fit 2004-up.

**VT No. 2217-8**

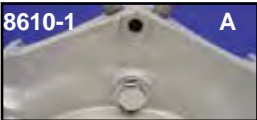

**A. Timing Plug** fits all Sportster timing plug holes and oil tanks.

**VT No. Finish**

8610-1 Chrome

8611-1 Cadmium

**B. Allen Style Plug** use on all 1970-up replaces 720.

9402-1 Chrome

9403-1 Cadmium

37-9206 Chrome by Gardner-Westcott

9960-1 Chrome (Oversize)



**Shovelhead Style Rocker Boxes** for 2014-up Sportster. Cast finish. left.

**VT No. 43-1096**

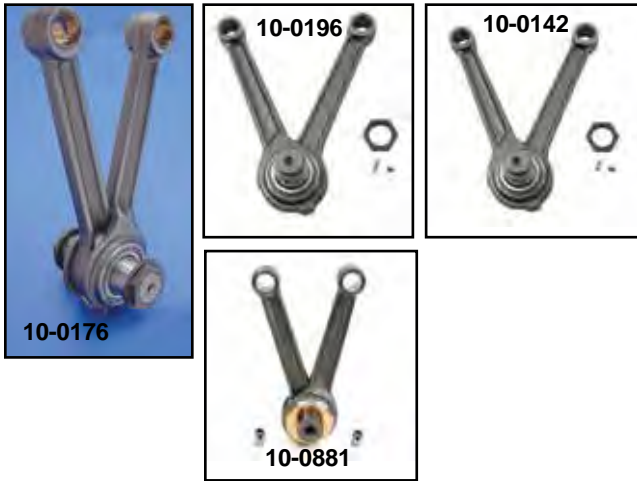

**V-Twin™ Replica Stock Replacement Rod Sets** include new rods, crank pin, nuts, cages and standard rollers which are fitted and assembled. Piston pin bushings are installed and honed for stock wrist pin.

VT No.	OEM	Years
10-0176	24275-57	1957-80
10-0196	24275-80	1981-85
10-0142	24275-86A	1986-99
10-0881		2000-up



**Sifton Crank Pin Kit** includes crank pin, rod races, standard rod rollers, and retainers.

VT No.	Years
10-2572	1954-Early 81
10-2573	Late 1981-86



**Rod Bearing Sets With Set of 3 Cages** fitted with standard size Torrington rollers for connecting rods. The cage material is noted.

VT No.	OEM	Cage	Year
10-0140	24370-52B	Alloy	1952-86
10-2567	Cage Set	Alloy	1952-86
10-2557	24354-87A	Steel	1987-99



**Crank Pin Lock Kits** include 2 nuts, 2 locks and mount screws. Nuts and locks are also available separately. Fits 1954-81.

VT No. 10-0183



**Alloy Cage Connecting Rod Roller Sets** for 1957-99 XL's.

Size	1957-Early 86
Standard	10-0160
.0002 oversize	10-0161
.0004 oversize	10-0162
.0006 oversize	10-0163
.0008 oversize	10-0164

# Rod Assembly

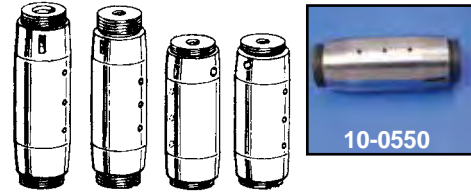

# Crank Pin

**Crank Pins** are made of 8620 steel with .062 heat treated penetration. \*Note: One Hole.

Years	OEM	Jims 3 Hole	Eastern 3-Hole	V-Twin 2-Hole	V-Twin 3-Hole
1954-81	23960-54	10-8359	10-0550	—	10-0552
L1981-99	23960-80A	10-8361	10-0192*	10-1210	—



**Connecting Rod Race Sets** made from 52100 steel and hardened. Fits 1957-85.

VT No.	Size
10-0137	STD
10-0827	.010 Oversize



**Wrist Pin Bushings** are available in bronze replica type or Sifton Ampco 45 for all XL's. Replica type sold in pairs. Sifton type sold each.

Size	VT No.	Type
STD	10-0760	Replica
STD	10-0766	Sifton
.005	10-0762	Replica
.010	10-0763	Replica

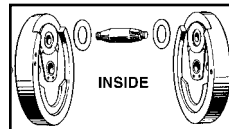

# Crank Pin Flywheel Washer



**Crank Pin Flywheel Washers** sold in pairs.

Inside	OEM	Type	Fits	Size
10-1150	6506	Bronze	L1979-86	Standard
10-1149	6506B	Bronze	L1979-86	.005 Oversize
10-1167	6508	Bronze	1987-99	Standard
10-1151	23972-57	Steel	1957-71	.072
10-1273	23972-57A	Bronze	1957-71	.073 with fly cut
10-1164	23972-72	Bronze	1972-E79	.062
10-1168	23972-72	Bronze	1972-E79	.005 Oversize
10-1285	23972-72A	Bronze	1972-E79	.060 with fly cut



**Crank Pin Nut Sets.**

Eastern	Jims	OEM	Fits
12-0522	12-0604	23967-54A	1954-Early 81
12-0565	12-0600	23901-81	Late 1981-99



**Crank Pin Nut Lock Plate.** Fits 1957-81.  
VT No. 17-0914

**100 Quantity Pack Only.**

Size	Long	OEM	Short	OEM
Standard	12-4561	9150A		9441A
.0002	12-4562	9152A	12-4554	9442A
.0004		9154A	12-4555	9443A
.0006	12-4564	9156A		9444A
.0008	12-4565	9158A		9445A
.001	12-4566	9160A	12-4558	9446A





# Pinion and Shaft Hardware

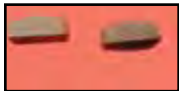

**Sprocket and Pinion Shaft Key.** Sold in 10 pack. Replaces 23985-12. Fits 1954-81.  
**VT No. 12-0200**



**Nut, Sprocket and Pinion Shaft Taper End.** Sold as a 5 pack.

Eastern	OEM	Fits
12-0531	8011	1954-80
12-0516	23902-81	1981-85



**Lock Plate, Sprocket and Pinion Shaft.**

Sold in 10 pack.

VT No.	OEM	Fits
17-0913	24016-36A	1957-80 XL
17-0917	24018-72	1972-81 Big Twin



**Nut, Pinion Shaft Gear End.**

Eastern	OEM	Fits
12-0536	7913	1977-90
12-0577	7916A	1991-up



**Pinion Bearing Sets** for 1954-76 XL right side includes rollers and cages. Washers and snap rings included when required except where \*noted.

VT No.	Item
10-2536	Kit
12-0403	Cage
<b>Bearing Only</b>	
12-0321	1977-86
10-2531	1977-84 Race for above

## 1987-up Pinion Bearings.

VT No.	OEM	Item
10-8530	8881	Outer Race
12-0946	11177	Retaining Ring
10-1279	24647-87	Blue Bearing Assembly
10-1280	24650-87	Red Bearing Assembly
10-1283	24658-87	Inner Ring
10-1281	24659-87	White/Grey Bearing Assembly
10-1282	24660-87	Green Bearing Assembly



10-1281



**Case Race** machined and ground to factory specifications.



## Pinion Right Side Case Race

Jims	Eastern	Size	Year
10-0252	10-0200	Standard	1954-76
—	10-0201	.002	1954-76
10-0253	10-0202	.005	1954-76
10-0254	10-0203	.010	.010 1954-76
—	12-0250	10 pack	1954-76 Set Screw
—	10-0755	Standard	1986
—	10-8530	Standard	1987-up
—	10-8531	.002	1987-up
—	10-8534	.005	1987-up

10-0404



**Pinion Shafts.** Precision ground for fit.

Jims	Eastern	VT No.	Item	Year	OEM
10-8330	10-0404	—	Pinion Shaft	1957-76	24005-57
—	10-0405	—	With Race	1977-E81	24008-75A
10-8354	10-0399	—	With Race	L1981-85	24005-80
—	10-2531	—	Race Only	1977-86	24009-77
—	—	12-0321	Bearing Only	1977-86	24648-77



12-1394

**Pinion Shaft Gears.** White is largest, brown is the smallest. \*Note: Motor Shop Brand.

Year	OEM
1952-76	1991-99
24011-37	—
Standard 12-1394*	—
Standard 12-1473	—
White	12-1469
Red	12-1468
Blue	12-1467
Green	12-1470



10-0711

**XL Cam Gear Bushing Kits** include bushings for #1, 2, 3 and 4. Cams. standard size. Fits 1957-90. **VT No. 10-0711**



10-8265



10-8266



10-8267

## Cam Bushing Kit.

VT No.	Year
10-8265	1986-90
10-8266	1977-85
10-8267	1957-77
10-8273	1991-96



10-8273



## Genuine Torrington Bearing Set.

4 piece set for XLS 1957-85.

VT No.	Brand	U/M
10-8285	V-Twin	4
10-8283	Torrington	4
12-0425	V-Twin	Each



**Cam Thrust Washers** for 1958-up.

**VT No. 17-0921**



## Motor Shop Cam Cover

**Bushing Service** will install new bushings in right side case and cam cover for 1957-up XL models.

**VT No. 60-0131**



# Pinion Parts

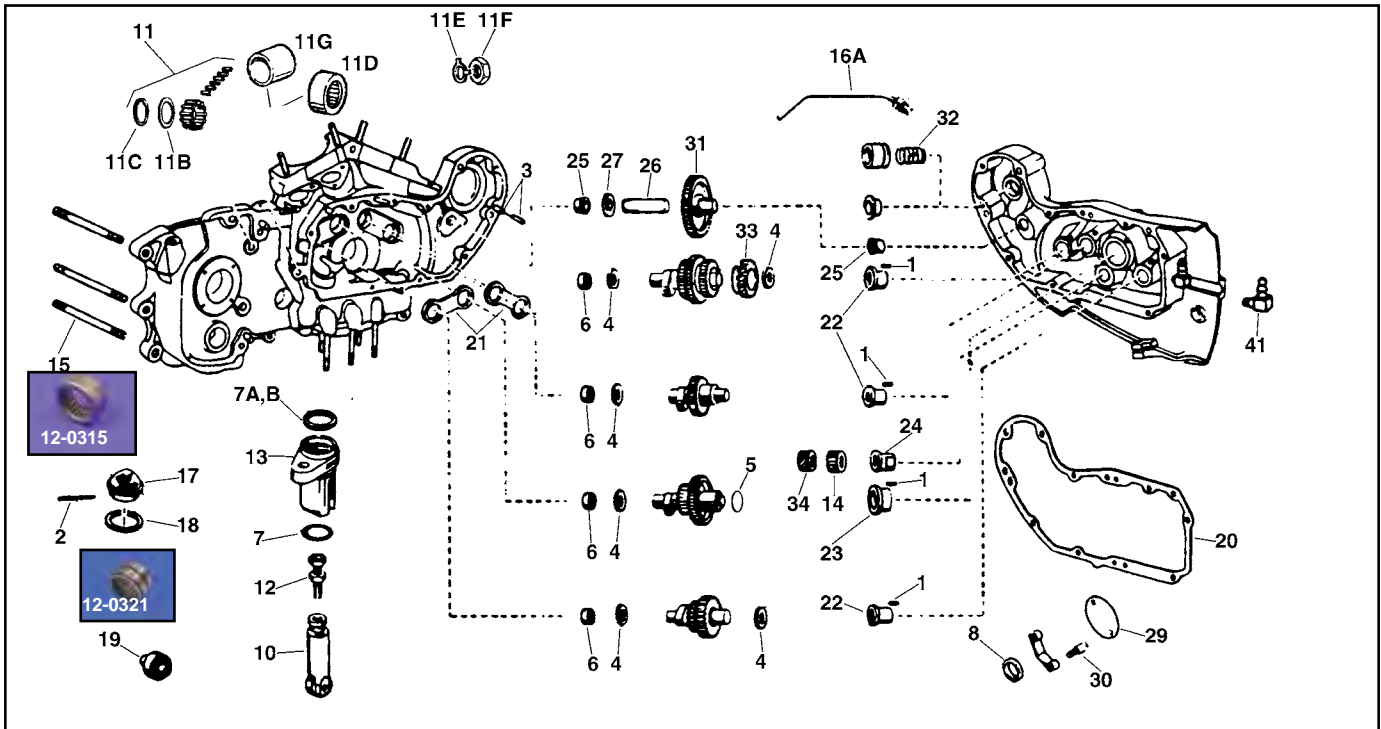

VT No.	#	OEM	Description	Year
12-1184	1	275	Pin Bushing	1954-90
12-1173	2	333	Pin, Strainer	1952-76
12-1172	3	375	Pin, Casing	1957-76
12-0705	4	6769	Shims Cams .007	1952-85
12-0706		6770	As Above .005	1952-85
12-0716		6771	As Above .015	1952-85
12-0717	5	6773	Shim #2 Cam .005	1952-85
12-0718		6775	As Above .010	1952-85
12-1258		6778	As Above .015	1952-85
12-0315	6	9057	Bearing Cam	1952-90
10-2552	6	25598-91	Bushing Cam	1991-up
14-0500	7	11100	O-Ring Block	1952-85
14-0501	7A	11101	O-Ring Pushrod	1979-85
15-0116	7B	17955-36	Cork, Pushrod (12)	1952-E79
14-0100	8	11124	Seal, Cam Cover	1957-up
10-0502	10	18508-52B	Cam Follower Standard	1957-86
10-0503		—	Cam Follower .005 Oversize	1957-86
10-2536	11	—	Pinion Bearing Kit	1954-76
10-1154	11B	24692-54	Washer	1954-76
12-0913	11C	24701-54	Ret. Ring	1954-76
12-0321	11D	24648-77	Bearing	1977-84
10-2531	11G	24009-77	Race	1977-84
17-0918	11E	7044A	Lock	1979-up
12-0536	11F	7913	Nut	1977-90
12-0577	11F	7916A	Nut	1991-up
10-0517	12	18554-57	Tappet Adjusters	1957-85
10-0522	13	18607-57A	Tappet Block (Jims)	1957-85
10-0182	13	18607-57A	Tappet Block Set	1957-85
12-1394	14	24011-37	Pinion Gear	1957-76
12-1473	14	24011-37	Pinion Gear	1957-76
Note:	14	24059-74	Pinion Gear See Chart	1977-up
12-1151	15	24817-52	Stud (3) Casing	1954-81
12-1150	15	24825-82	Stud (3) Casing	1982-up
40-0121	16A	24912-52A	Breather Pipe Chrome	1954-82
12-1512	17	24975-37	Oil Stainer	1954-72
12-1511	19	25075-55	Breather Valve	1952-76
15-0121	20	25224-52	Gasket, Cam Cover	1952-81
15-0124		25263-81	Gasket, Cam Cover	1981-85
15-0245		25263-86	Gasket, Cam Cover	1986-90
17-0921	21	25551-58	Cam Thrust Plate	1958-90
10-0709	22	25586-37	Bushing Cam	1952-up
10-2540	22	As Above	.005 Oversize	1952-up
10-0710	23	25588-57	Bushing #2 Cam	1952-90
10-2541	23	As Above	.005 Oversize	1952-90

VT No.	#	OEM	Description	Year
10-8538	23	25588-91	Bushing #2 Cam	1991-up
10-0712	24	25593-57	Bushing Pinion	1957-76
10-2544		As Above	.005 Oversize	1957-76
10-0713	24	25593-74	Bushing Pinion	1977-up
10-0715	25	25597-57	Bushing Idler	1952-85
10-2546	25	As Above	.005 Oversize	1952-85
10-2499	26	25787-57	Stud, Idler Gear	1957-85
15-0217	27	25811-11	Washer, Idler Gear	1957-85
10-0197	26 and 27	—	Idler Stud Kit	1957-85
N/A	29	32591-70	Gasket, 2 Hole	1970-79
15-0156		32591-80	Gasket, 4 Hole	1980-95
32-0051	30	32601-78	Stud, Ignition	1972-79
12-1451	31	25776-57	Idler Gear	1957-84
13-0106	32	25287-37	Breather Spring	1957-62
12-1400	33	25517-71	Tach Drive Gear	1971-80
12-1290	32A	25265-63	Breather Deflector	1963-78
12-0421	34	26818-37	Oil Pump Drive Gear	1957-76
12-1380	34	26318-75	Oil Pump Drive Gear	1977-87
12-1377	34	26318-88A	Oil Pump Drive Gear	1988-up
17-0519	41	62375-57	Vent Hose Fitting	1970-up
12-0215	42	11219	Oil Pump Drive Key	1988-99
12-0213	43	11204	Rear Intake Key	1980-85

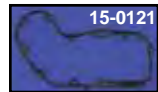

### 15-0121 Cam Cover Gaskets.

GB No.	James	OEM	Fits
15-0214	15-0214	24978-57	1957-81 Oil Strainer
15-0564	—	Pair	1954-Early 81 Cam Cover
15-0121	15-1078	25224-52A	1954-Early 81 Cam Cover
15-0124	15-0931	25263-81	1982-85 Cam Cover
15-0245	15-0932	25263-86	1986-90 Cam Cover
—	15-1255	As Above	With Silicone Bead
15-0308	15-1256	As Above	1991-99 Cam Cover With Silicone Bead
—	15-0933	25263-90A	2000-up Cam Cover
15-0385	15-1223	25263-00	2000-up Cam Cover w/Bead



**Quick Change Cam Gear Gasket and Seal Kit** fits XL and Evolution motors, includes both cork and quad seals for pushrods to fit all year range.

GB No.	Year	GB No.	Year
15-0752	1957-81	15-0755	1991-99
15-0753	1982-85	15-1265	2000-03
15-0754	1986-90	15-1266	2004-up

### Cam Cover Screws for Sportster

Chrome Acorn	Chrome Allen	Cadmium Stock	Chrome Stock	Year
—	—	8895-9	8894-9	1954-70
—	8783-8	2062-8	2061-8	1971-84
8865-11	9751-11	—	—	1986-2003
—	9751-11T	—	—	1986-2003
—	37-1202	—	—	2004-up
—	2222-11	—	—	2004-up





# Sprocket Shaft



**12-0322** Left Crankcase Bearing by Timken. Factory assembled with correct spacer for proper end play.  
**VT No. OEM Fits**  
**12-0322** 24729-52 1954-76  
**12-0323** 24729-74 1977-2003  
**12-0768** 24605-07 2004-up  
**Left Crankcase Bearing and Race**

Only. Two Required. Order snap ring and the correct spacer separately. Replaces 48302-85. Fits 1991-96.

VT No.	Timken	Fits
12-0430	12-0322	1954-76
12-0431	12-0323	1977-03
12-0768		2004-up



**Motor Sprocket Nuts.**  
**VT No. OEM Years Item**  
**12-0502** 8025 1957-69 Nut  
**12-0505** 40387-70 1970-88 Nut  
**12-0149** 7652 1989-up Nut  
**10-0460** 40240-89 1989-up Spacer

## Sprocket Shaft Hardware



Timken Bearing Spacer Shims available in 5 packs. 1977-up Sportster.

VT No.	OEM	Size	VT No.	OEM	Size
10-1260	9142	.100	10-1265	9147	.110
10-1261	9143	.102	10-1266	9148	.112
10-1262	9144	.104	10-1267	9149	.114
10-1263	9145	.106	10-1268	9155	.098
10-1264	9146	.108	12-0983	9119A	Retaining Ring, 10 pack



Sprocket Shafts fit as listed. Machined and hardened to factory specifications.

Jims	Eastern	Years	OEM
10-8319	10-0420	1957-76	24000-57
10-8320	10-0421	1977-Early 81	24000-75
10-8321	10-0434	Late1981-85	24000-80

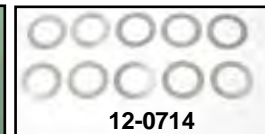
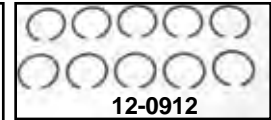
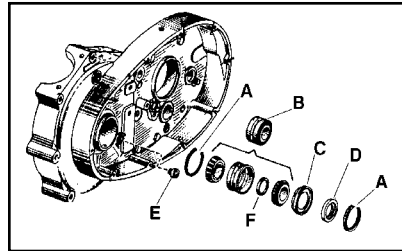

### Sprocket Shaft Hardware.

VT No.	#	OEM	Year	Item
12-0912	A	24701-52	1952-76	Ret Ring
12-0322	B	24729-52	1952-76	Timken Bearing
12-0323	B	24729-74	1977-up	Timken Bearing
12-0989	ACD	Kit	1952-76	Spacer Kit
12-0990	ACD	Kit	1977-90	Spacer Kit
10-0470	C	24781-54	1954-76	Spacer, each
10-0460	C	40240-89	1991-01	Spacer
14-0118	D	35151-52A	1954-E76	Seal, 5 pack
14-0119	D	35151-74	1977-up	Seal, 5 pack
12-1511	E	25075-55	1957-76	Oil Transfer Valve
12-0713	F		1952-76	Shim .003
12-0714	F		1977-up	Shim .003



## Sifton Cams for XLH-XLCH

Sifton Cam Set features PB + configuration, 4 piece set.

VT No.	Years	Timing	Duration @.053	Duration @.020	Max Lift	TDC	Fits
10-0662	1971-80	43/31	254	298	.410	.208	Bolt In Street Cam For More Power.No Head Work Required and Cam be used with stock springs

Sifton 205 Minus Titan Cam Set. They will produce excellent results in well aspirated or very large motors. Timing is taken at .053 of the lift off the low spot on the heel of the cam at the tappets. Tappet clearance is zero to .002.

VT No.	Years	Titan Cam	Degrees @ .053		Valve Lift Total	Spring Info		Free Travel
			Opens	Closes		TDC	Travel To Coli Bind	
10-0666	1981-84	Exhaust	52°	25°	.436	.194	.475	.500

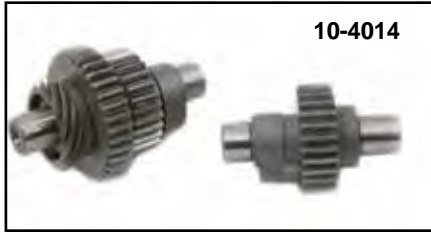

HIGH PERFORMANCE AND DRAGSTER CAMS								
VT No.	Year	Grind	Timing	Duration @ .053	Duration @ .020	Max Lift	TDC Lift	Fits
10-4010 10-4014 10-4020* 10-4025	1957-70 1971-80 1981-84 1984-85	PB+4/1 PB+4/1 PB+4/1 w/alternator	34/40 43/31	258 254	298 298	.410 .410	.200 .192	4/1 Kit consists of exhaust cams only for use with Stock P intakes. Bolt-in power for Sportsters with no head work, 2 piece set.
10-4040 10-4045 10-4050*	1957-70 1971-80 1981-84 1984-85	PB+ w/alternator	34/40 43/31	254 254	298 298	.410 .410	.208 .208	Fits Sportster with P or Q cams, bolt-in more power with great street grind. No head work needed, more power through RPM range with stock springs. To 7000 RPM.
10-4075 10-4080 10-4085* 10-4090	1957-70 1971-80 1981-84 1984-85	Y w/alternator	35/47 53/29	262 262	310 310	.425 .425	.206 .182	Street 900/1000 Biggest cam available for no head work installation. Some 1982 engines may require spring spacing. Stock springs are OK. Great mid and upper end power.
10-4105 10-4110 10-4115* 10-4120	1957-70 1971-80 1981-84 1984-85	R5 w/alternator	33/41 43/31	254 254	306 306	.445 .445	.209 .200	Street Drags modified 900/1000 motors and small strokers. Big boost in torque over stock cams (2000/7500 RPM). Stock springs are OK, but head set up required.
10-4140 10-4145* 10-4150	1957-70 1971-80 1981-84 1984-85	X w/alternator	35/55 57/33	270 270	314 314	.450 .450	.210 .206	Street Drags for stroker motors to 76". More mid range and upper end power. Lower lift results in easier installation in 1977 and later engines with extended pinion bearing housing. Stock springs recommended.

Note: 1981-84 Cam Gear Kit differs from 1971-80 only on the #4 Cam which does not have a tachometer drive gear. Tachometer Gear 25517-71 is available separately as VT No. 12-1400

1986-up 883-1100-1200 XL ENGINE CAM KITS								
—	—	Stock	02/41 41/02	223 223	270 270	.458 .458	.094 .094	Listed for comparison Note: 1985-87 exhaust cam lift is .414
10-8120 10-8125 10-8122	1986-90 1991-99 2000-up	V2 N2	16/44 46/18	240 244	290 290	.465 .440	.180 .155	Bolt-in cams for Stock 883, 1100 or 1200. More duration and lift means extra power thru RPM range. Stock springs and hydraulic lifters recommended. 2000 to 6000 RPM.
10-8140 10-8145 10-8123	1986-90 1991-99 2000-up	V4 N4	30/46 52/24	256 256	296 296	.490 .490	.216 .189	Street/Drags: Stock or modified 883/1100/1200. Slightly higher idle speed but stock springs and hydraulic lifters recommended. RPM range: 2500 to 6500.
10-8180 10-8185 10-8124	1986-90 1991-99 2000-up	V8 N8	32/44 56/28	256 264	296 302	.490 .500	.226 .212	Modified 1100-1200, stroked 883's with stock springs and hydraulic lifters. Great mid-range power: 2000-6000 RPM.
10-8160 10-8165 10-8128	1986-90 1991-99 2000-up	V6 N6	34/50 56/28	264 264	302 302	.500 .500	.241 .212	Modified 1200's to 80" and/or high comp. pistons. Same intake as N8 but more exhaust duration. Stock springs and hydraulic lifters recommended. RPM range: 2500-6500.



Cam Covers for XL 1971-up							
Year	Chrome Kick Starter & Electric	Chrome Kick Starter Only	Chrome Electric Only	Polished Kick Starter & Electric	Polished Kick Starter Only	Polished Electric Only	Cam and Primary Screw Sets
1971-76	10-0377	10-0572		10-0559	10-0591		37-8511
1977-80	10-0378	10-0573		10-0558	10-0592		37-8510
1981-85		10-0379		10-0560			37-8510
1986-90			10-0791	10-0857		10-0857	37-8509
1991-03			10-0554			10-0555	37-8508
2004-up			10-0563				37-1202



Gloss Black Covers for XL. Cam Cover for 2004-up. Order cover separately fits 2004-up XL racing models.  
**VT No. Item**  
 10-1431 Cam Cover  
 43-0387 Rocker Box  
 43-0390 Sprocket Cover

XL





# Tappet Kits and Pushrod Set



**Stock Solid Alloy Tappet Kit** includes tappets with adjuster screws, pushrods and tappet blocks. Fits 1957-84.

**VT No. 11-0588**



**Sifton Quick Install Pushrod Sets** are designed to be installed without removal of rocker boxes or cylinder heads. Precision made from 4130 chromoly tubing. Fit 1991-03.

**VT No. 11-9544**



**Sifton Pushrod Sets** are constructed of aluminum alloy with heat treated steel ends. Fits 1957-85.

**Sifton Colony**  
**11-9529 7123-4**



**Solid Pushrod Kits** include four alloy pushrods and adapters to convert stock hydraulic tappets to solid. Fits 1986-up 883-1200 Sportster.

VT No.	Years
11-9547	1986-90
11-9538	1991-03
11-1964	2004-up

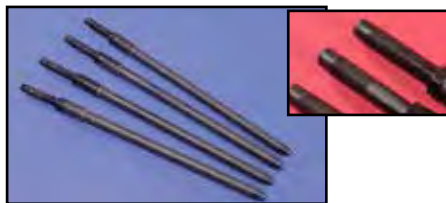

**Sifton Taper-Rod Pushrod Set** is constructed of chromoly extruded tapered tubing fits 1991-up XL's. Order Andrews Cam Set separately.

VT No.	Item	Year
11-9544	Pushrod Set	1991-03
10-8160*	Cam Set	1986-90
10-8165*	Cam Set	1991-99
10-8128*	Cam Set	2000-up

\***Note:** Modified 1200's to 80" and/or high compression pistons. Stock springs and hydraulic tappets recommended. RPM range: 2500-6500.



**Sifton Tappet Kits** include roller tappets and are fully adjustable, pushrod set included with hydraulic or solid type tappets.

VT No.	Year	Type
10-0821	1957-85	Solid
10-0823	1986-90	Solid
10-0822	1986-90	Hydraulic
10-0817	1991-99	Hydraulic
10-0818	2000-03	Hydraulic



**Tapered Adjustable Pushrods** are manufactured from 4130 steel with hardened adjusters and ball ends. Designed to be installed without removing gas tank or camshaft cover. Set of four for solid or hydraulic tappets.

VT No.	Year
11-9703	1984-90
11-0574*	1991-03

\***Note:** Requires the use of VT No. 11-0935 pushrod covers.



**Andrews Pushrods** available in chromoly steel or aluminum, adjustable or fixed type as noted. All are stock diameter, so there is no cover interference.

VT No.	Fits	Style
11-9867	1986-90	Adjustable Aluminum
11-9868	1986-90	Adjustable Chromoly
11-9869	1991-03	Fixed Aluminum
11-9870	1991-03	Fixed Chromoly
11-9952	1991-03	Adjustable Aluminum
11-9953	1991-03	Adjustable Chromoly
11-9874	1957-85	Fixed Chromoly
11-9876	1957-85	Fixed Aluminum



**Crane Adjustable Pushrods** made from 3/8" aircraft grade seamless 4130 chromoly steel tubing and heat treated to 128,000 psi tensile strength for a stronger and lighter than stock pushrod. Style adjuster helps minimize the effects of poor pushrod geometry found in stock pushrods, 3/8" diameter eliminates pushrod "rub" completely. Set contains 2 intake and exhaust pushrods. These are not time saver type. 1991-03.

**VT No. 7132-65**



**S&S Hydraulic .612 Tappet Limited Travel Kit.** Designed to maximize the efficiency of the stock hydraulic tappets. Kit consists of 4 machined heat treated and ground spacers when installed in the tappets reduce the travel of the hydraulic unit in high rpm situations thereby eliminating potential damage to the engine due to high RPM valve float. Fits 2003-up.

**VT No. 10-8532**



11-0905



11-0933

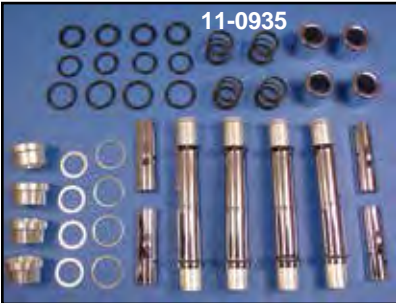

11-0935



11-1205



11-0941

**Chrome Pushrod Cover Kits** include all pieces and seals.

VT No.	Years
11-0905	1957-Early79
11-0937	Late1979-85
11-0933	1985-89
11-0935	1990-2003
11-1205	2004-up
11-0930	Adapts 11-0933 to 1990-up
11-0941	1990-2003 one piece design
11-1965	2004-up one piece design

**Pushrod Cover Components** fit 1957-85.

Colony	V-Twin	Item	Fits
7507-20	11-0929	Upper Kit	1957-85
9887-20	—	Upper Kit	1986-90
—	11-0916	Clip Only (4 piece)	1957-85
—	11-0932	Clip Only (4 piece)	1986-89
7808-4	—	Inner Tube	1957-78
—	11-0908	Inner Tube	1979-85
7822-12	11-0923	Lower	1957-78
—	11-0936	Lower	1979-85

# Pushrod Cover Set



11-0944

**Billet Pushrod Cover and Mount Base Set** allows adjustable covers to be used on 1991-2003.

VT No.	Item
11-0944	Complete Kit
14-4171	Lifter Base Seal Kit



37-9078



37-9079



11-1073

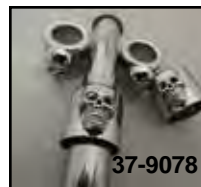

37-9078



37-9078

**Pushrod Cover Cups** feature die-cast construction in chrome or gold, set of four.

VT No.	Item
37-9078	Chrome Skull
37-9079	Gold Skull
11-1073	Brass Hex



Quad

Cork

O-Ring



14-0971

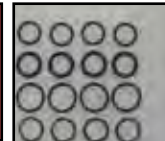

14-0951

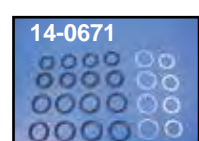

14-0671

**Pushrod Cover Cork-Seal Kits** include enough pieces to seal 4 complete pushrod covers on years listed. Available in cork, OEM-type Quad, or Buna-N machined rubber seals.

James	GB No.	Type	Fits
14-0668	15-0626	Cork	1957-79
14-0670	14-0953	Quad	1979-84
—	14-0971	Rubber	1957-79, Blue Silicone
14-0671	14-0951	Rubber	1986-89
14-0672	14-0952	Rubber	1991-up XL 883 1200 Evolution
—	8729-12	Rubber	1957-79 (Colony)

**Pushrod Tube Seals.**

VT No.	OEM	Type	Years
14-0501	11101	Lower	1979-85
14-0512	11132	Middle	1979-90
14-0550	11145	Lower	1986-90
14-0532	11157	Upper	1984-90
14-0912	11190	Upper	1991-up
14-0935	17944-89	Lower	1991-03





# Rocker Arm



11-9511



11-9512

Rocker Arms include bushings installed.

VT No.	OEM	Type	Brand
<b>1986-up Evolution</b>			
11-9511	17360-83	As Above.	Sifton
11-9512	17375-83	As Above	Sifton
<b>1957-85</b>			
11-0522	17394-57A	F. Ex	VT
11-0523	17395-57A	R. Ex	VT
11-0524	17396-57A	F. In	VT
11-0525	17397-57A	R. In	VT
11-1066	Set with shafts		VT



## Rocker Arm Shaft.

VT No.	OEM	U/M	Brand
<b>Fits 1957-85</b>			
11-0518	17435-57A	Each	Sifton
11-1068	17435-57A	Set	Sifton
11-0541	As Above	Each	Jims
<b>Fits 1986-up</b>			
11-0571	17611-83	Set of 4	Sifton
11-0576	17611-83	Set of 4	Jims
11-0814	17611-83	Each	
		.005 Oversize	Sifton



**Rocker Arm and Shaft Kit** by Sifton fits 1986-up models. Includes (2) 17375-83 rocker arm, (2) 17360-83 rocker arm and (4) 17611-83 shafts. **VT No. 11-0572**



**Rocker Box** available with polished or chrome finish for Iron Head Sportster. Fits 1957-85 XL.

VT No.	Finish	Note
11-0677	Chrome Set	Bare
11-0855	Polish Set	Bare
11-0078	Chrome Set	Assembled
11-0867	Polished Set	Assembled



**Sifton Rocker Arm Seals** are machined of nylon to replace rubber O-rings on 1957-85 models. **VT No. 14-0148**

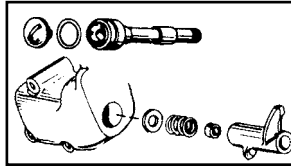

## Rocker Arm Spacer and Shims.

VT No.	OEM	Item	Qty
12-2116	17451-57	Spacer	10 pack
13-0100	17483-57	Springs	10 pack
14-0501	11101	O-Ring	10 pack



14-0501



**Rocker Arm Shims** fit 1957-85.

VT No.	Size
12-0704	.005
12-0710	.007
12-0715	.015



**Rocker Arm Bushings** replace 17428-57. Use on 1957-up models. Eight pieces.

VT No.	Type
10-0700	Stock Split type
10-2106	As Above, Sifton



**Sifton Rocker Arm and Shaft Kit** fits 1957-84 XL Iron Head models and includes four rocker arms with bushings installed, four shafts, shims, spacers, chrome replica end caps and nuts.

**VT No. 11-0820**



7142-4

## Chrome Rocker Shaft End Plugs.

Installation or removal is much easier than original slotted part. Packaged four per set.

VT No.	Fits
7142-4	1971-84
7143-4	1957-70



8224-8

**Rocker Shaft End Cap Kit** for Sportster as replica type with hex caps for left side.

VT No.	Year	Finish	Nut Type
2019-8*	1957-84	Chrome	Slot
2020-8*	1957-84	Cadmium	Slot
8222-8	1957-70	Chrome	Slot
8223-8	1957-70	Cadmium	Slot
8224-8	1971-84	Chrome	Allen
8225-8	1971-84	Cadmium	Allen

\*Note: Feature 1/2 x 20 thread to be used on later type rocker shafts.



## Chrome Allen Rocker Shaft Plugs.

Set of 4. Fit 1971-84 XL models. Includes sockets and cups.

**VT No. 37-0025**



**Rocker Box Bolts** for both heads, includes washers.

Available in stock hex type, acorn or allen.

Colony	VT No.	Year	Finish	Type
	9829-28	—	1957-76 Chrome	Hex
	9830-28	—	1957-76 Cadmium	Hex
	7136-14	—	1957-76 Chrome	Acorn
	8789-28	—	1957-76 Chrome	Allen
	9831-28	37-9395	1977-85 Chrome	Hex
	9831-28T		1977-85 Chrome	Hex
	9832-28	—	1977-85 Cadmium	Hex
	8790-28	—	1977-85 Chrome	Allen



8400-8



8730-8

**Rocker Shaft End Nut Kit** includes four acorn or cap style nuts and washers for replacing

VT No.	#	Type	Finish
8400-8	A	Cap	Chrome
8401-8	A	Cap	Cadmium
8730-8	B	Acorn	Chrome
12-1193	B	Washers	Zinc



**Chrome Rocker Shaft End Caps** provide ease of installation with ample clearance between gas tank.

**VT No. 8614-4**



**Lightning Tappet Assemblies.**  
Complete units precision machined and drilled for early motors. Holes allow better lubrication in valve train. Screws included. Fits 1957-85.

VT No.	Size
10-0514	Standard
10-0515	.005
10-0527	.010

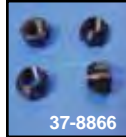
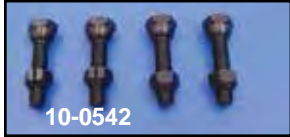

**Tappet Adjusting Screws and Nuts.**

VT No.	Qty	Year	Item
10-0542	Kit	1957-85	
10-0517	4 pack	1957-85	Screw
12-0523	10 pack	1936-52	Split Nuts
8780-4	4 pack	1936-52	Split Nuts



**Replacement Nuts** fit each brand of pushrods or tappets.

8780-4	Colony	5/16 - 24	4 pack
37-8866	V-Twin	5/16 - 32	4 pack
12-0524	Eastern	5/32 - 32	10 pack



**Solid Tappet**



**Big Axle Standard**

**Solid Tappet Assemblies** include roller assembly installed. Jims does not include adjuster screws or nuts where necessary. Jims available with Big Axle Roller Assembly. Fit 1957-85.

Jims	Eastern	Size
10-0632	10-0502	Standard
10-0633	10-0503	.005
—	10-0524	.010
—	10-0451	.015
—	10-0452	.020



**Tappet Roller Repair Kit** includes 4 pins and 4 roller assemblies for 1957-85 XL.

VT No.	Brand
10-0520	V-Twin
12-1179	Pins Only, 10 pack
10-0934	Big Axle

# Tappet Assembly for 1957-85

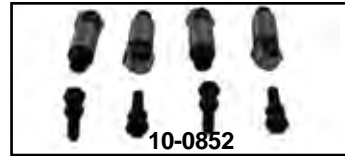

**Sifton Solid Tappet Assembly Sets of 4**, feature centrifugal surface fine grinding and max-axle precision fit rollers and pins. Solid units include adjuster screws & lock nuts. Fit 1957-85.

VT No.	Size
10-0784*	Standard *Note: Does not include adjuster screw and nuts.
10-0852	Standard
10-0774	.005
10-0775	.010



**Solid Lifter Kit** includes four standard tappets with adjusters and four lifter blocks.  
**VT No. 10-0474**

## 1986-up



**Jims Big Axle Tappet Assemblies** include roller assembly installed. Sold each.

VT No.	Size	Fits/Type
1986-90		
10-0657	Standard	Hydro Solid
10-0658	.002	Hydro Solid
1991-99		
10-8276	Standard	Power Glide
10-1803	Standard	Hydro Solid
10-8282	.005	Power Glide
2000-up		
10-1806	Standard	Power Glide
10-0568	Standard	Power Glide II
10-0571	.005	Power Glide II
10-1811	.010	Power Glide II
10-0569	Standard	Hydro Solid

**V-Twin Replacement Tappets** for 1991-up models.

VT No.	Size	U/M
Fits 1991-99		
10-8277	Standard	Each
Fits 2000-up		
10-0820	Standard	Each
10-0824	Standard	Set of 4



**11-9544**



**Evolution Solid Tappets** can only be used with adjustable pushrods. Jims brand sold each. Sifton™ sold in set of 4.

Jims	Sifton™	Size	Years/Fits
10-0636	10-8256	Standard	1986-90
10-0637	10-8257	.005	As Above
—	10-8258	.010	As Above
10-8370	10-8376	Standard	1991-up

**Pushrod Sets for Above.**  
11-9544 1991-03



**Tappet Roller Repair Kit** includes 4 pins and 4 roller assemblies.

VT No.	Year/Model	Brand
10-2534	1986-99 Evolution XL	V-Twin
10-0529	1986-99 Evolution XL	Crane



**Evolution Hy-Rev™ Hydraulic** by V-Thunder features a unique anti-pump up race retainer, designed to replace the normal clip so as to precisely limit travel of the plunger during operation, this allows the valve train to perform more like a mechanical stem allowing higher RPM operation with quiet and precision of hydraulics. Fits 1991-99. Standard size.

VT No.	U/M
10-8280	Each
10-8281	4



**V-Thunder Tappet Set of 4.**  
**VT No. 10-7391**



**Crane Hydraulic Roller Tappet** provides improved RPM capability, superior reliability and quieter operation. Features include use of a precision, hardened ball-type valve to provide superior sealing and lash control. A rotating check ball prevents localized wear and pitting. Fits 1999-up. **VT No. 10-2200**





# Replica Valve



Model and Year	Type	OEM	Sifton™ Nitrate Steel	Sifton™ Steel	Sifton™ Nitrate Steel	V-Twin™ Chrome Steel	V-Twin™ Stainless Steel Nitrate
Ironhead Sportster 1958-69	Intake	18070-58					
	Exhaust	18080-58A	11-1107		11-0617	11-0631	
Ironhead Sportster 1970-85	Intake	18070-70	11-1106		11-0609	11-0628	
	Exhaust	18080-58A	11-1107		11-0617	11-0631	
Ironhead "R"	Intake 1 <sup>5</sup> / <sub>16</sub> "	18070-70R		11-0665			
1970-85	Exhaust 1 <sup>3</sup> / <sub>4</sub> "	18080-70R		11-0676	11-0618		11-0623
<b>Note:</b> All XL Valves with an "R" after OEM part number denote racing stem lengths, they are .080" longer than the stock valves. All "R" type valves have a tulip shape head for maximum flow. Valve face diameters are also larger which require a larger seat ground in the head.							
Evolution 883cc 1986-2003	Intake	18031-86	11-1109		11-0671		
	Exhaust	18030-86					
Evolution 1100-1200 1987-2003	Intake	18023-87	11-1111		11-0667		
	Exhaust	18024-87					

# Tappet Base



Tappet Block for 1957-84 in polished finish.

VT No.	OEM	Brand
10-0522	18607-57	Jims, each
10-0182	18607-57	V-Twin, 4 Piece Set
10-0540	18607-57	Sifton Set
8782-4	Screws	Chrome Set, Allen
9846-4	Screws	Cadmium Hex Bolt Set

Chrome Tappet Base Cover is die cast one piece covering the area from the pushrod tube base to the cam cover. Fits 1991-2003.

VT No. 42-0447



Chrome Tappet Cover fit XL models, 2004-up.

VT No.	Item
10-0565	Cover
15-0544	Gaskets



Chrome Tappet Covers fit 1986-90 XL, 4 piece 42-0113 style presses onto tappet block. VT No. 42-0113

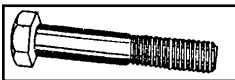

Tappet Base Screws.

Year	1957-85	1986-90	1991-94	1995-03
Acorn	—	8867-4	9765-4	9766-4
Allen	8782-4	8782-4	9759-4	9760-4
Hex, Cadmium	9846-4	—	—	—



Tappet Block Set fits 1986-90 XL models. Set of 4. VT No. 10-0593



Chrome Tappet Block Cover Set features contour for perfect fit over existing stock style tappet blocks, securely held in place by four chrome allen screws which are supplied. Pushrods must be removed for installation.

Original design by Motoy-Cycle™ Accessories. Fits 1957-85 XLH-XLCH.

VT No. 42-0115

Developed in 1991



# Valve by Rowe and Kibblewhite Precision Machining

Rowe or Precision Machining (Kibblewhite). Intake valves are made of 8645 heat treated valve steel and the exhaust valves are made of 21-2N heat treated non-magnetic stainless steel. These valves are available with the following stems and heads:

Model and Year	Application	ROWE VALVES			KIBBLEWHITE		
		Forged & Shot Peened Head		Fully Machined Head	Stainless		
		Roller Burnish Stem (1)	Melonite Special Black Stem (2)	Melonite Special Black Stem (2)	Rowe Pro (4)	Black Diamond™	Razor Back (5)
Ironhead Sportster 1958-1969	Intake 18070-58	—	—	—	—	11-6003	—
	Exhaust 18080-58A	—	—	—	—	11-6010	—
Ironhead Sportster 1970-1984	Intake 18070-58	11-6034	11-6041	—	—	11-6004	—
	1/16" O.S.	—	—	—	—	11-6107	—
	Exhaust 18080-58A	—	—	—	—	11-6010	—
Ironhead Sportster XLR 1970-85	Intake	—	—	—	—	11-6006	11-6082
	Exhaust	—	—	—	—	11-6013	—
Evolution 883cc 1986-2003	Intake 18031-86	—	—	—	11-6109	11-6091	—
	Exhaust 18030-86	—	—	—	—	11-6092	—
Evolution 1100cc 1987-2003	Intake 18023-86	—	—	—	—	11-6005	—
	Exhaust 18024-86	—	—	—	—	11-6012	—
Evolution 1100cc 1200cc 1987-2003	Intake 18023-87	—	—	11-6065	—	11-6093	—
	Exhaust 18024-87	—	—	—	—	11-6094	—
Evolution 883cc 2004-up	Intake 18053-04	—	—	—	—	—	—
	Exhaust 18059-04	—	—	11-6116	—	—	—
Evolution 1200cc 2004-up	Intake	—	—	11-6117	—	—	—
	Exhaust	—	—	—	—	—	—
Conversion 883 to 1200 Evolution	Intake	—	—	—	—	11-6072	—
	Exhaust	—	—	—	—	11-6073	—



**Oversize Valve Seats** can be used with unleaded gas. Replacement size is actual size of seat supplied by V-Twin Number. Stock size is noted as reference only.

### Intake

VT No.	Fits	Stock Size
11-0642	1957-69	1.690 Port Size
	Replacement Size	2 x 1.687 x 5/32"
11-0643	1970-85	1.650 Port Size
	Replacement Size	2 1/16" x 1.687 x 5/32"
11-0787	1986-up	1.815 x 1.398 x .384
	Replacement Size	36.5mm x 47mm x 10mm

### Exhaust

11-0659	1957-85	1.405 Port Size
11-0789	1986-up	1.579 x 1.107 x .340
	Replacement Size	1 1/16" x 1 1/8" x 3/8"



## One Piece Valve

**Manley Stainless Valve** machined from one piece forging with a swirl polished finish and chrome plated stem. Sold pairs.

VT No.	Type	Head Diameter	Stem Diameter	OEM
<b>1970-1985</b>				
11-9000	Exhaust	1 9/16" stock	.3385 stock	18080-58A
11-9032 is stock length from factory.				
11-9032	Intake	1 15/16" stock	.309 stock	18080-70
<b>1958-1969</b>				
11-9000	Exhaust	1 9/16" stock	.3385 stock	18080-58A
11-9034	Intake	1 15/16" stock	.309 stock	18070-58
<b>883 Evolution 1986-2003</b>				
11-9083	Exhaust	1.345 stock	.3095 stock	18030-86
11-9080	Intake	1.585 stock	.3105 stock	18031-86
<b>1200 Evolution 1988-2003</b>				
11-6093	Intake	1.715 stock	.3105 stock	18023-87

- Roller Burnished Stem:** Roller burnishing smooths the finest grind finish (16 microinch) to a 4 microinch.
- Melonite, Special Black Stem:** This is a heat treating process developed and patented in Germany. Gives the valve a Black Smokey look. Very hard and slippery. Currently being used on O.E.M. valves available in Rowe or Black Diamond brands.
- Razor Back by Kibblewhite** are one piece forged Evolution-8 stainless steel, fully CNC machined with hard chrome stems.
- Rowe Pro:** Forged one piece stainless steel valve precision CNC machined. Features special black melonite finish, swirl polished tulip area and heat treated water tip.



48-1351



48-1512



48-1473



48-1545



48-7787

### Belt Buckles.

#### VT No. Style

- 48-1351 XLH Ironhead
- 48-1512 XL Gas Tank
- 48-1473 XLH Ironhead Electric Start
- 48-1545 XL Points Cover
- 48-7787 XLCH Sportster
- 48-1522 Complete Set





# Valve Guide



Size	V-Twin Cast Iron		Rowe Cast Iron	Rowe Ampco 45
	Intake	Exhaust	Exhaust	Intake
<b>1957-82</b>				
Standard	11-0718	11-0722		
+.001	11-0719	11-0723		
+.002	11-0720	11-0724		11-1907
+.003	11-0721	11-0725	11-9828	
+.004	11-0687			
<b>1983-85</b>				
Standard				11-1913
+.002				11-1915

Rowe Unhoned Cast Iron Valve Guides		
Intake and Exhaust Guide is the same unless noted.		
Size	1957-82 Intake	1957-82 Exhaust
Standard		
.001		11-2157
.002	11-2158	
.003	11-2160	
Top Dia.	.531	.531
Seal#	14-0143	14-0144
Overall	1.73	1.86
Length*For High Lift Cams		

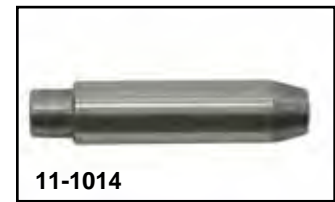

Size	Precision Bronzonium		Precision Ampco 45		Precision Cast Iron	
	Intake	Exhaust	Intake	Exhaust	Intake	Exhaust
<b>1957-82</b>						
STD			11-1024	11-1029	11-1034	11-1039
+.001			11-1025	11-1030	11-1035	11-1040
+.002			11-1026	11-1031	11-1036	11-1041
+.003	11-0767	11-0771	11-1027	11-1032		
+.004	11-0685	11-0684		11-1033		

Size	Rowe Ampco 45 In/Ex	Precision Machine Ampco 45 In/Ex	Precision Machine Cast Iron In/Ex
<b>Evolution Sportster 1986-up</b>			
STD		11-1019	11-1014
+.001		11-1020	11-1015
+.002			11-1016
+.003		11-1022	11-1017
+.004	11-1898	11-1023	11-1018
+.006	11-1899		

# Valve Seal



Valve Stem Oil Seal Kits include four pieces of proper guide seal and installation tool for XL's. Tool sold separately.

VT No.	Fits
16-1745	1985-up Kit
16-0405	1957-84 Kit
16-0134	1957-84 Tool, White
16-1746	1984-up Tool, Red



**Installation Tools**  
**16-0134** 1957-84 XL Tool  
**16-1746** 1984-up XL Tool Only

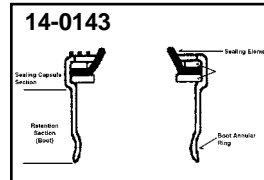

Valve Stem Seals in 10 packs for years listed. Installation tools and plastic 10 pack sleeves available separately.

VT No.	Fits	Mfg. No.	Size
14-0143	Intake XL 1957-85	1404	5/16"
14-0144	Exhaust, XL 1957-85	1405	11/32"
14-0164	Evolution 883-1200	1400	5/16"
16-1751	Sleeve 5/16"		
16-1752	Sleeve 11/32"		



# Sifton Valve Spring Kits



**Sifton XL Lower Valve Collar and Seal Kit** for all 1957-85 models. Kit includes four special lower collars machined to accept K-line style seals. Two intake seals and two exhaust seals. Top of guide must still be machined to accept seals. Seal installation tool included.  
**VT No. 11-0821**



**Sifton Lightweight Valve Spring Kits** include springs, keepers, retainers, and lower collars unless noted. Fits 1970-84 XL for 160 lb seat pressure, up to .460" valve travel. Hard-anodized aluminum retainers. May require "R" model valve to achieve installed height.  
**VT No. 13-2210**



**Sifton Lightweight Valve Spring Kits** include springs, keepers, retainer, and lower collars unless noted.



## Sportster .490" Lift Kit except Evolution

VT No.	Combined Loads	Coil Bind	Recommended Cam Lift
11-9609	85 @ 1.310 .500 @ .820	.790	Stock-.490

The above .490 lift kit features stock OD springs, interference fit to reduce harmonics and control spring surge. No machining required for installation. Springs have 20% more pressure than stock. Use with stock lift cams to .490. Supplied with steel top collars. Uses stock lower collars.



**Valve Spring Kits.** Includes all springs, collars and keepers necessary for each application.

VT No.	Year	Spring Only
13-9211	1957-81	13-0102
13-9199	1981-83	13-0102
13-9207	1983-85	13-9175
13-9196	1986-01	—



## Andrews Valve Gear 1957-85

VT No	Item
11-9881	Low Profile provide .060" more spring travel, 4 piece Set
1986-2001	<b>XL Evolution</b>
13-9251	Hi-Lift Springs .550+ :No machining required



## All Evolution XL

VT No.	Type
13-2080	170-180 lb seat pressure, up to .600" valve travel. With Titanium retainers.
13-2085	170-180 lb seat pressure, up to .600" valve travel. With Heat treated steel retainers.
13-2093	170-180 lb seat pressure, up to .600" valve travel. With Hard anodized aluminum retainers.
13-2140	170-210 lb seat pressure, up to .800" valve travel With Titanium retainers.
13-2142	170-210 lb seat pressure, up to .800" valve travel. With Heat treated steel retainers.



**Sifton Valve Spring Set** for High Lift Cams can be used with stock retainers and lower collars.

VT No.	Fits
13-2090	1985-90 up to .600" valve lift
13-2215	1970-84 stock replacement

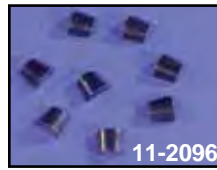

**Sifton Valve Spring Keeper Sets.** Keepers are CNC machined and then heat treated.

VT No.	Fits
11-2096	1986-up
11-4276	1957-84 includes retainer



**Valve Keeper Keys** Split type Packaged and sold in four pairs per package enough for one engine.

1957-85	1986-2001
11-0514 V-Twin	11-9610 Manley
11-9614 Manley	11-0805 V-Twin



**Steel Valve Collars.** Precision Machined and heat treated. Black oxide finish.

VT No.	OEM	Use	Year	Model
11-0806	18220-57	Lower	1957-Early81	900 and 1000
11-0807	18220-81	Lower	1981-Early83	900 and 1000
11-0808	18220-83	Lower	Late1983-85	900 and 1000
11-0809	18221-57B	Upper	1957-84	900 and 1000
11-0810	18222-83	Lower	1986-01	883-1100-1200
11-0811	18219-83	Upper	1986-01	883-1100-1200





# Heads and Hardware

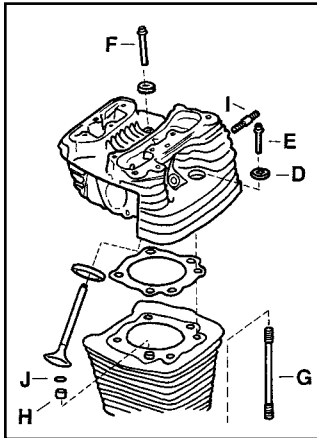

Components for One Head

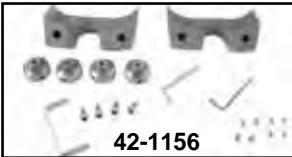
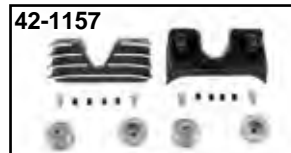
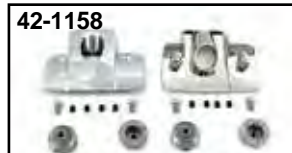

### Finned Head Bolt Bridge.

Bolts on! 2004-up XL.

Chrome Black Silver

42-1158 42-1157 42-1156

## Chrome Dome Cap Kit



9001-4 installed on bike

### Head Bolts and Hardware Kits for 1986-up XL Models for one head.

VT No.	#	OEM	Item
37-9370	—	—	Hardware Kit (Includes D, E and G)
2011-8	E	16478-85A	Head Bolt Chrome, 8 pack
	F	16480-85A	Screw Set, Late 1985-91 Big Twin
2012-8	E	16478-85A	Head Bolt Chrome, 8 pack
	F	16480-92	Screw Set 1993-up XL
9507-8	G	16832-86A	Colony Stud Evolution, 1986-up XL
37-9260	G	As Above	Sifton
37-8935	H	16573-83	Insert, 8 pack
12-1187	I	16715-83	Exhaust Stud, 5 pack
14-0516	J	26432-76	O Ring, 10 pack
37-9075	D	16482-85	Washer Late 1985-92, Zinc, 4 pack
37-9265	D	As Above	Chrome, 8 pieces
2017-8	D	As Above	Chrome, 8 pieces

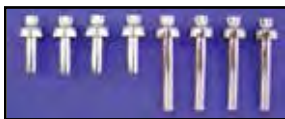

**Chrome 12 Point Head Bolt Set** includes 8 washers and 8 head bolts for 1986-92 XL. VT No. 37-9019

## COLONY Head Bolt

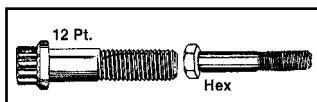

**Head Bolts, Head Nut and Washer Kits** are the highest quality available. Machined from high strength steel and hardened to original factory specifications to prevent stretching. All bolts feature rolled threads for superior strength and fit.

Cad	Chrome	Fits	Type
8945-16	8944-16	1957-72	Hex
—	9747-16	As Above	Allen
9212-16	9211-16	1973-85	12 point
—	9748-16	As Above	Allen

**Head Bolt Washer Kit** fits 1957-85 Sportster models.

8170-10 8488-10



**883 XL Model.** Ironhead motor model features 1:10 scale with authentic 1957 Sportster 900cc details! Fully pewter casted and mounted on a wooden base for display. VT No. 48-0746



**1986-03 Head Bolt and Spark Plug Covers** are die cast and chrome plated to cover entire head bolt area and spark plug base. Held

in place by rubber boots on spark plug wires. Fits 883-1200 XL models.

VT No. 42-0741



37-9131 Installed

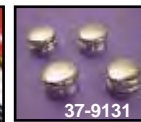

37-9131



37-8799

**Chrome Head Bolt Covers** fit 1986-2003 XL.

VT No.	Type
37-9131	Grooved
37-8799	Smooth



48-1351



48-1512



48-1473



48-1545



48-7787

### Belt Buckles.

VT No. Style

48-1351	XLH Ironhead
48-1512	XL Gas Tank
48-1473	XLH Ironhead Electric Start
48-1545	XL Points Cover
48-7787	XLCH Sportster
48-1522	Complete Set

# 9.5:1 883-1200 Big Bore Cylinder Kit



11-0473

**1200cc XL Conversion Cylinder and Piston Set** includes 2 silver finished cylinders or black wrinkle with milled edge fin cylinders with fitted Wiseco or Sifton moly 9.5:1 reverse dome piston and ring set. Order Rocker box gasket set separately.

VT No.	Item	Type	Finish	Years
11-0473	Cylinder/Piston Kit	Wiseco	Silver	1986-03
11-0355	Cylinder Piston Kit	Wiseco	Black	1986-03
11-0595	Cylinder/Piston Kit	Sifton Moly	Black	1986-03
11-1115	Cylinder/Piston Kit	Sifton Moly	Silver	1986-03
11-1118	Cylinder/Piston Kit	Sifton	Black	1986-03
11-1104	Cylinder/Piston Kit	Sifton	Silver	1986-03
11-1105	Cylinder/Piston Kit	Sifton	Black	1986-03
11-0346	Cylinder/Piston Kit	Wiseco	Silver	2004-up
11-0347	Cylinder/Piston Kit	Wiseco	Black	2004-up
11-0377	Cylinder/Piston Kit	Sifton Moly	Silver	2004-up
11-0378	Cylinder/Piston Kit	Sifton Moly	Black	2004-up

**Each kit includes**

- 2 Pre-Fit Cylinders with pistons and matching Hastings Piston Rings
- 10:1 Compression

## No Head Work Necessary

**Big Bore kits on this Page Do Not Require Any Machining!**

*The Sifton cylinders have a very thick, large O.D., "cast in" liner which has been proven to be an important factor to maintain thermal stability which is the ability to retain the important cylinder bore dimension through repeated heat cycles.*



15-0389

**Cylinder Base/Head Gasket Set.**

VT No.	Fits
15-0389	1986-03 XL
15-0394	2004-up XL



Power Stroke Hone  
Precision Fit!



Kwik-way Boring Bar

**Big Bore kits on this Page Do Not Require Any Machining!**

## No Head Work Necessary

**Each kit includes**

- 2 Pre-Fit Cylinders with pistons and matching Hastings Piston Rings
- 9.5:1 Compression



11-0595

We recommend use of adjustable pushrods with installation of Big Bore Kits

# 10:1 883-1200 Big Bore Conversion Cylinder Kit



**1200cc XL Conversion Cylinder and Piston Set** includes 2 silver finished cylinders or black wrinkle with milled edge fin cylinders with fitted Wiseco 10:1 piston and ring set.

VT No.	Finish	Fits
11-0565	Silver	1986-2003
11-0589	Black	1986-2003
11-0336	Silver	2004-up
11-0337	Black	2004-up





# 1957-85 Cast Iron Cylinder & Piston Kit



11-2607

VT No.	VT No.	10:1 Wiseco Year	CC	
9:1	11-2605	—	1957-71	900
	11-2606	—	1972-Early 73	1000
	11-2607	11-2617	Late 1973-85	1000



**Cylinder Base Studs** feature heat treating and interference thread at cylinder base. sets of eight.

VT No.	OEM	Year
8858-8	16830-72	1972-85
12-2102	16830-54	1954-71
12-2103	16830-72	1972-85



## Cylinders and Hardware

**Cylinders** are for stock bore, stock stroke and compression. Must be honed to standard size for proper fit.

Front	Rear	OEM	Year	CC
11-0482	11-0492	16464-58	1957-71	900
11-0488	11-0489	16464-72	1972-Early 73	1000
11-0504	11-0505	16464-73A	Late 1973-85	1000



**Base Nut Wrench** for 1957-85.  
VT No. 16-0108



**Cylinder Base Nuts** for 1957-84.

Chrome	Cad	Parkerized	#	Type/Fits
7018-16	—	—	B	1957-84, Acorn
7623-8	—	—	C	1957-84 XLR type,
7624-8	—	—		As above, Black Oxide
8106-16	8107-16	9624-16	A	Stock Hex

## Gasket Kit

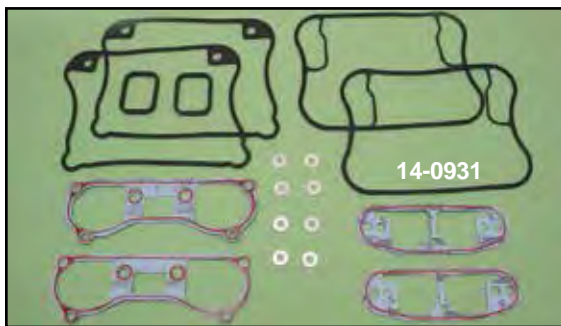

14-0931

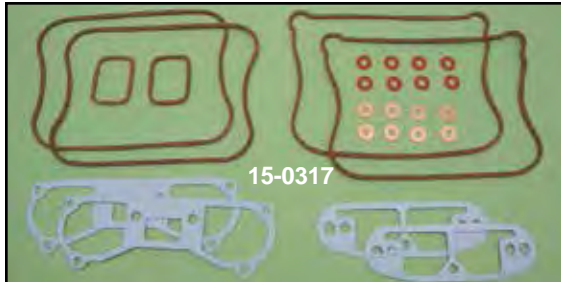

15-0317

**Rocker Cover Gasket Kits for Evo** include upper and lower gaskets in cork or molded O-ring type with bolt seals and washers for both heads.

James	GB	OEM	Type	Fits
15-0862	15-1377	17030-89	O-Ring	1986-90 883-1100-1200
—	15-0317	17030-86R	Cork	1986-90 883-1100-1200
15-0863	14-0931	17030-91	O-Ring	1991-2003 883-1200

## Collapsible Pushrod Cover Kit

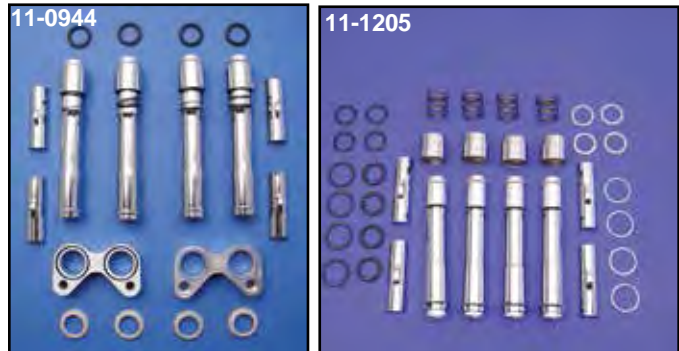

**Collapsible Pushrod Cover Sets** allow for ease of pushrod change or adjustment.

VT No.	Year
11-0944	1991-2003
11-1205	2004-up

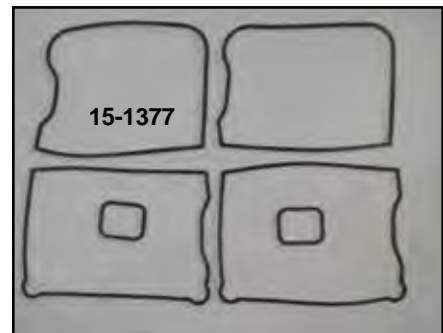

15-1377



# Replica Cylinder for 1986-up XL's



**Cylinders for Evolution XL Models** sold each. Cylinders sold without pistons and are not honed for final fit.

VT No.	OEM	Model	Finish	Years
11-0341	16446-86A	883	Silver	1986-03
11-0343	16447-88	1200	Black Wrinkle	1988-03
11-0344	16447-88	1200	Silver	1988-03
11-0342	16447-88	1200	Silver	1988-03
11-0334	16463-04	1200	Silver	2004-up
11-0335	16463-04	1200	Black Wrinkle	2004-up

**Each kit includes** two pre-fitted cylinders with pistons and matching Hastings piston rings, two head gaskets, two base gaskets and wrist pins.



**Replica Evolution XL Cylinder and Piston Sets** are pre-fitted with cast pistons and Hastings Rings.

VT No.	Size	Finish	Fits
11-2608	883cc	Silver	1986-03
11-2609	1200cc	Silver	1988-03
11-2626	1200cc	Black	1988-03

**Motor Shop 1200cc Cylinder Sets** include Wiseco fitted piston and ring sets to be used with 1200cc heads only. Fits 1988-03 1200cc as stock replacement on 1200cc only. Can not be used as Big Bore Kit for 883 models.

VT No.	Finish	Ratio
11-1200	Black	9:1
11-1201	Silver	9:1
11-1202	Black	10.5:1
11-1203	Silver	10.5:1

Install Slobber Stopper in this hole. Tap threads in this hole using tap supplied in kit

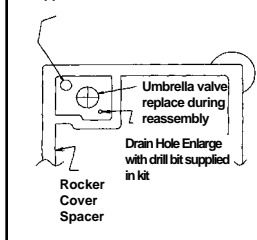

Remove material here to achieve correct alignment

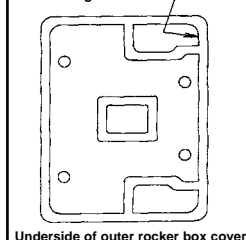

**Sifton Evolution Rocker Box Breather Upgrade Kit** includes tap, drill bit, breather tubes and instructions. Fits 1992-up.  
VT No. 16-0916

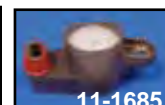
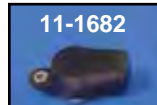

**OE Breather Valves**, sold each.  
Front Rear Year  
11-1682 2004-07  
11-1684 11-1685 2007-up  
14-0955 Valve Flap





**WISECO PISTON**

# Forged Piston Kits



Note: For our Product Descriptions "XL" denotes for Sportster models (including XLH, XLCH, XLS).

**Wiseco High Performance Forged Piston Sets** include 2 pistons that are forged from a high Silicone alloy, 2 ring sets (either Wiseco XC or Hastings X style), 2 wrist pins and 4 circlips. Wiseco rings sold per piston.



<b>1972-85 1000 Sportster 10:1 Compression 3<sup>3</sup>/<sub>16</sub>" Bore.</b> Piston Kits include Hastings X Ring.					
	Standard	.010	.020	.030	.040
Piston Kit	11-9720	11-9721	11-9722	11-9723	11-9724
Rings	11-9748	11-9749	11-9750	11-9751	11-9752
<b>1986-up 883 XL Evolution Overbore to 1200cc Rev Dome 8.5:1 Compression 3<sup>1</sup>/<sub>2</sub>" Bore.</b> Piston Kits include Hastings X Ring. *Note: 2009-up cylinders cannot be overbored. Requires the purchase of 1200cc cylinder to be used with piston kit.					
	Standard	.010	.020		
Piston Kit	11-9945	—	—		
Rings	11-9759	11-9762	11-9760		
<b>1986-up Piston Kits</b> include Hastings X Ring Pack. 883 XL Evolution Overbore to 1200cc. 9.5:1 Rev Dome Compression 3 <sup>1</sup> / <sub>2</sub> " Bore. *Note: 2009-up cylinders cannot be overbored. Requires the purchase of 1200cc cylinder to be used with piston kit.					
	Standard	.010	.020	.030	.040
Piston Kit	11-9885	11-9886	11-9887	11-9888	11-9889
Rings	11-9759	11-9762	11-9760	11-9764	11-9765
<b>1986-up 883 XL Overbore to 1200cc Rev Dome 10:1 Compression 3<sup>1</sup>/<sub>2</sub>" Bore</b> Piston Kit includes Hastings X-Ring Pack. *Note: 2009-up cylinders cannot be overbored. Requires the purchase of 1200cc cylinder to be used with piston kit.					
	Standard	.010	.020		
Piston Kit	11-9846	11-9847	11-9848		
Rings	11-9759	11-9762	11-9760		
<b>1988-2003 1200 XL, 1986-1987 1100 XL Evolution Flat Top 9:1 Compression.</b> Piston Kit includes Wiseco XC Ring.					
	.017	.027	.037	.047	
Piston Kit				11-9861	
Rings			11-9863		
<b>1988-2003 1200 XL, 1986-1987 1100 XL Piston Kits</b> include Hastings X Ring Pack. 1200cc XL Evo 9:1 Compression with flat top piston.					
	Standard	.010	.020	.030	.040
Piston Kit	11-9890	11-9891	11-9892	11-9893	—
Rings	11-9759	11-9762	11-9760	11-9764	11-9765
<b>1988-2003 1200 XL, 1986-1987 1100 XL Evolution 10.5:1 Compression.</b> Piston Kits include Hastings X-Ring Pack					
	Standard	.010	.020	.030	.040
Piston Kit	11-9913	11-9914	11-9915	11-9916	11-9917
Rings	11-9759	11-9762	11-9760	11-9764	11-9765
<b>2004-up 1200 XL Evolution 10.5:1 Compression.</b> Piston Kits include Hastings X-Ring Pack.					
	Standard	.010	.020		
Piston Kit	11-9954	11-9955	11-9956		
Rings	11-9759	11-9762	11-9760		



**S&S Button Style Keepers** control wrist pin end play which varies with bore size. Button style keepers must be fully supported by wrist pin hole. Sold in pairs. 3<sup>3</sup>/<sub>16</sub>" bore, standard to +.070, Aluminum. VT No. 11-2170



### Wiseco Replacement Wrist Pins

are sold each.  
**VT No. Bore Size**  
 11-9776 3<sup>3</sup>/<sub>16</sub>" and 3<sup>7</sup>/<sub>16</sub>"  
 11-9852 3<sup>1</sup>/<sub>2</sub>" 883 Evolution



**Wiseco Replacement Circlips** fit all 3<sup>3</sup>/<sub>16</sub>" bored pistons, sold as a pair.  
**VT No. 11-9779**



## KB PERFORMANCE PISTONS

\*Note: 2009-up cylinders cannot be overbored. Requires the purchase of 1200cc cylinder to be used with piston kit.

Engine	1000cc Sportster	1200cc Evolution	1200cc Evolution	883 to 1200cc Conversion
Model	XLH-XLCH	XL	XL 1988-up	XL
Years	1972-85	1988-up	w/High Cam	1986-up
C.I.D.	61"	74"	74"	74"
Bore	3.188"	3.498"	3.498"	3.498"
Stroke	3.812"	3.812"	3.812"	3.812"
Head Type	Dome	Flat Top	Flat Top	Dish
Cyl Height	5.330"	4.650"	4.650"	4.650"
Comp. Ratio	8.2	9.0:1	8.9:1	10.0:1
Standard	11-2240	11-2210	11-2245	11-2228
.005	—	11-2211	11-2246	11-2229
.010	11-2241	11-2212	11-2247	11-2230
.020	11-2242	11-2213	11-2248	11-2231
.030	11-2243	11-2214	11-2249	11-2232
.040	11-2244	11-2215	11-2250	11-2233

The Keith Black 390 Hypereutectic alloy is cast in a permanent steel mold which makes it possible to build a light weight piston that makes more power, runs quietly, uses less fuel and lasts longer than any other type of piston being made today. We can now forget about running loose, noisy, oil-burning pistons. The low heat transfer of the alloy keeps the skirts cool so piston expansion is minimal.

The KB piston will make maximum power at 2 to 4 degrees less total timing than conventional pistons. All KB pistons sets are supplied with Hastings Moly Ring sets.

APPLICATION	RING END GAP FACTOR	PISTON TO WALL CLEARANCE
Street Normally Aspirated	.0065"	.00075"-.0015"
Street Nitrous or Supercharged	.0080"	.0015"-.0025"
Flat Track Gasoline	.0080"	.0010"-.0030"
Flat Track Alcohol	.0060"	.0010"-.0030"
Drag Gasoline	.0075"	.0010"-.0030"
Drag Alcohol	.0065"	.0010"-.0030"
Drag Supercharged or Nitrous Gas	.0095"	.0015"-.0030"
Drag Supercharged Alcohol	.0085"	.0010"-.0030"
Drag Supercharged Fuel	.0115"	.0020"-.0040"

Note: It is important to use our ring end gap instructions to avoid ring butting. Safe top ring end gaps can be found by multiplying the bore diameter by the appropriate ring end gap factor from the adjoining chart.  
 Example: 3.5" bore "Street Normally Aspirated" = 3.5" bore x .0065" = .023" top ring end gap.

Note: Second ring end gaps do not need extra clearance.



# V-Twin Piston Kit



**V-Twin Piston Kits** include two cast alloy pistons, genuine Hastings three piece ring set, two wrist pins and four circlips.

*Over 100,000 Kits Sold Since 1978!*

**Piston Sets use 22588-78 Pin Lock, VT No. 12-0929**

Replica Type						
COMP	STD 9:1 900cc XL	STD 9:1 1000cc XL	LC 8.4:1 1000cc XL	STD 883cu V2	STD 1100cc V2	STD 86-03 1200cc V2
Dia.	3" Bore		3 <sup>3</sup> / <sub>16</sub> " Bore	Evolution	Evolution	Evolution
STD	11-0200	11-0208	11-0300	11-0241	11-0246	11-9761
.005	—	—	—	11-0242	11-0247	11-9849
.010	11-0201	11-0209	11-0301	11-0243	11-0248	11-9767
.020	11-0202	11-0210	11-0302	11-0244	11-0249	11-9768
.030	11-0203	11-0211	11-0303	11-0245	11-0250	11-9769
.040	11-0204	11-0212	11-0304	11-0440	11-0441	11-9712
.050	11-0205	11-0213	11-0305	—	—	—
.060	11-0206	11-0214	11-0306	—	—	—
.070	11-0207	11-0215	11-0430	—	—	—

11-0869



**Wrist Pin and Lock Kit.**

VT No. Year/Model

11-0869 1957-85 XL

11-0872 1986-03 1100-883 XL

11-0873 1988-03 1200 XL



**Wrist Pin Locks, 10 packs.**

12-0929 1978-85

12-0949 1986-up

## Big Bore Pistons

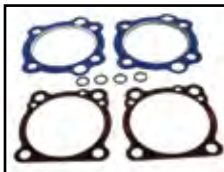

**Top End Gasket Set** fits Big Bore kits. Head base gasket set with .040 gasket, beaded, blue teflon with 4 O-Rings. Fits 1986-2003. VT No. 15-0393



See Tool section for more about our Motor Shop Services!



11-9885



11-1680



11-1700



11-1118

**Cylinder and Piston Conversion Kit** fits 1986-2003 XL. VT No. 11-1118

**Piston Sets** include rings, wrist pins and circlips.

**1986-up. \*Note:** 2009-up cylinders cannot be overbored. Requires the purchase of 1200cc cylinder to be used with piston kits.

VT No.	Item	Brand
11-9885	Piston Kit	Wiseco
11-1680	Piston Kit Standard	Sifton
11-1700	Piston Kit .005 OS	Sifton Moly
11-0852	Piston Kit Standard	Sifton Moly





# HASTINGS® RING SETS



Hastings Piston Ring Sets are replacements for OEM ring sets and will also fit our cast pistons. Available in standard or oversize versions with either a cast or moly compression ring and 3-piece oil ring in cast or moly construction. Sold in sets for two pistons.

<b>Model</b>	<b>883cc XL Evolution</b>
<b>Bore</b>	<b>3"</b>
<b>Comp Ring</b>	<b>1.5mm</b>
<b>Oil Ring</b>	<b>2.8mm</b>
	<b>Moly</b>
<b>Mfg.#</b>	<b>2M6198</b>
Standard	<b>11-0160</b>
.005	<b>11-0161</b>
.010	<b>11-0162</b>
.020	<b>11-0163</b>
.030	<b>11-0164</b>
.040	<b>11-0174</b>

<b>Model</b>	<b>1000cc XLH-XLCH</b>	
<b>Bore</b>	<b>3<sup>3</sup>/<sub>16</sub>"</b>	
<b>Comp Ring</b>	<b>1<sup>1</sup>/<sub>16</sub>"</b>	
<b>Oil Ring</b>	<b>3<sup>3</sup>/<sub>16</sub>"</b>	
	<b>Cast</b>	<b>Moly</b>
<b>Mfg.#</b>	<b>7003</b>	<b>2M7003</b>
Standard	<b>11-0109</b>	<b>11-1377</b>
.010	<b>11-0110</b>	<b>11-1378</b>
.020	<b>11-0111</b>	<b>11-1379</b>
.030	<b>11-0112</b>	<b>11-1380</b>
.040	<b>11-0113</b>	<b>11-1381</b>
.050	<b>11-0114</b>	<b>11-1382</b>
.060	<b>11-0115</b>	<b>11-1383</b>
.070	<b>11-0116</b>	<b>11-1384</b>
<b>Model</b>	<b>900cc XLH-XLCH</b>	
<b>Bore</b>	<b>3"</b>	
<b>Comp Ring</b>	<b>1<sup>1</sup>/<sub>16</sub>"</b>	
<b>Oil Ring</b>	<b>3<sup>3</sup>/<sub>16</sub>"</b>	
	<b>Cast</b>	
<b>Mfg.#</b>	<b>6457</b>	
Standard	<b>11-0100</b>	
.010	<b>11-0101</b>	
.020	<b>11-0102</b>	
.030	<b>11-0103</b>	
.040	<b>11-0104</b>	
.050	<b>11-0105</b>	
.060	<b>11-0106</b>	
.070	<b>11-0107</b>	

<b>Model</b>	<b>1200cc XL Evolution 1988-03</b>	
<b>Bore</b>	<b>3<sup>1</sup>/<sub>2</sub>"</b>	
<b>Comp Ring</b>	<b>1<sup>1</sup>/<sub>2</sub>"</b>	
<b>Oil Ring</b>	<b>5<sup>5</sup>/<sub>32</sub>"</b>	
	<b>Cast</b>	<b>Moly</b>
<b>Mfg.#</b>	<b>6164</b>	<b>2M6164</b>
Standard	<b>11-0190</b>	<b>11-1357</b>
.005	<b>11-0191</b>	<b>11-1358</b>
.010	<b>11-0192</b>	<b>11-1359</b>
.020	<b>11-0193</b>	<b>11-1360</b>
.030	<b>11-0194</b>	<b>11-1361</b>
.040	<b>11-0195</b>	<b>11-1362</b>
<b>Model</b>	<b>1200cc XL Evolution 2004-up</b>	
<b>Bore</b>	<b>88.85mm (3.498)</b>	
<b>Comp Ring</b>	<b>1.2mm Top Ring 1.5mm 2nd Ring</b>	
<b>Oil Ring</b>	<b>2.5mm</b>	
	<b>Moly</b>	
<b>Mfg.#</b>		
Standard	<b>11-1394</b>	
.005	<b>11-1395</b>	
.010	<b>11-1396</b>	
<b>Model</b>	<b>1100cc XL Evolution</b>	
<b>Bore</b>	<b>3.350</b>	
<b>Comp Ring</b>	<b>1.5mm</b>	
<b>Oil Ring</b>	<b>2.8mm</b>	
	<b>Cast</b>	<b>Moly</b>
<b>Mfg.#</b>	<b>—</b>	<b>2M6199</b>
Standard	<b>—</b>	<b>11-0165</b>
.005	<b>—</b>	<b>11-0166</b>
.010	<b>—</b>	<b>11-0167</b>
.020	<b>—</b>	<b>11-0168</b>
.030	<b>—</b>	<b>11-0169</b>
.040	<b>—</b>	<b>11-0175</b>



**Total Seal Ring Sets** include rings for 2 pistons with a top ring of ductile cast iron, the gapless-middle ring and Gold Power 3-pieces design oil rings.

	<b>900cc</b>	<b>883</b>
	<b>3" Bore</b>	<b>Evo</b>
		<b>V2</b>
<b>Mfg.#</b>	<b>7546</b>	<b>8916</b>
.010	<b>—</b>	<b>11-1828</b>
.030	<b>—</b>	<b>—</b>
.040	<b>11-1818</b>	<b>—</b>
.050	<b>—</b>	<b>—</b>

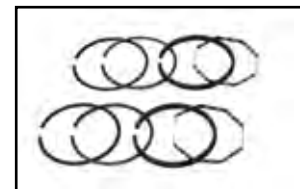

**One Piece Cast Iron Ring Sets** for 2 pistons with one piece oil ring.

<b>Dia.</b>	<b>1000cc</b>
	<b>XL 3<sup>3</sup>/<sub>16</sub>"</b>
	<b>Bore 61"</b>
Standard	<b>—</b>
.010	<b>11-2514</b>
.020	<b>11-2515</b>
.030	<b>11-2516</b>
.040	<b>11-2517</b>
.050	<b>11-2518</b>
.060	<b>11-2519</b>
.070	<b>11-2520</b>



# Gasket



**V-Twin Cylinder Head Gaskets Copper.**  
VT No. 15-0102

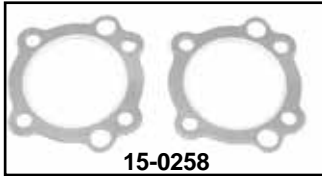

15-0258

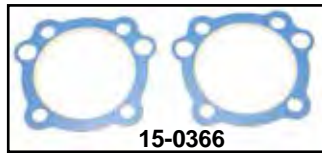

15-0366

### Cylinder Head Gaskets.

GB No.	James	OEM	Fits
15-0257	—	—	86-2000 883 Fire Ring
—	15-0970	16665-86	86-87 1100 Blue Teflon
15-0258	—	—	As Above Fire Ring
15-0366	15-1082	16773-86B	88-2000 1200 Fire Ring
15-0380	15-1083	—	As Above .045"
—	15-1132	—	As Above .030"
15-0643	—	—	As Above Graphite
—	15-1012	16769-57	1957-71 Teflon
15-0101	15-0973	16769-72A	1972-E73 Copper
—	15-1130	16769-73T	1973-85 Teflon
15-0102	15-0974	16769-73	1973-85 Copper
15-0189	15-1015	16769-82	1973-85 1000 Copper (.045")
14-0516	—	26432-76A	86-2000 Stud O-Ring

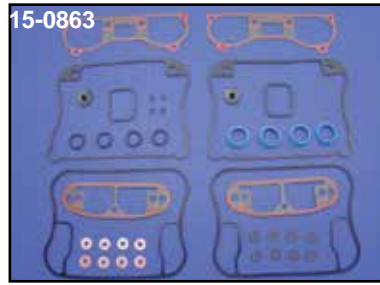

**Rocker Cover Gasket Kits for Evolution** include upper and lower gaskets in cork or molded O-Ring type with bolt seals and washers for both heads.

James	GB	Type/Fits
15-0862	—	O-Ring 1986-90 883-1100-1200
—	15-0317	Cork 1986-90 883-1100-1200
15-0863	14-0931	O-Ring 1991-03 883-1200
15-1454	—	2004-06 883-1200
15-1455	15-0786	2007-up



**GB Head/Base Gasket Sets** have .040 special copper head gaskets and .007" thick aluminum base gaskets, will not compress or torque. Kits include two head and two base gaskets.

VT No.	Year	Model
15-0313	1986-up	1200
15-0675	1989-up	883

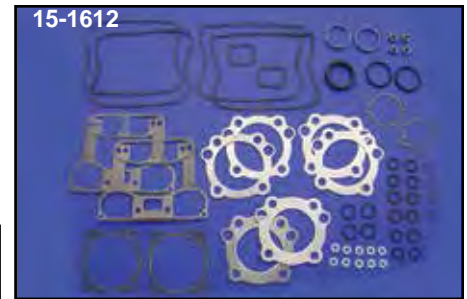

### GB Top End Gaskets for Sportster models.

VT No.	OEM	Years	Fits
15-0600	17030-57	1957-71	900cc
15-0601	17030-72	1972-E73	1000cc
15-0602	17030-73	1973-76	1000cc
15-0603	17032-79	1977-81	1000cc
15-0618	17032-82	1982-90	1000cc
—	—	1983	XR-1000
15-0635	17030-86	1985-90	883 Evolution
15-0636	17030-86A	1986-89	1100 Evolution
15-0639	—	1988-90	1200 Evolution
15-0053	17032-86B	1991-03	883 Evolution
15-0662	17032-91	1991-03	1200 Evolution
15-0054	17027-04	2004-up	883
15-0055	17049-04	2004-up	1200 Evolution



### Cylinder Base Gaskets.

GB No.	James	OEM	Fits
15-0105	15-0982	16774-57	1957-71 Front and Rear, 900cc
15-0106	15-0983	16774-72	1972-85 Front and Rear, 1000cc
15-1126	—	—	As Above Metal with seal Coating and Bead
—	15-1121	16774-86AC	1986-2003 with seal coating
15-0235	15-0984	16774-86D	1986-2003 Black
15-1534	—	16789-04	2004-up Black
15-1287	—	16774-86D	1986-03 Beaded



**Top End Kits.** Fits 2004-up XL. Replaces 17049-04.  
VT No. 15-1616





# Gasket Kits for XL's

*Genuine*

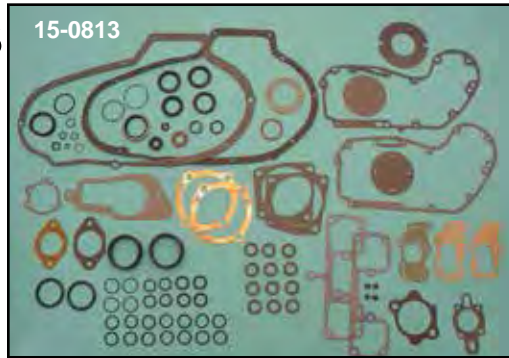
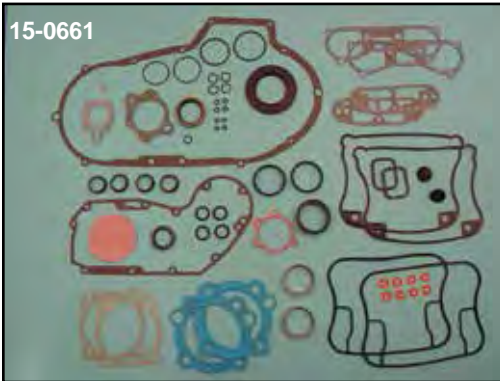
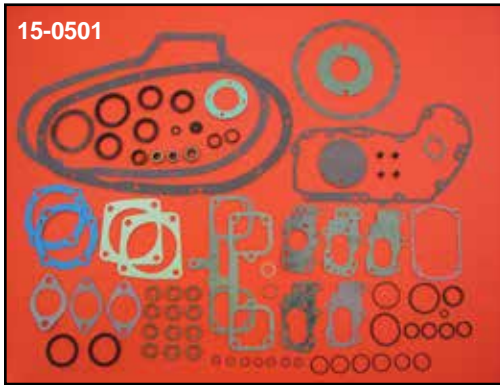

## Sportster Complete Gasket by James.

VT No.	OEM	Year	Models
15-0809	17026-71	1957-71	XLH-XLCH (Teflon Head Gaskets)
15-0813	17026-73	1972-85	XLH-XLCH (.032 Copper Head Gaskets)
15-1178	17026-86	1986-90	883-1200 XL (Teflon Head Gaskets/Rubber Rocker Gaskets)
15-0818	17026-91A	1991-03	883-1200 XL (Graphite Head Gaskets/Rubber Rocker Gaskets)
15-1450	17047-04	2004-06	883-1200 XL
15-1451	17047-07	2007-up	883-1200 XL

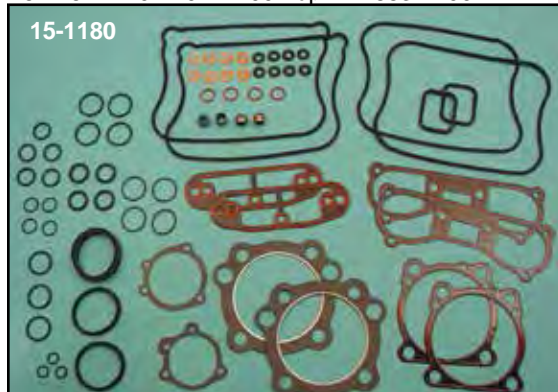

*Genuine*

## Top End Sets by James.

VT No.	OEM	Years	Models
15-0827	17030-57	1957-71	XL (Teflon Head Gaskets)
15-0828	17030-72	1972-85	XL (Copper Head Gaskets)
15-1180*	17030-86B	1986-90	1200 XL (Teflon Head Gaskets/Rubber Rocker Gaskets)
15-0835*	17032-91	1991-03	1200 XL (Graphite Head Gaskets/Rubber Gaskets)
15-1452*	17049-04	2004-06	1200 XL
15-1453*	17049-07	2007-up	1200 XL

\*Note: For 883 applications order head gaskets separately.



**Metal Cylinder Base Gasket** has a steel base metal which has been coated on both sides with a specially formulated high temperature oil resistant rubber compound. Silicone beading around the inner and outer perimeter forms a seal on both sides of gasket, pairs. Available from James. Fits 1986-up XL Evolution.

VT No. 15-1121

## Rocker Box Gaskets.

VT No.	James	OEM	Year
15-0112	15-1003	17536-70	1957-84
15-0640	—	Beaded	1957-84
—	15-1270	Metal w/bead	1957-84
15-0366	15-1134	17353-86	1986-up
15-0260	15-0991	17353-86	1986-up Lower (Cork)
—	15-0993	17354-86A	1986 Upper
15-0386	15-1135	17354-86A	1986-90 Upper
14-0933	15-0992	17353-89	1989-up Lower
—	15-0994	17354-89	1991-up Upper



## Engine Gaskets for Sportster Models by GB.

VT No.	OEM	Years	Models
15-0500	17026-70	1957-71	900cc
15-0501	17026-71	1972-E73	1000cc
15-0502	17026-73	1973-76	1000cc
15-0503	17026-79	1977-78	1000cc
15-0634*	17026-82	1982-85	1000cc
15-0523	17026-83	1983	XR-1000
15-1605	17026-86	1986-90	
15-0633	17026-86	1985-89	883 Evolution
15-0632	17026-86A	1986-89	1100 Evolution
15-0691	17026-88	1988-90	1200 Evolution
15-0661	17026-91A	1991-03	1200 Evolution

\*Note: Contains the thick low compression type head gasket. VT No. 15-0603 or 15-0504 can also be used for this application if a higher compression ratio is desired.



**GB Three Piece Rubber Coated Gaskets.** A three piece design that features a stainless center sandwiched between two rubber coated stainless spring steel outer layers. The outer layers are embossed at the oil drain hole and cylinder bore area that provides a correct seal. Sold in pairs. Fits Evolution Sportster.

## Cylinder Base Gaskets

Size	3 1/2" Bore	3 5/8" Bore	3 15/16" Bore	3 3/4" Bore
1986-99 XL, 883-1200				
.010	15-0487	15-0489	—	—
.020	15-0488	15-0490	—	—
Head Gaskets 1986-99 XL				
.030	15-0475	15-0477	15-0479	15-0481
.040	15-0476	15-0478	15-0480	15-0482



# 1954-76 XL-XLCH Oil Pump



**1957-76 XL Oil Pump**  
**Complete** includes all parts assembled. Hardware is sold less gears and body.  
**VT No. Fits OEM**  
**12-9979** 1957-66 26217-56  
**12-9930** 1967-76 26204-67  
**12-0177** 1957-76 Hardware Kit

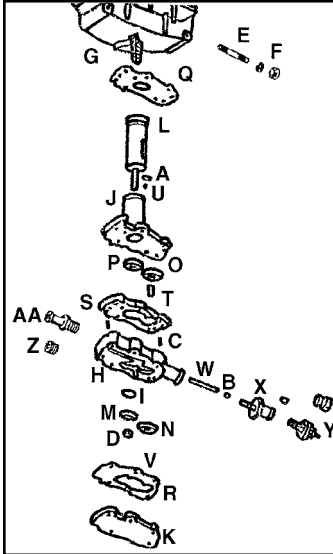

**Oil Pump Parts**, the small parts are available in packs of 10. The major parts are sold each. Fits 1952-76 all XLH-XLCH Sportster models.



**Oil Pump Gasket Kits for Sportster.**  
**James VT No. Years**  
**15-0849 15-0311** 1952-76



**XL Oil Pump Drive Gears.**  
**VT No. OEM Fits**  
**12-0421** 26318-37 1957-76  
**12-1380** 26318-75 1977-87  
**12-1377** 26318-88A 1988-up



**Machined Oil Pump Body** replaces 26214-72 for 1972-76 XL models, accepts later gears as listed below. Includes gear dowel pressed.  
**VT No. 12-1410**



**1972-76 XL Pump Gears.**  
**VT No. OEM Type**  
**12-9948** 26315-72A Scavenger  
**12-9949** 26317-72A Scavenger Idle  
**12-9950** 26322-52A Idle  
**12-9951** 26323-52A Feed



**Oil Pump Breather Parts.**  
**VT No. OEM Item**  
**12-1541** — Breather Kit  
**12-1542** — Oil Strainer Kit  
**12-1290** 25265-63 Deflector  
**12-1512** 24975-37 Oil Strainer 1954-76 XL  
**12-1173** 333 Pin, 10 pack  
**15-0214** 24978-57 Gasket, 10 pack  
**12-1511** 25075-55 Oil Transfer Valve, 1957-76 XL's  
**40-0121** 24912-52 Breather Pipe, 1954-78 XLH-XLCH Chrome with fitting nut  
**40-0546** 24918-52 Nut only for Above

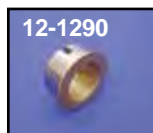

VT No.	OEM	#	Years	Item
<b>12-9930</b>	26204-67		1967-76	Complete Pump
<b>12-1524</b>	240	A	1961-71	Feed Pin
<b>12-1160</b>	603	A	1972-76	Roll Pin
<b>12-0158</b>	8873	B	1954-76	Check Ball
<b>N/A</b>	9095	C	1961-76	Dowel
<b>12-0901</b>	11002	D	1955-62	Retainer
			1972-76	
<b>8814-15</b>	24819-52	EF	1952-E71	Stud and Nuts
<b>8815-15</b>	24819-52	EF	As Above	Cadmium
<b>9614-10</b>	—		L1971-76	Stud and Nuts
<b>12-0154</b>	25276-52	G	1954-73	Screen
<b>12-1410*</b>	26214-72	H	1972-76	Body
<b>14-0114</b>	26227-58	I	1958-76	Seal
<b>12-9904</b>	26241-52	J	1954-76	Cover
<b>12-9946</b>	26250-56	K	1956-76	Plate
<b>12-8950**</b>	26331-52	L	1952-55	Breather Valve Gear
<b>12-8951**</b>	26331-56	L	1956-59	Breather Valve Gear
<b>12-8952**</b>	26331-60	L	1960-71	Breather Valve Gear
<b>12-8953**</b>	26331-72	L	1972-76	Breather Valve Gear
<b>12-9947</b>	26331-72	L	1972-76	Breather Valve Gear
<b>12-9948</b>	26315-72A	M	1972-76	Scavenger Gear
<b>12-9949</b>	26317-72A	N	1972-76	Scavenger Idle Gear
<b>12-9950</b>	26322-52A	O	1954-62	Idler Gear
			1972-76	
<b>12-9951</b>	26323-52A	P	1954-62	Gear, Feed
			1972-76	
<b>15-0942</b>	26256-52	Q	1954-76	Gasket, Case
<b>15-0945</b>	26258-52	R	1954-62	Outer Gasket
			1972-76	
<b>15-0946</b>	26258-62	R	L1962-71	Outer Gasket
<b>15-0950</b>	26259-52	S	1954-62	Inner Gasket
			1972-76	
<b>15-0951</b>	26259-62	S	L1962-71	Inner Gasket
<b>12-0800</b>	26327-52	T	1954-76	Idler Shaft
<b>12-0204</b>	26340-36	U	1960-71	Key
<b>12-0205</b>	26348-15	U	1972-76	Key
<b>12-0214</b>	26341-37	V	L1962-71	Retainer Half
<b>13-0115</b>	26364-57	W	1957-72	Check Spring
<b>13-0116</b>	26364-72	W	L1972-76	Check Spring
<b>N/A</b>	26420-57	X	1957-76	Fitting
<b>32-0427</b>	26552-72	Y	1954-76	Switch
<b>37-8777</b>	45830-48	Z	1958-76	Plug
<b>40-0566</b>	63533-41	AA	1967-76	Feed Fitting
<b>8816-10</b>	Chrome		1954-76	Allen Bolts
<b>8817-10</b>	Chrome		1977-90	Allen Bolts
<b>9806-8</b>	Chrome		1977-90	Acorn Kit

\*Note: 1972-76 body may be fitted on earlier models if later gears are substituted.  
 \*\*Note: GB Brand



**Oil Pressure Switches** are precision calibrated.  
**VT No. OEM Year Engine**  
**32-0427** 26552-72 1954-76 900-1000  
**32-0428** 26554-77 1977-up XL  
**12-1488** 26420-57 Fitting  
**32-1159** 1955-70 900





# Oil Pump Assembly 1977-up



12-1562

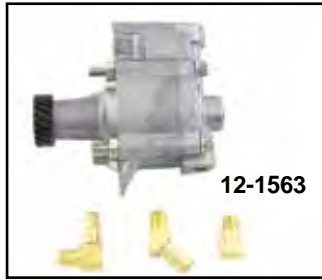

12-1563



12-9929



14-0109

**Oil Pump Seals.**  
James GB No. OEM Fits  
14-0611 14-0109 12036A 1977-90  
14-0623 14-0114 26227-58 1958-90



Acorn Screw



Allen Screw

## XL Oil Pump Mounting Kits.

Hex Chrome	Hex Cad	Allen	Acorn	Years
8814-15	8815-15	8816-10	—	1952-Early 71
9614-10	—	8816-10	—	Late 1971-76
—	—	8817-10	9806-8	1977-90
—	—	9774-8	9775-8	1991-up

**Oil Pressure Switch** is precision calibrated.  
Replaces 26554-77. Fits 1977-up.  
VT No. 32-0428

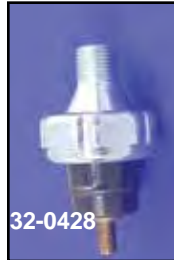

32-0428

## Oil Pump Gasket Kits for Sportster.

James	VT No.	Years
15-0850	15-0613	1977-90
15-1225	—	1991-up



15-0613

**Complete Oil Pumps** are fully assembled. Fit 1977-up.

VT No.	OEM	Years	Type
12-1562	26197-83 26204-75	1977-85	Complete
12-1563	26204-86	1986-90	Complete
12-9980	26488-75	1977-90	Shaft w/Gear only
12-0055	26204-91A	1991-up	1991-up Complete
12-9929	26204-91A	1991-up	Complete
12-9981	26488-91	1991-up	Shaft w/Gear only
10-0749	26431-76	1977-90	Cover Bushing
10-0750	26489-75	1975-90	Body Bushing

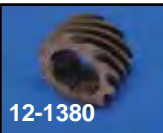

12-1380

## Oil Pump Drive Gears for XL.

VT No.	OEM	Fits
12-1380	26318-75	1977-87
12-1377	26318-88A	1988-up

## Oil Pump Gaskets.

GB No.	James	OEM	Fits
15-0129	15-0942	26256-52	1957-76 Body to Crankcase
15-0945	15-0945	26258-52	1957-E62; 1972-76 Outer Cover to Body
15-0133	15-0946	26258-62	1962-71 Outer Cover to Body
15-0135	15-0950	26259-52	1957-E62; 1972-76 Body to Inner Cover
15-0136	15-0951	25259-62	1962-71 Body to Inner Cover
15-0199	15-0961	26435-75	1977-90 Pump Mounting
—	15-1436	—	As Above, Foamet®
15-0684	15-0962	26495-89A	1991-up Pump Mounting
—	15-1437	—	As Above, Foamet®

## Shims for XL's.

VT No.	OEM	Use
12-0711	6732B	Pushrod
12-0704	.005	Rocker Arm
12-0710	.007	Rocker Arm
12-0715	.015	Rocker Arm
12-0705	6769	.007 Cam (1, 3, 4)
12-0706	6770	.005 Cam (1, 3, 4)
12-0716	6771	.015 Cam (1, 3, 4)
12-0717	6773	.005 Cam (#2)
12-0718	6775	.010 Cam (#2)
12-1258	6778	.015 Cam (#2)
12-0709	6802	Starter Crank
12-0713	.003	Sprocket Shaft 1952-76
12-0714	.003	Sprocket Shaft 1976-up

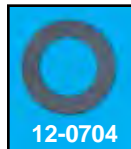

12-0704

# Oil Lines



40-0115

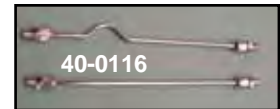

40-0116

**Chrome Oil Line Sets** for Sportster rocker boxes which include fittings and seals.

VT No.	Fits	Type
40-0115	1957-84	Coil
40-0116	1957-70	Magneto
40-9986	Fittings for Above, 4 pack	
14-0147	63529-57, Seals only, 100 pack	
14-0930	As Above Red Silicone, 50 pack	



**Stainless Steel Braided Overhead Rocker Arm Oil Lines.** Fit 1957-84 Sportster.  
VT No. 40-0242



**Breather Pipe** replaces 24912-52A on 1954-78 XLH-XLCH, chrome with fitting nut.

VT No. 40-0121



**Motor Shop Services Sportster 4-Speed Mainshaft Gear Cluster Assemblies.** Each shaft is assembled with correct thickness thrust washers and snap ring for proper gear clearance. Also included is shaft end play washer assortment for proper end play shimming during installation.

**Mainshaft Assemblies**

VT No.	Year
17-1250	1956-69 XLCH
17-1251	1967-70 XLH Only
17-1252	1971-E84
17-1253	Late 1984-86
17-1254	1987-90

## 4-Speed Transmission Installation Tips

**VT No. 17-0028, 17-0027, 17-0032, 17-0030, 17-0033, 17-0034, 17-0031, 17-0029**

All XL Transmission assemblies are bench tested for positive gear engagement and disengagement but it is always best for a final check after unpacking transmission before being installed.

All V-Twin Transmissions are assembled with late style shifter cam plate that uses welded in pin for neutral switch indicator. On some early (Pre 1974) case this pin may have to be shortened or removed to allow cam plate to move freely. Failure to check this will cause transmission to not completely shift through all gears. This should be checked first prior to assembly.

### Gear Engagement Check

Rotate pawl carrier (EE) until pawl carrier contacts lifter arm (Y+X). Hold the shifter cam (D) with opposite hand to prevent cam follower (I) from completing gearshifts. If hand pressure is released from shifter cam the gears will be drawn into complete engagement and all inspection procedures will be performed incorrectly.

Shift transmission into first gear then check gear to dog Pocket Engagement. Correct engagement should be 25%.

Shift transmission into all other gears checking Pocket Engagement, which must be at least 50%.

Filing of lifter arms (Y+X) will produce changes in Pocket Engagement.

### Establishing Mainshaft and Countershaft Endplay

Use the thinnest low gear washer and mainshaft washer. On 1954-early 84 models the mainshaft thrust washer must be installed with Tang Down. For 1954-early 1984 models the mainshaft needle bearing will have to be installed. Temporarily install access cover to crankcase with all transmission parts. Carefully align Cover Dowel Pins and with a rawhide mallet tap into position and install four cap screws.

When installing transmission into case check shift fork shaft for correct alignment to case. Do not force transmission into case if shift fork shaft will not go in to case. If shift fork shaft is forced into case damage or bending to shaft will happen causing shifter roller finger to bind against shifter cam plate or shifter fork binding on shaft or with pawl carrier assembly.

**On 1954-E84 Models** Inspect case race and rollers, if badly pitted scored or worn they should be replaced. Correct fit of main bearing is .0006in-.0014in. If clearance is beyond specified limit a new race and bearings must be installed, and line lapped for proper fit. **Note:** Fitment of door to case may sometimes requires reaming of holes in access door or removal of alignment pins from case. If removal of dowel pins is necessary tapping dowel pin holes and use of additional bolts is suggested.

Note also that even during factory assembly process several access doors were tried before final assembly.

Using a Dial Indicator measure mainshaft endplay from sprocket side of shaft, press against clutch gear so that bearing seats against lock ring in access cover. Move shaft back and forth and measure endplay while holding clutch gear in. If endplay is not with specification (see chart) install thrust washer of suitable size.

With access cover still in place bend a discarded spoke or other suitable wire and wedge into hole on end of countershaft. Push and pull countershaft and measure endplay with dial indicator. If endplay is not within specification (see chart) install countershaft washer of suitable size.

After countershaft endplay has been established install oiler plug in access cover with oil hole up.

**Note:** On 1959-early 84 models the clutch must be temporarily installed and the 1984-85 models the Stator spacing ring and the Stator must be installed on access door before above Endplay clearances can be established.

When Mainshaft and Countershaft end play established install **new** shifter shaft into the crankcase so that the shifter lever arm is centered. Using a grease pencil mark the shaft at the 12 o'clock position by marking the shaft you can tell if the shifter lever arm position changes when installing the transmission. Correct shaft to shifter pawl yoke engagement is important for proper gear shifting. Install transmission and rotate countershaft slowly to check that the gear shift arm is engaged with shifter pawl. To do so rotate shift lever, a noticeable resistance to movement indicates proper engagement.





# 4-Speed Transmission

1984-90 Units include Billet door by Sifton

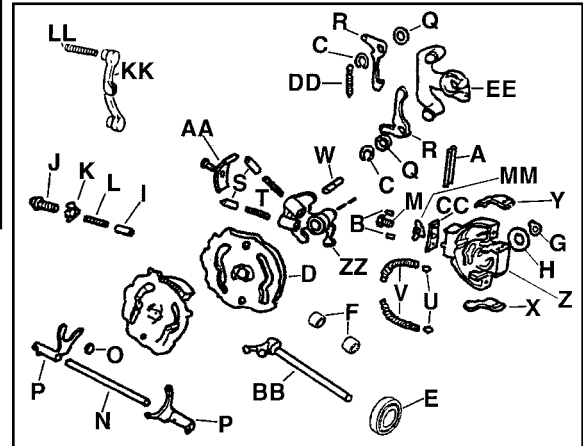

**Complete XLH-XLCH 4 Speed Transmission Gear Assembly Unit** includes gears, mainshaft, countershaft, shift forks and shafts assembled to trap door. Order right side case races, rollers, shims and bearings separately. Shift selector shaft included.

**VT No. Years**

**17-0028** 1956-66 XLH-XLCH, 1967-69 XLCH

**17-0027** 1967-70 XLH, 1970 XLCH

**17-0032** 1971-72 XLH-XLCH

**17-0030** 1973-74

**17-0033** 1975-76

**17-0034** 1977-84

**17-0031** Late 1984-85

**17-0039** 1986

**17-0029** 1987-90

**Note:** Main and countershaft end play and trap door alignment with case must be established and adjusted before final assembly.

**Transmission End Play Specifications**

	1956-78	1979-Early84	Late 1984-85
Countershaft	0.004-0.009	0.007-0.015	0.004-0.015
Mainshaft	0.003-0.009	0.003	0.003



**Batch of Transmissions Assembled!**



# 5-Speed Trans Gear



**1991-03 5-Speed Gear Sets** are available as kits which include: 1st gears, 2.68, counter and main, 2 pieces; 2nd gears, counter and main, 2 pieces; 3rd gears, counter and main, 2 pieces; 4th gears, counter and main, 2 pieces; 5th gears, counter and main, 2 pieces, countershaft, 1 piece; and mainshaft, 1 piece.

**VT No. 17-6015**



**17-9816 Medium Close Ratio 1st and 2nd** for drags and modified street bikes needing closer ratio shifts through 1st and 2nd gear, ratio "S" gear sets will be a distinct advantage. Set of 2 gears.

VT No.	Ratio	Fits
17-9816	2.368 1st gear set	1991-03
17-9724	1.876 2nd gear set	1991-03



**1994-03 5-Speed Trans Doors Stock.**

VT No.	OEM	Item	Type
17-0956	25238-94	Door	Stock
37-8935	16573-83	Insert	Stock



## 1991-up 5-Speed Transmission Hardware.

VT No.	OEM	Item	Fits
12-1159	11019	Retaining Ring	1991-03
12-0905	11031	Retaining Ring	1991-03
12-0968	33653-90	Retaining Ring	1991-03
13-9225	34481-91A	Spring	1991-03
13-9232	34491-91	Spring	1991-03
17-9853	6003	Thrust washer	1991-up
12-0366	8876A	Bearing, 4 pc	1991-up
12-0339	8977	Bearing, closed end	1991-up
12-0361	8996A	Ball Bearing	1991-up
12-0928	11067	Retaining Ring	1991-up
12-0952	11161	Retaining Ring	1991-up
14-0534	11165	Quad Seal	1991-up
14-0918	12030	Oil Seal	1991-up
14-0962*	12067B	Oil Seal	1991-up
17-0560*	33344-94	Spacer, Belt	1994-up
17-0586	35020-89	Retainer, Countershaft	1991-up
12-9997	35051-89	Needle Bearing	1991-up
17-0588	35063-89	Spacer	1991-up
17-9851**	33334-85	Spacer	1985-93

\*Note: Use on 1991-up with rear belt.

\*\*Note: Use on 1991-up with rear chain. Requires 14-0616 seal.

Speed	Main Drive	Drive	Seal	Spacer
5	17-9105	Belt	14-0962	17-0560
5	17-9105	Chain	14-0616	17-9851



**Super Close Ratio 1st, 2nd, 3rd, 4th "Y" gear sets** will put more usable torque where it belongs-at high RPMs. 2 gears per set.

VT No.	Ratio	Gear
17-9717	2.026	1st
17-9727	1.670	2nd
17-9737	1.364	3rd
s17-9747	1.158	4th



## 5-Speed 1991-up Gears and Shafts.

VT No.	OEM	Item	Type	Brand
17-9110	Set	2.61 close ratio 2 piece 1st gear set	1991-03	Andrews
17-9101	35771-89	2nd main/3rd counter	1991-03	Andrews
17-9103	35772-89	3rd main/2nd counter	1991-03	Andrews
17-9104	35773-89	4th gear/Main	1991-03	Andrews
17-9144	35775-89	4th gear/Counter	1991-03	Andrews
17-9105	35034-89	Main drive gear	1989-03	Andrews
17-9153	35633-89	Counter drive gear	1989-03	Andrews
17-9180	35640-89	Mainshaft	1989-03	Andrews
17-9183	35640-89	Mainshaft	1989-03	V-Twin
17-9182	35641-89	Countershaft	1989-03	V-Twin
17-9170	35641-89	Countershaft	1989-03	Andrews
17-0723	35163-06	Mainshaft	2006-up	V-Twin



## Transmission Drain Plugs.

**A.** Chrome dome head plug with an oversize thread and one tap for rethreading the stripped out drain hole. Fits 1965-up O.H.V. Big Twin and 1967-up Sportster w/4 -Speed transmission.

VT No.	Type
7502-2	Plug and Tap
7503-1	Plug Only

**B.** Stock style of drain plug and brass gasket used on Sportster transmission and motor case also oil tank with 1/2"-13 thread.

VT No.	Finish
8494-1	Chrome
8495-1	Cadmium
8495-1T	Cadmium
15-0194	Brass Gasket
15-1158	Brass Gasket James

# Drain Plug

**COLONY**





# 4-Speed XLH-XLCH Gears

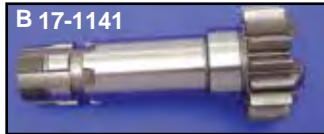

**Clutch Gears for Sportster**, 17 tooth, includes bushing and Torrington needle bearing.

Andrews	VT No.	#	OEM	Fits
—	17-1140	A	37449-56	1956-66 XLH-XLCH 1967-69 XLCH
—	17-1141	B	37448-67	1967-70 XLH, 1970 XLCH
17-8710	17-1142	C	37448-71	1971-E79 XL's
17-8711	17-9760	D	37448-79	L1979-E84 XL's
—	17-9826	E	37448-84A	L1984-86
17-4850	17-9146	F	37448-87	1987-90, 18T



**4-Speed Gear Sets For Sportster** are available as kits which include: 1st gears, counter and main, 2 pieces; 2nd gears, counter and main, 2 pieces; 3rd gears, counter and main, 2 pieces; 4th gears, counter and main, 2 pieces: the countershaft, and mainshaft, **must be ordered separately.**

1973-78	1979-84	Evolution 4 Speed	Brand
"W" 1st, Stock 4th			
17-6011	17-7654	—	Andrews
"W" 1st, "C", 4th			
17-6012	17-7655	17-7656	Andrews
Stock 1st, Stock 4th			
17-6013	17-7657	—	Andrews
—	17-0761	—	V-Twin
Stock 1st, "C" 4th			
17-6014	17-7658	17-7659*	Andrews

**\*Note:** Requires use of early countershaft 35613-58, VT No. 17-0328, 17-1151 or 17-8248



**Needle Bearings** feature full compliment roller design.

VT No.	Torrington	OEM	Type/Use
12-0461	12-0326	35690-54	Closed Transmission
12-0396	12-0327	35961-52	Open, Transmission

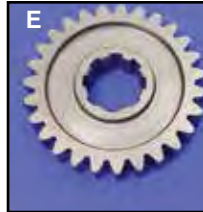

## 1st and Countershaft Drive Gear.

VT No.	Andrews	#	OEM	Teeth	Shaft	Fits
17-1122	17-1050	A	35277-52A	27	Main	1954-90
17-1053	—		Sifton	27	Main	1954-90
17-0168*	—	B	35760-54	17	Counter	1954-72
17-1119	17-1060	C	35760-73	17	Counter	1973-83
17-9825	—	D	35760-84A	17	Counter	1984-90
—	17-8580	E	35695-58	27	Counter	1958-86
17-5621	17-5620	F	35695-87	26	Counter	1987-90
17-1143	—	E	Sifton	27	Counter	1958-86

**\*Note:** Includes speedometer drive gear.

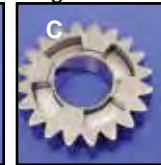
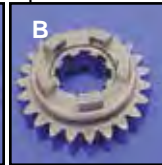

17-1123

## 2nd Gears

VT No.	Andrews	OEM	#	Teeth	Shaft	Fits
17-1126	17-8241	35750-58A	C	20	Counter	1958-90
	17-8242	35296-56A	B	23	Main	1956-90
17-1123	Sifton	35296-56A		23	Main	1956-90

## 3rd Gears

VT No.	Andrews	OEM	#	Teeth	Shaft	Fits
—	17-8243	35709-54B	D	23	Counter	1954-90
17-1124	Sifton	35709-54B	D	23	Counter	1954-90
17-1120	17-8244	35305-56A	A	20	Main	1956-90



**Andrews "C" Ratio Gear Sets** provide true close ratio shifting for XL gear boxes.

VT No.	Fits
17-8720	1971-78 All XL
17-8721	1979-Early 84 All XL
17-4850*	Late 1984-90 All XL
17-5622*	Late 1984-90 All XL (Sifton)

**\*Note:** From 1987-90 all XL models have "C"

Ratio Main Drive Gears as stock parts. Also fits late 1984 alternator 1000cc models.

Gear	Stock Ratio	"C" Ratio
1st	2.52	2.29
2nd	1.83	1.66
3rd	1.38	1.26
4th	1.00	1.00



**Andrews Wide Ratio 1st Gear Sets** changes 1st from 2.52 ratio to 2.68 for more low end torque with 21T or 22T trans sprocket. Fits 1973-85. Can also be used on 1986-90 models if early type countershaft is used. VT No. 17-9856



# 4-Speed Main Shaft Hardware

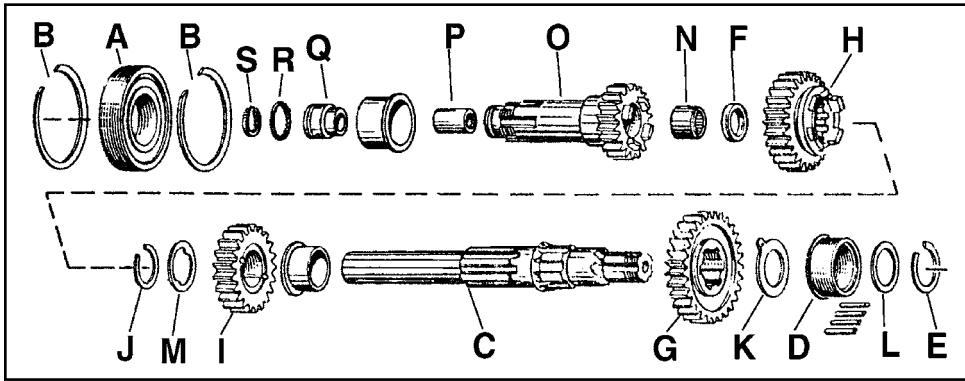

## Main Shaft Hardware

VT No.	OEM	#	Item	17-1122	35277-52A	G	M.S. First Gear, 1954-86, 27T	
12-0308	9025A	A	Ball Bearing, each	17-1050	As Above	G	Andrews	
12-9936	9025A	A	As Above, Torrington	17-8242	35296-56A	H	M.S. Second gear, 1956-90, 23T Andrews	
12-0378	35030-89	A	Ball Bearing, 1989-up 5-Speed	17-1120	35305-56A	I	M.S. Third Gear 1956-90, 20T	
12-0958	11006	B	Retaining Ring Inner, 1986-up	17-8244	As above	I	Andrews	
12-0965	11180	B	Retaining Ring, 1984-90 Outer	12-0932	35337-56	J	1956-up Snap Ring	
12-0930	35112-52	B	Retaining Ring, 1954-Early 84	17-1128	35326-73	K	Thrust washers .080, 54-78, 5 pack	
12-0966	35112-84	B	Retaining Ring Inner, Late 1984-85	17-9752	35326-Set	K	Set 15 pc .030-.125 54-78 Right	
17-1165	35044-56	C	Mainshaft, 1956-69 XLCH-XLH 1967-69 XLCH	17-9236	35385-84	K	.067 Right Side 1984-90, 5 pack	
17-8080	As above	C	Andrews	17-9237	35384-84	K	.072 As above	
17-1166	35046-67	C	Main Shaft, 1967-70 XLH	17-9238	35383-84	K	.079 As above	
17-1167	35046-71A	C	Main Shaft, 1971-E84, XL's	17-9239	35382-84	K	.084 As above	
17-8120	As above	C	Andrews	17-9240	35381-84	K	.090 As above	
17-9982	35036-84A	C	Main Shaft 1984-90 XL's	17-9241	35380-84	K	.096 As above	
<b>Main Shaft Oil Seals</b>				17-9247	35385-Set	K	1984-90, .067-.096, Six Piece Set	
17-1160			1952-E1984	17-9930	35360-Set	K	1979-83, .098-.125, Four Piece Set	
14-0150			L1984-1990	17-1129	35363-52	L	Thrust washer	
<b>XL Trans Main Bearing Race.</b>				17-1127	35364-56	M	Thrust washer	
VT No.	OEM	#	Years	Size	17-0089	35356-86	M	Thrust washer
17-1136	35105-52	D	1954-83	Standard	12-0327	35961-52	N	Needle Bearing
17-1178	As Above	D	Jims	Standard	17-1140	37449-56	O	Clutch gear 1956-66 XLH-XLCH 1967-69 XLCH
17-1137	—	D	1954-83	.002	17-1141	37448-67	O	Clutch gear 67-70 XLH, 70 XLCH
17-1138	—	D	1954-83	.005	17-1142	37448-71	O	Clutch gear 1971-E79 XL
17-1180	As Above	D	Jims	.005	17-8710	As above	O	Andrews
17-1139	—	D	1954-83	.010	17-9760	37448-79	O	Clutch gear Late79-E84 XL includes P, N, F installed
17-9912	—	D	1954-83	.020	17-8711	As Above	O	Andrews
17-9924	35105-83	D	E1984 only	Standard	17-9826	37448-84A	O	Clutch Gear Late1984-86, All
17-9925	—	D	E1984 only	.005	17-9146	37448-87	O	Clutch Gear 1987-90
17-9927	—	D	E1984 only	.002	17-4850	As Above	O	Andrews Set (Two Piece)
12-0359	9118	DD	1984-90	Bearing	10-0751	37458-52	P	Bushing, Clutch Gear
12-0361	8996	DD	1991-2005	Bearing	10-0764	37538-56	Q	End Bushing Clutch Gear
17-1182	35041-84	D	L1984-90	Standard	14-0502	11103	R	O-Ring
17-1183	—	D	L1984-90	.002	14-0127	37531-56B	S	Seal
17-1184	—	D	L1984-90	.005				
12-0931	35113-52	E	Retaining Ring	1954-Early 84				
17-9913	35216-79	F	Thrust Washer	.212				
17-1125	35361-56	F	Thrust Washer					



**XL Transmission Rollers.** Available in set of 23 or 100.

23 Pack	100 Pack	OEM	Size
17-1147		9095	Standard
17-1148	12-4588	9096	.0004
17-1149	12-4589	9097	.0008



**Oil Seal and Retainer Kit.** Metal retainer with seal. Replaces 35150-52, includes gasket and screws. Fits all 1952-Early 1984. **VT No. 17-1160**

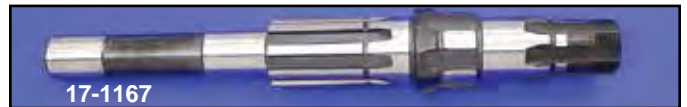

## XL Mainshaft

Andrews	VT No.	OEM	Fits
17-8080	17-1165	35044-56	1956-66 KH-XL-XLH-XLCH 1967-69 XLCH
—	17-1166	35046-67	1967-70 XLH, 1970 XLCH
17-8120	17-1167	35046-71A	1971-E84 XLH-XLCH
—	17-0143	35046-71A	As Above, Sifton
17-8121	17-9982	35036-84A	1984-90 XLH
17-9180	17-9183	35640-89	1991-05 XLH
—	17-0723		2006-up XL





# 4-Speed XL Countershaft



**Countershaft Assemblies**  
**17-1260** 1954-72  
**17-1261** 1973-E84  
**17-1262** L1984-86  
**17-1263** 1987-90

## L1984-85 Sportster Countershaft Hardware

VT No.	OEM	#	Item
17-9200	35818-72	A	.020 Washer
17-9228	35327-73	A	.025 Washer
17-9201	35819-72	A	.030 Washer
17-9229	35328-73	A	.035 Washer
17-9202	35821-72	A	.040 Washer
17-9227	35329-73	A	.045 Washer
17-9230	35820-52	A	.050 Washer
17-9231	35821-52	A	.055 Washer
17-9232	35824-52	A	.060 Washer
17-9233	35825-72	A	.065 Washer
17-9203	35828-72	A	.070 Washer
17-9234	35829-52	A	.075 Washer
17-9204	35830-72	A	.080 Washer
17-9205	35818-72	A	.085 Washer
17-1132	Set of 12	A	.020, .025, .030, .035, .040, .045, .050, .055, .060, .065, .070, .075
12-0326	35960-54	B	Countershaft Bearing
17-9929	Set of 4	C	.047, .056, .066, .080
17-9831	35613-84	D	Countershaft
17-8580	35695-58	E	Countershaft Drive, 27T, Andrews
17-8243	35709-54B	F	Countershaft Third, 23T, Andrews
17-1126	35750-58	G	Countershaft Second
17-8241	As above	G	Andrews
17-9825	35760-84A	H	Countershaft Low, 17T
12-0368	8888	I	Low Gear Bearing
17-9871	35631-73	J	Oiler Plug
17-1135	35809-58	K	Thrust washer
17-1134	35841-58	L	Thrust washer
12-0327	35961-52	M	Countershaft Bearing, Open

## 1986-90 Sportster Countershaft Hardware

17-9221	35865-86	A&C	Thrust washer .030,
17-9223	35864-86	A&C	.035 As Above
17-9224	35863-86	A&C	.040 As Above
17-9225	35862-86	A&C	.045 As Above
17-9226	35861-86	A&C	.050 As Above
17-9251	35860-86	A&C	.055 As Above
17-9928	Set of 6	A&C	.030, .035, .040, .045, .050, .055
12-0326	35960-54	B	Bearing
17-9831	35613-84	D	Countershaft, Sifton
17-5621	35695-87E	E	Countershaft Drive 26T
17-5620	As Above	E	Andrews
17-8243	35709-54B	F	Third Gear, 23T, Andrews
17-1126	35750-56	G	Second Gear
17-8241	As above	G	Andrews
17-9825	35760-84A	H	Low Gear, 17T
12-0368	8888	I	Low Gear Bearing Countershaft
17-1135	35809-58	K	Thrust washer
17-1134	35841-58	L	Thrust washer
12-0327	35961-52	M	Bearing, Open

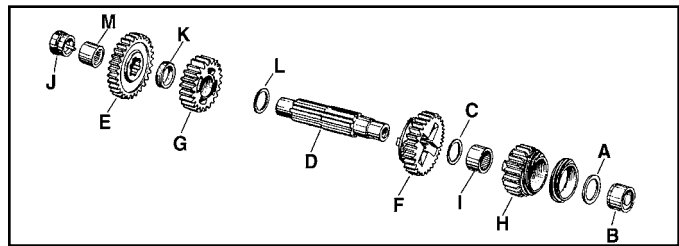

## 1954-E84 Sportster Countershaft Hardware

**Note: Washers sold in packs of 5, unless noted.**

VT No.	OEM	#	Item	VT No.	OEM	#	Item
17-9200	35818-72	A	.020	17-9231	35821-52	A	.055
17-9228	35327-73	A	.025	17-9232	35824-52	A	.060
17-9201	35819-72	A	.030	17-9233	35825-72	A	.065
17-9229	35328-73	A	.035	17-9203	35828-72	A	.070
17-9202	35821-72	A	.040	17-9234	35829-52	A	.075
17-9227	35329-73	A	.045	17-9204	35830-72	A	.080
17-9230	35820-52	A	.050	17-9205	35326-86	A	.085
17-1132	Set of 12	A	.020, .025, .030, .035, .040, .045, .050, .055, .060, .065, .070, .075				
12-0326	35960-54	B	Countershaft Bearing				
17-9253	35836-55	C	.075 Washer				
17-9254	35838-55	C	.085 Washer				
17-9206	35839-55	C	.100 Washer				
17-9235	35840-52	C	.065 Washer				
17-1133	Set of 4	C	.065, .075, .085, .100 Washer				
17-1151	35613-58	D	Countershaft				
17-8248	As above	D	Andrews				
17-0328	As above	D	Sifton				
17-8580	35695-58	E	Countershaft Drive, 27T Andrews				
17-8243	35709-54B	F	Countershaft Third, 23T, Andrews				
17-1126	35750-58	G	Countershaft Second				
17-8241	As above	G	Andrews				
17-0168	35760-54	H	Countershaft Low 1958-72 with Speedometer Gear 17T				
17-1119	35760-73	H	Countershaft Low Gear, 17T 1973-Early84				
17-1060	As above	H	Andrews				
10-2516	35787-52	I	1st Gear Bushing, 1954-Early72				
10-0752	35787-72	I	1st Gear Bushing, Late1972-Early84				
17-9771	35631-54	J	Oiler Plug 1954-72				
17-9871	35631-73	J	Oiler Plug 1973-86				
17-1135	35809-58	K	Thrust washer				
17-1134	35841-58	L	Thrust washer				
12-0327	35961-52	M	Countershaft Bearing, Open				



## Sifton™ Countershafts

VT No.	OEM	Year
17-0328	35613-58	1954-E84
17-9831	35613-84	1984-90
17-9182*	35641-89	1991-up

\*Note: 5 Speed



**XLH-XLCH Transmission Parts Continued.**

17-0053	34507-52A	Y	Pawl Lifter Arm, High
17-0233	Set	XY	Pawl Lifter Arm Set
N/A	34514-75A	Z	Pawl Support, 1977-90, Trock
17-9847	34514-75A	Z	Pawl Support, 1977-90
N/A	34489-52A	ZZ	Pawl Carrier 1954-71
17-9949	34494-74C	EE	Pawl Carrier 1972-90
17-0052	34525-70	AA	Pawl Retainer
17-1164	34628-54A	BB	Shift Shaft 1954-74
17-1162	34627-75	BB	Shaft 1975-76
17-0051	35891-66	CC	Shim, Pawl Support
13-0137	37222-52	DD	Shift Pawl Spring, 1972-90
13-9232	34491-91	DD	Shift Pawl Spring, 1991-up

# 4-Speed XLH-XLCH Trans

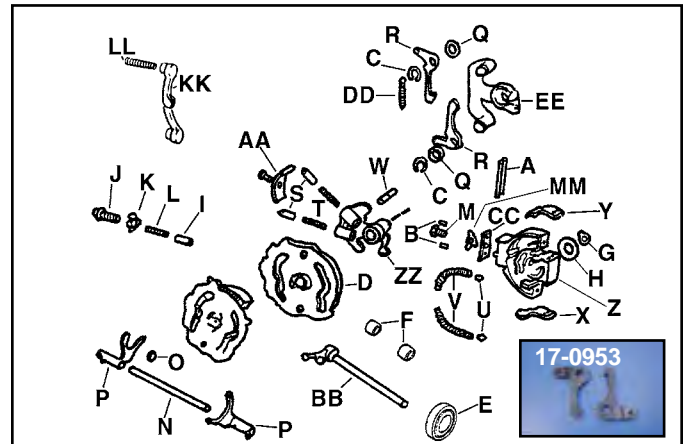

**Gear Selector Shafts for 1954-up Sportster models.**

VT No.	OEM	Years
17-1164*	34628-54A	1954-74
17-1186	34628-54	1954-74
17-1162*	34627-75	1975-76
17-1189*	34628-75	1977-85
17-1171*	34628-86	1986-90
17-1172*	34015-91	1991-2003
17-0987	34014-06	2006-up
10-1259	35404-74	1977-up, Thrust washer
14-0102	12010	1986-up Oil Seal
10-0733	40520-63	1979-up Bushing
10-0724	34037-52	1954-74 Bushing
14-0160	37101-84	1984-up Oil Seal
12-1292	16825-48	1954-74 End Plug



\*Note: All are splined on shift lever end.

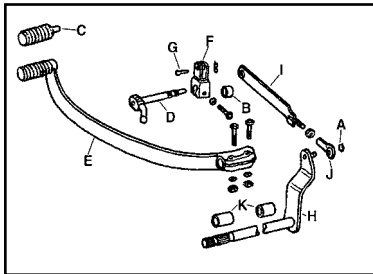

**1975-76 Shifter Linkage** replaces stock pieces for Sportsters.

VT No.	#	OEM	Item
12-0938	A	11016	Retainer
10-2483	B	34037-75	Bushing
21-0901	C	34611-65	Rubber
17-1162	D	34627-75	Shaft, Shifter
21-2034	E	34666-75	Lever, Chrome
17-0065	F	34670-75	Inner Lever
23-0421	G	42269-30	Clevis Pins washer and cotter pins
17-9758	H	42548-75	Cross Shaft
17-9780	I	42583-75	Shift Link
17-9781	J	42585-75	Pivot End, 5/16" x 24
10-2505	K	47757-52	Bushings, 2 pack



**XLH-XLCH Transmission Parts**

VT No.	OEM	#	Item
12-0974	638	B	Pin Arm Support
12-0939	11036	C	Retaining Ring
17-0061	34012-52C	D	Cam Plate 1952-76
17-0502	34012-75B	D	Cam Plate 1977-90
14-0116	34035-52	E	Oil Seal, 5 pack
10-0724	34037-52	F	Shifter Shaft Brush, pair
12-0917	34040-52	G	Cam Retainer Ring
17-0086	34060-52	H	Thrust Washer 1954-76, each
17-9911	35336-74	H	Thrust Washer 1977-90, each
17-0076	34062-52	I	Shifter Cam Follower
17-0067	34065-52	J	Cam Follower Bolt, each
17-0923	34067-52	K	Cam Bolt Lock Tab
17-0751	Kit	I,J,K	Cam Follower Kit
17-9845	34063-84	KK	Shifter Cam Follower
13-0130	34068-52	L	Cam Follow Spring
13-9161	29980-84A	LL	As Above 1984-up
17-0227	4621	M	Shifter Cam Bolt 1954-Early 84
17-0231	3854	M	Shifter Cam Bolt Late 1984-90
17-0919	34069-71	MM	Bolt Lock, Shift Cam
17-1159	34141-52A	N	Fork Shaft
17-0118	34168-52	O	Roller, Shift Fork, pair
17-1152	34291-52B	P	STD Steel Shift Fork
17-9793	—		+0.05 Steel Fork
17-9792	—		-.005 Steel Fork
17-1153	—		+.010 Steel Fork
17-1154	—		-.010 Steel Fork
17-1155	34292-72		+0.020 Steel Fork
17-1156	34293-72		-.020 Steel Fork
17-9790	—		+0.030 Steel Fork
17-9791	—		-.030 Steel Fork
17-1175	—		Standard Forged Brass Shift Fork
17-1173	—		+0.010 Forged Brass Fork
17-1174	—		-.010 Forged Brass Fork
17-1176	—		+0.020 Forged Brass Fork
17-1177	—		-.020 Forged Brass Fork
17-0058	34461-72	Q	Shift Pawl Spacer
17-0953	34476-72	R	Shift Pawl (2), Sifton
17-0073	34477-53	S	Shift Pawl Left, each
—	34478-53	S	Shift Pawl Right, each
13-0133	34482-53	T	Shift Pawl Spring
17-0056	34485-52	U	Plug Retainer
13-0134	34500-52A	V	Pawl Carrier Spring
17-0055	34503-52	W	Pawl Carrier Pin
17-0054	34506-52A	X	Pawl Lifter Arm, Low

XL





# Transmission Components



**Shifter Forks** steel type or brass forks available in standard or offset dimension. Both are one piece forged, heat treated and machined to stock specification. Use on all 4 Speed 1952-90. Sold each.

Brass	Steel	Size
17-1175	17-1152	Standard
—	17-9793	+ .005
—	17-9792	- .005
17-1173	17-1153	+ .010
17-1174	17-1154	- .010
17-1176	17-1155	+ .020
17-1177	17-1156	- .020
17-9794	17-9790	+ .030
17-9795	17-9791	- .030



**Shifter Finger Roller** replaces 34168-52. Fits 1954-90, sold in pairs.  
VT No. 17-0118



**Shifter Fork Shaft.**  
VT No. OEM Years  
17-1159 34141-52A 1952-84  
17-1170 34141-84A 1985-01



**Pawl Carrier Support Only.** Fits 1977-90, replaces 34514-75A.  
VT No. 17-9847



**Shifter Cam Follower** replaces 34063-84 on 1985-90, made of durable steel.

VT No.	Item
17-9845	Shifter Cam Follower
13-9161	Spring for Above



**Cam Follower Kit** includes steel follower and two springs Fits 1985-90.  
VT No. 17-0850



**Pawl Carrier Assembly** is an exact replica of forged aluminum as original and includes all internal parts assembled for XL 1952-90 4-Speed models. Replaces 34016-77. Order bolt separately.

VT No.	Item
17-0087	Assembly
17-9949	Pawl Carrier
17-0227	Bolt for 1954-E84
17-0231	Bolt for Late 1984-90



**Sportster Shifter Pawl Assembly** includes shifter pawl carrier, Shifter pawls, pawl springs, pawl spacer and retaining rings. Fits 1972-90 all XL models.

VT No. 17-9801



**Weld In Case Repair Section** fits 1957-83 cases.  
VT No. 43-0116

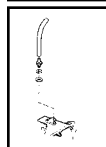

**Crank Case Vent Fitting** replaces 34744-77. Fits 1977-80.  
VT No. 40-0513

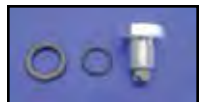

**Magnetic Drain Plugs** prevent metal particles from circulating through engine and transmission cases, oil tank, etc.

VT No.	OEM	Size	Use
37-0096	707	1/2 — 13	XL Transmission
37-0098	720, 706A	5/8 — 18	Oil Tank and Time Hole
37-8961	718	1/4 — 18	NPT Chain Cover

## Access Doors



VT No. 17-9148 is 7775-T6 aluminum and tempered 83,000 lb tensile strength

XLH-XLCH Transmission Products are guaranteed for quality and fit.

VT No.	Years	Item	Type
17-1161	1957-83	Door	Replica
17-1187	1957-83	Door with bearing	Replica
17-9148	1984-90	Door with alternator	Sifton
17-0956	1994-03	Door	Stock
37-8935	1991-03	Insert	Stock
12-1154	1957-90	Dowel	Pin Standard
12-1155	1957-90	Dowel	.010 Oversize



17-9148 Door Production



# Cover 1971-76



**Sprocket Cover.** Features starter motor cut out, fits both kick and electric start or electric start only models. Stock replacement type, not reinforced. Fits 1971-76 XLCH-XLH.

**Polished Chrome Type**

- 43-0108 43-0109 Kick and Electric
- 43-0173 Electric Only
- 43-0125 Electric Only



**Reinforced Sprocket Cover** features extra thick, heavy duty in cast aluminum. Fits 1971-76 XLH-XLCH.

**Polished Chrome Type**

- 43-0117 43-0145 Kick Only
- 43-0118 43-0180 Kick Starter and Electric

**1971-78 Kick Starter Return Spring Stud**

VT No.	Finish
17-0156	Chrome
9900-1	Chrome
9901-1	Cadmium

# Cover 1986-up



**Sprocket Covers** are die-cast as original. Order hardware separately. Fits XLS-XLH.

Polished	Chrome	Black	OEM	Year
43-0166	43-0167		34911-81B	1986-90
43-0129	43-0130		34911-81A	1981-85
—	43-0080		Belt	1986-90
43-0149	43-0150	43-0330	34911-91	1991-03
43-0185	43-0186	43-0329	34932-04	2004-up

# Sprocket Cover 1977-80



**1977-78 Sprocket Covers** for XLCH kick only, and XLH kick and electric. Has foot peg stud hole. Replaces OEM 34850-77 kick, 34870-75A kick and electric.

**Polished Chrome Type**

- 43-0111 43-0138 Kick
- 43-0112 43-0144 Kick and Electric
- 43-0172 Electric Only



Allen Style      Acorn Screw      Stock Screw

**Mount Kits**

Chrome	Chrome	Cad	Years	Type
8888-2	—	8889-2	1971-76	Stock
7155-4	—	—	1971-76	Acorn
8784-4	8784-4T	—	1971-76	Allen
8786-5	8786-5T	—	1977-80	Allen

**1979-80 Sprocket Covers.**

Chrome	Polished	OEM	Year
43-0177	43-1195	34870-79	1979
43-0178*		34872-79	1979
	43-0119*	34888-79	1979
43-0152	43-0120	34911-80A	1980

\*Note: For kick and electric start.



**1979 Kick Starter Return Chrome Spring Stud.**  
VT No. 9902-1





# Kick Starter Gear Kit

17-1105



**XLCH Ratchet Gear Kit** includes gear, plate, rivets, machined spacer and spring for appropriate year. Spacer supplied as noted.

VT No.	Year	Spacer
17-1103	1954-70	17-1100
17-1104	1971-72	17-1100
17-1105	1973-79	17-1102

17-1146



**XLCH Internal Kick Starter Gear Kit** has parts pictured, matched ratchet gear set with sleeve, crank gear, spring, rivets, locks, shaft and the hard to find hardware for XLCH repair or XLH conversion. Only needed parts are a cover, kick starter spring and arm assembly. 1980-up Sportsters are not drilled to accept a kicker shaft.

VT No.	Fits
17-1144	1954-70
17-1145	1971-72
17-1146*	1973-79

\*Note: Must be used with early style one piece kicker arm  
VT No. 17-0308.

## 1981-up Sprocket Cover and Hardware

42-0840



42-0843



42-0845



42-0930



42-0383



42-0384



**Sprocket Cover Trim** fits over existing cover for XL's as noted. Includes hardware.

Chrome	Black	Fits
42-0840		1986-90
42-0843		1981-85
42-0845	42-0383	1991-2003
42-0930	42-0384	2004-up



23-1728



23-3024



23-3080



23-3079

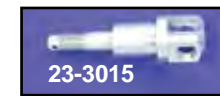

23-3015

**Sprocket Cover Hardware.** Fits XLS-XLH.

VT No.	OEM	Years	Item
23-3024	34866-86A	1986-90	Mount Stud
23-3015	42441-80	1980-90	Pivot Stud
23-3079	42441-90	1991-2003	Pivot Shaft
23-1728	34909-83	1983-90	Master Cylinder Support Bracket
23-3080	34933-96	1991-2003	Master Cylinder Support Bracket

\*Note: Fits belt and chain drive.



Acorn



Allen

**Sprocket Cover Screw Sets.**

Acorn	Allen	Years
—	8786-5	1981-85
8866-8	9750-6	1986-2003
—	9750-6T	1986-2003
—	2226-4	2004-up



# 1952-79 XLH Kick Starter Conversion

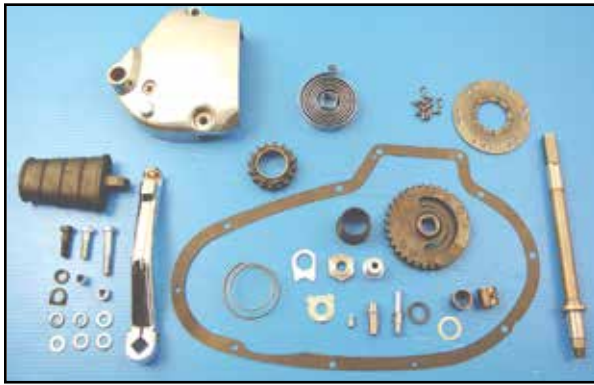

**XLH Complete Kick Starter Kits.** All parts included as illustrated. Check ratchet gear spacing before assembly. Available in kick only sprocket cover or kick and electric sprocket cover with cut away for start-er motor. Available with chrome or polished sprocket cover.

**V-Twin Original Since 1980!**

VT No.	Years	Type	Finish
22-0211	1973-76	Kick only	Chrome
22-0205	1977-78	Kick and Electric	Polish
22-0210	1977-78	As Above with Cover	Chrome
22-0206	1977-78	Kick only	Polish
22-0207	1979-only	Kick and Electric	Polish
22-0215	1986-90	Kit	Chrome

**Note:** 1980-up Cases are not machined from factory to accept kick starter components and can not be fitted with a kick starter.

VT No.	Years	Type	Finish
22-1050	1952-70	Kick only	Polish
22-0200	1967-70	Kick and Electric	Polish
22-0201	1971-72	Kick and Electric	Polish
22-0202	1971-72	Kick only	Polish
22-0203	1973-76	Kick and Electric	Polish
22-0209	1973-76	As Above with Cover	Chrome
22-0204	1973-76	Kick only	Polish

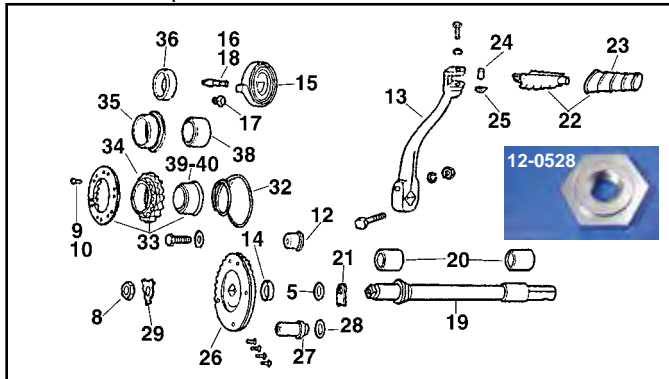

### Kicker Starter Hardware for 1954-79 Sportster.

VT No.	#	OEM	Years	Item
12-0709	5	6802	All	.007 Shim
12-0528	8	7926	All	Shaft Nut
17-1111	9	8215	1957-70	Rivet, 25 pack
17-1112	10	8216	1971-up	Rivet, 25 pack
17-9844	12	24577-68	1968-up	Hole Plug
17-0018	13	33052-71	All	Kick Arm
14-0115	14	33076-37	All	Oil Seal
13-0122	15	33084-41	All	Chrome Spring
17-0155	16	33088-52	1952-70	Spring Stud Zinc
17-0156	18	33088-71	1971-79	Spring Stud Chrome
17-1114	19	33094-57	1957-76	Kicker Shaft
17-1115		33094-77A	1977-79	Kicker Shaft
10-0718	20	33099-52A	All	Bushing Shaft
10-0719	20	As Above with seal		
17-1113	21	33110-54	All	Thrust Plate
17-0301	22	33175-16B	All	Kick Pedal
28-0213	23	33182-63A	All	Black Rubber
10-2494	24	33213-31	All	Pedal Bushing
13-9184	25	33215-30	All	Spring Washer
17-1106	26	33348-57	1957-77	Large Kick Gear
17-1107		33348-77	1978-79	Large Kick Gear
17-9833	27	33356-52	All	Gear Stop
37-9239	28	6469	All	Washer for Above
17-0911	29	33362-52	All	Lock Tab
17-1116	30	33379-57	1957-70	Ratchet Plate 9T
17-1109	31	33379-71A	1971-79	Ratchet Plate 9T
13-0127	32	33390-52	All	Ratchet Spring
17-1103	33	Cpt. Kit	1954-70	Ratchet Gear Kit
17-1104	33	Cpt. Kit	1971-72	Ratchet Gear Kit
17-1105	33	Cpt. Kit	1973-79	Ratchet Gear Kit
17-0998	34	33432-73	1973-79	Ratchet Gear 9T
10-0722	35	33442-57	57-E73	Bushing
10-0723	36	33442-73	L73-79	Bushing
17-1101	38	37753-76	1957-70	Spacer XLH, electric start only
17-1100*	39	37754-74	1957-72	Spacer 1.047 long
17-1102*	40	37755-73	1971-79	Spacer 1.153

**\*Note:** For kick and electric start.



**XLCH Ratchet Gear Kit.** Includes gear, plate, rivets, machined spacer and spring for appropriate year. Spacer supplied as noted.

VT No.	Year	Spacer
17-1103	1954-70	17-1100
17-1104	1971-72	17-1100
17-1105	1971-79	17-1102



**Ratchet Plate Riveting Fixture and Alignment Tool** clamps plate to drum while setting rivets on 1971-79 XL clutch drum.  
**VT No 16-0165**



17-1116



17-1109



17-1108

**Starter Ratchet Plates** available with 9 teeth. Both mesh with starter gear.

VT No.	OEM	Year
17-1116*	33379-57	1957-70
17-1109	33379-71A	1971-79
17-1108*	33379-71A	1971-79
17-1191	3379-57	18 Tooth



17-1191

**\*Note:** Machined type

**Ratchet Plate Rivets.** Two lengths  $\frac{5}{32} \times 1\frac{3}{16} \times \frac{9}{32}$  dia (8215) use on 1957-70 XLCH and  $\frac{5}{32} \times \frac{7}{16} \times \frac{9}{32}$  dia (8216) use on 1971-79 XLCH. 25 pk.

VT No.	OEM	Type
17-1111	8215	Early
17-1112	8216	Late





# Kick Pedal and Arm



**Kick Starter Arms** are constructed of forged steel for durability for 1954-84 FX-FL.

**VT No. OEM Finish Type**  
17-0309 Kit Complete

Includes heavy forged offset kick arm VT No. 17-0308, kick pedal 17-0301 and necessary hardware for easy installation.

- 17-0308 33052-71 Chrome Heavy
- 17-0310 As above Stainless Heavy
- 17-0018 As Above Chrome Standard
- 17-0322 33052-71 Black Polished
- 17-0344 Natural Replica Black
- 17-0601 Bolts Chrome Kit
- 17-0602 Bolts Chrome Kit



**Alloy Billet Kick Starter Pedals.**

- VT No. Style**
- 17-0386 Knuckle
- 17-0765 Maltese
- 17-1491 Knuckle Only Alloy
- 17-0359 Polished Alloy Assembly
- 17-0355 Bronze Assembly



**Red Baron Billet Kick Starter Pedal** includes chrome axle shaft.  
**VT No. 17-0651**



**Flat Kick Starter Pedals** available in O-Ring or Rail design.

- VT No. Type**
- 17-0299 O-Ring
- 17-9150 Rail

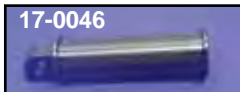

**Spool Kick Starter Pedal.** Order bolt kit separately.



- Chrome Black Style**
- 17-2124 17-0046 Smooth
- 17-0461 17-0459 Holes
- 17-0957 Hex



**Brass**  
17-0343 Holes



**Kick Starter Return Spring** for all 1954-79.

- VT No. OEM Finish**
- 13-0122 33084-41 Chrome
- 13-9248 33084-41 Black



**Stroker Kick Starter Arm Kit** includes I Beam, 1" longer chrome kicker arm with chrome rail type buffalo kick pedal and hardware.

- VT No. Item**
- 17-9921 Complete kit
- 17-0160 Arm only
- 17-9150 Pedal only



**Chrome Fold-Out Kick Starter Arms** for 1977-79. The 17-9934 features flat kicker pedal that spins.

- VT No. Type**
- 17-0307 Stock
- 17-9934 Flat Pedal Style



**H-D Logo Kick Starter Pedal** VT No. 17-0315



**VT No. 17-0982**

**Kick Starter Pedal Assembly** for 1936-76.

- VT No. Fits**
- 17-0301 Flat Rubber Complete
- 17-0311 Flat Rubber White
- 17-2123 Shaft Only
- 17-0302 Chrome Skeleton (USA)
- 17-0306 Bolt Kit
- 37-0992 Chrome Bolt (5 pack)
- 17-0771 Bolt, Each
- 37-0964 Bolt, Each, Chrome



**Kick Starter Rubber** is a stock replacement of rubber, for old style popsicle kick starter pedal.

- Black White**
- 28-0213 28-0214

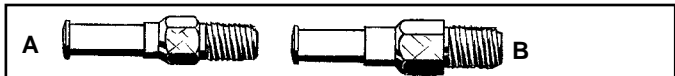

**Kick Starter Spring Studs.**

Zinc	Chrome	Cadmium	#	OEM	Year
17-0155	9898-1	—	A	33088-52	1952-70
—	17-0156	—	—	33088-71	1971-78
—	9900-1	9901-1	—	As Above	1971-78
—	9902-1	—	B	33098-79	1979



# 5 Speed Kicker Kit



22-0218  
Installed



22-0218



22-0213  
Installed



22-0213



22-0213  
Installed

Kicker Kits fit 1991-03 XL 5 Speed models. Sprocket cover features logo.

VT No.	Years	Finish	Item
22-0213	1991-03	Alloy	Kit
22-0218	1991-03	Chrome	Kit
22-0562	2004-06	Alloy	Kit
22-0563	2004-06	Chrome	Kit
22-0458	2007-up	Alloy	Kit
22-0459	2007-up	Chrome	Kit

### Components for 1991-up.

17-0466	1991-06		Mainshaft
17-0723	2006-up		Mainshaft w/gears
17-0467	2004-up		Cover
17-0468	2004-up		Kit
43-0967	2004-up	Alloy	Sprocket Cover
43-0969	2004-up	Chrome	Sprocket Cover



17-0723

Now Available for 2004-up models! Kit includes new mainshaft with integral gears!



Kickstarter Motor



22-0458





# 1991-up Clutch Component



**Complete Clutch Pack** includes all parts shown except clutch ramp.  
**VT No. Year**  
**18-0177** 1991-93  
**18-0178** 1994-03

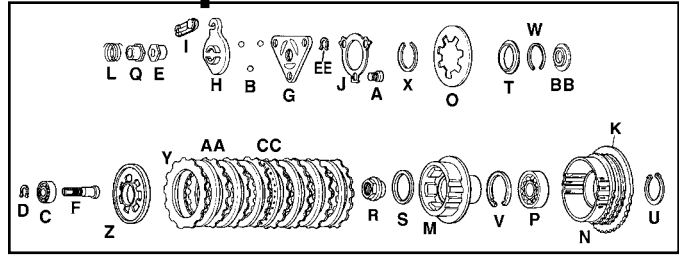

<b>18-3647</b>	—	K	Ring Gear
<b>13-9158</b>	36715-84	L	Clutch Adjuster Spring, 1991-93
<b>13-9257</b>	36715-94	L	Clutch Adjuster Spring, 1994-up
<b>18-8327</b>	36785-91	M	Clutch Hub, replica
<b>18-8326</b>	36790-91	N	Clutch Shell with P & V, 1991-03
<b>18-0792</b>	36790-04	N	Clutch Shell with P & V, 2004-up
<b>18-8296</b>	36792-91	O	Diaphragm Spring
<b>18-5052</b>	37924-04A	O	2004-up Diaphragm Spring
<b>12-9998</b>	36799-91	P	Ball Bearing
<b>17-0932</b>	36802-84B	Q	Filler Plug Lock Plate
<b>12-9915</b>	37495-91	R	Main Shaft Nut
<b>18-8298</b>	37870-91	S	Spring Washer
<b>18-8256</b>	37872-90	T	Inner Spring Seat
<b>18-8258</b>	37904-90	U	Retaining Ring
<b>18-8259</b>	37905-90	V	Retaining Ring
<b>18-8260</b>	37908-90	W	Retaining Ring
<b>18-8261</b>	37909-90	X	Retaining Ring
<b>18-3230</b>	37910-91	Y	Clutch Plates (8) Set
<b>18-8255</b>	37912-91	Z	Pressure Plate
<b>18-3231</b>	37913-90	AA	Steel Plate (6)
<b>18-8297</b>	37918-91	BB	Release Plate
<b>18-8313</b>	37977-90	CC	Spring Plate

## Clutch Hardware for 1991-up Sportster.

VT No.	OEM	#	Item
<b>37-9161</b>	3583	A	Bolt
<b>12-0158</b>	8873	B	Ball, 25 pack
<b>12-0353</b>	8885	C	Bearing
<b>12-0961</b>	11046	D	Adj. Screw Ret. Ring
<b>12-0567</b>	11730A	E	Nut Adj. Screw
<b>12-0986</b>	11250	EE	Ret. Ring, 1994-up
<b>18-3206</b>	11735B	F	Adjust Screw, 1991-93
<b>18-3242</b>	11752	F	Adjust Screw, 1994-03
<b>18-3210</b>	25453-87A	G	Ramp, Inner 1994-up
<b>18-0351</b>	Kit		Ramp Assembly 1991-93
<b>18-0352</b>	Kit		Ramp Assembly 1994-up
<b>18-0834</b>	Kit		Tamer, 1994-up
<b>18-3211</b>	34920-86	I	Cable Coupling
<b>17-0931</b>	25448-84	J	Lock Tab 1991-93

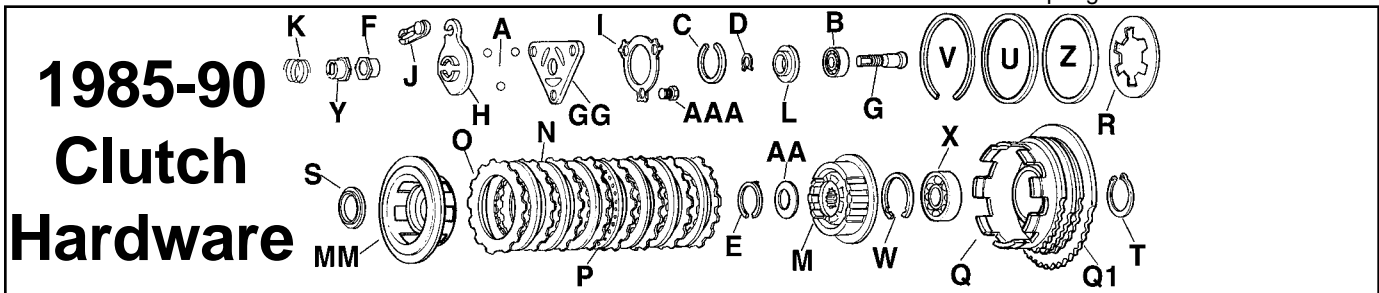

## Clutch Hardware for Sportster 1985-90.

VT No.	OEM	#	Item	VT No.	OEM	#	Item
<b>37-9161</b>	3583	AAA	Bolt	<b>18-8268</b>	36786-84	MM	Pressure Plate
<b>18-8269</b>	5707	AA	Spacer	<b>18-1146</b>	36787-84	N	Steel Drive Plate, 5 Piece Set
<b>12-0158</b>	8873	A	Ball, 50 pack	<b>18-3665</b>	36788-84	O	Friction Plate, 7 Piece Set
<b>12-0353</b>	8885	B	Bearing	<b>18-3216</b>	36789-84	P	Spring Plate, Center
<b>12-0960</b>	11045	C	Retaining Ring, Guide	<b>18-8324</b>	36791-84	Q	As Above V-Twin Brand
<b>12-0961</b>	11046	D	Adjusting Screw Retaining Ring	<b>18-3646</b>	—	Q-1	Ring Gear Only
<b>12-0962</b>	11164	E	Clutch Hub Retaining, 10 pack	<b>18-8233</b>	36792-84	R	Spring Pressure Plate
<b>12-0567</b>	11730A	F	Nut, Adjuster Screw	<b>18-8219</b>	36794-84		Clutch Internal Spring Seat Kit
<b>18-3206</b>	11735B	G	Adjust Screw	<b>12-0964</b>	36795-84	T	Ret. Ring, Clutch Hub
<b>18-0351</b>	25408-84	GG	Ramp Kit	<b>18-3660</b>	36797-84	V	Retaining Ring Press. Plate, 10
<b>17-0931</b>	25448-84	I	Lock Plate, Ramp	<b>12-0963</b>	36798-84	W	Retaining Ring Clutch Hub
<b>18-3211</b>	34920-86	J	Cable Coupling	<b>12-0352</b>	36799-84	X	Bearing, Clutch
<b>13-9158</b>	36715-84	K	Clutch Adjuster Spring	<b>17-0932</b>	36802-84B	Y	Filler Plug Lock Plate
<b>18-3659</b>	36730-84	L	Bearing Guide	<b>18-8266</b>	36793-84	Z	Spring Seat Center
<b>18-8244</b>	36785-84	M	Clutch Hub	<b>18-0179</b>	—	A-Z	Complete Kit

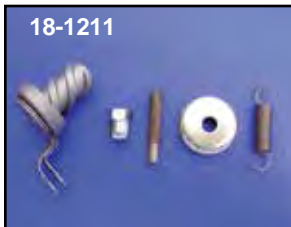

**Clutch Ramp Assemblies Full Kits** include all necessary hardware for installation.  
**VT No. Year**  
**18-0352** 1994-up  
**18-0351** 1986-93  
**18-3619** 1971-84  
**18-1211** 1954-70

# 1971-84 Clutch Hardware

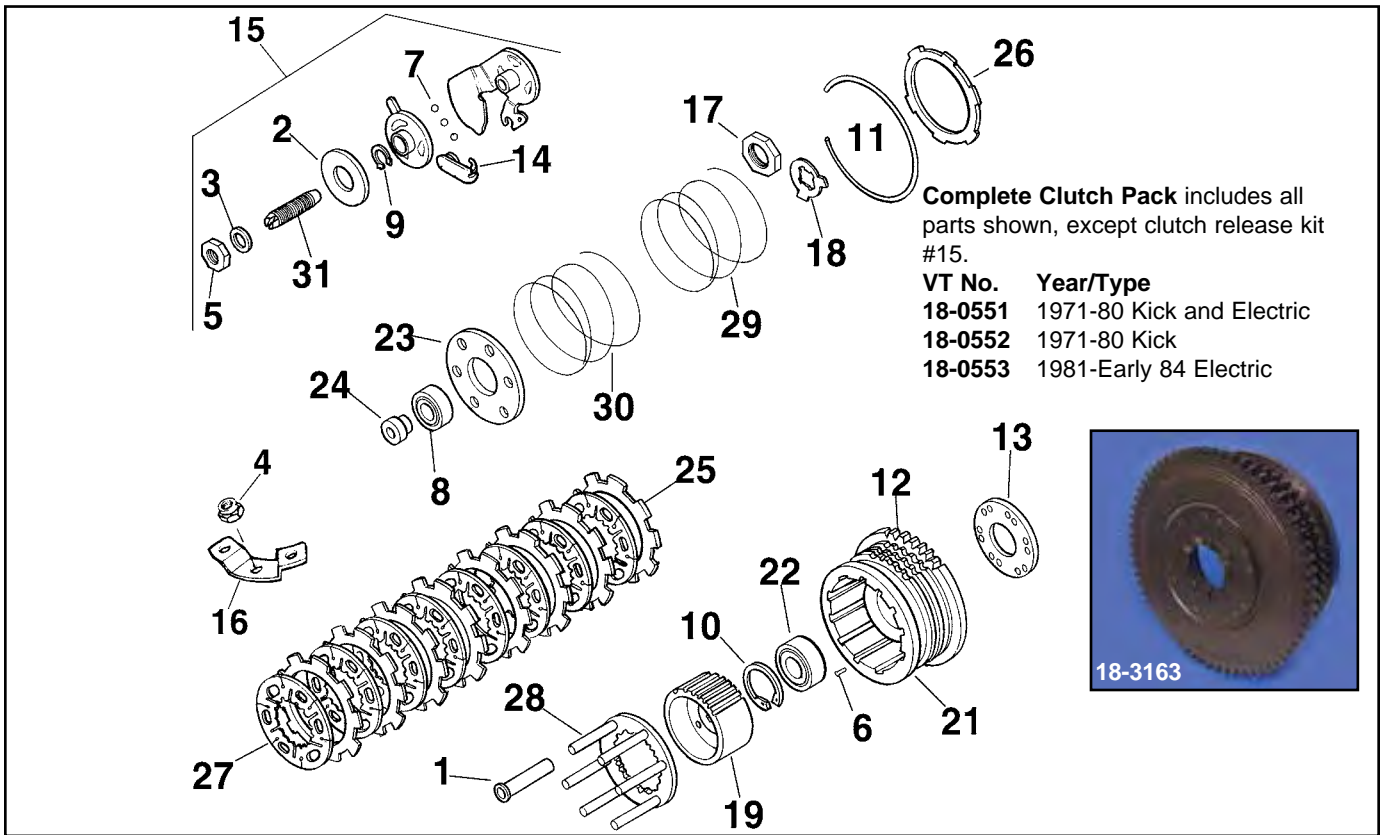

**Complete Clutch Pack** includes all parts shown, except clutch release kit #15.

VT No.	Year/Type
18-0551	1971-80 Kick and Electric
18-0552	1971-80 Kick
18-0553	1981-Early 84 Electric



## XL Clutch Hardware

VT No.	OEM	#	Item
18-1212	5995	1	Spacer Standard 1.525 (6)
18-1214	5996	1	-.040 (6) under
18-1215	5997	1	-.080 (6) under
18-3655	6860	2	Washer, each
37-0516	7130W	3	Lock Washer
12-0511	7686	4	Nylon Lock Nut, 10 pack
12-0513	7803	5	Adjuster Nut
17-1112	8216	6	Rivet, 25 pack
12-0157	8860	7	Balls
12-0341	9073	8	Bearing
12-0903	11005	9	Snap Ring, 10 pack
12-0909	11052	10	Snap Ring, 10 pack
18-3260	11053	11	Retainer, 10 pack
18-3640	33167-67	12	1967-80 Ring Gear
18-3645	—	12	1981-Early 84 Ring Gear
17-1109	33379-71A	13	Ratchet Plate
18-3650	34920-71	14	End Coupling
18-3619		15	Kit, assembly
12-0540	37527-67	17	Hub Nut, each
17-0912	37533-52A	18	Lockwasher, 10 pack
12-1967	Kit	17-18	Nut Kit
18-2321	37499-71	16	Retainer, Releasing Disc Nut, Set of 6 retainers with nuts
18-1142	37561-71	19	Clutch Hub
18-3162	37701-71A	21	As Above 71-80 Clutch Drum Kick Only with Ratchet Plate
18-3163	37716-71A	21	71-80 Clutch Drum Kick and Electric with Ratchet Plate
18-1131	37716-81	21	Clutch Drum 1981-E84 with Ring Gear
12-0329	33722-71	22	Bearing
18-3208	37878-74	23	Release Disc

18-2330	37879-71	24	Thrust Collar
18-3651	37985-71	25	Drive Plate, 8 pack
18-1119	37987-71	26	Outer Drive, each
18-1118	37992-71	27	Steel Drive, 8 pack
18-2322	38005-74	28	Stud Plate
13-0141	38079-72	29	Outer Spring
Set	38080-71	30	Inner Spring
18-3618	31830-71	31	Screw Kit (Includes 3 and 5)
18-1213	38130-71	31	Screw only

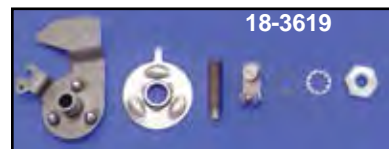
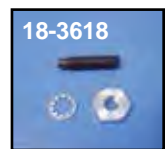

**1971-Early 84 XL Clutch Adjuster Parts Kit** includes parts illustrated. Other items available separately. Screw kit includes adjuster screw and nut only.

VT No.	OEM	Item
18-8155	Kit	Complete Kit
18-3619	37203-71A	Ramp Kit
	37202-71A	34920-71
18-2332	37202-71A	Inner Ramp
18-3618	31130-71	Adjuster Screw Kit
18-3650	34920-71	End Coupling
12-0903	11005	Snap Ring, 10 pack
12-0157	8860	Balls, 50 pack





# 1970 & Earlier XL Clutch

## 1970 and Earlier Clutch.

VT No.	#	OEM	Item
17-1111	4	8215	5/32 x 13/16 x 9/32 Rivet
18-3640	5	33162-67	Starter Ring Gear
17-1116	6	33379-57	Starter Ratchet 9T
18-2331	7	34897-53	Screw Retainer
18-1140	8	37201-54	Release Worm and Lever
18-1138	9	37210-47	Release Worm Cover
13-0137	10	37222-52	Worm Lever Spring
17-1158	12	37279-56	Release Rod Set 56-66 XL's 1967-69 XLCH
17-1157	12	37280-67	Release Rod Set 1967-69 XLH, 1970 XLCH
14-0125	15	37339-53	Release Rod Oil Seal
N/A	16	37345-52	Release Rod Oil Seal Ret.
12-0539	17	37526-56A	Clutch Hub Nut
12-0540	18	37527-67A	Clutch Hub Nut
17-0912	19	37533-52A	Clutch Hub Lockwasher
17-0090	20	37535-52	Clutch Hub Spacer
18-3157	21	37556-57B	Hub Assembly, 1957-69 XLCH
18-3161	21	37557-67	Hub Assembly, 1967-70 XLH, 1970 XLCH
18-3164*			Nuts for Above *Note: Required
12-0372	22	37568-67	Clutch Hub Bearing Inner Race
12-0510	23	37581-52	Large Hub Stud Nut
12-0574	24	37582-52	Small Hub Stud Nut
12-0551	24A		Nut Set 3 each, #23 & #24
18-8232	25	37584-64	Clutch Hub Stud (6) 1964-66
18-3123	25	37584-67	Clutch Hub Stud (6) 1967-70
17-0091	28	37721-54	Sprocket Hub Washer
12-0328	29	37722-52	Clutch Sprocket Needle Bearing
17-0020	30	37731-52	Washer, Sprocket Bearing, 0.0955" thick
17-0021	30	37732-52	Washer, Sprocket Bearing, 0.0975" thick
17-0022	30	37733-52	Washer, Sprocket Bearing, 0.0980" thick
17-0024	30	37735-52	Washer, Sprocket Bearing, 0.0925" thick
17-0023	30		Washer Sprocket Bearing, 0.1010" thick
17-0092	30		As Above Assortment, 1 each of above
14-0128	31	37740-57	Clutch Hub Oil Seal, Kick Start
14-0129	32	37741-67	Clutch Hub Oil Seal, Electric Start
18-3637	33	37760-52	Clutch Cover
15-0212	34	37762-52	Clutch Cover Gasket
18-3635	35	37876-52	Releasing Disc
18-1113	36	37985-52A	Friction Plate Raybestos (7)
18-1115	37	37992-52	Drive Plate (7)
18-1141	38	38013-52	Pressure Plate
18-1116	39	38016-52	Backing Plate
13-0140	40	38076-52	Spring (6)
18-3642	41	38101-52	Backing Plate, Spring Cup (6)
18-1139	42	38130-54	Adjusting Screw
12-0519	43	38135-50	Adjusting Screw, Locknut

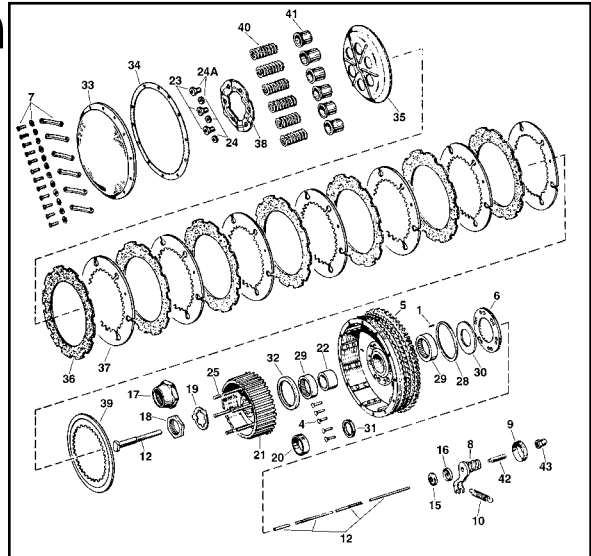
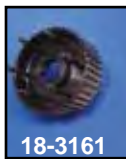
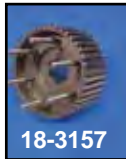

Assembly Order Illustration



### Clutch Rod Installation for 17-1166 and 17-1165. VT No.

Year	Models	VT No.
17-1158	1956-66 XLH	
	1967-69 XLCH	
17-1157	1967-69 XLH	
	1970 XLCH	



**Early XLH & XLCH Sprocket Cover.** Kick and electric with starter cut out. Replaces 34871-67B, kick only replaces 34782-57A on 1952-70 Sportsters. Complete cover assembly includes cover, release worm adjuster screw, nut, oil deflector, spring and kicker spring stud.

VT No.	Type
43-0114	Polished Kick & Electric Cover
43-0135	Polished Kick Cover Only
43-0136	Chrome Kick Cover Only
43-0115	Chrome Kick and Electric Cover
18-1211	Release Kit
8886-2	Stud, Chrome
8887-2	Stud, Cadmium

### Stock Sprocket Kick Starter Cover Screws

VT No.	Years	Type/Finish
8884-2	1954-70	Chrome
8885-2	1954-70	Cadmium
8886-2	1952-70	Pipe Mount Stud
8887-2	1952-70	As Above, Cadmium



**1952-67 XLCH Cast Sprocket Cover** features early Rib design, includes worm and hardware, replaces 34874-52A.

### VT No. 43-0133

**Rubber Cable Oiler Boot** replaces 38690-55, for XL 1955-80. 5 pack.

### VT No. 28-0401

**Replica Clutch Adjuster Sleeve.** Fits 1954-71, 7/16" hole levers. Zinc plated.

### VT No. 37-8460



### 1954-70 Clutch Release Kits. VT No. 18-1211

### 1954-70 Clutch Release Parts.

VT No.	OEM	Part
18-1211		Kit
18-1138	37210-47	Cover
18-1139	38130-54	Screw
12-0519	38135-50	Nut
18-1140	37201-54	Worm
13-0137	37222-52	Spring (10)



### 1952-70 Clutch Cable with adjuster.

VT No.	Item
36-0406	Cable Assembly
37-8460	Adjuster Only, Zinc
2576-1	Adjuster Only, Cadmium



# Clutch Set

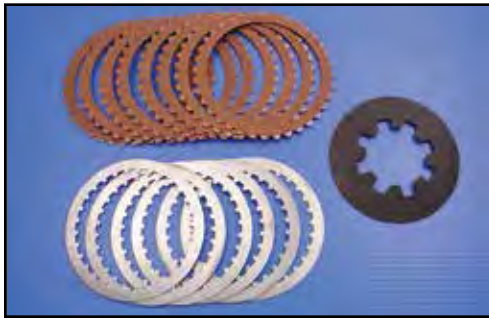

**Clutch Kit.** Heavy duty factory "wet" type for XL's complete kit includes our original bonded police clutch steel plates and spring plate.

VT No.	Year	Spring
18-1734	1984-90	Without
18-1735	1984-90	Without
18-3686	1991-up	With



York Patch.  
VT No. 48-1781



**Clutch and Spring Kit** includes 8 friction plates, 8 steel plates, spacer set and spring set. Fits 1971-E84.  
**VT No. 18-1150**



## Replica Clutch Sets.

VT No.	Year	Type	Set
18-1113	1952-70	Raybestos Friction	7 piece
18-1120	1971-84	Alloy Friction	8 piece
18-0155	1971-84	Kevlar Friction	8 piece
18-3651	1971-84	Steel Friction	8 piece
18-3263	1991-up	Steel Drive	6 piece
18-0154	1991-up	Kevlar Friction	8 piece



**Tamer Thrust Collar** fits 1971-84. Eliminates jerking and lunging while in gear. Works on belt and chain drive, replaces bearing thrust collar.

**VT No. 18-2323**



**Clutch Spring** for 1971-84, two piece type replaces 38079-72 and 38080-71 or as one piece heavy duty type.

VT No.	Item	Type
13-0141	2 piece	Stock
13-9204	1 piece	Heavy



**Clutch Adjusting Screws** sold each.

VT No.	Years	Model
18-1139	1952-70	XL and K
18-1213	1971-84	XL
18-3206	1985-94	XL
18-3242	1995-03	XL
18-3262	2004-up	XL

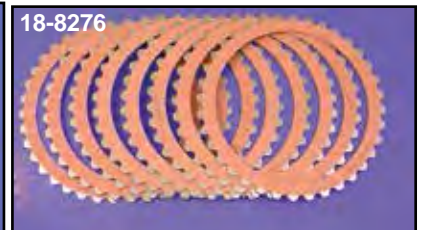
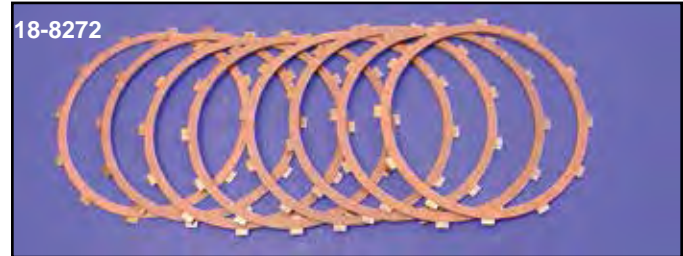

**Alto Clutch Sets.** Sold Kevlar or Red Eagle type. Both are bonded to steel.

VT No.	Year	Type
18-8271	1957-70	Red Eagle
18-8272	1971-83	Red Eagle
18-8273	1971-83	Kevlar
18-8274	1971-83	Red Eagle Outer Drive Plate, each
18-8275	1984-90	Red Eagle
18-8300	1984-90	Kevlar
18-8276	1991-up	Red Eagle
18-8299	1991-up	Kevlar



## Steel Sets.

VT No.	Year	Qty	VT No.	Year	Qty
18-8283	1957-70	7 piece	18-8285	1984-90	5 piece
18-8284	1971-83	8 piece	18-8286	1991-up	6 piece



**Clutch Spacer** for 1971-83. Set of 6 spacers to provide adjustment of pressure plate and adequate clearance on inside diameter of friction plates.

VT No.	Colony	Size	Type
18-1217*		1.525"	Barnett
18-1212	2756-12	1.530"	Stock
18-1214	2765-12	.040"	Under
18-1215	2775-12	.080"	Under

\*Note: Use with Barnett Clutch Plates SK3K (VT No. 18-1117).



**Clutch Hub Nuts** secure clutch hub to main shaft.

VT No.	Fits	Item
12-0539	1956-69	Nut
2738-4	1956-69	Kit
12-0540	1967-84	Nut
12-1967	1967-84	Kit
12-9915	1991-up	Nut

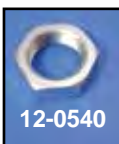





# Primary Chain



**Diamond Endless Primary Chains** with oval side plates.

VT No.	Year	Sprocket	Link
19-0362	1957-2003	34	94
19-0369	2004-up	38	96

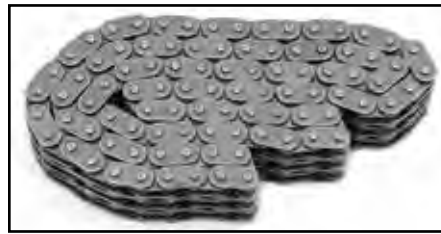

**Primary Chain** features endless construction, oval shape side plates. Fits 1957-2003 XL (35 x 3 x 94) for 34T sprocket.  
VT No. 19-0932

## Barnett Clutch Kit

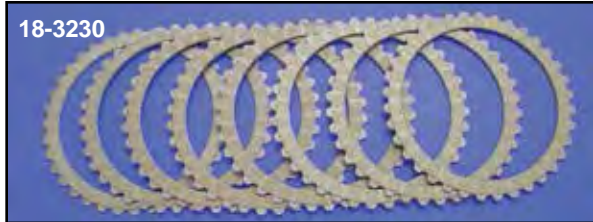

**Barnett Series K Kevlar Clutch Plates and Steel Plates** for Sportster. The ultimate in durability, smoothness and strength. Steel backed plates give smooth precise launches and shifting even under extreme heat. 100% asbestos free. Barnett friction clutch sets and steel plates, sold in sets only.



**Carbon Fiber Clutch Sets** for wet clutch by Barnett. Carbon fiber clutches feature excellent lubricity and very good energy absorption. Order steel plates separately.

VT No.	Year
18-3688	1971-84
18-3689	1984-90
18-3690	1991-up
18-3691*	1991-up

\*Note: Consists of nine friction plates and eight steel drive plates. Add 12% more surface area. Double steel drive plate is not used.

VT No.	Year	Type	U/M
18-1115	1952-70	Steel	7
18-1116	1952-70	Steel	1
18-1117	1971-84	Friction	8
18-1118	1971-84	Steel	8
18-1119	1971-84	Alloy	7
18-3665	1984-90	Friction	7
18-8248	1984-90	Friction	7
18-1146	1984-90	Steel	5
18-3230	1991-up	Friction	8
18-3231	1991-up	Steel	6
18-3233	1991-up	Extra Plate	3

.047 Thick wit key hole slots  
 Backing Plate  
 Wet Only Supplied with Spacers  
 Inner/outer slots keep plate flat and true  
 Bonded one side outer drive plate  
 Kevlar bonded  
 9 Friction 8 Steel Plates, adds 14% surface area.  
 Kevlar bonded  
 Re-use stock double riveted drive plate  
 Extra Plate Consists of 9 Kevlar Friction, 8 Steel Plates. Adds 12% more surface area, double riveted drive plate not used.



**Barnett Scorpion Clutch Kit** features over twice as much friction surface area compared to stock clutch. Scorpion Clutches provide a positive engagement and release. The kit incorporates six heavy duty coil springs. In addition, an extra spring rate is included which allows the clutch to be tuned for street or race application depending on usage. Tunability is easy without removal of the primary cover. Barnett friction plates are compatible with any primary oil. Each kit is designed to be used with stock type clutch basket.



**1971-84 Barnett Friction Plate Set.** Original compound.  
VT No. 18-3122



**Clutch Springs.** Stock type are sold as sets.

Fits 1971-84

VT No.	Brand	Quantity
13-0141	V-Twin	2
13-9204	Heavy Duty	1
13-2007	Sifton	1



Fits 1952-70

13-0140	V-Twin	6
13-9254	Barnett	6



VT No.	Fits
18-3722	1971-83
18-3732	1984-90
18-3742	1991-up



**Pro-Clutch**

VT No.	Item
20-0211	1991-up Chain
16-0310	Puller Tool





V-Twin Chain is 120 links by 530.

VT No.	Finish	Type
19-0723	Nickel	STD
19-0725	Nickel	STD
19-0726	Parkerized	STD
19-0457	Natural	Heavy Duty
19-0458	Natural	O-Ring
19-0823	Silver	O-Ring
19-0824	Nickel	O-Ring



"530 QR" Solid Roller Chains is an economical, high quality, solid roller chain.

QR	Size
19-0512	108
19-0513	110
19-0514	112
19-0515	120
19-0559	130

530 Sigma O-Ring Chain with 10,600 lbs. tensile strength, features heavy-duty, wide-waist link plates for increased durability.

Standard		Standard	
S Series	Size	S Series	Size
19-0540	102	19-0545	112
19-0541	104	19-0554	130
19-0542	106	19-0555	150
19-0543	108		



530 HSL Tsubaki is a virtually maintenance free chain that has heavy duty shot-peened side plates sintered metal bushings and quad-staked riveting.

HSL	Size
19-0528	110
19-0529	112
19-0530	120
19-0531	Connecting Link



## Diamond Rear Chain



530 Standard Diamond is the mainstay of the motorcycle chain.

VT No.	Links	VT No.	Links
19-0320	100	19-0327	108
19-0321	102	19-0324	110
19-0322	104	19-0325	112
19-0323	106	19-0326	120



530 XDL Self Lube eliminates the possibility of hit and miss lubrication, as it has a constant and consistent lubrication in the pin bushing (wear) area.

VT No.	Link	VT No.	Link
19-0330	100	19-0334	108
19-0331	102	19-0335	110
19-0332	104	19-0336	112
19-0333	106	19-0337	120



530 XLO Diamond O-Ring Chain includes a .214 pin which has been produced using a special alloy steel and case hardened for optimum strength.

VT No.	Links	VT No.	Links
19-0349	108		
19-0354	102	19-0357	110
19-0355	104	19-0358	112
19-0348	106	19-0398	120



530 Diamond Nickel Plated Chain offers rust-proof protection along with a nickel finish. Each part of the nickel plated chain is individually plated before assembly Size 50ENP.

VT No.	Links	VT No.	Links
19-0340	100	19-0344	108
19-0341	102	19-0345	110
19-0342	104	19-0346	112
19-0343	106	19-0347	120

Master Links. Replacement link for #50 530 chain. Note: sold in 10 packs unless noted otherwise.

VT No. Fits Chain Type

19-0350	Standard
19-0351	Nickel
19-0375	XDL Self Lube
19-0353	XLO O-Ring, each
19-0376	N.O.S. Repair Link with 2 Masterlinks OEM, 40052-15

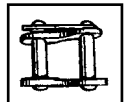

Rear Chain Tensioner by LBV reduces chain vibration and frequency of adjustment by utilizing a durable urethane roller which revolves on sealed bearings mounted on chrome anchor plates.

VT No.	Year	Model
19-0432	1957-up	XL-XLH
19-0436	Roller only	For Above





# Rear Sprocket



**Chrome 5-Spoke Sprockets.** Offset models have 9.8 mm offset. **Note:** Offset is measured from sprocket bolt mount surface to center line of teeth as shown.

Offset	Flat	Teeth	Fits
19-0672	19-0674	48	1986-99
19-0673	19-0675	51	1986-99
19-0218	19-0251	48	2000-up
19-0250	19-0221	51	2000-up



**1979-81. Rear Sprockets.** Replaces 41470-73. Used on 1979-81 XL, XLCH & XLS, cast or wire wheel. Dish type sprocket with 9.8mm offset.

Zinc	Chrome	Teeth
—	19-0047	43
—	19-0049	44
—	19-0032	45
19-0048	19-0033	46
—	19-0035	47
—	19-0037	48
—	19-0039	49
19-0040	19-0041	51

**1982-92.** Chrome finish. Offset types have 6 mm offset.

VT No.	OEM	Teeth	Type
19-0042	41470-82	48	Offset
19-0043	41464-81	51	Offset
19-0120	41470-78	48	Flat
19-0124	—	49	Flat
19-0121	41464-86	51	Flat

**Note:** VT No. 19-0120, 19-0124, 19-0121 are flat. 19-0042, 19-0043 have 6.0mm offset. 19-0032 through 19-0048 have 9.8mm offset.



**Chrome Lazer Style Sprockets** feature milled center design and 9.8 mm offset fit 1979-81. Flat fits 1986-up.

Offset	Flat	Teeth
19-0129	19-0132	48
19-0130	19-0133	49
19-0131	19-0134	51

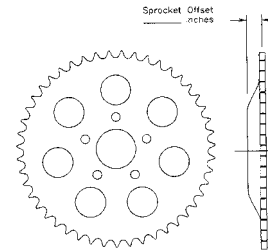

**Note:** Sprocket offset measured from bolt mount surface to center of teeth.

**Rear Sprocket Kits** for brake drums with rivet on sprockets. Includes rivets and dowels. Fits 1952-78. 51 tooth. Replaces 41470-70.

VT No.	Item
19-0011	Kit
19-0114	Rivets



# Transmission Drive Sprocket

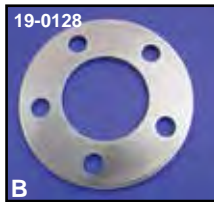

**(A) Offset Sprockets** fit models which allow use of a 150 series tire, order rear sprocket **(B) spacer** separately.

VT No.	Teeth	Speed	Year
19-0419	19	4	1984-90
19-0409	21	4	1984-90
19-0410	22	4	1984-90
19-0421	19	5	1991-up
19-0422	20	5	1991-up
19-0128	Spacer 3/16"		

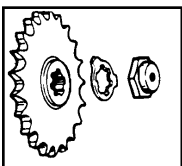

**Drive Sprocket Nut Kit** includes lock tab. VT No. 12-0529 includes seal in nut.

VT No.	OEM	Years
12-0529*	35047-53	E1953-70
12-0530	35047-71A	1971-E84
12-0566*	7855W	1984-90
20-0308	35211-91	1991-up
17-0910	Lock Tab	1952-E84

\*Note: Does not include lock tab.



**Transmission Sprockets.** 19-0589 has offset for 200 tire.

1952-78	1979-83	1984-90	1991-up	# of Teeth
Type A	Type A	Type B	Type C	
19-0125	—	—	—	18
19-0090	—	—	19-0446	19
19-0091	—	19-0072	19-0383	20
19-0092	19-0096	19-0063	19-0384	21
19-0093	19-0097	19-0064	19-0385	22
19-0589	19-0589	—	—	22
19-0094	19-0098	19-0073	19-0386	23
19-0095	19-0099	—	—	24



**Offset Transmission Drive Sprockets** fit 1991-up XL's with chain drive conversion. **.500" Offset Counter Shaft Sprocket**

VT No.	Teeth
19-0164	22
19-0402	23
19-0122	24

**.810" Offset Counter Shaft Sprocket**

VT No.	Teeth
19-0214	22
19-0215	23
19-0216	24

**Oil Seal & Retainer Kit.** Metal retainer with seal. Replaces 35150-52, includes gasket and screws. Fits all 1952-E84.

VT No.	OEM	Item
17-1160	Complete	Kit
15-0190	35169-52	Gasket
14-0118	35151-52	Seal

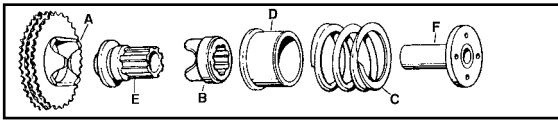

**Compensator Sprocket Components.** Fits 1957-76 XL.

VT No.	#	OEM	Item	Year
19-0437	A-F	—	Complete Kit	1967-74
19-0438	A	40273-67	34T Sprocket	1967-76
19-0439	B	40297-57	Cam Extension	1957-76
13-9238	C	40302-55A	Spring	1957-76
19-0440	D	40325-57	Sleeve	1957-76
19-0441	E	40376-57	Shaft Extension	L1957-E74
19-0443	E	40377-74	Shaft Extension	1974-76
19-0442	F	40386-57	Nut	1957-76

# Motor Sprocket



**Note:** 2004-up models requires purchase of sprocket/alternator rotor assembly

**\*Note:** Rotor Assembly

## XLCH Motor Sprocket.

VT No.	OEM	Years	Teeth
19-0009	Special	1957-76	23
19-0123	40288-58	1954-69	34
19-0067	40235-70A	1970-76 XLCH 1976-78 XLH	34
19-0381	40235-74	1977-78 XLCH 1979-90 All XL	34
32-0030*	32493-02A	2004-up	34
19-0451	40241-02	2004-up	34
<b>Nuts</b>			
12-0502	8025	1957-69	Nut
12-0505	40387-70	1970-88	Nut
12-0149	7652	1989-up	Nut
10-0460	40240-89	1989-up	Spacer



# Primary Chain Adjuster

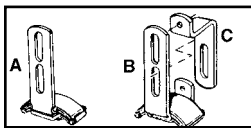

**Chain Tensioner** includes pad and clip replaces 39975-54A on 1957-69 XLCH models or 39975-54B on 1971-76 XLH-XLCH includes 39980-54 brace.

VT No.	OEM	Item
18-3155	39975-54A	(A)
18-3156	39975-54B	(B-C) 2 piece
18-3228	39980-54	(C) Offset Bracket



**Primary Chain Nylon Adjuster Pads** for 1957-76.

VT No.	OEM #	Years	Model
28-0224*	Kit	1957-76	XLH-XLCH
28-0227	39978-58A	1957-76	XLH-XLCH
18-3643	39979-58		Retainer For Above

**\*Note:** Includes metal retainer 18-3643.

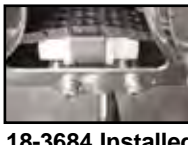

**York Self Adjusting Chain Tensioner** fits 5 speed models with wet clutch. Replaces factory type detent adjuster shoe assembly. Tensioner kit includes all hardware and instructions for complete conversion. Fits 1991-up.

**VT No. 18-3684**

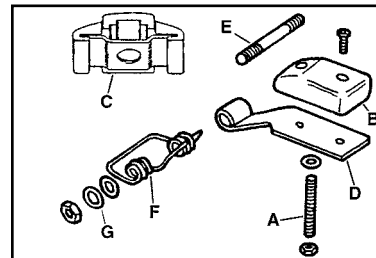

**Primary Adjuster Shoe Kit** for 1977-up.

VT No.	#	OEM	Year	Item
18-3220		Kit	1977-85	All Shown
18-3249		Kit	1986-90	As Above
18-3221	A	3250	1977-90	Adjuster
18-0250	C&A	39975-90A	1991-2001	Pad & Adjuster
18-0119		40039-02B	2002-up	Pad & Adjuster
28-0226	B	39966-80	1980-90	Pad
18-3222	D	39973-86	1977-90	Carrier
12-1186	E	40018-77	1977-85	Stud
12-2121	E	40018-86	1986-90	Stud
13-9163	F	40019-80A	1977-85	Spring
13-9164	F	40019-86A	1986-90	Spring
37-0588	G	6033	1977-85	Copper Washer

**Note: For descriptive purposes  
XL= For Sportster**

XL





# Rear Pulley



## Rear Drive Pulley.

VT No. # of Teeth Finish

Year	VT No.	# of Teeth	Finish
1991-99			
20-0376	61	Chrome	
20-0764	61	Natural	
2000-06			
20-0377	61	Chrome	
20-0765	61	Natural	
2004-06			
20-0379	61	Chrome, 18 Spoke	
20-0767	61	Natural	
2007-up			
20-0378	68	2007-up Chrome, 5 Spoke, 1"	
20-0766	68	2007-up Natural, 1"	



## Rear Pulley Cover.

VT No.	Year	Teeth	Finish
42-0670	1991-03	61	Chrome
42-0934	2004-up	68	Chrome
42-7512	2004-up	68	Chrome
42-1132	2004-up	68	Black



# Rear Belt



Note: There is no warranty on belts sold as part of kit or individual replacements.



**Pulley Lock Tool** fits 1991-up XL. VT No. 16-0588

Final Drive Belts for XL's by Carlisle, BDL and Gates.

Carlisle Dayco	BDL	Width	Tooth/Model
20-3999	—	20-0456	1.125" 125T XL Ratio Change
20-4000	—	20-0060	1.125" 128T 1991-92 XL 883
Deluxe XL 1200, 1993-03 All XL and 1986-92 XL Rear Belt Conversion Kit			
20-4001	—	—	1.125" 133T 1993-2003 XL Ratio Change
—	—	20-4004	1.125" 136T 2004-06 883 XL
—	20-0688	—	1.125" 137T 2004-06 1200 XL
—	20-4005	—	1.000" 136T 2007-10 883 XL
20-4003	20-0788	—	1.000" 137T 2007-up 1200 XL 2011-up XL

**Pulley Indexing Flange Nut** allows drilling and tapping of additional set screw locations. Fits 1991-up XL.

VT No.	Type
20-0215	Belt
20-0324	Chain

# Chrome Pulley/Sprocket Bolt Kit

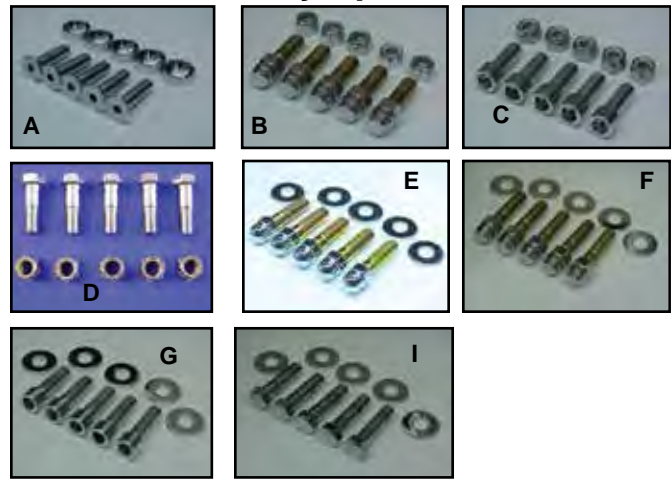

Year	Wheel Type		Drive Type		#	Style	Nuts/Washer	
	Cast	Spoke	Belt	Chain				
1979-91	9857-10		*	*	A	Collar		
1979-91		9856-15	*	*	A	Collar	*	*
1979-91		8836-10	*	*	A	Acorn		
1979-91			*	*	B	Cap	*	
1979-91		8834-10	*	*	C	Allen	*	
1979-91		37-8131	*	*	D	Hex	*	
1979-up			*	*	E	Acorn		*
1979-up			*	*	F	Cap		*
1979-up	8835-10		*	*	G	Allen	*	*
1979-up	9608-10	9609-15	*	*	H	Dome	*	*
2000-up	2053-10	2053-10	*	*	I	Hex		*

# Front Pulleys



**Final Drive Front Pulleys** for 1986-up 5 Speed models as supplied by V-Twin or BDL. All BDL pulleys are 1/3" lighter than stock and include spacer, seal, lock plate and screws. Stock Size Pulley Noted by \*

Teeth	V-Twin	BDL	Year
27	20-0328		1986-90
28		20-0650	1991-03
29	20-0526*	20-0651*	1991-03
29	20-0341		2004-up
30		20-0652	1991-03



**29 Tooth Front Drive Pulley** features offset. 1991-03  
VT No. Offset  
20-0512 .750"  
20-0648 1.00"



**Front Belt Lock Plate and Nut Kit** includes 2 allen screws, sprocket lock nut and lock plate. Fits 1991-up XL models.

VT No.	Item
20-0308	Kit
17-0934	Lock Only
12-0579	Nut Only
37-0429	Set Screw

Note: For descriptive purposes XL= For Sportster



# Sprocket



**Offset Transmission Drive Sprockets** fit 1991-up XL's with chain drive conversion. Order flange nut separately.  
**.500" Offset Counter Shaft Sprocket**

VT No.	Teeth
19-0164	22
19-0402	23
19-0122	24
20-0324	Nut



**Chrome 5-Spoke Sprockets.** Offset models have 9.8 mm offset. **Note:** Offset is measured from sprocket bolt mount surface to center line of teeth as shown.

Offset	Teeth	Fits	Part No.	Material	Year
19-0672	48	1986-99	19-0250	51	2000-up
19-0673	51	1986-99	23-0320	Shim	1986-99
19-0218	48	2000-up	20-0346	Shim	2000-up

## Rear Chain Conversion Sprocket



**Sprocket Kit** for converting 1991-up XL models to chain drive. Includes 120 link chain, front and rear sprockets.

VT No.	Front Tooth	Rear Tooth
19-0761	23	51

## Rear Belt Guard



**Chrome Guard/Rear Pulley/Dress Up Kit** includes belt guards, upper and lower, and rear pulley cover for 5-Speed belt drive models with hardware.

VT No.	Year	Pulley
27-0541	1991-99	61 Tooth
27-0542	2000-03	61 Tooth
27-0619	2004-up	68 Tooth

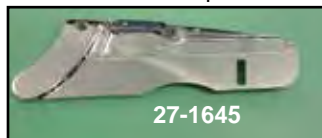

**Chrome Lower Belt Guard.**

VT No.	Year
27-1645	1991-2003
27-0788	2004-up
20-0784	2004-up



**Chrome Belt Guards.**

VT No.	Year
27-1667	1991-99
27-0123	2000-03
27-1745	2004-up
27-0862	2004-up





# Shifter Lever



**Chrome Shifter Lever Assemblies** include cats paw shifter peg. 21-0571 has smooth bore.

VT No.	Year	VT No.	Year
21-0571	1957-70	21-0575	1977-85
21-0572	1957-70	21-0576	1986-90
21-0573	1971-74	21-0577	1991-2003
21-0574	1975-76	21-0579	2004-up



**Shifter Lever** fits 1991-up 5-Speed.  
**VT No.** **Year**  
 21-0550 1991-2003  
 21-0387 2004-up  
 21-0590 1991-2003  
 Black with highlighted aluminum



**Chrome Shifter Levers. Note:** 21-2013 & 21-0301 have smooth bore. (A) type requires use of long stud shifter footpeg as hole is not threaded.

VT No.	#	Year
21-2013	A	1952-70
21-0310	A	1952-70
21-0301	B	1971-74
21-0314	B	1971-74
21-2034	C	1975-76
21-0304	D	1977-85
21-2012	E	1986-90
21-0643	E	1986-90
21-2032	F	1991-03
21-0578	H	2004-up



**Heel to Toe**  
 21-0584 2004-up  
 21-0823 1991-03

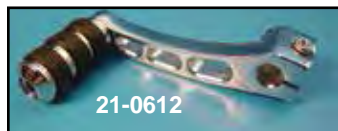

**Chrome Billet Shifter Lever and Footpeg Kit** includes arm and cats paw shifter footpeg.

**VT No.** **Year**  
 21-0612 1991-03  
 21-0614 2004-up

## Shifter Pegs



**Chrome Diamond Shape Shifter Peg** includes diamond shape rubber insert and short stud (1/2").  
**VT No.** 21-0260

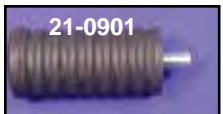

**Stock Rubber Shifter Pegs** are in long or short stud. The 7/8" long stud is used when the lever is unthreaded and stud accepts a nut. Short 5/8" thread screws into lever.

VT No.	Color	Type
21-0901	Black	Short 1/2"
21-0902	White	Short 5/8"
21-0903	Black	Long 7/8"
21-0908	Black	Long 7/8"
21-0904	White	Long 7/8"



**Shifter Footpegs** are the short stud type.

VT No.	#	Type
27-1633	A	Railer
21-2025	B	Cats Paw
21-1665	C	Cats Paw, extended
21-0407	E	Chrome Cap
21-0640	F	O-Ring (Rotates)
21-0402	F	O-Ring
21-0872		Skull Shifter



# 2004-up Forward Control Set

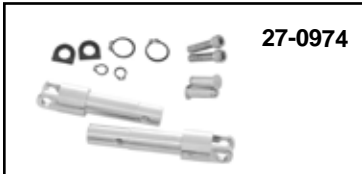

**Forward Control Peg Adapters** allow use of male pegs on OE style forward controls.  
**VT No. Type**  
**27-0974** Stock  
**27-0999** +2"

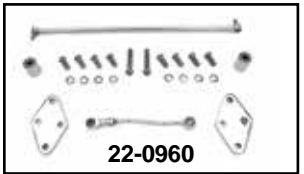

**Reduced Reach Forward Control Adapter Kit** fits XL. Brings forward controls closer to rider.  
**VT No. Years**  
**27-1731** 2011-2013  
**22-0960** 2014-up

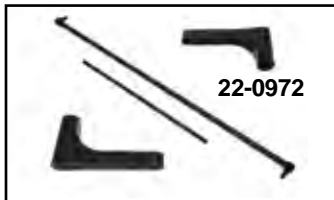
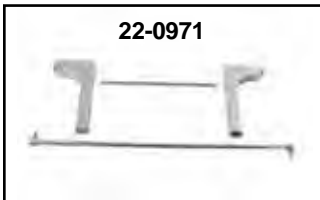

**Extended Reach Forward Control Conversion** for 2004-13 XL forward controls, to move 6" forward.  
**VT No. Finish**  
**22-0971** Chrome  
**22-0972** Black

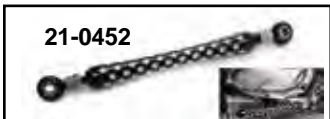
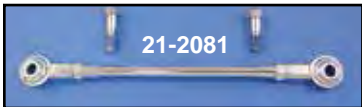

**Shifter Linkage** fits 2004-up XLC models with forward controls.  
**VT No. Style**  
**21-2081** Round SS  
**21-2087** Maltese  
**21-0452** Black Hole  
**21-0453** Black Talon



**2004-up Forward Control Set** includes brake pedals and mount plates as shown. 22-0731 includes soft peg set.

VT No.	Type	Type	Year
22-0721	Without Footpegs	Stock	2004-05
22-0731	With Footpegs	Stock	2004-05
22-0900	Chrome w/Footpegs	Stock	2006-13
22-0799	Black w/Footpegs	+2"	2004-13
22-0456	Chrome w/o Footpegs	Stock	2014-up
22-0457	Black w/o Footpegs	Stock	2014-up

**Hardware for Above**

- 21-0787 Shaft Arm
- 23-0856 Brake Rod



**2004-up Chrome Forward Control Footrest Support** fits XLC models with forward controls.  
**VT No. Item**  
**27-0010** Support  
**21-0746** Footpeg Yoke

**Note: For descriptive purposes XL= For Sportster**





# 1991-2003 Forward Control Kit



22-0766  
Left Side  
Shift



22-0769  
Installed  
Right



22-0766 Right  
Side Brake



22-0769  
Installed  
Left



22-0769  
Left



Right  
22-0769

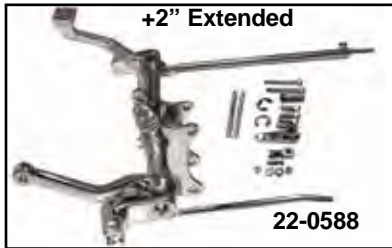

+2" Extended

22-0588

**Chrome Forward Control Kit** for XL models, featuring XLC styling. Kit includes Cats Paw™ Foot and Shifter Pegs. 22-0718 & 22-0588 order pegs separately.

**Chrome Billet Forward Control Kit.** Master cylinder included. Order brake line and related parts separately.

VT No.	Item	Year
22-0769	Kit	1986-03
22-0828	Kit	2004-13
23-0688	Brake "T"	
23-8060	21" Line	
23-0612	10 mm Bolt	
23-4047	Straight Banjo	
23-4051	90° Banjo	

VT No.	Item	Years	Speed
22-0766	Control Kit with pegs	1986-90	4
22-0719	Control Kit with pegs	1991-2003	5
22-0718	Control Kit without pegs	1991-2003	5
22-0588	Control Kit +2" without pegs	1986-2003	4/5
27-1582	Foot Peg Set	All 1991-03	
21-2025	Shift Peg	All 1991-03	
23-0465	Brake Pedal	All 1991-03	
21-0830	Shifter Arm		

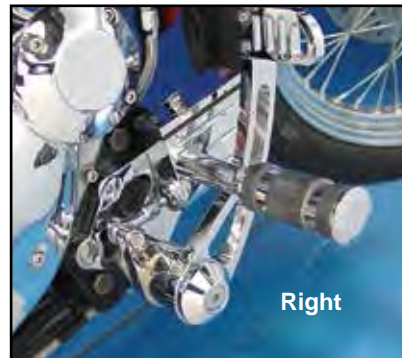

Right

**1986-03 Billet Forward Control Kit** features Big Twin style controls. Order related brake parts separately. **Will not work with stock exhaust.**

VT No. 22-0790



22-0785



22-0797



Left

**Brake Related Parts for 22-0790.**

VT No.	Item
23-4279	90 degree Fitting
23-8342	36" Hose
23-0571	"T"
23-0426	Switch
23-8362	16" Hose
23-4050	Banjo
23-3005	Master Cylinder
23-0859	MC Rebuild
23-0773	Plunger

**Billet Forward Control.**

**Black Polish Fits**  
22-0784 22-0785 883 1991-2003 XL  
22-0796 22-0797 883 2004-13 XL



# Forward Control for 1957-2003



22-0962

22-0962



22-0957



22-0957



22-0958

**2014-up Forward Mid-Control Kits** slightly forward than stock for comfort.

- |               |  |
|---------------|--|
| <b>VT No.</b> | <b>Item</b>                                      |
| 22-0460       | 1986-2003, Mid Forward Control, Chrome           |
| 22-0461       | 2004-up, Mid Forward Control, Chrome             |
| 22-0957       | Forward Control Kit, Chrome                      |
| 22-0958       | Forward Control Kit, Black                       |
| 22-0961       | Mid Forward Control Kit with floorboards, Chrome |
| 22-0962       | Mid Forward Control Kit with floorboards, Black  |

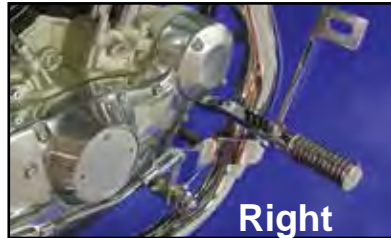

Right



Left

**883-1000-1100-1200 Forward Control Kit** for Sportster models with alternator. Includes chrome brake and shifter assemblies, complete with all necessary brackets, pedals, linkage, O-Ring pegs and hardware for installation. Use existing master cylinder for assembly.

- |               |              |                      |
|---------------|--------------|----------------------|
| <b>VT No.</b> | <b>Year</b>  | <b>Model</b>         |
| 22-0395       | 1984-85 only | 4-Speed              |
| 22-1048       | 1986-90      | 4-Speed              |
| 22-0396       | 1991-2003    | 5-Speed              |
| 22-0383       | 1991-2003    | 5-Speed without pegs |



21-2014

21-2018

21-2052

22-1046

### Replacement Parts.

- |               |                                   |
|---------------|-----------------------------------|
| <b>VT No.</b> | <b>Item</b>                       |
| 23-9202       | Brake Pedal only                  |
| 22-1046       | Bracket Only                      |
| 21-2058       | Shift Foot Lever only             |
| 21-2014       | Shift Lever Arm, 5 Speed          |
| 21-2018       | Inner Shift Lever, 5 Speed        |
| 21-2052       | Two Piece Shift Arm, 4 Speed      |
| 21-0957       | Shifter Arm Extension             |
| 21-0956       | Shifter Pedal Mount               |
| 21-0402       | Shifter Peg                       |
| 27-1580       | Footpegs                          |
| 22-0451       | Jockey Clutch Pedal Shaft, chrome |



21-2058

**Front Motor Mount Bolt Kit.** Stock length kits include chrome spacers and washer. Extra length kit are bolts only and do not include spacers. Use extra length kit for installing forward controls or hiway bars. Fit 1957-84.

- |               |                 |              |
|---------------|-----------------|--------------|
| <b>VT No.</b> | <b>Type</b>     | <b>Style</b> |
| 7141-18       | Stock           | Acorn        |
| 37-9207*      | Stock           | Hex          |
| 9797-20       | Stock           | Allen        |
| 7408-10       | Extra long      | Acorn, 7.5"  |
| 7408-10T      | Extra long      | Acorn, 7.5"  |
| 37-9086       | Chrome          | Spacer Set   |
| 37-9158       | Washers, 4 pack | Locating     |

\*Note: Does not include spacers

7408-10T



Left



Right



VT No. 22-0700



VT No. 22-0701

**XLH-XLCH Forward Controls** are chrome plated and complete as pictured for right and left sides for 1957-78 models with mechanical brakes. Purchase longer motor mount bolts separately. Note: Front Pipe may have to be indented for clearance.

- |               |             |              |              |
|---------------|-------------|--------------|--------------|
| <b>VT No.</b> | <b>Fits</b> | <b>Brake</b> | <b>Shift</b> |
| 22-0700       | 1957-74     | Left         | Right        |
| 22-0701       | 1977-78     | Right        | Left         |

### Replacement Part for 22-0701

- |               |              |
|---------------|--------------|
| <b>VT No.</b> | <b>Item</b>  |
| 22-0375       | Chrome Brake |



Brake Side



Shift Side



22-0391

**Daniel Boone Forward Controls** fit models as listed. 1977-78 models are cable operated and include cable. 22-0391 includes master cylinder and stainless brake line.

- |               |             |              |              |                   |
|---------------|-------------|--------------|--------------|-------------------|
| <b>VT No.</b> | <b>Fits</b> | <b>Brake</b> | <b>Shift</b> | <b>Brake Type</b> |
| 22-0391       | 1979-83     | Right        | Left         | Hydraulic         |
| 21-0923       | 1957-74     |              |              | Lever             |



27-1519

27-1520



21-0671

**Brake Pedal** can be used as a replacement for Daniel Boone or Davey Crocket controls. The 3/8" - 16 threaded stud can also be used as rigid mount foot pegs.

- |               |                |            |
|---------------|----------------|------------|
| <b>VT No.</b> | <b>Item</b>    | <b>U/M</b> |
| 27-1519       | Rubber Covered | Set        |
| 27-1520       | O-Ring         | Set        |
| 21-0671       | Cats Paw Peg   | Each       |





# 1980-up Rear Brake Part



**Chrome Brake Pedal**  
includes bushing.  
**VT No. Year**  
**23-0401** 1980-2003  
**23-0680** 2004-up



**Chrome Pedal and Master Cylinder Cover Kit** includes pedal, cover, plunger and mount hardware. Fits 1982-2003.  
**VT No. 23-0672**



**Brake Pedal Dress Kit** includes pedal and reservoir cover. Fits 2004-07 XL.  
**VT No. 23-0962**



**Sprocket Cover Hardware.** Fits XLS-XLH.

VT No.	OEM	Years	Item
23-3024	34866-86A	1986-90	Mount Stud
23-3015	42441-80	1980-90	Pivot Stud
23-3079	42441-90	1991-up	Pivot Shaft
23-1728	34909-83	1983-90	M.C. Support Bracket
23-3080	34933-96	1991-2003	M.C. Support Bracket



**Rear Brake Lines**  
for Sportster, master cylinder to TEE, rear hose is rubber with chrome STEEL end from TEE to rear caliper.

VT No.	OEM	Item	Years
23-0696	44437-77	Tube	1979
23-0729	42484-81	Tube	1981-85
23-2310	44438-87B	Hose	1987-03
23-8076	Braided	Hose	1987-03 (Stainless Steel)

\*Note: Single piece hoses, use this line only.

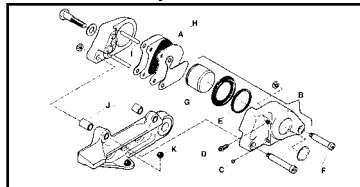

**Rear Caliper Parts** for 1979-81.

VT No.	#	OEM	Item
23-9239		Assembly	Caliper, Chrome
23-1746	F	44175-77 44176-77	Screw Set
23-0414	I	44186-77	Caliper Pins, 10 pack
23-9199	H	44182-77 44185-77	Plate, Inner Plate, Outer
23-2276	E	44152-77 44180-77	Seal Kit
23-0510	A	43395-80	Pad Set
23-2280	G	44181-77A	Caliper Piston
23-1731	D	44146-77	Bleeder
23-9198	C	44141-77	Brake Hose Seat
23-0135	J	45861-79 45862-79	Bushing, Set
28-0718	K	44199-79	Rubber Bumper

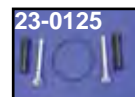
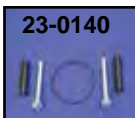

**Rear Caliper Bolt Set.**

VT No.	Fits	Finish
37-0508	1982-E87	Chrome
23-0140	L1987-99	Chrome
23-0125	L1987-99	Black
2081-3	2000-2003	Chrome

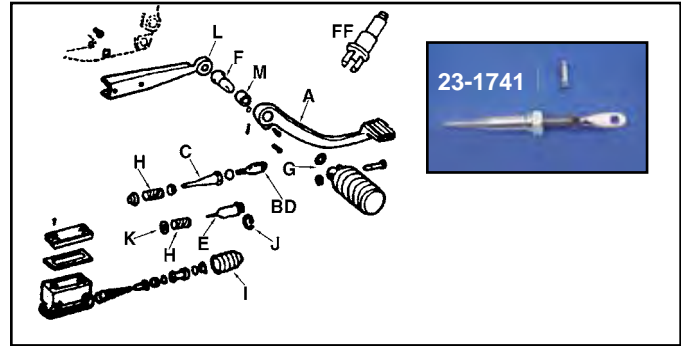

**Rear Brake Pedal & Components** fits 1980-2003.

VT No.	#	OEM	Item
23-0401	A	42459-80B	1980-2003 Pedal
23-0405	A-1	542400-80	Pin for Pedal
23-1741	B	42445-80A	1980-2003 Rod End and
	C	42448-80	Plunger Assembly
23-1986	B&D	—	Rod End with Pin
23-3016	B	42445-80A	1980-E87 Rod End only
23-9173	B	42437-87	1987-up Plunger Rod End
23-3017	E	42448-82A	1982-E87 Plunger
23-3015	F	42441-80	1980-90 Pivot Shaft
23-3079	FF	42441-90A	1991-03 Pivot Shaft with Clevis
12-0972	G	11093	1980-89 Pivot Retainer
13-9165	H	40920-79	1980-84 Return Spring
13-9166	H	40920-82	1984-E87 Return Spring
28-0505	I	40922-79	1979 Pushrod Boot
12-0971	J	40918-82	1984-up Retaining Ring
23-1758	K	44126-82	1982-up Washer, Spring
23-1728	L	34909-83	1983-90 Bracket
23-3080	L	34933-96	1991-03 Bracket, Chrome
10-1256	M	42443-80	1980-up Bushing

## Caliper Insert



**Chrome Brake Caliper Inserts** are easily installed with double face tape supplied. Sold each.

VT No.	Diameter	Fits	Type
37-8968	1.80"	1987-99	Hayes Rear
37-8969	1.47"	1984-99	Front
		1982-E87	Girling Rear
37-8970	1.40"	1977-83	Dual Disc Front
		1972-84	Banana Rear
		1977-81	Rear



**Rear Caliper Pistons.** \*Note: Includes seal kit.

VT No.	Year
23-2280	1979-81
23-2281	1982-86
23-1999*	1987-99
23-0532	2000-03
23-0275*	2004-13
23-0290	2014-up



**Rear Caliper Seal Kits.**

VT No.	Year
23-2276	1979-81
23-2277	1982-86
23-9022	1987-99
23-0533	2000-03
23-0276	2004-13
23-0293	2014-up



# Rear Caliper

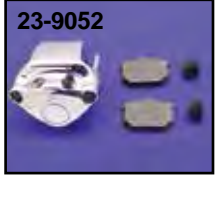
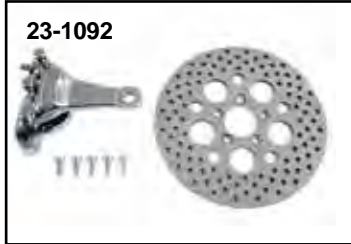

**Chrome Rear Caliper Kit** fits XL models and includes complete chrome replica 4-piston caliper assembly with pads and polished stainless steel drilled brake disc with chrome mount bolts.

VT No.	Year	2004-up	
23-1150	2005-up	23-0680	Rear Pedal
23-1097	2004	21-0578	Chrome Shifter Lever
23-1092	2000-2003	27-0817	Footpeg Support Left Side
22-0369	1987-1999	23-0780	Footpeg Support Right Side
22-0366	1982-1986		



**Rear Caliper Kits** include GMA Caliper with bracket and either a polished or standard 11½" stainless steel rotor with mount bolts. Use with 5/8" master cylinder.

Polished		Standard Fits	
22-0361	22-0354	1979-81	
22-0362	22-0355	1982-Early87	
22-0363	22-0356	Late1987-99	

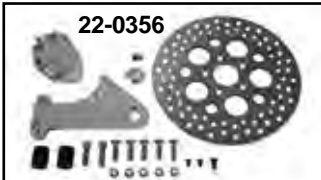

**Chrome Bracket for Calipers** are sold separately. Replaces 40929-87. Fits L1987-99.

VT No. 23-9047



**Vibration Shims** fit rear pads.

VT No.	OEM	Year
23-9238	41665-82	1982-86
23-0137	43959-86	1987-99
23-0147	44337-00	2000-03
23-9268	42521-04	2004-13



**11.5" Chrome Caliper Kit** fits XL's Rigid frames with 3/4" rear axle. Kit includes polished 11.5" disc, bolts, chrome 4-piston caliper complete with integral bracket and weld on frame tab for left side. VT No. 22-0370

**Rear GMA Billet Aluminum Brake Calipers** are machined from billet aluminum and clear anodized. Feature dual pistons which are internally connected, brake pads and brackets, when provided. Include spacers and hardware necessary for installation. Hoses and brake disc not included. Use 5/8" bore master cylinder.

VT No.	GMA	Model
23-4519	203	1979-81 XL
23-9208	204	1982-Early 87 XL
23-9209	205	Late1987-99 XL with banjo bolts

**GMA Components.**

23-4520	PA2	GMA Caliper Piston, pair, fits 23-4519, 23-9208, 23-9209
23-4510	RB1	Caliper O-Ring Seal Kit fits ,23-4519, 23-9208, 23-9209
23-4514	B-Pad	SBS Brake Pad Set fits Calipers: 23-4519, 23-9208, 23-9209
23-9936	R79FXL	GMA Floating Brake Disc1979-99 Rear





# 1952-78 Rear Brake



**Rear Brake Drum** includes sprocket riveted on for use on 1955-78 XLH-XLCH Sportster models. Order mounting bolts separately.

VT No.	#	Type	Finish
45-0403	A	Cover	Chrome
23-0437	B	Drum	Chrome
23-0438	B	Drum	Black
8812-16		Bolts	Cadmium Set
8811-16		Bolts	Chrome Set
19-0011		Sprocket	51T Black with rivets
19-0114		Rivets	Set
23-0817		Shoe Kit	1952-72
23-0818		Shoe Kit	1973-78



**Brake Shoe Sets** fit 1954-78 XL models. Include linings riveted on. Order spring set separately.

VT No.	Item	Type
23-0505	Lining Set	Standard
23-0450	Lining Set	.025 Oversize
13-0146	Spring Set	—
23-0503	Shoe Set	Standard
23-0390	Shoe Set	.025 Oversize



**Rear Wheel/Brake Drum Assembly** includes 16" all chrome wheel, brake drum, chrome backing plate assembly and chrome axle kit. Order chrome brake arm VT No. 23-0397.

VT No.	Fits
52-1050	1954-72
52-1051	1973-74
52-1052	1975-78



### Brake Pedals.

VT No.	OEM	Years	
23-0408	42410-52	1952-74	
23-0931	42410-52	1952-75	Zinc
23-0400	42420-75	1975-76	
23-0404	42410-75A	1977-79	



**Rear Brake Backing Plate** in chrome or polished finish. Order anchor bolt kit separately.

Polished	Chrome	#	Year	Type
—	23-9013	A	1954-72	Rod
—	23-9014	B	1973-74	Rod
23-2268	23-9015	C	1975-78	Cable

**Brake Operating Shafts** are splined to accept brake pedal.

VT No.	OEM	Year
23-1997	42549-52	1952-74
23-0396	41620-75	1975-76
23-1998	42549-75	1977-79

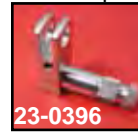

### Brake Operating Shaft Bushings.

10-2505	47757-52	1952-76
10-8268	25594-75	1977-Early81
10-0748	34898-79	1979 only Pivot Shaft



### Chrome Rear Backing Plate

**Assembly** includes chrome backing plate, shoes, springs, cam, pivot stud and related hardware. Order rear arm separately.

VT No.	Year
22-0728	1954-72
22-0729	1973-74
22-0730	1975-78



### Chrome Rear Brake Linkage

**Kit** includes chrome rod with nut, chrome pedal, chrome rear arm, brake spring, cross shaft, clevis pin and hardware.

VT No.	Years
22-0812	1952-66
22-0811	1967-74

## 1952-72 Drum Front Brake

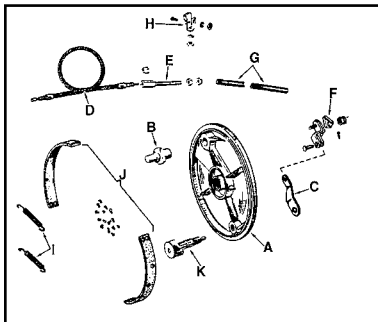

**Front Brake Parts** fit 1952-72.

VT No.	#	OEM	Item
N/A	A	44148-64	Polished Backing Plate
24-0116	B	44156-64	Pivot Stud, 1964-72
24-0609	C	44307-52	Zinc Lever
36-2385	D	45060-54	Cable Assembly
36-2565	D		Cable Assembly
8818-3	E	45159-50	Adjuster, zinc
9741-2	E		Chrome As Above
37-8676	F	45174-64	Zinc Clevis
24-0095	G	45203-52	Chrome Front Brake Tube
24-0646			As Above Cadmium
2041-7	H	45218-53	Zinc Cable Tube Clamp
13-0146	I	41835-69	Spring Set
23-0505	J	44432-54	1952-63 Linings
23-0450	J		O.S. 1952-63 Linings
23-0506	J	41848-64	1964-72 Linings
23-0525		41849-64	Shoe Set
23-0519	K	44264-64	Brake Cam, 1954-72



### Clutch and Brake Lever Assemblies

include cable pin. Available chrome or polished with 5/16" hole sizes for cable entry. VT No. 26-2167 and 26-2168 accept front brake switch.

Chrome	Polished	OEM	Fits
26-0525	26-0526	45002-65	1952-68 Brake
26-2167	26-2168	45002-69	1969-72 Brake



23-1717



42-9945



23-1720

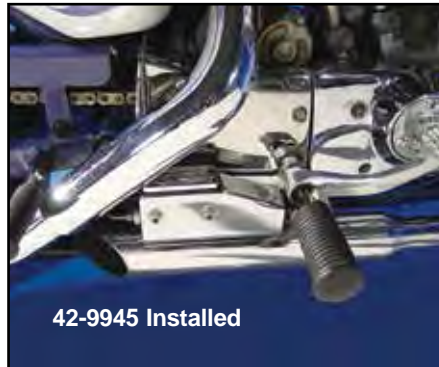

42-9945 Installed



23-1828



23-9177



23-9201



23-0586



42-0890



23-0757

23-0758



23-9262



23-0789

**Rear Master Cylinder Rebuilds.**

VT No.	OEM	Fits
23-1717	42374-77B	1980-81
23-1720	42874-82A	1982-Early87
23-9177	42382-87A	Late 1987-2003
23-1211	42810-04	2004-07
23-1213		Above without Piston
23-1212	42810-07	2007-13
23-1828	41700097	2014-up
23-0586	Pushrod	Late 1987-2003
	42436-87	

**Chrome Rear Master Cylinder Covers.**

VT No.	Years
42-9945	1980-2003
42-0890	1982-2003



23-2313

**Rear Master Cylinder.**

VT No.	OEM	Finish	Years
23-0757	42453-82B	Natural	1982-E87
23-0758	42453-82B	Chrome	1982-E87
23-9262	42456-87	Chrome	L87-2003
23-0586	Pushrod		L87-2003
23-0800	42521-07		2007-up
23-0789	42521-04		2004-06

**Warranty** All Brake/Calipers/Master Cylinders sold as individual pieces or in kits are covered under our warranty "Replacement Only" Provision. All item part numbers begin with a 23 prefix. No credit will be issued for these items as they are exchange only.



24-0632

24-0629

23-0617

24-0601

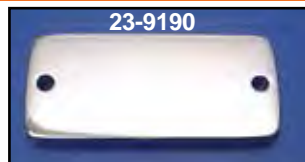

23-9190

Rear Master Cylinder Top Covers available for the years listed in Eagle Spirit chrome or with gold inlay and in smooth style.

Smooth	Eagle Spirit		Years
	Chrome	Gold	
23-9187	24-0629	24-0632	1987-96
23-9190	—	—	1982-87
23-0617	—	—	1979-81
Finned			
24-0601	—	—	1979-81

**Handlebar Master Cylinder.**

Fits	Years
2014-up.	
Chrome Black	
26-2213	26-2214 without ABS
26-2215	26-2216 with ABS



15-0203

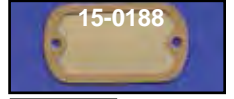

15-0188

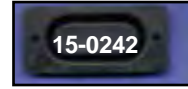

15-0242



15-0250

**Big Twin Gaskets Master Cylinder and Reservoir Top Gaskets**

GB No.	OEM	Year	Type
15-0188	45012-72	1972-81	Master
15-0204	45012-82	1982-84	Master
15-0242	45005-85	1985-95	Master
15-0250	45005-96	1996-up	Master
Rear			
15-0202	41766-58	1958-78	Master
15-0203	42455-80	1979-81	Master
15-0248	42455-82	1982-E87	Reservoir
15-0540	42455-99	2000-up	Reservoir
15-0240	45005-85	1985-95	Master
15-1379	Gasket	2004-06	Master
15-1380	Gasket	2007-up	Master



**Rear Master Cylinder Boots** sold each.

VT No.	OEM	Fits
28-0503	41764-79	1979
28-0505	40922-79	1980-86
28-2005	40922-87	1987-up

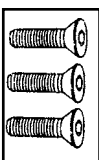

**Stainless Steel Master Cylinder Top Screws, 25 pack.**

VT No.	OEM	Years	Type
37-8947	2628	1972-81	Front Master Top, Countersunk
37-8821	42534-82	1982-up	Reservoir Cover

XL





# 1954-78 Mechanical Brake Part



**Chrome Rear Brake Arm** replaces 41925-52.  
Fits 1952-78.  
VT No. 23-0397

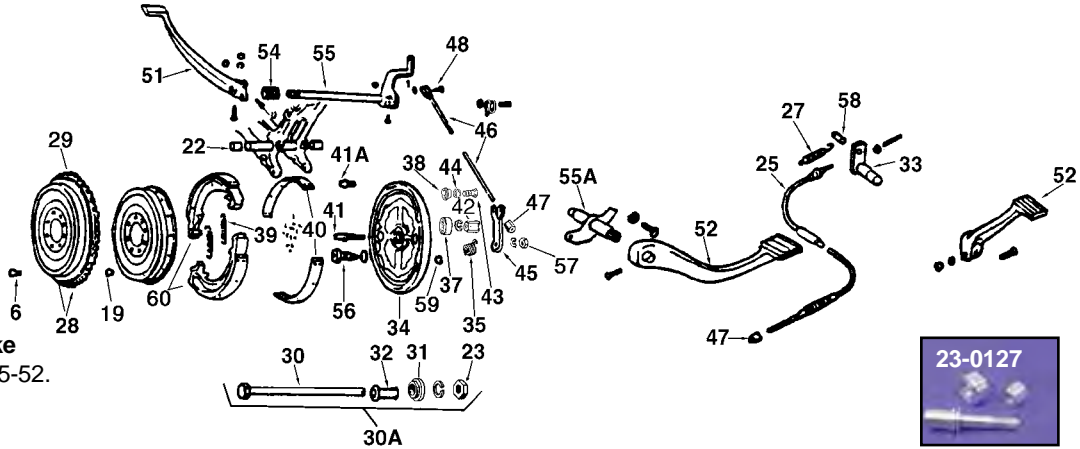

## 1954-78 XL Rear Brake Components, Drum Type.

VT No.	#	OEM	Item /Type
10-2505	22	47757-52	Bushing, pair
44-0326	23	7986	Axle Nut Kit, Chrome
36-1975	25	38634-75	Cable Assembly 1975-76
36-1977	25	38634-77	Cable Assembly 1977-78
13-0205	27	40521-75	Spring, Stop Light & Switch
23-0438	28	41401-52	Drum and Sprocket, Black
23-0437	28	Complete	As above, Chrome
19-0011	29	41470-70	Sprocket only, Black with rivets
8811-16	6-19	Chrome	Lug Bolt Set
8812-16	6-19	Cadmium	3970B and 7725 Nut
44-0217	30	41551-52	Rear Axle, Chrome
44-0565	30A	—	Rear Axle Kit
44-0317	31	41598-52	Collar, Zinc
44-0500	31	41598-52	Collar, Chrome
44-0324	32	41600-55	Spacer, Chrome
23-0396	33	41620-75	Splined Arm 1975-76
23-2267	34	41662-54	Side Plate 1954-72
23-2268	34	41662-75	Side Plate 1975-78
13-0144	35	41667-75	Spring, Lever, each
13-0146	39	41835-69	Shoe Springs, pr
23-0411	37	41730-52	Locating Block, Zinc
8937-3	38	41730-73	Spacer Pivot Stud Kit
	43	41882-73	Bolt, 3 Piece
	44	41883-73	Washer, Cadmium
8936-3	—	—	As Above, Chrome 3 Piece Kit
23-0127	37-41-52	—	Pivot Stud Kit 3pc 1952-72

23-0410	41A	41876-73	Pivot Stud 1973-78
23-0412	42	41882-52	Stud Nut 1954-72
9207-4	37-41-42	—	Pivot Stud Kit, Chrome
9208-4	—	As Above	Pivot Stud Kit, Cadmium
23-0397	45	41925-52	Rear Lever Chrome
23-0399	46	42252-52	Brake Rod, 54-66 Short, Chrome.
23-0324	—	42252-52	As above, Cad w/nut
23-0326	—	42252-52	As above, Parkerized
23-0398	46	42253-67	Brake Rod, Long 67-74, Chrome
23-0325	—	42253-67	As above, Cad w/nut
37-8461	47	42264-52	Adjuster Nut 1952-78
23-0421	48	42269-30	Clevis Pin 1954-74
23-0408	51	42410-52	Pedal, Chrome 1952-74
23-0400	52	42420-75	Pedal, Chrome 1975-76
23-0404	52	42410-75A	Pedal, Chrome 1977-79
13-0153	54	42427-52	Return Spring 1954-78
23-1997	55	42549-52	Cross Shaft 1954-74
23-1998	55A	42549-75	Operating Shaft 1977-79
23-3066	56	44264-54	Cam Brake 1954-78
23-0505	40	44432-54	Lining and Rivet Set 1954-78
37-9172	58	45052-75	Cable pin
23-0503	60	44401-49B	Brake Shoe Set



## Chrome Brake Light Switches

VT No.	#	OEM	Type	Fits
32-7785	A	72004-52	Push	1959-66
32-0547	B	72004-75	Pull	1975-76
32-0552	B	Black	Pull	As Above
32-0424	C	72004-70	Push	1967-74
32-0572	D	Kit	Pull	1975-76
32-0551	E	Kit	Push	1977-78
13-0218	—	—	Spring	1969



**Brake Rod Adjuster Nut.**  
Fits 1952-78. VT No. 37-8461

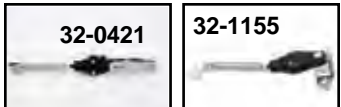

**Universal Black Mechanical Brake Lamp Switch** includes clamp and spring. Pull is on.  
VT No. Type  
32-0421 Pull  
32-1155 Pull  
32-1156 Pull



**Rear Brake Cable Assembly** fits drum brake 1975-78 models, 2 types.

VT No.	OEM	Year
36-1975	38634-75	1975-76
36-1977	38634-77	1977-78

**Rear Chain Adjuster Sets** are heat treated and include nuts. Fits 1952-78.

VT No.	Finish
7703-2	Chrome
9020-2	Cadmium

**Anchor Studs** for backing plates in chrome or cadmium finish.

VT No.	Years	Finish
9207-4	1954-72	Chrome
9208-4	1954-72	Cadmium
8936-3	1973-78	Chrome
8937-3	1973-78	Cadmium
23-0410	1973-78	Zinc



**1958-69 XLCH Switch Kit** replaces 72011-59 bracket, 5902 (2) spacer.  
VT No. Item  
32-9161 Switch with bracket



1984-99 Type

23-2226

**Chrome Front Disc Caliper** available as right or left assemblies or set for 11½" brake rotors. Includes all internal components and pads. Fits 1984-99.

23-3082



VT No.	Item
23-2226	Pair, Right and Left
23-3085	Right only
23-3082	Left only



23-3061

**1984-99 Black Front Caliper** include internal components. Replaces 046-84C, left. VT No. 23-3061

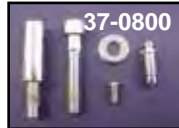

**Chrome Front Caliper Bolt Kits.**  
VT No. Years  
37-0800 1993-99  
37-8822 1984-92



23-1105 Installed



23-1105



23-0865

**Edart Billet Front Caliper** includes bracket for 1984-99 ST and XL models is one piece design. VT No. Piston  
23-1105 2  
23-0865 4

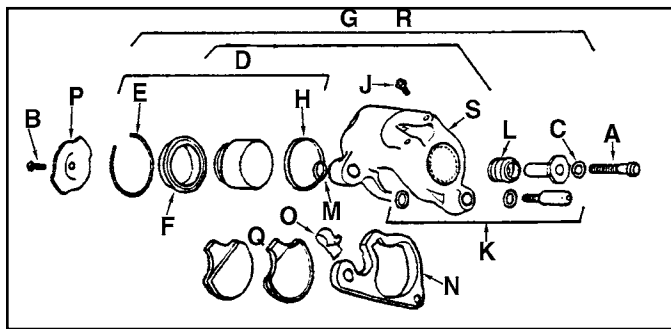

1984-99 Front Calipers and Components.

VT No.	#	OEM	Item
37-8822	A	855	Screw
Kit	B	3517	Screw
1983-92	C	6019	Washer
37-0800		As Above	1993-99
23-2279	D	44020-83	Piston Rebuild Kit
12-0977	E	44021-83	Retainer
23-2275	F and H	44047-83	Dust Boot with Seal
23-3061	G	44046-84C	1984-99 All, Black
23-3082	G	As Above	Caliper Left, Chrome Complete
23-1731	J	44048-83	Bleeder
23-2274	K	44053-83	1984-92
23-9226	K	44053-92	Guide Pin Kit for 1993-99
28-2133	L	44054-83	Boot, each
14-0563	M	44059-83	O-Ring
23-2308	N	44072-92A	Bracket, Left
N/A	N	44073-92A	Bracket, Right
23-2306	O	44061-83	Spring Clip
23-2307	P	44062-83	Retaining Pad
23-0512	Q	44063-83	Pad Set with B

# Front Caliper 1984-99



**11½" Chrome Left Side Front Caliper Kit** includes polished stainless steel Dura brake disc with bolts and chrome caliper half with brake pads and hardware. 39mm. Fits 1984-99.

VT No. 23-0563



**Chrome Caliper Kit** features 4 piston chrome caliper and polished stainless steel Dura brake disc. Fits 1984-99.

VT No. 23-0649



23-0279 Installed



**Front Chrome Billet Calipers** feature 4-piston design with mount brackets included. Fits 1984-99.

VT No. 23-0279



23-0555 Installed



4 Piston

**Chrome Left Side 4 Piston Caliper** features 2000-up styling to retro fit 1984-99 models.

VT No. 23-0555

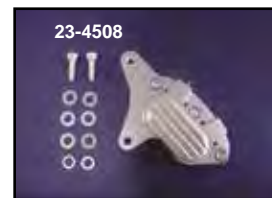

23-4508

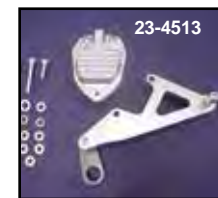

23-4513



23-4504

**Front GMA Billet Aluminum Brake Calipers** are machined from billet aluminum and clear anodized. Feature dual pistons which are internally connected, brake pads and brackets, when provided. Include spacers and hardware necessary for installation. Hoses and rotors not included.

VT No.	GMA#	Fits	Bore
23-4508	400	77-83 XL Dual Kit, 8 Piston.	¾"
23-4513	200E	74-77 XL Single Disc	⅝"
23-4504	200F	84-99 Single Disc XL Kit, fits left only, 2 piston	⅝"

Components	Part No.	Description
23-4521	PA4	Caliper Piston Pair fits 23-4508, 23-9210, 23-1793, 23-9256
23-4520	PA2	Caliper Piston Pair fits 23-4513, 23-4504
23-4510	RB1	O-Ring Seal Kit fits 23-4513, 23-4504
23-4522	RB4	O-Ring Seal Kit fits 23-4508, 23-9210, 23-1793, 23-9256
23-4514	B Pad	SBS Brake Pad Set Fits 23-9513, 23-4504
23-9169	F Pad	SBS Brake Pad Set Fits 23-4508, 23-9210
23-0593	F-Pad	Dura 4 pc Set

XL





# Front Caliper Kit

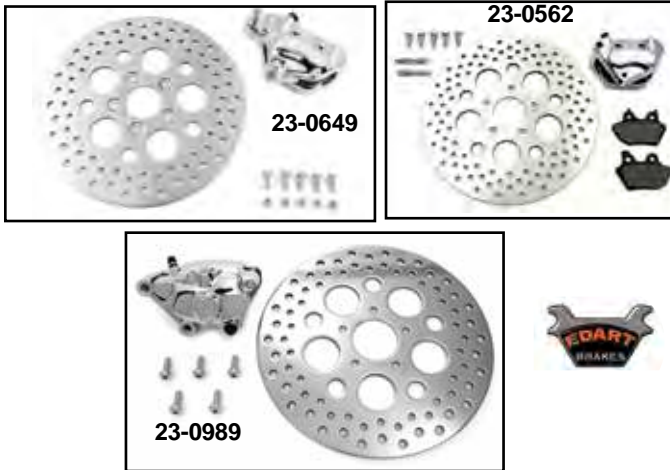

**11.5" Chrome Front Caliper and Rotor Kit** includes a complete chrome replica 4-piston caliper assembly with pads, polished stainless steel drilled rotor and chrome mount bolts.

VT No.	Year
23-0649	1984-99
23-0562	2000-03
23-0989	2004-up



**1984-99 Chrome Billet Front Caliper Kit** includes billet chrome front caliper and bracket with pads and polished 18 spoke stainless steel brake rotor with bolts. Kit includes hardware to fit 39 & 41mm forks FXST, FXD and FLST models.

VT No.	Item
23-0238	18 Spoke Kit
23-0240	Razor Kit
23-0279	Caliper & Bracket Only
23-0884	Caliper Rebuild fits V-Twin Billet 4 Piston Calipers

## 1974-77 Single Disc Caliper

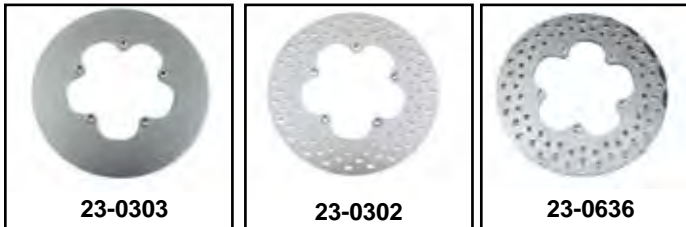

**1974-77 "Clover Leaf" 11 1/2" Rotors.**

VT No.	Finish	Brand
23-0303	Zinc	Dura
23-0302	Zinc, Drilled	Dura
23-0317	Stainless	Dura
23-9042	SS Polished	Russell
23-0636	SS Polished	Dura

**1974-77 Front Caliper Service Fix Kit** includes seal kit, spring, pins and bleeder screw.

VT No. 23-0148

**1974-77 Single Caliper Pieces.**

VT No.	#	OEM	Item
23-1723	K	44275-74	Piston
12-0943	L	44274-74	Piston, Friction Ring
23-0514	A&B	44281-74	Pad Set
23-0606	E&F	44277-74	Caliper Seal Kit
		44278-74	
23-0148		Kit	Service Kit includes C,D,E,F,G,N
23-1747	C&D	44280-74	Caliper Pin Set, two piece
		44283-74	Set
		43302-77	Spring, Service Fix
23-1995	H	44272-74	Anchor Arm
	I	44276-74	Plate, Floating Lining
23-0065			Anchor Arm Only
37-8996	M	Kit	Mount Bolt Kit Chrome
23-1730	J	Complete	Black Caliper Assembly with A-F+H,I
23-0711	N	41749-58	Bleeder Screw
8759-5	O	41191-74	Chrome Rotor Screw Set

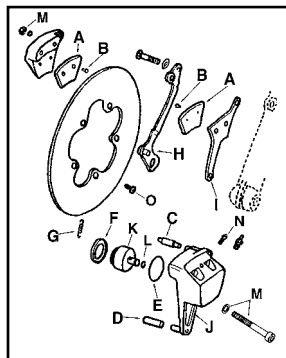

**Chrome Caliper Kit Drilled** includes zinc or polished stainless steel brake rotor. Fits 1974-77.

VT No.	Rotor Type
23-0564	Steel Zinc
23-0565	Stainless Steel Polished



**Single Disc Front Caliper Assembly** features stock type construction in black or chrome with piston installed. Caliper units include zinc plated brackets and hardware. Fits 11 1/2" rotor on stock 35mm forks. Fits 1974-77.

VT No.	Finish
23-1730	Black
23-1737	Chrome



**1974-77 Single Disc Caliper Kit** includes GMA Billet Caliper, 11.5" drilled zinc plated steel rotor and mount bolts.

VT No.	Item
23-0626	Kit
23-4513	Caliper Only (GMA)
23-1100	Edart Chrome Caliper Only

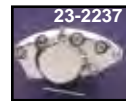
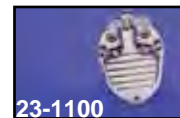

**Front Caliper Assemblies** are fully assembled with disc pads and all internals for 1973 only XL front. Calipers accept 1/8" NPT line.

VT No.	Finish
23-2219	Black
23-2237	Chrome



# 00-03 Front Caliper



**23-0554**  
**23-0554**  
**Front Caliper** are 4 piston type including all internal components. 23-0554 features smooth face. Fits 2000-03.

VT No.	OEM	Side	Finish
23-0554	44046-00	Left	Chrome
23-0529	44046-00	Left	Black
23-0580	44025-00	Right	Chrome
23-0581	Set	Right and Left	Chrome



**Chrome Billet Front Caliper** fits 2000-03 XL models.  
**VT No. 23-1039**



**Caliper Seal Kits** contain seal & dust boot for year listed.

VT No.	OEM	Front
23-2275	44047-83 44022-83	1984-99 XL
23-0533	44315-00	2000-03 All Front Only



**Left Chrome Front Caliper Cover** includes chrome trim disc to conceal mount hardware. Fits 2000-2003.  
**VT No. 42-0844**



**Front Chrome Disc Brake Caliper Mount Bolt Kit** fits 2000-03 models.

**V-Twin Colony**  
**37-0816 2080-4**

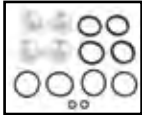

**Pistons Only**, less seals, pistons are sold each.  
**VT No. OEM Front**  
**23-2279** 44020-83 1983-99 XL  
**23-0532** 44313-00 2000-03 All Front Only

# 2004-up Front Caliper

**2004-up XL Front Calipers** feature 4 pistons design in chrome.

VT No.	OEM	Finish	Side	Model
23-0851	44121-04	Silver	Left	XLH
23-0852	44121-04	Chrome	Left	XLH
23-0008	44546-04	Chrome	Right	XLH
23-0286	44121-07A	Chrome	Left	XLH
23-0821	42879-07	Chrome	Left	"48"
23-0273	42822-04	Piston with seal	2004-06	
23-0274	43529-04	Seal Kit	2004-06	
23-0285	42028-07	Piston & Seal Kit	2007-13	
23-0292		Seal Kit	2007-13	
23-0827	41300006	Piston & Seat Kit	2014-up	
23-0294		Front Seal Kit	2014-up	



# 1977-83 Dual Disc



**1977-83 Chrome Dual Disc Caliper and Rotor Set** includes (2) chrome calipers and (2) 10" drilled rotors.

VT No.	Item	Rotor
23-0250	Caliper Rotor Set	Zinc Steel
23-0258	Caliper Rotor Set	Polished Stainless Steel
23-0259	Caliper Rotor Set	Stainless Steel
8758-10	Bolt Set	

**Chrome Lower Slider Set Only** fits 1977-82 dual disc 35mm forks.  
**VT No. 24-0541**

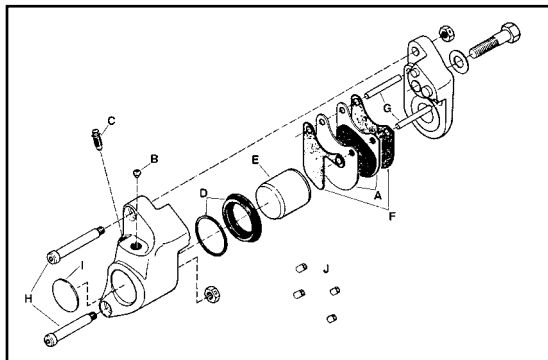

**Dual Disc Front Disc Calipers** includes body, piston, seals. Dual type fits 1977-83 FX-FXWG with 10" brake rotors. Order mounting hardware separately.

VT No.	Side	Finish	Style
23-2221	Right	Black	A
23-1121	Right	Chrome	A
23-2238	Left	Black	A
23-1120	Left	Chrome	A
23-1119	Right and Left	Black	A
23-1122	Right and Left	Black, ET	B
23-2220	Right and Left	Chrome, Daytona	B
23-0550	Right and Left	Chrome, ET	A



**Dual Disc Caliper Hardware** fits 1977-83.

VT No.	#	OEM	Item
23-0509	A	44098-77	Pad Set (4)
23-9198	B	44141-77	Seat, brake hose
23-1731	C	44146-77	Bleeder Fitting
23-0607	D	44151-77	Seal, piston
		44153-77	
23-2278	E	44157-77	Piston
23-0523	F	44158-77	Plate, Outer
		44161-77	Plate, Inner
23-1734	G	44162-77	Pin
24-0602	H	44173-77	Screw
		44174-77	
37-8970	I	—	Chrome Insert, each
24-0603	J	46018-77	Mount Bushing Set
		46019-77	

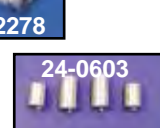





# Stainless Brake Rotor

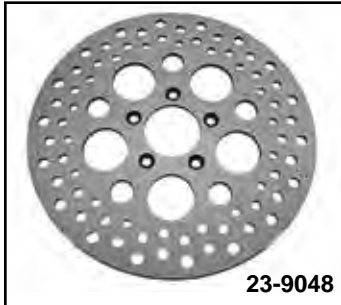
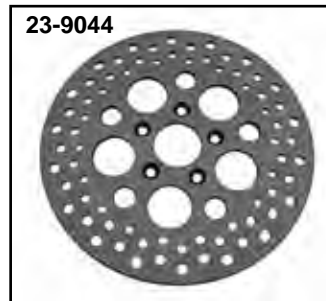

**Drilled Stainless Rotors** feature rustless finish for appearance and long service life, in Russell or Dura Rotor brand. Available in standard or polished finish. Russell High Performance and Dura Stainless Steel Rotors are compatible with all disc pads including sintered metal and OEM.

Dura Rotor		Russell		OEM	Dia.	Bolt Kit	Bolt Kit	Fits
Polished	Standard	Polished	Standard					
<b>REAR</b>								
23-0341	23-0333	23-9044	23-0318	41791-79	11.5"	8791-10 Cast or Wire	8791-10T	1979-92 Cast or Wire
23-0362	23-0361	23-9045	23-9926	41789-92	11.5"	9807-10 Cast or Wire	9807-10T	1993-99 Cast or Wire
23-0468	23-0469	—	—	41789-92	11.5"	9807-10 Cast or Wire	9807-10T	1993-99 Cast or Wire
23-0357	23-0387	23-9050	23-9051	41797-00	11.5"	9807-10 Wire 9818-5 Cast	9807-10T	2000-up Cast or Wire
<b>FRONT</b>								
23-0343	23-0334	23-9040	23-0319	44136-84	11.5"	8793-5 Cast 8794-10 Wire	8793-5T 8794-10T	1984-91 Cast or Wire
23-9206	23-0368	23-9040	23-0319	44136-92	11.5"	8793-5 Cast 8794-10 Wire	8793-5T 8794-10T	1992-99 Cast or Wire Wheel
23-0467	—	—	—	44136-92	11.5"	8793-5 Cast 8794-10 Wire	8793-5T 8794-10T	1992-99 Cast or Wire Wheel
23-0356	23-0379	23-9048	23-9049	44156-00	11.5"	8793-5 Cast 8794-10 Wire	8793-5T 8794-10T	2000-up Cast or Wire Wheel Left Side Rotor



# Disc Brake Pad

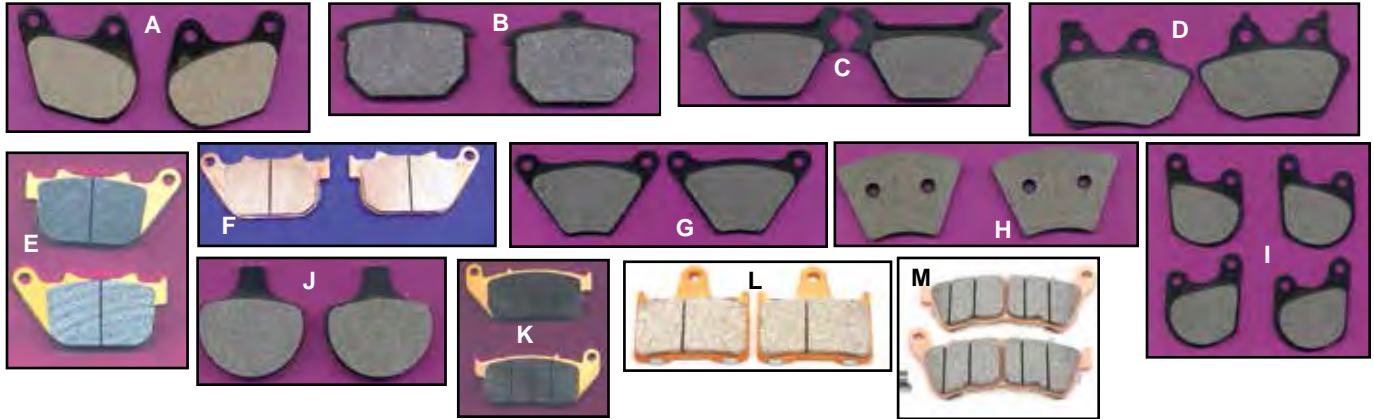

**Disc Brake Pads** are available in **Dura**, **SBS**, **Dura Kevlar**, **Dura Semi-Metallic** for excellent stopping on all types of disc rotors. **Dura** replacement pads are a soft compound designed to be compatible to all types of brake disc rotors. **SBS brand** is available in **Sintered**, **Ceramic** or **Carbon Tech** compounds. **Sintered Metal Pads** provides maximum stopping power but can never be used in calipers that were originally equipped with non-sintered pads. Works best with stainless steel disc rotors. **Ceramic Pads** are designed for general purpose use on carbon steel rotors and can be used on carbon steel rotors and can be used on calipers originally equipped with sintered metal brake pads. **Carbon Tech Pads** designed for use in all stock or aftermarket calipers. Works well with stainless steel or cast iron rotors.

Fits	OEM	Dura Metallic	Dura Ceramic	Dura Soft	Dura Semi	Dura Kevlar	SBS Sintered Tech	SBS Ceramic	SBS Carbon	Photo #
<b>Rear Disc Pad Sets for Stock Type Calipers</b>										
1979-81 XL	43395-80	—	23-0999	23-0510	23-0640	23-0618	—	23-1766	—	A
1982-E87 XL	44209-82	—	23-0912	23-0511	23-0641	23-0619	—	23-1764	23-1776	B
1987-99 XL	44213-87	—	23-0992	23-9163	23-0642	23-0620	23-1780	—	23-1779	C
2000-2003 XL	44082-00	—	23-0993	23-0526	23-0643	23-0546	23-4559	23-1781	23-1782	D
2004-06 XL	42836-04	—	23-0916	—	23-1950	23-1951	23-1952	—	—	E
2007-13 XL	42029-07	23-0183	23-0910	—	—	23-0184	—	—	—	F
2014-up XL	41300053	23-0185	23-0186	—	—	23-0187	—	—	—	L
<b>Front Disc Pad Sets for Stock Type Calipers</b>										
1973 XL	44131-73	—	23-0913	23-0513	23-0644	23-0621	—	23-1763	23-1775	G
1974-77 XL	44281-74	—	23-0915	23-0514	23-0645	23-0623	23-1767**	23-1786	—	H
1978-83 XL	44098-77	—	23-0911	23-0509*	23-0646	23-0624	—	23-1760*	23-1783*	I
1984-99 XL	44063-83	—	23-0996	23-0512	23-0647	23-0625	23-1784	23-1762	23-1785	J
2000-2003 XL	44082-00	—	23-0993	23-0526	23-0643	23-0546	23-4561	23-4560	23-1782	F
2004-13 XL	42831-04	23-1958	23-0914	23-1959	23-1955	23-1956	23-1960	—	—	K
2014-up XL	41300004	23-0188	23-0189	—	23-0190	23-0191	—	—	—	M

\*Note: Set of Four, \*\*Note: Dura Brand

## Replica Steel Brake Rotor

**V-Twin Mfg™ Brake Rotors** feature fine finish ground surface. Available with or without holes in steel with zinc finish unless as construction as noted as stainless. Exactly interchangeable with stock discs. Order bolt set separately.



23-0309

23-0312

Drilled	Plain	OEM	Dia.	Bolt Kit	Fits	Type
<b>FRONT</b>						
23-0304	23-0305	41813-79	10"	8738-10	1972-84 FLH	Steel
				8738-10T	Cast or Wire 1973 only FX	
23-0309	23-0310	41806-72B	10"	8738-10	1972-84 FLH, 1973 only FX	Steel
				8738-10T	Cast or Wire with built in offset	
23-0311	23-0312	44137-77A	10"	8758-10	1977-83 All FX Cast or Wire	Steel
					Cast or Wire 2 3/8" Inner Diameter Center Hole	
<b>REAR</b>						
23-0307	23-0308	41791-79	11.5"	8791-10	1981-92 Cast or Wire	Steel



**Vibration Shims** fit rear pads. Fit 2004-up. Replaces 42521-04.  
VT No. 23-9268

23-9268





# Replica Brake Hose

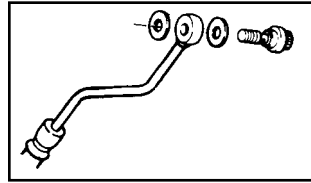
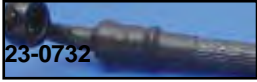

Hoses Listed are of stock type rubber construction are D. O. T. approved.

### Front

VT No.	OEM	Length	Fits
23-0732	45521-74A	40"	1974-77 XL
23-0723	45121-77	19"	1977-79 XL Lower only 1980-82 XL
23-0726	45121-77	19"	1977-79 XL Lower only

### Rear

23-2310	44438-87B		Late1987-03 XL
---------	-----------	--	----------------

**Chrome Banjo Bolt Kits** for use with universal or stock lines, front and rear, washers included. The VT No. 37-8979 is to be used when a master cylinder or caliper uses a 3/8-24 banjo bolt and the line has a 12mm hole instead of 10mm.

VT No.	OEM	Line	Size/Item
23-0612	41747-82A	10mm	3/8-24
23-0613	41731-82	10mm	Washers
23-0614	41739-84	12mm	7/16-24
23-0615	45583-83	12mm	Washers
37-8979	Special Kit	12mm	3/8-24
14-0568	41731-88	10mm	Washer with O-Ring
14-0567	41733-88	12mm	Washer with O-Ring
23-0882	2004-up XL	10mm	Hex
23-0883	2004-up XL	12mm	Hex
2300-3	2004-up XL	10mm	Dome Hex
2302-3	2000-up XL	12mm	Dome Hex



**Brake Hose Fittings** for front master cylinder, chrome.

VT No.	OEM	Type
26-0622	43307-78	Angle
23-0517		Converts 10mm late threads to 1/8" NPT with inverted flare, early thread hose type, straight.



**Banjo Bolt** by Russell accepts brake light switch and eliminates the need for junction block. Replaces the standard 3/8 x 24 bolt. Sold each. **VT No. 23-0746**

## Brake Tees



### Chrome Steel Brake Line Tees

VT No.	Type
23-0570	Center hole inverted flare 3/8" - 24 UNF, side tubes 3/8" - 24 UNF, mounting hole 5/16" I.D.
23-0571	Center hole 1/8" - 27 NPT, side tubes 3/8" - 24 UNF, mounting hole 5/16" I.D.
23-0572	Center hole & side tubes 1/8" - 27 NPT, mounting hole 5/16" I. D.



### Billet Aluminum Brake Tees

VT No.	Type
23-9227	Front 3/8-24 inverted flare in all 3 holes
23-9228	Rear 3/8-24 inverted flare in 2 holes and 1/8" NPT in center hole



**Chrome Front Replacement Brake Tees** for XL's.

VT No.	OEM	Fits
23-0706	43308-78	1978
23-0708	44311-80	1982
23-0705	43310-77	1979-81



**Chrome Stock Billet Brake Clips.**  
VT No. 36-0351



**Brake Banjo Seal Washers** feature built in O-Rings.

VT No.	OEM	Type
14-0567	41733-88	7/8", 12mm fits handlebar cylinders 1984-00, single disc
14-0568	41731-88	3/8", 10mm fits 1982-00 Dual Disc Brake Calipers
14-0578	41731-01	Fits 2001-up Master Cylinder & Brake Calipers



**Allen Button Head Banjo Bolts** sold with washers.

VT No.	Size	MM
37-8517	3/8-24	10
37-8518	7/16-24	12



**Universal Straight Chrome Union** with bracket.

VT No.	Thread
23-0635	1/8 NPT
23-0688	3/8-24



**10mm Russell Street Legal Universal Brake Lines.** Build it yourself line assemblies ready for adapter fittings. Preassembled with high performance #3 stainless braided hose with a rugged Teflon® inner and crimp-on chrome plated female swivel hose ends. Clear coated for abrasion resistance. Meets the guidelines of the D.O.T. MVSS-106 requirements and are 50-state legal. Compatible with all brake fluids.

VT No.	Length	VT No.	Length	VT No.	Length
23-8352	4"	23-8120	32"	23-8282	58"
23-8002	6"	23-8130	34"	23-8229	60"
23-8010	9"	23-8342	36"	23-8332	62"
23-8020	12"	23-8140	38"	23-8312	64"
23-8030	15"	23-8242	40"	23-8322	66"
23-8362	16"	23-8150	42"	23-5833	68"
23-8040	17"	23-8252	43"	23-5835	72"
23-8212	18"	23-8262	44"	23-5836	74"
23-8050	19"	23-8192	45"	23-5840	80"
23-8060	21"	23-8372	46"		
23-8070	23"	23-8160	47"		
23-8080	25"	23-8202	50"		
23-8090	26"	23-8170	52"		
23-8100	28"	23-8180	54"		
23-8110	30"	23-8272	56"		

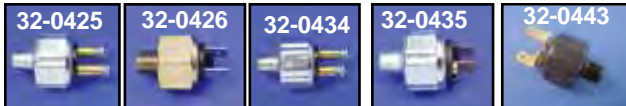

**Hydraulic Brake Switch** features heavy duty contacts and quality brass terminals for 1951-up models.

VT No.	Type	Brand
32-0425	Screw	V-Twin
32-0426	Flag	V-Twin
32-0434	Screw	Accel
32-0435	Flag	Accel
32-0443*	Flag	V-Twin



**Front Chrome Brake Line Clamp** fits under triple tree to secure stainless brake line. 1/4 x 20 mount hole.

VT No.	Type
23-0675	A
23-0686	B



**Brake Hose Fittings.**

23-4306	Front Wide Glide Junction Block
23-4307	Front Narrow Glide
23-4305	90° long forward control banjo, 10mm
23-4303	35° short rear brake banjo, 10mm
23-4304	90° short rear brake banjo, 10mm



# Brake Fitting & Bolt

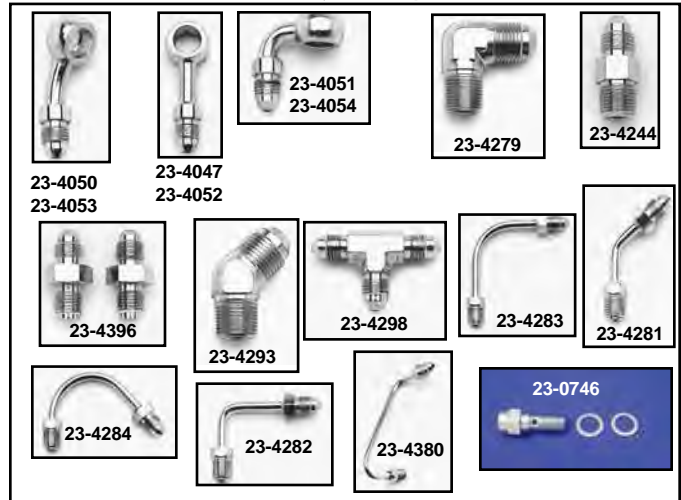

**Chrome Adapter Fittings** see listing for application. Sold as each, unless noted. \*Note: Most common use

**VT No. Fitting Type Adapts To:**

- 23-4047 10mm Banjo, straight
- 23-4050 10mm Banjo, 35°
- 23-4055 10mm Banjo, 45°
- 23-4051 10mm Banjo, 90°
- 23-4052 7/16" Banjo, straight
- 23-4053 7/16" Banjo, 35°
- 23-4056 7/16" Banjo, 45°
- 23-4054 7/16" Banjo, 90°
- 23-4057 12mm Banjo, straight
- 23-4058 12mm Banjo, 35°
- 23-4059 12mm Banjo, 90°
- 23-4244 1/8" Male NPT, straight
- 23-4279 1/8" Male NPT, 90°
- 23-4293 1/8" Male NPT, 45°
- 23-4298 Male "T"
- 23-6033 Flare Union
- 23-6034 3/8 x 24 Banjo Bolt
- 23-6035 7/16 x 24 Banjo Bolt
- 23-6040 10mm x 1.25" Banjo Bolt
- 23-6041 12mm x 1.25" Banjo Bolt
- 23-6036 3/8 x 24 Double Banjo Bolt
- 23-6042 10mm x 1.25" Double Banjo Bolt
- 23-0746 3/8 x 24 Brake Switch Banjo Bolt
- 23-6037 35° Rear Banjo, 10mm
- 23-6038 90° Short Rear Banjo, 10mm
- 23-6039 90° Long Forward Control Banjo, 10mm
- 23-4396 3/8-24 Male Inverted Flare, straight, 2 pack
- 23-4380 3/8-24 Male Inverted Flare, 90° & 120°
- 23-4281 \*Junction block to master cylinder
- 3/8-24 Male Inverted Flare, 45°
- \*Rear Calipers
- 23-4282 3/8-24 Male Inverted Flare, 90°, short
- \*Junction Block to Front Caliper
- 23-4283 3/8-24 Male Inverted Flare, 90°, long
- \*Junction Block to Front Caliper
- 23-4284 3/8-24 Male Inverted Flare, 150°
- \*Forward Controls

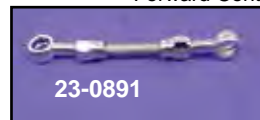
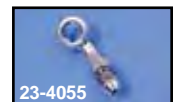
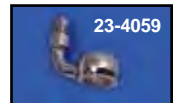

**Double Banjo Brake Line** use with 10mm bolt.

VT No.	Item
23-0891	Line
23-0612	Bolt
23-0688	Junction





# Stainless Brake Line

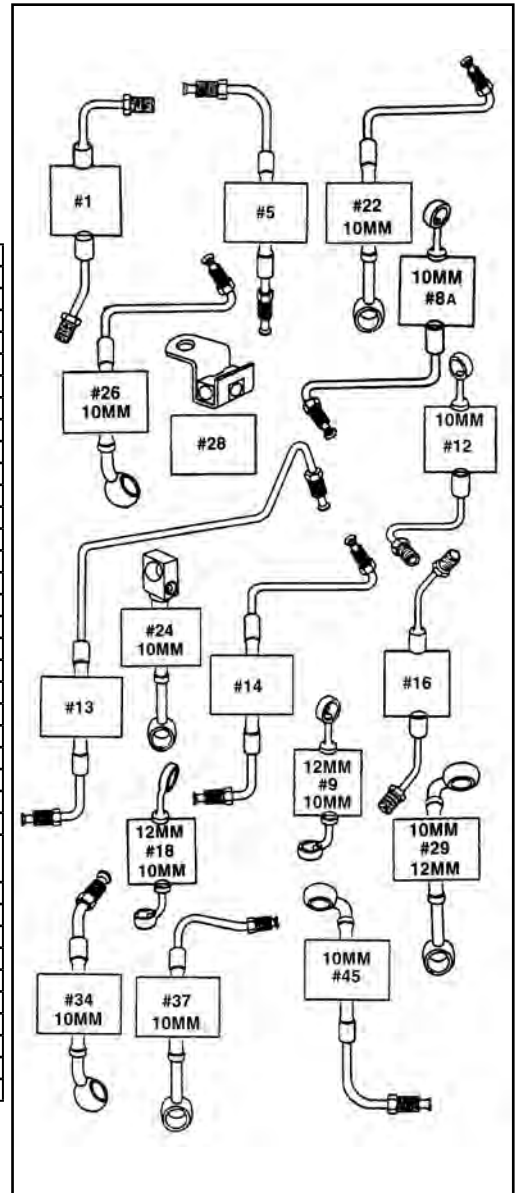

**10mm Stainless Steel Banjo End Dual Disc Upper Hose** fits 1982-up style master cylinders for single or dual disc application. Hose has nut with inverted flare at opposite end.

**VT No.**      **Length**  
**23-8926**      24"

Year	Model	Front	Diagram#	Rear	Diagram#
*Note: D.O.T. approved.					
1974-77	+4" Ext	23-8901	1	—	
	As Above +8" Ext	23-8902	1	—	
1978-79	XL-XLCH	23-8703	5	23-8800	20
1979	XLS	23-8704	5	23-8800	20
1980	XLS		5, 14	23-8801	16
1980	XLH	—	5, 14	23-8801	16
1981	XL-XLS	—	5, 14	23-8801	16
1984-85	XLX	23-8729	18		
1984-85	XLH	23-8722*	9		
1984-85	XLS	23-8723*	9		
	As Above +2" Ext	23-8943	9		
	As Above +4" Ext	23-8944	9		
	As Above +6" Ext	23-8945	9		
1987-99	XLH 883 Standard (Man. After 2/1/87)	23-8735*	29	23-8834*	
2000-03	XLH 883 Standard	23-8735*	29	23-8835*	
2004-07	XLH 883 Standard	23-8794*		—	
1987-98	XLH 883 Deluxe	23-8746*	9	23-8834*	
	As Above +2" Ext		9	23-8834*	
	As Above +4" Ext	23-8983	9	23-8834*	
1986-87	XLH 1100	23-8722*	9	23-8816	
1987-95	XLH 883 Hugger	23-8746*	9	23-8834*	
	As Above +2" Ext		9	23-8834*	
	As Above +4" Ext	23-8983	9	23-8834*	
1996-99	XLH 883 Hugger			23-8834*	
2000-03	XLH 883 Hugger Custom				
1988-98	XLH 1200	23-8746		23-8834*	
1996-99	XLH 1200 Standard	23-8753*		23-8834*	
2000-03	XLH 1200 Standard	23-8753*		23-8834*	
1996-99	XL 1200S Sport	23-8754*		23-8834*	
2000-03	XL 1200S Sport	23-8754*		23-8835*	
1996-03	XLH 1200 Custom	23-8755*		23-8834*	
1997-98	XLH 1200	23-8755*		23-8835*	34, 37, 48
2004-up	XL 1200C Custom	23-8794		—	
2004-up	XL 50th Anniversary	23-8794		—	
2004-up	XL 1200R Roadster	23-8794		—	

Front Lines-Dual Disc Upper Lines (sold each)			
VT No.	Year/Model	Length	Diagram#
23-8908	1978-79 XLH-XLCH	Stock 19"	5
23-8909	1978-79 XLH-XLCH	+2"	5
23-8910	1978-79 XLH-XLCH	+4"	5
23-8911	1978-79 XLH-XLCH	+6"	5
23-8912	1978-79 XLH-XLCH	+8"	5
23-8906	1977-81 XL	Stock 14"	5
23-8926	1983 XLH	Stock 24"	12
23-8928	1983 XLH	+4"	12
Lower Lines-Dual Disc Lower Lines (2 required, sold each)			
23-8908	1978-82 XLH-XLCH	Stock 19"	5
23-8909	1978-82 XLH-XLCH	+2"	5
23-8910	1978-82 XLH-XLCH	+4"	5
23-8911	1978-82 XLH-XLCH	+6"	5
23-8912	1978-82 XLH-XLCH	+8"	5
23-8909	1977-82 XL	Stock 21"	5
23-8910	1977-82 XL	+2"	5
23-8911	1977-82 XL	+4"	5
23-8942	1981 XL-XLS	+23"	14

# 41 mm FL Glide Style Fork Kit for XL



24-2036

**Fatster™**



**Dual 10" Disc Style**  
24-2024,  
24-2026

**41mm Glide Fork Assemblies** for 1952-up XL models. Feature wide style with chrome triple trees, polished or chrome lower sliders, hard chrome fork tubes, axle, neck bearings, top cone and stem nut, pinch bolts and bearing dust covers. Fork is 31" overall length. Single disc units accept

11.5" brake rotors, dual rotors type uses two 10" brake rotors. All units require Big Twin WG front wheels. Also available as complete kits with 21" wheels and black or chrome calipers, brake rotors and brake disc bolts. Order neck cup set 24-0157 for 1952-78 models. Units do not include provision for fork lock. Single disc models accept 36-0803 speedo drive, dual disc models accept 36-0547 speedo drive kit.



**41 mm Fat Kid Style Fork Assemblies Only.** Include chrome top tree, black lower tree with polished or chrome lower sliders assembled with hard chrome fork tubes and axle kit.



**41mm Glide Fork Assembly**

**Single 11 1/2" Disc Style**  
24-2023, 24-2025

23-2029

VT No.	Year	Sliders
24-0765	1982-2003	Polish
24-0766	1982-2003	Chrome
24-1457	Cone Nut	



**FLST Style**



**Fat Kid Style**

**41mm FLST Style Complete Front End Assembly** to fit XL models. Kits include the complete fork assembly kit, with the addition of the 5 piece chrome fork cover set, 7" headlamp and bracket, 16" chrome wheel, speedometer drive, chrome caliper, 11.5" drilled disc, and fat kid style or FLST style fender. Kits available with a chrome caliper and polished or chrome lower legs.

- 1982-2003 Fat Kid Style Kit**
- 24-2036** Kit with Chrome Lower Slider
- 1982-2003 FLST Style Kit**
- 24-2035** Kit with Chrome Lower Slider

The V-Twin™ Fork Assembly is shipped complete with axle, axle nut, spacer, top nut, bearings, cone nut, dust cover, triple trees and fork tubes & sliders. Fork tubes and sliders are fully assembled with internals. Final assembly of the remaining components is done by the dealer. Every leg assembly is shipped dry. We recommend use of the appropriate fork oil such as Type B. The amount of fork oil to add varies by model. A FX will need about 6 oz per leg, a FL will need about 8.5 oz per leg and a FXWG need about 10 oz per leg. Due to oil cling, dry for leg needs about 1 oz more to fill than a drained leg would require.

## 1952-81 Fork Assemblies.

VT No.	Type	Finish
24-0759	11.5" Single	Polish Slider
24-0760	11.5" Single	Chrome Slider
24-0758	10" Dual	Polish Slider
24-0761	10" Dual	Chrome Slider

## 1952-81 Fork/Wheel Assemblies.

These assemblies include 21" chrome wheel, chrome caliper(s) drilled disc brake disc(s) and brake disc bolts.

24-2023	11.5" Single	Chrome Slider
24-2024	10" Dual	Chrome Slider

## 1982-03 Fork Assemblies.

24-0040	11.5" Single	Polished Slider
24-0041	11.5" Single	Chrome Slider
24-0042	10" Dual	Polished Slider
24-0043	10" Dual	Chrome Slider

## 1982-03 Fork/Wheel Assemblies.

These include 21" chrome wheel, chrome caliper(s), drill disc brake disc(s) and brake disc bolts.

24-2025	11.5" Single	Chrome Slider
24-2026	10" Dual	Chrome Slider



**Chrome Lower Tree Cover** covers area on lower tree below headlamp.

VT No. 31-9991





# Fork Assembly



## 35mm and 39mm

**Fork Assembly with Polished Lower Sliders.** Complete narrow glide fork assemblies. \*Note: Units have chrome lower sliders.

Dual Chrome	Single	Fits	MM
24-8569	—	1977 only	35 7/8" Neck Post
24-8570	—	1978-81	35 15/16" Neck Post
24-8571	—	1982-83	35 1" Neck Post
—	—	1988-99 883	39
—	—	1995-99 1200	39
—	24-8559	1996-up XLC	39
—	24-8562*	1988-99	39
—	24-8566*	2000-03 XL	39



**39mm Chrome Fork Assembly** fits XL models.

Kits include:

- Chrome Triple Tree Set
- Chrome Fork Sliders
- Chrome Left Side Caliper
- 11.5" Polished Stainless Steel Brake Disc
- 19" or 21" Wheel Assembly
- Axle
- Fender
- Riser Bushings
- Bearing Set

VT No.	Year	Wheel
24-0991	1982-99	21"
24-0992	1982-99	19"
24-1050	2000-03	21"
24-1051	2000-03	19"
24-1054	2004-up	21"
24-1053	2004-up	19"

# Fork Brace



**39mm Chrome Fork Braces** are machined from Billet aluminum, easy to install and offers increased torsional rigidity. Fits 1987-up XL by clamping over chrome dust boots.

VT No. 24-0841



24-0841 Installed



**Tweek Bar Fork Brace** is a two piece design of polished alloy that clamps directly to fork tube.

VT No.	Size	Fits
24-0824	35 mm	1973-87
24-0823	33.4 mm	1952-72



24-1036



24-1040

**Fork Brace** fits 2010-up XL 1200X.

VT No.	Finish
24-1036	Chrome
24-1040	Black



**35mm Chrome Forged Aluminum Fork Brace** add rigidity to forks by clamping to fork seal area of lower leg. Fits XL with Showa forks.

VT No. 24-0323

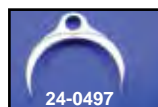

**39 mm Kwik-Klip** attaches brake line or speedo cable to fork leg.  
VT No. 24-1023



# 39mm Triple Tree

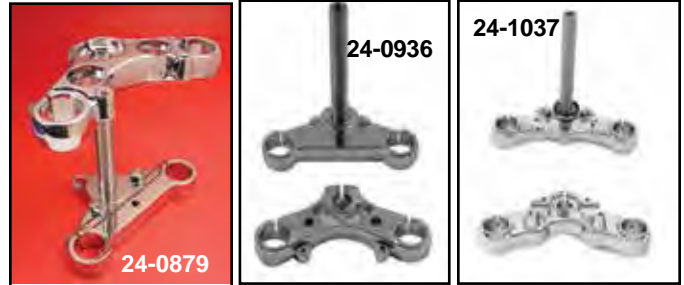

**Chrome Triple Tree Sets** include upper and lower trees to fit 39mm fork tubes as stock on 1990-up.

VT No.	Years
24-0879	1990-03
24-0936	2004-up
2272-5	Screws
24-1037	2011-up "48"



**Chrome Top Triple Tree** for 1988-up.

VT No.	Year
24-0865	1988-2003
24-0898	2004-up
24-1034	2010-up "48"



**Chrome Lower Triple Tree Cover** fits 39mm forks 1987-up designed for easy installation.  
VT No. 42-0342



**Lower Fork Stem Retaining Ring** for 1986-up all models. Replaces 45611-86.  
VT No. 12-0979



**Upper Bracket Cover** fits 1988-up XL-FXD 39mm forked models, when using a custom bottom mount headlamp.

VT No.	Item
42-0861	Cover
2272-5	Screw Set

## 39 mm Lower Tree Applications.

VT No.	Fits	Finish
24-0856	1988-03 XL 1200 1995-03 XL 883	Polish
24-1020	As Above	Chrome
24-0857	1996-2003 XLC	Polish
24-0665	As Above, XLC	Chrome
24-0858	1988-94 XL 883	Black
24-0897	2004-up XL's	Chrome
24-1035	2011-up "48"	Chrome

## Steering Stabilizer Kit

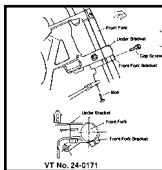

**Billet Fork Stop** to be mounted to billet triple tree sets to allow for fork stops. Drilling of tree may be required.

VT No. 24-0749

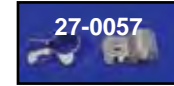

**Chrome Steel Mount Clamp** with 3/8" mount hole. Use to mount damper body to frame tube. Sold as a pair.

VT No.	Inner Diameter
27-0057	1"
27-0059	1 1/4"



**Stop Plate** mounts to custom triple trees under lower bearing for 39mm and 41 mm forks.

VT No. 24-0894



**Steering Damper Fork Tube Clamp** in alloy finish available in 2 piece design for attaching damper end to fork tube.

Size	VT No.
39mm	24-0657
41mm	24-0658

**39mm Steering Stabilizer Kit** includes brackets and adjustable round body dampener piston. Fits 883-1200.

VT No.	Year
24-0171	1988-03
24-0172	2004-06
24-0664	2007-up



**Steering Damper** is heavy alloy universal, multi-position, and adjustable, can be secured between the frame and most forks. Fork tube and frame clamps sold separately.  
VT No. 24-0168





# 41mm Narrow Glide

41 mm Narrow Glide will replace 39 mm assembly on XL models. Use with original wheel and brake assembly from 1984-03. Wheel not included.

VT No.	Item	Type
24-1275	Fork Assembly	Dual
24-1276	Fork Assembly	Single
52-0170	19" Wheel	Single/Dual
52-0171	21" Wheel	Single/Dual
44-0852	Axle	Dual



**Fork Cover Sets** fit the space between the triple trees and cover the fork tube like the 1960's styling. **Note:** Will not fit "48" models, required front fender removal 14" long.

1986-03	2004-up	Finish
24-1316	24-1318	Black
24-1315	24-1317	Chrome

## 39mm to 41mm Conversion Kit



**Narrow Glide Conversion Kit** allows use of 41mm leg assembly, 1984-99 style and utilizes the original FXD or XL 19" or 21" wheels, and the caliper and brake disc from the original motorcycle. 24-0958 is shown with stock leg assembly 24-0510 FXST style.

**Narrow Glide Conversion Kit** to fit FXD-XL 39mm models includes upper and lower triple trees, stem, stem nut, fork stops, axle, axle spacers and fender spacers. For use with 1984-99 FXST/FXDWG 41mm fork leg assemblies and 1984-99 narrow glide 19" or 21" wheel assembly with aluminum hub and front fender. Accepts OEM 11.5" brake disc and caliper (custom brakes may cause interference with laced wheels). Measures 4<sup>9</sup>/<sub>16</sub>" between fender mounts. For front wheel speedometer operation, replace left side axle spacer with speedometer drive unit.

VT No.	Item
24-0958	Kit
36-2450	Speedometer Drive





42-0308



42-0291



42-0290

**Chrome Lower Fork Stem Covers** for 1957-85 with 35mm forks. VT No. 42-0290 can be installed without disassembling forks. VT No. 42-0308 replaces 45750-70 in one piece style.

VT No.	Type	Style
42-0308	1 Piece	Smooth
42-0291	1 Piece	XLCH
42-0290	3 Piece	Smooth
8757-8	Allen Screws for Above	



**Top Triple Tree for Sportsters.**

VT No.	OEM	Year	Finish
24-0801	45739-62B	1954-72	Cast
24-0802	45738-73	1973-87	Cast
24-0803	45738-73	1973-87	Polished
24-0826	45736-78B	1973-87	Chrome
28-1503	Bushing Set	1954-99	
37-0860	Screw Kit	1962-86	



**Fork Stem Lock Tabs** replace broken, bent or missing on stock lower triple trees, to be welded on. Fits 1981-83 XLH.

VT No. 51-0099

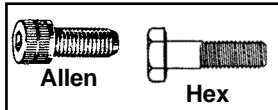

**Lower Stem Pinch Bolts.**

VT No.	Type	Finish
37-8834	Hex	Zinc
37-9220	Allen	Chrome



37-9220

## 33 and 35mm Triple Tree



24-0808



24-0855

**Lower Trees.** Steel construction.

VT No.	OEM	Years	Tube Size (mm)
24-0807*	45703-71	1957-72	33.4
24-0808	45703-73	1973-77	35
24-0930	Chrome	1973-77	35
24-0809	45703-78	1978-81	35
24-0810	47693-81	1982-87	35
24-0855	Chrome	1982-87	35

\*Note: Requires use of 15/16" tapered bearings.

## Top Stem Nuts



**Chrome Fork Stem Nut Cover** to fit over stock stem nut and held in place by set screws. Cover is one piece.

VT No.	Fits
24-0636	1971-87 35mm fork
24-1336	1980-up 39mm fork



8809-6

**Stem Bolt and Cover Kit** includes sleeve, stem bolt, dust shield, spacer rubber plug and chrome cover. Fits all 1957-78 without steering damper.

VT No.	OEM	Item
8809-6	Kit	Nut Kit and Cover
8810-2	Kit	Cover
24-0223	45752-52	Spacer
24-0224	45721-54	Sleeve



9978-2

**Chrome Domed Shaped Fork Stem Nuts.**

VT No.	Fits
7618-1	1952-77
7618-1T	1952-77
37-0598	1952-77
7619-1	1978-87
7619-1T	1978-87
9978-2	1988-up



37-8137

**Chrome Flat Top Stem Nut** replaces 45718-71 on 1978-87.

VT No.	Item
37-8137	Nut
9963-1	Washer
37-0988	Washer



37-0443

**Acorn Stud** for use on 1987-up FXR-FXST. Order nut separately.

VT No.	Item
24-1209	Stud
37-0443	Acorn Nut



24-0637



37-9073



37-9073 Installed



24-1278

**39mm Chrome Fork Stem Nut Covers** fit over stock stem nut and held in place by set screws. \*Note: Includes (2) fork tube cap covers and (1) stem nut cover for 1988-up XL 883-1200.

VT No.	Fits	Type
24-0637	1988-up XL	Stem Only
37-9073*	3 piece Set	Flat
24-1278*	3 piece Set	Dome
24-1296*	3 piece Set	Pointed





# Chrome Fork Tube



**Fork Tubes** are precision machined with ground finish for fit and quality. Available in chrome or hard chrome as stock. Sold in pairs.

## 39mm

**1988-08 XL models 883-1200, 39mm except Hugger**

**24-0020** 23 $\frac{3}{8}$ ", Hard Chrome

**24-0434** 23 $\frac{3}{8}$ ", Chrome

**24-0019** 25 $\frac{3}{8}$ ", Chrome

**24-0439** 27 $\frac{3}{8}$ ", (+2") Chrome

**24-0442** 29 $\frac{3}{8}$ " (+4") Chrome

**2009-up All XL models except XL883L, XL1200L, XL 883N, XL 1200N**

**24-0390** Stock Hard Chrome

**24-0391** 2" over stock

**24-0392** 4" over stock

**24-0393** 6" over stock

## 35mm

**1975-83 XLH-XLCH-XLCR, 1983 XLX-XLS**

**24-0013** Stock 23 $\frac{1}{4}$ ", replaces 45407-75, Hard Chrome

**24-0425** 2" over stock, replaces 45644-77

**24-0426** 4" over stock

**24-0427** 6" over stock

**24-0428** 8" over stock

**1979-82 XLS models, Showa Fork. 35mm.**

**24-0425** Stock 25 $\frac{1}{4}$ " replaces 45644-77

**24-0014** As above Hard Chrome

**24-0426** 2" over stock

**24-0427** 4" over stock

**1973-74 XL, Kayaba Fork. 35mm.**

**24-0015** Stock 23 $\frac{1}{2}$ ", replaces 45977-73, Hard Chrome

**24-0421** 2" over stock

**24-0422** 4" over stock

**1973-74 XL**

**24-1073** Stock 23 $\frac{1}{2}$ "

**1984-E86 XL, except sport pkg. 35mm.**

**24-0016** Stock 23 $\frac{1}{4}$ ", replaces 45407-83, Hard Chrome

**24-0430** 2" over stock replaces 45392-83, Hard Chrome

**L1986-87 XL, 35mm.**

**24-0434** Stock 23 $\frac{1}{4}$ " replaces 45407-86

**24-0435** 2" over stock

**24-0436** 4" over stock

## 33.4mm

**1954-72 XL**

**24-0012** Stock 22 $\frac{3}{4}$ " replaces 45953-71, Hard Chrome



# 35 and 39 mm Fork Tube and Slider Assembly

**Fork Tube and Slider Assembly** available in right and left pairs, completely assembled. Units have hard chrome fork tubes, and either polished or chrome lower sliders, with springs and all internal components installed.

## 39mm

VT No.	Disc	Fits	Slider
<b>24-0590</b>	Single	1994-99 XLH	Chrome
<b>24-0984</b>		2000-03 XL	Chrome
<b>24-0384</b>		2004-up XL	Chrome

## 35mm

VT No.	Disc	Fits	Slider
<b>24-0589</b>	Dual	1977-84	Chrome



**39 mm Fork Tube Assembly** includes internals with springs, assembled for 1987-99. Tube length is 23 $\frac{3}{8}$ ".

**VT No. 24-0107**



**39mm Chrome Single Disc Lower Fork Sliders** for XL's.

VT No.	Fits
<b>24-0373</b>	1988-99
<b>24-0079</b>	2000-07
<b>24-0353</b>	2008-up
<b>2273-7</b>	Bolt Set



**Attention!!**  
These fork tubes have been manufactured and tested for exact fit and application per model. It can be difficult to identify the front end assemblies because they may not always be original equipment. Before installing, compare old and new tubes. Be sure the stock top plugs fit into the new fork tubes. To avoid scratching the chrome, we suggest that the tubes be lightly rubbed with oil before installing into fork legs. Be absolutely sure you have the right tubes before you install them. No fork tubes can be accepted for return that are scratched or damaged due to improper installation or handling.

**Note: See Vintage section for 1952-72 components.**



**E-Z Fill Fork Tube Top Plugs** feature a small oil fill cap built into fork tube top plug which will allow fork oil change/fill without removing top fork cap. Pairs.

VT No.	Type	Fits
24-0862	35 mm	1973-85
24-0863	39 mm	1988-up



**Chrome Top Fork Tube Plug** replaces 45756-59. Sold each. For 1957-72.  
VT No. 7621-1



**Fork Tube Spring Retainers and Pin Wrench Kit** includes 2 retainers for 1952-72 XL and pin wrench for installation removal of retainers.  
VT No. 7700-3

## 33.4, 35 & 39 mm Fork Plug



### Chrome 35 mm Fork Plugs.

VT No.	#	OEM	Year
7622-1	A	45993-73	1973-85
7622-1T	A	45993-73	1973-85
37-8988	A	As Above	Pair
24-0166*	B	45933-74	1974-85
8863-1	A	45993-86	Late1985-Mid87

\*Note: 24-0166 is drilled and tapped to accept gauge mounts.



### Chrome 39 mm Fork Plugs. Replace 45596-87.

VT No.	Year	Type	UM
9914-2	As Above	Domed	Each
24-0335*	1988-up	Flat top type	Pair

## Fork Spring



**Fork Tube Spring Sets** feature high tensile strength wire construction with ground ends. Sold in pairs for OEM replacement per the factory number. For more fork spring applications check factory parts book.

VT No.	OEM	Fits	MM
<b>33.4mm</b>			
24-0822	46057-52	1952-70 XLH-XLCH	33.4
24-0900	46057-71	1971-72 XLH	33.4
24-0901	45984-73	1973-74 XL	35
24-0904	45408-75	1976-83 XLH-XLCH	35
24-0903	45987-77	1979 XLS	35
24-0905	45907-80	1980-83 XL	35
24-0906	46052-80	1980-82 XLS	35
24-0913	45376-87	1987-94 XL	39
		Except Hugger	
24-0933	45372-92	1992-96	39
24-0919	45376-97	1997-2003	39
24-0932	45376-04	2004-2008	39



**Progressive Suspension Fork Lowering Kits.** Each kit comes with Progressive rate fork springs and spacers. Each kit can be installed at two different levels to lower fork 1" or 2".

VT No.	Fits
24-1560	1988-up
24-1559	1984-87



### 20th Century Fork Spring

**Lowering Kits** for Showa forks have progressively wound springs that resist bottoming out. Installation requires minor disassembly to lower the front forks 1 1/4" or 2" depending on the spacer used. Kit includes springs, spacers and hardware. Easily converts back to stock by reinstalling stock fork springs.

VT No.	Type	Model
24-0160	39mm	1987-95
24-0161	35mm	1975-87



### 39mm Street Tough Fork Springs

by 20th Century Suspension. Progressively wound springs are made using drawn spring wire. Eliminate front end sag, reduce nose dive under braking and improve stability. Fits 1988-91 Showa. VT No. 24-0164



**Progressive Suspension Fork Springs** feature high quality, high performance replacement fork springs that eliminate front end sag, reduce nose dive under braking, improve cornering stability, increase ride comfort and allow forks to utilize full travel. Sold in pairs.

VT No.	Size	Fits
24-0883	39	2004-up XL
24-2056	39	1988-up XL except Hugger
24-2045	39	1992-up XL Hugger
24-2040	35	1952-87 XL-XR





# Fork Damper Tube



**Fork Damper Tubes** less hardware, pairs.

VT No. OEM Fits

39mm

24-0464 45925-88 1988-93 XL

24-0476 45925-94 1994-96 XL

24-0477 45925-97 1997-08 XL

24-0676 45462-87 1987-up XL, Nylon Ring

24-0677 45460-90 1990-up Dynaglide Nylon Ring

35mm

24-0096 45409-75 1975-83 XL Showa

24-0675 45412-75 1975-86 Nylon Ring

**Fork Damper Tube Kit** includes for 2 sides, damper tubes with rings, screws and washers, lower stops, slider seal washers and retaining rings.

VT No.	Type	Fits	MM
24-0454	Steel Leg	1971-72 XL	33.4
24-0457	Kayaba	1973-76 XL	35
24-0446	Showa	1976-83 XL	35
24-0473	Showa	1988-93 XLH	39
24-0474	Showa	1994-96 XLH	39
24-0475	Showa	1997-up XLH	39

### Damper Tube Screw.

VT No.	OEM	Type
24-0188	45995-73	Kayaba, 1973-86
24-0787	45405-75A	Screw pair with washer, showa
24-0786	Showa	Screw only, 5 pack

### Damper Tube Washers in 10 pack.

VT No.	OEM	Fits
14-0017	45992-73	1973-74 XL Kayaba Fiber
14-0018	45406-75	1975-up XL Showa Copper



**1952-70 Internal Conversion.** Send us your lower Sportster legs, we will update by drilling to accept later 24-0454 damper tube kit. New bushings can be added at the same time for an additional charge.  
VT No. 60-0235

### Lower Damper Tube Springs.

VT No.	OEM	Fits
13-9210	46062-71	1971-72, pair
13-9160	45382-83	1983-86, 10 pack
13-9258	45374-87	1987-up, pair

### Lower Damper Tube Stop, sold in pairs.

VT No.	OEM	Fits
24-0459	45918-73	1973-77 XL Kayaba
24-0094	45402-75	1976-83 XL Showa
24-0460	45403-84	1984-87 XLH
24-0466	45463-87	1988-89 XL
24-0375	45361-90	1990-up XL

# Fork Drain Plug



**Fork Drain Screws** are supplied with washers, pair.

VT No.	Use	Finish
9907-4	1952-72 XL-K	Chrome
9908-4	As Above	Cadmium
9910-4	1973-up Showa	Chrome
24-0010	1976-up Showa	Chrome

**Drain Screw Fiber Washers** available in 10 packs.

VT No.	OEM	Years	Use
14-0959	6218W	1952-72	Early XL
14-0019	45986-73	1973-75	Kayaba
14-0020	45403-75	1976-up	Showa

**Chrome Fork Slider Axle Cap** is for the left side. Cap is of alloy material with a chrome finish. Fits 1975-83 models with 35 and 39 mm fork tubes. Replaces 45410-75.

VT No. 24-0505





# Fork Boot Cover

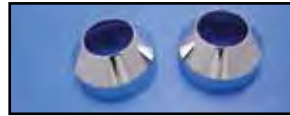

**Chrome Wiper Boot Covers** are die cast to fit over the stock rubber fork wiper boot.

VT No.	Type	Year	MM
24-0104	Kayaba	1973-74 XLH	35
24-0105	Showa	1975-87 XL	35
24-9939	Showa	1988-up XL	39



**Black Rubber Fork Boots** are designed for a better fit and improved sealing and wiping action. Sold pairs.

VT No.	OEM	MM Fits
28-0900	46001-71	33 1971-72
28-0902	45983-73	35 Kayaba forks 1973-74
28-0903	45404-75	35 Showa forks 1975-87
28-0905	—	35 As Above White



**39mm Fork Boot Cover Dust Shield Kit** fits 1988-up.

VT No.	Item
24-0090	Complete Kit
14-0956	Seals only

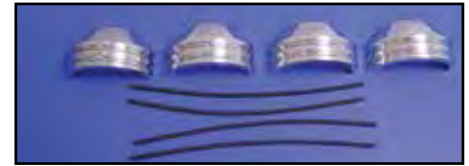

**Two Piece Chrome Fork Boot Cover Sets** install overstock rubber fork boot by the unique interlocking springs, supplied with the kit, to securely hold boot covers in place. 35 mm. Fits 1973-87.

**VT No. 24-9992**



**Gaiter Fork Boots** are flexible type for 39mm forks. Rubber boots are 230 mm long, black, sold as a pair.

**VT No. 28-0440**



**39mm Fork Gaiter fits** Nightster XL-FXD.

VT No.	Type
28-0758	XLN
28-0885	V-Twin

# Fork Seal Kit



**GB Deluxe Fork Seal Rebuilding Kits** include all pieces illustrated as appropriate for each application.

VT No.	Fits	Size
14-0702	1973-74 Kayaba	35 mm
14-0703	1975-84 Showa	35 mm
14-0704	1988-15 Showa	39 mm
14-0705	1984-87 Showa	35 mm



**V-Twin Deluxe Seal Kits** include seals, gaskets, snap rings, washers and o-rings.

**James Kits** include seals and o-rings only.

James VT No.	MM	Year	Fits
— 14-0043	33.4	1952-70	XL-XLH, Gasket only
14-0039 14-0940	33.4	1971-72	XLH-XL
14-0040 14-0941	35	1973-74	XLH, Kayaba
14-0041 14-0942	35	1975-84	XL Showa
14-0044 14-0998	35	1984-87	XL
14-0042 14-0943	39	1988-15	XL



**Leak Proof Fork Seals** feature a Teflon coating to reduce drag and carry a manufacturer's lifetime guarantee, sold in pair.

VT No.	Size	Year
14-0250	35 mm	1973-74 XLH-XL Kayaba
14-0251	35 mm	1975-87 XL, Showa
14-0024	39 mm	1988-up XL



**Fork Seal Sets** are molded with factory part number, sold in pairs for XL models.

VT No.	OEM	Years	MM
14-0010	45975-71	1971-72	32.5
14-0013	45927-73	1973-74	35
14-0011	45400-75	1975-82	35
14-0016	45387-83	1982-87	39
14-0021	45378-87	1988-up	39
14-0956	45401-87	1988-up	Dust Seal

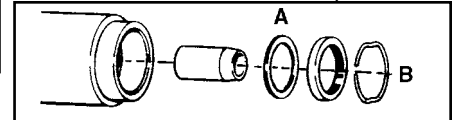

**A-Slider Seal Washers** are zinc plated.

VT No.	OEM	Year
24-0642	45928-73	1973-76
24-0091	45911-80	1980-83

**Fork Seal Retaining Ring.**

VT No.	OEM	Year	Model
24-0641	45931-73	1973-76	XL
24-0613	45401-75	1975-80	XLH
24-0614	45908-80	1980-87	XL
24-0623	45905-87	1988-up	XLH



**Fork Seal Spacer** fits 1986-87. Replaces 45386-83.  
**VT No. 24-0627**





# Neck Cup Kit



**Ball Bearing Neck Cups** available in pairs as zinc cups only or chrome kit with races and balls. Fits 1952-77 Sportster.

**Note:** Sportsters use 28 ball bearings.

VT No.	OEM	Finish
24-0110	48310-30	Zinc Cups
24-0135	Cpt. Kit	Chrome
24-0195*	Cpt. Kit	Chrome
12-0157	8860	5/16", Balls 50 piece
12-0128	8860	5/16", Balls 30 piece
24-0099	48346-39	Upper Race
24-0621	48347-52	Lower Race

**\*Note:** Includes top nut, sleeve and dust cover.



**Fork Stem Bearings and Races.**  
Order separately as noted for 1982-up XL.

VT No.	OEM	Item	U/M
24-0118	48360-60	Bearings	Pair
12-0384	Peer	Bearings	Pair
12-0335	Timken	Bearing	Each
12-0348	48315-60	Race	Each
12-0383	Peer	Race	Each



**Neck Cup Kit** features solid internal fork stops that are built into the cups and hidden away. Fits stock and custom rigid frames that accept stock XL neck cups. Kit includes cups, races, bearings and covers. Drilling and triple tree

required at bearing area. Fits 1957-81.

VT No. 24-0236



**Neck Cup Kits** for Sportster to convert 1952-77 ball bearing style cups to Timken tapered type. Complete conversion kit includes two (2) chrome cups, two (2) tapered bearings and dust shields, 1978-up types are for stock replacement.

VT No.	OEM	Year	Item
24-0225	Kit	1952-77	Complete Kit
24-0232	Set	1952-77	Bearing Set
24-0233	Set	1952-77	Dust Covers
24-0157	Set	1952-77	Cups with Races
24-0338	48310-78	1978-81	Cups with Races
24-0101	45586-78	1978-81	Bearing Set
12-0354	As Above	Each	
24-0221	45597-78	1978-81	Upper Dust Shield
24-0619	48370-78	1978-81	Lower Dust Shield
24-9935	All	1978-81	Kit with 2 Dust Shields
24-9936*	All	1982-up	Kit with 2 Dust Shields
24-0118	Set	1982-up	Bearings Only
24-1098	Set	1978-81	Cups without races

**\*Note:** Does not include neck cups.



**Dust Shield Sets** include upper and lower for 1982-up.

VT No.	Finish
24-0117	Zinc
24-0114	Chrome



**Dust Shields** zinc plated.

VT No.	OEM	Fit	Model
24-0221	45597-78	Upper	1978-81
24-0618	48361-80	Upper	1982-up
24-0112	48365-48A	Lower	1982-up
24-0619	48370-78	Lower	1978-81
24-0111	48370-52	Upper	1952-78
14-0174	48184-01	Upper/Lower	2001-up

## "Raked" Neck Cups



**1982-up "Raked" Chrome Neck Cup Kit** includes longer stem. Rake requires long fork tubes and neck lock cannot be retained.

VT No.	Stop	Year	Degree
24-0294	Tab	1988-03	3°
24-0376	Plate	1982-03	3°
24-1285	Plate	1982-03	5°
24-1267	Plate	1982-03	7°

**"Raked" Chrome Neck Cup Kits** provide 3° rake when installed.

VT No.	Year
24-0289	1952-77
24-0291	1978-81

**Note:** Rake Neck Kits are for **Show Applications** only and **Require** longer Fork Tube to be **Installed**.



# Kickstand

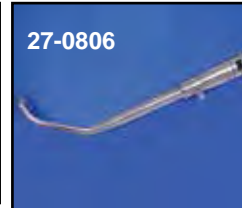
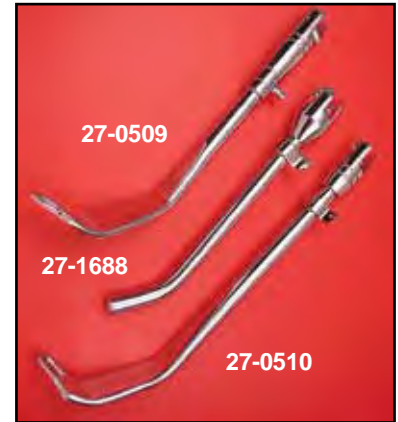

## 1984-up Kickstands.

VT No.	Year	Item
27-0520*	1990-03	Short Stand
27-0047	1984-88	Stock Stand
27-1515	1984-88	Extended Stand
27-0048	1984-88	Catch
13-9159	1984-88	Spring
27-1668	1989-03	Stock Stand
37-9153	1989-up	Pin
13-9162	1989-up	Spring
<b>2004-up</b>		
27-1672	2004-up	Stock Stand
27-1730	2004-up	1" Lower
27-0946	2008-up	Stock
27-0823	2011-up	Stock
27-0492	2011-up	Stock
27-0019	2004-up	Stock, Gloss Black
27-0020	2004-up	1" Lower, Gloss Black
27-0828	2004-up	Chrome Kickstand Kit
27-1516	1989-03	Bushing Set
37-9153	1989-up	Pin
13-9162	1989-up	Spring

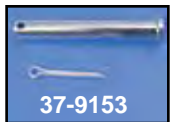

## Forged End Kickstands in chrome.

VT No.	OEM	Years	Length
27-0806	—	1952-83	Stock
27-0509	50006-80	1952-83	Stock
27-0689	—	1957-83	Stock
27-1688	50062-52A	1952-79	Stock
27-1733	—	2"	Short
27-0510*	Extended	1952-83	11.5"
37-9117	Fits 27-0509 and 27-0510	—	Pin
27-1500	Fits 27-1688	—	Pin

\*Note: For use with +2" or +4" forks.

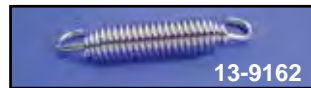
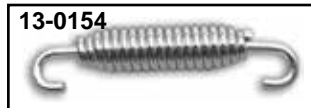

## Chrome Kickstand Springs

VT No.	Years
13-0154	1952-83
13-9159	1984-88
13-9162	1989-06
13-0545	2007-up
28-2234	1990-07 Bumper Stop

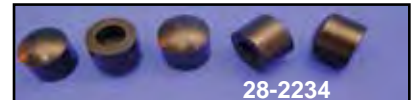

**Weld On Kick Stand Assembly** includes weld on type heavy duty mount, chrome spring and chrome kick stand with forged flat end.

VT No.	Item
27-0257	Kit
27-0795	Bushing

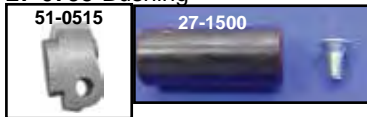

**Kickstand Tab and Pin** for 1952-83. Tab is for weld on repair. Pin includes screw.

VT No.	Item
51-0515	Repair tab
27-1500	Pin kit



**1952-81 K/XL Center Stand** is constructed of cast aluminum and includes spring and hardware for mounting to stock swing arm frames. Replaces 49701-57. **VT No. 27-0548**

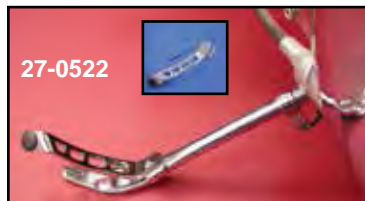

**Kickstand Extensions** allow rider to more readily access side stand. Replaces 50212-98 and fits 1984-up.

VT No.	OEM	Model	Finish
27-0522	50212-98	1984-2003 XL	Chrome
27-0025	50250-04	2004-up XL	Chrome
27-0801	Black	2007-up XL	Black

**Kickstand Extension Kits** include chrome mounting hardware and rubber type extended peg easier operation of kickstand.

VT No.	Fits
27-0093	2004-06 XL
27-0094	2007-up XL

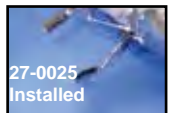





# Driver Footpeg Support



27-1624



27-1735

**Driver Peg Support Bars** are the splined type, less pegs fit 1952-74. Replaces 50948-71 left, 50949-67 right. Use with large female type driver pegs.

VT No.	Finish
27-1624	Zinc
27-1735	Chrome



**Chrome Forward Control Footrest Support** fits XLC models with forward controls. VT No. 27-0010

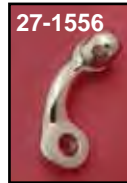

27-1556

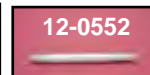

12-0552



27-0044

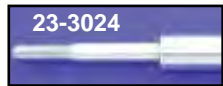

23-3024

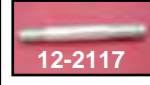

12-2117

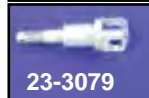

23-3079

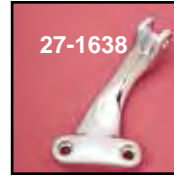

27-1638

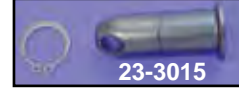

23-3015



23-1728



23-0780



23-3080

## Foot Rest Supports and Studs.

VT No.	OEM	Years	Item
<b>Left Side</b>			
27-1556	50948-75	1977-85	Support
12-0552	24752-75	1977-85	Stud
27-1638	50951-90	1991-03	Support
27-0817	42972-04	2004-up	Support

## Right Side

23-3024	34886-86A	1986-90	Stud
27-1577	50949-75	1977-79	Support
12-2117	247751-75	1977-79	Stud
23-3079	42441-90A	1991-03	Peg Clevis
23-3015*	42441-80	1980-90	Pivot-Stud
23-0780	42971-04	2004-up	Support
23-1728	34909-83	1983-90	MC Support Bracket
23-3080	34909-90	1991-03	MC Support Bracket

\*Note: Acts as foot support brake pivot.



27-1577

# Rear Peg Mounts



**Passenger Peg Mount Bracket Sets Only.** Use with male style peg.  
**Chrome Black** Years  
 27-1564 — 2004-13  
 27-0825 27-0271 2014-up



27-0633



27-0634

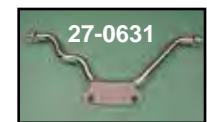

27-0631



A 27-1686



B 27-1685



D 27-1687



C 27-1561

**Rear Passenger Peg Mounts (D)** Replaces 50610-86 on 1986-2003 models, to mount rear passenger pegs to swing arm. Choose pegs to complete or order kit.

VT No.	#	Item
27-1686	C-A	Kit
27-1685	C-B	Kit
27-1687	C-D	Kit
27-1561	C	Mounts Only



**Rear Passenger Peg Relocation Bracket Set** fits 2004-13 XL with 30-0300 pipe set. Black finish. Order chrome footrest for support bracket separately.

VT No. 31-0766



VT No. 27-0634 Shown on motorcycle



**Chrome Rear Footpeg Brackets** bolts to rear motor mount bolts, for use on Rigid or Swing Arm frames.

VT No.	Fits
27-0633	1957-78 Sportster, uses large female Driver pegs 27-1215, 27-1220 and 27-1581
27-0634	1982-90 XL use 27-1227 Small Male Pegs
27-0631	1957-81 except 1979 use 27-1227 Small Male Pegs

# Luggage Rack



**Chrome Sissy Bar Luggage Rack** of solid steel fits all 16" tall sissy bars, unique design for easy installation or removal. Mount holes are 2 $\frac{5}{8}$ " center to center and 5 $\frac{1}{4}$ " wide. May require drilling for some applications.  
 VT No. 50-1011



**Chrome Eagle Spirit** is a 3 $\frac{1}{2}$ " universal medallion, adhesive backed. VT No. 42-0532

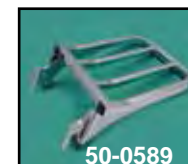

50-0589



50-0847



50-0841

**Bolt On Luggage Racks** mount to rigid side straps of sissy bar on 2004-up XL models.

VT No.	Model
50-0589	Rack
50-0847	Side Plate
50-0841	Sissy Bar Top



# Sissy Bar

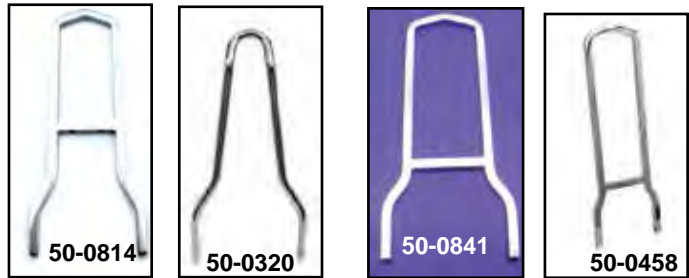
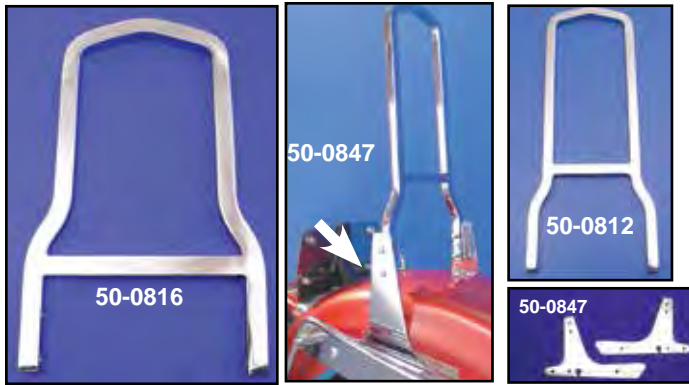

Sissy Bar Side Strap & Back. Order top and straps separately.					
Fitment	Side Straps	16" Back	11" Back	20" Back	Sissy Bar Back Width
2004-up	50-0847	50-0841	50-0842	50-0461	7½"
2004-up	50-1198				Black, Side Plates
		50-1514			Round, Black
		50-1192			Round Chrome
1994-03	50-0807	50-0812	50-0816	50-0458	6¾"
1994-03			50-0893		Round
1979-93	50-0808	50-0813	50-0817	50-0459	8"
1979-93			50-0320		8" Round
1957-78	50-0810	50-0814	50-0818	50-0460	7¾"
1957-78			50-1192		7¾" Round
1979-93			50-0323		Round
Screw Set	37-1509				



**Sissy Bar Grab Rail Combo.**  
VT No. 50-0503

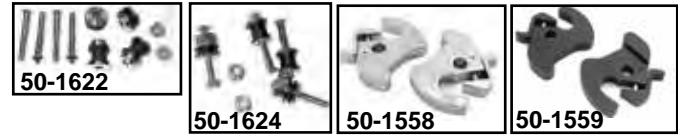

**Detachable Side Plates and Dockable Hardware.**

Side Plate	Hardware	Year
50-1621	50-1622	2004-up
50-1623	50-1624	1994-03
	50-1558	Cam Lock, Chrome
	50-1559	Cam Lock, Black
	50-1651	Mounting Kit for detachable rack
	31-1315	Bushing Set (2)
	31-1316	Bushing Set (2) Narrow
	31-1304	Bushing Set for docking points (2)
	50-1512	Stainless Steel Bushing Set (4)
	31-1300	Bushing Set, Narrow, Chrome
	31-1301	Bushing Set, Narrow, 53697-06
	31-1302	Bushing Set, Narrow, 53942-04
	31-1303	Bushing Set, Wide, 53943-04
	31-1312	Bushing Set, Narrow, 53967-06



**Sissy Bar Inserts.**

VT No.	Type	Finish
50-0820	Cross	Chrome
42-0045	Skull	Brass
42-0156	Eagle	Brass



**Sissy Bar for 2004-up XL.**

Solid	Detachable	Height
50-1634	50-1625	20"
50-1626	50-1627	16"
50-1628	50-1629	11"
50-1630	50-1631	Grab Rail
50-1542		16" Round

XL





# Belt Guard



27-1667



27-0123



27-1745



27-0862

## Chrome Belt Guards.

VT No.	Year
27-1667	1991-99
27-0123	2000-03
27-1745	2004-up
27-0862	2004-up



27-1645



27-0788



20-0784



27-0788  
Installed

## Chrome Lower Belt Guard for XL's.

VT No.	Year
27-1645	1991-2003
27-0788	2004-up
20-0784	2004-up



27-0112



27-1573

## Chrome Chain Guards with spatter apron.

VT No.	Year
27-0112	1983-87
27-1573	1988-92

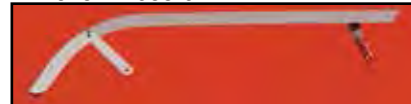

## Chrome Rigid Frame Chain Guard for Sportster.

VT No.	Item
27-0128	Guard
31-0710	Strap



27-0619



27-0542

## Chrome Guard/Rear Pulley/Dress Up Kit includes belt guards, upper and lower, and 61T rear pulley cover for 5-Speed belt drive models with hardware.

VT No.	Year
27-0541	1991-99
27-0542	2000-2003
27-0619	2004-up



42-0670



42-0934



42-7512

## Chrome Rear Pulley Cover. Order VT No. 37-8671 chrome torx bolt set separately.

VT No.	Year	Tooth
42-0670	1991-2003	61
42-0934	2004-up	68
42-7512	2004-up	68
42-1132	2004-up, Black	68



42-1132



## Universal Right Side measures 25" length. VT No. 27-0101



27-0102



27-0103



27-0401



27-0400

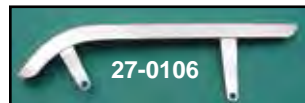

27-0106

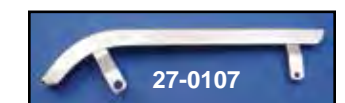

27-0107

## Chrome Chain Guards for Sportster.

VT No.	Year/Model
27-0102	1954-71 XLH
27-0103	1954-71 XLCH
27-0401	1972-78 XLCH
27-0400	1972-78 XLH
27-0106	1979-81 XLCH-XLH
27-0107	1982 only XL



# Front Fenders fit 35mm and 39mm Fork



50-0120



50-0392



50-0118



50-0119 unassembled



50-0932



50-0789

**Front Stock Type Fender** in raw steel, has chrome tubular type brackets riveted in place.

VT No.	Year	Type	Cable Bracket
50-0120	1970-83	Assembled	Right
50-0392	1970-83	Assembled	Left
50-0118	1970-83	Unassembled	
50-0119	1970-83	Bobbed	
50-0932		Bracket set	
50-0789	1984-91	Assembled	
37-6370	—	SS rivets, 25 pieces	



**Chrome Front Fender Allen Head Screws** to assemble brackets to stock front fender and attach fender to fork.

VT No.	Brand
37-6367	GW
2531-12	Colony



50-0133



50-0195



50-0196



50-1586

**Universal Sport Style Front Fender** is rolled on edge and in front. The brackets are not included.

VT No.	Type	50-0196	50-1141	50-1586
50-0133	Chrome (drilled)	Chrome	Raw	Rib, Raw
50-0195	Plain			
50-1141	Model 48"			



50-0690



**Chrome Front Fender Tip** fits stock front fenders, rear tail.

VT No.	Item
50-0432	Skull
50-0690	Tip Set



50-0122

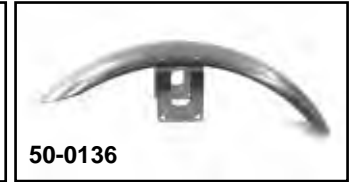

50-0136



50-0123



50-0164



50-0165



50-0889



50-0191



50-1140

**Narrow Type Front Fenders** for 35 or 39mm forks feature a raw or chrome steel fender with brackets riveted on to fit 19" wheels. 50-0122 fits 19" wheels on 1973-90 XLX models, 50-0164 fits 1973-up models with 21" wheel and 1991-up with 19" or 21" wheel.

VT No.	Finish	Brackets	VT No.	Finish	Brackets
50-0122	Plain	Chrome	50-0165	Raw	Raw
50-0136	Plain	Raw	50-0191	Chrome	Chrome
50-0123	Chrome	Chrome	50-0889	Raw	Raw
50-0164	Raw	Chrome	50-1140	Raw	Raw
			50-0270	Raw	Raw

### Rib Style

50-1583	Raw	Raw
50-1584	Raw	Chrome
50-1585	Raw	Chrome



**Spring Fork Style Front Fender** is the classic shape and flare in 5" wide for 19" and 21" wheels. Includes chrome braces. Fits 1973-up.

VT No. 50-0116



**Early Front Fender** for 1957-69 replacing 59007-52 stock fender, braces riveted on, raw finish.

VT No. 50-0129

## Fender Trim

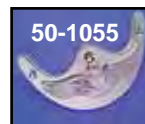

50-1055



50-1050



50-1049



50-0915

**Chrome Front Fender Tips** in stamped, includes screws. Fits fender width as noted.

VT No.	Style	Width	Models
50-1055	Eagle	4"	XLX
50-1050	Smooth	4"	XLX
50-1049	Smooth	5"	XL
50-0915	Eagle	5"	XL





# Steel Fender Kit

**EZ Bob Rear Fender Kit** for Sportster models includes steel fender and chrome taillight bracket which includes cateye 33-0306 taillight. Order chrome struts and covers separately.

VT No.	Item
50-0178	1979-81 Fender Kit
50-0787	1982-93 Fender Kit
50-0799	1994-03 Fender Kit
50-0856	2004-06 Fender Kit
50-0866*	2007-up Fender Kit

\*Note: Order taillight bracket and cateye taillight separately.

### Related Parts

50-0787A	1982-93 Fender
50-0881	Splash Insert (82-03)
31-0472	Taillight Bracket 1982-03
31-0991	Taillight Bracket 2004-up
33-0306	Cateye Taillight
50-1097	1979-81 Chrome Struts
50-0899	1982-89 Chrome Struts
50-1035	1990-93 Chrome Struts
50-1093	1994-03 Chrome Strut Covers



**Bobbed Rear Fender** mounts to stock strut bars. Fits 1994-03 with mounting holes.

VT No. 50-0253



**Fender Edge LED Lamp Kit** fits 2004-2014 XLs with chopped rear fender.

VT No. Color  
33-0069 Red  
33-0070 Smoke



**FL Style Rear Fender** fits 1982-up models must be drilled for installation.

VT No.	Width
50-0942	6.5"
50-0471	7.5"
50-0860	8"
50-1525	9.0"

**All Fenders Are Steel!**

When installing 04-up rear fenders on 2007-up models it will be necessary to cut out opening to accommodate the ignition module.



**EZ Bob Rear Fender Kit** for 1952-78 Sportster model includes a steel fender, cateye taillight, chrome taillight, bracket and chrome struts. Order sissy bar components separately.

VT No.	Item
50-0792	1952-78 Fender Kit
50-0929	Struts for Above
31-9030	Tail lamp Bracket for Above
50-0813	Lo Boy Sissy Top Bar for Above
50-0810	Side Straps



**Bobbed Rear Fender** for Rigid is 7¼ wide by 5½" deep raw finish with right cutout, 50-0927 includes bracket to accept taillight plate.

VT No.	Item
50-0151	Right
50-0927	Right, with bracket

# XL-XLCH Replica Rear Fender



**Steel Rear Fenders** mount to stock struts.

VT No.	OEM	Years
50-1068*	59609-52	1952-78
50-0148	—	1959-72
50-0149	—	1952-78
50-0145	Flared	1952-78
50-0146	59611-73A	1973-78
50-0147	59674-79A	1979-81
50-0153	59674-81A	1982-93
50-0183	59674-94A	1994-96
50-0184	59756-97	1997-98
50-0187	59674-99	1999-2003
50-0722*	Undrilled	1982-2003
50-0725*	Bobbed	1982-2003
50-0255	59847-04	2004-2009
50-1701	69847-04	2004-2009
50-0456	59865-07	2004-2009 1200N Only
50-0457*	Bobbed	2004-up
50-1700	Bobbed	2004-2009

\*Note: Holes must be drilled for mounting.

50-1528 Insert 2004-up  
50-1143 59865-10 2010-up 883N & 1200N



**Note:** VT No. 50-0146, 50-0147, 50-0153 accept VT No. 33-0301 (68008-73A) tail-light. 50-0148 accepts 33-0300 early tail-light (68006-64).

\*Note: VT No. 50-1068 XLH and K Style Rear Fender features full length style with rear flare, without tail light cut out, but includes internal reinforcement to mount 1955-72 type light, tombstone or beehive light.



**When installing 04-up rear fenders on 2007-up XL 883N, XL 1200N models it will be necessary to cut out opening to accommodate the ignition module on 50-0255, 50-0456, 50-1701 & 50-1700. 50-1700 has no cutout.**



Fender Extension Rubber Flap fits 1979-81.  
VT No. 28-0745



Chrome Rear Fender Bracket fits 1954-78. Reduces vibration between fender and frame, includes foam pad, replaces 59795-52A.

VT No. Item  
50-0912 Bracket with pad  
28-224 6 Foam pad only





# Strut Set

50-1035



50-0899



50-1097



50-1092



50-1082



50-1093



50-0238



Chrome XL Fender Strut Sets are of a die cast alloy construction.

VT No.	OEM	Year	Item
50-1035	59950-89	1990-93	Set
	59951-89		
50-1142	—	1990-93	Set
50-0899	59950-81B	1982-89	Set
	59951-81		
50-1097	52754-79	1979-81	Set
	52755-79		
37-9084	Allen Bolt Set	1982-up	Set
33-0016	59259-90	1990-93	Reflector, Red



Chrome Strut Covers for Sportsters fit over existing stock struts.

VT No.	OEM	Years
50-1092	59243-95	1982-89
50-1082	59541-95	1990-93
50-1093	59897-94	1994-2003
50-0238	59902-04	2004-up
	59903-04	



50-1188



Rear Fender Black Struts. Constructed of die cast alloy.

VT No.	Fits
50-1187	1982-89 XLH
50-1188	1990-93 XL



Fender Rail Bolt Kits attach struts to the rear fender.

Stock	Acorn	Cap	Allen	Fits
8880-18	—	—	2529-6	1952-58 K and XLCH
2626-18	—	—	—	1952-58 XL (Cadmium)
8881-18	7207-8	8462-8	—	1959-81
2665-18	—	—	—	1959-81 (Cadmium)
—	—	—	37-9050	1957-78
—	—	—	37-9084	1982-03
—	—	—	2274-10	2004-up



Chrome Steel Fender Strut Sets available in smooth or stock style with or without turn signal holes.

Smooth	Stock	OEM	Year	Fits
50-0908	50-0904	59930-52B	1955-78 XL	Without signals
—	50-1034	59934-73	1973-78 XL	With signals



27-0587

**Mega Footpeg Kit** features billet clamp set to attach to 1 1/4" engine bars.  
**VT No. Item**  
**27-0587** Footpeg Kit  
**27-0698** Bracket Set

# Chrome Front Engine Bar

**FOR ENGINE BARS LISTED ON THIS PAGE**  
**WARNING:** ENGINE/FRAME BARS MAY PROVIDE LIMITED LEG AND COSMETIC VEHICLE PROTECTION UNDER UNIQUE CIRCUMSTANCES (FALL OVER WHILE STOPPED, VERY LOW SPEED SLIDE). THEY ARE NOT MADE NOR INTENDED TO PROVIDE PROTECTION FROM BODILY INJURY IN A COLLISION WITH AN AUTOMOBILE OR ANY OTHER OBJECT.



27-0660  
Installed

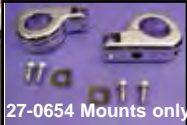

27-0654 Mounts only



27-0654

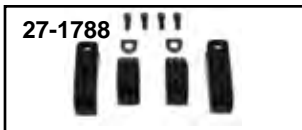

27-1788

**Chrome Billet Engine Bar Footpeg Mount Kit** fits on 1 1/4" front engine bars with male pegs.

**VT No. Item**  
**27-0660** Kit  
**27-0654** Chrome, Mounts Only  
**27-1788** Black, Mounts Only 1 1/4" Bar



27-0032

**Chrome Footpeg Mount Kits** include clamp set and extension bars to accept male pegs.

**VT No. Size**  
**27-0032** 1"  
**27-0033** 1 1/8"  
**27-0034** 1 1/4"

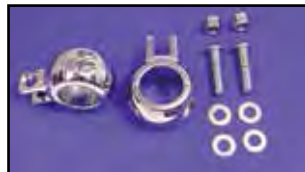

**Bar Clamps** fit 1 1/4" engine bars to mount male footpeg sets.  
**VT No. 27-0892**



**Footpeg Mount Kit** allows male-type pegs to be mounted to 1 1/4" diameter engine bar.  
**VT No. 27-0651**

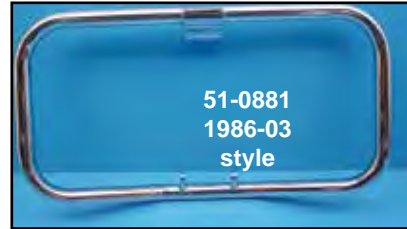

51-0881  
1986-03  
style



51-0886  
1956-81  
style



51-0939

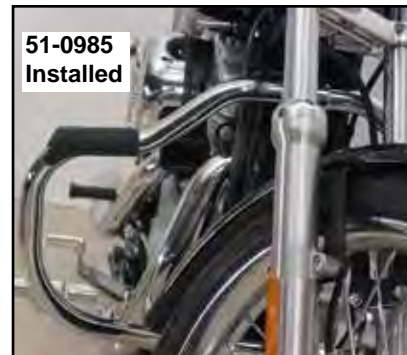

51-0985  
Installed

## XLH-XLCH 1 1/4" Diameter

VT No.	OEM	Fits
51-0886	49042-56A	1956-81
51-0881	49018-88C	1986-03
51-0888	With Pads	1986-03
51-0939	49060-04	2004-up
51-0985	W/Pads	2004-up

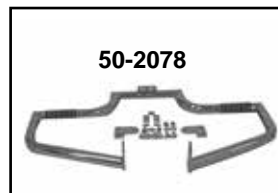

50-2078

**Lindby Custom Front Highway Bars** with footpegs feature 1 1/4" tubing and built in O-Ring pegs. Fits XL models without forward controls.

**VT No. Fits**  
**50-2078** 2011-up  
**14-0977** Replacement O-Ring





# Shock Stud Kit



**Shock Stud Kits** include all pieces for upper and lower positions. Including washers, nuts and lockwashers as necessary. Studs and bolts are zinc plated. Outer nuts and washers are chrome.

VT No.	Years	VT No.	Years
54-0460	1956-74	54-0449	1982-85
54-0448	1979-81	54-0450	1986-90
		54-0451	1991-2001



**Shock Stud Conversion Stud Kit** updates 1954-74 to late model bushing diameter of 1/2". Kit includes 4 studs, 4 nuts and 8 washers and top covers. Use with VT No. 54-0106 with 1/2" holes.

**VT No. Item**  
**54-0403** Kit  
**28-0231** Bushings  
 1/2" Inner Diameter



**Chrome Shock Covers** are a 1950's style top cover. Fit all models of swing arm with stock shocks including 1952-78 Sportster. Some seats may cause interference.

**VT No. 54-0154**



**Chrome Lower Shock Covers** give the Big Twin look on XL models 1979-up with Showa shocks. Covers install easily without dismantling the shock.

**VT No. 54-0206**



**Shock Tool.**

VT No.	Years
16-0101	1975-78
16-0409	1979-up
16-0100	1952-74
16-0954	1979-up



**Chrome Upper Shock Stud Covers.**

VT No.	Years
54-0152	1965-74
54-0153	1975-78
54-0514	1982-90
54-0509	1991-99
54-0532	1991-2003
54-0124	2004-up



**Chrome or Zinc Plated Rear Shock Studs** with cup washers. Each kit includes two (2) studs and four (4) chrome cup washers. Cup washers and lock nuts may be purchased separately.

**Upper Pair**

Chrome	Zinc	Year
54-0443	54-0414	1956-74
—	54-0417	1975-78
—	54-0455	1991-93 <b>Note:</b> Includes two studs.
—	54-0457	1994-up <b>Note:</b> Two studs only

**Lower Pair**

54-0444	54-0415	1956-74
—	54-0405	1975-78
54-0430	—	1982-91

**Upper-Lower**

2406-10	—	2000-03
2405-10	—	2004-up



**Shock Stud Washer 10 pack.**

VT No.	Type	Finish
54-0418	5/8" Hole Cup	Chrome
54-0419	3/8" Hole Cup	Chrome
54-0420	1/2" Hole Cup	Chrome
54-0421	1/2" Hole x 1" Flat	Chrome
54-0424	5/8" Hole x 1.3" Flat	Zinc
54-0432	3/8" Hole x 1.25" Flat	Zinc

**Nyloc** shock stud nut is 5/8"-18, replaces 7993.

VT No.	Finish	Qty
54-0422	Zinc	10
54-0447	Chrome	4

All shocks are measured eyelet to center of eyelet.

# Shock Set



**AEE Series Chrome Shocks** feature an adjustable spring pre-load nitrogen charged with multi-stage automatic damping in a black body with chrome spring and end caps. **Note:** When installing replacement shocks on 1978-00 XL models, it may be necessary to modify or space the chain guard/belt guard to allow proper shock clearance.

**\*Note:** Denotes stock length shock. When installing other than stock length shocks, tire to fender clearances must be checked.

Year	Model	11"	11.5"	12.5"	13	13.5"	14.25
1980-06	XLH 1200,	54-0020	54-0021	54-0022	54-0023	54-0024*	54-0025
	XLH 883 Hugger	54-0020	54-0021	54-0022*	54-0023	54-0024	54-0025
1988-03	XLH 883	54-0020	54-0021	54-0022	54-0023	54-0024*	54-0025
1979-87	XLX-XLH-XLS	54-0020	54-0021	54-0022*	54-0023	54-0024	54-0025
1954-78	XL	—	—	—	—	54-0027	—



# Shock Set



**Progressive Suspension 412 Series Chrome Shocks** are manufactured from the finest material available. Magnum 412 Series shocks are nitrogen charged with six-stage automatic damping and an adjustable spring preload. Available with chrome spring and end caps, shock cartridge is not chrome. All shocks are measured eyelet to center of eyelet.

**Note:** When installing replacement shocks on 1978-00 XL models, it may be necessary to modify or space the chain guard/belt guard to allow proper shock clearance.

**\*Note:** Denotes stock length shock. When installing other than stock length shocks, tire to fender clearances must be checked.

Year/Fits	11.0"	11.5"	12.5"	13.0"	13.5"	14.2"
1988-03 XLH 1200	54-0093	54-0033	54-2000	54-2001	54-2002*	54-0059
1988-03 XLH 883 Hugger	54-0093	54-0033	54-2000*	54-2001	54-2002	54-0059
1988-03 XLH 883	54-0093	54-0033	54-2000	54-2001	54-2002*	54-0059
1979-87 XLX-XLH-XLS	54-0093	54-0033	54-2000*	54-2001	54-2002	54-0059
1953-78 XLH-XLCH	—	—	—	—	54-2009	54-2003

Mount Studs not included with shock sets.



**Progressive Suspension 440 Series Chrome Shocks** feature two rebound damping circuits and are available in standard for the average single rider, heavy duty for touring or carrying passengers. Fit 1977-02.

Standard	Heavy	Size
54-4005	54-4022	11.0"
54-4006	54-4011	11.5"
	54-4050	12.0"
	54-4001	12.5"
54-4009	54-4003	13.5"

# Lowering Kit

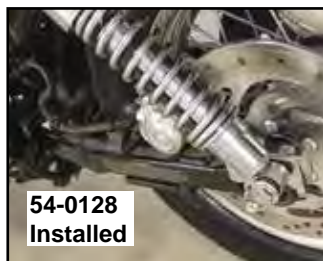

## 1" Rear Shock Lowering Kits.

VT No.	Fits	Finish
54-0510	1989-99	Black
54-0523	2000-03	Black
54-0511	1982-85	Black
54-0541	2000-03	Chrome
54-0542	1989-99	Chrome
54-0127	2005-up	Black
54-0128	2005-up	Chrome



**Warning:** Installing a lowering kit or shorter shocks will decrease initial ground clearance. The motorcycle will be lower to the ground and care should be taken to avoid bottoming, especially over bumps or in turns.

XL





# Shock Set

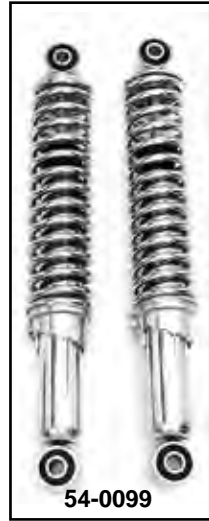
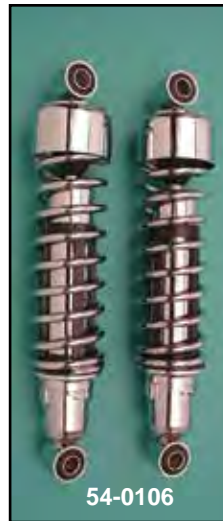
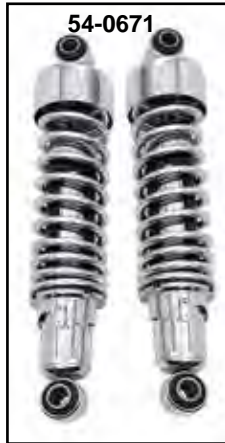
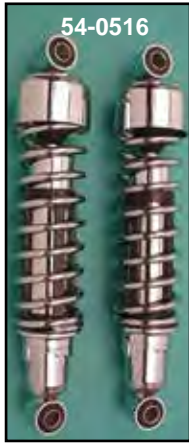

54-0143  
Installed

## 1" Lower Shocks!

**Shorter Length Shocks** lower the seat height by approximately 1". 54-0143 shocks feature chrome-plated springs and body caps with suspension preload.

VT No.	Fits	Length
54-0143	1991-2005 XL 883	11.75"
	1991-2005 XL 1200	11.75"
	1991-2005 XL 883DLX	11.75"
	1992-2005 XL 883R	11.75"
54-0516	All XLS, 1991-03	11.75"
54-0671	2006-2010 883 XL	
	2009-up 1200 XL	

**Warning:** Installing a lowering kit or shorter shocks will decrease initial ground clearance. The motorcycle will be lower to the ground and care should be taken to avoid bottoming, especially over bumps or in turns.



### Shock Bushings.

VT No.	Year
28-0220	1954-73
28-0231	1982-84
28-2140	1985-up

928

### Shock Sets for Sportster includes chrome springs.

VT No.	OEM	Length	Fits
54-0106*	54490-78	14.5"	1975-78 XLH-XLCH
54-0099	54568-79B	13"	L1979-81 XL-XLS XLH-XLCH
54-0098	54568-82	12.5"	1982-87 XL-XLS-XLX 1988-90 XLH 883 Hugger
54-0501	54566-91	13.375"	1991-93 XLH 883 STD/Deluxe 1991-93 XLH 1200
54-0503	54568-92	11.75"	1993-03 XLH 883 Hugger
54-0144	54568-04	13.38"	2004-08 XL 1200

\*Note: Use 54-0403 stud kit for installation on 1952-74 models.

### Shock Absorbers for Lowering Sportster

VT No.	OEM	Length	Fits
54-0098	54568-82	A 12.50"	88-90 XL 883 Std Deluxe XL 1200
54-0503	54568-92	B 11.75"	91-03 XL 883 Std Deluxe XL 1200
54-0503	54568-92	A 11.75"	91 XL Hugger, Stock on 92-03 Hugger models

54-0516 54568-92 As Above, V-Twin

Note: (A) Lowers seat height 1" (B) Lowers seat height 2".

### Shock Absorbers for Raising Sportster

VT No.	OEM	Length	Fits
54-0501	54566-91	A 13.375"	1991 XL Hugger
54-0501	54566-91	B 13.375"	1992-03 Hugger

Note: (A) Raises seat height 1" (B) Raises seat height 2".

Mount Studs not included with shock sets.

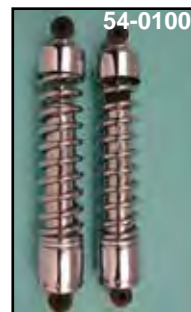

**14" Replica Shock Sets** for 1952-78 Sportster include bushings with 5/8" hole use with 54-0460 stud kit.

VT No.	OEM	Type
54-0100	54504-73	Chrome Springs
54-0101	54500-56A	Full Covered
54-0460		Mounting Kit for Above



# XL Tools



**Primary Plug Wrenches** for Sportster models.  
**VT No. OEM Years**  
**16-0158** 1971-84  
**16-0985\*** 33186 1971-up  
**8862-1** Evolution 1986-up  
**8862-1T** Evolution 1986-up  
 \*Note: Uses 3/8 socket handle



**Jims Sportster Crankshaft Locking Tool.** Use on Pinion side of all 1991-up XL to keep crankshaft assembly from rotating during assembly on valve train repair.  
**VT No. Fits**  
**16-1666** 1991-2002  
**16-1665** 2003-up



**Clutch Adjusting Gauges** are used to find the correct distance between the outer drive plate and outer releasing disc for 1971-83 Sportsters, 1936-67 early and 1968-84 late Big Twins. Set of 3 tools  
**VT No. 16-1807**



**1971-85 XL Clutch Adjust Tool.**  
**VT No. 16-0123**



**Outer Primary Cover Starter Bearing Removal Tool** removes 9063 Torrington Needle Bearing for XL covers.  
**VT No. 16-0717**  
**Note:** This tool will also 4-Speed Sportster Clutch Gear.



**Transmission Door Puller Tool.** Fits 1957-90 XL and 1952-56 K.  
**VT No. 16-0139**



**Shaft Turning Tool** fits spline on assembled motor and allows engine to be turned over by 1/2" ratchet or impact driver. Sifton unless noted. Fits 1957-up XL  
**VT No. 16-1852**



**Clutch Compression Tool** fits 1990-up Big Twin and 1991-up XL models.  
**VT No. 16-1514**



**1990-up Big Twin Clutch Compressor Tool** features access windows to ease the removal and installation of snap ring, by Jims.  
**VT No. Fits**  
**16-1805** Big Twin  
**16-1849** Adapter to fit 1991-up XL



**Countershaft Support Plate Tool** fits 1991-up 5-speed Sportster.  
**VT No. 16-1756**



**Drive Bearing Press Tool.**  
**VT No. OEM Fits**  
**16-1767** 37842 1991-up XL



**Motor Stand** fits 1952-03 XL  
**VT No. 16-0507**



**Main Bearing End Plug Tool** allows the setting of proper end play in Big Twin Timken Bearing Assemblies by selection of proper spacer from the catalog. Use when refitting bearings or bearing sets on late models when spacers are not included. Not needed for our VT No. 12-0309 or 12-0310 Timken sets, these are pre-spaced from the factory. Fits 1977-up XL's.  
**VT No. 16-1796**



**Ratchet Plate Riveting Fixture** securely aligns plate to drum while setting rivets on 1971-79 XL model clutch drum.  
**VT No. 16-0165**



**Sprocket Shaft Timken Bearing Installer Tool.**  
**VT No. Jims OEM Year/Model**  
**16-0149** — 97081-54 1954-76 XL  
 — **16-1837** As Above Jims  
 — **16-1760\*** 2.500 Long 1977-up XL  
 — **16-1761\*** 2.060 Long 1977-up XL

\*Note: Sold separately for 1977-up use with 16-0149 and 16-1837.



**Cam Shaft Needle Bearing Installer.**  
**VT No. Jims OEM**  
**16-0127 16-1857** 97273-60



**Sprocket Shaft Timken Bearing Inner Race Puller** fits 1952-76 XL.  
**VT No. 16-1758**



**Timken Bearing Removers** remove bearing from shaft without removing shaft from fly-wheels.  
**VT No. Fits**  
**16-0667** 1957-76  
**16-1833** 1977-up



**Evolution XL Cam Relief Tool** allows the installation of high lift cams in 5-Speed XL models by removing some of case material at the base of the lifter bores and around the pinion bearing for lobe swing clearance. This tool cuts clearance quickly and can be performed on an assembled engine in the frame.  
**VT No. 16-0353**



**16-0046 Bearing Race Press Plug** is used to remove and install Timken bearing outer race.  
**VT No. Fits**  
**16-0045** 1957-76 XL  
**16-0046** 1977-up XL



**Clutch Compressor Tools** allows disassembly of clutch pack.  
**VT No. Year Model**  
**16-1769\*** 1991-up XL's (Screw)  
**16-0156** 1971-84 XL's  
**16-0059** 1985-90 XL's

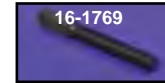

**Final Drive Tool** fits final drive pulley, so the nut can be properly set to torque specifications. Fits XL.  
**VT No. 16-0588**



**Bushing Reaming Tools** fit pinion bushing in cam cover.

VT No.	OEM	Year	Model
<b>16-0981</b>	94812-37A	1954-76	XL & 45"
<b>16-0980</b>	94812-80A	1977-85	Sportster
<b>16-0962</b>	94812-89	1986-up	Sportster
<b>16-1791</b>	—	1957-up	Sportster

1-3-4 Cam Cover Bushing



**Clutch Drum Locking Tools** for removing clutch hub and motor nuts.  
**VT No. Year**  
**16-0125** 1952-70  
**16-0159** 1956-84  
**16-0992** 1971-84



**Pinion Shaft Race Installer** fits 1977-E81 Sportster models. Replaces 97080-77A.  
**VT No. 16-0965**



**Sifton Pinion Gear Puller** is used for installation and removal of the pinion gear. Fits 1957-76 XL.  
**VT No. 16-1060**





# Swingarm Bearing



Swingarm Bearing Assembly Kit contains parts pictured for 1952-81.

VT No.	Fits
44-0539	1952-73
44-0538	1974-81

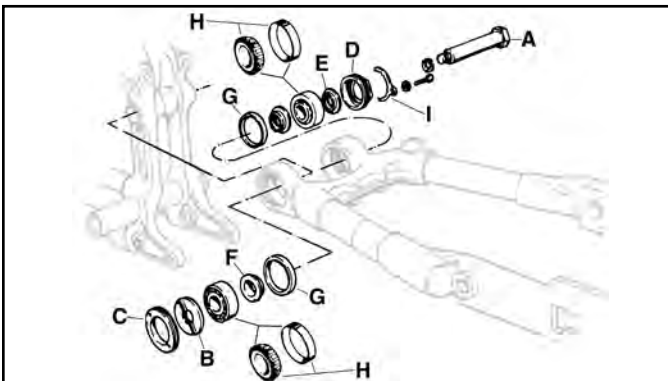

## Pivot Pin Hardware for 1952-81 models.

VT No.	#	Year	Item
44-0107	A	1952-81	Pivot Bolt, chrome
44-0098	B	1952-73	Nut
44-0097	B	1974-81	Nut
44-0096	C	1952-73	Locknut
44-0095	C	1974-81	Locknut
44-0088	D	1954-73	Locknut, Right
44-0087	D	1974-81	Locknut, Right
44-0094	E	1952-73	Outer Spacer
44-0093	E	1974-81	Inner Spacer
44-0367	F	1952-81	Spacer, pair
44-0110	G	1952-81	Shield, pair
44-0108	H	1952-73	Bearing Set
44-0109	H	1974-81	Bearing Set
17-0920	I	1952-81	Locktab



Smooth Swingarm Pivot Covers Set covers end of pin.

VT No.	Year
37-1206	2004-up
37-9522	2004-up

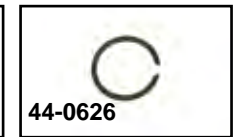
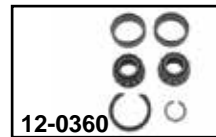
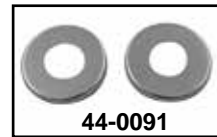

Pivot Bolt Kit includes black pin, screw, spacer, bushing, bearing and dust covers.

VT No.	Item
44-0540	1982-03 Kit
44-0709	2004-up Kit
44-0714	2004-up Kit, Chrome
44-0875	2004-up Kit
44-0872	2004-up, Pivot Shaft, Zinc
44-0092	1982-03 Bolt/Nut
44-0151	2004-up Bolt/Nut
44-0091	1982-up Dust Cover (2)
12-0362	1982-03 Bushing, Left
12-0360	1981-99 Bearing, Right
12-0127	2004-up Bearing, Right
44-0626	2004-up Pivot Retaining Ring



Swingarm Pivot Kit. Includes all parts shown for 1952-80 XLH-XLCH Sportster models.

VT No.	Fits
44-1959	1952-73
44-1960	1974-80

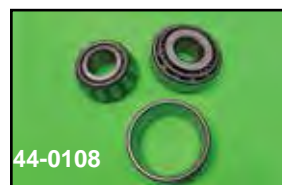

## XL-XLH Model Swingarm Bearings and Kits.

VT No.	Years	Item	U/M
44-0108	1952-73	Four Piece	Kit
12-0332	1952-73	Bearing	Pair
12-1100	1952-73	Race Set	Pair
44-0109	1974-81	4 Piece	Set
12-0333	1974-81	Bearing Set	Pair
12-1101	1974-81	Race Set	Pair



# Rigid Frame



51-0107



50-2174



51-2176



**Custom Rigid Frames** to fit XL models. Available without Fat Bob mounts. These frames can only be used with custom oil tank and battery tray, ordered separately. VT No. 51-2174 use VT No. 24-0225 neck cup kit .

**Note:** VT No. 51-2176 and 51-2175 frames include kickstand tab which must be welded on by customer. All frames use a 140 rear tire except 51-0107 which will accept a 180 tire with chain drive.

VT No.	Years	Stretch	Rake	Brake	Tire
51-2174*	1957-76	1"	40°	Drum	140
51-2176	1986-03	Stock	Stock	Disc	140
51-0107	1986-03	2¼"	40°	Disc	180

### Related Parts

40-0416	All	Custom Oil Tank (Fits 180 & 200 Tire)
40-0437	All	Battery Tray with strap and top uses
23-0370	—	12N16-4B battery
44-0221	—	1987-up Rear Caliper Kit
7704-2	—	10½" Chrome Axle Kit
27-0047	—	Chrome Rear Chain Adjuster
27-0509	—	1986-03 Stock Kickstand
27-0128	—	1957-85 Kickstand
	—	Chain Guard for Above

\*Note: Stock neck rake is 28°



40-0416



40-0437



7704-2

**XL Rigid Oil Tank and Battery Tray.** Battery tray accepts 12N164B battery, VT No. 53-0518.

VT No.	Item
40-0416	Oil Tank
40-0437	Battery Tray with Strap and Top

# Swingarm Frame

**VT No. 51-2026 and 51-2028 1979-up Disc Brake Only XL frame recommended components.** Order separately as required.

VT No.	Item	VT No.	Item
40-0397	Oil Tank	54-0516	Shock Set, (11.75")
23-9209	Caliper	24-0253	Neck Cup Set with Bearings
44-0566	Axle Kit	54-0449	Shock Mount Kit
44-0540	Swing Arm Bearing Kit	50-0899	Strut Set
28-0410	Battery Pad	31-3978	Front Mount Set, 1979-85
28-0409	Bumper	31-2137	Front Mount Set, 1986-up
40-0391	Oil Tank, 1997-up	31-0224	Rear Mount, 1979-81



**1972-78 Neck** fits XL model to be welded in place on stock or custom frames. Accepts 24-0225. Neckcups, 7/8" size.

VT No. 51-0524



51-0910

**Chrome Swingarm.** Fits 1990-99.  
VT No. 51-0910



**Rear Axle Cover** for XL models customizes the rear axle and swingarm end. Fits 2004.  
VT No. 42-0945

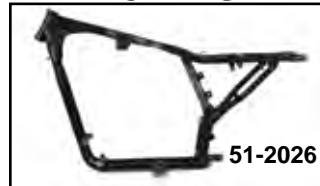

51-2026

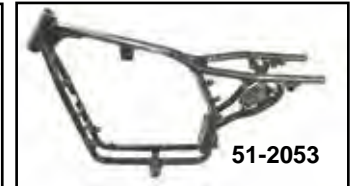

51-2053

**Swingarm Frames** will accept 1983-up oil tank, gas tank, 1994-up battery carrier, 1982-93 rear fender, struts and 1" Big Twin chrome neck cups. 1979-up type accept 1982-up swing arm and bearings for use with disc brakes. Use 1986-up wheel and related caliper components.

VT No.	Year	Type
51-2028	1979-1981	Disc
51-2026	1982-2003	Disc
		Belt/Chain
51-2053	1986-1990	Belt/Chain
51-2054	1991-2003	Belt/Chain







# 200 Series Rigid Frame



51-3525

Wyatt Gatling Rigid Frame features 40 degree rake, 3" stretch in front legs, to accept 1.125" belt with 200 series tire. Frame has kick stand tab and battery box mount welded in place.

**VT No. Year**

**51-3525** 1986-03

**51-3575** 1957-85



51-3575

**Related Components** for 200 1986-03 XL Frame. Order separately.

**VT No. Item**

**44-0148** Axle, 14.5"

**44-0545** Adjuster Kit

**20-4001** Belt, 133T x 1.125"

**20-0512** Offset Pulley

**31-0953** Front Top Mount

**24-0253** Neck Cup Set, 1"

**44-0786** Right Hand Rear Axle Spacer

**40-0404** Oil Tank, Round

**40-0474** Round Oil Tank

**42-9912** Battery Box

**22-0370** Caliper Kit

**37-0889** Axle Nut Set

31-1755



- **Frame** 51-3525
- **Fork** 24-0938
- **Pipes** 30-0300
- **Oil Tank** 40-0474
- **Gas Tank** 38-0196
- **Forward Control** 22-0731

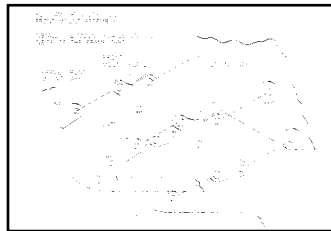

**Note:** On 51-3525 motor mount plates fit inside of frame mount tabs as shown.



Bobber

**V-Twin Rolling Chassis** include rigid frame, single disc glide fork assembly, 16" chrome rear wheel, 21" chrome front wheel, 3/2 gallon bobbed tank set, cast dash kit, axles, Avon rear tire as noted, oil tank and kick stand. Disc brake models will accept 1987-99 GMA Rear Caliper VT No. 23-9209.

VT No.	Year	Engine Type	Brake Type	Tire	Type
51-1030	1952-76	Ironhead	Mechanical	130	Bobber
51-1033	1977-78	Ironhead	Mechanical	130	Bobber
51-1034	1979-81	Ironhead	Disc	130	Bobber
51-1035	1982-03	Ironhead and Evolution	Disc (Belt-Chain)	130 Belt, 140 Chain	Bobber
51-5002	1982-03	Ironhead and Evolution	Disc	150	Chopper
51-1260	1982-03	Evolution	Disc	180	Chopper
51-1265	1982-03	Evolution	Disc	180	Bobber



**Weld On Caliper Bracket Set** fits Rigid XL frame for left side use.

**VT No. 51-0630**

**Chrome 5.5" Round Oil Tank** fits XL's with Rigid frame mounts by clamping to center tube or top mount center fill.

VT No.	Type	Finish	Brackets
40-0474	Clamp	Chrome	—
40-1476	Clamp	Raw	—
40-0741	Top Mount	Chrome	31-1755
40-0742	Top Mount	Raw	31-1755



- Features Flatside Bob Tank Mounts
- Suggested Parts List
- Kick Stand Mount
- Sissy Bar Tabs

Frames include a suggested parts listing to aid in construction.

51-1025



51-1032  
Order Neck Cups Separately



51-1032

**Rigid Frames** for XL models will accept 1" neck cups, VT No. 24-0119 and include mounts for flat side fat bob tanks or stock tank. Frames with cross shafts include bushings. Order oil tank and

battery box separately. Disc brake models accept 1987-99 caliper assembly VT No. 22-0370 and a 140 tire. All frames have 40° rake and 1" stretch. 1975-76 models require use of forward controls. **Note:** 1957-79 application requires modification of rear motor mount to accept kick shaft.

VT No.	Year	Engine	Brake Type
51-1025	1957-76	Ironhead	Mechanical
51-1028	1977-78	Ironhead	Mechanical
51-1031	1952-78	Ironhead	Disc
51-1032	1979-81	Ironhead	Disc
51-1027	1986-2003	Evolution	Disc, Belt, Chain (140)
51-3525	1986-2003	Evolution	Belt (200)



40-0474  
Installed



40-0742



# "200" XLST Frame Assembly



51-1038  
Complete Kit



51-1038

Kit includes chrome shocks, raw rear section and mount bolts.



51-1037

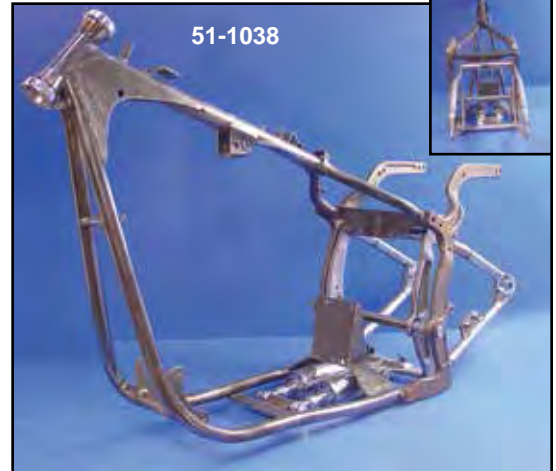

51-1038

Kit without shocks

Related Parts for 51-1038 XLST frame order separately.

VT No.	Item	50-0112	9" Rear Fender
40-0393	Oil Tank, Raw	50-1069	Struts, Smooth
40-0394	Oil Tank, Chrome	31-0713	Top Mount
44-0638	Rear Axle	31-4004	Front Mounts
44-0545	Adjuster Kit	20-4004	Pulley, Offset
24-0322	Neck Cup Set	23-8834	Rear Brake Line
23-0587	Rear Caliper		
31-0221	Oil Tank Mount		
31-2137	Front Mount Set		
52-2033	17" Rear Wheel		

**Softtail Frame for Sportsters** features 40° rake with 1" stretch and includes the rear section, including pivot bolt kit. Frame accepts readily available components for ST, which are available separately including neck cups, flat side gas tanks, oil tank, 23-0587 caliper, rear fender, fender struts and fork assembly as noted.

VT No.	Year	Engine Type
51-1036	1957-85	Iron Head
51-1037	1986-2003	Evolution As Pictured
51-1038	1986-03	Evolution, Complete

**Pivot Pin Spacer Assembly Placement. Note left and right**



52-2033



40-0394



50-0112



23-0587



50-1069



31-2137



31-0713

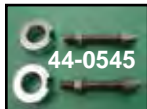

44-0545

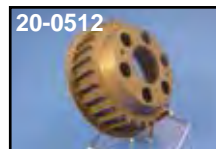

20-0512

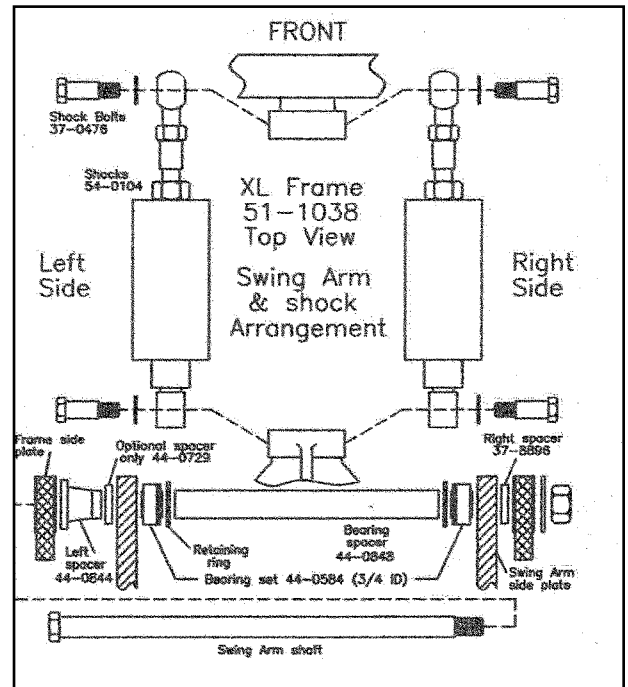





# Hardtail

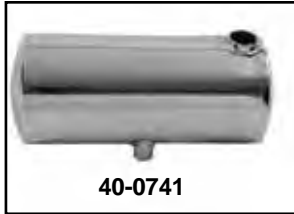
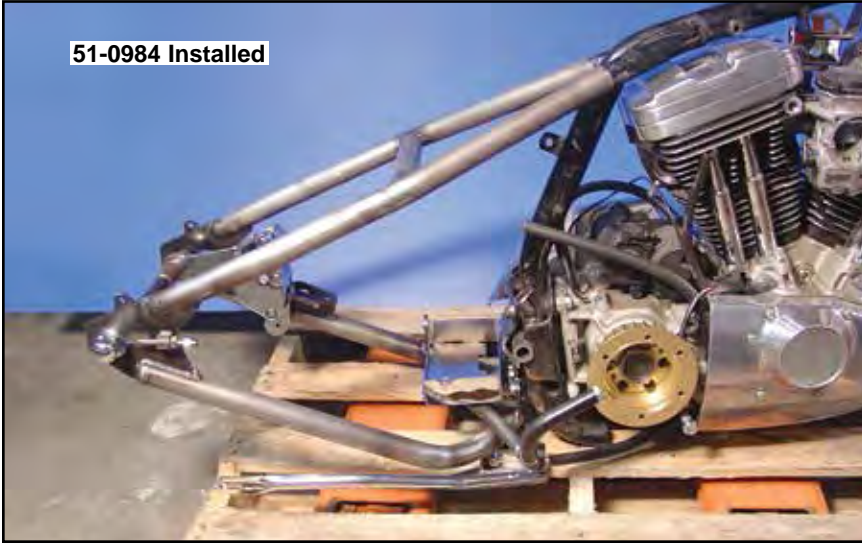

**Chrome 5.5" Round Oil Tank** fits XL's with rigid frame mounts by clamping to center tube or top mount side fill. 31-1755 clamp set will mount 40-0742/40-0741 in 1957-78, 1979-81 and 1982-03 stock frames with hardtails installed.

VT No.	Type	Finish	Brackets
40-0474	Clamp	Chrome	—
40-1476	Clamp	Raw	—
40-0741	Top Mount	Chrome	31-1755
40-0742	Top Mount	Raw	31-1755



**Hardtails** fit to stock frames for years listed.

VT No.	Fits	Type	Style
51-0921	1952-72	Weld-on	Drum
51-0922	1952-78	Bolt-on	Drum
51-0981	1973-78	Weld-on	Drum
51-0982	1979-81	Weld-on	Disc
51-0984	1982-03	Weld-on	Disc
51-0996	2004-up	Weld-on	Disc

**Notes:** VT No. 51-0921 eliminates seat casting area and accepts stock drum brakes. VT No. 51-0922 is bolt on top and bottom, 51-0921, 51-0981, 51-0982 and 51-0984 with 3/4" axle slots is weld on top and bolt on bottom for alignment. Seat plate must be welded in place.



# 2004-up Exhaust Pipe



**2004-up XL Side by Side Pipes** fit XL and XLC models with forward controls. Pipes are 1<sup>3</sup>/<sub>4</sub>" at head and 2<sup>1</sup>/<sub>4</sub>" at end and includes brackets and baffle set. 2007-up has provisions for oxygen sensors. Sensors may be capped by 30-0423 if desired.

VT No.	Type	Year
30-0477	Straight	2007-up
30-0324	Straight	2004-06
30-0327	Slash	2004-06
30-0380	Slash	2007-up
30-0423	Oxygen Sensor Plugs	2007-up

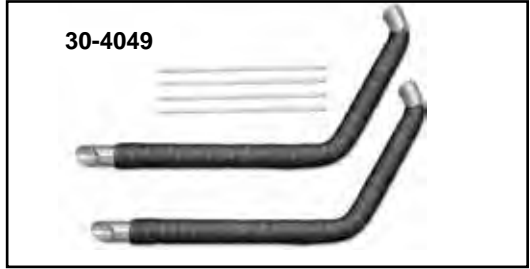
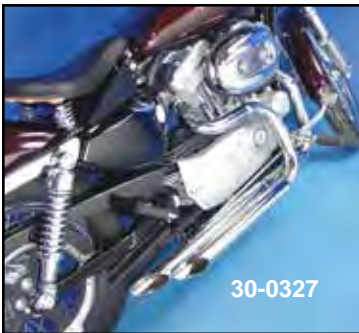

**Black Heat Wrapped Drag Pipe Sets** for XL's.  
 VT No. Year  
 30-4049 1986-03



30-0342



30-0385

**2<sup>1</sup>/<sub>4</sub>" Drag Pipe Set** features built in mount tabs to bolt to stock bracket. Chrome replacement bracket and baffle set available separately. Fits 1986-2003 XL models.



**Oxygen Sensor Units** sold each.  
 Fits 2007-up  
 VT No. Fits  
 30-0434 2007-13  
 30-0490 2014-up front  
 30-0491 2014-up rear



**Namz O2 Enrichment Device.**  
 Recommended for bikes with high flow air cleaner performance exhaust systems. Reduces engine operating temperature between 20 to 30 degrees. Simply plug in between oxygen sensors and wiring harness. Works with stock ECM. Fits 2007-up XL. Sold in sets. **VT No. 32-6556**

VT No.	Item	Type
30-0342	Pipes	Down Slash
30-0385	Pipes	Side Slash
31-0418	Bracket	
30-0050	Baffle Ring	

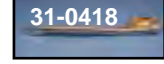

30-0796



30-0797

**Billet End Tips** fit 1<sup>3</sup>/<sub>4</sub>" straight cut drags.  
 VT No. Finish  
 30-0796 Chrome  
 30-0797 Black



**Caution:** These exhaust products are not legal for sale or use in California on pollution controlled vehicles. These products are intended for the experienced rider only.



**Limited Warranty.** Exhaust Products distributed by Tedd Cycle Inc. are warranted against defects in material and workmanship, which include fitting and finish quality at the time of installation only. Claims regarding discoloration, peeling blistering or blued chrome will not be considered as defective material or workmanship and cannot be returned as such as per manufacturers warranty.

XL





# Drag Pipe Set

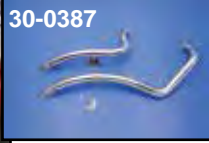

**2" Curvado Pipe Set** fits XL models. Include removable oxygen sensor plugs to fit 2007-up models.

VT No.	Item	Year
30-0387	Pipe Set	2004-13
30-0384	Pipe Set	1986-03
31-0988	Mount Bracket	1986-03
31-0989	Mount Bracket	2004-13

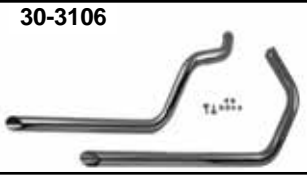

**Chrome Drag Pipe Sets** by Cycle Shack are 40" in length.

VT No.	Bracket	Size
1957-85, except 1979	—	31-4052 2"

**1979 only**

30-3106	31-9994	1 3/4"
---------	---------	--------

**2004-06**

30-0075	Stock	1 3/4"
---------	-------	--------

**2007-13**

30-0077*	Stock	1 3/4"
----------	-------	--------

\*Note: With straight cut ends.

Note: 2007-up models are fitted with oxygen sensors.



**Wyatt Gatling 2 into 1 Exhaust Header Set** is a one piece design featuring turn out mufflers. Fits 1986-2003 XL with stock foot controls.

VT No.	Finish
29-0932	Chrome
29-0933	Black



**Sportster Muffler Pipe Set** with straight cut ends are direct bolt for all pipe sets. Fits 1986-2003 XL and 883, 1100 and 1200 models.

VT No. 29-1159



Caution: These exhaust products are not legal for sale or use in California on pollution controlled vehicles. These products are intended for the experienced rider only for non-highway only.



**Magnum Exhaust Drag Pipe Set** is constructed of steel featuring heat shields. Fits 2004-up XL.

VT No. Finish

30-1286 Black

30-1285 Chrome

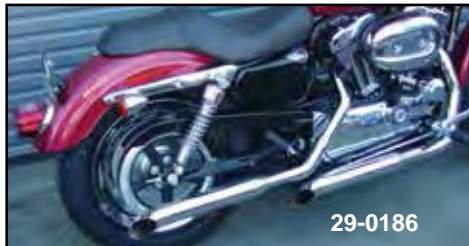

**Cycle Shack 2004-13 XL Pipe Sets** to fit all 883 and 1200 models. 1 3/4" header set accept factory heatshields. 2" headers are supplied with heatshield Both 1 3/4" and 2" type mount to factory support bracket. Muffler pipe sets feature one piece construction and high flow rate baffles.

**1 3/4" Muffler Pipe Set**

2007-14	2004-06	Style
30-0077	—	Straight
29-0192	—	Taper
—	29-0186	Turnout
—	30-0075	1 3/4" Slash Cut End
—	30-0356	Heat Shields

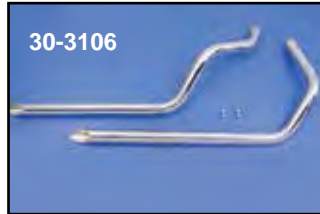

**Chrome Drag Pipe Set** has a diameter of 1 3/4" and comes with channel mounts. Fits 1979 only.

VT No.	Bracket
30-3106	31-9994



**Namz O2 Enrichment Device.**

Recommended for bikes with high flow air cleaner performance exhaust systems. Reduces engine operating temperature between 20 to 30°. Simply plug in between oxygen sensors and wiring harness. Works with stock ECM. Sold in sets. Fits 2007-up XL

VT No. 32-6556



# Drag Pipe

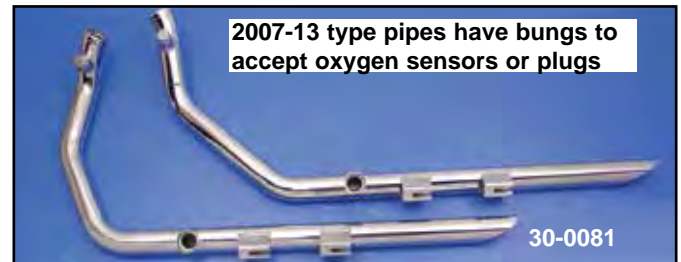

2007-13 type pipes have bungs to accept oxygen sensors or plugs

1 3/4" Drag Pipe Sets available in black or chrome finish with formed heatshields (as noted) and either slash cut or straight ends. 38" length. Pipes mount by stock brackets except where noted. 2007-up style have oxygen sensor ports.

Chrome With Heatshield	Chrome Without Heatshields	Black Without Heatshields	Black
1986-2003 use with or without forward controls	30-3012	30-3020	30-3419
—	30-0879**	—	—
—	30-3104	—	—
2004-06	30-0070**	—	—
—	30-0071	—	—
—	30-0069*	—	—
—	30-0080*	—	—
2007-13	30-0081	30-3021	—
—	30-0089*	—	—
—	30-0071	—	—
1957-78, 1980-84	30-3006	30-3022	30-3418
Note: These pipes require mounting bracket, 31-4052	30-3018***	—	—
		30-3420	

\*Note: With straight ends  
\*\*Note: Without O2 ports

\*\*\*Note: Goose style

Caution: These exhaust products are not legal for sale or use in California on pollution controlled vehicles. These products are intended for the experienced rider only.



Limited Warranty. Exhaust Products distributed by Tedd Cycle Inc. are warranted against defects in material and workmanship, which include fitting and finish quality at the time of installation only. Claims regarding discoloration, peeling blistering or blued chrome will not be considered as defective material or workmanship and cannot be returned as such as per manufacturers warranty.

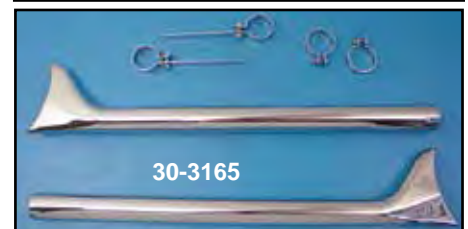
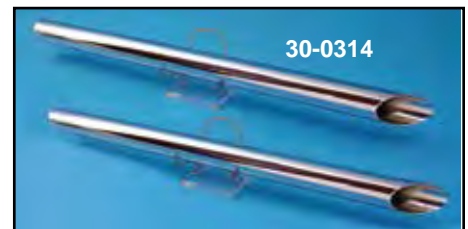

Chrome Straight Pipe Sets fit over 1 3/4" exhaust pipes. The 1 7/8" outside diameter allows pipes to be cut down and still slide over pipes. 30" long.

VT No. Type  
30-0314 Slash  
30-3165 Fish Tail





# Shot Gun



**Sportster Evo Shotgun Duals.** 1 3/4" diameter drags for all 1986-03 Sportster when installed in a custom rigid frame.

- VT No. Fits**  
 29-0200 Rigid  
 29-0201 Swing Arm

## Upsweep



**Flame Heat Shield Installed**  
30-0118

**Upswept Drag Pipe Header Set** for 1957-03 XL models. Available with slash or straight cut ends and rigid swing arm models.

VT No.	Years	Fits	End
29-0087	1957-85	Rigid	Straight
29-0084	1986-03	Rigid	Straight
29-0114	1957-85	Rigid	Slash
29-0157	1986-03	Rigid Swing Arm	Slash
29-0188	1986-03	Rigid	Slash



### Belt Buckles.

- VT No. Style**  
 48-1351 XLH Ironhead  
 48-1512 XL Gas Tank  
 48-1473 XLH Ironhead Electric Start  
 48-1545 XL Points Cover  
 48-7787 XLCH Sportster  
 48-1522 Complete Set

# Goose Drag Pipe Set

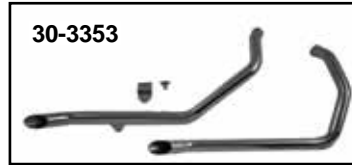

**Goose Style Drags.** Retro chopper styling in 1 3/4" diameter and slash cut ends, 34" long on all models except VT No. 30-3353 at 40". Note: Order mount bracket as noted. Bracket not required on stock type.

VT No.	Mount Bracket	Year
30-3132	31-2101	1979 only
30-3353	Stock	1985-2003 883-1100-1200

## Shot Gun



**Shot Gun 1 3/4" Drag Pipes Sets** fits rigid frames only and requires bracket for mounting. Slash cut ends.

VT No.	Year
29-0179	1957-1984
29-0180	1986-2003

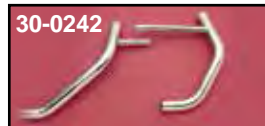

**Chrome Replica Header Sets.** Muffler sold separately.

VT No.	OEM	Year	Model
30-0242	65290-75	1975-78	XL With Cross Over
30-0204	65415-75		Cross over Heatshield for Above, Black

## Clamps



**Chrome Muffler End Clamp** clamps mufflers to pipes.

VT No.	Size
31-2103	1 3/4"
31-0318	1 7/8"



**Stainless Exhaust Head Clamp.** Stock type construction, sold as a pair. Replaces 65519-52. Fits 1952-71.

VT No.	Item
31-0226	Clamps
37-8684	Bolt Set

### Exhaust Pipes and Mufflers Warranty Information

There is no warranty on exhaust pipes and mufflers with regard to any discoloration. Discoloration (blueing) is caused by tuning characteristics, cam timing, carburetor jetting, overheating, etc., and is not caused by defective manufacturing. This means, once exhaust pipes have been installed and started these pipes are considered used. **If pipes are not to the dealer/customer satisfaction, contact us immediately for a return authorization before starting your engine.** Refunds and exchange are not available. Manufacturers will guarantee all sets of exhaust systems against any kind of manufacturer's defects.



**Important Note:** Some items on this page may be emission-related parts subject to California or other emission control laws. Please see note on page 71 for important information regarding emission control regulatory compliance and warranty information.





# Universal Muffler

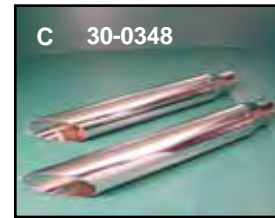

Slip On Chrome Mufflers steel baffled with 1 3/4" inlet.

VT No.	Type	Length	Dia.	Mt Type	Removable Baffle	U/M
30-0149	A-Slash	16"	2 1/2"	Stud	No	Each
30-0148	B-Tapered	16 1/2"	2 1/4"	Channel	Yes	Pair
30-1401	Tapered	11"	1 1/2"	Black	Yes	Set
30-0641	Tapered, Black	11"	2 1/2"	Channel		Set
30-0642	Tapered, Chrome	11"	2 1/2"	Channel		Set
30-0147	C-Baloney Slice	16 1/2"	2 1/2"	Stud	Yes	Each
30-0348	C-Baloney Slice	16 1/2"	2 1/2"	Channel	Yes	Pair
30-0150*	D-Shorty	12"	2 1/4"	Stud	Yes	Each
30-0296	E-Megaphone	19"		Channel	Yes	Each
30-0794	Megaphone	19"		Channel	Yes	Pair
30-2105	F-Megaphone Upsweep			Channel	Yes	Pair

\*Note: Fits 1 3/4" or 1 1/2" diameter.



# Replica Muffler

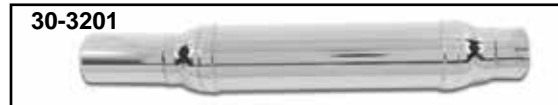

K+ Early XLCH Mufflers have 2 3/8" body diameter, 1 3/4" inlet.

VT No.	OEM	Fits	Type
30-0742	Replica	1952-56 K-KH	21 1/2" Long
30-3201	65231-58	1959-61 XLCH	
30-0986	Replica	1962-64 XLCH	with Slash
30-1109	Replica	Pair	with Slash
30-0212	65230-65	1965-73 XLCH	with Taper
30-0795	65231-65A	1965-70 XLCH	Replica, Embossed
30-3221	65281-77	1977-78 XLCH	Left, Black
30-3222	65286-77	1977-78 XLCH	Right, Black
31-0301	65275-57	1 7/8" I.D.	End Clamp
31-0318	Chrome		End Clamp
31-0303	65412-75	1975-80 XL	Cover Clamps
31-0231	65279-57	1952-59	Body Clamp
31-0319	Stainless	1952-59	Body Clamp



**STOP** Caution: These exhaust products are not legal for sale or use in California on pollution controlled vehicles. These products are intended for non-highway only.



XL





# 1986-03 XL Exhaust



**Radii Exhaust Sets** feature the "Quad Finishing" which includes triple dura nickel and chrome as the final finish. After chrome plating, pipes are normalized and dried @ 572° F for the final finish process.



For 2004-2006 models you must purchase 30-0423 plug set. For 1986-2003 models you must purchase 30-0423 plug set and 31-0897 bracket. Order baffle style as desired for required back pressure.

VT No.	Item
30-0987	2004-13
30-0383*	1986-03
31-0897	1986-03 Bracket
31-1001	2004-13 Bracket
30-0103	Baffles
30-0423	Plug Set

\*Note: Must be used with a forward control kit.



**Chrome Vance & Hines Side Shots** feature power chamber design, 2½" header pipe, 220° full length heat shields and removable baffles. Mounting hardware included. Fits 2004-2006 XL.

VT No. 30-1528



**Chrome Straight Drag Exhaust Set** with a unique header design has removable performance baffles and polished black anodized billet aluminum end caps. Fits 2004-2006 XL.

VT No. 30-0395

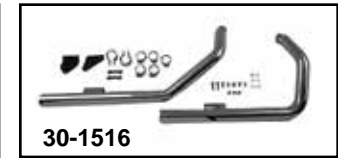

**Dual Straight Stagger Shots** feature full length/full coverage heatshields, 1¾" header pipes with 2¼" bodies, removable baffles and mounting hardware.

VT No.	Fits	Brand
30-1515	1986-2003	VH
30-1516	1999-03 883C and 1200C only	VH
30-1525	2004-06	VH
30-1576*	2004-10	VH

\*Note: Pre2007 models require O2 Sensor Plugs VT No. 30-0423



**Chrome Stock Rear Exhaust Bracket.** Fits 1980-2003 XL. VT No. 31-0418



**Oxygen Sensor Sealing Washer**  
VT No. Year Fits  
15-0081 2006-10 18 mm  
15-0012 2011-up 12 mm



**Exhaust Oxygen Sensor Plugs** are doing for away with your oxygen sensor, use this threaded plug in its place.

VT No. Fits  
30-0423 18 mm  
30-0448 12 mm



**Vance & Hines Super Radius 2 into 2 Pipe Set.** Super radius brings a deeper richer tone to the custom styled exhaust and is engineered for today's larger capacity engine to get solid performance and just the right sound. Features include deeper tone, full coverage heat shields and available in chrome. Fits 2014-up XL.

VT No. 30-1656

**Limited Warranty.** Exhaust Products distributed by Tedd Cycle Inc. are warranted against defects in material and workmanship, which include fitting and finish quality at the time of installation only. Claims regarding discoloration, peeling blistering or blued chrome will not be considered as defective material or workmanship and cannot be returned as such as per manufacturers warranty.



**Caution: These exhaust products are not legal for sale or use in California on pollution controlled vehicles. These products are intended for non-highway only.**



# 1979 Only Pipe

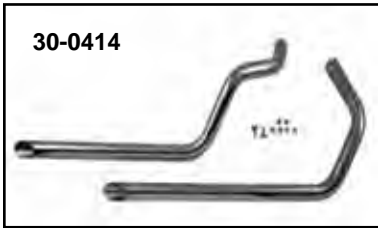

## 1979 Only Muffler Pipes.

VT No.	Style
30-3106	1 3/4" Drags with channels
30-3132	1 3/4" Goose Drags
31-4052	Bracket, Black
31-4057	Bracket, Chrome

**Note:** Drag Pipes do not include brackets. VT No. 30-3107 and 30-3132 use VT No. 31-2101 mounting clamps. VT No. 30-3106 uses 31-9994 mounting bracket.



# Big Guns



**Big Guns Exhaust System** mounts using stock bracket unless noted. Drag pipes feature 1 3/4" head port end with 2 1/4" diameter body. Heat shields sold separately. All pipes fit with XLC forward controls except 30-3303. Fits 2004-2006 Big Slash.

VT No. 30-0414



**Vance & Hines Big Radius System** is virtually blue-proof. Scalloped end caps for a unique look. Removable baffles and mounting hardware included. Include mounts for factory O2 sensors as required. Pre 2007 models require O2 sensor plugs VT No. 30-0423. Fits 2004-2012 XL.

VT No. 30-1575



**Black Support Tube** to mount drag pipes or stock muffler system for 1958-79 XL-XLH models. Replaces 65316-65B.

VT No. 31-4029



**Brake Pedal Stop** required on 1980-85 XL models when fitted with drag or custom pipe sets, to act as pedal stop which was originally welded on stock header pipes have a combination mounting bracket/brake pedal stop welded to stock header pipes.

VT No. 31-2124



**Chrome Rinehart Crossback 2 into 2 Exhaust Drag Pipes** include header pipes, flash cut mufflers, heat shields, baffles and billet end caps. Fits: 2004-up XL. VT No. 30-1552

# 1957-80, 81-85 XL Exhaust

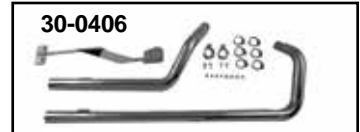

**Samson Big Guns II** feature 1 3/4" head pipes with 2 3/4" full coverage heatshields. All Big Guns II come complete with mounting bracket and hardware. Fit 2004-06 XL.

VT No. Style

30-0406 Cannons with forward controls

30-0407 Classics

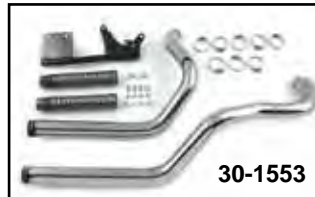

**Rinehart Racing Chrome Staggered Style Crossback 2 into 2 Exhaust System.** The crossover three step header design with 2 1/2" chrome torque and horsepower across the RPM range. Crossback systems are available 220° full coverage heatshields that merge flush to the muffler bodies, custom baffles (2" outside diameter for engines up to 96CI and 2 1/4" outside diameter for large high performance engines). All system includes two oxygen sensor parts. Fits 2004-13 XL.

VT No. 30-1553



**Chrome Heat Shields** are for 1-3/4" stock or drag pipe sets. Sold in a quantity of 2. \*\*CAUTION: These exhaust products are not legal for sale or use in California on pollution controlled vehicles. These products are intended for non-highway only. Fits: XL 1957-1984 XL, does not fit 1979.

VT No. 30-0082

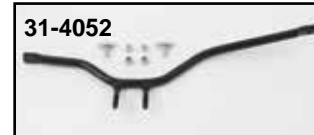

**Exhaust Pipe Mount Bracket.**

31-4052 BK-4 Cycle Shack PHD-112 series and PHD-117 series muffler pipes & PHD-110 & PHD-210 drag pipes for Sportster produced with adjustable channel mount

31-4057 BK-4 As Above, chrome

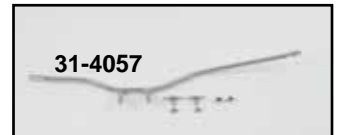

**Chrome 40" Drag Pipe set** has a diameter of 1 3/4" and features black slash cut tips. Fits 2007-up. VT No. 30-3109



**Chrome Drag Pipes** have a diameter of 1 3/4" and are 38" long. Fits 1986-1999 XL. VT No. 30-3168



**Caution:** These exhaust products are not legal for sale or use in California on pollution controlled vehicles. These products are intended for non-highway only.







# Exhaust



30-0722  
1 3/4"



30-0300  
Pipes  
Shown  
on XLST



30-0727



30-0319

30-0319 Installed on Ironhead Models. Brackets must be fabricated for installation.



2"  
30-0460

**Radii™ Curved Exhaust Headers** feature 2" diameter. **Note:** For 2004-up models order additional bracket separately. 1957-85 Iron Heads require fabrication of rear bracket and will not work with XLH (Side Mount) oil tank.

VT No.	Years
30-0319	1957-85
30-0300	1986-07
31-0765	2004-07 Bracket



**Vance and Hines Side Shots** feature power chamber design 220° full length heatshield 2 1/2" header pipe and removable baffles mounting hardware included. Fits 2007-13.  
VT No. 30-1536



**2-Stage Torque Kit** fit 2 1/4" inner diameter exhaust pipes, reduces noise and increases back pressure.  
VT No. 30-0617



**Passenger Peg Mount Bracket Sets Only.** Use with male style peg.  
**Chrome Black** Years  
27-1564 — 2004-13  
27-0825 27-0271 2014-up

## Wyatt Gatling Down Drag Pipe Set.

Available in black or chrome finish and in 1 3/4" or 2" diameter. Pipes for 2004-up models include O2 sensor bung plugs for 2004-07 applications. 1957-85

Chrome	Black	O.D.
30-0727	30-0728	1 3/4"
2004-up		
30-0722	30-0735	1 3/4"
30-0460	30-0464	2"



30-0728



30-0952

**Wyatt Gatling Chrome Staggered Short Shots** feature 1 3/4" headpipes with 220° coverage heatshields and slash cut ends. Includes baffles and mounting hardware. Fits 2004-13.  
VT No. 30-0952\*

\*Note: Pre 07 Models require O2 sensors port plug set.



**Rear Passenger Peg Relocation Bracket Set** fits 2004-13 XL with 30-0300 pipe set. Black finish. Order chrome footrest for support bracket separately.  
VT No. 31-0766

**Limited Warranty.** Exhaust Products distributed by Tedd Cycle Inc. are warranted against defects in material and workmanship, which include fitting and finish quality at the time of installation only. Claims regarding discoloration, peeling blistering or blued chrome will not be considered as defective material or workmanship and cannot be returned as such as per manufacturers warranty.



**Caution:** These exhaust products are not legal for sale or use in California on pollution controlled vehicles. These products are intended for the experienced rider only for non-highway only.



30-0743  
Installed



30-0444 Installed



30-0444



30-0446 Installed



30-0447 Installed

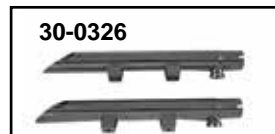

30-0326

Wyatt Gatling Slip-on Mufflers fit 2007-13 XL's. Chrome unless noted.

**VT No. Style**

- 30-1275 High Output End
- 30-1276 Black Barrel End
- 30-1277 Barrel End
- 30-1278 Tapered End
- 30-0463 3" Tapered End
- 30-0462 Slash
- 30-1279 Black 3" Tapered End
- 30-1280 Black End

**Limited Warranty.** Exhaust Products distributed by Tedd Cycle Inc. are warranted against defects in material and workmanship, which include fitting and finish quality at the time of installation only. Claims regarding discoloration, peeling blistering or blued chrome will not be considered as defective material or workmanship and cannot be returned as such as per manufacturers warranty.



30-0767 Installed

**2" Slip-On Drag Pipe Extensions**

2014-up

Side

30-0767 Black

30-0766 Chrome

**RMB Baffles 30 Second Removal!**

**2" Slip-On Slash Cut Muffler Sets are available** with black or chrome finish. Feature removable baffles and mount to stock brackets.

<b>2004-13</b>	<b>Type</b>	<b>Finish</b>
30-0743	Side Slash	Black
30-0444	Side Slash	Chrome
30-0326	Down Slash	Chrome
<b>2014-up</b>	<b>Type</b>	<b>Finish</b>
30-0446	Down Slash	Black
30-0447	Down Slash	Chrome
30-1407	Replacement	Baffle Set



Motorcycles modified with some aftermarket parts, accessories and performance engine parts may be restricted from use on public roads and/or limited to closed courses. Please see United States E.P.A. and your respective state regulations.







# Slip On Mufflers



30-0239 Installed

30-0239



30-0359 installed on 2005 XL

30-0359



30-0455



30-0456

Slip-On Mufflers Sets have removable baffles.

Chrome	Black	Style	Year	Type
30-0239	—	Slash	1980-03	Side
30-0644	30-0649	Taper	1980-03	Tapered
30-0359*	—	Slash	2004-13	Side
30-0361*	—	Slash	2004-13	Down
30-0934	30-0935	Slash	2004-13	Down
30-0821	30-0843	Taper	2004-13	
30-0455	30-0456	Straight	2014-up	Straight
30-0568	30-0569	Slash	2014-up	Down

\*Note: Slash style includes RMB removable baffle set.



Connector Tube Gasket Set.  
VT No. 15-1533



30-0633

**V-Slots Torque Tube Set** features improved baffling and back pressure for XL. Slash type mufflers with removable baffles. Use with slip on mufflers with 3" inner diameter. **VT No. 30-0633**



30-0361



30-0934 Installed

30-0934



30-0935 Installed

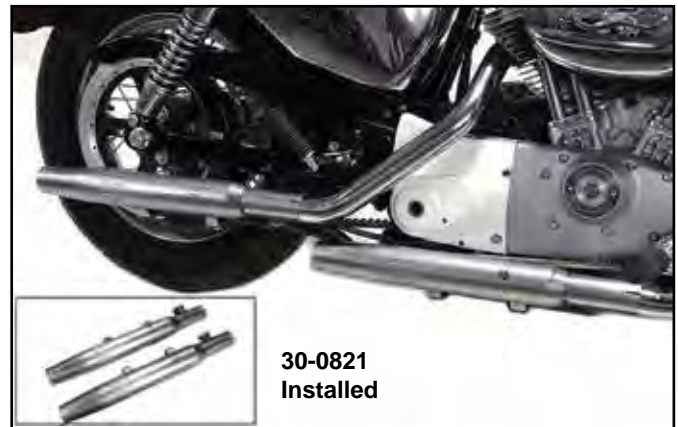

30-0821 Installed



30-0240



30-0358

**Turn Out Muffler Set Slip-On Type.** Baffles are not removable.

VT No.	Year
30-0240	1980-03
30-0358	2007-13

**Limited Warranty.** Exhaust Products distributed by Tedd Cycle Inc. are warranted against defects in material and workmanship, which include fitting and finish quality at the time of installation only. Claims regarding discoloration, peeling blistering or blued chrome will not be considered as defective material or workmanship and cannot be returned as such as per manufacturers warranty.



Motorcycles modified with some aftermarket parts, accessories and performance engine parts may be restricted from use on public roads and/or limited to closed courses. Please see United States E.P.A. and your respective state regulations.





# Heatshield

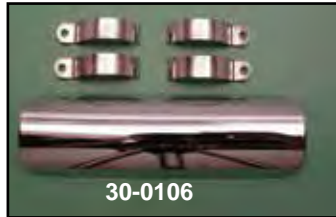

Universal Heat Shields include clamps for installation.

VT No. #	Type	Dia.	Length
30-0109 A	Perforated	1 3/4"	9"
30-0106 B	Smooth	1 3/4"	7"



30-3360 1986-2003 on Bike

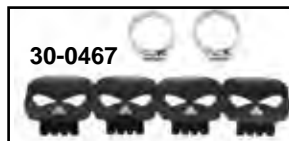

## Skull

Chrome Black	Dia.	Length
30-3385 30-0466	2 1/4"	9"
30-3386 30-0467	2 1/4"	12"
30-0468 30-0471	1 3/4"	9"
30-0470 30-0472	1 3/4"	12"

## Flame

Chrome Black	Dia.	Length
30-0118	1 3/4"	8"
30-0117	1 3/4"	11"
30-0481 30-0483	1 3/4"	9"
30-0482 30-0484	1 3/4"	12"
30-0473 30-0479	2 1/4"	9"
30-0478 30-0480	2 1/4"	12"

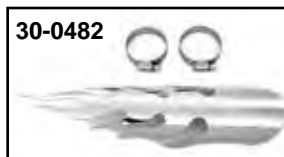

## Chrome Heatshield Set fits 2004-2013.

VT No.	Type
30-1167	Holes
30-0356	Smooth

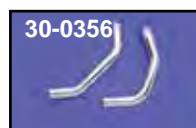

Heat Shield Set fits 1 3/4" stock or drag pipe sets, fits 1957-84 XL except 1979. VT No. 30-0082

## Chrome Exhaust Pipe Heat Shields.

VT No.	Type	Style
1957-84		
30-0099	Front	Stock/Drags
30-0100	Rear	Stock/Drags
30-3218	Rear	Stock/Drags
30-0127	Set	Cycle Shack Drag & Muffler for 1957-85
1986-2003		
30-3360	Set	Drag Pipes
2004-up		
30-0356	Set	Drag Pipes

Front Muffler Chrome Pipe Junction Shield fits 1984-2003 XL. VT No. 42-0523



Universal Straight Heat Shields are available for 1 3/4" or 2 1/4" pipes. Includes mounting clamps. Sold individually.

## For 2 1/4" Pipes

30-0120	4"
30-0121	10"

## For 1 3/4" Pipes

30-0122	10"
30-0123	12"
30-0124	18"

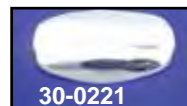

Chrome Heat Shield includes 2 clamps.

VT No.	Length
30-0221	5 1/2"
30-0245	9"



Chrome Pipe Shield for 1983-85 XL-XLS models. VT No. 42-0521





# Exhaust Clamp



31-0270



31-1007



31-2103



31-0301

**Chrome Muffler End Clamps.** 1<sup>5</sup>/<sub>8</sub>" for use when attaching muffler to 1<sup>1</sup>/<sub>2</sub>" tubing.

**VT No. I.D. Size**

31-0270 1<sup>5</sup>/<sub>8</sub>"

31-2132 1<sup>3</sup>/<sub>4</sub>"

31-1263 1<sup>3</sup>/<sub>4</sub>" Zinc

31-2103 1<sup>7</sup>/<sub>8</sub>"

31-2144 1<sup>7</sup>/<sub>8</sub>" Heavy

31-1007 1<sup>7</sup>/<sub>8</sub>" Super

31-9914 2"

31-0283 2<sup>1</sup>/<sub>4</sub>" Narrow

31-2099 2<sup>7</sup>/<sub>8</sub>"

31-2141 3"

31-1977 3<sup>1</sup>/<sub>2</sub>"

31-2109 3<sup>1</sup>/<sub>4</sub>"

31-4016\* 3<sup>1</sup>/<sub>4</sub>"

37-8683 Bolt Set

\*Note: Stainless steel sold each



**Chrome Front Pipe Clamp** for 1958-85 XL' s.  
**VT No. 31-2104**

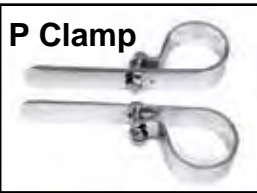

P Clamp



Hanger Clamp

**Exhaust Mount Clamps (2" and under).**

VT No.	I.D. Size	Style	Length
31-3947	1"	"P" shape	Long
31-2100	1 <sup>1</sup> / <sub>2</sub> "	Hanger	Long
31-2101	1 <sup>3</sup> / <sub>4</sub> "	Hanger	Long
31-2146	1 <sup>3</sup> / <sub>4</sub> "	"P" shape	Short
31-1011	1 <sup>3</sup> / <sub>4</sub> "	"P" shape	Long
31-0816	1 <sup>7</sup> / <sub>8</sub> "	"P" shape	Short
31-2105	1 <sup>7</sup> / <sub>8</sub> "	Hanger	Long
31-2102	2"	"P" shape	Short

**Muffler Mount Clamps**

VT No.	I.D. Size	Style	Length
31-2120	2 <sup>1</sup> / <sub>2</sub> "	Hanger	Long
31-2106	2 <sup>1</sup> / <sub>2</sub> "	"P" shape	Short
31-2119	2 <sup>1</sup> / <sub>4</sub> "	"P" shape	Short
31-2108	3"	Hanger	Short
31-1977	3 <sup>1</sup> / <sub>2</sub> "	Hanger	Short
31-2107	2 <sup>3</sup> / <sub>4</sub> "	Hanger	Short



31-2132



31-2144



31-4016



31-0273



31-2131

**Frame Mounting Clamp** is 1" clamp for mounting exhaust pipes or footpegs. Sold in pairs. Order bolts and nuts separately.

VT No.	Finish
31-2131	Chrome
31-0273	Black, P-Type Clamp



31-9971



31-9973

**Exhaust Brackets** are 1" wide x 1/8" thick for mounting goodies, pairs.

VT No.	Type
31-9971	3" Short
31-9972	4 <sup>3</sup> / <sub>4</sub> " Long
31-9973	L Bend 1" x 3 <sup>3</sup> / <sub>4</sub> "

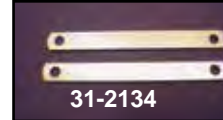

31-2134



31-2115

**Chrome Exhaust Strap Brackets.**

Straight strap 6" long, 3/8" holes. Offset 2" between 3/8" holes. Made from 1/8" steel.

**VT No. Type of Bracket**

31-2134 Straight

31-2115 Offset



A



B

**Chrome Brackets.** Sold in pairs.

VT No.	Note
31-0676	With 3/8" holes (A)
31-0677	With 1/2" holes (B)

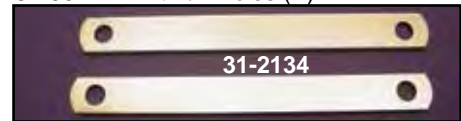

31-2134

**Universal Chrome Straps** are sold in pairs.

**VT No. Length**

31-2133 3"

31-2134 6"

31-2135 8"



**Chrome Angle Bracket** is 7" long.  
**VT No. 31-0783**

# Header Clamp



A



B

**Chrome Allen Type Exhaust Clamps** feature a unique design which allows the bolt to be nearer the exhaust pipe for positive clamping strength which permits easy access with hex wrench. Available in wide or extra wide. Fit 1957-85.

VT No.	Item
31-2112	(A) Standard Wide
31-3942	(B) Extra wide



**Stainless Exhaust Head Clamp.** Stock type construction for 1952-85 sold in pairs.

VT No.	Item
31-0226	Clamps
37-8684	Bolts



**2004-up Chrome Exhaust Flange Set** replaces 65184-02.  
**VT No. 30-0368**



**Chrome Finned Exhaust Flange** fits 1986-up XL models.  
**VT No. 30-0857**



31-2110

**Super Manifold Clamps** are stainless steel aircraft clamps. Designed with

a heat treated 'T' bolt and self-locking nut. Fits 1957-85.

**VT No. 31-2110**



31-4038

**1957-84 Chrome Allen Exhaust Clamps** with allen cap screws securing 2 barrel swivels.

**VT No. 31-4038**



**Stainless Steel Taper Valve Kit** includes 2 pure stainless extruded sleeves to fit between pipe and exhaust port, to aid in back pressure when drag pipes are

used. Kit includes solid copper machined exhaust seals which will not restrict flow.  
**VT No. 30-0312**



30-0113



30-0355

**Stainless Exhaust Taper Valves** fit into exhaust between pipe and head to put back the low end torque which is lost when large diameter or straight pipes are used. Fit Evolution with factory or aftermarket pipes, pair.

**VT No. Type**  
30-0113 Machined  
30-0355 Extruded



**Stainless Steel Taper Valve Exhaust Kit** fit into the header at the flange area to compensate for exhaust velocity when large diameter pipes installed. Fits Evolution and XL models 1986-up with large outside diameter aftermarket pipes. Kit includes two valves with gaskets.

**VT No. 30-0119**



**Exhaust Port Gasket** of knitted stainless steel. on Evolution engines.

VT No.	Type	Qty
15-0227	Tapered	2
15-0267	Mesh Gasket	5
15-0712	Tapered, James	5
15-0732	Tapered	10



15-1285



15-1274

**Exhaust Port Gasket Kit** includes two stainless steel knitted gaskets, two snap rings and four heavy duty flange nuts. Fits all 1985-up Twins.

**VT No Brand**

15-1285 Radii

15-1274 James



30-0101



30-0102



30-0103



30-0216



30-0217



30-0372



30-0618

**Pipe Baffles** fit inside straight pipes, sold in pairs. Note: Baffle size denotes size of pipe into which it fits.

VT No.	Size	Length
30-0101	1.5"	4"
30-0102	1.75"	4"
30-0103	2"	4"
30-0216	1.75"	8"
30-0217	2"	8"
30-0372	2.25"	4.5"
30-0618	2.25"	4.5"

\*Note: Fits Cycle Shack stainless steel pipes, sold each.



**Jims Exhaust Gasket Installer Tool** will correctly install exhaust port gaskets into cylinder heads, minimizes gasket distortion. Helps heads flow better.  
**VT No. 16-2112**

# Exhaust Flange



**1986-up Exhaust Gasket Set** includes 2 snap rings.  
**VT No. 15-0451**



**Exhaust Flange Kit** fits 1986-up Sportster models. Kit includes snap rings and mesh gaskets.

VT No.	Item	U/M
30-0205	Kit	Ea
12-0942	Snap Ring	10
15-0227	Gasket	2
15-0732	Gasket	10
15-0451	Gasket & Snap Ring Kit	Kit
12-1187	Exhaust Stud, 16715-83	5
30-0257	Chrome Flange Only	2
30-0724	Drilled Flange	

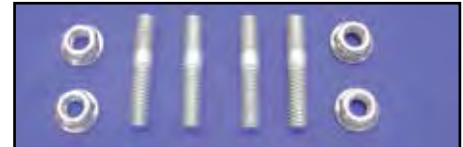

**Exhaust Stud Kit** includes four studs and four stainless flanged nuts. Fits 1986-up Sportster.

VT No.	Item
12-2125	Kit
12-1187	Studs Only

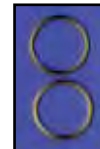

**Solid Copper Exhaust Gaskets** fit Evolution models.  
**VT No. 15-0777**



**Evolution Exhaust Kit** includes four chrome cap nuts, four washers and two mesh gaskets. For 1984-up 883-1100-1200 1340 Evolution model.

VT No.	Type
37-8900	V-Twin
15-0726	James





# Motor Mount for XLH

31-0591



31-0629



31-2137

**Chrome Top Motor Mount** for 1986-2003.

**VT No. Year OEM**

31-0591 1986-94 16278-86A

31-0629 1995-03 16278-95B

42-0027 1986-94 Top Center Mount Cover



**Chrome Motor Mounts** for Late 1984-2003 Evolution XL.

**VT No. Item**

31-2137 Front Mount Set

9772-22 Allen As Above

**1986-03 Bolt Sets**

8871-13 Acorn Center

9773-8 Acorn, Cylinder Head



**Chrome Finned Coil Cover** fits coils on top motor mount, as on FXR or custom applications.

**VT No. 42-0962**



**Horn Mount Bracket** replaces 69135-04.

Fits 2004-up XL.

**VT No. 31-0299**

## 1982-03

**Chrome 1986-2003 XL Billet Top Motor Mount** accepts coil bracket, horn.  
**VT No. 31-0713**



31-0410



9967-4



**Chrome Top Front Mount** replaces 16214-86, 1986-2003 Evolution XL 883-1100-1200 models.

**VT No. Item**

31-0410 Mount

9967-4 Bolt Kit



**Chrome Teardrop Coil Cover** fits top motor mounts with 2 holes such as 31-0664. Includes key switch hole.

**VT No. 42-0926**



31-0848



31-0849



31-0850

**Front Isolator Mount Kit.**

**VT No. Item**

31-0848 2004-16

31-0849 2004-13

31-0850 2014-16

## 2004-up Motor Mounts



31-0715



31-0882

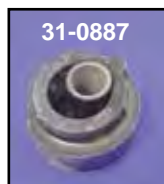

31-0887



31-0884

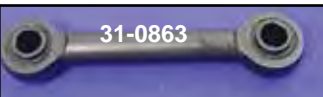

31-0863



31-0881



31-1273



31-0881



31-1280

**Chrome Allen Bolt Set** fits 2004-up motor mounts.  
**VT No. 2228-16**

**Motor Mounts** for 2004-up.

31-0715 Mount

31-0863 Tie Rod

31-1273 Tie Rod, Chrome

31-0862 Center Mount

31-0881 Tie Link Mount Bracket

31-0882 Rear Iso

31-0883 Pivot

31-0884 Rear Mount

31-0887 Front Iso

31-1280 Front Mount



**Top Motor Mount Kits** for 1957-76 Sportster in chrome.

VT No.	Type
31-0115	2 pc
31-0116	3 pc
37-0867	Chrome Hex Bolt Set



**Four Piece Top Motor Mount Kit** replaces the following 69129-72 zinc, 16250-57 chrome, 16266-76 zinc, 16265-76 chrome. Fits 1977-81.\

VT No.	Item
31-0117	4pc Kit
37-0848	Allen Bolt Set



**Top Mounts** fit 1979-81.

VT No.	Item
31-0135	Upper Front
31-0242	1982-85 XL Upper Front Motor Mount



**Top Motor Mounts** fits 1957-76.

VT No.	OEM	Item
31-0138	16250-57	Cylinder Head
31-0137	16251-58	Cylinder Head to Frame

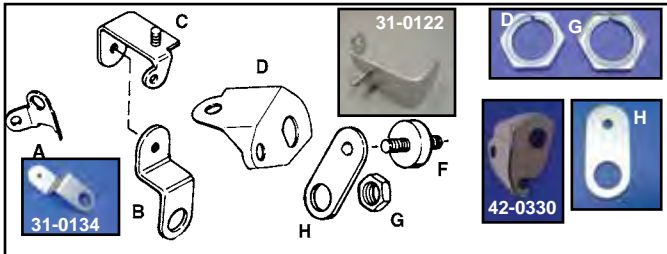

**Ignition and Horn Brackets** are chrome except noted.

VT No.	#	OEM	Years	Type
31-0133	A	69041-73	1973-85	Horn Bumper, Black
31-0134	B	69117-71A	1971-85	Horn Mount, Zinc
31-0122	C	69129-72A	1972-85	Upper Horn & Choke
42-0330	D	71510-72A	1972-up	Switch Cover
28-2247	F	69125-65	1965-up	Iso Mount
12-0550	G	69149-65		Nut, 10 pack
31-0129	H	69117-65	1965-70	Mount, Zinc

# Mount for 1957-84 XL-XLCH



**1957-77 Chrome Top Motor Mount** accepts molded coil. Available with or without hole to mount a universal key switch.

VT No.	Type
31-0113	Key Hole
31-0114	No Key Hole



**Chrome Front Lower Motor Mount Plates.**

VT No.	Years	Item
31-0120	1952-81	
31-3978*	1982-E84	
40-0301**	1982-E84	
7141-18	1952-84	Acorn Bolt Kit

\*Note: Does not have oil filter provision.

\*\*Note: Includes oil filter.



**Front Lower Motor Mount Bolt Kits** fit 1957-84.

VT No.	Type
7141-18	Acorn, Stock with Spacer and Washer
7408-10	Extra length for forward pegs, Acorn, Complete Does not include spacers
9797-20	Allen Type, Complete
9798-20	Stock Hex Type, Chrome, Complete
9799-20	Stock Hex Type, Cadmium, Complete
37-9207	Stock Hex, Chrome, Bolts only
37-9086	Spacer Set, Chrome
37-9158	5 Locating Washers



**XL Rear Motor Mount Cast Replacement**, top 2 bolt style. Order studs separately.

VT No.	OEM	Years
31-0111	16203-67	1967-81 XLH, 1970-81 XLCH
31-0224	16203-82A	1982-90 XLH

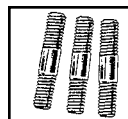

**Rear Engine Case Studs.** Set of 3.

VT No.	OEM	Years
12-1151	24817-52	1952-81
12-1150	24825-82	1982-90





# Coil



**V-Tech™ Single Fire Coil** gives 1 spark for each cylinder as fired and will mount to stock bracket and accept stock coil cover.

**VT No. Finish**  
32-0467 Black  
32-0474 Chrome

**Volt Tech Black Molded Coil** features black late shape with bobbin type windings. 32-0511 features side terminals for 1983-99.

VT No.	OEM	Year
32-7572	—	1965-79
32-7573	—	1980-82
32-0511	31614-83A	1983-03
32-0743	31655-99	2000-06
32-0771	31656-07A	2007-up
12-0586	7638	All Coil Stud Nut



**80 KV Coil** for 1965-99 mounts to stock locations.  
**VT No. 32-0095**



**Volt Tech Stock Coils** are factory quality to fit stock brackets.

VT No.	OEM	Years
32-0711	6 Volt	Pre1965
32-0128	12 Volt	1965-79
32-0129	12 Volt	1980-83 (2.8 ohm)
32-1268	12 Volt	1965-79, Red

**Note:** VT No. 32-0129 for electronic ignition, top terminal mounting.



**Chrome Stock Style Coils** bolt to original brackets for exact fit.

VT No.	OEM	Year
32-0513	31609-65A	1965-79
32-0514	31609-80	1980-83
32-0512	31614-83	1984-99

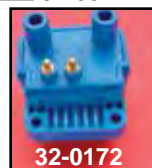

**Blue Streak 45,000 Volt Coils** provide more spark and energy than stock coil and the higher voltage eliminates spark deterioration at peak RPM.

VT No.	Years	Type	Ohms
32-0171	1980-99	Electronic Ignition	2.7
32-0172	1965-79	Point Ignition	4.6



**Chrome Coil Mount Bracket Kit**

VT No.	Year
31-0131	1971-94
31-0321	1995-up
31-0758	2004-up



**Coil Cover** available in polished stainless or chrome.

VT No.	Fits	Finish
42-0839	1983-03	Chrome
42-0039	1985-03	Stainless
42-0418	1971-78	Chrome

**Coil Mount Studs** replace 64611-55, 64612-55 models, pairs. Fits 1955-67 XLH.  
**VT No. 37-9156**



**Andrews Coils.** Black coil fits through 1980 with point type ignition sets. Rust colored coils are for 1981 and later with electronic ignition systems. Both coils produce more voltage than stock coils.

VT No.	Color	Ohms	Years
32-0709	Black	4.8	Pre1980
32-0712	Red	2.8	1980-99

# ACCEL Coil



**Accel H.V. Super Coil.** High performance bolt on for points or electronic ignition systems. High-tech molding for exact fit on 1965-99.

VT No.	Ignition	Ohm
32-7771	Points	4.7
32-7800	As Above	Chrome
32-7772	Electronic	2.3
32-7801	As Above	Chrome



**Accel Single Fire Super Coil** features ultra fast coil rise time with voltage output 45% higher than stock and 3.0 ohms of primary resistance. Mounts to stock coil bracket and fits under stock coil covers.

VT No.	Finish
32-0090	Yellow
32-7802	Chrome



**Accel Power Pulse Coil** provides longer spark duration with a greater KV rating and faster rise time than stock coil. Molded in bright yellow epoxy. 12 Volt 1965-83 Twins.  
**VT No. 32-0130**



**Daytona Twin Tec TCFI Gen 4 Auto Tune Fuel Injection Controller** is fully programmable plug in replacement for the 36 pin Delphi controller with J1850 data bus.

- Quickly auto-tune fuel curves for front and rear cylinder on a dyno or on-road with new WEGO IID dual channel wide band oxygen sensor interface.
- Fully programmable plug-in for 36 pin Delphi® controller with J1850 data bus.
- Powerful Windows software for custom programming and data analysis
- Full support J1850 data bus used for communications with turn signal/security module (TSM/TSSM) and instrument cluster
- Support for new 6th gear indicator.
- Extended data logging and diagnostics. DataFLASH memory stores full 60 minutes of operating data at 10 samples/second.
- Programmable user input and output.
- Billet aluminum housing with black anodized finish
- Easy plug-in installation
- Supports all sensors including theft/security module

Includes TCFI Gen 4 plug-in fuel injection controller with billet aluminum housing with black finish, dual channel wide band exhaust gas oxygen sensor interface, two Bosch LSU 4.2 wide band exhaust gas oxygen sensors, and two 18 x 1.5mm weld nuts for exhaust pipes. Quickly auto-tune fuel curves for front and rear cylinders on a dyno or on-road. The robust alpha-N fuel control eliminates problems with long duration/high overlap camshafts. Windows software provides custom programming and data analysis. Its full support for J1850 data bus used for communications with turn signal/security module and instrument cluster.

\*NOTE: Not legal for sale or use on pollution controlled vehicles.

Fits 2007-up Sportster

**VT No. 32-7401**



**Dynatek Fusion EFI Ignition Module**

VT No.	Sportster	Applications
32-1178	883	2010-13
32-1179	883	2014-up
32-1180	1200	2007-09
32-1181	1200	2010-13
32-1182	1200	2014-up



**Dyna Ignition Booster** for single point systems only transforms inconsistent electrical surges into controlled bursts of energy to the coil, power is not wasted. **VT No. 32-7787**

# Tune Up Kit



**V-Twin Tune-Up Kits** include plugs, points and condenser. Also available as points and condenser kit only.

With Plugs	Without Plugs	Years	Fits
32-1114	32-0114	1957-70	XLH
32-1115	32-0115	1970-74	XLH
32-1116	32-0116	1958-69	XLCH Magneto
—	32-0115	1975-78	XL
32-1232	—	1957-70	XLCH, Kit



**Accel Performance Tune-Ups Kits** include replacement spark plugs, matched crown contact points, condenser, gap settings and point cam lube. Kits available without spark plugs.

VT No.	Fits
32-0109	1957-69 XLCH with magneto
32-0107	1957-70 XLH, 1969 XLCH
32-0106	1970-78 XL



**Blue Streak Premium Parts** for 1970-78 Twins

VT No.	OEM	Item
32-0156	32661-70	Points
32-0157	32726-30A	Condenser



**Point Sets.**

VT No.	OEM	Model	U/M
32-0117	30605-48	1957-70 XLH, 1970 XLCH	Each
32-0118	32661-70	1970-E78 XLH-XLCH	Each
32-0119	29533-55A	1958-69 XLCH Magneto	Each

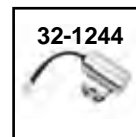

**Condensers.**

VT No.	OEM	Year/Model
32-0121	32726-30A	1957-70 XLH, 1970 XLCH 1971-E78 XLH-XLCH
32-1316	5 pack	As Above
32-1244	—	1957-1970 XLH 1957-1978 XLCH
32-0122	29534-55A	1958-69 XLCH Magneto





# Spark Plug and Cover



**V-Twin Performance Spark Plugs** features a copper core electrode for a longer service life, nickel plated housing, 95% pure alumina insulator and a heat crimping process to ensure a leak free seal.

VT No.	Applications	#
32-6691	1986-up Evolution	6R12
32-6696	1979-85	4R5
32-6697	1971-85	4R
32-6698	1957-78	3



**Blue Lightning Bug Spark Plug Ends** are neon gas filled, glow as strobe lights. Fit plugs with screw terminal fittings only, pair.  
VT No. 32-1552



**Sparkies** are chrome plated die cast covers to fit perfectly on a spark hex for Evolution XL 883-1200 models, pair.  
VT No. 37-8953

## Autolite Platinum Plugs.

VT No.	Autolite#	Year	Model	U/M
32-9232	AP4164DP2	1986-up	V-2 Evolution	Pair

## Autolite Spark Plugs, Standard.

VT No.	Auto#	H-D#	Fits	
32-9293	4316	4	1954-79 Hotter Plug	10
32-9294	4123	4R5	1980-85	10
32-9295	4164	6R12	1986-up Evolution XL's	10



**OE factory spark plug set have copper coated electrodes for foul resistance.** Sold as a pair. Fits 1971-85 XL. Replaces OEM# 32301-80. Mfg # 4R5.  
VT No. 32-8903



**1986-up Head Bolt and Spark Plug Covers** are die cast and chrome plated to cover entire head bolt area and spark plug base. Held in place by rubber boots on spark plug wires. Fits 883-1200 XL models.

VT No. 42-0741



Champion Spark Plug available in Copper Plus style.						
Engine	Fits	HD#	Gap	Copper Plus Champion	Qty	Copper Plus VT No.
1200 V2	1988-up XL	6R12	.040	RA8HC	4	32-7547
1100 V2	1985-87 XL	6R12	.040	RA8HC	4	32-7547
883 V2	1985-up XL	6R12	.040	RA8HC	4	32-7547
1000	1979-85 XL	4-RS	.040	RL82YC	4	32-7545
	1972-78 XL	4	.030	H8C	4	32-7544
	1972-78 XL	4	.030	H10C	4	32-8073**
900	1957-71 XL	4	.030	H8C	4	32-7544
	1957-71 XL	4	.030	H10C	4	32-8073**

\*Note: RN13LYC may also be used  
\*\*Note: One heat range hotter than stock replacement plug



**Bosch Spark Plugs** sold in pairs. Available in silver type.

**Silver:** Hard silver center electrode, extended service life.

VT No. 32-1223

Engine	Fits	HD#
1200 V2	1988-up XL	6R12
1100 V2	1985-87 XL	6R12
883 V2	1985-up XL	6R12



**Spark Plug Wire Clamp Set.**  
**VT No. Size Finish**  
**37-9062 7mm Chrome**  
**37-2911 8mm Chrome**



**Sumax Thunder Volt 50 Black Wire Sets** feature a ferrite spiral wound coated core that is a blend of copper/nickel alloy bonded by a conductive acrylic latex cover. This process is designed to reinforce and assist in holding core resistance to 50 ohms. The fat 10.4 mm (.409") wires also feature three layers of pure zimplex silicone, 600 degrees of heat protection, 102,000 volts dielectric strength with a tightly woven heat treated fiberglass braid and black pro boots bonded to the black with gold lettering wires. Available in 8.2mm or 10.4 mm.

8.2mm	10.4mm	Fits
32-5206	32-0033	1986-2003 XL
32-5204	32-2032	2004-up XL
32-5208	32-5608	24" Universal (2 pc) with 90° boots
32-5202	32-0031	1971-85 XL

## Blue Streak Wire Set



**Blue Streak XXX Silicone 8mm Wire Sets** offer maximum RFI suppression. Copper core wire sets are for point type ignition systems only and feature a copper core wire to allow for special improved electrical conductivity and mechanical strength. All wire sets are supplied with electrical boots and OEM style terminals that lock onto the spark plug.

**8 mm**

### Copper Core Sets

VT No.	Year	Model
32-0250	1958-69	XL/XLCH w/Magneto
32-0251	1971-78	XLH/XLCH

### VT No. XXX Silicon Sets Replaces

32-0253	Universal Application	Self Make Kit	32095-98
32-0257	1986-05	XL	32092-98
32-0261	1998-up	4 Plug XL 1200S	32054-98
32-0270	2004-06	XL	31958-04A
32-0271	2007-up	XL	31901-08



32-9101

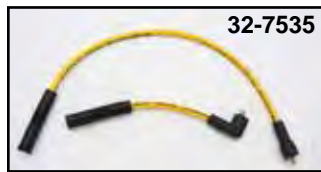

32-7535

**Accel 8.8mm Custom-Fit Ignition Wire Sets** are available in 300+ or custom fit.

300+	Custom Fit		Year	Model
Black	Yellow	Black		
32-9101	32-0656	32-8044	L1979-85 L1979-82	XL, XLCH-XLX, XLS
32-9101	32-0655	32-8046	1971-E78	XLH-XLCH
32-9102	32-0659	32-8047	1958-69	XL-XLCH w/ Magneto
32-9105	32-7535	32-8050	1986-up	All XL's
<b>8mm V-Twin Wire Set</b>				
—	32-0661	—	1971-83	XL-XLCH

# Wire Set



**Universal 7 mm Wire Sets** are 40" long with double 90° spark boots. Simply cut to the desired length and install coil terminal clips supplied. Available in copper or suppression core.

VT No.	Color	Type
32-0647	Yellow	Suppression
32-0648	Yellow	Copper
32-0650	Orange	Copper
32-0651	Black	Suppression
32-0696	Black	Copper
32-1123	Red	Copper

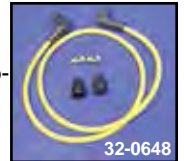

**8 mm**

**Sumax by Taylor Colored 8 mm Plug Wires** are pre-cut and have the plug/coil boots and terminals already installed. Designed for electronic ignition, but work great on point types.

Color	1986-03	2004-up
Red	32-7233	32-2024
Purple	—	32-2034
Blue	—	32-2064
Black	32-7033	32-2004
Yellow	—	32-2044



**Universal 8mm Pro Spark Plug Kits** feature 24" wire leads with either 90° or 180° molded plug boots and straight coil boots with brass terminals. Wires feature the Spiro-Pro design which provides 10 times the firepower of carbon core wires and heat protection to 600F. Works with electronic or points style ignition. All wires have a resistance factor of 350 ohm/ft. Great for magnetos, distributors or dual plug heads.

90° Kits	Color	32-6481	Yellow
32-6081	Black	32-6681	Blue
32-6181	White	32-6381	Purple
32-6281	Red	32-6085	Black (180° Kit)

**42" Accel 8.8 Wire Sets** have the ends terminated with a 90° or a variangle boot and comes with a hardware kit which includes terminals, boots and instructions.

### Variangle

VT No.	Color	Type
32-9248	Black	Suppression
32-9252	Yellow	Suppression
32-9253	Yellow	Copper
<b>90°</b>		
32-9250	Black	Suppression
32-9254	Yellow	Suppression
32-7536	Yellow	Copper



**Splitfire Dual Mag Black 7mm Wire Set** incorporates two premium magnetic suppression core conductors, which are protected by a layer of braided fiberglass and a 100% pure silicone outer jacket. Fits 1985-98.

**VT No. 32-2086**





# Ignition Advance Unit



**Blue Streak Sifton "Tuneable" Ignition Advance Assembly** includes stainless advance base, points plate with "Blue Streak" points and condenser with hardware and 3 pairs of color coated springs which allow full advance at 1400, 2000 and 2600 RPM depending on which spring is selected.  
**VT No. 32-0713**



**Mallory Ignition Plate** fits all 1971-78 XL models.  
**VT No. 32-5129**



**Points Plate Assembly** available as stock point and condenser replacement or Accel Super plate with micro chip condenser and 32 oz. spring points. Both for 1970-78.

VT No.	OEM	Item
32-0549	32577-70	Point Plate Assembly
32-0042	32618-70A	Mount Plate Only
37-8809	1047	Point Mount Plate Screws and Washer Assortment
	7115, 6189W	

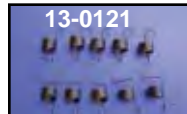
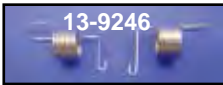
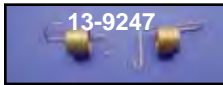

## 1970-up Advance Weight Springs.

VT No.	Fits
13-9247	Severe Duty Advance Weight Springs for all Hi-compression and heavily modified engines. Also useful for applications experiencing detonation (pinging) or very erratic idle, pair
13-9246	Heavy Advance Weight Springs for slightly modified stock, low compression or mild stroker application, helps cure minor idle problems, pr
13-0121	Original type replacement. Uses premium grade spring steel, 10 pack



**Tuneable Advance Unit** features stainless base, heat treated weights cam bolt and 3 different color coded spring sets which allows full advance at 1400, 2000, and 2600 RPM depending on which springs are selected. Can be used with all ignitions, points, single or dual fire types which utilize an advance unit. Springs also available separately.

VT No.	Type	Item
32-9220	Stock	Kit
32-9261	Needle Bearing	Kit
32-7510	Stock Base Only	Base
32-0055	Bolt	



**Points Conversion Kit.** Both brands include everything necessary for direct replacement on 1971-78 Sportsters or for converting

late model electronic-type back to points. Accel type available with microchip points, which will require a domed shaped points cover such as VT No. 42-0299 to accommodate taller points. The V-Twin unit includes stock style points and condenser and is available with stock needle bearing weights.

VT No.	Item	Type
32-7773	Accel Microchip	Stock
32-0136	V-Twin Points	Stock
32-0150	V-Twin/Points	Needle



**Stainless Advance Unit** features stainless base, heat treated weights & cam center screw for 1970-up mechanical advance ignition.

VT No.	Item	Brand
32-0178	Set	Sifton
32-0168	Set	V-Tech <b>Note:</b> Without bolt
32-0055	Bolt Only	V-Twin

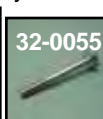

**Advance Units** feature heat treated weights. Order center bolt separately.

VT No.	Type
32-7510	With steel base
32-0055	Center bolt



**Competition Advance Unit** features machined stainless steel shaft and plate, metallic coated weights and special wound springs for exact advance. Replaces 32505-78A for 1970-up, mechanical advance applications. Center screw included.

VT No.	Item	Brand
32-9037	Competition Unit	Rivera
32-9220	Complete with tuneable springs	V-Twin



**Points Plate Screws.**

VT No.	Year	Type
32-0049	1982-up	Steel
32-0760	1982-up	Stainless
32-0051	1970-81	Steel

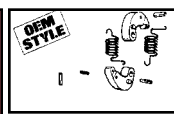

**Automatic Advance Rebuild Kit** includes 2 of the following: springs, weights, and 4 roll pins. For all 1970-78 Twins.

**VT No. 32-0140**



# Ignition and Points Cover for XL



1971-03	2004-up		42-0748	Chrome Flame
42-0090	42-0106	Chrome Live to Ride	42-5522	Chrome Flame
42-0087	42-0088	Gold Live to Ride	42-0065	Chrome Flame with Black Skull
42-0035	42-0035	Chrome V-Tech	42-1078	Chrome with Skull
42-0299	42-0299	Chrome Domed	42-1110	Chrome Perforated
42-0662	42-0662	Chrome Flat	42-1115	Black Ball Milled
42-1535		Chrome Flame Mesh Design	42-0155	Chrome Smooth
42-0638		Chrome Finned	42-1058	Chrome Milled Skull
42-0084	42-0081	Chrome Skull	42-1116	Black Smooth
42-0582		Black Chrome Skull	42-1125	Black Perforated
42-0960	42-0960	Chrome Maltese	42-1122	Black with Alloy Flames
42-6100	42-6100	Chrome Raised Maltese	42-1095	Chrome Ball Milled
42-0561	42-0560	Black with Chrome Raised Skull	42-0581	Black with Chrome Skull
	42-1261	Chrome with Chrome Skull	42-0474	Chrome Flame
	42-1262	Chrome with Black Skull	42-0475	Black Flame
	42-1383	Chrome Air Flow	42-0189	Black Smooth
	42-1384	Black Air Flow	42-0198	Chrome Smooth
42-0162	42-0162	Chrome Maltese Spinner	42-0465	Chrome Flames with black mesh
42-1524	42-0464	Chrome with Black Mesh Skull	15-1032	1970-03
42-0956	42-0956	Chrome Hidden Mounting	15-1033	1980-up
	42-1176	Chrome Skull with Chain	8764-2	1970-78 Allen
42-1146	42-1148	Chrome Grooved	8765-2	1978-up Allen
42-1147	42-1166	Black Grooved	8402-2	1978-up Chrome Acorn
			2219-2	2004-up

## Timing Plugs

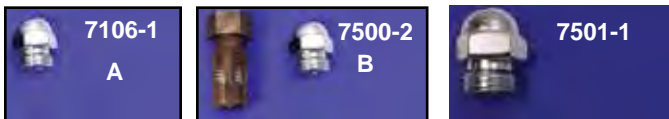

**Timing Plugs.** Note Stock is 5/8" - 18 thread, Oversize is 11/16" - 16.

**A.** Acorn style plug fits all Sportster models timing plug holes and oil tanks.

**VT No. 7106-1**

**B.** Acorn style plug with oversize thread and one tap for rethreading stripped out timing hole. Fits all timing holes.

**VT No. Type**

**7500-2** Plug and Tap (Oversize)

**7501-1** Plug Only (Oversize)

**9407-1** 11/16"-16 Tap (Oversize)

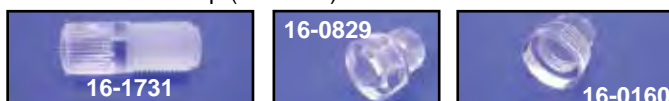

**Clear Timing Plugs** are available as a long optically clear type or a short standard version with or without the internal hex.

**VT No. Item**

**16-1731** Long Type

**16-0829** Hex Type

**16-0099** Standard, 10 pack

**16-0160** Standard, each



**C. Stock Type Timing Plug for 1936-69** in chrome or cadmium finish.

**VT No. Finish**

**8114-1** Chrome

**8115-1** Cadmium

**9404-1** Cadmium (Oversize)

**9304-1** Chrome (Oversize)

**D.** Functional and custom design plug fits all Sportster timing plug holes and oil tanks.

**8610-1** Chrome

**8611-1** Cadmium



**E.** Allen style plug use on all 1970-up replaces 720.

**9402-1** Chrome

**9403-1** Cadmium

**37-9206** Chrome by Gardner-Wescott

**9960-1** Chrome (Oversize)





# DYNA Ignition



**Dyna 2000 Digital Ignition Systems.** Systems include Dyna 2000 HD-1 Ignition Module and a matched Dyna Twin Fire Coil for each application.

VT No.	#	Fits
32-0802	SFK-3	1994-up XL
32-0804	SFK-1	Pre 1994 XL
32-9118	Programming Software for 32-0802	
32-9117	Programming Software for 32-0804	



**Dyna 2000i Digital Ignition** available as a module only or complete kits that include correct coil as listed. Features include single or dual fire operation, 8 advance curves, built in tach driver, adjustable RPM limit from 6000 to 7500

and easy static timing with built in timing indicator. Fits all 1970-98 carbureted models and requires 1983-up sensor cup for 1982 and earlier applications. Advanced Programming Software allows mechanic or tuner the ability to fine tune 2000i ignition but requires adapter harness.

VT No.	Item
32-9151	Kit Single Plug/Single Fire with DC3-1
32-9152	Kit Dual Plug/Single Fire with DC1-1
32-9153	Kit Dual Plug/Dual Fire with DC2-1
32-9155	Kit Single Plug/Single Fire with DC6-5 miniature coil
32-9159	Module Only
32-9087	Sensor Cup, 1983-94
32-9124	Sensor Cup, 1995-up
32-9052	Cup Screw, 10 pk
32-9120	Advanced Programming Software for Above Ignitions
32-9121	Software Adapter Harness for Above Ignitions

**Power Commander V Fuel and Ignition Timing Control** for each cylinder in a new smaller enclosure. Rev Xtend feature increases stock rev limiter. Switch between two maps "on the fly" maps can be adjusted on a "per gear" basis. Allows for one map per cylinder per gear if required. Adjustment of fuel and timing based on engine temperature is provided by the cold start feature. Will power up with USB cable only for programming. Note: not legal for use on pollution controlled vehicle

VT No.	Fits
32-0844	2007-2009 XL 883
32-0846	2007-2009 XL 1200
32-1031	2010-12 XL 883
32-1032	2010-12 XL 1200
32-1051	2013-up XL 883



Dyna	Application
DC6-5	All FXR-FXST and Dyna
DC6-4	Dual Spark Plug Head

**Dyna Twin Fire Ignition Coils** are designed to work with Dyna 2000 HD-I ignition modules. Twin fire coils are slightly larger than stock coils, fit the stock mounting bracket. Twin fire coils can be used with any electric advance ignition system that incorporates dwell control except Dyna DS6-2 or similar type ignitions.

VT No.	Dyna	Ohms/Type
32-9285	DC6-5	3 (A)Twin Fire II Miniature Dual Output Towers, Replaces DC6-3
32-9264	DC6-4	3 (B) Four output towers Fits Dual Spark Plug

# Daytona Twin Tec

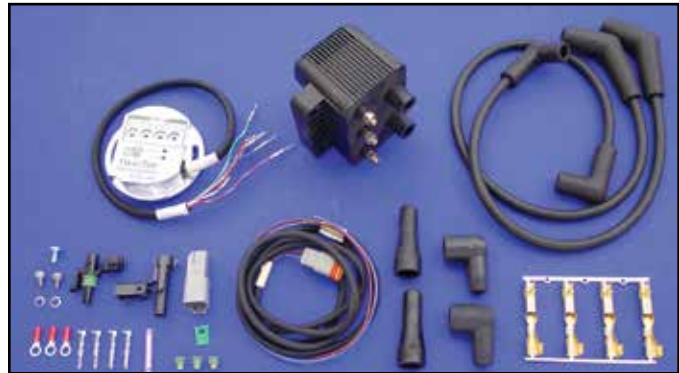

**Daytona Twin Tec Internal Ignition Kit** for 1998-03 Sportster models (except 1200S). Kit includes matching Deutsch plug and harness for single fire conversion, coil and spark plug wire set. VT No. 32-3016



**Twin Tec Internal Ignition for 1970-99 Big Twin models and 1971-1997 XL.** Two advance curve families with adjustable advance slope accommodate stock to highly modified engines. Digitally set RPM Limit (100 RPM Steps). Selectable single or dual fire mode. Coil outputs protected against short circuits. Optional PC link cable and software for programming custom advance curve VT No. 32-1005



**Daytona Twin Tec External Ignition Kits** include module, coil and spark plug wire set. VT No. Fits  
32-3017 1990-93 Sportster  
32-3018 1994-99 Sportster



**Daytona Twin Tec Internal Ignition Kit** for 1971-97 Sportster models. Kit includes ignition, coil and spark plug wire set. VT No. 32-3015



**Sensor Cup Kit** includes special screw to fit all "Sensor" type ignition kits. Fits 1995-99. VT No. 32-9124



# DYNA Ignition



**Dyna 'S' Hi-Performance Ignition System** is completely self contained, fits behind ignition cover, uses magnetic rotor with the original spark advancer so factory advance curve is maintained. Improves performance,

extends spark plug life, eliminates points and condensers. Great for dual plugged heads, on 1980-up use advance mechanism VT No. 32-7510. **VT No. 32-7778** (DS6-1)



**Replacement Rotor** for Dyna Ignitions.

**VT No. Fits**  
**32-9300 DS-6-1**  
**32-9301 DS-6-2**



32-7777

**Dyna 'S' Single Fire Ignition** has the features of the Dyna 'S', but fires front and rear cylinders independently of each other which allows accurate timing of each cylinder. Stock ignition systems fire both cylinders at the same time which has the wasted sparks on the exhaust stroke. This eliminates this inherent problem. For use with either dual or single plug heads. On 1980-up models, use VT No. 32-7510 Advance assembly. **VT No. 32-7777** (DS6-2)



32-9020

**Ignition Sensor Plate Assembly.**

**VT No. OEM Fits**  
**32-9020 32400-80A 1980-94 XL**  
**32-0519 32400-94 1995-97 XL**



**Dyna Electric Tach Adapter Kit** must be used with Dyna 'S' single fire ignition is installed on any twins when electric tach is used.

**VT No. 32-7799**



32-3047



32-3048

**Daytona Twin Tec External Single Fire Ignition Conversion Kit** includes 50 state street legal selectable ignition module, sensor plate, rotor cup and adapter harness that allows use of tachometer and single fire coil. Allows use of external ignition on all 1970-1999 carbureted only Big Twins and 1971-2003 XL models. Helps prevent heat related ignition failures by replacing heat sensitive internal nose-cone style ignitions. Also available as complete kit with correct 3.0 ohm single fire coil and plug wire set.

**VT No. Item**

**32-3047 Conversion Kit**

**32-3048 Complete Conversion Kit with Coil and Wires**



32-0801

**Dyna S Performance Ignition Systems.**

Available in dual or single fire for street applications only. Each kit includes sensor plate assembly and correct coil for each application. Single plug only. 1980-up applications require 32-7510 advance mechanism.

**VT No. # Type**  
**32-0800 DSK-6-2 Single Fire**  
**32-0801 SDK-6-1 Dual Fire**



32-7789

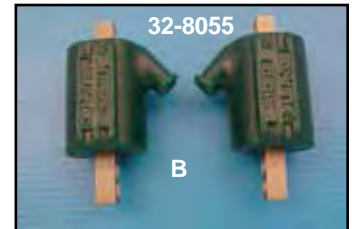

32-8055



32-7792



32-7793

**Dyna Coils.** 35,000 volts! Works with all points ignitions, aftermarket or factory electronic ignitions.

**VT No. Volt Ohm # Dyna Type U/M**  
**32-7789 12V 3 A DC-1 Angle, Dual Pair**  
**32-7790 6V 1½ A DC-2 Angle, Dual Pair**

Use 2 for dual plug heads

**32-7792 12V 3 C electro DC-6 Stock, Dual Each**  
**32-7793\*12V 5 C points DC-7 Stock, Dual Each**  
**32-8055 12V 3 B DC-3 Angle, Single Pair**  
**32-8086 12V 5 A DC-8 Angle, Dual Pair**  
**32-9035 12V 5 B DC-10-1 Angle, Single Pair**

\*Note: Use 2 for single fire ignition.



32-1732

**Crane H1-4N Multi Function Performance Ignition** features one piece machined aluminum housing, BCD switches with solid detent and legible markings,

which allows easy adjustments of mode. Advance rate and rev limit, single or dual fire operation and initial timing marks that allows precise adjustment. Fits 1970-97 XL. Also available as an ignition kit which includes HI-4N ignition, single fire coil and 8.5 mm plug wire set.

**VT No. Item**

**32-1731 HI-4N Ignition**

**32-1732 HI-4N Kit**

**Single Fire:** Just the spark plug for the piston that is in its compression stroke will be fired. The other piston, being in its overlap position will not be ignited.

**Dual Fire:** Both spark plugs are fired simultaneously at the time only one piston is in its compression stroke.

This is the way the stock motor works.

**Single Plug:** One spark plug in each head. Total of 2 spark plugs in one engine.

**Dual Plug:** Two spark plugs in each head. Total of 4 spark plugs in one engine.





# Module for XL



**Power Commander III Engine Management System** is for fuel injected models and allows for both fuel and ignition adjustments. USB cable and 9 volt battery power adapter are included. The Power Commander includes an link cable and software package which allows you to fully map the fuel ignition curves on a computer. If a computer is not available, the fuel curves can be adjusted by using three touch buttons on the face plate. This unit includes a specific map, designed to improve performance over stock. Fits 2007-2008 XL 883, EFI model.

**VT No. 32-3029**



**Replacement Ignition Modules** bolt-on replacements. Harness 32-9014 required as noted.

<b>VT No.</b>	<b>OEM</b>	<b>Fits</b>
42-0399		Cover
32-2218	32466-95A	1995-97 XLH 883



**S&S Spark Technology Ignition System Installation Kit**

32-1049	1986-03
32-7806	2004-up

**Compu-Fire Plug In Performance Ignition Module** features programmable advance curve, RPM limit, Single Fire or Dual Fire operation, Accu-Ray Timing light which simplifies installation and two selectable levels of VOES control. Fits 1996-97 8 pin Deutsch style. **Note:** Each module has two pigtailed and plug connector. White lead goes to tach, red lead goes to the second coil for single fire operation.

**VT No. 32-2503**



**Power Commander V** features 2 position map switching function, gear and analog input. Power commander also allows each cylinder to be mapped individually and for each gear. This has 10 throttle position columns, and enhanced accel pump utility. Unit has a -100/+250 percent fuel change range and is compatible with 2009 and newer models.

<b>VT No.</b>	<b>Fits</b>
32-1053	2014-up 883
32-1060	2014-up 1200
958	



**Self Learning Module** by Accel helps regain control of fuel injected bike. Improves mileage-while increasing power and reducing emissions, works on all stock and mildly modified. Automatic recalibration-optimizing

modifications gains expected from performance exhausts, air cleaners and camshafts. Easy installation-direct plug-in connections to factory throttle position, crank shaft position, and oxygen sensors. Self learning-module seamlessly compensates for changing loads, weather conditions and altitude while you ride; no need dyno tuning sessions or downloading new calibration maps to a laptop computer. Smoother running engine-eliminates to pop and bang associated with a mis-programmed ECU due to intake or exhaust modifications, the need to re flash the factory ECU has been eliminated, truly a plug and play proposition. ACCEL NO. SLM03 07-11 Sportster utilizes factory installed O2 sensors

**VT No. 32-1702**



**Dyna Tek FI Controller** is a plug module that offer 3 user selectable base fuel curves that are designed to improve engine operation and can be modified to suit a wide variety of modifications. Fuel mixture can be enriched or leaned as required. The Dyna FI controller uses the factory connectors for

easy installation and there is no PC required for tuning or adjusting the fuel curves. There are no modifications required to the stock ECU and removing the Dyna FI controller returns the vehicle to the factory configuration.

<b>VT No.</b>	<b>Fits</b>
32-3035	2007-09 XL 883
32-3036	2007-09 XL 1200



**Accel Late Model Super Coil** for late model Twins with carb. Features faster rise time, higher voltage, maximum spark and energy to spark plugs for quicker starting, improved idle and crisper throttle response. Fits in OEM location and is available in black finish. Fits 2005-06 All XL models.

**VT No. 32-1810**

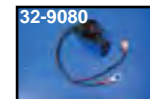

**Vacuum Switch Assembly**

<b>VT No.</b>	<b>OEM</b>	<b>Fits</b>
32-9079	26557-83	83-85 XL-XLS-XLX
32-9080	26558-84	1986-93 All XL



**Dyna 2000 Ignition Modules** for 2000-up Sportster models feature programmable advance curves, rev limiter and LED diagnostic lamp for easy static timing. Plugs into stock harness and bolts to stock module location.

<b>VT No.</b>	<b>Fits</b>
32-9123	2004-07 with carburetor
32-1067	2007-up 883 with EFI
32-1068	2007-up 1200 with EFI



# Charging System



32-9099



Back Side of 32-9099

**Alternator Rotor by Volt Tech** features vibration proof magnet construction, as magnets are held in place by a stainless steel non-magnetic insert for durability. Unit includes sprocket. OE type has stock type magnets.

VT No.	Teeth	Year
32-9099	35	1991-2003
32-0024	38	2004-up
32-0030	34	2004-up



**Alternator Rotor Clutch Shell Assembly** feature vibration proof magnet construction, as magnets are held in place by stainless steel non-magnetic insert for durability. Replaces 36791-84. Fits 1984-90. Bearing and ring gear included.

**VT No. 18-8324**



32-0472

**Volt-Tech 1991-up Charging System** for XL models. Complete kits include rotor, stator, regulator and all hardware necessary for complete installation.

VT No.	Year	Teeth
32-0471	1991-93	35
32-0472	1994-03	35
32-0023	2004-up	38
32-0025	2004-up	34



32-0473

**Charging System** fits 1984-90 XL models with alternator in clutch drum. Kit includes alternator rotor clutch shell assembly with bearing and ring gear installed, which features vibration proof magnet construction, as magnets are held in place by stainless steel non-magnetic insert, stator and chrome regulator.

**VT No. 32-0473**

**Charging System Kit for XL's developed by V-Twin in 1995**

### Warranty

All Electrical Components sold as individual pieces or in kits are covered under our warranty "Replacement Only" Provision. All electrical related item part numbers begin with a 32 prefix. No credit will be issued for these items as they are exchange only.



Unmolded

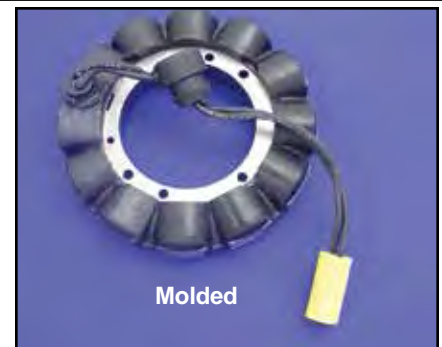

Molded

**Stators** replace stock units for models listed in molded or unmolded type. 32-0965 features heavy duty copper windings.

VT No.	Brand	Type
<b>1985-89 XL, Replaces 29967-84A, 19 Amp</b>		
32-7566	Volt Tech	Unmolded
32-9043	Accel	Unmolded
32-9044	Accel	Molded
<b>1990-06 XL, Replaces 29967-89A, 22 Amp</b>		
32-9230	Volt Tech	Unmolded
32-0965	Volt Tech	Unmolded
32-9046	Accel	Unmolded
<b>2007-up XL, Replaces 29997-07A</b>		
32-0958	Volt Tech	Unmolded



32-0965



XL





# Regulator



Chrome



32-0809



32-0684



32-0989

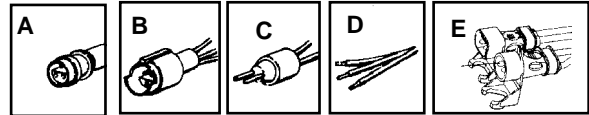

**Volt Tech™ and Accel Solid State Regulators** feature rugged aluminum alloy construction. Accel Brand available in chrome, alloy or black stock finish with polished top fins or Volt Tech's black or chrome finish. Provides more accurately regulated voltage under all electrical loads. All units listed carry the full replacement warranty by Accel or Volt Tech.

Accel Black	Accel Alloy	Accel Chrome	Volt Tech Black	Volt Tech Chrome	Dome Chrome	Replace OEM	Lead	#	Fits	Charging System Type
—	—	—	32-0618	32-1532	—	All 6V	N/A	D	1958-64 XL-XLH-XLCH,	Replaces Mechanical Regulator
32-8064	32-0607	32-0857	32-0619	32-0989	—	All 12V	N/A	D	1965-77 XL-XLH-XLCH	1958-69 FL-FLH replaces Mechanical Regulator
—	—	32-0851	32-0617	—	32-0684	74504-78	5"	A	1977 XLCH, 78-81 XLH-XLCH-XLS 12V Gen.	
—	—	32-0853	32-0620	32-0032	—	74504-82	5"	B	1982-84 XL-XLS-XLX with 12V Gen.,	1982-E84 uses 12V Gen.,
32-8068	—	32-0854	32-7570	32-0782	—	74523-84A		29" C	1984-90 XL 19 Amp. Alt.	
32-8170	—	32-0855	32-9002	32-0798	—	74523-91/92		9" C	1991-93 XL 22 Amp. Alt.	
32-8171	—	32-1856	32-7530	32-0779	—	74523-92A			1992-93 XL	
32-8172	—	32-1857	32-0669	32-0777	—	74523-94		C	1994-03 XL	
—	—	32-1858	32-0811	32-0809	—	74523-04		C	2004-06 XL 22 Amp	
—	—	—	32-0981	32-0982	—	74546-07A		E	2007 XL	
—	—	—	32-0980	32-0984	—	74711-08		E	2009-up XL	



32-0623



32-0621



32-0626

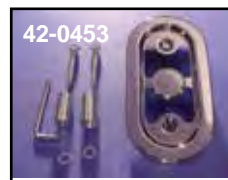

42-0453

**Chrome Voltage Regulator Cover** features open center grill to allow for cooling of regulator. Fits 1985-03 XL. VT No. 42-0453

**Replica Mechanical Regulators** for generator systems. Each unit features heavy duty shock mounted steel bases, vibration resistant internal wire connections, fiber and mylar insulated pads and large diameter contact surfaces.

Black	Chrome	OEM	Brand	Type	Note
—	32-0763		Accel	6V 2 Brush	(A)
32-0623	32-0624	74510-47A	VT	6V 2 Brush	(A)
32-1209			Delco		
32-0626	32-0627	74511-65	Accel	12V Bosch Type	(B)
32-0625	—	74511-65	Bosch	12V Bosch Zinc	(B)
32-0621	32-0622	74510-64	Accel	12V Delco Type	(C)
32-0995	—		Delco	12V Delco	

- A. Fits 1952-65 XLH
- B. Fits 1965-78 XLCH Kick Starter
- C. Fits XLH 1967-78



42-0399



42-0403



42-0442



42-0402



32-0071



32-0067

**"Look-A-Like" Relay** is exact shape and size of earlier 6V relay and will mount the same. Electronic design will function with 2 brush generators.

VT No.	Volt
32-0071	12V
32-0067	6V

### Chrome Regulator Covers

VT No.	Type	Fits	Volt
42-0399	Module	1980-03	12
42-0403	Delco	Large	12
42-0402	Bosch	Center screw	12
42-0442	Delco	3 Brush	6
42-1047	Delco	Black	6



**Solid State Generator Regulator** features die-cast chrome end cover which mounts to all 1965-77, 12 Volt, 2 brush generators. Small solid state regulators fits behind cover for a clean look.

VT No. 32-7757



**Chrome Solid State Regulator Mount** bolts directly to 2 brush generator housings on Big Twin and Sportsters models. Fits Accel and V-Twin finned type regulators.

VT No. 31-0207



31-0170



31-0593

### Rectifier-Regulator Mount.

VT No.	Year	Model	Type	Finish
31-0170	1970-78	XLCH	Stock	Zinc
31-0593	1958-85	Generator Mount Type	Bosch	Chrome



# Distributor



**Unilite Distributor** includes gear. Features 12 volt electronic performance. Dual fire type. No external box required. Electronic ignition module fits inside distributor. Adjustable advance limit, using spring kit pre1970, Use with low resistance coils as low as 2 ohms for greater spark energy. No points to adjust or replace. Use larger spark plug gaps up to .040. Billet aluminum housing. Top may be removed without removal of front cylinder head.

VT No.	Item	Year
32-0174	Accel Distributor XL	1952-70
32-7792	Dyna Coil	3 Ohm



**Chrome Auto Advance Distributors** are completely assembled with gear and all internal parts. The XLH type fits 1952-70 Sportster models and requires **VT No. 31-3966 hold down**.

VT No.	OEM	Years/Model	Type
32-7558	32506-70	1952-70 XLH	Complete
42-0300	32589-65	1965-70	Top Only
31-3966	32515-66	1952-70 XL	Clamp



**Electronic Advance Distributor** with rev limiting for 1952-70 Sportster models. Features adjustable electronic advance curves, single on dual fire modes and CNC machined billet housing. Use with a 3 ohm coil. **VT No. 32-7804**



**Distributor Hold Down Clamp.**  
**VT No. 31-3966**

## 2 Brush Generator Component



**Replica Generator Armatures** feature heavy copper windings on precision shafts with solid copper commutator.

VT No.	OEM	Volt	Fits	Brand
32-0224	30851-65A	12V	1965-80	Accel
32-0226	30851-58	6V	1958-60	VT
32-0222	30851-65A	12V	1965-80	VT



**Replica 2 Brush Field Coils** feature warp-free laminates and heavy copper core winding. Matched pair with lead.

VT No.	OEM	Type	Model
32-0229	30201-58A	58/61	6 Volt
32-7599	30201-65	65	12 Volt



**Generator End Brush Band** for 1966-80 2-brush generators replaces 30475-66 with bolt.

VT No.	Finish
32-0199	Chrome
32-0200	Black



**Generator Mount Gaskets.**  
**VT No. Fits**  
15-0150 1958-69 10 pack  
15-0565 1958-69 Gary Bang, pair



**2-Brush 1958-69 Generator Terminal Kits** include nuts and insulators.  
**VT No. 2127-11**



**2 Brush Generator Hardware Kits** include gaskets and replacement hardware as shown. **VT No. 32-0227**



**Generator Terminal Nuts** replace 7634, on all generators 1930-up, 10 pack.

VT No.	Type
12-0572	Brass
12-0581	Steel with star washer



**Generator Parts.**

VT No.	OEM	Item	Year
32-0217	31035-58	Oil Deflector	1958-81
32-0217	32-0219	32-0219 31067-63 Washer	1958-69



**Brush Sets.**

VT No.	OEM	Fits	Model
32-0234	30426-58	1958-80	2 Brush
32-0231*	29913-82	1981-84	Hitachi

\*Note: V-Twin Replica

## Component

2-Brush Generator Components available separately.

VT No.	OEM	Item
32-0164	30012-58	Bolt (2)
32-0234	30426-58	Brush Set
32-0231	29913-82	Brush Set, Hitachi
12-0581	7634	Terminal Nut
12-2120	30280-58	Pole Screw
32-0209	30350-58	6 Volt Brush Holder
32-0210	30450-66	12 Volt Brush Holder
13-0117	30453-58	Brush Spring, 10 pack
12-0302	9005	Brush End Bearing
12-0303	9007	Gear End Bearing
12-0304	9007	As Above (Open)
10-2553	30148-58	Comm End Cover Bushing

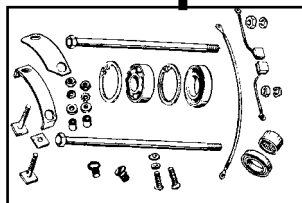

VT No.	OEM	Item
12-0319	9064	End Cover Bearing
12-0902	11004	Front Retaining Ring
14-0112	30145-46A	1958-69 Large Seal

**Generator Rebuild Kit.** Complete as shown, all small parts necessary for rebuilding a 6 or 12 Volt, 2-Brush Generator.

**VT No. 32-0431**

**Hitachi Style Generator Parts** for 1977-E84 models as a high output unit.

VT No.	OEM	Item
N/A	29978-77A	Generator Complete
N/A	29920-82	Armature
N/A	29922-82	Field Coils
10-8542	29907-82	Thrust Washer .004
10-8543	29908-82	Thrust Washer .010
10-8544	29909-82	Thrust Washer .020
10-8545	29910-82	Thrust Washer .039
14-0627	29911-82	Oil Seal
32-0231	29913-82	Brush Set
15-1023	30143-58	Gasket
32-0221	31073-63A	Drive Gear, 14T
42-0522	31599-82	Chrome End Cover





# Generator



32-0790



32-0787

**2-Brush Generators** with built-in regulators by Cycle Electric or Volt Tech brand. All styles fit 1952-81 XL. Order gear kits separately. **VT No.'s 32-9000, 32-0788 and 32-0789** in addition to models noted above will also replace Hitachi generator on 1981-E85 XL models. Order VT No. 32-0983 for gear kit to complete the installation. Units noted as low output for use with VT No. 53-0505 mini 12V battery.

VT No.	Volt	Type	Finish	Brand
32-0212	12V	Low Output	Black	CE
32-0790	12V	Low Output	Black	VT
32-0787	12V	Low Output	Chrome	VT
32-9000	12V	High Output	Black	CE
32-0788	12V	High Output	Black	VT
32-0789	12V	High Output	Chrome	VT
32-9001	6V	Standard	Black	CE
32-0983	XL	Gear Kit 14T		



### Generator Screws.

VT No.	Year	Finish	Type
8877-2	1957-70	Chrome	Stock
8878-2	1957-70	Cadmium	Stock
9757-2	1957-70	Chrome	Allen
7154-2	1971-84	Chrome	Acorn
8787-2	1971-84	Chrome	Allen
9880-2	1971-84	Chrome	Stock
9881-2	1971-84	Zinc	Stock



**Generator Gear Kit** is available as complete installation kit. Kits include gear, deflector nuts and proper pieces for each application. Fits 1959-81. 14 Teeth.

VT No.	Item
32-0983	Kit
32-0221	Gear Only



32-0207



32-0967

**2-Brush Generator** by Cycle Electric or Volt Tech. All styles fit 1952-81. Order gear kit separately.

VT No.	OEM	Volts	Type	Finish
32-8999		12V	VT	Black
32-8998		12V	VT	Chrome
32-7526	29975-65A	12V	CE	Black
32-0967	29975-65A	12V	VT	Black
32-0207	29975-65A	12V	VT	Chrome
32-1530	With gear	12V	VT	Chrome
32-0213	29975-61A	6V	CE	Black
32-0214	29975-61A	6V	VT	Black
32-0983	XL Gear Kit	14 Tooth		



32-0785

**Regulator End Cover** features solid state components in generator end cover. Cover with needle bearing installed black with fins for all 29975-65A 12 volt and 29975-61A generators. **\*Note:** Built in indicator light.

VT No.	Type	Type	Brand
32-7768	12 Volt	Black	CE
32-0795	12 Volt	Black	VT
32-0785	12 Volt	Chrome	VT
32-0969*	12 Volt		VT
32-0970*	12 Volt		VT



**Regulator End Cover** by Cycle Electric to replace the units on their generators VT No. 32-9000 12 Volt High Output, VT No. 32-9001 6 Volt and VT No. 32-0212

32-7762	12 Volt Low Output
32-7758	12 Volt High Output

**Warranty Information**  
Volt Tech Brand Electrical Products Warranty claims are serviced through our Missouri Facility. Cycle Electric warranty claims are returned to Cycle Electric Co in Ohio. Allow extra time for these claims. All electric items will be repaired & replaced at manufacturer's discretion, no credit will be issued for these returns.



# Alternator Conversion Kit



32-0371



32-0372

**Alternator Conversion Kit** replaces original generator and regulator. Compact, high output alternator 3 1/4" long, weighing only 3lbs. Features include high power output, 17 amp@1000RPM, billet housing, for strength and accurate alignment, stress proof shaft which is stronger than stock. Includes alternator unit in chrome or black, black voltage regulator and instructions. Fits 12V 1965-83 XL as well pre 1965 which have been converted to 12V electric, may be used on earlier models if generator bolt holes in case are drilled out to 5/16". Cannot be used with mini (12N55A-3B) battery.

VT No.	Item
32-7528	Complete Kit, Black Alt/Black Reg
32-0390	Complete Kit, Chrome Alt/Black Reg
32-0371	Black Alternator
32-0372	Chrome Alternator
32-0667	Replacement Black Regulator
31-0172	Regulator Mount Bracket



32-0390

Internal View



32-1671



32-1673



32-1674



32-1676

**Alternator Conversion Kit for Sportsters.**

VT No.	Item	Year
32-1671	Black	1971-83
32-1673	Chrome	1958-70
32-1674	Chrome	1971-83
32-1676	Black	1958-70



# 1991-up Starter Motor



**Chrome Starter Assembly** VT No. 32-5127 features built in button for remote starting. Unit has polished aluminum parts and chrome steel parts. Fits 1981-07 XL.  
**VT No. 32-5127**



**High Torque Starter Motor** by Volt Tech are available with 1.4 kw field wound. Stock starter motor is 1.2 kw field wound type. Chrome units have all aluminum parts, polished and all steel parts chrome plated. All units are supplied with jackshaft bolt.



**Push Button Starter End Cap.**  
**VT No. Finish**  
**32-0742** Chrome  
**32-1195** Black



**Chrome Starter Solenoid Plate** replaces 31688-90. Fits 1994-up XL models.  
**VT No. 32-7798**

**VT No. Finish Year**  
**32-5124** Black 1981-up  
**32-5125** Chrome 1981-up

**Stock Black Starter Motor and Parts.**

VT No.	OEM	Fits	Item
<b>32-9072</b>	31390-91B	1991-up XL	Motor complete
<b>32-9075</b>	31546-81	1981-94 883 1981-90 1100 1981-90 1200	Solenoid Assembly
<b>32-9346</b>	31605-90	1981-94 883 1981-90 1200	Solenoid Repair Kit
<b>32-9347</b>	31603-91	1991-up 1200	Solenoid Repair Kit
<b>32-7769</b>	31575-81	1981-90 XL	Brush Set
<b>32-1427</b>		1989-up BT 1981-91 XL	Solenoid Repair Kit

\*Note: Provides 15% greater torque over stock starter motor.



## Starter Motor Cover



**Chrome Generator Covers.**

VT No.	Type	Year
<b>42-0414</b>	2 Brush, End	1958-81
<b>42-0522</b>	Hitachi, End	1982-84
<b>42-0406</b>	2 Brush, Body Wrap	1958-81



**Chrome Starter Covers** completely cover the top of the right side of starter motor. **42-0347** covers the end of starter and solenoid only.

VT No.	Fits	Type
<b>42-0347</b>	1981-90	One Piece
<b>42-0349</b>	1991-2003	Three Piece



**Belt Buckles.**

VT No.	Style
<b>48-1351</b>	Ironhead Motor
<b>48-1512</b>	XL Gas Tank
<b>48-1473</b>	XLH Ironhead
<b>48-1545</b>	XL Points Cover
<b>48-7787</b>	XLCH Sportster
<b>48-1522</b>	Complete Set

XL





# Replica Starter Motor



**Hitachi Type Starters** are replicas for 1974-76, Parts interchange with original, 5" overall body length.

VT No.	OEM	Item
32-7760	31570-73	Complete, Black
32-1307		Complete, Black
32-7761	31570-73	Complete, Chrome
32-0306	31580-73	Armature
32-7769	31575-81	Brush Set, 1981-90 XL only
32-0307	31582-73	Brush Set
32-0308	31579-73	Field Coils
32-0059	31576-73	Thru Bolts
12-0347	31583-73	Bearing, Drive End



**Prestolite Type Starter Motor** replaces Prestolite starter used on 1967-73 XL, 1977-80 XL models. Chromed unit is completely chromed. 6" overall body length.

VT No.	OEM	Item
32-7524	31458-66A	Complete, Chrome
32-7525	31458-66A	Complete, Black
32-1308		Complete, Black
32-0303	31542-66	Armature
32-0680	31540-66	Field Coil Set
32-0592	31535-66	Thru Bolts
12-0325	31539-66	Bearing

**Starter Brush Spring** for Hitachi Starter Motors 1973-up.

VT No.	OEM	Years
13-0223	31593-73	1973-80
13-9157	31557-81	1981-up, Compression
13-9220	31600-90	1990-up, Starter Clutch Assembly

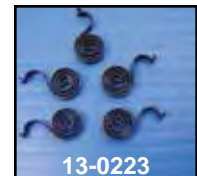

**High Torque Starter Motor** features 1.4 kw design that generates more power and shaft speed than original type .8 kw starter.

## 1.4 KW

VT No.	Finish	Type
32-5122	Black	Hitachi
32-5123	Chrome	Hitachi
32-5120	Black	Prestolite
32-5121	Chrome	Prestolite



**Starter Motor Clamp** Fits 1973-80. Replaces 31473-67 in stainless.  
VT No. 31-0099

**Warranty**  
All Electrical Components sold as individual pieces or in kits are covered under our warranty "Replacement Only" Provision. All electrical related item part numbers begin with a 32 prefix. No credit will be issued for these items as they are exchange only.



**Hitachi Starter Hardware Kit** includes brushes, holder, springs, thru bolts and insulator commutator end bushing for 1973-80.  
VT No. 32-0553

# Starter Relay

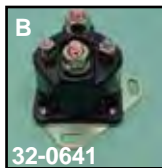

## Starter Relays

VT No.	#	OEM	Fits
32-0640	A	71463-73A	1975-79 XL Accel
32-0641	B	71463-73A	As Above V-Twin, Replica
32-0642	C	31506-79	1980-90 All
32-0738	D	—	As Above with Weather Proof Skirt
32-9076	E	31504-91A	1991-03 All XL
32-0643		71455-67	1967-E68, L71-74 XL
32-0185	F	71455-67	1967-E68
32-0768	G	31601-04	2004-11 XL
32-1160		31586-07	2012-up XL

## Starter Relay Connectors

VT No.	OEM	Fits
32-8036	72046-79C	1979-up All Twins
32-8041	4-lug	1973-78 All Twins when using 1979-90 type starter relay
32-8042	5-lug	As Above

**Note:** 32-8036 includes crimp style connector ends and 32-8041 and 32-8042 includes pigtail harness.



**Start Boost Relay** will reduce 12v voltage drop in single fire ignition applications during cranking will allow full battery voltage to the module and coil.

VT No. 32-3000



**Starter Solenoid** replaces 71469-65 used on 1967-80.

VT No.	Brand	Finish
32-0699	Volt Tech	Zinc
32-0633	Accel	Zinc
32-0632	Accel	Chrome
32-1021	Volt Tech	Chrome



**Starter Solenoid Kit** fits 1967-80. Kit includes chrome or zinc solenoid, outer & inner rubber boot, foam gasket, bolts & spacer.

VT No.	Finish
32-0697	Zinc
32-0698	Chrome

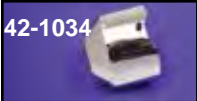

**Chrome Solenoid End Cover.** Order roller boots separately.



VT No.	Item
42-1034	Cover
28-0117	Boot
42-0400	Cover



**Solenoid Plunger Hardware** fits 1967-80 solenoids.

VT No. 32-7571



**Chrome Starter Motor Covers**

VT No.	OEM	Type	Model
42-0413	31565-67	End	Prestolite 1967-80 XL-FL Hitachi 1973-80XL
42-0412	31350-83T	Wrap Long	Prestolite 1966-82 FL 1967-80 XLH
42-0410	31351-83T	Wrap Short	Hitachi 1974-E76 XLH



**Starter Ring Gears** for replacement on stock clutch drums only. Must be welded on. **Note:** Bevel edge is for welding (outside) teeth side.

VT No.	Fits	Teeth
18-3640	1967-80	62T
18-3645	1981-E84	78T
18-3646	1984 <sup>1</sup> / <sub>2</sub> -90	78T
18-3647	1991-up	78T



**Starter Housing.** Order needle bearing separately.

VT No.	Type
43-9132	1967-72 Prestolite
43-9133	1973-78 Hitachi
12-0317	Needle Bearing
15-0152	Gasket



**Starter Block Plate** fits 1970-78 XLCH's also be used on all 1970-78 XLH when starter assembly is removed. Replaces 31460-70.

VT No. 31-0126

# Starter Housing Kit

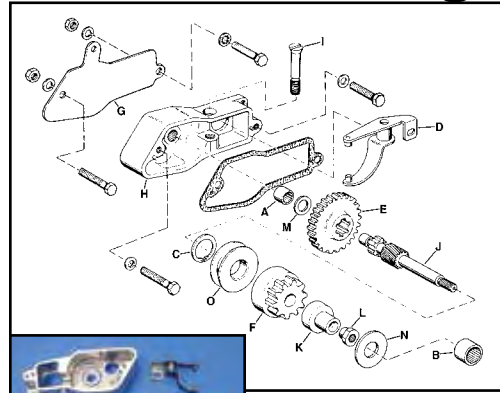

**1967-80 XL**

43-9155

**XLH Starter Parts** listed below fit 1967-80 XLH electric start Sportsters.

VT No.	OEM	#	Item
43-9155	Kit		Includes A, B, C, D, E, F, H, I, J, K, L, M, N, O
	Prestolite		J, K, L, M, N, O
43-9154	Hitachi Kit	As Above	
12-0317	9062	A	Bearing
12-0318	9063	B	Bearing
12-0934	11039	C	Snap Ring
17-1501	31424-67	D	Lever
17-0080	31429-67	E	Gear
32-0639	31443-65A	F	Bendix Drive
31-0126	31460-70	G	Block Off Plate
43-9132	31462-67	H	Housing, Presto
43-9133	31462-74	H	Housing, Hitachi
17-1500	31478-67	I	Bolt
17-0083	31483-67	J	Shaft
17-0082	31490-67	K	Spacer
17-0081	31493-67	L	Nut
17-0093	Kit	L&K	Nut/Spacer
17-1503	31501-65	M	Washer
17-1504	31502-65	N	Washer
17-1502	31503-65	O	Collar
17-1512	Kit		C, K, L, M, N

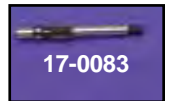

**1967-80 XL Starter Shaft Assembly.** Order starter drive separately. VT No. 17-0243

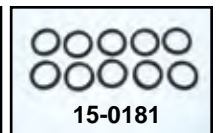
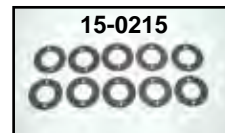
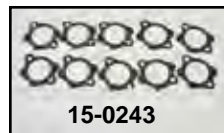

**Starter Gaskets**

GB No.	James	OEM	Fits
15-0151	15-1026	31461-70	1970-E79 XLCH Starter Housing to Primary Mount
15-0152	15-1027	31471-67A	1967-80 Starter Housing to Primary Mount
15-0215	15-1028	31488-77	1967-80 Starter Body to Housing Mount
15-0243	15-1029	31488-81	1981-2000 Starter Mounting
15-0181	15-0917	60645-65	1967-80 Solenoid





# 1967-80 XL Electric Start Kits

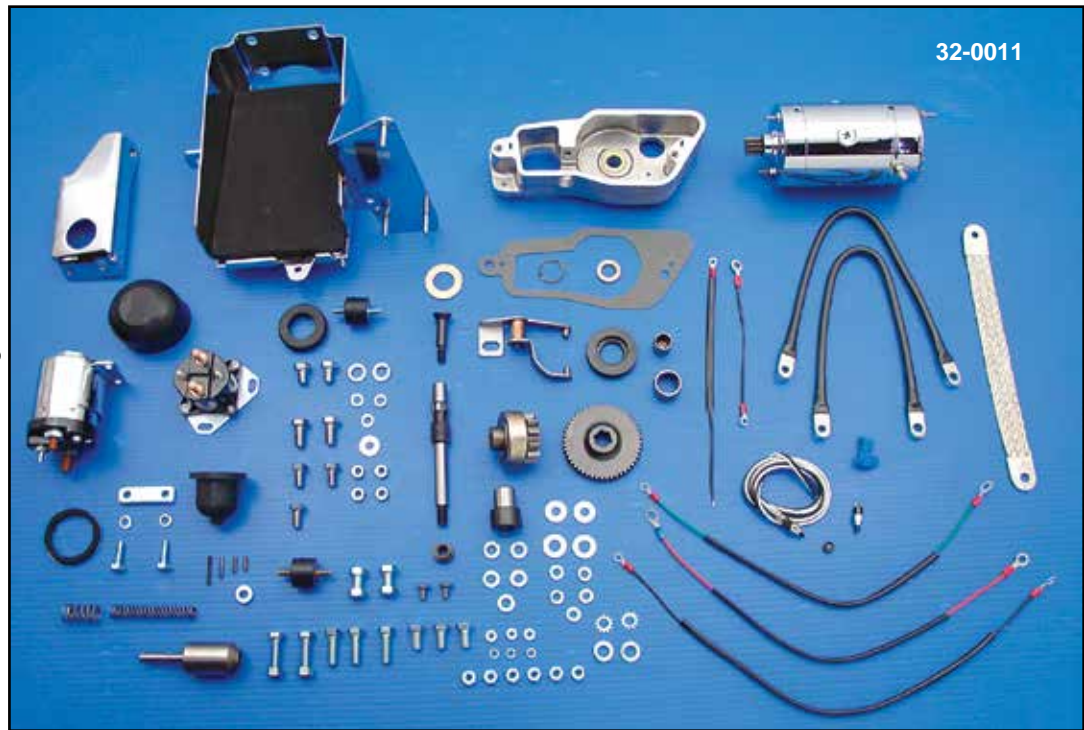

**XLH Electric Start Kits** include parts pictured to fit 1967-80 XL. Your existing clutch drum must have starter ring gear attached. Side mount electric start oil tank 40-0400 must be purchased when fitted to 1971-80 models. Kick and electric start sprocket cover must be used if kick start is to be retained. Battery, top cover and strap not included. Also available with chrome starter motor.

Black	Chrome	Model	Type
32-0002*	32-0010*	Prestolite	1971-78 XLH
32-0003*	32-0011*	Hitachi	1971-78 XLH
32-0006	32-0012	Hitachi	1979-80 XLH

\*Note: Can also be used 1967-70 models but engine cases must be electric start type as kits can be used for replacement only for these years.

## V-Twin Developed Starter Kits for XL in 1981.

**For XLH Electric Start Kits Listed**, these additional parts may be required. **Note:** 28-2217 is rubber strap only.

Year	Battery Side Cover	Sprocket Cover Chrome	Sprocket Cover Polished	Battery Top and Strap
1967-70	42-0509	—	43-0114	42-5514
1971-76	42-0509	43-0180	43-0118	42-5514
1977-78	42-0509	43-0144	43-0112	42-5514
1979	42-0504	43-0177	43-0119	28-2217
1980	42-0503	43-0152	43-0120	28-2217

## Starter Drives



**Starter Clutch Drive Kit** include clutch drive, O-ring, lock tab, seals, spring and cable boot. Fits 1991-up. **VT No. 32-0964**

### Starter Motor Replacement Parts.

VT No.	OEM	Fits
12-9994	8882	1989-90 Commutator End
12-9996	8883	1991-up Commutator End
12-9995	8871	1991-up Gear End
13-9220	31600-90	1991-up Plunger Spring
13-9219	31692-90	1991-up Clutch

**Starter Drive** features high strength five roller clutch, stainless steel springs, hardened ramped clutch receivers, premium bronze bushing and factory pre-lubing.

VT No.	Item	Fits	Brand
32-0638	31443-65A	1967-80 All	Accel Heavy
32-0639	31443-65A	1967-80 All	Volt Tech
32-2506	31443-65A	1967-80 All	Volt Tech Heavy Duty
32-9032*	31567-81	1981-90	OE
32-9031	31663-90	1991-up 1200	With bearing

\*Note: Drive Assemblies



**Barrel Key Ignition Switch** features round style keys. Two position activation with positive detent to retain key in the off position. Fits 1973-94. Run position with lights off.  
**VT No. 32-9053**



**Chrome Stock Key Switch** for ignition and light switch for Sportster, replaces 71425-77 & 70124-75. Includes two keys and mounting ring.

VT No.	Type	Year
32-0161	Replica	1977-98
32-0416	Stock Type	1977-98
32-1099	As Above	Cam Lock
32-0175	Replica	1973-76
32-1100	As Above	Cam Lock
32-1267	Off/On	Start

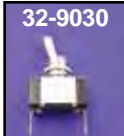

**Universal Toggle Switches.**  
**VT No. Type**  
**32-0423** On/off w/leads  
**32-9030** Spotlamp On/off w/o leads

**Warranty**  
 All Electrical Components sold as individual pieces or in kits are covered under our warranty "Replacement Only" Provision. All electrical related item part numbers begin with a 32 prefix. No credit issued for these items as they are exchange only.



**SHRINK TUBING**

**Shrink Wrap Tubing.** Cut to length, thread the wires, carefully apply heat and watch the insulation shrink to a perfectly fit around the wires. Easy to use.

VT No.	Inner Diameter	Length
32-0124	1/4"	4'
32-0125	3/8"	4'
32-8039	5/8"	4'

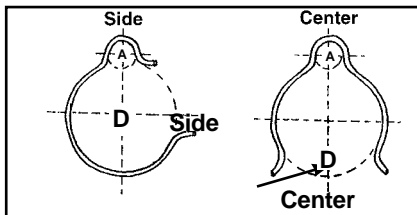

**Control Cable and Wire Clamps** are zinc plated spring steel, packs of 10.

VT No.	D-Tube Size	A-Wire Size	"D" is the diameter of the tube it fits. "A" is the size wire/loom that is secures.
37-8677	1" Side	3/16" - 7/32"	
37-8678	1 1/4" Side	3/16" - 7/32"	
37-8679	1" Center	3/16" - 7/32"	
37-8680	1" Center	5/16"	
37-8681	1 1/8" Center	5/16"	



**Chrome Handlebar Wiring Clips** snap into handlebars with holes at bends, 10 pk.  
**VT No. OEM Size, Inner Diameter**  
**36-0613** 56073-83 3/8"  
**36-0614** 70345-84 1/2"

# Ignition Switches



**Chrome Ignition Switch Cover** fits 1995-up models. Includes decal.  
**VT No. Years**  
**42-0648** 1995-2003  
**42-0935** 2004-2013



**Chrome Switch Cover** fits 1972-87 models.  
**VT No. 42-0330**

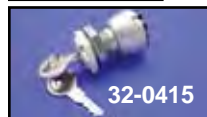

**Universal Key Switch** includes mounting ring and two keys.

VT No.	Type
32-0415	On-Off-On
32-0478	Off-On-Start
32-0479	Off-On-On
32-0420	Off-On-On
32-1236	Lock/Key

# Circuit Breaker

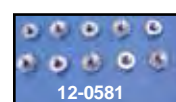
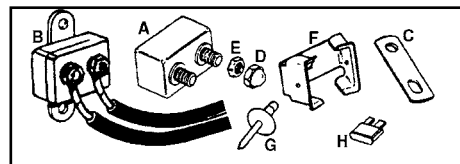

**Circuit Breaker** are stock replacements.

VT No.	#	OEM	Amp	Fits
32-0414	A	74589-73	15	1973-up
32-0413	A	74599-77B	30	1978-up
32-0412	B	74594-71	20	1971-72 XL
32-0436	H	74587-94	15	1994-96
32-9207	A	74600-94	50	1994-up
32-8921	C	74598-73		Connector Bar, each
32-8922		69999-77		Connector Bar, each
32-8945		7/8" C/C		Connector Bar, pair
37-9069	D	7602		Nylon Nut, 10/32", 25 pack,
12-0581	E	7629		Nut, 10 pack
31-9952	F	9952		Mount Clip, 10 pack secures breaker or flasher to fender
31-9964	G	8672		Rivet for Above

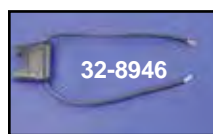

**In-Line Fuse Holder** has 6" long wire leads.  
**VT No. Type**  
**32-0410** Fuse  
**32-8946** ATC Type

XL





# Wiring Harness

**Note: Order the appropriate factory service manual to facilitate wire harness installation.**



**Wiring Kits** feature plastic covered wires. All 1970-99 harness are available as complete "builders kit" with main harness, handlebar, tail lamp and starter wires, or as main harness.

## XLH Electric Start 1970-99.

Complete Kit	Main Harness	OEM	Application
—	<b>32-9206</b>	Starter	1967-80 XLH
<b>32-7617</b>	<b>32-9010</b>	70151-70	1970-72 XLH
<b>32-7618</b>	<b>32-9059</b>	70151-73	1973-74 XLH
<b>32-7619</b>	<b>32-7554</b>	70006-75	1975-76 XLH
<b>32-7620</b>	<b>32-9304</b>	70006-76	1977-Early 1978 XLH
<b>32-7621</b>	<b>32-9209</b>	70006-79	Late 1978-79 XL-XLS
<b>32-7622</b>	<b>32-9210</b>	70006-80	1980 XL-XLS
<b>32-7623</b>	<b>32-9211</b>	70006-81	1981 XL-XLS
<b>32-7624</b>	<b>32-9212</b>	70006-82	1982-E84 XL-XLS
<b>32-7625</b>	<b>32-0721</b>	70135-84	1984-85 XL-XLS
<b>32-7626</b>	<b>32-0722</b>	70135-86	1986-90 XL-XLS
—	<b>32-8929</b>	70135-92A	1992-93 XLH
—	<b>32-8937</b>	70135-97	1997 Standard, Hugger
—	<b>32-8939</b>	70135-98	1998-99 Standard, Hugger

See BT Section.

Taillight Wires.

PVC Covered Taillight Wires 1970-up.

VT No.	Fits
<b>32-9309</b>	1970-72 XL-XLCH
<b>32-9312</b>	1973-77 XL, XLCH, 1982-84 XL
<b>32-9313</b>	1978 XL-XLCH
<b>32-9314</b>	1979-81 XL

Accessory Kits.

VT No.	OEM	Type
<b>32-9206</b>	—	1967-80 XLH
<b>32-0323</b>	70018-77	Small Starter Wire Set, PVC
<b>32-0158</b>	70169-70	Relay to Solenoid Wire
<b>32-0163</b>	70165-58	Relay to Ground Wire
		Battery Box to Ground 1965-69 BT



**Chrome Nylon Tie Straps**, 25 pack.

VT No.	Length
<b>28-0720</b>	4"
<b>28-0721</b>	7"



**Electrical Terminal Plates** are pre-assembled for main junction which includes studs for mounting coil and auxiliary junction for headlamp wiring on 1970-74 XL headlamp. Replaces 72303-70. **VT No. 9817-15**

## XLCH Kickstart 1970-79.

Complete Kit	Main Harness	OEM	Application
<b>32-7610</b>	<b>32-9283</b>	70153-70	1970-E71 XLCH
<b>32-7611</b>	<b>32-7577</b>	70153-71	L1971-72 XLCH
<b>32-7612</b>	<b>32-7578</b>	70153-73	1973-74 XLCH
<b>32-7613</b>	<b>32-0671</b>	70001-75	1975-76 XLCH
<b>32-7614</b>	<b>32-9305</b>	70001-76	1977 XLCH
<b>32-7615</b>	<b>32-7579</b>	70001-78	1978 XLCH
<b>32-7616</b>	<b>32-7580</b>	70001-79	1979 XLCH

## Auxiliary Harness

<b>32-9206</b>	Starter Wire Set	1967-80
----------------	------------------	---------



**1952-69 Wire Harness Kits** feature cloth covered, color coded wire as original.

## XLH Battery Type 1952-67

VT No.	OEM	Application
<b>32-8011</b>	70320-59	1959-64 XLH, 6 Volt
<b>32-7556</b>	70320-65	1965-66 XLH, 12 Volt
<b>32-7557</b>	70320-67	1967 only XLH, Electric Start
<b>32-7559</b>	70320-68	1968-69 XLH, Electric Start

## XLCH Magneto Type 1958-69

VT No.	OEM	Application
<b>32-9057</b>	70320-58	1958-64 XLCH
<b>32-9058</b>	—	1965-69 XLCH

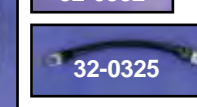
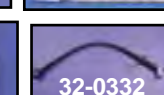
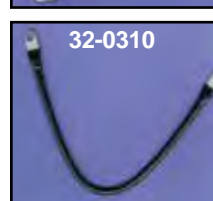

**Battery Cables** are replacements of the originals with heat shielded terminal ends.

VT No.	OEM	Length	Application
<b>Negative</b>			
<b>32-0325</b>	70011-81	8"	1981-85 All XL
<b>32-0311</b>	70097-75A	10¾"	1986-96 XL, Pos. 1975-79 XLH, 1979 XL
<b>32-0324</b>	70235-67A	9"	1967-72 XLH Braided
<b>32-0363</b>	70235-67A	8.5"	1967-72 XLH Braided
<b>32-0312</b>	70295-70	6¾"	1970-78 XLCH
<b>Positive</b>			
<b>32-0315</b>	70083-82A	15¾"	Pos. to Solenoid 1982-88 XL
<b>32-0332</b>	70076-89A	14¾"	Pos. to Solenoid 1989-96 XL
<b>Miscellaneous</b>			
<b>32-0310</b>	70069-65B	15½"	Solenoid to Battery & Starter 1967-75 XLH, 82 XL

## 2 Gauge Cables.

<b>32-2011</b>	11" & 16"	1981-2003 (Set)
<b>32-2012</b>	12" & 13"	2004-up (Set)

## Sealed AGM Battery



- Lock Bonded Plates
- Stainless Steel Terminal Bolts
- Exact fit

**AGM Batteries.** The "Absorbed Glass Mat" Technology provides higher cold cranking amps, better rechargeability with longer overall life. Batteries are fully sealed for trouble free service in a black case. **Note: 1998 and earlier XL models,** require battery side cover, VT No. 42-0770 and a top cover, VT No. 42-0786 for XL's.

VT No.	OEM	Years/Models
53-0547	65991-75C	1977-78 XLCR 1979-96 XL
53-0585	65991-75	1973-84 FXE
53-0789	Dry	1997-2003 XL
53-0548	65958-04	2004-up XL

**Note:** AGM Batteries will require charging before installation.

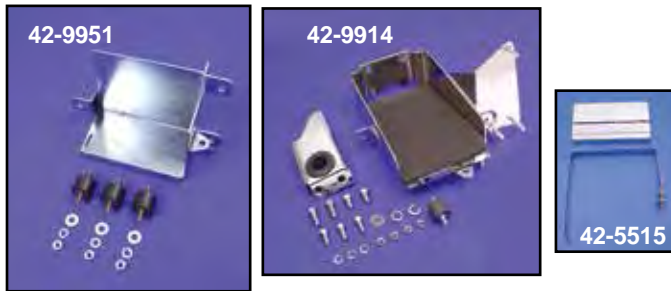

**Battery Carrier Kits** fit stock frames with bracket & Iso-Mounts included as required. All units are chrome plated except where noted. Order battery top cover and strap kit as noted separately.

VT No.	Year	Model	Finish	Cover Kit
42-9951	1970-78	XLCH	Zinc	42-5515
42-9914	1967-78	XLH	Chrome	42-5514
	1994-03	XL	Black	42-5519

\*Note: Use with 1994-2003 XL Oil Tank



**Iso Mounting Rubber Studs.** All types UNC threads 1/4" used on XL battery box and oil tank, 28-0619 used on FX dash.

VT No.	OEM	#	Size	Type	Qty
28-0749	Hex	A-1	1/4"	Male-Male	2
28-0546	62563-65	A	1/4"	Male-Male	5
28-0549	62563-65T	A	1/4"	Male-Male	5
28-0418	w/Spring	A	1/4"	Male-Male	5
28-0636	Lord	A-2	1/4"	Male-Male	2
28-0547	62563-66	B	5/16"	Male-Male	Each
28-0402	62569-94	B	5/16"x 1/4"	XL Oil Tank	Each
28-0619	50235-63	C	5/16"	Male-Female	Each
28-2247	69125-65	D	5/16"	Male-Male, horn	Each

## 12 V Battery

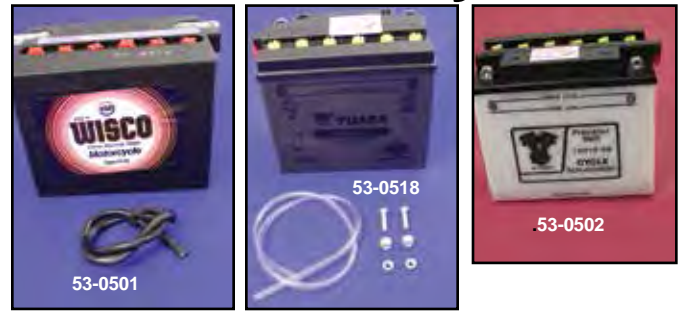

1970-78 XLCH Kickstart models measures 5 <sup>13</sup> / <sub>32</sub> " x 3" x 5 <sup>5</sup> / <sub>16</sub> ".			
53-0504	66006-70	12N7-4A	V-Twin
53-0515	As Above		Yuasa Yumicron
1967-78 XLH with Electric Start measures 8 <sup>1</sup> / <sub>8</sub> " x 5 <sup>1</sup> / <sub>4</sub> " x 6 <sup>1</sup> / <sub>2</sub> ".			
53-0501	66006-65A	H-12	V-Twin
53-0516			Yuasa
53-0532			Champion/Super Crank
1979-96 All XL, 1977-78 XLCR measures 7" x 4" x 6 <sup>1</sup> / <sub>4</sub> ".			
53-0502	65991-75C	12N16-4B	V-Twin, 16 amp
53-0517			Yuasa, Yumicron
53-0518			Yuasa CX 19 amp
1997-03 All XL			
53-0530	65989-97A		V-Twin
2004-up XL			
53-0557	65958-04		V-Twin

All Batteries are dry charged and do not include electrolyte. Electrolyte (battery acid) is available at Tractor Supply stores, nationwide.

Batteries may contain lead, a chemical that is known to cause cancer, or birth defects or other reproductive harm.

**Battery Warranty Information.** The battery is unconditionally guaranteed up to 30 days and pro-rated up to 90 days. No guarantee for cracked or physically damaged cases or terminals at any time. Damage caused in shipping must be reported to us and carrier 24 hours after receipt of shipping. All batteries shipped dry charged.



**Chrome Battery Carrier Bracket** fits 1967-78 XLH. Replaces 66480-67.  
VT No. 31-0130

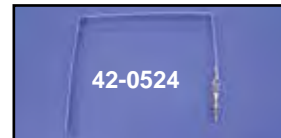

**Replacement Stainless Battery Straps.**

VT No.	OEM	Application
28-2217	66105-77	1979 XL (Rubber)
42-0514	66470-67	1967-78 XLH
42-0515	66470-70	1970-78 XLCH
42-0524	66476-73A	1986-97 XL, XLS, XLX
42-0798	66476-98	1998-2003 XL
42-1211	66476-04A	2004-up XL





# Battery Cover Kits



**2004-up Left Side Battery Cover.**  
**VT No. Type**  
**42-0936** 2004-13 XLH  
**42-1041** 2008-up XR



**Chrome Battery Cover Kit**  
 includes both top and side covers  
 with correct stainless steel strap.  
 Note style of side cover.

VT No.	Year	Model	Style
42-0576	1998-03	XL	Slotted
42-0547	1991-97	XL	Slotted
42-0548	1982-90	XL	Slotted
42-0549	1979 only	XL	Smooth (Rubber)
42-0575	1980-81	XL	Smooth <b>Note:</b> Strap not included
42-0542*	1970-78	XLCH	Slotted
42-0557	1967-78	XLH	Ribbed

**\*Note:** Battery strap not included, top and side cover only



**Battery Top Cover and Strap Kit.** Help save time by ordering the proper cover and hold down strap.

VT No.	Application
42-5514	1967-78 XLH
42-5515	1970-84 XL Kick Only
42-5519	1997-03 XL

**Battery Covers \*Note:** Fits AGM Battery.

Chrome Side	Black Side	Chrome Top	Year/Model
42-0505		42-0512	1970-78 XLCH
42-0509		42-0513	1967-78 XLH
42-0504		42-0511	1979 XLH
42-0503		42-0511	1980-81 XLH
	42-0566		1980-96 XLH
42-0502		42-0511	1982-up XLH
42-0714	42-0567	42-0786	1997-up XLH
42-0770*		42-0786	1998-2003 XLH
42-0936			2004-13 XL
42-0882	42-0569		1997-05 FXD Embossed
42-1164			1997-2005 FXD Embossed
	42-0568		1997-05 FXD

**Chrome XLH & K Battery Top** replaces 66375-52 on 1952-64, 6-volt models.  
**VT No. 42-0732**





**Big Sucker Air Cleaner Assembly** bolts on to 1991-up XL with internal breather bolts included.  
**VT No. 34-0101**

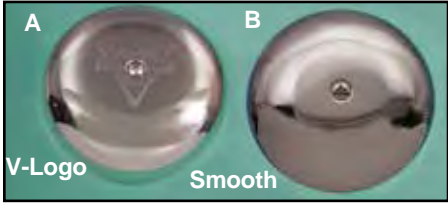

**7" Air Cleaner** with center screw available with cover to fit Bendix, Tillotson, Keihin & CV carburetors, features breather tube, backing plate and foam element, 3" thick.

**Bendix-Keihin CV Type # Item**

- 34-0524 C Eagle Spirit
- 34-0505 A V-Logo
- 34-0547 B Smooth
- 34-0408 Bobber, black
- 34-0554 B 1988-90 XL, with mt brackets
- 34-1032 B 1988-up XL, Ev without mt brackets
- 34-1043 34-1044 Plate Only
- 34-0905 Unifilter foam filter
- 34-0916 V-Twin Foam Filter
- 34-1041 7" Smooth Air Cleaner Cover
- 34-1042 7" V-Logo Air Cleaner Cover
- 9916-2 Mount Kit
- 34-1032 Smooth, chrome
- 34-0406 Smooth, black
- 34-0550 C Cover Only, Eagle Spirit
- 34-0555 A Cover Only, Smooth



**Original Style Oval Chrome Air Cleaner** includes element, cover, screws and backing plate, fits 1965-up Bendix and Keihin carburetors only.

**VT No. Item**

- 34-0526 Complete Assembly, Bendix
- 34-0924 Complete Assembly, Keihin
- 34-0475 Complete Assembly, CV
- 34-0900 Element
- 34-0559 Cover only
- 34-0930 Backing Plate only, Keihin, Bendix
- 34-1248 Filter Element
- 34-1350 Backing Plate only, CV
- 8212-3 Cover Screws, Chrome
- 34-0560 Mount Kit
- 34-0432 Insert Oval, Black



**Tear Drop Deflector** fits Bendix Keihin.  
**VT No. 34-1301**

# Air Cleaner



**New Era Air Cleaners Assembly Kit** includes complete chrome air cleaner, mounting bracket and breather kit to fit stock Keihin carburetors.

Black	Chrome	Fits	Carburetor Type
34-1314	34-0839	1991-up XL	CV Integral/Breather
—	34-0803	1991-up XL	CV External/Breather
—	34-0814	1985-87 XL	Butterfly Keihin External/Breather
—	34-0835	1988-90 XL	Butterfly CV External/Breather
34-0977	34-0977		Element



**Air Cleaners.** New Era, B, C, and Round A styles. Includes cover, element and backing plate. Round type is 7" with center screw. Order the brackets separately.

Bendix Keihin	CV Type	Finish
Pre 1988	1988-up	
34-1008		Chrome Smooth
34-1292	34-1095	Chrome smooth
34-1322	34-1318	Black smooth
34-0977	34-0977	Element only
34-0905	34-0905	Element only fits 34-0904
	34-0937	Screen



**Teardrop Air Cleaner Kits** include chrome air cleaner assembly with smooth, finned or flame teardrop cover, chrome mount bracket and a breather kit with a black hose and breather unit or bracket only as required.

Finned	Smooth	Flame	Year
34-1701	34-1700	34-1702	1991-up
34-0665	34-0658	34-0652	1991-up
34-0881	34-0882	34-0883	1988-90
34-0688	34-0689	34-0690	1985-87
34-0685	34-0686	34-0687	1957-84

**VT No. Item**  
 34-1464 Performance Air Cleaner





# Air Cleaner



34-1280



34-1066



34-1374



34-1374  
Installed

**Hi-Flow Air Cleaner Kit** fits 1988-up XL models. Cover not included. 34-0190 requires ECM calibration.

VT No.	Item	Brand	Years
34-1077	Kit	OE	1988-2003
34-0734	Kit	K&N	2004-2006
34-1066	Element	OE	1988-2003
34-1187	Element	K&N	2004-2009
34-0559	Cover	VT	1988-2003
34-1280	Cover	VT	2004-up
34-1374	Kit	VT	1988-up

**Complete Maltese Carburetor Cover Kit** includes brackets or breather kit as required. Order filter separately.

VT No.	Fits
34-1141	1991-up
34-1142	1988-90
34-1143	1985-87
34-0608	1967-84
34-0610	S&S E
34-1168	Filter

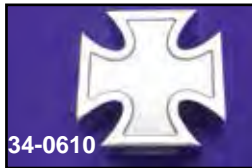

34-0610



**Polished Maltese Air Cleaners** include backing plate as noted. Order filter and brackets separately.

VT No.	Type
34-1168	Filter
34-1112	Cover Only

34-0619

**Air Cleaner Adapter Plate** will adapt any CV style 3-Bolt Air Cleaner to Keihin/Bendix carburetor.

VT No.	Carb Type	Size
34-0619	Bendix/Keihin	38mm



**Siren Air Cleaner Assembly** fits 1991-up XL models. Includes chrome cover, backing plate and mounting hardware.

VT No. 34-1529



35-0007

**S&S Super E Complete Carburetor Kit.** Fits 1979-1985 XL.

VT No. 35-0007

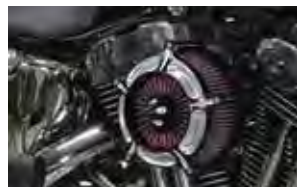

**Wyatt Gatling Air Cleaner** includes a bracket, filter element, breather bolts and hardware. Fits 1991-up XL.

VT No. 34-0491



**Chrome Velocity Stack Kits** include 2.5" chrome stack, chrome support bracket and breather kit with black or stainless hose kit as listed for stock Keihin or CV carburetors.

With breather		Fits
Black Hose	SS Hose	
34-1114	34-1124	1991-up
Without breather kit		
34-1119	—	1988-90
34-1120	—	1985-87
34-1126	—	S&S E+G
34-1127	—	4" S&S E+G



**V-Charger™ Chrome Air Cleaner** features air scoop "blower" design with built-in chrome screen and filter. Kits include brackets and/or breather kits as required.

VT No.	Type	Fits
34-0583	CV	1991-up
34-0586	CV	1988-90
34-0589	Keihin	1986-87
34-0588	Keihin-Bendix	1957-85
34-0616	S&S "E"	
34-1178	Filter	All



**Chrome Teardrop Air Cleaner Kit** includes backing plate, filter, breather brackets and teardrop cover.

VT No. 34-0938



34-1046



**Early Style Carburetor Breather Snoots** feature chrome cover without filter. Bendix Keihin & CV is 3 bolt pattern. CV requires use of 35-0121 for 1991-up XL's.

VT No.	Type
34-1046	Bendix-Keihin
34-1081	CV
34-1331	CV Kit
34-0659	Cover Only



34-0831



34-0821

VT No.	Style	Model
34-0668	Sweeper	CV
34-0821	Diamond	CV
34-0831	Skull	CV
34-0826	Diamond	Keihin
34-0837	Diamond	S&S
34-0694	Bracket	91-up XL



34-0668

**Axel's Chrome Billet Air Cleaners** fit to CV carburetors. Order mount kits separately. Bracket listed features built in breather passage and includes bolts for Evolution and TC-88 models.



Spirit  
Chrome



Vented

34-0680



34-0707

**Chrome Air Cleaner Covers** fit S&S carburetor stock backing plate and filter, "bolt on."

Super E	Super B Style	
—	34-0545	Eagle Spirit Chrome
34-0978	—	Smooth (S&S)
34-0707	—	Skull
34-0709	—	Maltese
34-0710	—	Flame



Air Cleaner fits 1988-up.  
VT No. 34-0493



34-1382



34-1374

Oval Air Cleaner Assembly with backing plate, filter and chrome cover.

**Bendix CV Item**

34-1382 34-1374 Assembly

34-0930 34-1350 Backing Plate



34-1374 Installed



**Chrome Smooth Teardrop Air Cleaner**  
fits 1988-up XL.  
VT No. 34-1501

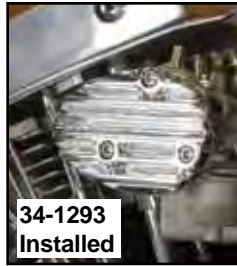

34-1293 Installed

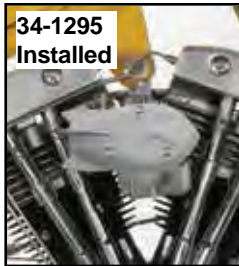

34-1295 Installed



34-1293



34-1295

**Bendix-Keihin Carburetor Cover** is 3 bolt style & made of alloy.

VT No. Style

34-1293 Finned

34-1295 Rocket



34-0512



34-0510

**5 3/4" Chrome Air Cleaners** are for Bendix and Keihin 3 bolt carburetors. Includes foam washable element, 2 1/4" thick.

**Bendix CV Item**

34-0510 34-0762 Drilled

34-0512 34-0763 Smooth

34-0915 34-0915 Element Only



**Chrome S&S Super E & G Air Cleaners** are available as complete units, or replacement covers only. Complete assemblies include backing plate which have built-in brackets to mount to Evolution heads.

VT No. Item/Fits

34-1015 Complete Assembly

34-0981 Chrome Cover All Super 'E'

34-1063 As Above with Notched Cover for 5 Gallon Tanks

34-0984 Uni Filter Super 'E' Foam Type

9980-3 Chrome Allen Screw Set for S&S Covers



**Adapter Plate** allows installation of CV Air Cleaner to S&S E carburetors and vertical or horizontal mounting of 34-0670 tapered cone air cleaner.

VT No. 34-0673

# Air Cleaner



34-0557



34-0558



34-0634



34-0987



34-0634 Installed



34-0641 Installed

**Air Cleaner Inserts** fit recessed area of round center screw type units.

Chrome	Gold Inlay	Fits
34-0557	—	Evolution 8"
—	34-0558	Evolution 8"
34-0986	34-0987	Oval
34-0641	34-0634	2004-up

\*Note: Full outer cover replaces stock 8" type. Does not have lower cut out for Late 1989-up applications.



34-0501

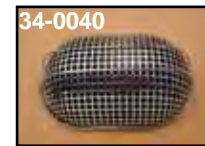

34-0040



34-0506



34-0732



34-0746



34-0501 Installed

**Air Cleaners** include element.

Chrome	Black	Fits
34-0501	34-1325	Bendix-Keihin, Round
34-0733	—	S&S "E"
34-0040	34-1370	Bendix-Keihin, Turbo Oval
34-0078	34-0078	Filter Only Above
34-0506	—	Bendix-Keihin, Flat with Mesh

**CV Type**

34-0746 34-0764 CV Turbo

34-0732 34-0742 CV Round

34-0079 34-0079 Filter Only for Above

34-0906 Foam Element for VT No. 34-0506 type

34-0711 Foam Element for VT No. 34-0501, 34-0733 type



34-0906



34-1354



34-1355



34-1379



34-1380

**Air Cleaner Cover Only.**

Chrome	Black	Diameter
34-1354	34-1355	8"
34-1379	34-1380	7"



**Chrome Wyatt Gatling Air Cleaner Assembly.** Fits 1991-up XL.  
VT No. 34-0473





# Teardrop/Round Air Cleaner

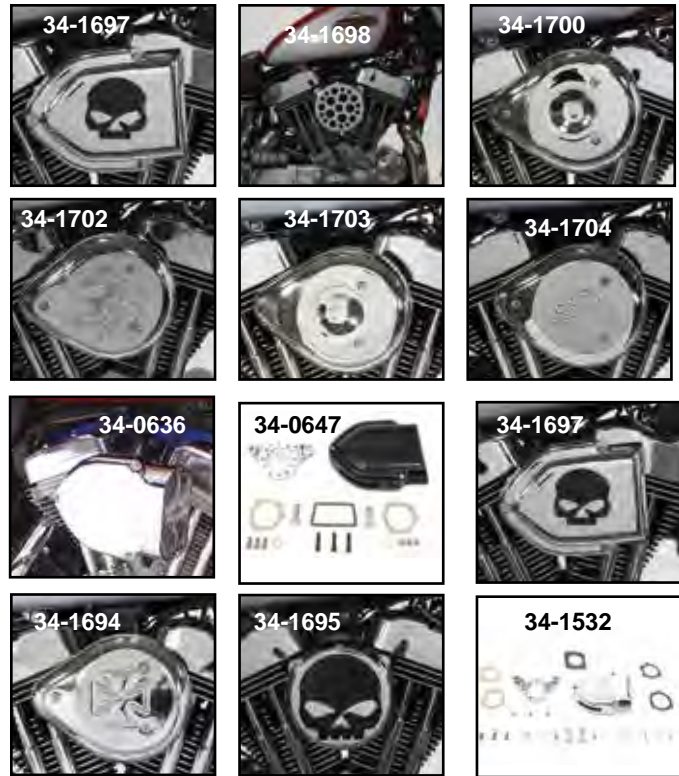
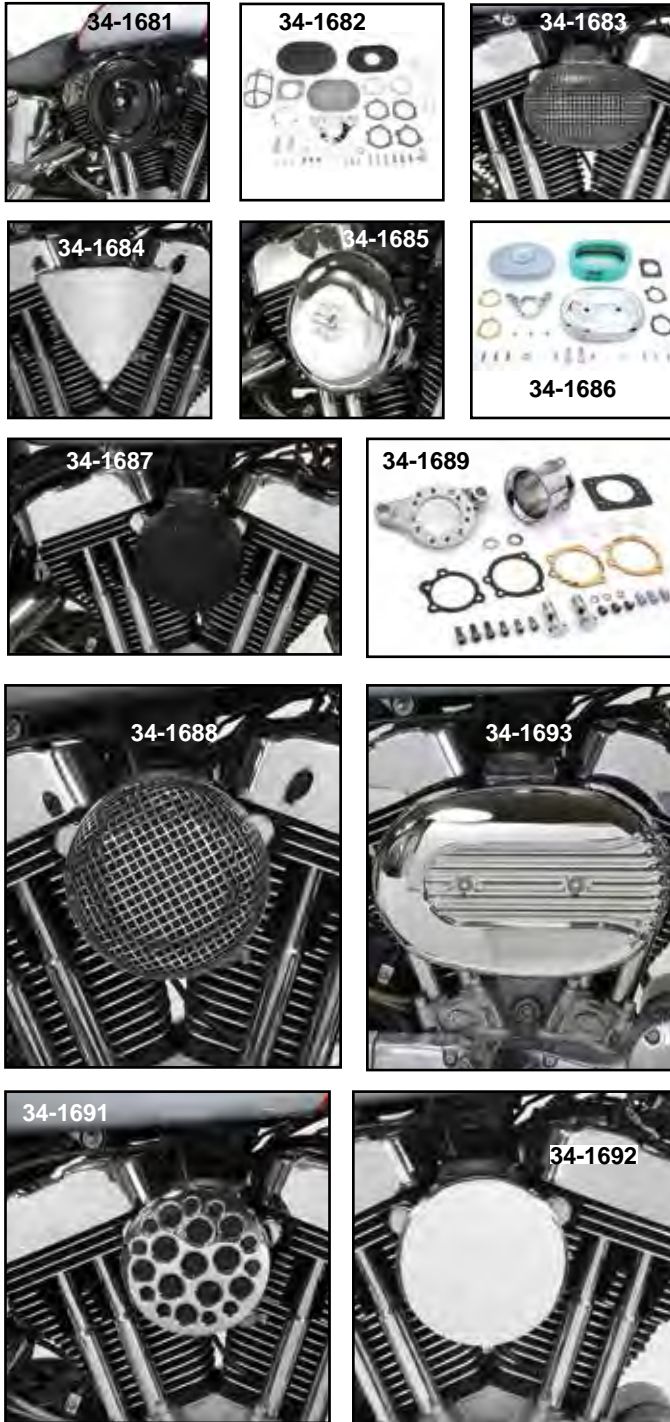

**Wyatt Gatling Air Cleaner Assemblies** includes integral breather system with bracket, mounting kit and air cleaner. Includes air filter element. DIY easy install bolt-on assembly has no hoses to connect! Fit 1991-up XL.

VT No.	w/Air Cleaner	Shape	Style
34-1681	34-0406	Round	Black, 7"
34-1859		Round	Chrome
34-1860		Round	
34-1861		Round	
34-1709		Round	Chrome, 7"
34-1846		Round	Chrome, Smooth
34-1706		Round	Chrome
34-1682	34-0764	Oval	Black, Mesh
34-1683	34-0746	Oval	Chrome, Mesh
34-1684	34-1206	Diamond	Billet
34-1849		Diamond	Chrome
34-1850		Diamond	Chrome
34-1685	34-1373	Round	Chrome, 7"
34-1686	34-0475	Oval	Chrome
34-1687	34-0742	Round	Black, Mesh
34-1688	34-0732	Round	Chrome, Mesh
34-1689*	34-1119	Velocity Stack	Chrome
34-1691	34-0762	Round	Chrome, Drilled
34-1692	34-0763	Round	Chrome, Baby Moon
34-1693	34-1374	Oval	Chrome, Late Style
34-1694	34-0628	Teardrop	Chrome, Maltese
34-1695	34-1735	Round	Chrome, Skull Mesh
34-1698	34-1742	Round	Chrome, Hole Pattern
34-1699*	34-1081	Breather Snoot	Chrome
34-1700	34-1022	Teardrop	Chrome, Smooth
34-1701	34-0530	Teardrop	Chrome, Finner
34-1702	34-0511	Teardrop	Chrome, Flame
34-1703	34-0630	Teardrop	Chrome, Slotted
34-1704	34-0629	Teardrop	Chrome, Skull
34-1705	34-1020	Teardrop	Chrome, Live to Ride
34-0636	34-0620	WG Chrome	
34-0647	34-1430	WG Black	
34-1697	34-1429	WG Skull	
34-1532	34-1129	WG Skull	
34-1366	34-1334	WG Inverted	
34-0636		WG Smooth	
34-0647		WG Black Smooth	
34-1244		WG Skull	
34-1847		WG Swiss Cheese	
34-1845		WG Skull	
34-1707		Skull	Chrome
34-1708		Skull	Black
34-1857		Scoop	Chrome
34-1848		Sweeper	Chrome
34-1856		Dish	Chrome

\*Note: Does not require filter element



# Replica™ Air Filters



**Washable Paper Air Filters** feature original shape and styling for exact fit.

VT No.	Fits	VT No.	Fits
34-0934	1988-2001 XL	34-1298	Eagle Round
34-0935	S&S "B"	34-1066	Oblong
34-1176	S&S, "E" and "G"	34-1248	1973-76 XL
34-0948	Tapered, Velo Type	34-1334	Inverted Type
34-1067	Sifton Air Power™	34-0734	K&N
34-0959	2004-13 XL	34-0277	Mount Set
34-0064	2014-up XL, filter		
34-1040	Screamin' Eagle Round		

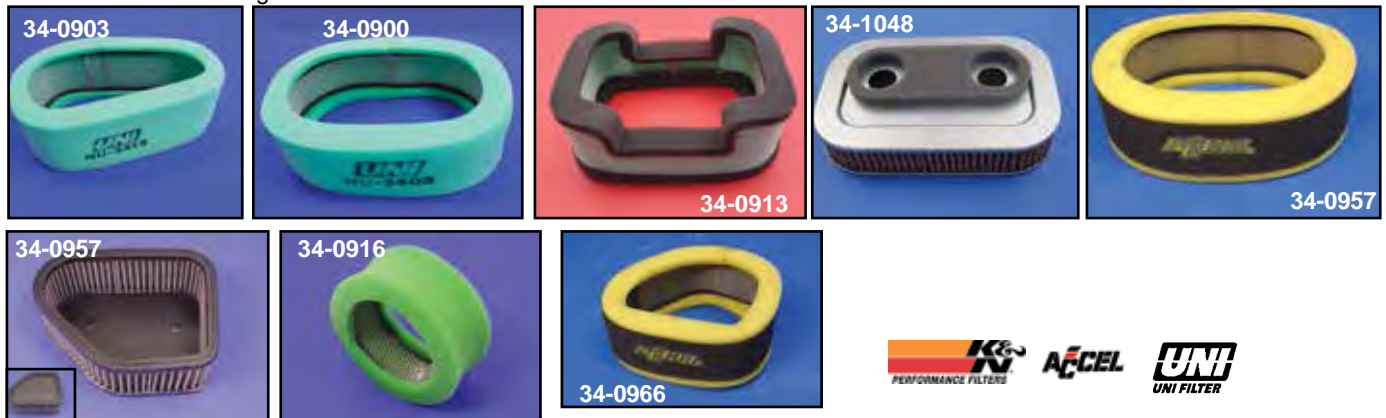

**Air Filters** are available in 4 types, K&N paper, Uni Filter foam, Accel 2-stage foam and V-Twin foam.

K & N	Accel	Uni Foam	Fits	For Aftermarket Models			
34-1329	—	—	2014-up XL	34-0960	34-0975	34-0905	S&S Super "B"
34-1191	—	—	2004-13 XL	—	—	34-0916	S&S Super "B" (VTwin)
34-1048	—	34-0913*	1988-2003 XL				Round Style
34-0957	34-0966	34-0909	1986-87 XL	34-1010	—	34-0984	S & S Super "E" & "G"
34-0951	—	34-0900	1983-85 1000	—	—	34-0906	34-0506, 34-0508
34-0954	34-0970	34-0903	1979-82 1000	—	—	34-0915	34-0510
34-0953	—	34-0902	L1975-78 1000	—	—	34-0977	New Era
34-0952	34-0967	34-0901	L1973-E75 1000	34-1009	—	—	Mikuni HSR-40 smoothbore
34-1248	—	—	1968-75 FL, FX	34-1078	—	—	Mikuni HSR 42/45 smoothbore
34-0951	—	34-0900	1967-75 900/1000	34-1070	—	—	Hyper Charger
				34-1187	—	—	Screamin' Eagle 2004-up

## Air Cover Screws



**Air Cleaner Cover Allen Mounting Kit.**  
VT No. 9916-2



**S&S Chrome Air Cleaner Cover** countersunk allen screws mount cover on S&S air cleaners. Three screws per kit. VT No. 9980-3



**Chrome Air Cleaner Screws.**

VT No.	#	Size	Style	U/M
37-8556	B	1/4 - 20	S&S	3 pack
8212-3	C	5/16 - 24	Early Stock	Kit
7206-2	A	5/16 - 24	1957-77 Acorn	2 pack
8461-2			As Above Cap	2 pack
7806-3	A	5/16 - 18	1978-84 Acorn	3 pack
9916-2	B	5/16 - 18	Chrome Flat Allen	Kit
37-2096	C	5/16 - 24	Early Stock	4 pack
37-8750		8mm - 5/8		4 pack

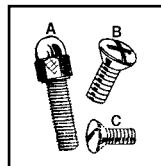

XL





# Breather and Bracket Kit



V-Charger Air Cleaner Units Only include element. Order brackets and breather kits as required.

Chrome	Black	Style
34-0638		Smooth
34-1429	34-1456	Raised Skull
34-0620		Smooth
34-1303		Engraved Skull
34-1070	34-1070	Air Filter



**6" Moon Air Cleaners**  
**VT No. Fits**  
**34-0481** CV Backing Plate  
**34-0283** Air Cleaner Kit, Keihin

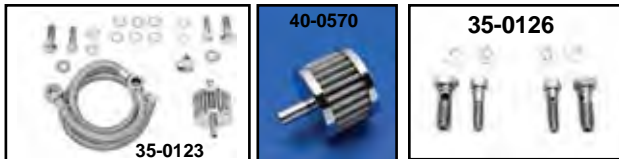

**Sifton Braided Hose Crankcase Breather Kit** features 3/8" inner diameter stainless steel braided hose attached. Includes breather filter (with mounting stud), 24" hose, hardware and instructions. Air cleaner and carburetor support bracket must be purchased separately. Fits 1991-up XL custom applications only.

VT No.	Item
35-0123	Kit
40-0570	Breather
35-0126	Bolt Kit
31-0751	Support Bracket

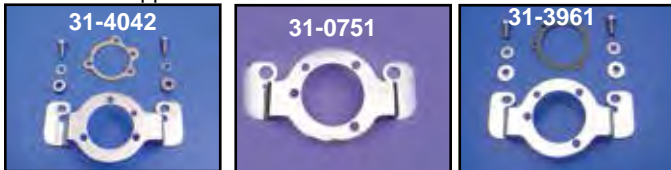

**Chrome Air Cleaner Bracket** for Evolution mounts to boss on engine heads to support custom air cleaners.

VT No.	Year
31-4042	1985-87
31-3961	1988-90
31-0751*	1991-up

\*Note: To be used w/breather kit or 40-0453 breather buttons. **Air Cleaner Adapter Ring** adapts Linkert 4 bolt air cleaner to CV carbs.

**VT No. 34-1302**



**34-1281 Installed**



**Hi-Flow Air Cleaner Back Plate Kit** includes filter and brackets with integral breather passages.

VT No.	Size	Cover
34-1257	7"	No
34-1281	8"	Yes

976



**Teardrop Air Cleaners.** Order appropriate bracket set separately.

1987 and earlier

VT No.	Style
34-0532	Eagle Spirit, Bendix Keihin type
34-0544	Eagle Spirit Gold
34-0516	Smooth
34-0515	Smooth Polished
34-0520	Smooth Stee3
34-0528	Finned
34-0631	Slotted
34-0527	Smooth with Flames

1988-up, CV Type

34-1020	Eagle Spirit
34-1022	Smooth
34-0511	Flames
34-0530	Finned
34-0630	Slotted
34-0628	Maltese
34-0629	Skull
34-0560	Screws

**Individual Parts For Units**

34-0517	Polished Cover only
34-0518	Chrome Cover only
34-0519	Bendix Keihin Backing Plate
34-1054	CV Back Plate only, Alloy
34-1080	CV Back Plate only, Steel
34-1389	CV Back Plate only, Chrome
37-8556	Chrome 3 piece screw kit
34-0545	Eagle Spirit Chrome Cover
34-0905	Uni-filter Element
34-0916	Foam Filter Element
34-0434	Backing Plate

**Brackets For Teardrop Air Cleaners.**

34-0201	1957-85 XL
31-3941	1985-90 XL Evolution
31-0431	1991-up XL Evolution

## Air Cleaner Brackets

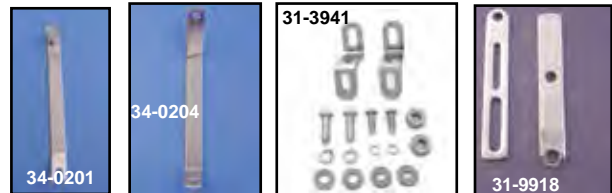

**Chrome Air Cleaner Support Brackets** are used for installing custom round or teardrop air cleaners.

VT No.	Fits
34-0204	1966-85 S&S XL
34-0201	1957-85 Sportster
31-3941	1985-90 Evolution XL

**Air Cleaner Support Brackets** fit S&S 1 7/8" Super 'B' carburetors.

VT No.	Fits
34-0204	1975-85 XL's
31-9918	All Adjustable type



**Carburetor Support Bracket** replaces 27433-57. Zinc plated. Fits 1957-67.

**VT No. 31-0463**

**Air Cleaner Mount Gaskets, 10 pack.**

James	VT No.	OEM	Years
15-1146	15-0148	29058-77	1977-89
15-1016	—	As Above	.062 thick
15-1017	15-0285	29059-88	1988-up CV type
15-1147	—	As Above	Steel Core
15-1148	—	As Above	Adhesive Coated
15-0596	—	29095-95	1995-00 EFI
—	15-1527	28583-01A	01-up EFI
15-1199	—	29062-95B	1995-up Carb
15-1149	—	29313-95	1995-up Air Cleaner

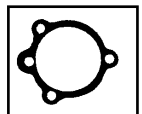

15-0285



# Breather Sets for 1991-up XL's

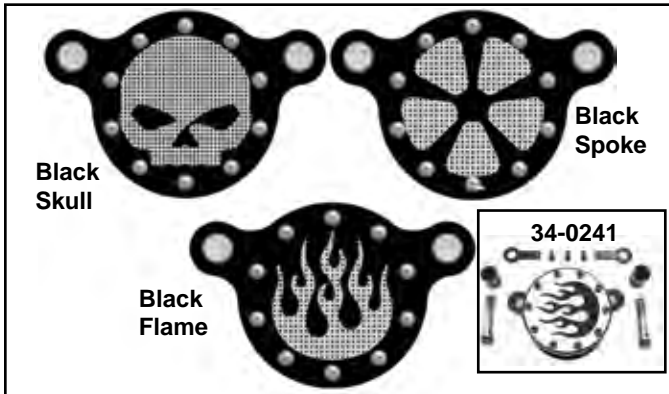

**Wyatt Gatling Billet Air Cleaner Kits** for 1991-up XL CV models.

**Black Chrome**  
**34-0239 34-0248** Spoke  
**34-0240 34-0249** Skull  
**34-0241 34-0250** Flame

**Skull Style Air Cleaner Intake Kit** fits both carbureted and fuel injected models. Fits 2004-up XL.  
**VT No. 34-1671**

**2007-2015 XL Air Cleaner Mount Kit.**  
**VT No. 34-0468**



**Billet Air Cleaner Mount Set** will mount air cleaners with flat backing plates to Evolution and

TC-88 models. Offset Billet mounts feature built in breather passage that feeds inside air cleaner housing. Brackets can be rotated to proper position, then by drilling the back plate. Threaded breather nipples will fasten back plate to brackets. Fits 1991-up XL.

**VT No. 34-0750**



**Sifton Dual Breather Kit** includes 2 canisters and banjo tubes with hardware for 1991-up XL.  
**VT No. 40-0451**



**Chrome Billet Canister Set** includes bolts for 1991-up XL applications.  
**VT No. 40-0346**



**Chrome Vented Breather Canister** accepts 5/16" or 3/8" hose.  
**VT No. 40-0457**



**Sifton Mini-Breather Bolt Kit.** Unique chrome breather cups have built in mount bolt. Use with carburetor mount bracket 31-0751 on 1991-up models.  
**VT No. 40-0453**



**40-0449**

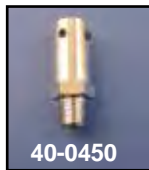

**40-0450**

**Sifton Breather Canister** features enclosed breather filter and tube for attaching to breather cross over lines, which is held in place by set screws. Bottom cover is removable for cleaning for 1991-up.

<b>VT No.</b>	<b>Item</b>
<b>40-0446</b>	Canister
<b>40-0449</b>	Breather Tube Kit
<b>40-0450</b>	Tube Only



**Sifton Dual Vent Kit** includes 2 vent canisters, banjo bolts for 1991-up with necessary fittings.  
**VT No. Item**  
**35-0441** Kit  
**35-0126** Bolt Kit



**XL Billet Chrome Integral Breather/Carburetor Mount Bracket** includes mount bolts for installation of any 3 bolt CV type air cleaner or velocity stack to be installed in vertical or horizontal position.

**VT No. Year**  
**34-0694** 1991-up  
**35-0791** Bolt Set

**This is the Best Bracket to use, Easy and Secure Mounting!**

## No Hoses Required!



**Air Cleaner Breather Manifold Kits** for fit custom air cleaners to motors with the internal breathing system. Kit includes chrome breather manifold, chrome banjo bolts, chrome air cleaner support brackets, gaskets and instructions. Fits 1991-up air cleaner noted.

<b>VT No. OEM</b>	<b>Air Cleaner</b>
<b>31-0431</b>	29281-91T Teardrop
<b>35-0671</b>	Tube Only



**Crankcase Breather and Bracket Kit** fits CV Carburetors to allow use of aftermarket air cleaners on models with cylinder head/crankcase breather systems. Order air cleaner separately. Fits 1991-up XL.  
**VT No. 35-0121**



**Sifton Dual Breather Kit** includes 2 canisters, banjo tubes and bolts for 1991-up XL.  
**VT No. 40-0436**



**Sifton Dual Canister Set** includes hardware for 1991-up XL.  
**VT No. 40-0452**

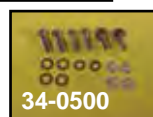

**Breather Bolt and Banjo Kit** includes bolts for XL applications and 2 banjos to accept 5/16" hose.

<b>VT No. Item</b>
<b>34-0500</b> Without tee
<b>34-0808</b> With tee
<b>37-0985</b> Evolution Nylon Washers
<b>37-0986</b> TC-88 Nylon Washers





# Intake Manifolds



35-0085



35-0084



35-9188



35-9195



35-8021



35-0161



35-8033

**Stock Intake Manifolds** for XL's are of cast alloy as original.

VT No.	OEM	Fits	Type
35-0085	27021-71A	1966-77	O-Ring
35-0084	27021-78	1978-84	Flat Seal
35-9188	27004-88A	1988-03	Spigot
35-9195	27024-04	2004-06	Spigot

**Manifold Spacer** replaces 29250-78 on 1971-88 models.  $\frac{3}{8}$ " thick.

VT No.	Item
15-0141	Stock Spacer, each
15-1019	As Above, James
15-0142	Gaskets, Non-beaded
15-1144	Gaskets, Beaded
15-1019	Spacer Kit, James ( $\frac{1}{4}$ " inner diameter) Stock
15-1162	Spacer Kit, James ( $\frac{1}{16}$ " inner diameter) Custom



15-0142



35-9150

**CV Carburetor Adapter** adapts HSR-42 Mikuni or CV carburetor to 2 bolt manifold. Use spigot seal VT No. 14-0180.

**VT No. 35-9150**



35-9136



35-0117



35-0194

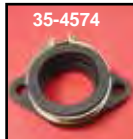

35-4574



35-9162



35-9340



35-9341



35-0098

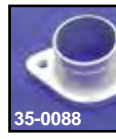

35-0088

**Carburetor Adapters.**

VT No.	Size (mm)	Type
35-9136	30-45	Spigot Rubber
35-0117	42-42	Spigot Rubber
35-0194	44-44	Spigot Rubber
35-4574	36-38	Flange Adapter
35-9162	40	Flange Adapter
35-9340	42	Flange Adapter
35-9341	46	Flange Adapter
35-0098	38	2 Bolt Adapter w/rubber
35-0088	38	Flange



35-0101



35-0102

**S&S Manifolds** are replacements for all S&S  $\frac{1}{8}$ " Super carburetors or can be used as stock replacements.

VT No.	Type	Model
35-0101	O-Ring	1957-77 models
35-0109	As Above	With .200 longer cylinder
35-0102	Flat Seal	1978-84
35-9184	As Above	With .200 longer cylinder
35-8021	Flat Seal	1986-up XL Evolution

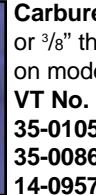

**Carburetor Spacers** for S&S are available in 1" or  $\frac{3}{8}$ " thickness for spacing out  $1\frac{1}{8}$ " carburetors on models with 5 gallon tanks.

VT No.	Size
35-0105	1"
35-0086	$\frac{3}{8}$ "
14-0957	Super 'E' Carburetor Base, O-Ring



**Intake Manifold Chrome Allen Mount Screws.**

VT No.	Year	Model
9932-8-P	As Above	Polished
9933-12	1986-87	XL
9933-12-P	As Above	Polished



35-0411

**1966-77 Intake Manifold Rings** use to update early style O-Ring intake manifolds or cylinder heads to late style flat band type seals. Available for stock or stroker .200 taller cylinders. Set includes 4 standard and 2 stroker rings.

VT No.	Type	Qty
35-0411	Adapter Rings, Stock	10
35-0412	Stroker Rings	10
35-0429	Set	

## For EFI



**Chrome Manifold Cover** fits 2007-up XL.

VT No.	Item
34-0100	Kit
15-1527	Gasket



35-0408



35-9177



35-0410



35-0418

# Intake Clamps



**V-Twin's 360° Power Intake Clamp** is full stainless steel which features a "floating bridge." Closes the gap under the "T" bolt for total 360° wrap around seal. The best available sold as a set with O-Rings or seals.

**Stock Style Intake Clamp Sets** include O-ring or seals for proper year, feature fillister or allen screws as factory. Available in chrome or stainless.

VT No.	Year	Finish	Screw
35-0408	1955-77	Chrome	Allen
35-9177	1955-77	Stainless	Fillister
35-0410	1978-84	Chrome	Allen
35-0418	1978-84	Stainless	Fillister

VT No.	Type	U/M
35-0415 35-0449	1955-77	O-Ring Kit
35-0409 35-0448	1978-84	Flat Seal Kit
14-0519	1957-77	O-Rings 10 pack
14-0113	1978-85	Flat Seals 10 pack



35-0406



35-8026



35-0407

**Polished Intake Manifold Clamps** are strong yet easy to install. For Big Twin, 1955-Early78, Sportster 1957-Early78 with O-rings.



35-0193



35-0192

VT No.	Item
35-0407	Clamp Kit
14-0519	O-Rings, 10 pack



**Intake Clamp Update Kit** for 1967-77 models. Kit includes manifold rings, Silicone seals and stainless clamps. Use to update early intakes to late style seals or when intake flanges are damaged on early heads.

**V-Twin Style Intake Clamps** are two piece type polished brass or chrome. Seals included in 1978-84 types.

VT No.	Years	Type	Finish	Note
35-0406	1955-77	O-Ring	Chrome	No Seals
35-8026	1978-84	Flat Seal	Chrome	No Seals
35-0193	1957-77	O-Ring	Brass	Seal
35-0192	1978-84	Flat Seal	Brass	Seal

VT No. 35-0436



**1978-84 Intake Clamp Set** includes 4 pieces of single use clamp, installed by VT No. 16-0050 tool.

VT No. 35-0419

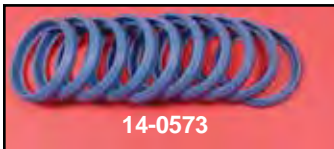

14-0573



14-0924

## Intake Manifold O-Rings and Seals.

James	VT No.	OEM	Type
—	14-0519	27060-55	1955-77, O-Ring
14-0626	14-0113	27062-78	1978-85 Flat Seal
—	14-0924	As Above	Red Silicone
14-0624	14-0165	26995-86A	1986-up
14-0573	—	As Above	Blue Silicone
14-0678	—	As Above	Oversize
14-0689	—	As Above	Rubber with metal element Standard Size
14-0708	—	As Above	Rubber with Extra Thick Metal Insert Standard Size
14-0625*	14-0180*	27002-89	1990-up

\*Note: Seal for carburetor to intake manifold.



**Replica Intake Clamp Set** features fillister head screws, pair.

VT No.	Year	Finish
35-0417	1955-56	Cadmium
35-0439	1957-76	Cadmium
35-0440	1977-84	Zinc

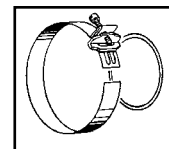





# Bendix Carb Kit

**Bendix Carburetor Kit** fits 1957-85 XL. Kit includes 38mm Bendix Carburetor with adjustable main jet, throttle handle with grips, cable and cable bracket and 7" round logo air cleaner with support. Kit includes seal adapters to use on pre-1978 O-Ring heads. **VT No. 35-0118**



**Adjustable Main Jet Conversion Kit** fits all Bendix carburetors.

**VT No. Item**  
**35-0202** Jet Kit  
**16-0865** Jet Tap  $\frac{9}{32}$ " x 32, Some early carburetors require drilling and tapping for jet installation.



**Bendix Carburetor** has 38mm Venturi and 42mm throat. Complete with choke, accelerator pump, and built-in return spring. This complete unit bolts onto all Big Twins from 1971-75 as stock replacement.

VT No.	MM	Type	Cable	Finish
35-0021	38	Fixed	Single	Cast
35-0060	38	Adjustable	Single	Cast
35-0022	40	Adjustable	Dual	Cast

**Bendix Repair Kit** includes accelerator-pump for all 38 and 40mm, stock or adjustable jet carburetors. Replaces 27132-71.

VT No.	MM	Brand
35-4570	38	Facet
35-0201	38	V-Twin
35-9164	40	Facet

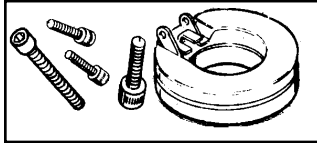

**35-0203**

### Bendix Carburetor Replacement Parts.

VT No.	OEM	Item	Brand/Finish
35-0507	27630-71	Float	Facet
35-4577	27645-71	38mm Float bowl	Facet, Plain
35-9250	—	40mm Float bowl	Facet, Plain
15-0147	27646-71	Bowl gasket	10 pack
35-0203	27762-71A	Pump	V-Twin
35-9132	27389-71	Pump boot	Accel
13-9242	27659-71	Float Pin Spring	10 pack
35-0424	—	Float Needle	38mm
35-0425	—	Float Needle	40mm
35-0533	—	Idle Jet Tube	
12-2557	—	Throttle Stop Screw with Spring	
13-9223	27613-71	Throttle Stop Screw Spring	



### Bendix Main Jets.

VT No.	OEM	Size
35-9143	27651-75	.095
35-9144	27652 75	1.00
35-9145	27653-75	1.05
35-0198	27654-75	1.10
35-9146	27655-75	1.15
35-9147	27656-75	1.20
14-0520	O-Ring	10 pack

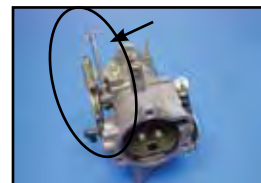

**Idle Adjusting Screw** allows the ease of adjustment with the "T" handle design. A single idle "T" screw is available for Bendix.

**VT No. Finish**  
**35-0221** Stainless Steel  
**35-0931** Brass

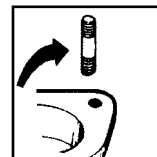

### Carburetor Mount Stud Sets.

VT No.	OEM	Years	Size
12-2099	33298-65	1965-77	$\frac{5}{16}$ - 1 $\frac{1}{2}$
12-2126	24824-67	1967-70	$\frac{3}{8}$ - 2
12-2110	29254-78	1978-89	$\frac{5}{16}$ - 1 $\frac{1}{4}$



**CV Carburetor Rebuild Kit** includes seals, O-Rings, diaphragm and vacuum piston.  
**VT No. 35-0465**



**CV Carburetor Rebuild Kit** for 1989-up models.  
**VT No. Brand**  
**35-0416 GB**  
**35-0422 James**  
**35-0444 Deluxe**



**35-0444**

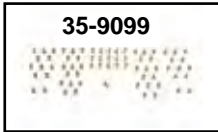

**35-9099**

**CV Carburetor Main Jet Assortment** for all CV carbs and 35-9075 kit.  
**VT No. 35-9099**



**35-9172**



**35-9279**

**Deluxe Carburetor Kits** include all pieces shown for 1976-89 Keihin carburetors.  
**VT No. Type**  
**35-9172 Stock**  
**35-9176 Viton**  
**35-9279 Replica**



**37-9116**

**Keihin Screw Kit** includes chrome screws where required.

VT No.	Years	Type
<b>35-0206</b>	1976-89	Allen
<b>37-9116</b>	CV	Allen
<b>2596-13</b>	CV	Allen
<b>35-0259</b>		Hex

## Dell'Orto



**38 mm Dell'Orto Spigot Carburetor** has an o-ring seal on spigot.  
**VT No. 35-0238**



**DELL'ORTO**

**36-2550**

**Dell'Orto Pumper** features adjustable accelerator pump and choke. Kit includes throttle assembly, cable, grips, air cleaner adapter and carburetor adapter to fit stock two bolt XL manifolds on pre1985 models.

**VT No. Item**  
**35-0030** 38mm Complete Kit  
**35-0031** 40mm Complete Kit  
**36-2550** Replacement Throttle Cable for 38 & 40mm  
**35-0238** 38mm Carburetor Only  
**35-0239** 40mm Carburetor Only

## CV Keihin Rebuild Kits



**35-8029**



**35-8032**



**35-8025**

**Chrome CV Carburetor Top** replaces black plastic cover on 1988-up XL models.

**VT No. Type**  
**35-8025 Smooth**  
**35-8029 Eagle Spirit**  
**35-8032 Ball Milled**  
**35-9107 Perforated**



**35-9107**



**Extended Float Bowl Kit** fits CV carburetors for extra capacity, includes Hi-Flow inlet fitting. **VT No. 35-0135**

**CV Tuners Kit By Kinetic-Karb** is for 1989-99 Keihin constant velocity carburetors to permit easy tuning after installation of custom air cleaners, cams and exhaust. Includes instructions, 3 main jets, needle jet, adjustable needle with spacers and circlips, a spring and drill bits. This dual purpose kit fits 1989 models without accelerator pump 1990-99 with accelerator pump. Jet assortment includes #140-205, 70 piece main jet assortment.

**VT No. Item**  
**35-9075 Kit**  
**35-9099 Jet Assortment**



**35-9075**

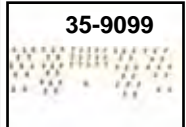

**35-9099**



**35-6102**

**CV Tuner Kits.**

**VT No. Fits**  
**35-6102 1988-03 XL**  
**35-6103 2004-06 XL**



## CV Jet Kits 1988-up models

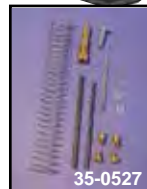

**35-0527**

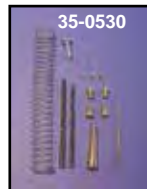

**35-0530**

**DynoJet** for stock carburetors work with mild cams stock or aftermarket exhaust and stock or aftermarket air cleaner.

VT No.	Fits	DynoJet #
<b>35-0527</b>	1989-96 883 w/accelerator pump disabled. Race only.	8703
<b>35-0530</b>	1989-03 1200 XL Thunderslide Kit	8109



**Dell'Orto Pumper Air Cleaner Flat Adapter** allows use of Bendix, air cleaners.  
**VT No. 34-1060**



**Dell'Orto Spigot Carburetor Adapters.** O-Ring seal with steel flange for 38 mm carburetors.  
**VT No. 35-9076**





# 1976-87 Keihin

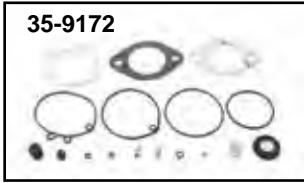

**Deluxe Carburetor Kits** include all pieces shown for 1976-89 Keihin carburetors.

VT No.	Type
35-9172	Stock
35-9176	Viton
35-9279	Replica



**Keihin Carburetor Rebuilds** contains needle, proper o-rings and diaphragm.

VT No.	Year	Brand
35-0200	1976-78	GB
35-0240	1976-86	Keihin
35-0196	1983-89	GB
35-0219	1976-86	James
35-0416	1989-up CV	GB
35-0422	1988-up CV	James
35-0444	1988-up CV	VT



**CV Hot Rod Kit** includes enhancement items and rebuild components.  
VT No. 35-0612



**44mm 2 Bolt Turbulator** turns the intake manifold into a violent mixing chamber. The heavier fuel particles are directed away from the sides of the intake manifold back to the center of air flow. The fixed valve turbulator then tumbles the mixture resulting in higher horsepower.  
VT No. 35-9264



**1967-70 Tillotson Carburetor Gasket and Hardware Kit** includes 27806-66 gasket, 27816-66 diaphragm, two 27689-61 idle and intermediate adjuster screw spring, 27706-66 throttle shaft spring, 27691-66 throttle lever stop screw spring and six diaphragm cover screws.

VT No.	Item
35-0223	Kit
35-0229	Kit with Accelerator Pump, Intermediate Adjuster Screw, Needle and Seat
35-0226	Needle and Seat
35-0224	Intermediate Adjuster Screw
13-9215	Inlet Valve Lever Spring
13-9216	Idle Adjuster Spring
13-9217	Throttle Lever Stop Screw Spring
13-0230	Throttle Shaft Spring
35-0262	Adjustable Jet Kit
35-0225	Pump Assembly Kit



**Enricher for CV Carburetors** will eliminate choke cable. Unit has three positions.  
VT No. 35-0447



**Keihin Low Speed Jets** fit 1976-89 Keihin carburetors, except CV.

VT No.	OEM	MM
35-0297	27896-79	.65
35-0294	27894-78	.68
35-0296	27897-78	.72
35-0295	27382-77	.75
35-0299	27348-77	.88
35-0298	27348-76	1.00



**Keihin Main Jets.**

VT No.	OEM	MM
35-0357	27419-76	1.65
35-0358	27418-76	1.70
35-0359	27417-76	1.75
35-0361	27416-76	1.80

## CV

**CV Main Jets** for Keihin available in packs of 5.

VT No.	Size
35-0451	1.40
35-0452	1.45
35-0453	1.50
35-0454	1.55
35-0375	1.60
35-0376	1.65
35-0377	1.70
35-0378	1.75
35-0334	1.80
35-0379	1.85
35-0335	1.90
35-0336	1.95
35-0337	2.00
35-0455	2.05

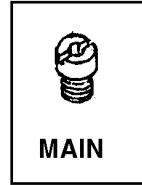

MAIN

**CV Slow Jets**

VT No.	Size
35-0380	.040
35-0381	.042
35-0338	.044
35-0382	.045
35-0339	.046
35-0383	.048
35-0456	.050
35-0457	.052
35-0458	.054

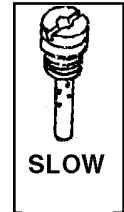

SLOW



**Slow Jet Screw Driver** facilitates removal of Keihin slow jets with no damage to jet. VT No. 16-0546

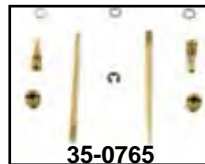

**EZ Quick Tuner Kits** for CV carburetors. Kit includes brass jets and instructions designed for specifically for each model listed. These kits feature no drilling installation and will work on stock to heavily modified engines.

VT No.	Fits
35-0765	1988-03 Sportster 883
35-0760	1988-03 Sportster 1200
35-0761	2004-06 Sportster



**Boyesen Power X-Wing The Power X-Wing** is a cost effective, bolt on upgrade that will eliminate sluggish throttle response. Dyno test shows up to 4 hp and 5 ft lbs of torque gained compliments air filter system upgrades and requires no re-jetting.

VT No.	Type	Fits
35-0904	HSR-42/45	With 1 1/4" ID Adapter
35-0906	HSR 48	With 2" ID Adapter



**Keihin and CV Idle Screw** allows for easier adjustment by hand.  
**VT No. 35-0220**

**VT No. 35-0220 Installed**



**Keihin Carburetor Fitting** replaces 27371-76, 90°, plastic, each.  
**VT No. 40-0534**



**Accelerator Pump Kit** improves throttle response on 1979-88 type Keihin carburetor models with a greater volume of fuel from the pump circuit.  
**VT No. 35-9050**



**High Flow Fuel Inlet** replaces broken fuel inlet to the carburetor bowl for modified motors. Fits all Keihin carburetors (Butterfly and CV) 1976-up XL.  
**VT No. 35-0134**



**Keihin Adjustable Main Jet.** Fully adjustable for maximum tuning efficiency. As pictured.  
**VT No. 35-0369**

# Keihin

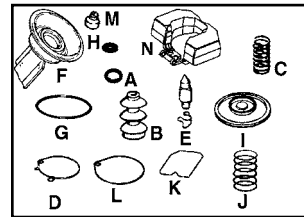

**35-0230**

**Keihin Carburetor Parts and Accessories**

VT No.	#	OEM	Item
14-0921	A	27121-89	Float Valve O-ring 1989-up CV
35-0110	B	27311-76	Pump Cap, 10 pack
14-0566		27312-76	Float Bowl Screw O-ring, 1976-77
13-9234	C	27314-76	Throttle Stop Screw Spring
14-0560	D	27324-83	Float Bowl O-ring 1983-91 CV, 5pk
35-9067	E	27337-76	Float Valve with clip
		27338-76	
35-0230	F	27585-88	Vacuum Piston
14-0559	G	27358-76	Float Bowl O-ring 1976-78
35-9066	I	27361-76	Pump Diaphragm
13-9168		27362-76	Diaphragm Spring
14-0564	K	27577-88	Float Bowl O-ring 1989-91 CV
14-0937	K	27577-92	Float Bowl O-ring 1992-up CV
14-0557	L	27889-78	Float Bowl O-ring 1978-82
14-0679	M	27385-76	Low Speed Jet Plug 1976-up
13-9212		27123-89	Accelerator Rod Spring 1989-up
13-9169		27136-81	Throttle & Idle Adj. Screw Spring, 1981-up
13-9213		27162-89	Vacuum Piston Spring, 1989-up
13-9179		27315-88	Primary Starter Spring, 1988-up
13-9181		27319-76	Low Speed Adjuster Screw Spring, 1981-up
13-9183		27322-76	Throttle Lever Spring, 1981-up
13-9178		27584-88	Primary Vacuum Spring, 1988-up
35-9196	N	27576-92	Float 40 mm CV 1992-up

# Mikuni Carburetor



**Mikuni Carburetor Kits** 38mm for all XL. Includes air cleaner, carburetor, manifold adapter, hose clamps, main and pilot jet assortment and throttle cable. Fits 1957-up.



**Mikuni Carburetor Parts and Information Manual.**  
**VT No. 48-0671**

VT No.	Item
35-0010	Complete Kit
34-0567	Air Cleaner
36-0105	Cable
35-0071	Throttle Handle



**Mikuni HSR 42 Easy Kits.** These kits are designed to work with stock intake manifold, choke cable, air cleaner and throttle cables.

VT No.	Fits
35-9320	1994-2006
35-9115	1971-1985



**Carburetor Rebuild Kit** for Mikuni carburetor includes flow fuel hose, throttle valve seal, float bowl seal o-ring, and carburetor top gasket. Custom application for HSR-42/HSR-45 carburetors. **VT No. 35-0821**

# Jets



**Keihin Low Speed Jets** fit 1976-89 Keihin carburetors, except CV.

VT No.	OEM	MM
35-0297	27896-79	.65
35-0294	27894-78	.68
35-0296	27897-78	.72
35-0295	27382-77	.75
35-0299	27348-77	.88
35-0298	27348-76	1.00



**Keihin Main Jets.**

VT No.	OEM	MM
35-0357	27419-76	1.65
35-0358	27418-76	1.70
35-0359	27417-76	1.75
35-0361	27416-76	1.80

# Jets

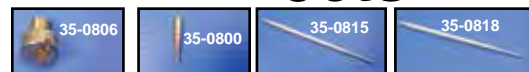

**Mikuni HS and HSR Jets.**

Pilot Jets		Main Jets		Main Jets	
VT No.	Size	VT No.	Size	VT No.	Size
35-0800	22.5	35-0806	150.0	35-0812	165.0
35-0801	25.0	35-0807	152.5	35-0814	170.0
35-0802	27.5	35-0808	155.0		
35-0803	30.0	35-0809	157.5		
—		35-0810	160.0		
35-0805	35.0	35-0811	162.5		
HSR-42 Jet Needles		HSR-45 Jet Needles			
VT No.	Size	VT No.	Size		
35-0815	95	35-0818	95		
35-0816	96	35-0819	96		
35-0817	97	35-0820	97		





# Super 'E' & 'G'

35-0009



Tedd Cycle, Inc.  
original S&S  
Distributor since  
1981!

**S&S 1 7/8 & 2 1/16 Super 'G'** feature adjustable volume pump, enrichment device for ease of starting and a throttle spool assembly designed for late 2 cable operation. Supplied with tear drop air cleaner, mounting bracket and black fuel line. Super 'E' Carburetor is approximately 1 7/16" shorter than the Super 'B' carburetor, making installation length of the Super 'E' the same as stock. The 1 7/8" is for street stock applications, 2 1/16" for big bore and race use. Intake manifold clamps or flanges must be purchased separately when they are required.

1 7/8 'E'	2 1/16 'G'	Fits
35-0005	—	Pre1978 XL
35-0008	35-9207	1986-90 XL Evolution
35-0009	35-9208	1991-03 XL Evolution
35-9368	—	2004-up XL Evolution
—	35-0470	Carburetor only
2596-13	—	Screw Kit
35-0970	—	Float Needle and Seat Set
35-0850	—	S&S Super "E" Rebuild Carb Kit
35-0849	—	90° Elbow Tube
35-0966	—	Accelerator Pump Kit
35-0355	—	Carb Intermediate Jet



**Accelerator Pump Adjusting Screws** allow adjustment of idle and accelerator pumps by these 'T' bar style screws for ease of adjustment.

VT No.	Item
35-0217	T Screw
35-0830	Brass Knurl Screw Set
35-0931	Idle Adjuster Screw Set



35-0830

All Carburetors sold as individual pieces or in kits are covered under our warranty "Replacement Only" Provision. All Carburetor related item part numbers begin with a 35 prefix. No credit will be issued for these items as they are exchange only.



**Sifton Carburetor Hop Up Kit** includes emulsion tube and bomb sight annular booster tube for all S&S E carburetors.

VT No.	Item
35-0133	Kit
35-0026	Idle Mixture Screw

35-0026  
Installed



**S&S Air Cleaner Breather Bolt Kit** for 1993-up Super E & G Air Cleaner Assemblies features two piece breather bolt with rubber coated washers. Fits 1990-up.

VT No. 35-1705



**Throttle Cable Adapter Block** allows use of stock 1996-up throttle cables on S&S E carburetors.

36-0546 Installed VT No. 36-0546



35-0995



35-0287

**Jet Assortment** for S&S Super 'E', 'G' and 'B' carburetors. Complete kit includes 7 intermediate jets from .025" to .033" and a main jet kit only which includes 14 main jets from .062" to .084".

VT No. Kit  
35-0995 Complete  
35-0287 Main Only



1 7/8" "E"  
**Black Carburetor Only**  
VT No. 35-1050



**Sifton Enricher** for S&S, fits Super E&G and B carburetors, includes chrome knob.  
VT No. 35-0466

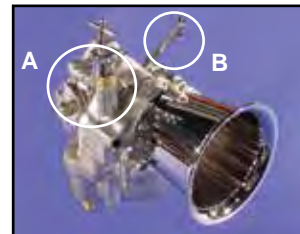

**Chrome Choke Knob** for Super E&G. Allows use of the stock plunger and spring. Kit includes brass plunger nut and chrome knob.

VT No.	#	Item
35-0132	A	Choke Knob
35-0217	B	Idle Screw Set



**Long Float Bowl Screws** fit S&S E carburetors, to facilitate easy removal of bowl.

VT No.	Finish
35-0025	Brass
35-0029	Chrome



**Hi-Flow Air Cleaner Element** fits S&S E Air Cleaners. Kit includes washable 3.5" high filter and mount studs. Mount studs available separately.

VT No.	Item
34-0653	Kit
37-0055	Mount Studs



34-1176



34-0935

**Replica Air Filter Elements** fit S&S models washable.

VT No.	Model
34-1176	E&G
34-0935	B
34-0251	E&G



35-0992

"R" Carburetor has 1 7/8" bore.

VT No.	Item
35-0992	Carb
35-8035	Manifold, BT
35-8033	Manifold, XL



**Air Cleaner Support Brackets** fit S&S Super 'E' and 'G' for 1957-85 XL  
VT No. 34-0337



**ThunderPro ThunderJet** fits S&S 'G' & 'D' Series carburetors. Increases fuel delivery. Black finish.  
VT No. 35-0179



34-0199

**S&S Air Cleaner** for stock carburetors. Chrome plated S&S tear drop air cleaners to fit all Tillotson, Bendix or Keihin carburetors. Complete with cover, backing plate, element and all hardware needed for installation.

VT No.	Fits
34-0199	1966-84



# Throttle Cable Kit



**Throttle & Cable Kits** include grips, throttle and idle. Barnett cable with ends attached for S&S 'E' & 'G' carburetors.

VT No.	Item
35-9246	38" Complete Kit
35-0212	Handle and Grips only

## S&S Super 'E' & 'G' Cables for Dual Stock Type Throttle Handles.

Stainless	Black	Length	Type	Years
36-1504	36-2464	38"	Throttle	81-95
36-1506	36-2466	38"	Idle	81-95
36-1561	36-0744	38"	Throttle	96-up
36-1562	36-0746	38"	Idle	96-up
36-1563	36-2545	42"	Throttle	81-95
36-1564	36-2544	42"	Idle	81-95
36-1565	36-0732	42"	Throttle	96-up
36-1566	36-0734	42"	Idle	96-up



**Chrome Throttle Clamps and Tube Set** feature smooth design, upper and lower pieces with screws and nylon throttle tube, for single or dual cable applications.

VT No.	Type
35-0253	Single
35-0254	Dual



**Chrome Hand Grip Hole Plugs** replace 56238-62 on 1960-up, using stock grips, 10 pk.  
VT No. 28-0618



## Nylon Throttle Tubes.

VT No.	Type	Year
35-9073	Single	1976-81
28-1981	Dual	1982-95
35-9870	Dual	1996-up
35-9871		2008-up



**Throttle Cable Bracket and Clamp** fits 1972-73 XLH, XLCH.  
VT No. 2904-4



**Throttle Kits** available in single or dual units with or without grips and chrome end plugs.

## VT No. Type

35-0215**	Kit with 2 grips
35-0700	Cable Assembly Kit, single
35-0211*	Throttle only
35-9073	Nylon Tube only
35-0210	Adjuster only

\*Note: Includes nylon tube with chrome clamps

\*\*Note: Includes chrome end plug.



## Bendix Carburetor

**Throttle Kit** includes single cable throttle assembly, cable with adjuster and chrome bracket.

VT No. 35-0070

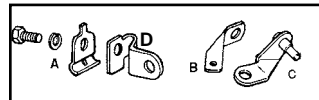

## Carburetor Cable Brackets.

VT No.	#	OEM	Fits/Finish
31-0445	D	27449-92	1972-73 XL Zinc
31-0446	B	27449-66	1966-71 XL Zinc
35-0208	C	27459-74	1974-up XL w/Bendix Chrome
2904-4	A&B		1972-73 XL



**Universal Throttle Sets** feature chrome housing with adjuster, metal twist tube, both use universal cable.

VT No.	#	Item
35-0071	A	1" with Anderson Rubber Grips
35-0232		As Above without Grips
28-0116		Grips for Above
35-0213	B	1" with Plastic Grips and Cable
35-0214	D	7/8" with Plastic Grips and Cable
36-0104		Cable only, barrel end, 48"
36-0112		Cable only, barrel end, 60"
36-2538		Handle Ferule with nut

\*Note: Does not include left side grip order 28-0215.



## Dual 1981-up (Push-Pull)

VT No.	Item
35-0237	Kit with grips
35-0212**	Kit with grips
35-9352**	Kit w/black cables, 1981-89
35-9350	Kit w/black cables
35-9351	1996-up Kit w/black cables
35-9149*	Throttle only
35-9218	All Friction Spring

\*Note: Includes nylon tube with chrome clamps.

\*\*Note: Includes chrome end plugs.



**Chrome Throttle Cable Router** directs cable on Tillotson carburetor.  
VT No. 35-0500



**Throttle Adjusting Kit** includes chrome knob and spring. Fits 1974-up.

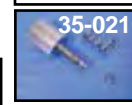

VT No. Item  
35-0210 Adjuster w/Spring  
13-9197 Spring  
12-0980 Retaining Ring

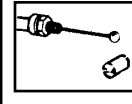

**Keihin Throttle Cable End.** Brass cable fitting end. Replaces 56508-76, 10 pk.  
VT No. 36-2480



**Throttle Thumbwheel Screw** is 1" diameter for throttle return on 1974-up models. Spring included.  
VT No. 35-0372





# Throttle Cable Set

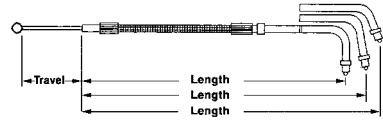

## Throttle/Idle Cables

M&M Cables are constructed with the Supra™ stainless steel braid which is tightly woven for a bright, quality consistent finish. The clear coat is UV resistant, heat bonded, non-yellowing grade for long service life. All applications include the correct fittings, adjuster and inner lengths for an exact installation and fit.

**Stainless Steel Braided Cable Set** by M&M features clear coating for throttle and idle applications.

VT No.	Year	Model	Length
36-0857	1996-98	XL	Stock (35")
36-0856	1990-95	XL	Stock (34")
36-0866	1990-96	XL	+8" (42")
36-0855	1981-89	XL	Stock (38")
36-0827	1999-up	XL	Stock (33")
36-0114	1982-95	S&S	42"
36-0115	1982-95	S&S	54"
36-0857	1996-up	S&S	34.25"
36-0129	1996-up	S&S	38"
36-0128	1996-up	S&S	42.50"
36-0119	1996-up	S&S	47"
36-0131	1996-up	+12"	52"



**Black Matched Stock and Idle Cable Sets** for Big Twins include correct throttle and idle cable assembly.

Stock	+8"	+12"	Years
36-0858	36-0861	—	1996-up
36-0859	36-0862	—	1990-95
36-0860	36-0863	36-2561	1981-89



**Throttle/Idle Cables** are available in black vinyl or braided stainless covering with correct end fitting for each application, also available in over stock length. All are assemblies unless noted.

V-Twin Stainless	V-Twin Black	Barnett Stainless	Barnett Clear Coat	Barnett Black	OEM	Length	Fits
—	—	—	36-1500	36-2460	56389-74	Stock	1974-75
—	36-0107	—	—	36-0107	—	+6" Extension	As Above
—	—	—	36-1501	36-2461	—	+8" Extension	As Above
36-0901	36-0102	—	36-1502	36-2462	56313-76	Stock	1976-80
—	36-0103	—	—	—	—	+6" Extension	As Above
—	36-0357	—	36-1503	36-2463	—	+8" Extension	As Above
—	—	—	—	36-0948	—	+12" Extension	As Above
36-0903	36-0101	—	36-1504	36-2464	56324-81	Stock	1981-85 Throttle Cable
—	36-0357	—	36-1505	36-2465	—	+8" Extension	As Above
—	36-0356	—	—	36-2558	—	+12" Extension	As Above
36-0902	36-0100	36-0635	36-1506	36-2466	56323-81	Stock	As Above Idle Cable
—	—	—	36-1507	36-2467	—	+8" Extension	As Above
—	36-2557	—	—	—	—	+12" Extension	As Above
—	—	—	36-1520	36-2472	56308-86	Stock	1986-87 Throttle Cable
—	—	—	36-1521	36-2473	56309-86	Stock	As Above, Idle Cable
—	—	—	36-1522	36-2490	56308-88	Stock	1988-95 Throttle Cable
—	—	—	36-1523	36-2491	56309-88	Stock	As Above, Idle Cable
—	—	—	36-1524	36-0703	56308-96	Stock	1996-01 Throttle Cable
—	—	—	36-1525	36-0705	56309-96	Stock	As Above, Idle Cable
—	—	—	36-1568	36-0762	56400-96	Stock	2002-up Throttle Cable
—	—	—	36-1569	36-0763	56401-96	Stock	As Above, Idle Cable



## Cable Sets



**Barnett Clear Coat Braided Stainless Throttle Cable Sets** include throttle & idle cable.

VT No.	Year	Model	Length
36-0832	1981-95	S&S Super E.G. Screamin' Eagle	40.125"
36-0829	1996-up	S&S Super E.G. Screamin' Eagle	40.375"
36-0830	1981-95	S&S Super E.G. Screamin' Eagle	45.375"
36-0831	1996-up	S&S Super E.G. Screamin' Eagle	41.50"
36-0832	1981-85	XL	Stock
36-0833	1981-85	As Above	+8"
36-0851	1986-87	XL	Stock
36-0852	1988-95	XL	Stock
36-0853	1996-01	XL	Stock



**Chrome Dual Throttle Cable Separator** is two piece design.  
VT No. 31-9942



**Chrome Throttle Cable Support Bracket.** for all Twins with Bendix carburetor. Replaces 27459-74.  
VT No. 35-0208



**Spiral Chrome Throttle Cable** in stock length. Fits 1976-80 all throttle.  
VT No. 36-0511

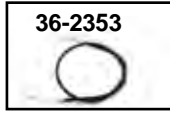

# Clutch Cable

**Clutch Cable Assemblies** feature heavy duty construction designed for reliability and longer service. By V-Twin or Barnett in black vinyl or braided stainless covering.

V-Twin Stainless	V-Twin Black	Barnett Stainless with Clear Coat	Barnett Black	OEM	Length	Fits
36-0504	36-0406	36-1534	36-2350	38619-57	Stock	1957-70 All XL
—	36-0407	—	—	—	+4" Ext.	1957-70 All XL
—	—	—	36-2351	—	+8" Ext.	1957-70 All XL
36-0506	36-0408	36-1536	36-2352	38619-71	Stock	1971-85 All XL
—	36-0409	—	—	—	+4" Ext.	1971-85 All XL
—	—	36-1537	36-2353	—	+8" Ext.	1971-85 All XL
—	—	—	36-2495	—	-5" Under	1971-85 All XL
—	—	—	36-2354	—	Stock	1971-85 All XL, Nylon Lined
—	36-2425	—	—	38619-06	Stock	1986-90 XL 883
36-2513	—	—	—	38621-86	Stock	1986-90 XL 1100, 1200
—	—	36-1538	36-2485*	38619-86A	Stock	1986-03 XL 883
—	—	36-1539	36-2486*	38621-86A	Stock	1986-03 XL 1100,1200
—	—	36-1540	36-2487*	—	+6" Ext.	1986-up XL 1100,1200
36-8061	36-2432	36-1541	36-0539	38620-96	Stock	1996-03 XLH-1200CC
—	36-8089	—	—	—	2" understock	As Above
36-8064	36-8085	—	36-8087	—	38699-04	Stock 2004-up XL
36-8078	36-8086	—	36-8088	—	+4" Ext.	2004-up XL

\*Note: Uses eyelet style end. Hand lever pin is supplied.



Stainless Steel Braided Clutch Cables.				
VT No.	Casing Length	Length	OEM#	Application
36-8050	52.75"	Stock	38619-86A 38663-00	86-03 XLH 883 Std., 87-91 XLH 883 Deluxe, 00-03 XL 833C/1200CC, 02-03 XL 883 R, 96-03 XL 1200S
36-8052	61.25"	Stock	38621-86A	86-87 XLH, 92-95 XLH 833 Delux, 87-95 XLH 883 Hugger, 88-95 XLH 1200
36-8053	47.06"	Stock	38619-84	70-85 XLH, 81-85 XLS, 70-79 XLCH
36-8061	57.25"	Stock	38662-00 38620-96	96-03 XLH 883 Hugger/ XLH 1200, 99 XL 883C, 96-99 XL 1200C
36-8064	54.75"	Stock	38699-04	04-up XL/XL 883C/XL 1200R
36-8078	59.25"	+4"	—	As Above



**Chrome Clutch Cable Adjuster Cover** fits 1987-up Big Twin and installs over adjuster at clutch adjustment cover. Locks in place with stainless set screw. Will retro fit Barnett or stock cables.

VT No.	Type	Style
36-0578	1982-up	Upper
36-0579	1987-up	Lower



**60" Chrome Cable Wrap** is a classic 1950's style dresser trim item. I.D. size noted. Sold each.

VT No.	Size
36-0520	5mm
36-0521	6-7mm
36-0525	10-11mm



**Rubber Cable Oiler Boot** replaces 38690-55, for XL 1955-80. 5 pack.  
VT No. 28-0401

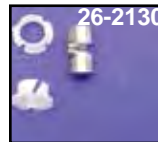

### Lever Pins/Bushings

VT No.	OEM	Item	U/M
26-2130	45036-82	1982-87	10
26-0505	45036-68	1965-72 with Bushings	10
26-2138	45039-68	Nylon Bushing	25
26-2132*	45036-88	1988-up with Bushings	Ea
36-2559	45423-92	Lever Bushings	10

\*Note: Teflon pin fits 1988-up eyelet clutch cables



**Replica Clutch Adjuster Sleeve.** Fits 1954-71, 7/16" hole levers. Zinc plated.  
VT No. 37-8460





# Speedo Cable



## Front Wheel Drive Speedometer Cables

Choose by application or by length and top nut size.

**Blk Vinyl Stainless OEM Length Top Nut**  
1984-87 XLH, 1986-87 XLH 1100, 1984-85 XL, 1983-85 XR.

Replaces OEM 67078-85A, 67051-73 & 67052-78A.

36-0606 36-2528 See Text 40" 16mm

36-0813 — Barnett 40" 16mm

— 36-0120 Coated 40" 16mm

1973 XL, 1988-94 XLH, 883 HUG-DLX and XLH 1200.

36-2414 36-2529 67048-83A 43" 16mm

— 36-0121 Coated 43" 16mm

36-0815 — Barnett 42" 16mm

36-0608 — 67052-78B 49" 16mm

1973 only XL Models.

36-0601 — 67051-73 42.5" 16mm

36-0602 — +4" 46.5" 16mm

1983 XLS Models.

36-2410 36-2530 67054-83A 46.5" 16mm

1974-83 XL Models.

36-0603 36-0819 67051-74 39" 12mm

— 36-0123 Coated 39" 12mm

36-0814 — Barnett 39" 12mm

36-0959 — With Elbow 41" 16mm

36-0604 — +4" 43" 12mm

36-0605 36-2534 +6" 44.5" 12mm

— 36-0124 Coated 44.5" 12mm

1979-82 XLS Models.

36-2411 36-2533 67060-79A 38" 12mm

## Transmission Drive Speedometer Cables

Black Metal OEM Lgth Top  
Vinyl Zinc Zinc Nut

1957-70 XL's Trans Drive

36-2570 36-2577 67051-52A 46" 5/8"

1970-72 XLH Models.

36-0992 — 67051-70 46" 16mm

1952-70 XL, Mini Speedo Kit 39-0365 and 39-0314

36-0512 Custom — 50" 12mm

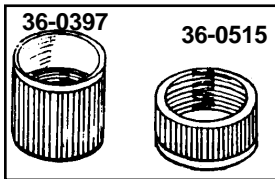

## Replacement Speedometer Cable Nuts

for front wheel drive cables and sold in 5 packs.

VT No. Size

36-0397 12mm

36-0515 16mm Course

5/8" NPT, fits Fat Bob

# Cable Clamp



**Chrome Cable Clamps** are two-piece design for securing cables or wires to frame and forks. Sold each. As noted for cable type

VT No.	Size	Holes	Type
37-8911	1"	1	Clutch
37-9119	1"	2	Throttle
31-9943	1"	Slot	Throttle (2)
37-8976	1 1/4"	Slot	Throttle (2)
37-9396	1 1/4"	2	Throttle (2)
37-8915	1 1/8"	1	Clutch
37-9359	1 1/4"	1	Clutch
37-8913	35mm (1 3/8")	1	Clutch
37-8914	39mm	1	Speedometer
37-9341	41mm	1	Speedometer
31-1010	49mm	1	Clutch



**Chrome Billet Cable Clamps** sold each.

VT No.	Size	Type
37-0883	1"	Throttle, Single
37-0887	41mm	Clutch
37-0897	39mm	Clutch



**Kwik-Klip** attaches brake line or speedo cable to fork leg.

VT No.	Inner Diameter
24-1023	39
24-1024	49
24-0497	41

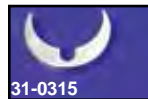

**41mm Push On Fork Tube Clamps.**

VT No.	Style
31-0315	Smooth
31-0316	Groove



**Cable Adapter** allows use of 5/8" cable on 12mm threaded speedometers.

VT No. 36-0507

# Brake Cables



**Brake Cable Clamp** cinches cable to brake arm.

VT No. 26-0508



**Cable Clamp** is fitted to hand lever for emergency or permanent use. Easy to install .460" diameter, pair.

VT No. 26-0509



**Front Brake Cable.** Replacement core and casing for 1949-71 FLH Glide 1952-72 Sportster models. Replaces 45073-51 60" long, must be cut to proper length.

VT No.	Type
36-2385	Stock V-Twin
36-2565	Stock M&M
36-0545	Replica 1949-52, 26"
36-0501	Stock Type, Barnett
36-0509	Replica
36-2489	Braided Steel

# Choke Cable

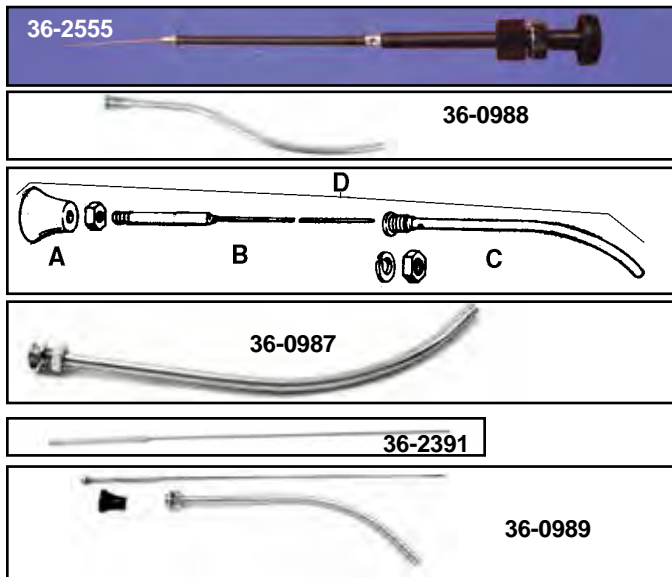

**Choke Cable Assemblies** for years listed.

VT No.	#	OEM	Fits
36-0989	D	Kit	1967-70 XL
36-0946	D	Kit	1972-79 XLH-XLCH
36-2555	D	29229-88D	1988-up XL
36-0987	C	29220-67	1967-70 XL
36-0988	C	29220-72 29219-78	1972-78 XL 1979-E80
36-2391	B	29216-72	1972-78 XL
36-0994	A	29214-67	1971-84 XL Knob Black plastic



**Chrome Choke Knob** fits 1989-up CV model carbs. **VT No. 36-0551**



**Choke Knob Insert** polish stainless, pack of 5. Fits 1989-up. **VT No. 36-0555**



**Block Off Plug** for speedometer drive hole plug fits 1952-72. **VT No. 2057-2**

# Speedometer Drive

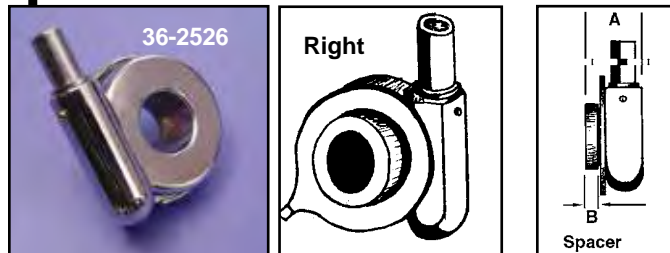

**Speedometer Drive Units** fit front wheel only, have .750 axle hole, for right and left side as noted, spacer length note. (A) Overall (B) Spacer length. 2.1 Ratio.

VT No.	OEM	Spacer	Length	Fits	Side
36-0800	67127-73	.268	.789	All 1973-83 XL-XLS-XLCH	Right
36-2526	Chrome	.268	.789	As Above	Right
36-0802	67127-84A	.361	.940	1984-94 XL	Left



**Chrome Speedometer Drive Cover** fits perfectly over the existing drive units. Fits 1987-95 with 39mm Forks.

**VT No. 42-0434**



**Speedometer Drive Spacers** replace drive units. Fits 1973-83 XL.

**VT No. 44-0390**



31-0149



28-1998  
Installed

**Speedometer Cable and Cable Mount** for front wheel drive models 1973-95. 5 packs.

VT No.	OEM	Item
31-0149	38623-68	Chrome Bracket
28-1998	66996-85	Cable Boot

# Electronic



**Speedometer Sending Unit Wrench** features a shortened 3/16" ball end hex bit for removal or installation of hex screw used on all models equipped with electronic sending units.

**VT No. 16-6738**



36-0250



36-0422

**Speedometer Calibrator Corrects** readings of stock electronic speedometers when using oversized rear tires or when other drive train modifications have been done that effect final drive ratio. Use on all Big Twins.

VT No.	Brand
36-0250	S&S
36-0422	V-Twin



**1995-up XL Electronic Speedometer Sending Unit** replaces 74402-95B.

**VT No. 17-0589**



**Programmable Transmission Speedometer Sensor** is a fully adjustable sensor assembly for all 5 & 6 Speed transmissions with electronic drive speedometer. Allows fast and accurate adjustments for any tire size, pulley on gear ratio change.

**VT No. 36-0150**





# Mini Gauge Kit

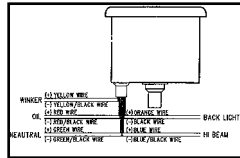
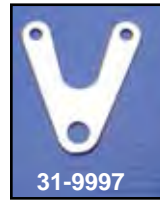
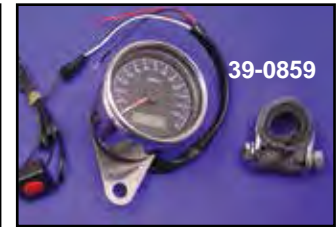
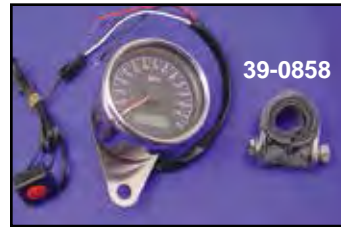

39-0435, 39-0436, 39-0550 Turn Signal Light, Pre90 models tap into orange wire exiting turn signal flasher. 1991-up models signal indicator light cannot be used.

**60mm Mini Electronic Speedometer and Tachometer.** Speedometer features a 12 volt LED back-light and easy push button recalibration and re-settable trip meter. The 8000 RPM tachometer has LED lamp. All units have black face and include clamp.

**Mini Gauges** includes cable and mount clamp and 4 LED indicators on 60mm types only. Note: 39-0556 & 39-0437 include left side speedometer drive.

- Blue-High Beam
- Green-Neutral
- Red-Oil
- Yellow-Turn Signals



VT No.	Ratio	Drive	Item
39-0858	2:1	Mechanical	Speedometer
39-0859	2240:60	Mechanical	Speedometer
39-0593*		Electronic	Speedometer
39-0860	0-8000 RPM		Tachometer
31-9997	Y		Bracket
28-0325			Clamp

\*Note: For use with stock type electronic speed sensor.

## White Face

48 mm	60 mm	Ratio	Item	Year
39-0435	39-0550	2:1	Speedometer	1973-94
39-0437**	39-0556**	2:1	Speedometer	Custom
39-0438*	39-0576*		Tachometer	Electric
39-0456	39-0456		Knob	Speedometer

\*Note: Does not have LED indicators.

\*\*Note: Does not have LED indicators and includes 2:1 ratio left side speedo drive unit.

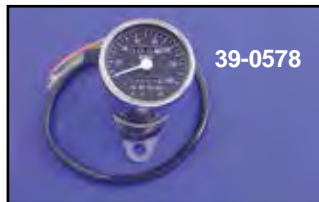

**80mm Electronic Gauge** features stainless housing and Y bracket.

VT No.	Type	Year
39-0563	Tachometer	1978-up
39-0789	Speedometer	1995-up



48mm	60mm	Ratio	Item	Year
White Face	Black Face			
3-LED	4-LED			
39-0439	39-0578	2:1	Speedometer	1973-94
39-0441	39-0580	2:1	Speedometer	1995-99

## Warranty

All Gauges sold as individual pieces or in kits are covered under our warranty "Replacement Only" Provision. All item part numbers begin with a 39 prefix. No credit will be issued for these items as they are exchange only.

# Digital Speedo/Tachometer



## Digital Speedometer/Tachometer

has the following functions:

- Bar Graph Tach
- High Beam
- Neutral
- Oil Pressure
- Turn Signals
- Digital Odometer
- Trip Meter
- Unit measures

110mm ((L)x57mm (H) x 38mm(W).

**VT No. Item**

- 39-0599** Gauge (A) **Requires an installation bracket**
- 39-0685** Gauge (B) **No bracket necessary for installation**
- 31-0984** Bracket
- 31-2145** Bracket
- 31-1262** Bracket



**Multi-Colored Mini Gauges.** 60 mm gauge features a 2.4" polished stainless body with a white face, total length of 2.7". Units include a chrome bezel with choice of red, orange, blue, yellow, white, green or purple by the push of a button. Works on 12 v systems. Tach adapter required for use with single fire ignition. Speedometer accepts 12 mm drive cable.

**VT No. Gauge Ratio**

- 39-0417** Speedometer 2:1
- 39-0433** Speedometer 2240:60
- 39-0434** Tachometer Electric

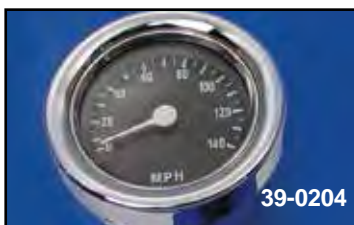

# Mini Gauge Kit



**48mm Deco or 60mm Mini Speedometer and Tachometer Kits** include gauge, chrome bracket and rubber handlebar clamp and proper cable which can be installed without any adapters or modifications.

1995-99 kits for XL includes drive and cable.

48mm Deco	60mm Mini	Ratio	Fits
<b>Speedometer</b>			
<b>39-0365</b>	<b>39-0314</b>	2:1	1952-72
<b>39-0368</b>	<b>39-0315</b>	2:1	1973-94
<b>39-0554</b>	<b>39-0555</b>	2:1	1995-99
—	<b>39-0575</b>	Electric	1995-up (Not a Kit)

**Tachometer**

<b>39-0366</b>	<b>39-0317</b>		1971-80
<b>39-0367</b>	<b>39-0392*</b>		Electric 3-wire type

- 31-9997** Fits All Chrome Y mount
- 33-2008** Fits All Light socket with bulb
- 33-2047** Fits All 12 Volt bulb, 10 pack

**Note:** For use on 1978-up models with coil triggered tach, Green Negative wire goes to negative side of coil. Red wire goes to ignition side of key switch. Tach head must be grounded by black wire.

Cable 36-0512 fits 39-0314 & 39-0316 kits.

Cable 36-0603 fits 39-0315 kits.



**Chrome Billet Housing** will accept 48 mm electronic tachometer or speedometer.

**VT No. 39-0116**

**Chrome 60mm Tachometer Housing Kit** includes bracket (to mount to XL 39mm 1988-up fork stem bolt) and 60 mm electric tachometer. Housing which is available separately may be fitted with any 60mm electric speedo or gauge.

**VT No. Item**

- 39-0202** Tachometer Kit (Includes housing & bracket)
- 39-0204** Speedometer Kit (Includes housing & bracket)
- 39-0203** Housing Only
- 24-0637** Stem Bolt





# Gauge Mount



39-0142

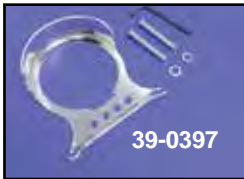

39-0397

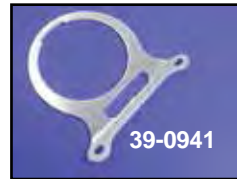

39-0941



39-0212



39-0213



39-0141



39-0400



39-0942

## For 48mm Mini Gauge



39-0602



39-0603



39-0604

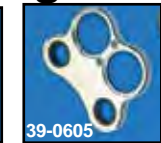

39-0605

Chrome Billet Gauge Holder fits 48mm or 60mm gauges for T-type bars 1" or 1 1/4" with 3/2" center.

48mm	60mm	Holes	Type
39-0602		None	Single
39-0603		2	Single
39-0604	39-0613	None	Dual
39-0605	39-0614	2	Dual



Speedometer Visor fits 1995-up XL models.  
VT No. 39-0223



31-0877 Installed

Chrome Billet Fork Tube Gauge Bracket permits quick and easy installation of mini 48 mm gauges to exposed fork tubes. Gauges are sold separately.

VT No.	Fork Size
31-0876	39mm
31-0877	41mm



33-2022



33-2024



33-2025



33-2026

### 3/8" Indicator Lamps.

VT No.	OEM	Color	Type	Fits
33-2022	68489-86	Red	Oil Pressure	1986-up XL
33-2023	68574-86	Green	Neutral	1986-up XL
33-2024	68023-92	Blue	HiBeam	1986-up XL
33-2025	68695-91	Green	Turn Signal	1991-up XL
33-2026	68002-92A	Red		1991-up XL

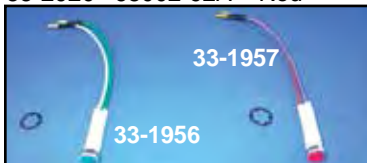

33-1957

33-1956

Indicator Lamps fit visors and dash for high beam, neutral and generator.

VT No.	OEM	Color	Type	Fits
33-1956	67851-75	Green	Neutral	1975-83 XL
33-1957	68536-75	Red	Oil Pressure	1975-83 XL

Speedometer and Tachometer Brackets in chrome fit all XL models.

VT No.	OEM	Lite	Years	Type
39-0142	67053-83	3	1983-91	Single
39-0397	67053-86	4	1986-91	Single
39-0941	67083-92	Slot	1992-94	Single
39-0212	67293-95		1995-up	Single
39-0141	67110-83	3	1983-91	Dual
39-0400	67036-86	4	1983-91	Dual
39-0942	67167-92	Slot	1992-94	Dual
39-0213	67294-95A		1995-up	Dual



39-0162



39-0395



39-0394



39-0401



39-0955



39-0956

Chrome Gauge Covers fit FXR models.

VT No.	OEM	Year	Type
39-0162	Set	1984-90	Tach and Speedometer
39-0395	67092-85	1984-94	Tachometer
39-0394	67090-85	1984-90	Speedometer
39-0943	67091-91	1991-94	Speedometer
39-0955	92061-83	1983-up	Rubber Cushion
39-0956	67104-83	1984-91	XL Rubber Cushion



39-0143



39-0139



39-0140

Speedometer and Tachometer Brackets, 1973 only.

VT No.	OEM	Type
39-0143	67181-73	Single Gauge
39-0139	92074-73	Tachometer-Speedometer
39-0140	67180-73	Cup for Speedometer and Tachometer



# Tank for 2004-up XL



38-7079



38-7080

**Bobber Gas Tank** for XL. Tanks have a 2.3 gallon capacity and left side petcock.

VT No.	Year
38-7079	2007-up
38-7080	2004-06



38-0877



38-0295



38-0283

**King Tanks** available with pop up gas cap. Capacity is approximately 3.3 gallons. 38-0283 purchase gas caps separately, 38-0352

VT No.	Style	Year
38-0295	Pop Up	2004-06
38-0283	Aircraft	2004-06
38-0296	Cap Only	



38-0025



38-0065



38-0026

**Bobber Tanks** are 3.2 gallon and fit 2004-06 models. 38-0026 accepts dash kit.

VT No.	Type	Cap
38-0025	Smooth	2
38-0065	Smooth	1
38-0026	Accepts Dash	2
37-0350	Bolt Set	



**Chrome Right and Left Gas Tank Cover** fits 2004-up XL.  
VT No. 38-0933



35-0748



35-0750

**Adapter Bushing** allows use of carb type petcock on electronic fuel injection models.

VT No.	Model
35-0748	FX-FL
35-0750	XL



38-0270



38-0885



38-0880



38-0951



38-0853

**Replica Tank** with stock or aero filler neck.

Replica	Aero	Year	Type
38-0270*	38-0885*	2004-06	Carburetor
38-0877*	38-0880	2007-up	Electronic Fuel Injection
38-0853	—	2007-up	Electronic Fuel Injection
38-0951	—	2011-up	2.4 Gallon 1200X
28-0928	—	2007-up	EFI Plug

\*Note: Order cap separately.

Note: 2007-up XL models are fuel injected and require a fuel tank that accepts the Electronic Fuel Injection unit.



38-0030

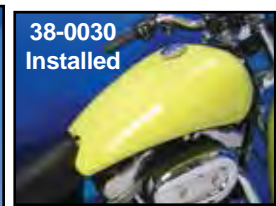

38-0030 Installed

**2" Stretch Tank** as shown on 2004 XL Sportster, to fit 2004-06 models, 4.0 gallons.

VT No.	Type	Cap Type
38-0030	Smooth	Screw In
38-0425	Smooth	Pop-up



**4.0 Gallon One Piece Bobbed Tank** for 2004-06 XL's and includes bolt in locking aircraft style gas caps and full rubber mount system.  
VT No. 38-0299





# 1982-03 Tank



**One Piece Bobber Tank** fits 1982-03 brackets included. Order cap separately. **VT No. 38-0639**



**Seamless Side Panel Design!**

**2" Stretch!**



**Legacy Gas Tanks** use stock bung cap for Sportsters.

**VT No. Year**  
**38-0481** 1983-03  
**38-0482** Custom  
**38-0483** 2004-10  
**38-0484** 2007-up EFI



**King Tanks** available with air craft or pop up gas cap. Feature smooth radius edge profiles. Capacity is approximately 3.3 gallons.

**Air Craft Pop Up Year**  
**38-0281\*** — 1982-1995  
**38-0426 38-0296** Cap Only

**\*Note:** Does not include cap must be purchased separately.

**2" Stretch Tank** for 1982-2003 XLS is one piece curved design with full rubber mounting. Order coil and switch location kit for 1995-2003 models. Dash type accepts 2, 3 or cast dash assemblies.

VT No.	Type	Year	Type
<b>38-0260</b>	Dash Type	1982-2003	Smooth
<b>38-0262</b>	Single Cap	1982-2003	Smooth
<b>38-0297</b>	Single Cap	1982-2003	Indent
<b>38-0930</b>	Single Cap	2007-up	Smooth (No Cap)
<b>38-0931</b>	Single Cap	2007-up	Indented



# 3.2 Gallon E-Z Bob Tank



**38-0191**  
**Bobbed Tank Kit** features one piece 3.2 gallon design, which includes chrome bung style late caps, and all necessary mount hardware for installation. Kit also includes a chrome cast dash kit.

VT No.	Years
38-0179	1982-94
38-0177	1995-03
38-0191	2004-06

\*NOTE: THE ABOVE TANK KITS INCLUDE A DASH KIT WHICH INCLUDES A PLAIN DASH BASE WITHOUT WIRING, 2:1 RATIO BOB STYLE SPEEDO, A 43" SPEEDO CABLE FOR FRONT WHEEL DRIVE APPLICATION AND A LATE BOB TYPE 6 POST CHROME KEY SWITCH. UNITS FOR 1995-UP DO NOT INCLUDE SPEEDO OR CABLE, THESE KITS DO INCLUDE BRACKET TO MOUNT STOCK ELECTRONIC SPEEDO FROM MOTORCYCLE AND A COIL RELOCATION KIT. TANK IS 21 3/4" LONG AND 12 3/4" WIDE. MOUNT HOLE TO MOUNT HOLE IS 15 1/4". PETCOCK ON LEFT. TANK ASSEMBLIES ARE SOLD WITH "PLAIN DASH BASE" AND ARE NOT DESIGNED TO BE WIRED FOR INSTRUMENT LIGHTING. DASH BASES VT No. 39-0959 FOR 3-LIGHT AND VT No. 39-0960 FOR CAST DASH ARE AVAILABLE SEPARATELY FOR BUILDER REQUIRING DASH LIGHTING.

## Bobbed Tank Kit



**Bobbed Tanks** feature a smooth top and does not accept dash panel or speedo. 3.2 gallon capacity and includes necessary hardware for installation. Order cap set VT No. 38-0321 late bung style caps separately. 1995-up kits include coil/ignition switch kit. Tank width is 14 1/2" tapering to 9", overall length is 19", tunnel height is 7 1/2" and width is 2 1/2".

VT No.	Years
38-0090	1957-78
38-0072	1979-81
38-0091*	1982-94
38-0071*	1995-03
38-0025	2004-06
38-0321	Chrome Two Cap Set
31-0321	Coil Mount and Switch Cover Kit

\*Note: Mount hardware not included!



**Bobbed Tanks** fit XL's and feature bolt in locking aircraft style gas caps and full rubber mount system for 1982-03 models.

VT No.	Style	Gallon	Year
38-0033	Bobbed	3	1982-03
38-0426	Cap Only with two keys		



**Bobbed Tanks One Piece** for Sportsters will bolt to existing mounting holes and includes hardware. Available as tank only which will accept 2, 3 or cast type dash kits which includes 3 lite dash, plain unwired dash base, 2:1 ratio speedometer, key switch (for cosmetic looks only) gas cap set, gas tank and mounting hardware. 1982-up models must use XLS or shorter seat. All tanks use 38-0321 gas cap set and are 3.2 gallon capacity. Tank measure 21 3/4" long and 12 3/4" wide and is 15 1/4" from mount hole to mount hole with petcock location on left hand side. 1995-up kits include coil relocation kit VT No. 38-0218 and speedometer adapter ring that allows use of stock speedometer in dash cover.

Kit	Tank Only	Years
38-0075	38-0097	1952-78
38-0076	38-0094	1979-81
38-0077	38-0096	1982-94
38-0067*	—	1995-03
—	38-0026	2004-06

\*Note: Does not include speedometer cover



**Bobbed Gas Tank Kit\*** include a 3.2 gallon one piece tank, chrome dash without key switch hole, plain dash base and mounting hardware. All kits can be used with a solo seat or custom seat with a shorter nose like our XLS types. Dash will not accept a speedo with a built in tach. Order speedo separately. Tank is 21 3/4" long and 12 3/4" wide. Mount hole to mount hole is 15 1/4" petcock on left. Fits 1982-94 bung style.

VT No. 38-0082





# Replica Gas Tank



38-0024



38-0104



38-0743



38-0117



38-0085



38-0039

Replica Gas Tanks for Sportster are stock styled high-tunnel Tanks that feature stock mounts and filler neck. Fits 1955-up, 2.4 gallon capacity. Tanks use a 1975-up petcock.

VT No.	OEM	Fits	Side
38-0095*	61000-54C	1952-70 includes vent tube & accepts early petcock 35-0400	Right
38-0024*	61023-83	1982-93 Rubber Mount	Right
38-0104*	61044-75	1958-78	Right
38-0743		1958-78	Right
38-0105*	61097-79	1979-81	Right
38-0117**	61023-83	1982-92	Right
38-0085**	61023-93	1993-2003	Right
38-0039**	61023-93	1993-2003	Left

\*Note: Uses early cap 38-0310

\*\*Note: Uses cap 38-0317



38-0224

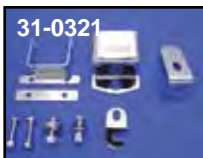

31-0321



38-0218

### Iso-Mount Kit.

VT No.	Year
38-0224	1957-78
38-0225	1979-81
38-0219	1982-2003
38-0218	1995-98 Coil and Switch Mount Relocation Kit
31-0321	Coil Mount and Ignition Switch Cover with Hardware, 1995-up

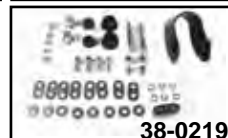

38-0219

# Gas Cap



38-0757



38-0361



38-0391



38-0405



38-0423



38-0789



38-7001



38-0541

Gas Caps for screw in bung style gas tanks. Vented type fits 1983-up single cap XLH tanks. Sold each.

VT No.	Style	VT No.	Style	VT No.	Style
38-0757	Pop-Up	38-0423	Maltese	38-0539	Smooth, Black
38-0361	Pop-Up	38-7001	Eagle	38-1132	Skull, Black
38-0391	Cross	38-0789	Skull	38-6719	Wings
38-0405	Flame	38-0541	Flame		



Chrome Spinner Gas Cap fits bung style tanks with vent.

VT No.	Fits
38-0409	1983-95
38-0429	Set 1983-95

# Mounting Hardware

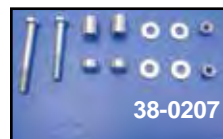

38-0207

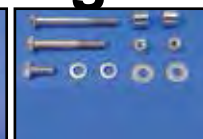

38-0217

XLCH Gas Tank Mounting Hardware Kit includes nuts, washers and spacers for mounting stock gas tank.

VT No.	Years
38-0207	1958-85
38-0216	1986-92
38-0217	1993-2003

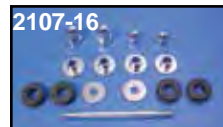
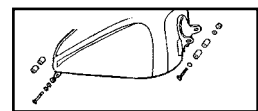

2107-16



2265-6

Gas Tank Mounting Kit includes chrome custom acorn nuts, washers, studs, spacers and grommets.

VT No.	Year
2107-16	1996-2003
2265-6	2004-up

Hardware for above available separately.

VT No.	OEM	Year	Item
37-9209	42500-80	1980-up	Spacer
37-9208	5787	1993-up	Spacer
37-9211	61135-57	1952-81	Spacer

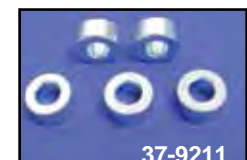

37-9211



# King Gas Tank



38-0132 Back



38-0132 Front



38-0132  
Rolled Bottom  
Edge



38-0133  
Installed  
and Painted



38-0032



38-0032  
under  
side



38-0485



38-0485 under side



38-0274



38-0274



38-0799



38-0106



King

Stock



38-0118



38-0086

'King' Gas Tanks are made 2" wider than stock and include stock style mounts, 3.1 gallon capacity. King Tank is 17½" long, 10¾" wide. 38-0106 accepts 3/8" NPT petcock. Petcock side as noted.

VT No.	Year	Side
38-0106*	1958-78	Right
38-0107*	1979-81	Right
38-0118**	1982-92	Right
38-0086**	1982-94	Right

\*Note: Uses Early Cap 38-0310.

\*\*Note: Uses Cap 38-0317



38-0019



38-0021



38-0066



38-0098

Universal Gas Tanks available in 3.1 or 2.5 gallon capacity.

VT No.	Type	Size	Tabs
38-0019	2.5	Stock, Forward, Bayonet	Side
38-0021	2.5	Stock, Forward	Side
38-0023	2.4	Stock, Right	Side
38-0066	2.5	Stock	F & R
38-0098	3.1	King	F & R



### Allen Tank Mount Kits.

VT No	Year
37-9302	1972-79
37-9303	1986-95



Tank Riser Kit gives a 2" rise to the front tank on 1995-2010 Sportster models.

VT No. 38-0857

V-Twin™ Replica King Tanks feature an updated design shape that rolls the bottom edge under, to give flowing lines, while still retaining the classic shape. These are replicas of the 1996-up stock versions which are stock on all 1997-up models. King Tank is 20" long 10" wide.

VT No.	Year	Gallon	Petcock	Type
38-0133	82-94	3.2	Right	Carburetor
38-0132	95-03	3.2	Left	Carburetor
38-0032	04-06	3.2	Left	Carburetor
38-0485	07-up	3.2	Left	Electronic Fuel Injection
38-0799	07-up	3.2	Left	Electronic Fuel Injection, Aero
38-0845	07-up	3.2	Left	Electronic Fuel Injection, Pop-up
38-0951	07-up	2.4	Left	Electronic Fuel Injection, 1200 X
38-0274		3.2	Left	Carburetor Custom
28-0923				Rubber Insert





38-0288



38-0065



38-0686



38-0685



38-0687



38-0688

**Chopper Tanks** feature axed style with single center bung. 38-0288 is rubber mounted. Bung style cap.

VT No.	Year
38-0288	1982-03
38-0065	2004-06

**XR Style Gas Tank.** Original shape for the "750" look.

VT No.	Fits
38-0686	1957-78
38-0685	1982-03
38-0687	2004-06
38-0688	2007-up
38-0636	XR 750 1957-78 Without brackets, Universal

## Porkster Tank™



38-0079



38-0027



38-0028



38-0038



38-0037



38-0037 on bike



**Porkster Tank** is 4.2 gallon axed style large tank to bolt on Sportsters models, use 38-0310 cap for single and dual cap styles and stock petcocks. Available in single or dual caps. Tank is 13½" wide, 15¾" long, 8¾" deep. Tunnel is 2¼" wide, 2¼" deep.

Single	Dual	Years	Petcock Side
—	38-0079*	1979-81	Right
38-0027	38-0028	2004-2006	Left

\*Note: Uses early style pre1975 type petcock all other numbers use 1975-up type petcock.

**Replica Style 3.5 Gallon Tank.**

VT No.	Year	Petcock
38-0038	1952-78	Right
38-0037	1982-2003	Left
38-0329		Cap



**Replacement Fuel Filter Kit** is OEM style and fits 883 and 1200cc Sportster models. Fits 2007-up.

VT No. 35-6107

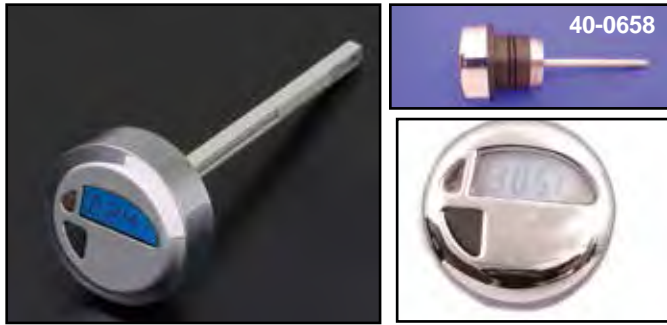

**LCD Dipstick** with temperature read-out. Fits 1984-2003 XL models.

**VT No. 40-0658**



**Oil Temperature Dipstick** features

- Lighted LCD readout
- Fahrenheit or Celsius operation
- Replaceable battery
- Fits 1984-2003

**VT No. 40-0602**

## Oil Cooler



**Dual Cool Chrome Oil Cooler** includes stainless steel hose and adapter fitting for engine to allow use of oil filter which is included on 40-0270 and 40-0272. 1971-81 models may require bracket modification. **Note:** Brackets included also sold separately.

VT No.	Year	Brackets
40-0272	2004-up	31-1177
40-0270	1979-2003	31-0722
40-0271	1957-78	31-0722

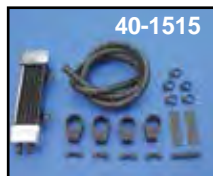

**Sifton Oil Coolers** for XL models. These are mounted vertically.

Deluxe	Slim Line	Chrome	Year
40-1525	40-1516	40-1518	1957-03
Jagg	—	40-1512	1957-up



**Billet Twin-Cooler Set** feature two independent 1" diameter cooler canisters with four billet clamps for mounting to 1 1/8" front frame tubes.

VT No.	Length	Finish
40-0339	9"	Chrome
40-0805	7"	Black
40-0806	11 1/2"	Black

Clamp Size	Item
40-0342 1 1/8"	
40-0590 1"	

## Dipstick

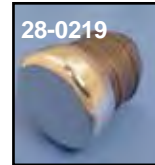

**Oil Tank Dipstick and Temperature Gauge Plugs.** Stock dip sticks also available, replaces rubber plug in caps.

VT No.	Type	Year
40-0361	Temperature Gauge	1979-2003
40-0667	Temperature Gauge	2004-up
40-1526	Dipstick	2008-up XR
28-0219	Oil Tank Cap	1970-78
40-0227	Oil Tank Cap, Maltese	1970-78
40-0495	Dipstick	1970-78
40-0360	Dipstick fits	1979-2003
40-0463	Dipstick, Maltese	1979-2003



**Sifton Oil Cooler** is a replica style in black or chrome. Order bracket separately.

VT No.	Finish	Item
40-0305	Black	Cooler
40-0306	Chrome	Cooler
31-1758		1982-up Bracket





# Oil Tank



**XLH Chrome Side Oil Tank** fits electric start Sportsters 1954-E78. Cap not included.

VT No.	Item
40-0400	Chrome Tank
40-1254	Black Tank
40-0504	Cap Assembly
40-0845	Cap Kit
37-0827	Mount Bolt Kit
15-0200	Cap Gasket (1952-65)
15-0201	Cap Gasket (1966-78)



**XLCH Chrome Oil Tank** fits 1970-78 with kick start in rigid or stock frame. Includes chrome fill plug. Top mount and lower mount available separately.



VT No.	Item	Finish
40-0425	Tank	Chrome
40-0612	Tank	Black
40-0324	Tank	Black, Early
31-3975	Lower bracket	Chrome
31-3965	Upper bracket	Zinc
37-0826	Mount Bolt Kit	Zinc



**Chrome Electric Start Oil Tank** fits electric or kick starter models 1967-78. Tank utilizes stock mounts for installation. Measures 12" x 6" x 6". Some 1973-78 models may require strut brace modification. Battery compartment measures 7½" long x 4 ¼" wide.



VT No. 40-0403

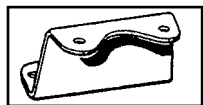

**XLCH Front Oil Tank Mount.** Zinc plated, fits 1953-65.

VT No. 31-0426

## Caps



**Oil Tank Plug** is constructed of rubber with chrome cap for tanks which accept a push in plug. VT No. 28-0219

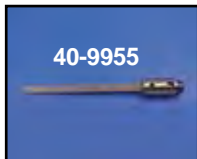

**Chrome Oil Tank Cap** fits the stock type oil tank on 1952-78 XLH. Replaces 62610-52A  
VT No. Item  
40-0504 Cap  
15-0329 Cap Gasket  
15-0341 Cap Washer  
40-9955 Dipstick  
12-0970 Retaining Ring



**Magnetic Drain Plug** prevents metal particles from circulating through oil tank and time hole. Plug is ¾" — 18. OEM#720, 706A. VT No. 37-0098



40-0474 Installed



40-0742

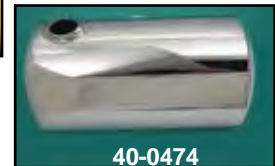

40-0474



31-1755

**Chrome 5.5" Round Oil Tank** fits XL's with Rigid frame mounts by clamping to center tube or top mount center fill.

VT No.	Type	Finish	Brackets
40-0474	Clamp	Chrome	—
40-1476	Clamp	Raw	—
40-0741	Top Mount	Chrome	31-1755
40-0742	Top Mount	Raw	31-1755



40-0404

**Chrome Magneto Horseshoe Tank** for Sportster features side fill spout with a capacity of 3¾ quarts. Fits 1957-78 kick starter applications. No provision for a battery. Use mount kit to attach 40-0404 to single tube XL rigid frame. Includes cap.

VT No.	Item	Type
40-0404	Tank	Swingarm, stock
37-0098	Drain Plug	



40-0416

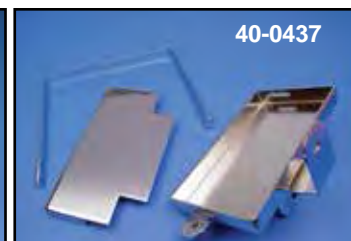

40-0437

**Chrome Rigid Oil Tanks** fit our frames VT No. 51-2174 thru 51-2177. Battery tray accepts 12N164B battery, VT No. 53-0518.

VT No.	Item
40-0416	Oil Tank
40-0437	Battery Tray with strap and Top



# Oil Tank and Cover for 1979-up



40-0399



40-0390



40-0391



40-0401



40-0397



40-0397



Installed  
40-0001

## Oil Tank Cover "Instant" Installation

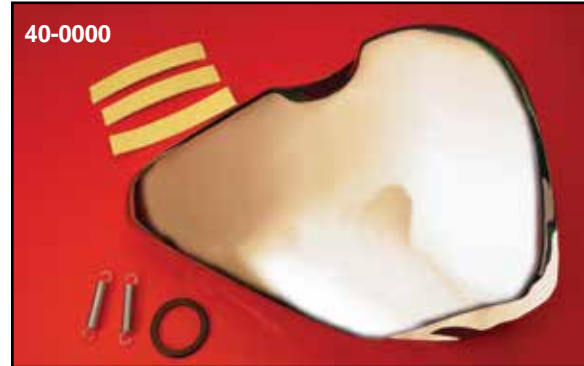

40-0000



40-0002

Oil Tank for XL's.

Chrome	Black	OEM	Year
40-0399	40-0390	62475-83	1983-93
40-0391	40-0401	62475-94	1994-96
40-0397	40-0257	62475-97	1997-2003
	40-0274	62888-04	2004-2009
28-0546		62563-65	Iso-Mounting Studs for Above Tanks

**Note:** Updated VT No. 40-0391 tank maybe fitted to earlier models by using battery oil tank mount tray.

VT No.	OEM	Year	Item
28-0409	60429-97	1997-2003	Bumper
28-0410	66214-97	1997-2003	Pad

## Module Covers



42-9973



42-9974



42-0310

Ignition Module Cover for 1982-2003.

VT No.	Style	Item
42-9973	Chrome Eagle Spirit	Cover
42-9974	Gold Inlay Eagle Spirit	Cover
42-0310	Smooth Chrome	Cover
37-0824	Chrome Screw Set	1982-97
37-0893	Chrome Screw Set	1998-2003
37-8348	Insert for Above	



40-4006  
1980-81 Style



40-4005

Chrome Right Side Oil Tank Covers replace stock cover perfectly.

VT No.	OEM	Year
40-4005	66415-79	1979
40-4006	66601-80	1980-81
28-0158	11406	Mounting Grommet, 1980-81, pair

**Chrome Oil Tank Covers** are of one piece form fitting design to fully cover the outer surface of the tank. Cover is easily installed without removal of tank. It is attached to the rear oil tank fittings by springs supplied on 1983-93 model and by clips on 1994-up models.

VT No.	Year
40-0000	1983-93
40-0001	1994-2003
40-0002	2004-up

**V-Twin Developed The First Form fit oil tank covers in 1978 for the Sportster Electric Start Oil Tank.**





# Oil Filter Kit



**Universal Oil Cooler-Filter Kit** includes chrome spin on filter, finned aluminum mount flange, with hose and clamps.

VT No.	Item
40-0098	Filter Kit, Alloy
40-0952	Filter Kit, Chrome
40-0709	Filter Only, Chrome
31-2131	1" Frame Clamps

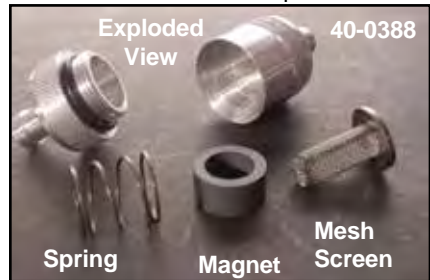

**Sifton Oil Pre-Filters** are constructed of machined alloy with a #40 mesh screen installed to trap large debris and a circular magnetic collar to collect the ultra fine ferrous particles before they reach the engine. Unit can be installed in the following locations for 3/8" inner diameter oil line: Supply line before the engine, all models. Return line to oil tank on XLCH and models without a factory filter, External oil return on high performance heads. Any pressure supply or return (use the prefilter with the 1/8" NPT threaded body).

VT No.	Type	Hose
40-0388	1/8" NPT Body	3/8"
40-0387	Barbed end	3/8"
40-0389	Barbed end	1/2"

## 1986-99 Oil Filter Hardware.

VT No.	OEM	Item
37-9195	6016	Washer
14-0556	11148	Quad Seal
13-9182	26002-86	Spring
14-0517	26433-77	O-Ring for Check Valve
13-9180	26436-86	Spring
32-0428	26554-77	Oil Pressure Switch



**XLH-XLS Oil Filter Kit** installs as engine mount plates and oil filter unit on all 1982-84 except Evolution. Accepts late peg assembly. Includes chrome filter, hose, clamps and chrome motor mount plates 16210-81 and 16213-81.

VT No.	Item
40-0301	Complete Kit
40-0711	Replacement Filter
27-0635	Late Type Foot Rest Support



40-0315 Installed



**Oil-Filter Adapter** for 1984-up XL alternator models, use 40-0709 filter.

VT No.	Item	Finish
40-0315	Adapter	Alloy
40-0316	Adapter	Chrome
40-0709	Chrome Filter	



**Oil Filter Adapter Screw Kit** fits all 1986-92 models.

VT No.	Type
8864-4	Acorn
9752-4	Allen



**Pura-Flow Oil Filter Kit** fits 1957-77. Kit includes left side motor mount plate, chrome filter and hose with clamps.

VT No.	Item
40-0097	Kit
40-0709	Replacement Filter



**Pura-Flo Universal Clamp On Oil Filter Kit** includes filter and hose.

VT No. 40-0850



**Sifton Oil Filter Adapter** for 1986-90.

VT No. 40-0540



**Oil Filter Adapter** use with 40-0709 filter. For 1986-2003 XL.

VT No. 40-0273



# Oil Filter



**Note: Chrome and Black Spin On Filters** are 3" outer diameter.



**Chrome Fram Spin-On Oil Filter** replaces 63782-80. Fits 1980-E84. 2.5" in length.

**VT No. 40-0725**



**K&N Spin-on Oil Filters** are available in chrome or black finish and feature hex nut end for easy removal and installation, improved pressure relief valve and anti-drain back valve.

VT No.	Finish	Fits	Length
40-1720	Chrome	1980-84	2.5"
40-1710	Chrome	1984½-up	3.75"
40-1711	Black	As Above	3.75"



**Perf-Form Filter Unit** is a complete drop-in replacement. 1954-78 XLH. Spring included.

**VT No. 40-0380**



**Oil Filter Elements** are original style. Fit 54-78 XLH models. Replaces 63888-53.

VT No.	Type
40-0700	Felt
40-0705	Metal Perforated
40-0720	Fram

Hex	VT No.	Perf-form	OEM	Finish	Length	Year
40-0857	40-0711	40-0363	63782-80T	Chrome	2.5"	1980-Early 84
40-0871	40-0710	40-0379	63810-80T	Black	2.5"	1980-Early 84
40-0860	40-0708	40-0378	63805-80T	Black	3.75"	1984½-up
40-0872	40-0709		63796-77T	Chrome	3.75"	1984½-up



40-0865 with nut

**Magnetek™ Oil Filters** feature a magnetic ring in center tower to trap particles less than 10 microns which could have escaped thru the filter wall.

Hex	VT No.	OEM	Fits	Lgth
40-0865	40-0851	63782-80	80-E84	2.5"
40-0864	40-0852	63796-77	84½-up	3.75"
				5-Speed XL



**Oil Filter Wrench** fits all spin on filters. 3/8" drive. **VT No. 16-0743**

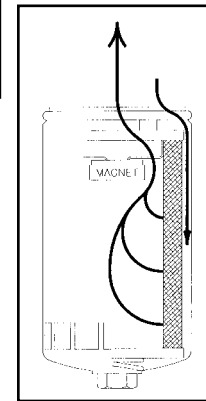

Oil flows in around the outer diameter, through the filter media and out passing by the magnet. The magnet captures particles less than 10 microns which could have escaped through the filter wall.

## 1954-78 Filters

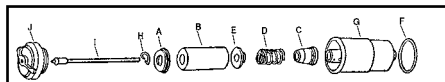

40-0125

**Oil Filter Hardware** for 54-78 XL models.

VT No #	OEM	Item
40-0714	Kit	A-B-C-D-E-F-H
40-9953	Kit	As Above w/cup (G)
40-9954	G	63826-53 Cup
40-0700	B	63839-53 Filter Element, 12 pieces
40-0122	E	63846-67 Lower Washer
13-0207	D	63831-67 Spring, 10 pack
40-0125	A&C	63881-67 Upper Seal Kit
		63882-67 Lower Seal
14-0526	F	63879-53 O-Ring, 10 pack
12-0940	H	63878-53 Clip 10 pack
40-9955	I	63885-65 Dipstick
40-0504	J	62610-52A Chrome Cap Assembly



**Drop In Filter Unit** includes spring, O-ring and one piece filter.

**VT No. 40-0172**



**VT No. 40-0714** includes internal components A-H as illustrated.



40-9953





# Oil Gauge

SIFTON  
MOTORCYCLE  
PRODUCTS

All gauges measure 1.5" diameter.



40-9966



40-0182



40-0632

**Sifton™ Rocker Box Oil Pressure Gauge Kits** feature 0-60lb liquid filled pressure gauge with case fitting which allows retention of oil pressure switch for indicator lamp with chrome bracket and screw to mount to head. Stainless steel line included.

VT No.	Year	Item
40-9966	1991-03	Kit
40-0632	2004-up	Kit
40-0841	2004-up	Hardware
40-0182		Line



40-0515



40-9991

**1½" Deluxe Liquid Filled Oil Gauge Kit.** Liquid filled face eliminates needle bounce giving a constant reading. Gauge features weather resistant sealed lens with chrome rim and extra-heavy mechanism, stainless steel case. Includes necessary chrome fittings for bolt-on installation.

VT No.	Fits
40-0515	1957-84 All XL's
40-9991	1985-90 Evolution XL's Head Mount



**Oil Gauge Fitting Kit** accept standard oil gauge with 1/8" NPT. 1957-84 XLH. 3 piece kit.  
VT No. 12-1415



40-9988



40-9988



40-0010

**Blackface Nugget Oil Gauge Kit** has original hex design to place oil gauge at rocker box level on 1957-85 Sportster. Sold as kit with 60 lb. Liquid filled gauge. Hex dome matches our rocker shaft end plugs early 7142-4, late 7143-4.

VT No.	Item
40-9987	1957-70 Complete Kit
40-9988	1971-85 Complete Kit
40-0359	1957-70 Fitting Only
40-0358	1971-85 Fitting Only
40-0010	1971-85 Fitting Only, Knuckle Nut Style
40-0500	60lb Gauge only, liquid, whiteface



40-0878



40-0589

**1" OD Mini Oil Gauge** with 1/8" pipe fitting.

VT No.	Year	Type
40-0878	1971-84	FX-XL
40-0589		1/8"NPT Gauge Only



40-9906

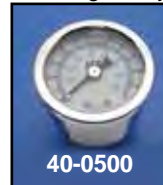

40-0500

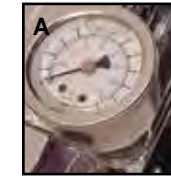

40-0569

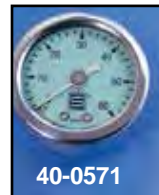

40-0571



40-0382



40-0386



40-9907

**Oil Pressure Gauge** has a stainless steel case and rim house. Available with liquid filled housing with 1½" face, 1/8" NPT male rear fitting.

VT No.	Pounds	Face	Brand
40-9906	0-30	Black	V-Twin
40-0500	0-60	White	AEE
40-0569	0-60	Silver	Sifton
40-0571	0-60	Blue	Sifton
40-0382	0-60	Black	Accel
40-0386	0-60	Black	V-Twin
40-9907	0-100	Black	Accel
40-0385	0-100	Black	V-Twin

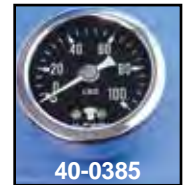

40-0385

Oil Gauges are covered under our warranty exchange terms for replacement only.



# Chrome Front Axle Kit



**Rear Chrome Axle Nut Caps Set** for both axle nut and axle head where required. Each cap has an internal hex to allow more thickness for set screws thread to eliminate thread stripping. **Note:** These axle caps will not work on late model rear axles with cotter key locking devices.

VT No.	Fitment
37-8885	1988-up
37-8885	1981-87
37-8884	1973-80
37-8884	1957-72



**Front Axle Cap Cover Sets** include right and left caps with set screws for glide type forks. Fits XL with 39mm forks.

VT No. 37-0036

**Front Wheel Seal Spacers** sold each for left side.

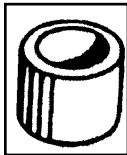

VT No.	Fits
44-0391	1973 XLH-XLCH
44-0305	1974-77 XLH-XLCH
44-0306	1978-95 XL-XLS
44-0296	1986-99 All XL Models



**Chrome Front Axle Spacer, Washer and Nut Kits** for 2000-up XL models with 39mm forks.

**Smooth Groove**  
2028-5 2027-5



**Chrome Front Axle Kits** include plated axle, nuts, spacer, and hardware. **\*Note:** Zinc Finish.

Year	Kit	Nut Kit	Axle	Axle OEM
1952-72	44-0573*	44-0308	44-0204*	43871-52
1973-77	44-0574	8768-3	44-0205	43871-73
1978-83	44-0576	8768-3	44-0206	43883-77
1986-87	44-0577	8768-3	44-0207	43883-84
1988-99	44-0578	8769-3	44-0086	43895-87
2000-07	44-0614	2028-5	44-0257	43895-08
2008-up	—	2509-6	—	—
2010-up	44-0747	—	—	Model "48"



**Chrome Flush Mount Axle** fits 1988-99 XL models with 39 mm forks. VT No. 44-0003



**Pike Front Axle Cover Sets** for 39 mm forks. Fits 1988-03. VT No. 2263-2

# Front And Rear Wheel Hubs



## Rear Hubs

VT No.	#	OEM	Fits
45-0301	A	41017-55	1955-78 K-XL-XLH-XLCH
45-0668	B	43457-79	1979-81 All XL
45-0670	B	40952-82A	1982-85 XL
45-0671	B	40976-86A	1986-99 XL
45-0332	E	40976-00	2000-2004 XL
45-0333	E	41053-02	2005-2007 XL
45-0792	E	—	2008-up without ABS
45-0810	E	—	2015-up with ABS

VT No.	#	OEM	Fits
45-0297	C	43600-73	1973 only XL
45-0307	D	43600-74	1974-77 XL's, Single Disc
45-0310	C	43600-78	1978-83 XL-XLS
45-0311*	C	—	As above, Satin
45-0298	C	43619-84	1984-99 XL-XLS
45-0292	C	—	As above but Dual Disc
45-0532	C	43619-00	2000-07 XL Hugger, Dual Disc
45-0641	C	43610-00	2000-07 XL Custom 883/1200 Chrome Single Disc
45-0793	E	—	2008-up Single Disc without ABS
45-0811	E	—	2015-up Single Disc with ABS
45-0958	—	—	2010-up "Model 48" without ABS

**\*Note:** Internals not included, order separately

All Hubs include bearings, races, seals, seal spacers and are assembled and chromed except where noted.





# Rear Axle Kit



Rear Axle Kits include chrome axle, nuts, sleeves and spacers for each application.

Kit Cpt	Spacer	Collar	Axle only	Nut Kit	Model
44-0565	44-0324	44-0317	44-0217	44-0326	1952-78
—	—	—	44-0089	44-0326	1977-78, Zinc
44-0566	—	—	44-0220	8715-4	1979-85
44-0643	9997-3	—	44-0220	9997-3	1986-99
44-0644	2040-4	—	44-0220	37-9032	2000-03
44-0126	2258-5	—	44-0127	2258-5	2004
44-0125	2257-4	—	44-0128	2257-4	2005-07
44-0801	—	—	44-0248	—	2008-up



Chrome Axle Kits include pike or acorn nuts. Fit 1979-2004 models. 3/4" diameter.

VT No.	Style
44-0664	Pike
44-0665	Acorn

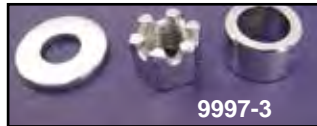
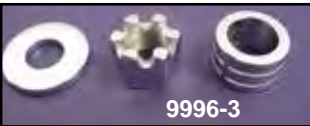

Chrome Rear Axle Spacer Kits include castle nut for axle and adjuster collars

Stock	Grooved	Years
2040-4	—	2000-03
9997-3	9996-3	1986-99
2258-5	—	2004
2257-4	—	2005
—	2483-4	2006-07
2510-5	—	2008-up

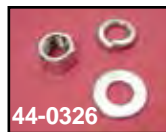

Rear Axle Nut and Washers fit 1952-79.

VT No.	Item	Finish	U/M
44-0326	Nut with washer	Chrome	Kit
37-8127	Nyloc-Nut	—	10 pack
44-0317	41598-52, Sportster 1952-77	Zinc	Each
44-0500	As Above	Chrome	Each



Rear Pike Axle Nut Cover Set fits 1993-2003.  
VT No. 2261-2

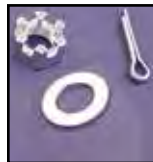

Chrome Rear Axle Nut Kit includes washer and cotter pin for rear axles on 1989-up models, replaces 7987, 511. 5/8 x 18 thread nut  
VT No. 37-9032



Chrome Rear Axle Spring Clip replaces 510 spring clip used on all 1991-up, 5 pack.  
VT No. 2042-5



Chrome Rear Axle Nut Kit is a custom hardware kit with installation instructions. Fits 1979-up.  
VT No. Type  
8606-6 Acorn  
8607-6 Cap

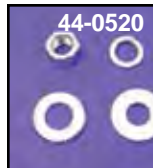

Chrome Rear Axle Nut and Washer Kit includes two extra thick washers, nut and lock washers for 1973-up, on square swing arms.  
VT No. Brand  
8715-4 Colony  
44-0520 V-Twin

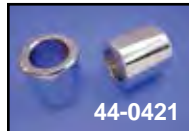

Rear Axle Spacers for XL.

VT No.	Year	Side
44-0324	1955-78	Left
44-0421	1982-85	Left (Pair)
44-0427	1986-99	Both
44-0422	1979-81	Left
44-0424	1979	Right
44-0810	2004-07	Right and Left



DIY Universal Axle Spacer is constructed of stainless steel 6" long with 3/4" inner diameter are 1 1/8" outside diameter, to be cut to length.  
VT No. 44-0670



**Rear Axle Adjuster Sets.**

- VT No. Years**  
**44-0334** 1979-84 with chrome end caps  
**44-0434** 2005-08  
**44-0234** 2009-up



**Rear Chain Adjusters** available in pairs with nuts. Fits 1952-78.

- VT No. Finish**  
**7703-2** Chrome  
**9020-2** Cadmium

# Wheel Adjuster



**Chrome Pyramid Axle Adjusters** includes nuts.

- VT No. Years Item**  
**44-0251** 1997-03 Blocks Only  
**44-0365** 1979-96 Complete Kit  
**44-0366** 1979-96 Blocks Only

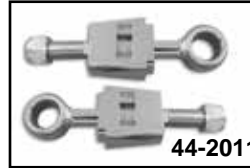

**Chrome Calibrated Rear Wheel Adjusters** feature pyramid blocks with sight indicator to view calibrated adjuster bolt, for accurate and easy wheel alignment. Adjuster bolt is 1/2" rod with micrometer markings. Fits 1979-96.

**VT No. 44-2011**

# Hub Rebuild



## 1955-78 XLH-XLCH

**XLCH-XLH Rear Hub Rebuild Kit** for use on all model steel hubs 1955-78, complete with all parts Illustrated, everything necessary to install in a bare hub!

**VT No. 44-0404**



**Hub Lock Nut Kit** includes correct locknut spacer and seal for rear. Fits 1955-78.

**VT No. 44-0412**

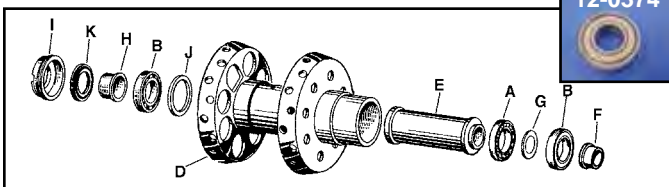

**Rear Hub Hardware** fits 1952-78.

- | VT No.         | OEM       | #   | Item                             |
|----------------|-----------|-----|----------------------------------|
| <b>44-0404</b> | Kit       | All | Complete Hub Rebuild             |
| <b>45-0401</b> | Cap       |     | Chrome Hub Cap                   |
| <b>12-0305</b> | 9008      | A   | Bearing without shield           |
| <b>12-0374</b> | 9009      | B   | Bearing with shield              |
| <b>44-0533</b> | 9851      |     | Grease Fitting, 10 pack          |
| <b>45-0301</b> | 41017-55C | D   | Complete Chrome Hub              |
| <b>44-0315</b> | 41185-63  | E   | Hub Spacer, each                 |
| <b>44-1999</b> | 41195-52  | F   | Brake side Washer 1954-62        |
| <b>44-0395</b> | 41195-63  | G   | Brake side Washer 54-62, 10 pack |
| <b>44-0392</b> | 41196-55  | H   | Seal Spacer, each                |
| <b>44-0529</b> | 41201-55  | I   | Locknut, Right Hand              |
| <b>44-0396</b> | 41205-52  | J   | Bearing Washer, 10 pack          |
| <b>14-0131</b> | 41210-55  | K   | Seal, 5 pack                     |



**2000-up Wheel Bearing** fits front and rear.

- | VT No.         | OEM  | U/M  | Size |
|----------------|------|------|------|
| <b>12-0592</b> | 9267 | Each | 3/4" |
| <b>44-0993</b> | 9267 | Pair | 3/4" |
| <b>12-0390</b> | 9247 | Pair | 1"   |
| <b>12-0631</b> | 9276 | Pair | 25mm |



**Front Internal Hub Kit** includes all internal parts for complete rebuilding of all alloy front hubs. Includes inner spacer, bearings, races seals and seal spacer matched for each year group. Hub is not included.

- | VT No.         | Type      | Fits                |
|----------------|-----------|---------------------|
| <b>44-0403</b> | Drum      | 1964-72 XL-XLH      |
| <b>44-0311</b> | Drum      | Tube Spacer         |
| <b>44-0556</b> | Drum      | Dust Shield         |
| <b>12-0906</b> | Drum      | Snap Ring for Above |
| <b>44-0402</b> | 10" Disc  | 1973-only XL        |
| <b>44-0401</b> | 11" Disc  | 1974-77 XL          |
| <b>44-0400</b> | Dual Disc | 1977-83 XL          |
| <b>44-0537</b> | 11" Disc  | 1984-91 XL          |
| <b>44-0611</b> | 11" Disc  | 2000-07 XL          |



**Rear Double Row Retro** fit wheel bearing kits for models with bearings. Double row wheel bearings eliminate wheel play, have a longer wear life, require no adjustment. Kit includes two bearings, center spacer and spacers.

- | VT No.         | Item             | Year    |
|----------------|------------------|---------|
| <b>44-2995</b> | Kit              | 1991-99 |
| <b>44-0921</b> | Bearing Set Only |         |
- Replica Type**
- | VT No.         | Fits | Year    |
|----------------|------|---------|
| <b>44-0991</b> | Kit  | 2000-04 |
| <b>44-0992</b> | Kit  | 2005-07 |
| <b>44-0994</b> | Kit  | 2008-up |



**Rear Hub Rebuild Kits** include all parts pictured less hub and internal bearing spacer. Fits 1979-up.

- | VT No.         | Fits    | Wheel Type   |
|----------------|---------|--------------|
| <b>44-0460</b> | 1979-81 | Cast or Wire |
| <b>44-0461</b> | 1982-85 | Cast only    |
| <b>44-0462</b> | 1982-85 | Wire only    |
| <b>44-0453</b> | 1986-99 | Cast or Wire |

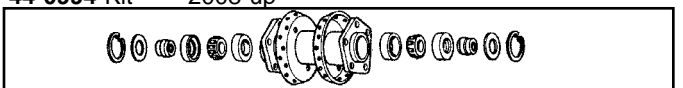

XL





# Front Wheel Assembly for 35 and 39 mm Fork

Wheel Builders



Since 1969

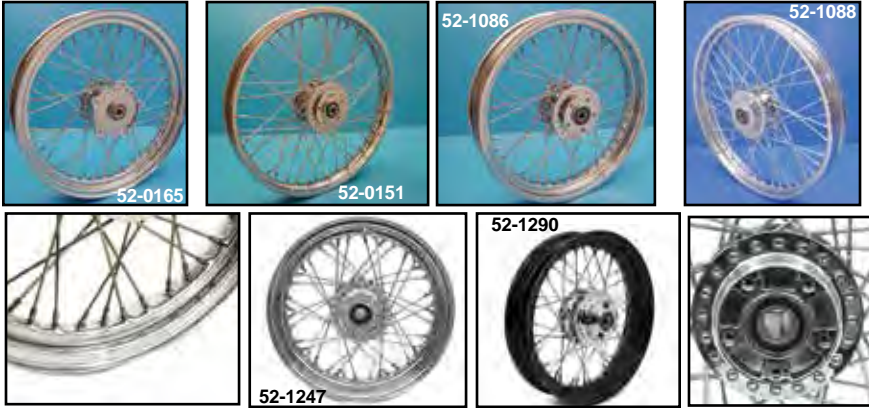

2008-up XL with 39mm forks without ABS.

52-2035	—	19" Drop Center	2.50"
52-2036	—	21" Drop Center	2.15"
52-1030	—	23"	3.00"

2015-up XL with ABS.

52-2051	—	19" Drop Center	2.50"
52-2052	—	21" Drop Center	2.15"

2010-up Model "48" without ABS

52-1247	—	16"	3.00"
52-1290	Black	16"	3.00"
52-1031	—	23"	3.00"

Front Wheels on this page feature a chrome hub, unless noted as satin, with all internal bearings installed, choice of chrome or stainless spokes and chrome rim completely laced and trued.

Chrome Spokes	Stainless Spokes	Rim Diameter	Rim Width
---------------	------------------	--------------	-----------

1973 Only XL with single disc. Fits 35mm forks.

52-0158	—	19" Drop Center	2.50"
52-0174	—	21"	1.85"

1974-77 XL Clover Type with single disc. Fits 35mm forks.

52-0165	52-0817	19" Drop Center	2.50"
52-0161	—	21"	1.85"

1974-77 XL Clover Type with single disc satin hub. Fits 35mm forks.

52-0187	52-0188	19" Drop Center	2.50"
52-0189	—	21"	1.85"

1978-83 XL with dual disc. Fits 35mm forks.

52-0155	52-0818	19" Drop Center	2.50"
52-0151	52-0819	21"	2.15"
52-1025	—	23"	3.00"

1984-99 XLH-XL with single/dual disc. Fits 35 and 39 mm forks.

52-0170	52-0827	19" Drop Center	2.50"
52-0171	52-0828	21"	2.15"
52-1024	—	23"	3.00"

1984-99 XLH-XL with single disc. Fits 35mm and 39mm forks.

52-0190	52-0192	19" Drop Center	2.50"
52-0191	52-0193	21"	2.15"
52-1024	—	23"	3.00"

2000-07 XL with 39mm forks and 3/4" axle, XL Standard Hugger

52-1086	52-1087	19" Drop Center	2.50"
52-1088	52-1089	21"	2.15"
52-2023	52-2024	21" Dual Disc	2.15"
52-1212	—	23"	3.00"

## Twirled Spoke Wheels



Twirl Spoke Detail

Wheels with Twirled Spokes include a chrome hub with internals, rim and twirled chrome spokes assembled.

VT No.	Fits	Type	Width
<b>Front</b>			
52-0845	1984-99	19" Dual	2.50"
52-0973	2000-07	19" Dual/Single	2.50"
52-0943	1984-99	21" Dual/Single	2.15"
52-0974	2000-07	21" Dual/Single	2.15"
52-0860	1974-77	19" Single	2.50"
52-0846	1977-83	19" Dual/Single	2.50"
52-0944	1977-83	21" Dual/Single	2.15"
<b>Rear</b>			
52-0177	1982-85	16"	3.00"
52-0865	1954-78	16"	3.00"
52-0883	1979-81	16"	3.00"
52-0842	1986-99	16"	3.00"
52-0851	As Above	16"	4.00"
52-0976	2000-2004	16"	3.00"
52-0978	2000-2004	16"	4.00"

## Model "48" Conversion



16" Rear Chrome Profile Laced Wheel fits 2005-07 XL 883C and XL 1200C models. VT No. 52-0665



Rear Chrome 3 Spoke 16" Cast Wheels include bearings and spacers. Fits 2000-2004. VT No. 52-1015

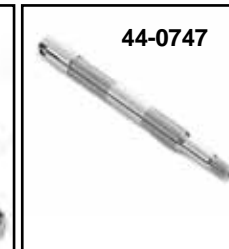

Model "48" Components to install 16" wheel on XLH models.

VT No.	Item
24-1037	Tree Set
44-0747	Axle
52-1247	Wheel
50-1215	Raw Fender

# Rim and Spoke

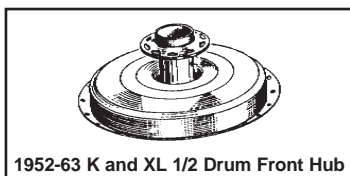
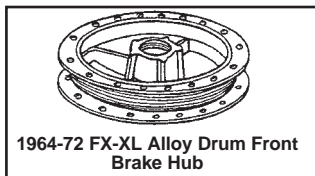

Above Hubs are shown for reference only

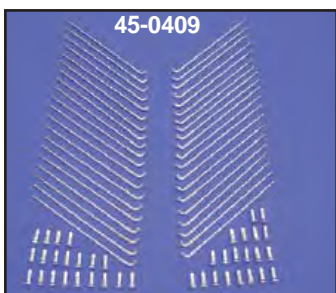

Wheel Builders



# Rear Wheel Assembly



Since 1969

Wheels for Sportster models are laced, trued and include bearings installed. 3.0 rims accept 130-140 tire, 4.0" and 4.5" accept 150-180 tires



Wheels for Sportster.

K & XL Rim and Spoke Application Chart.						
Front Rims					Recommended Spoke Sets	
V-Twin	Fits	Size	Type /Finish	Chrome	Stainless	
52-0946	52-56 K	18"	Steel/Chrome	—	45-0708	
52-1018	52-56 K 57-59 XL	18"	Steel/Chrome	—	—	
52-0969	52-56 XL	19"	Steel/Chrome	—	45-0707	
52-0977	64-72 XL	19"	Drop Center/Chrome	45-0622	45-0657	
52-0965	64-72 XL	19"	Steel/Chrome	45-0604	45-0658	
52-0700	73-up XL	19"	Drop Center/Chrome	45-0631	45-0714	
Rear Rims					Recommended Spoke Sets	
52-0707	65-78 XL	18"	Drop Center/Chrome	45-0610	45-0656	
Front or Rear Rims					Recommended Spoke Sets	
52-1023	10-up XL	16"	Drop Center/Black	45-0722	—	

Chrome Spokes	Stainless Spokes	Rim Diameter	Rim Width
<b>1954-78</b>			
52-0172	52-0807	16"	3.00"
52-0142*	—	16"	4.00"
52-0884	52-0885	18"	2.15"
52-0890	52-0891	18"	2.50 Drop Center
*Note: For Rigid Frame			
<b>1979-81</b>			
52-0167	52-0808	16"	3.00"
<b>1982-85</b>			
52-0168	52-0809	16"	3.00"
<b>1986-99</b>			
52-0176	52-0810	16"	3.00"
52-0861*	52-0862*	16"	3.00"
52-0935*	52-0936*	16"	4.00"
52-0775	—	18"	4.50"
<b>2000-2004</b>			
52-1080	52-1082	16"	3.00"
52-1081	52-1083	16"	4.00"
52-0777	—	18"	4.50"
<b>2005-2007</b>			
52-1099	52-1098	16"	3.00"
52-0665	—	16"	3.00"
52-0913	52-0912	16"	4.00"
52-0779	—	18"	4.50"
<b>2008-up</b>			
52-0789	—	16"	3.00"
52-1246	—	16" Black Rim	3.00"
<b>2015-up with ABS</b>			
52-2053	—	16"	3.00"

\*Note: Deluxe Wheels feature RDC Rim.

XL





# Hustler Series 1952-78



47-0462



47-0578



47-0575



47-0570

VT No.	Style/Color
47-0462	Black Flame
47-0590	Teal Flame
47-0582	Aqua Flame

VT No.	Style/Color
47-0578	Purple Flame
47-0575	Yellow Flame
47-0570	Red Flame

47-0856 47-0852 47-0470



**Invictor Gunfighter Saddles** feature sewn inlay of colored flames on rear pad area with matching flame stitch and thread in front driver area. Original style includes textured top panel in driver area and silver chrome accent to separate the driver and tail area.



**Chrome Rear Seat Tab.** Fits 1979-96.  
VT No. 31-4018



47-0864

**Invictor Flatlander Saddles** feature low frame hugging design.

2007-up	2004-06	Style
47-0884	—	Cobra
—	47-0864	Button



47-0875

**MKI Invictor Series Seat** features Naugahyde construction as noted, fits 2004-06.  
VT No. 47-0875



47-0990

**Invictor Series Saddles** fit 2004-06 XL models.

VT No.	Type
47-0990	Bucket
47-0861	Smooth

2004-06	1979-03	Color/Style
47-0851	—	Black Flame
47-0856	—	Yellow Flame
47-0855	—	Purple Flame
47-0857	—	Orange Flame
47-0852	—	Teal Flame
47-0854	47-0470	Aqua Flame



**Seat Mount Pins** available as quick release push pin in stainless steel in natural finish with O-Ring and extra stud. Thread into existing seat mount hole with 1/4 - 28 threads. Replacement pin available for 37-8902.

VT No.	#	Type
37-8902	A	Quick Release with Pin
37-9179	B	Chrome Knob
31-0348		Kit



47-0866 Installed

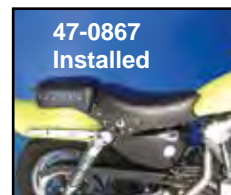

47-0867 Installed



47-0868 Installed

**Invictor Smoothie Saddles** are a solo and pad on a single piece steel baseplate.

Original	Original Leather	Chrome Spot	Black Spot	Year
47-0866	47-0865	47-0867	47-0868	2004-06

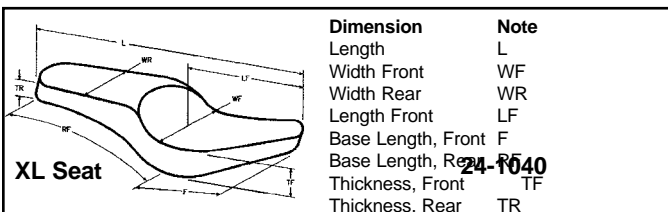

47-0270

**Voyager Series** for 2004-up XL's feature full comfort design for the longest ride.  
VT No. 47-0270



# Solo for XL Frame Mount Type

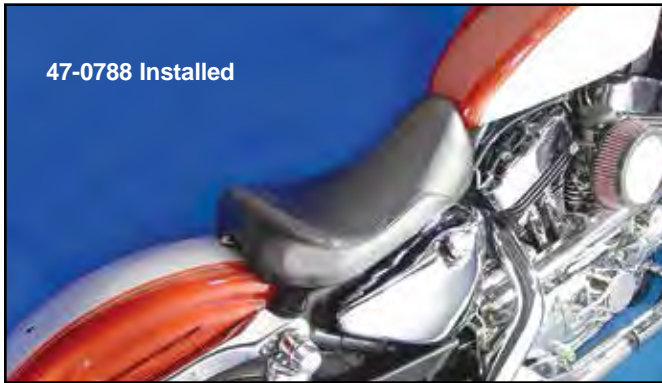

47-0788 Installed



**Leather Solo Saddles** are frame mounted to fit stock 2004-06 models.  
VT No. 47-0756



**Classic Black Solo** features premium Naugahyde with skirt decorated with midnite spots, order seat pad or fender tail available separately. Fits 2004-06  
VT No. 47-0881

Spring Mount Leather Solos and Mount Kits are listed in the Multi Fit section.



31-0213



31-0439

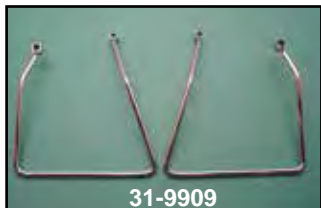

31-9909



31-9924



31-9951

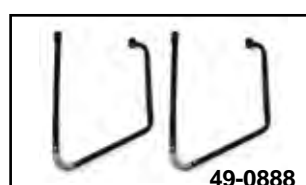

49-0888

**XL Chrome Saddlebag Supports** are designed to fit the contour of the fender struts and protect your bags from the brake caliper and swing arm.

VT No.	Year	Note
31-0213	1952-78	
31-0439	1979-81	
31-9909	1982-93	1
31-9924	1994-03	2
31-9951	2004-up	
49-0888	Black	All
49-0889	Chrome	All



49-0889

**Note 1:** Requires 31-9913 Signal Relocation Kit for 1982-89 models. Require signals to be moved to rear fender strut mounting hole.

**Note 2:** Requires 31-9925 Signal Relocation Kit



47-0723

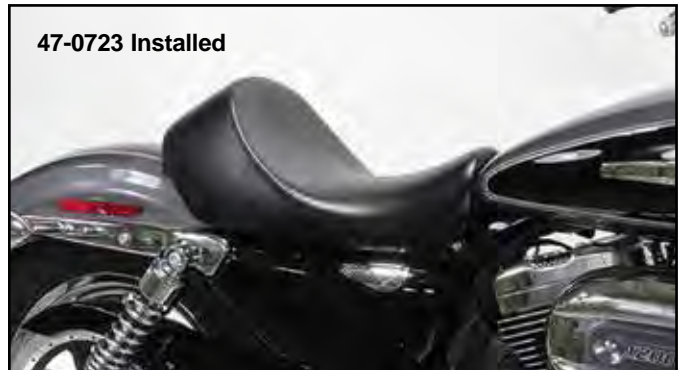

47-0723 Installed



47-0789 Installed

**Contour Solo Seat** fits XL models and bolts on.

VT No. Year

47-0788 1982-03

47-0723 2004-up

47-0789 2004-06, 2010-14

## Saddlebag Support



31-9913



31-9925

**Directional Signal Relocation Kits** includes special hardware and extension for models listed to provide clearance for saddle bags.

VT No.	OEM	Fits
31-9913	90504-82A	1979-89
31-9925	68471-94A	1994-2003





# Solo



47-0134 shown with 50-0246 luggage rack



Bates Style Solo VT No. 47-8655 Shown Mounted



47-0131



**Leather Solo Seat Kits** for XL models includes K-model seat, chrome 2" springs and mount hardware. 47-0134 includes frame cover.

VT No.	Item	Cover
47-0131	1952-78	—
47-0132	1979-81	—
47-0133	1982-2003	42-0979
47-0134	2004-06	Included



47-0130 Installed



**Rigid Frame Solo Seat and Mount Kit** includes chrome 3" hairpin springs. Mount kit and seat are also sold separately.

VT No.	Item
47-0130	Seat Kit
31-0608	Mount Kit Only
47-0110	Replica Seat Only



47-0119 Installed

**Rigid Seat Kit** includes 3" springs and solo seat.

VT No.	Item
47-0119	Seat Kit
31-4043	Mount Kit Only
47-0110	Seat Only



47-0152



**Black Solo Seat Kit** fits Big Twin and XL Rigid frames. Includes mount kit with hair pin springs included.

VT No. 47-0152

# Luggage Rack



50-1018 Installed



50-0589



50-0847

**Chrome Bolt On Luggage Racks** mount to rigid side straps of sissy bar for 2004-up XL's.

**VT No. Item**

50-0589 Rack

50-0847 Side Plates



50-2015



50-1550

**Detachable Luggage Rack** fits 2004-up XL models. Order hardware and latch kit separately.

**VT No. Item**

50-1550 Rack

50-1622 Mount Kit

50-1564 Cpt Kit w/hardware & latch

50-1558 Latch Kit



50-0235 Installed



50-1527



50-1558



50-1559



31-1304



31-1315



50-1512

**Docking Hardware** fits 2004-up XL.

**VT No. Item**

50-1527 Stud Set for Detachable Saddlebags Only

50-1558 Rotary Latch Kit, chrome

50-1559 Rotary Latch Kit, black

31-1304 Bushings (2), wide style, rubber between chrome ends

31-1315 Bushing Set, rubber installed between chrome ends

50-1512 Stainless Steel Bushing Set (4)



50-0239 Installed



50-0239



50-0246 Installed



16-0746



16-0746

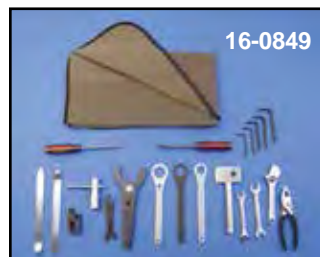

16-0849



16-0846

**Chrome Luggage Racks** for XL's measure 6" x 8" for fender mounting and for loads of 10 pounds or less.

VT No.	Fits	Seat
50-1018	1979-2003	Two Passenger
50-2015	1994-2009	Solo
50-0235	1985-2003	Solo
50-0239	2004-2009	Stock Solo
50-0246	2004-up	Stock Solo

**Tool Kits** for XL models.

**VT No. Year**

16-0849 1957-70

16-0846 1977-84

16-0746 1986-up





**national cycle**  
**Windshield**



**Low Boy Heavy Duty.** Light tint D.O.T. approved hardware sold separately. Fits 1957-up. For 35mm Fork Legs order VT No. 28-0335 bushings **in addition** to mounting kit.

VT No.	Item
51-0330	Shield
31-9930	Mounts
28-0335	Rubber Bushing

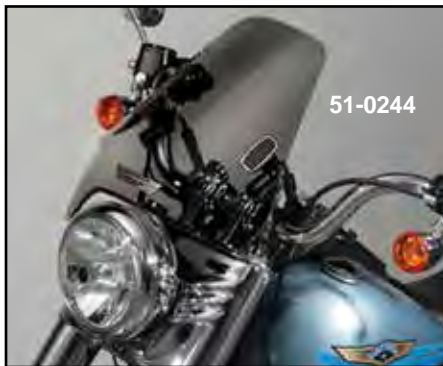

**Deflector Screen Lexan.** Features Rake Adjust and Quickset hardware. Super tough Lexan hardcoated polycarbonate. Fits all 1957-up.

**Size:**  
H: 14¾"  
W: 15"

**Light or medium tint. DOT and TUV approved. Hardware packaged with windshield.**

VT No.	Tint
51-0244	Medium
51-0245	Light



**Ranger Heavy Duty.** Low Profile and narrow proportions. Light Tint, DOT and TUV approved. Approved for night use. Hardware sold separately. Fits all 1957-up XL. Mounting Kit VT No. 31-9930 required. For 35mm Fork Legs order VT No. 28-0335 bushings **in addition** to mounting kit.

**Size:**  
H: 13½"  
W: 16½"  
VT No. 51-0246



**National Cycle Wave QR Windshield** manufactured from dark tint polycarbonate that features free flowing lines, adjustable rake partitioning and quick release mounting. Order mounting hardware separately. Fits 1996-up XL.

**VT No. Mounting Hardware**  
51-0283 31-9936



**Streetshield.** Contoured to enhance wind protection. Features 4 point ball socket mount. Fits 1957-up XL.

**Size:**  
H: 17"  
W: 16½"

VT No. 51-0324 Smoke



**Streetshield Ex.** Features 4 point ball socket mount with Quikset hardware.

**Size:**  
H: 18"  
W: 19¼"

**DOT approved.**  
VT No. 51-0325 Smoke  
Fits all: XL 1957-2000



**Custom Heavy Duty.** Taller and slightly wider than the Ranger. A trim and lean custom look. Light Tint, DOT approved. Approved for night use. Hardware sold separately. Fits all 1957-up XL. Mounting Kit VT No. 31-9930 required. For 35mm Fork Legs order VT No. 28-0335 bushings **in addition** to mounting kit.

**Size:**  
H: 19" to 21"  
W: 18¾"  
VT No. 51-0248

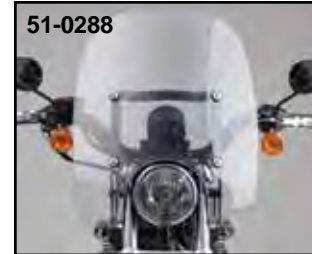

**National Cycle Spartan Quick Release Windshield** features a full size quantum clear hand coated polycarbonate windshield, quick release hardware and a black powder coated mounting frame. Available in 16¼" and 18½" heights which is measured from head lamp cut-out to top of shield.

VT No.	Height	Fits	Mounting Hardware
51-0288	16¼"	1996-10	31-9936
51-0289	18½"	1996-10	31-9936



**Flyscreen LS.** Small windshield with a very custom appearance. Triple chrome front plate. Flush counter sunk hex bolts. Fits all 1957-up.

**Size:**  
H: 8½"  
W: 9¾"

**DOT and TUV approved. Approved for night use. Hardware packaged with windshield.**

VT No. 51-0243 Bronze Tint Bracket Set fits 1957-78 XL.  
VT No. 49-0879

# Multi Fit/Chopper Index

<b>B</b>	
<b>BELT BUCKLES</b> .....	<b>1325</b>
<b>BRAKE</b>	
Caliper Kit(Spring Fork).....	1220
Master(Front).....	1053
Pedal Pads.....	1069
<b>BULLET LAMPS</b> .....	<b>1152,1153</b>
<b>C</b>	
<b>CHAIN</b>	
Master Link.....	1055
Primary.....	1054,1055
Rear.....	1055
<b>CIGARETTE LIGHTER</b> .....	<b>1171</b>
<b>CLUTCH CONTROL</b>	
Lever.....	1045,1048,1052
<b>COIN HOLDER</b> .....	<b>1031</b>
<b>D</b>	
<b>DECAL</b> .....	<b>1051,1209</b>
<b>DOCKING HARDWARE</b> .....	<b>1062</b>
<b>E</b>	
<b>EMBLEM</b> .....	<b>1206,1208-1209</b>
<b>F</b>	
<b>FENDER</b> .....	<b>1219,1220,1228-1229</b>
Brace.....	1227
Front.....	1219,1220,1228
Lamp.....	1129,1131-1132,1169
Pads(Seat).....	1239,1240
Rear.....	1229,1230
Spring Fork.....	1220
<b>FILTER</b>	
Fuel.....	1199
<b>FOOTBOARD</b> .....	<b>1076-1082</b>
<b>FOOTPEG</b> .....	<b>1058-1060,1063-1068</b>
.....	<b>1070-1075</b>
Extended.....	1056,1068
Folding.....	1066
Heel Rest.....	1059,1060
Mount(Replica).....	1056,1057,1058,
.....	1059,1074
Relocate.....	1051,1074,1075
Shifter.....	1061,1064,1067,1068
Stirrup.....	1059
<b>FORK COVER</b> .....	<b>1094</b>
<b>FRAME</b> .....	<b>1222-1225</b>
Protective Tubing.....	1223
<b>FUEL</b>	
Filter.....	1199
Gas Cap.....	1202-1207,1232
Hose.....	1201
Line.....	1200,1201
Petcock.....	1196-1198
Shut Off.....	1199
<b>G</b>	
<b>GAS</b>	
Cap.....	1202-1207,1232
Decal.....	1209
Emblem.....	1208,1209
Line/Hose.....	1200,1201
Petcock.....	1196-1198
Shut Off.....	1199
Tank.....	1231-1234,1235
Tank Trim.....	1209
Weld On Pieces.....	1223
<b>GRIP</b> .....	<b>1083-1090</b>
<b>H</b>	
<b>HANDGRIP</b>	
By Wire.....	1084
Leather Cover.....	1086

<b>HANDLEBAR</b> .....	<b>1023-1031</b>
Accessory.....	1031
Controls/Switch.....	1044-1051
Cover.....	1091
Damper.....	1039
End Plugs.....	1090
Riser.....	1032-1040
Wiring.....	1050,1051
<b>HEADLAMP</b> .....	<b>1091-1093,1095-1109</b>
Bates.....	1099
Bracket.....	1101,1104,1108,1109
Bulb.....	1093,1100,1106,1107
Connector.....	1096
Cowl.....	1091,1095
Cycle Ray.....	1105
Fork Cover Set.....	1094
HID.....	1109
Internal.....	1091,1101
Rim.....	1091,1092,1093,1095,1105
Spring Fork.....	1104
Visor/Trim.....	1094,1095,1101,
.....	1102,1106,1107,1152,1165
<b>HIGHWAY BAR</b> .....	<b>1056,1058</b>
<b>HORN</b> .....	<b>1170-1175</b>
<b>HOSE</b> .....	<b>1200-1201</b>
<b>INDICATOR LAMP</b> .....	<b>1101,1168</b>
<b>INSPECTION TAG</b> .....	<b>1120</b>
<b>K</b>	
<b>KROMMET</b> .....	<b>1145,1146,1147</b>
<b>L</b>	
<b>LAPEL PINS</b> .....	<b>1324,1327</b>
<b>LENS</b> .....	<b>1137-1138,1150,1151,1153,1158</b>
<b>LEVER</b> .....	<b>1041,1042,1043,1044,1045</b>
<b>LICENSE PLATE</b> .....	<b>1142-1146</b>
<b>LIGHT BAR</b> .....	<b>1153</b>
<b>LIGHTS</b> .....	<b>1091-1169</b>
Bar.....	1153
Bulbs.....	1106,1107,1114,
.....	1140-1141,1168
Fender.....	1129,1131-1132,1169
Gasket.....	1165
Headlamp.....	1091-1093,1095-1109
Indicator.....	1101,1168
Marker.....	1148-1151,1150,1154
Reflector.....	1166
Signal.....	1155-1164,1220
Spotlamp.....	1110-1115
Tachometer/Speedometer.....	1168
Tail Lamp.....	1116-1138
Turn Signal.....	1155-1164
<b>M</b>	
<b>MARKER LAMP</b> .....	<b>1148-1151,1154</b>
<b>MASTER CYLINDER</b>	
Cover/Gasket.....	1052
Front.....	1053
Rebuild.....	1053
<b>MIRROR</b> .....	<b>1176-1195</b>
Extension Kit.....	1195
Indian.....	1191
Lighted LED.....	1178,1183
Metric Adaptor.....	1195
Split Vision Mirror.....	1186
Stem.....	1191,1192
<b>P</b>	
<b>PATCHES</b> .....	<b>1323,1326</b>
<b>PEDAL PAD</b> .....	<b>1069</b>
<b>PEG</b> .....	<b>1085-1068,1070-1075</b>
<b>PETCOCK</b> .....	<b>1196-1198</b>
<b>O</b>	
<b>OIL LINE</b> .....	<b>1200-1201</b>

<b>R</b>	
<b>REFLECTOR</b> .....	<b>1166</b>
<b>REGISTRATION TAG</b> .....	<b>1120</b>
<b>RISER</b> .....	<b>1032-1040</b>
Spring Fork.....	792
Top Clamp.....	1034,1219
<b>S</b>	
<b>SEAT</b> .....	<b>1235-1258</b>
Buddy.....	1253,1254
Mounts.....	1241,1242,1243
Police Style.....	1249,1250,1251,1252
Rear Pads.....	1239,1240
Rigid.....	1235,1246
Solo.....	1236-1238,1241,1243,1244
.....	1245,1246,1249-1250
Springs.....	1255,1257,1258
Tee.....	1240,1241,1255,1256
<b>SHIFTER PEG</b> .....	<b>1061,1066,1067,1068</b>
<b>SIGNAL</b> .....	<b>1155-1167</b>
<b>SISSY BAR</b> .....	<b>1227</b>
<b>SISSY BAR/PAD</b> .....	<b>1227,1240</b>
<b>SKULL STUFF</b> .....	<b>1017-1022</b>
<b>SPOOL WHEEL</b> .....	<b>1218</b>
<b>SPOTLAMP</b> .....	<b>1110-1115</b>
Bulbs.....	1114
<b>SPRING FORK</b> .....	<b>1219-1221</b>
Caliper Kit.....	1220
Fender.....	1220
Horn.....	1174
Lamp.....	1104
Tree/Riser.....	1221
Wide.....	1219
<b>SWITCH</b> .....	<b>1047,1048,1049</b>
Repair.....	1051
<b>T</b>	
<b>TAIL LAMP</b> .....	<b>1116-1138</b>
Assemblies.....	1116-1128,1138
Bulb.....	1141
Connector.....	1141
Fender Mt.....	1117,1129,1131,1132
Lens.....	1137-1139
License Bracket.....	1137,1142
Side Mount.....	1120-1128
Tombstone.....	1134,1135
Vintage.....	1132-1134,1137
Wiring.....	1128
<b>THROTTLE(Internals)</b> .....	<b>1083</b>
<b>TIRE</b> .....	<b>1210-1216</b>
Tube/Repair.....	1217
Weights.....	1217
<b>TOOL BOX</b> .....	<b>1226</b>
<b>TOP TREE</b> .....	<b>1231</b>
<b>TOPPERS</b> .....	<b>1147</b>
<b>TRAFFIC LIGHT SENSOR</b> .....	<b>1167</b>
<b>TUBE</b> .....	<b>1217</b>
<b>TURN SIGNAL</b> .....	<b>1155-1167</b>
Canceler.....	1166,1167
Equalizer.....	1166,1167
Flasher.....	1166
Gasket.....	1165
Mount.....	1162,1163,1164
Relocate.....	1162,1163
<b>V</b>	
<b>VISOR</b> .....	<b>1096,1101,1102,1103</b>
.....	<b>1106,1110,1137,1138,1158,1165</b>
<b>W</b>	
<b>WHEEL</b>	
Spool.....	1218





# SKULL STUFF



Close Up  
Skull End



26-2189

**Skull Contour Levers** in chrome feature skull ends.

Chrome	Black	Fits
26-2172	—	1972-81
26-2111	26-2162	1982-95
26-2189	26-2109	1996-up
—	26-1186	2008-up
26-0119	—	2004-13 XL
—	26-0118	1996-14



**Chrome Skull Contour Brake and Clutch Hand Lever Set** fits 1996-2007 FLST, 1996-2007, 1996-2007, 1996-2003. **VT No. 26-0787**



26-2111

**1982-95 Chrome Clutch and Brake Lever Set** features a girder design with skull end. **VT No. 26-2111**



**Stainless Skull Medallion** fits fender end. **VT No. 50-1137**



42-5041

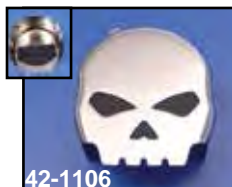

42-1106



42-1174

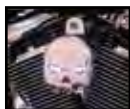

**Chrome Skull Horn Covers.**

VT No.	Fits
42-5041	1993-up All
42-1174	1993-up (LED)
42-1106	1976-84 FX



42-1036



42-1526

**Chrome Skull Horn Round Cover** fits 1991-up Softail.

VT No.	Fits
42-1036	1993-up XL
42-1526	1993-up Big Twin



**Skull Air Cleaner Cover** fits 34-0948 tapered filter units. **VT No. 34-0280**



**Idle Skull Adjustment Screw** fit CV carburetor cables include housing as shown. **VT No. 35-0793**



23-0832



23-0833



23-0834



23-0835



23-0837

**Stainless Brake Disc** with skull engraving.

VT No.	Year	Type	Finish
23-0832	1984-99	Front	Stainless Steel
23-0833	1984-99	Front	Polished
23-0834	1984-99	Rear	Polished
23-0835	1984-99	Rear	Stainless Steel
23-0836	2000-up	Rear	Stainless Steel
23-0837	2000-up	Rear	Polished Stainless Steel



**Chrome Dash Mount Stud Kits** include stud, nuts, nylon washer and either skull or acorn nut, Fits 1968-up cast dash panel on FXST-FL-FXWG when choke cable is not used.

VT No.	Type
37-9122	Skull
37-0573	Stud only

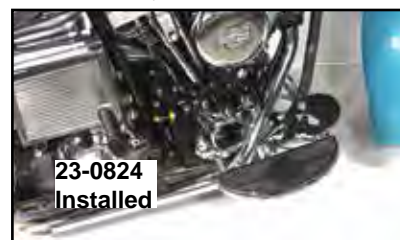
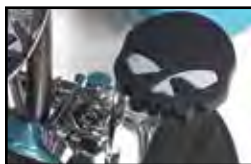

23-0824  
Installed



23-0823  
Front Back



23-0824  
Front Back

**Skull Pedal Pad** is constructed of neoprene. Sold each.

VT No.	Type
23-0823	FXST
23-0824	FLST-FLH



**Skull Side Hinge Electronic Switch** features round key set and side hinge. Fits 1996-10 Softail. **VT No. 32-0987**



27-0478

**Skull Mini Footboards** are fully adjustable foot pad is full rubber on foot surface with chrome design on back side. **VT No. 27-0478**

# Mirrors

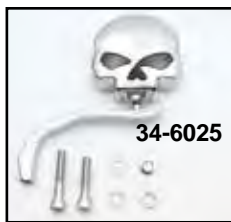

**Skull Mirrors**  
feature offset stems.  
**VT No. Stem**  
**34-6025** Worm  
**34-6024** Wing



**Skull Billet Mirror** fits right or left side complete with stem.

VT No.	Skull	Stem
34-6022	5	Worm
34-1565	3	Wing
34-1564	3	Worm



**Skeleton Hand Mirror Set** with bone shaped stems.

VT No.	Type
34-0782	Chrome
34-0783	Gold Inlay
34-0784	Black



**Chrome Skull Mirror Set** with bone stem includes right and left sides. Additional hardware is included for installation on metric bikes. Stem is 4" long and is adjustable. Features black eyes.  
**VT No. 34-1274**



**Universal Skull LED.** LED marker lamp set is a 3 or 4 wire type for use as a brake light or marker lamp. These can be installed in any flat panel such as saddlebags, tourpaks or fender surface. Features threaded back with aluminum panel mounting nut. Requires a 2-1/8" hole for mounting. Sold in pairs.

VT No.	Style	Finish
33-0065	3-Wire	Chrome
33-0074	4-Wire	Red



**Decorative Skull Emblem** for fender.  
**VT No. 48-0250**

# SKULL STUFF



**Round Skull Mirror Set** is 3 9/16" diameter features bone stem, pair. Set includes right and left.

**VT No. 34-0367**



**Skull Mirror** includes 2 length stems to fit right or left side.

**VT No. 34-0111**



**Skull Teardrop Mirror Set** include stems. Includes left and right.

**VT No. 34-0759**



**Chrome Billet Pork Chop Mirror set** with 3-skull tribal billet stems. Set includes left and right sides.

**VT No. 34-1230**



**Gothic 3 Skull Mirrors** with billet stems, sold as pairs, fit right and left.

**VT No. 34-0760**



**Skeleton Arm Mirror Sets.**

VT No.	Finish
34-0072	LED Turn Signal





# SKULL STUFF



34-0831



34-1284

**Axel's Chrome Skull Billet Air Cleaners** fit to CV carburetors. Order mount kits separately. Bracket listed features built in breather passage and includes bolts for Evolution and TC-88 models.

**VT No. Model**

34-0831 Skull with circle

34-1284 Skull without circle



**Skull Air Cleaner** fits 1993-99 FXST, FLST, FXD, FLT, 1993-94 FXR.  
**VT No. 34-1506**



34-0843



34-0844

**Skull Air Cleaners** fit CV models.  
**VT No. Finish**  
34-0843 Chrome  
34-0844 Black



34-0050



34-0051

**Raised Skull Air Cleaner Inserts** features a chrome insert with raised black skull design. Available for 7" and 8" air cleaner assemblies.

**VT No. Model**

34-0050 7" TC

34-0051 8" Evolution



44-0812

**Chrome Softail Rear Frame Skull Covers** bolt onto cover axle adjuster area on all Softail frames 1986-99. Hardware and instructions included.

**VT No. 44-0812**



42-0084



42-0081



42-0075



42-0091



42-0092



42-0578



42-0562



42-1057



42-0084 Installed



42-1524



42-0464



42-0065



42-1177

## Chrome Skull Design Points and Derby Cover.

VT No.	Year	Type	Model
42-0084	1971-2003	Points	XL
42-0081	1970-98	Points	XL & Big Twin
42-1176	2004-up	Points	XL
42-0075	1999-up	Points	TC-88
42-1524	1971-05	Points	XL
42-0464	2004-up	Points	XL
42-1177	1971-03	Points	XL, vertical
42-0091	1970-98	Derby	Big Twin
42-0092	1999-up	Derby	Big Twin



42-0461



42-1524

**Wyatts Carbon Fibre Skull Mesh** on chrome points covers.

VT No.	Type	Model
42-0461	5-Hole	TC-88
42-0464	2-Hole	1970-99 Big Twin 2004-up XL
42-1524	2-Hole	1971-03 XL

# SKULL STUFF



**Krommets** feature 1/4 — 20 studs unless noted for decorative mounting. Available in 5 packs unless noted.

- | VT No.  | Item  |
|---------|---|
| 37-9076 | Chrome Skull                                    |
| 37-9077 | Gold Skull                                      |
| 37-2999 | Chrome Skull, large, 5/16 — 18, no stud         |
| 37-9096 | Chrome Skull, large 1/4 — 20, stud              |
| 37-9297 | Chrome Skull large 5/16 — 18, stud              |
| 37-9218 | Skull Valve Stem Cover, pair                    |
| 37-1529 | License Plate Skull Chrome Small, 1 1/8 x 1 1/8 |
| 37-1530 | License Plate Skull Chrome Large, 1 1/4 x 1 1/4 |



- Skull Krommets** feature LED eyes, pair.
- | VT No.  | Color       |
|---------|-------------|
| 33-0856 | Amber       |
| 33-0857 | Red         |
| 37-0950 | Cross Bones |



- Large Krommet Sets**
- | VT No.  | Type        |
|---------|-------------|
| 48-1622 | Skull/Motor |
| 48-1620 | Skull       |
| 48-1621 | Skull/Star  |



**Clear Skull Face Tombstone Lamp** features die cast construction with LED board.

VT No. 33-0205

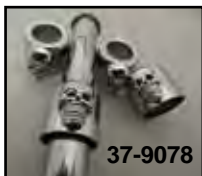

**Skull Pushrod Cover Cups** feature die-cast construction in chrome or gold, set of four.

- | VT No.  | Item        |
|---------|-------------|
| 37-9078 | Chrome cups |
| 37-9079 | Gold cups   |



**Skull Style License Bolt Set.**  
VT No. 37-1960



**Skull Cateye Taillamp** feature classic oval design with skull lens, 12 Volt.

- | VT No.  | Type |
|---------|------|
| 33-0587 | Bulb |
| 33-0031 | LED  |



**Skull Medallion** included 1/4" mounting stud.  
VT No. 37-1532



**Deco Skull** has 1/4" -20 thread for mounting.  
VT No. 48-0302



**33-0313 Chrome Tombstone Taillight** includes skull rim lens grill. Kits include die cast chrome taillamp license plate bracket &

chrome plated steel adapter plate which will mount to all Big Twin stock rear fenders, replaces original style lamp.

- | VT No.  | Item                      | Fits    |
|---------|---------------------------|---------|
| 33-0313 | Tail lamp with Rim Custom |         |
| 33-0190 | Kit                       | 1973-98 |
| 33-0191 | Kit                       | 1999-up |



**Skull Rim** is available with or without blue dot fits early style tombstone tail lamps 33-0305, 33-0171, 33-0185 and 33-0599.

- | VT No.  | Type        |
|---------|-------------|
| 33-0434 | With Dot    |
| 33-2161 | Without Dot |



**2" Chrome Skull Marker Lamp** is for decoration only, lighted eyes.

- | VT No.  | Type |
|---------|------|
| 33-2146 | Bulb |
| 33-0626 | LED  |



**1986-up FLT Skull Signal** with amber Lenses replace stock style.  
VT No. 33-0979



**Skull Medallion Set** includes the mount stud for mounting medallions to the license plate.  
VT No. 48-1323





# SKULL STUFF



Black



Chrome

Skull Gas Caps by Wyatt Gatling.

Chrome	Black	Year	Type
	38-1132	1962-82	Vent
38-0953	38-0954	1984-95	Vent
38-0955	38-0956	1996-12	Vent
38-0957	38-0958	1984-95	Set
38-0959	38-0960	1996-12	Set
38-0961*	38-0962*	1996-up	Vent and Dummy

\*Note: Sets include vented cap and dummy cap for left side to replace fuel gauge.



38-0793



38-0789



38-0794

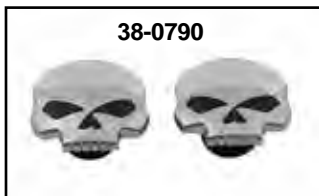

38-0790



38-0791



38-0436



38-0437



38-0438



38-0439



38-0789 Installed

Skull Gas Caps.

Black	Chrome	Type
38-0793	38-0789	Vented (Right)
38-0794	38-0790	1996-99 Left and Right
	38-0791	Right and Left Dummy
	38-0436	Set, 1984-96
	38-0437	Vented 1984-96
	38-0438	Set 1997-up
	38-0439	Vented 1997-up

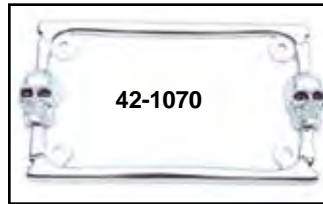

42-1070



42-1068

Chrome License Plate Frame

VT No.	Type
42-1070	Two Skulls
42-1068	Three Skull



Chrome Skull License Plate Bolt Set.  
VT No. 48-0923



Skull Riser Sets in black or chrome.

Chrome	Black	Size
25-1928	25-1929	2"
25-1930	25-1931	4"
25-1932	25-1933	6"



33-0640



33-0385



33-0387

Chrome Billet Skull Style Red LED Tail Lamp and License Plate Holder.

VT No.	Fits
33-0640	Custom application, 5/8 axle
33-0385	Replacement application, spacer
33-0387	1997-up FLT



40-1276



40-0596



40-1277



40-0870

Chrome Skull Oil Fill Dipsticks.

For Softail		For FXD-FXDWG	
VT No.	Year	VT No.	Years
40-1276	1985-99	40-0596	1999-2005
40-1277	2000-up	40-0870	2006-2012

# SKULL STUFF



50-1536

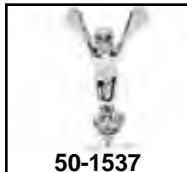

50-1537

## Skull Fender Ornaments

VT No. Type

50-1536 Skull

50-1537 Flying Skull



**Skull Coil Cover** fits 1965-99 FX, FLH, FXST models, chrome with embossed design.  
VT No. 42-0723



42-1044

**Chrome Ignition Module Cover** with skull. Fits 2004-up FXD.  
VT No. 42-1044



42-1080



42-1528



## Skull Chrome Coil Covers.

VT No. Year

42-5523 1965-99 Big Twin

42-1528 1965-99 Big Twin

42-1076 2000-up Softail

42-1539 2000-05 FXD

42-1080 2008-up FXCW



30-3385

**Universal Skull Heat Shields** include clamps for installation.

VT No. Length

30-3385 9"

30-3386 12"



48-1820



**Topper for License Plate.**  
VT No. 42-1530



**Chrome Front Fender Strip** with skull design.  
VT No. Fits 50-1157 FL 50-0432 XL



33-1932 Installed



33-1932



33-1936

**Chrome Skull Ornament** fits visors, each.

VT No. Fits

33-1932 4"

33-1936 7"



27-0620



27-0694

## Billet Footpeg Sets.

VT No. Item Style Finish

27-0620 Peg Set Skull Chrome

27-0694 Peg Set Skull Chrome



28-0759

**Chrome Billet Aluminum Skull Grip Set** have the throttle sleeve machined as part of the grip. This makes for smooth operation of the throttle.

VT No. 28-0759

## Skull Keychain

VT No. Finish

48-1820 Brass

48-1821 Chrome

48-1822 Polished Pewter

48-1823 Black Pewter



**Chrome Billet Fork Lock Cover** with raised black skull design.  
VT No. 42-0135



Skull

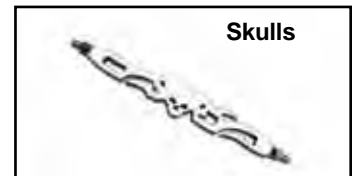

Skulls

## Chrome Shifter Rod.

11" 12.25" 13.75"

Skull 21-0581 21-0582 21-0583

Skulls 21-0557 21-0554



21-0991

21-0992

21-0993

21-0994

## Skull Shifter Linkage

VT No.	Item	Fits
21-0991	1999-12 FLHT	Black
21-0992	1999-12 FLHT	Chrome
21-0993	1986-10 FX/FLST	Black
21-0994	1986-10 FX/FLST	Chrome



**Skull Chrome End Handlebar Grip Sets.** Order throttle inner sleeve separately.

VT No. Item

28-0144 Grip Set

28-1981 Inner Sleeve



**Skull Dash Kit** includes cover and base.

VT No. 39-0615

XL

MULTI FIT/CHOPPER





# SKULL STUFF



48-0490



48-0491



48-0492



48-0493



48-0494



48-0495



48-0496



48-0493 Installed

Pewter Emblems with adhesive backing.

VT No.	Size	Style
48-0490	4" x 3"	Skull with sickle
48-0491	3" x 1"	5 Skulls
48-0492	2" x 3"	Grim Reaper
48-0493	1.5" x 2.5"	Skull
48-0494	2.5" x 2.5"	Maltese Cross with Skull
48-0495	1.5" x 1"	Skull
48-0496	3" x 1"	Winged Skull



**Skull Belt Buckle.**  
VT No. 48-1784



**Skull Knob** is made of solid brass, polished, can be drilled and tapped for shifter ornament.  
VT No. 21-2015



**Chrome Billet Shifter Footpeg** has 2 skull and cross bones machined into the footpeg.  
VT No. 21-0790



**Skull Fender Ornament** features a chrome skull face with a black shroud.  
VT No. 48-0249



25-0201



25-0202



24-1161



24-1162

**Handlebar Top Clamp** fit 1974-up FX-FXR-FLH-FXST. Front Panel as long or short skirt.

Skirt	No Skirt Style
25-0200	Skull, Chrome
25-0201	Skull, Chrome
25-0203	25-0202 Chrome Skull on black
24-1163	24-1161 Chrome Skull with flames
24-1164	24-1162 Chrome Skull with flames on black



**Chrome Skull Top Riser Clamp** fits 1973-1984 FX, 1982-1994 FXR, 1984-up FXST, 1974-up XL  
VT No. 25-2210



**Chrome Die Cast Skull Face LED Tombstone Tail Lamp** with red lens and license plate bracket.  
VT No. 33-0199



31-0390



31-0391

**Skull Mirror Bracket Extensions** for FXD-FXST models.

Chrome	Black
31-0390	31-0391



**Sissy Bar Skull Medallion.**  
VT No. 42-0045



50-0012

**Chrome Deep Cut Inner Fairing Speaker Grill Set with black skull** fits batwing style fairings on FLT models.

VT No.	Fits
50-0012	2000-2013
50-0736	2014-up



# 1 1/4" Chrome Handlebar

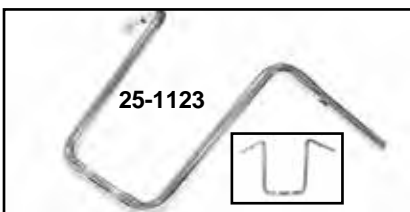
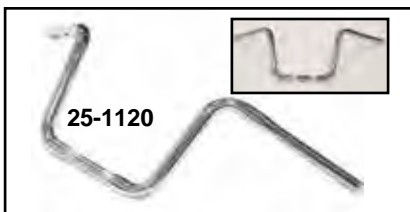

1 1/4" Chrome Ape Hanger Bars feature tapered design at the hand control area to allow the use of custom or OEM controls (including hydraulic clutch). Wide bars are also notched for throttle by wire applications.

Narrow	Wide	Rise
25-1120	25-1124	11"
25-1121	25-1125	14"
25-1122	25-1126	17"
25-1123		19"



1 1/4" Z Bars with knurls.  
 VT No. Height  
 25-1178 10"  
 25-1177 12"



1 1/4" Chrome Handlebars with 10" rise and indent for external wiring. Fits 1986-2013 FLH

VT No.	Type
25-1842	Curved
25-1843	Bathtub

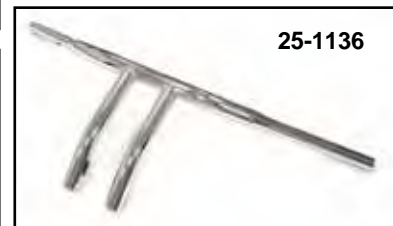
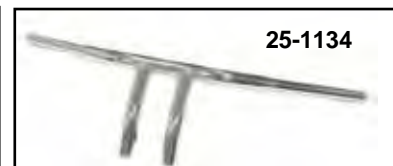

1 1/4" "T" Bars	VT No.	Rise	Finish
	25-1134	6"	Chrome
	25-1135	8"	Chrome
	25-1136	10"	Chrome

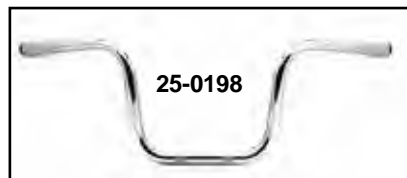

8.5" Mini Ape Hanger  
 Chrome Black

25-0196 25-0197

25-0198 25-0199 For XL without indents

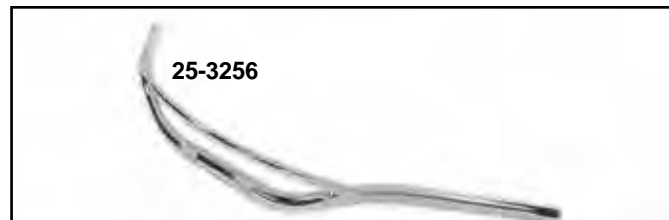

Hollywood Bars feature cross bar. Fits 1984-up FXST, FLT, 1986-up FLST, 1982-up XL, 1991-up FXD.

Black Chrome Diameter

—	25-0996	1"
25-0999	25-0997	1 1/4"



Chrome Ape Style Z Handlebar has a 1 1/4" bar diameter, height of 12", holes for internal wiring, and will accept throttle-by-wire with right side notches.

VT No. 25-3256





# Z-Handlebar



**Dropped Z Bars** feature long handles in 1" with knurl without indents.

**VT No. Type**  
**25-0701** Single  
**25-0848** Double

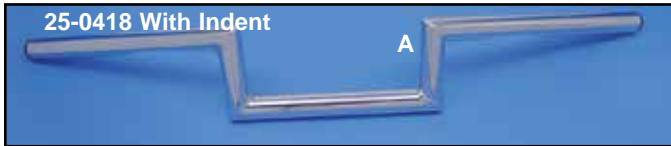

25-0418 With Indent

A

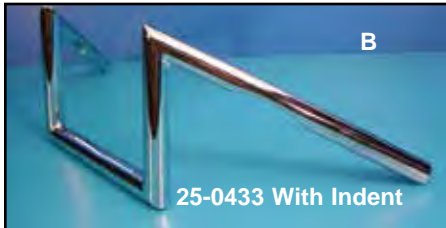

25-0433 With Indent

**Chrome 1" Z Type Handlebars** feature early chopper styling without knurling. Available with or without indents.

**VT No. Type**  
**25-0418** A 4"  
**25-0430** B 4"  
**25-0426** A 6"  
**25-0433** B 6"  
**25-0427** A 8"  
**25-0431** B 8"  
**25-0428** A 10"

With Indent	Without Indent	#	Height
25-0418	25-0429	A	4"
25-0430	—	B	4"
25-0426	25-0419	A	6"
25-0433	—	B	6"
25-0427	25-0420	A	8"
25-0431	—	B	8"
25-0428	25-0421	A	10"



**Incysa "Z" Bars** use with 1.25" inner diameter risers.

**VT No. 25-0748**



25-0845

**Incysa "Z" Bars** 1" diameter, knurled.

**VT No. Type**  
**25-0845** FXSTS  
**25-0871** FX-XL  
**25-3257** 10" Rise



**"ZZ" Bar** is 1.25" outside diameter with indent for wiring. 7 3/4".

**VT No. 25-1095**

## V-Bars



25-0702

**V-Bars** with indents are 1" outside diameter.

**VT No. 25-0702**



**1 1/4" Low Rise Z Bar** features 4.5" pullback and 4.5" rise with indents.

**VT No. 25-0791**

**Note:** We suggest using our chrome control and housing sets on 1 1/4" bars such as 26-0402, 26-0405, 26-0406, 26-0407, 26-0410 and 26-0411.



**Chiseled Chrome Handlebar.**

**VT No. Height**  
**25-0632** 11"  
**25-0633** 13"  
**25-0634** 15"  
**25-0635** 17"



**Mini "Z" Bar** features 25" width, 4" drop with indents.

**VT No. 25-0704**



25-0753



25-0755



25-3255

**Fatty Z Bars** are 1 1/4" outside diameter.

**VT No. Height**

**25-0753** 12"  
**25-0754** 14"  
**25-0755** 4"

**25-3255** 11", Ape Style, 2008-up FLT

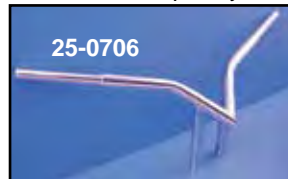

25-0706



25-0707

**Flying V-Bar** features 8" rising with 1 1/4" outside diameter. Available for stock or raked forks.

**VT No. Type**

**25-0706** Stock  
**25-0707** Raked

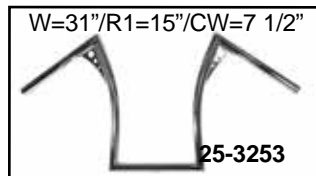

W=31"/R1=15"/CW=7 1/2"

25-3253

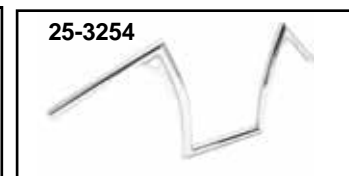

25-3254



25-3258

**1" Z Bars** are slotted and drilled for internal wiring. Feature notches for throttle by wire applications.

**VT No. Rise**

**25-3257** 10"  
**25-3252** 10 1/2"  
**25-3253** 15"  
**25-1179** 17"  
**25-3254** 12"  
**25-3258** 12"



**Crazy-Z Bars** feature 1 1/4" outside diameter with holes to accept 1" controls.

VT No.	Black	Height
25-0859	25-0864	3"
25-0757	—	5"

**Chrome 7/8" Crazy Z Bars** for use with 7/8" inner diameter. Riser and throttle control without indents, holes or knurling.

VT No.	Height	VT No.	Height
25-0861	4"	25-0863	8"
25-0862	6"	25-0862	10"

## Z Bar



1 1/4" Z Bars with indents and knurls.

**VT No. Height**

25-1143	10"
25-1144	12"
25-1145	14"
25-1146	16"
25-1147	18"

## FXSTS Handlebar

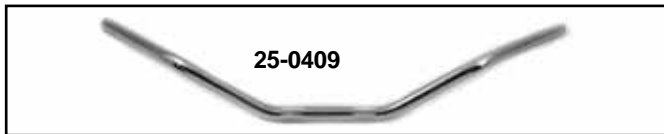

**Handlebars for FXSTS Springer.**

VT No.	Style
25-2168	Stock
25-0409	Police

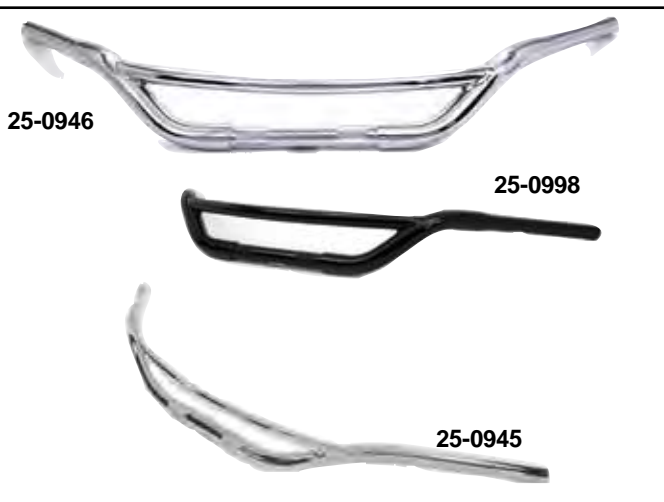

**Hollywood Bars** with knurls for FXSTS.

Chrome	Black	Type
25-0946	25-0998	1 1/4"
25-0945	—	1"



**1" Vintage Handlebar** for Spring Fork 3/4" spacing and a 12" rise with holes for internal wiring.  
**VT No. 25-1837**

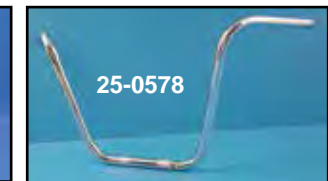
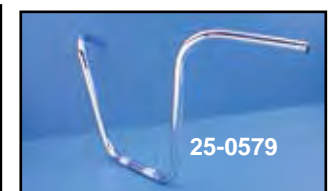
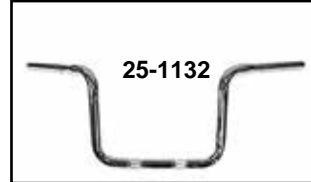

**Ape Hangers for FXSTS models** feature 3/4" knurl spacing, and indents for wiring.

1 1/4"	1"	Rise
25-1132	25-0845	(Z Bar) 11"
25-0583	25-0580	12"
25-0584	25-0579	15"
25-0586	—	16"
25-0585	—	17"
25-1133	—	17"
—	25-0578	18"

**1" +  
1 1/4"**

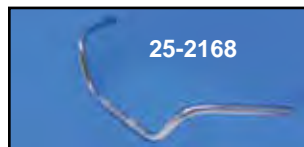

**Replica Handlebar** with indents with 3/4" spacing. Fits FXSTS with 16" rise and replaces 56093-88.  
**VT No. 25-2168**



**Vintage Bar** with 7.5" rise and holes for internal wiring.  
**VT No. 25-1834**





# 1 1/4" Buffalo Handlebar

## 1 1/4" Buffalo Ape Hangers.

FXST	Rise	Grips
25-0714	12"	36"
25-0682	13"	36"
25-0715	14"	36"
—	15"	36"
25-0716	16"	36"
25-0656	18"	37"
25-0717	20"	37"



**1 1/4" Chrome Knucklebars** are pre-drilled for internal wiring. Feature 30" width with a 4.5" pullback. Fits custom springer front end applications.  
VT No. 25-0230



**1 1/4" Buffalo Bars** fit 1988-up FXST models, featuring 36" width, 1.5" rise 14" center width and a 12.5" pullback.  
VT No. 25-0577

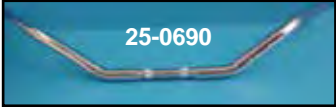

## Dresser Buffalo Bars.

VT No.	Width	Height	Pull Back
25-0690	38"	5"	10 1/4"
25-0693	35"	6 1/2"	10 1/2"

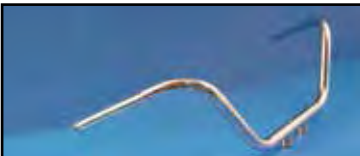

**Dresser Style Bar** with indents features 1 1/4" diameter with 34.5" width, 2" rise and 11" pull back with 1/2"-20 threads.

VT No. 25-0651

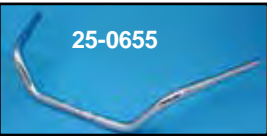

**Buffalo FL Style Dresser Bar** features 4" end riser, 14" pullback and 12" center width with grips at 35" wide. Designed for tall riders.

VT No. 25-0655

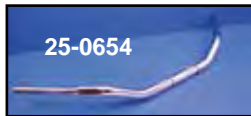

**Buffalo Bars** are 1 1/4" outside diameter with low profile. Drag style.

VT No. 25-0654



**1 1/4" Bikini Beach Bars** are 36" wide with 3.5" rise with 8" at the center.

VT No. 25-0699

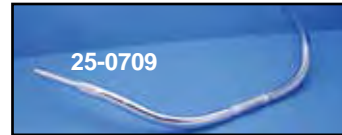

**1 1/4" Beach Bars** are pre-drilled for internal wiring. The shape provides comfort with control. Use with stock risers and clamps.

VT No. Type  
25-0709 FLST  
25-0710 FXSTS

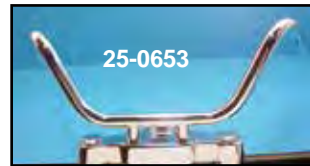

**1 1/4" Flat Track Bar** feature 30" width and 14.5" pull back with built in 3" riser with 1/2 - 20 thread.  
VT No. 25-0653

## Black Bars



### 1 1/4" T-Bar

VT No.	Rise	Finish
25-1134	6"	Chrome
25-1135	8"	Chrome
25-1140	8"	Black



### Black T- Bars.

VT No.	Rise
25-2279	10"
25-2281	6"

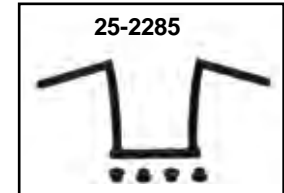
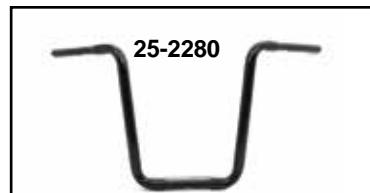
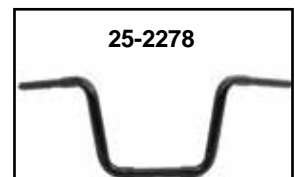
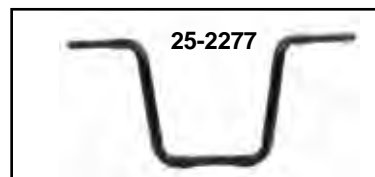

**Black Bars.** \*Note: Throttle by wire

VT No.	Rise	Type
25-2275	15"	Z-Bar
25-2276	15"	Z-Bar, 2" knurled spacing and indents
25-2277*	14"	Narrow Body Ape Hanger
25-2278*	11"	Narrow Body Ape Hanger
25-2280*	17"	Narrow Body Ape Hanger
25-2285*	11"	Z-Bar



# 1" Drag Handlebar

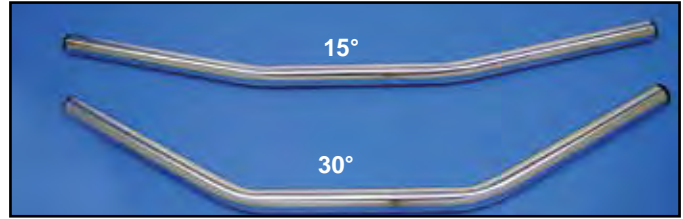
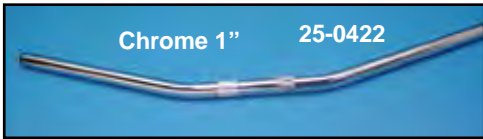

1" Wide Drag Bars feature knurls at riser area. Available with or without indents.

Chrome	Black	Type	Width
25-0422	—	Smooth	32"
25-0424	—	Indent	32"
25-0423	25-0458	Smooth	36"
25-0425	25-0459	Indent	36"

1" Drag Bars sweep back angle style with 15 or 30 degree bends and 30" overall width.

Chrome	Black	Sweep
25-0539	25-0561	15°
25-0540	—	30°
25-0544	25-0456	15° indented
25-0879*	—	15° indented *Note: without knurls.
25-2144	—	30° indented
25-2215	—	Indented
25-2216	—	30° indented

## 1 1/4" Bars

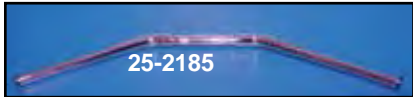

Buffalo Drag Bar features 30 1/2" width.  
 VT No. O.D.  
 25-2185 1.25"  
 25-0796\* 1.25" \*Note: without knurls.  
 25-0658 1.50"

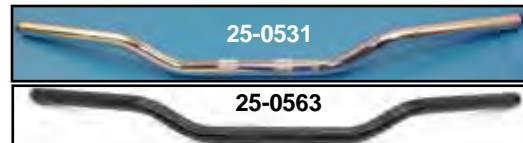
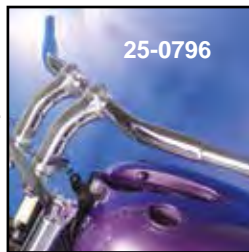

2" Rise Drag Bars offer the pullback style yet, retain the drag bar look. Measure 8" across riser, 2" rise, 7 1/2" grip, 31 3/4" across, 1" diameter.

Chrome	Black	Indent	Knurl	Grip
25-0531	25-0563	Without	Yes	31 3/4"
25-0666	25-0564	With	Yes	31 3/4"
25-0847	—	Without	No	31 3/4"
25-0727	—	With	Yes	29 3/4"
25-2216*	—	With	Yes	28 1/4" *Note: 2 1/2" rise



VT No. 26-0585 Buffalo Riser Set  
 Shown with  
 25-0531 Bar

## 1" Riser Bar

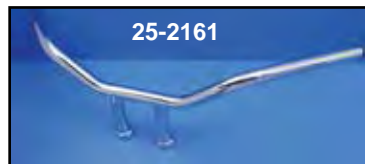

Riser Bars are available with indents for 1982-up models or without indents, feature 3 1/2" center to center, to accept 1/2 - 20 thread bolts.

With Indents	Without Indents
25-2152 5"	25-2161 5"
25-2153 7 1/2"	25-2162 6"
25-2154 9"	25-2163 8"



1 1/4" Chrome Knucklebars are pre-drilled for internal wiring. Feature 30" width with a 4.5" pullback. Fits custom springer front end applications.

VT No. 25-0230

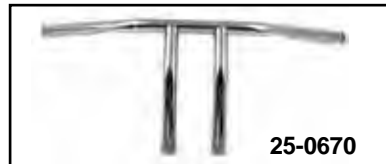

1" Pullbacks bolt to 3 1/2" bolt centers, mounts with 1/2 - 20 bolts. Grips 22" apart.

With Indents	Without Indents	Rise
25-0669	25-0536	4"
25-0670	25-0537	6"
	25-0575	8"





# Riser Handlebar



25-0698



25-0678

**Chrome Buffalo "T" Handlebars** are 1 1/4" bars with indents and drilled for internal wiring. Has 3.5" bolt spacing.

\***Note:** Without indents.

VT No.	Width	Height	Pullback
25-0698	32.75"	10.5"	8.5"
25-0679	32"	8.5"	10.5"
25-0678*	32.5"	6.5"	9"
25-0708	29"	7"	6"
25-0721*	32.5"	10.5"	5"



**1 1/4" Lean Back Riser Handlebar** feature swept back design with indents for extended neck-fork applications.  
VT No. 25-0703



**Radius Handlebar with indent** features 9" tall V-design and 9" rise with wire indent and 1 1/4" diameter.  
VT No. 25-0725



**1.25" Curve Riser Bar** is 26" wide, 9.5" pullback, rise to grip 9" and 1 1/4" diameter.  
VT No. 25-0720



**Buckhorn Style 1" Riser Bars** feature 11" rise to center, 12" rise to grip, 11" pullback and 22 1/2" end to end. Mounts to 3 1/2" center to center with 1/2"-20 bolts. Available with or without indents.  
VT No. Type  
25-0625 With Indents  
25-0626 Without Indents



**Flat Track Bar** features 29" width, 4" rise to grip, 8 1/2" rise to center and 12" pullback with built in riser with 1/2" x 20 thread.  
VT No. 25-0652



25-0640



25-0640 Installed

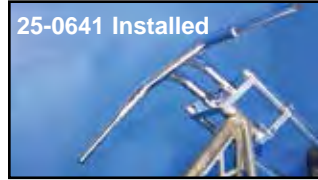

25-0641 Installed

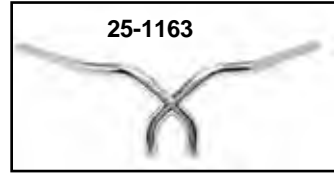

25-1163



25-1164



25-1163 Install

**1.5" Fatster "T" Bar** has 3.5" bolt centers for 1/2" x 13 bolts.

VT No.	Rise
25-0640	6"
25-0641	8"
25-0874	8"
25-0642	10"
25-1163	Gothic
25-1164	V-Bar
25-1191	V-Bar, Black
25-1165	Flyer



**Chrome Riser Sleeves** for use with riser drag bars.  
VT No. Size  
28-0441 1"  
28-0442 1.25"



25-0788

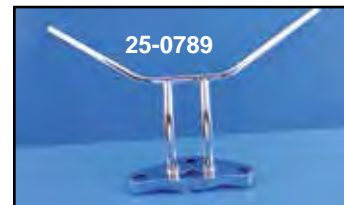

25-0789

**Swing Back Handlebar** in 1" outside diameter with indents.  
VT No. Size  
25-0788 6"  
25-0789 7 1/2"



**FXLRC Style Handlebar** mounts with 1/2" - 13 bolts, 3 1/2" spread. Order gauge mount that fits between bars.  
VT No. Item  
25-0664 Bars  
37-8452 Mount Bolts

Check out our website for detailed dimensions on handlebars at [www.vtwinmfg.com](http://www.vtwinmfg.com)



# 1" Handlebar

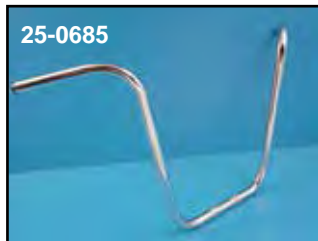

25-0685



25-0672

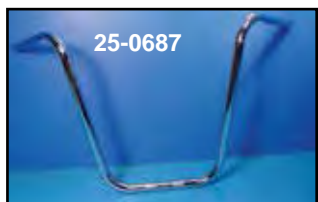

25-0687



25-0671

**Chrome Ape Hangers** are made of heavy steel tubing.

**Note:** All 1982-up Ape Hangers come with indents.

Pre-82	1982-up	Rise
25-0532	25-0713	8"
25-0533	25-2146	10"
25-0534	25-0671	12"
25-0529	25-0576	14"
25-0672	25-0673	15"
25-0684	25-0686	16"
25-0685	25-0687	18"
25-0855	25-0856	20"

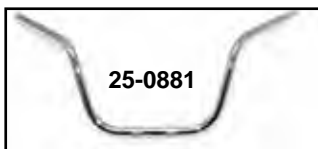

25-0881

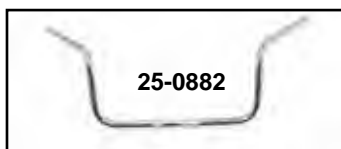

25-0882

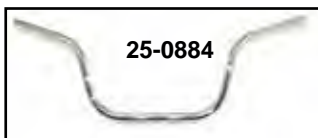

25-0884



25-0885

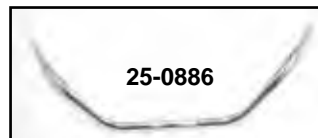

25-0886



25-0887

**Handlebars** for 1982-up Big Twin, XLH

**VT No. Style**

- 25-0881 FL Style
- 25-0882 Glide
- 25-0884 Mid Rise
- 25-0885 Mid Rise
- 25-0886 Cruise
- 25-0887 Police



25-1833



25-1836



25-1833

**Vintage Bars.**

**VT No. Description**

- 25-1832 Shorty Bar, F/XL, FX, ST
- 25-1833 Bar, 7.5" H, F/XL, FX, ST
- 25-1834 Bar, 7.5" H, F/Springer
- 25-1836 Bar, 12" H, F/XL, FX, ST



**Heritage Style Bars** indented and pre-drilled for hidden wiring, 32" wide, 6" rise, 10" pullback with 13" center width. 1" diameter.

**VT No. 25-2149**



**Chrome Mini-Buckhorns** are a modified scaled down look and size of the original 70's buckhorn. 1" diameter.

**VT No. 25-0542**



**Two Piece Bars.** Original Buckhorn type, knurled to fit stock riser block on 1960-78 FL, 1" diameter on both ends enables snap throttle to be used.

**VT No. 25-0663**

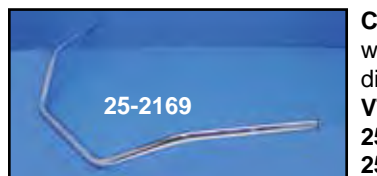

25-2169

**Chrome Beach Bars** are 39" wide at grip with a 5" rise. 1" diameter.

**VT No. Type**

- 25-2169 With indents
- 25-2170 Without indents

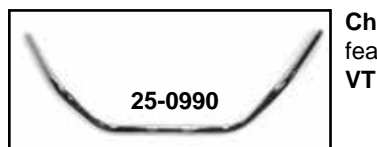

25-0990

**Chrome Speeder 1" Bars** feature knurled center.

**VT No. 25-0990**



25-0408

**Police Bars** are the wide style 33" across with 4" rise FL tour bar 12" across riser mount; excellent for dog bone or flanders style risers. The 1982-up is available with indents. 1" diameter.

**VT No. Type**

- 25-0399 Pre 1982
- 25-0408 1982-up w/indents



**Narrow Ape Hangers.**

**VT No. Size**

- 25-0951 13"
- 25-0952 15"



**Stainless Handlebars** with knurl replaces 56083-74 on FX models 1974-81. Stock Pre-1982. 1" diameter.

**VT No. 25-0416**

**For the Complete Listings, Measurements and Photos**

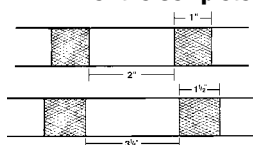

**Note:** Handlebars include knurls with 2" spacing except FXSTS type which have 3/4" spacing.





# 1" Replica Handlebar

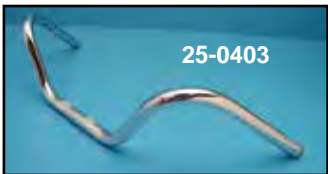
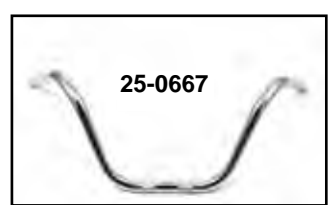
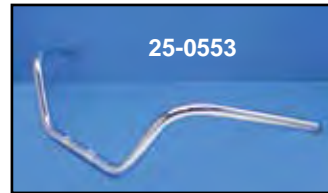
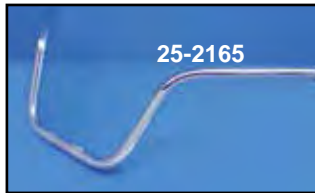
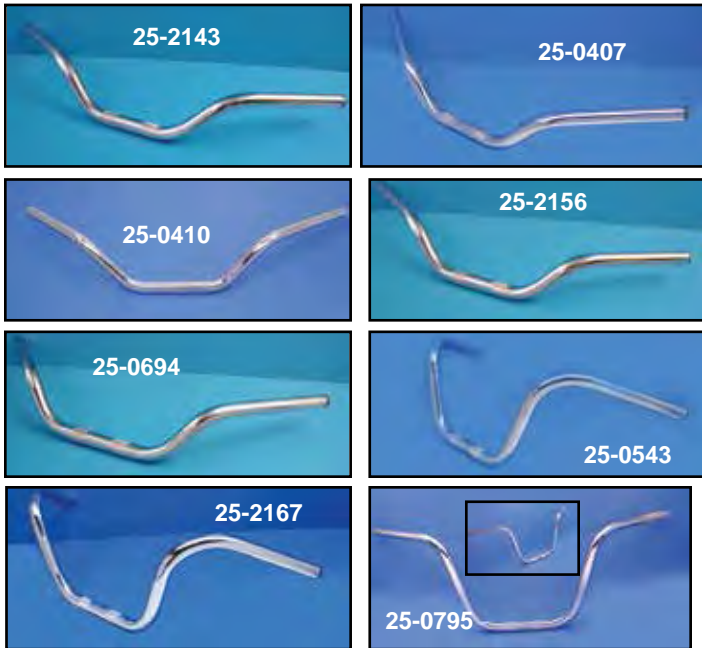

1" Stock Replacement Handlebars in chrome with indents and knurled center, for 1982-up models.

\*\*Note: Denotes without indents

VT No.	OEM	Type
25-2143	56082-83	883 XL Low
25-0407	56085-83	XLX
25-0410	W/O Knurl	XLX
25-2156**	As Above	XLX
25-0694	56473-98	XL Sport
25-0543	56081-82	FXR
25-2167	56081-82	FXST, XL 1200
25-0795	56962-07	FXST
25-2166	56079-93	FXDWG
25-2165	56569-86	FLSTC
25-0553	56557-95	FLSTF-FLHR
25-0401	55919-82	FLSTF-FLHR-FLH
25-0696	56086-81	FX-FXE
25-0405**	55950-80	FXWG
25-0667	55950-80	FXWG
25-0417**	55963-77	FXS
25-0403	56003-75	FXE
25-0404**	56003-76	FXE

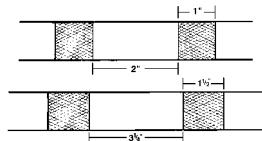

Note: Handlebars include knurls with 2" spacing.

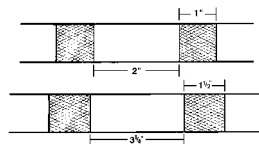

Note: Handlebars include knurls with 2" spacing except FXSTS type which have 3/4" spacing.

## How Bars Are Measured

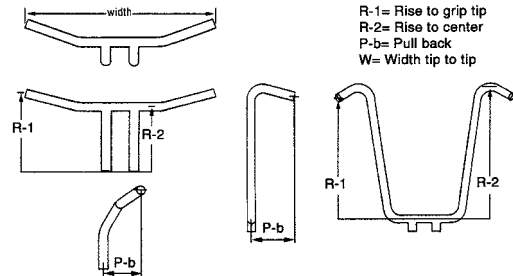



# 1" Handlebar

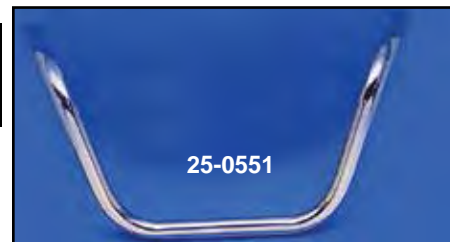
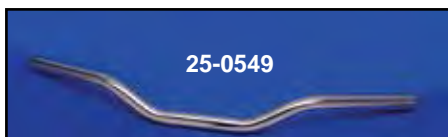
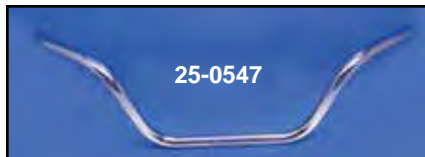
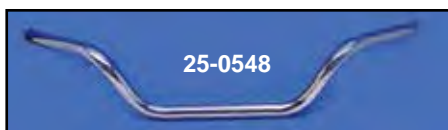
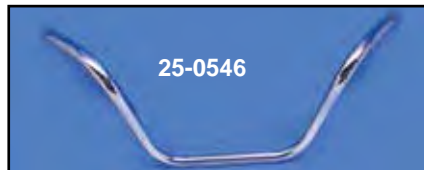

Style	W/O Indent	With Indent	Width	Rise	Pull Back	Center Width
High Buckhorn	25-0530	25-0546	33"	9"	11"	8.5"
Med Buckhorn	25-0520	25-0547	33"	7"	7.5"	10"
Low Buckhorn	—	25-0548	32"	3.5"	10"	8.5"
Superbar	25-0660	25-0549	29"	2"	5"	5.5"
		25-0443*	29"	2"	5"	5.5"
High Chopper	25-0650	25-0550	24.5"	6"	15"	6"
Low Chopper	25-0630	25-0551	23"	6"	13.5"	5"
Drag Bar	—	25-0412	28.5"		5.5"	8.5"
		25-0442*	28.5"		5.5"	8.5"
		25-0445*	29"	6"	13"	7"

Note: All 1982-up handlebars with indents are for external wiring only.

\*Note: Denotes without knurl

## Cross-Bar



Speedster Style Bar features wide format and will accept cross bar VT No. 49-2607 which may be ordered separately.

VT No.	Type
25-0406	FX-XL
25-0409*	FXSTS



Replica Chrome Cross Bar Kit includes fluted tube and 2 stainless clamps. For FLH models.

VT No.	Item
49-0153	Cross Bar
31-0530	Clamp Set Only

## Handlebar Accessory



Chrome Billet Handlebar Assemblies fit 7/8" or 1" handlebars.

VT No.	Item
39-0785	Clock, 7/8" or 1"
39-0786	Outside Temperature Gauge, 1"
39-0788	Clock with glow in dark hands, 7/8" or 1"

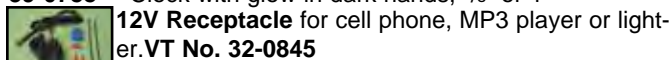

Chrome Electronic Device Holder mounts to left side control clamp on 1996-up models.

VT No. 31-1233



Weighted End Inserts fit the inner diameter of 1" handlebars to reduce vibration at bar ends. Inserts are made of brass.

VT No. 28-0629



Universal Cigarette Lighter available for panel mounting.

VT No.	Finish
33-0561	Chrome
33-0562	Chrome with bracket



Chrome Coin Holder clamps to handlebars with a clip for dollars. Great for tolls.

VT No. 48-0644





# 1 1/4" I.D. Riser

Note: Bars and risers are full 1 1/4".



**Chrome Riser Set** fits 1 1/4" bars on 2006-up FXST.  
VT No. 26-0252



**FXSTC Riser Kit** fits 06-up models 1 1/4" ID.  
VT No. 26-0689



**Shorty 1.25" Stock Riser Kit** fits 2006-up FXDWG.  
VT No. 26-0745



**Fat Handlebar Clamp Set** fits over existing risers

VT No.	Item	Fits
25-0221	Clamp Set	2006-up FXST
26-0688	Riser Stems	1999-up FXWG 2000-up FLSTF



**Chrome Lean Back Riser Set** for 1 1/4" handlebars. 2" pullback with 3 1/2" rise.  
VT No. 26-0605



**Chrome Solid Billet Riser Sets** feature 1/2 x 13 mount threads.  
1 1/4" I.D. Size  
26-0597 3"  
26-0599 4"  
26-0598 5"  
26-0600 6"  
26-0601 8"



**Chrome Riser Set** fits 06-up FXDWG models to use with 1 1/4" bars (1 1/4" riser hole diameter).  
VT No. 26-0791



**Fat Riser Set** fits 2008-up FXDF with 1 1/4" bars.  
VT No. 26-0742



25-0252



**Riser Height (H)** as measured.



25-0792



25-0554



25-0555

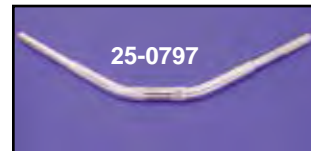

25-0797



**Replica Bar.** These bars are full 1 1/4" outside diameter and will fit 2007 FXD-FLSTF. Use with 1 1/4" inner diameter risers.

VT No.	Model	Height
25-0792	FLSTF	5"
25-0554	FXDWG	10"
25-0555	FXDWG	10" (Drilled for Internal Wiring)
25-0730	Ape	12"
25-0735	Ape	13"
25-0731	Ape	14.5"
25-0732	Ape	16"
25-0734	Ape	18"
25-0733	Ape	20"
25-0797	Drag	—



25-0734



**Chrome Riser Kit** includes top clamp for 1" bars.  
**VT No. 26-0744**



**3" Glide Riser Kit** includes antique style top clamp with 3 1/2" center to center for all 1973-up FX-FL models. Kit includes allen cap screws, clamp and risers.  
**VT No. Item**  
**25-2145** Kit  
**25-2183** Top Only



**Chrome Stock Riser Stems** sold in pairs, order top clamp and screws separately.

VT No.	Height	Model
25-2101	1 1/2"	FX
25-2115*	1 1/2"	FX
25-2178	1 1/2"	FLST
25-2133	1 1/8"	FLH Type
25-2131	Offset	1986-1994 FXR

\*Note: Threaded, others are drilled through for hex bolt.



# Stock Riser Set



**Chrome Stock Riser Set** includes finned riser cap and screws. Use 1/2" x 13 mounting bolt. Fits 1970-up.  
**VT No. Type**  
**25-2100** Complete Kit, 1 1/2"  
**25-2132** Complete Kit, 1 1/8"  
**25-2179\*** Complete Kit, FLST  
 \*Note: Includes bolts



**Straight Riser Kit.** Stems replace 56142-80 as stock on all 1980-up FXWG. Complete, with riser cap and screws. Use 1/2" x 13 mounting bolts.

VT No.	Item	
25-2119	Stems only	4 1/4"
25-2114	Smooth Kit	4 1/4"
25-2116	Ribbed Kit	4 1/4"
25-2147	Eagle Spirit Kit	3 3/4"

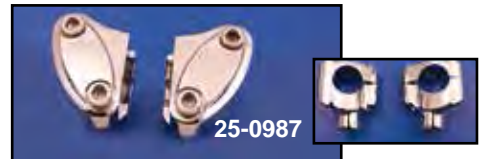

**Chrome Riser Set** fits 1988-up Touring.

VT No.	Item
25-0985	Riser Set
24-1155	Top Clamp
25-0987	Riser Kit



**Chrome Riser Sets.**

VT No.	Item
25-0233	Wide Glide 4"
25-0235	Wide Glide 4"
25-0236	Wide Glide 6"
25-0234	6" Spy Glass





# Riser Top Clamp



**Chrome Handlebar Top Clamp** fit 1974-up FX-FXR-FLH-FXST. Front Panel as long or short skirt.

- |   |                      |                                 |
|---|----------------------|---------------------------------|
| <b>Skirt</b>                              | <b>No Skirt</b>      | <b>No Skirt</b>                 |
| 25-2104 Smooth                            | 25-2128 Raised Top   | 25-2120 Smooth Hidden           |
| 25-2108 Finned                            | 25-2107 Smooth       | 26-0795 USA Hidden              |
| 25-2138 Antique                           | 25-2109 Finned       | 25-2210 Skull, Hidden           |
| 25-2155 Raised Top                        | 25-2135 Eagle Spirit | 24-1155 Touring                 |
| 25-0200 Skull, Chrome                     | 26-2161 Live to Ride | 24-1161 Chrome skull w/ flames  |
| 25-0201 Skull, skirt                      | 26-0590 Chrome       | 24-1162 Black skull with flames |
| 25-0202 Skull, black                      | 26-0591 Black        |                                 |
| 25-0203 Skull, black                      |                      |                                 |
| 24-1163 Chrome Skull with flames          |                      |                                 |
| 24-1164 Chrome Skull with flames on black |                      |                                 |
| 26-0592 Chrome                            |                      |                                 |
| 26-0593 Black                             |                      |                                 |



**Chrome Billet Style Riser Cap Set** replaces 56057-00 and is a curved 2 piece design. For risers which accept the 1 piece clamp.  
**VT No. 26-0540**



**Riser Links** cover top of glide type risers on both FX, 3 1/2" center. Studs and acorns included.  
**VT No. Fits**  
**49-0418** 1973-up FX-XL  
**37-8810** 4 Studs and 4 Acorns, Set



**Handlebar Reducer Sleeves** measure 7/8" ID, 1" OD to grip 7/8" bars in ID risers, set of 4.  
**VT No. 25-2174**

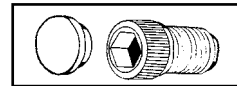

**Chrome Handlebar Screw Caps** snap over allen head screws to cover hole. 10 pack.  
**VT No. 37-7966**



**Chrome Handlebar Top Clamp Bolt Sets** available in allen or acorn types.

VT No.	Type	Year	No Skirt
8795-4	Allen	1974-81	FX
8796-4	Allen	1982-up	FX
9962-6	Allen	1995-up	FX
9636-8	Acorn	1982-up	FX



# Riser Set



**Chrome Buffalo Risers** features 1 1/4" diameter post and are available in 9 1/2" or 10" height with top clamp. Uses 1/2"-13 mounting bolts.

**VT No. Size/Clamps**  
**26-0586** 9 1/2" With (two piece)  
**26-0585** 10" With (one piece)  
**2131-4** Mounting Bolts



**Polished Stainless Steel 1 3/4" Riser Set** with 1/2"-13 thread.  
**VT No. 26-0555**



**Chrome Fat Post Riser Set** includes top clamp, use 1/2" - 13 mount bolts with 5" rise.  
**VT No. 26-0744**



**Riser Sets** with hidden top screws for 1" handlebars.  
**VT No. Size**  
**26-0943** 3"  
**26-0944** 5"



**6" Post Risers.**  
**VT No. 25-0556**



25-2202



25-2203



25-2204



25-2205

**Chrome Glide Risers** in steel have 1/2" - 20 threads.  
 \*Note: 25-2203 has hole through for bolt, not threaded.

**VT No. Height**  
**25-2202** 4" **25-2205** 8"  
**25-2203\*** 4" **25-0556** 6" without tops  
**26-0595** 8"  
**25-2204** 6"



25-2200



25-2201

**Chrome Steel Post Risers** have 1/2" - 20 internal for mounting.

**VT No. Rise Brand**  
**25-2214** 3" Wyatt  
**25-2200** 3" Paughco  
**25-2201** 5" Paughco



25-2214



25-2171



25-2130



**Chrome Tapered Stock Type Risers.** Original tapered type, through bolt design, chrome steel. Bolts not included.

**VT No. Rise**  
**25-2171** 3" **25-2176\*** 3"  
**25-2129** 4", Threaded **25-2250** 3"  
**25-2173** 5" **25-2208** 6", Threaded  
**25-2130\*** 5" **25-2209** 8"

\*Note: Feature rubber Iso-inserts, and 5/16" allen screws



26-0250

**Chrome Smooth Top Billet Risers Set** feature classic glide riser styling and hidden top screws. Available in 4" height.  
**VT No. 26-0250**



26-0646



26-0647

**Black Solid Riser Sets.**  
**VT No. Item**  
**26-0646** 4" Hourglass  
**26-0647** 6" Wide Glide



**Chrome Riser Cap Set** for 3" riser set.  
**VT No. 25-2212**





# Pullback Riser Set

**Note:** Unless otherwise noted these risers are for 1" bars.



**Chrome Pullback Riser Set** features pullback styling. Kit includes two piece cap set and risers with 5" rise and 2" pull back and 1/2" — 13 internal threads.

**VT No. Type**

- 26-0539 Fatty
- 26-0591 Slotted



**5" Pullback Riser Set** with 1/2" — 13 mount holes.  
**VT No. 25-2164**



**3" Pullback Riser Set** features 30° set back, to accept 1/2" — 13 bolts.  
**VT No. 25-2123**



**Chrome Pull Back Riser Set** features 1/2" - 13 threads for mounting.

VT No.	Height	Diameter
25-2151	9 1/2"	1 1/4"
25-2195	7"	1 1/4"
2131-4	Mounting Bolts	

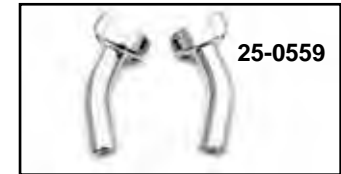
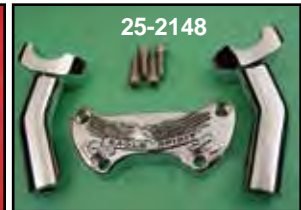
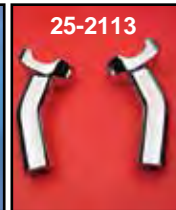

**Chrome Pullback Riser Kits** are replicas of factory type with 1 1/2" set back and 4 1/2" rise, to clear Bobbed tanks. Fit 1973-up FX and Sportster models. Kit includes top clamp and screws, accepts 1/2" — 13 mount bolts.

VT No.	Type
25-2113	Stems only
25-0528	4" Stems only
25-0559	4" Stems only
25-2112	Ribbed Kit
25-2110	Smooth Kit
25-2148*	Eagle Spirit Kit

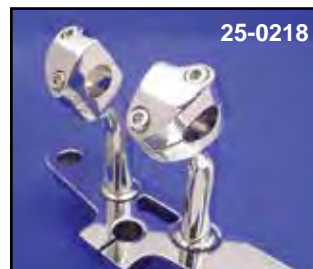
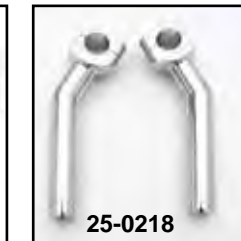
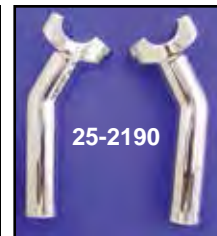

**Chrome Forged Aluminum Pullback Riser** are available as stems only that can be used with stock top clamp or 26-0540 Billet cap clamp or as riser set which includes top clamp. Post are 1.10" diameter and use 1/2" — 13 mounting bolts.

VT No.	Height	Cap
25-2192	4"	Without
25-2190	5.5"	Without
25-2193	6.5"	Without
25-0215	4"	With
25-0217	5"	With
25-0218	6.5"	With



**Switchback Billet Riser Set**  
features 4" rise and 1" setback.  
VT No. 26-0602



**Pullback Riser Set** will set back bars on FXD models.  
VT No. 26-0604

# Pullback Riser Set



**Billet Tilt Back Risers.**  
VT No. Height  
26-0643 3½"  
26-0644 4½"  
26-0645 5½"



**4" Girder Riser Set.**  
VT No. 26-0942

# Post Riser



**Forged Riser Sets** feature hidden top screws.  
VT No. Height  
25-0224 2"  
25-0228 10"



25-0226



26-0881



26-0882



26-0883

**Wyatt's Riser Set** are ½ — 20 thread.  
VT No. Height  
26-0880 4"  
26-0881 6"  
26-0882 8"  
26-0883 10"



25-2121

**Chrome Post Risers** with allen cap screws.

Steel	Aluminum Alloy	Type	Thread
25-2207	25-2122	3"	½ — 20
	25-2121	5"	½ — 13



**Dog Bone 6" Riser Set** includes Iso bushing design with inserts for FXSTS models forks 1988-06.  
VT No. 25-2139



25-2139



Offset Dog Bones

25-2141

**Offset Dog Bones** are risers machined of solid steel and chromed includes rubber grommets in riser top vibration damper.  
VT No. Type  
25-2141 4¼"  
25-2160 5¼"  
25-2142 6¼"  
25-2213 8¼"  
28-0908 Rubbers for Above



25-2122  
Installed







# Shorty Riser



**Wyatt's Riser Set**  
**VT No. Type**  
 26-0879 Chrome  
 26-0885 Brass



**Shorty Riser Set** features 1" rise with 1/2" — 13 threads for handlebars.  
**VT No. Finish**  
 25-2184 Chrome  
 25-2221 Black



26-0255



26-0794

Chrome Short Riser Sets fit 1" bars.

**VT No. Height**  
 26-0255 3.5"  
 26-0794 1.5"



25-1928

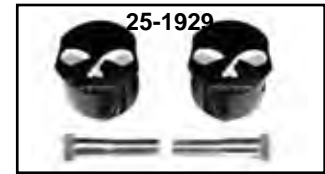

25-1929



25-1930



25-1931



25-1932



25-1933

Skull Riser Sets in black or chrome.

Chrome	Black	Size
25-1928	25-1929	2"
25-1930	25-1931	4"
25-1932	25-1933	6"

# Buffalo Riser Set



25-2118

**Chrome Tall Straight Riser Kit** is 6" tall and replaces 56223-98 for 1977-up FX and FXR. Smooth or finned top included. Longer cables, wiring or brake hose may be required.

VT No.	Type
25-2118	With finned top
25-2182	With smooth top



25-2188



25-2191

**Chrome Forged Aluminum Straight Risers** can be used with stock clamp or 26-0540 billet cap clamp. Available in 1.10" or 1.125" post diameter and use 1/2"-13" mounting bolts.

VT No.	Height	Post Diameter
25-2187	1.7"	1.10"
25-2188	2"	1.10"
25-2189	4.5"	1.125"
25-2194	5.5"	1.125"
25-2191	6"	1.125"

# Post Riser Set



25-0232



25-0558



25-0557

**Post Riser** features hidden top screw. Available in plain, flame or maltese design.

VT No.	Type	Riser
25-0232	Plain	8"
25-0558	Flame	3"
25-0557	Plain	3"



26-0588



26-0592



26-0150



26-0151



26-0593

**Chrome Solid Billet Riser Sets** feature 1/2" — 13 mount threads.

1" Inner Diameter	Size
26-0150	3"
26-0588	4"
26-0151	5"
26-0592	6"
26-0593	8"



**Riser Mount Set** with 1/2 x 13 threads.  
VT No. 25-0953



**Chrome Flush Mount Top Triple Tree Bushing Kit** includes 4 chrome steel bushings with O-rings for damping. Included are chrome allen bolts with 1/2 — 13 thread.  
VT No. 28-0240



**Handlebar Bushings** are made of Polyurethane for 25% stiffer construction than stock rubber units, and are vibration absorbent. Four piece set replaces 53156-86 & 56158-73 on FX-FXST-FXR and Dyna models.

VT No. Item  
28-0135 Bushing, four piece  
28-0232 Kit, eight piece



**Handlebar Riser Damper Kit** includes all rubber bushings, threaded studs(except where noted), washers and cups.

VT No.	Fits
28-2118	1984-85 FXRT 1985-up FXSB-EF
28-2119	1987-up FLSTC, 1987 FXR-RC-S-SP
25-2125	1984-up FLT
28-2124	1986-up FLST
28-0221	1984-up FXST, XL 1985 FXWG without studs
25-2126	1984-up FLST



**Handlebar Damper Bushings** replace original rubber type, sold in sets of 4.

VT No.	OEM	Model
28-0254	56158-73	1948-85 FXE-FLT, 1982-94 FXR
28-0255	56161-83A	1984-up FLT
28-0987	53157-97	1997-up FLSTS



**Contoured Riser Bushing Set** includes 1/2 — 13 threaded bolts.  
VT No. 28-0670

# Riser Bushing Set



**Chrome Flush Mount Handlebar Damper Kit** machined washer design with poly bushings, absorbs vibration.  
VT No. Size  
28-0670 1/2 — 13  
28-0671 1/2 — 20



**Chrome Riser Adapter Kit** allows use of custom risers on the FXSTD Deuce.  
VT No. 26-0534



**Machined Chrome Washer Four Piece Set** fits all stock rubber bushing sets. Extra heavy.  
VT No. 37-8881



**Chrome Solid Mount Kit** to replace stock rubber bushings and cap washers. Order bolt set separately.

VT No.	Item	Thread
28-0673	Kit	Billet
28-0675	Kit	Steel
2132-4	Bolts	1/2 — 20
2094-4	Bolts	1/2 — 13



**Poly Urethane Riser Bushing Set** includes 4 bushings with chrome covers.

VT No.	Fits	Year
28-0284	FX-XL	1973-up
28-2259	FLT	1983-13
28-2260	FX	1973-up

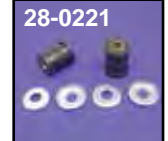

**Handlebar Damper Kit** consists of one pair of damper, spacers, top and bottom washers. Replaces 56153-73, 46159-73. Fits 1973-84 XL-FX-FL.

VT No.	Item	Finish
28-0221	Kit FX-XL-FXST-WG	Zinc
28-0228	Kit FX-XL-FXST-WG	Chrome
28-2124	Kit, FLST	Chrome
37-8881	Washers, four pieces	Chrome



**Angled Riser Solid Mount Bushing Set** allows solid and angular mounting of risers or riser bars.

VT No.	Degree
25-0986	5°
25-1096	10°



**Nylon Handlebar Damper** machined nylon, provides stiffer dampening action and longer life for 1973-83 FX.  
VT No. 28-2218





# Riser Bolt



28-0950



28-0951



28-0744

**Chrome Billet Cone Head Riser Mount Kit** includes washers, cones and bolts 3½" long.

**VT No. Bolts**

**28-0950** ½ — 20

**28-0951** ½ — 13

**28-0744** ½ — 13 Chrome 1973-up (**Washers Not Included**)



37-0528



37-0529

**Chrome Riser Bolt Kits** for threaded riser and handlebar/riser combinations. Include four cupwashers and two lockwashers.

**VT No. Description**

**37-0528** ½ — 13 — 2¾ Riser Bolt Kit includes chrome bolts and lock washers. For FLST models.

**37-0529** ½ — 13 — 2½ Riser Bolt Kit includes chrome bolts and lock washers. For 1980-up FXWG-FXST and 1993-up FLT.



37-0878

**Chrome Riser Bolt Kit** includes bolts with integral lower flange washer, and allen flush head for installation. Includes spacers and chrome top washers.

**VT No.**

**37-0881** ½ — 13

**37-0878** ½ — 20



2135-4



**Chrome Riser Bolt Sets** in allen or hex style includes lock washers. Order cupwashers separately.

Hex	Allen	Length	Thread
2135-4	2094-4	2½"	½ — 13
—	2132-4	2½"	½ — 20
—	2133-4	2¾"	½ — 20
2136-4	2095-4	2¾"	½ — 13
2137-4	2129-4	3"	½ — 13
—	2134-4	3"	½ — 20
2138-4	2130-4	3½"	½ — 13
2139-4	2131-4	3¾"	½ — 13



37-8820



**Handlebar Riser Bolts.** Replacement for the stock type riser bolts. Can also be used with V-Twin risers. Sold as pair.

VT No.	Length	Application
<b>37-8820</b>	Stock Slotted	1949-59 FL-FLH
<b>37-8450</b>	½ — 20 — 2½	1973-79 FL
<b>37-8451</b>	½ — 13 — 3¼	1980-83 FL, 1983-up XLX
<b>37-8452</b>	½ — 13 — 2¾	1984 FL, 84-up FXWG
<b>37-8453</b>	½ — 13 — 3¾	1979-up XL-XLCH 1979-82 FX 1974-up all FX-FXE
<b>37-8454</b>	½ — 13 — 2½	1979-80 XL, 1980-83 FXWG, 1984-up FXST
<b>37-8455</b>	½ — 13 — 3	1984 XL-XLX 1984-up FXE 80
<b>37-8456</b>	½ — 13 — 3½	1974-79 all XL

# 1996-up Lever Assembly

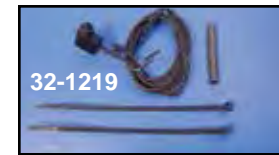
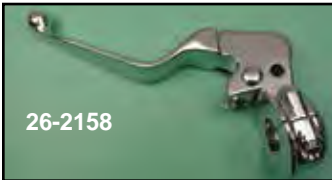

**1996-up Type Clutch Lever Bracket** includes 2 halves.

VT No.	OEM	Finish	Fits
26-2184	38608-96	Chrome	1996-14 FXST, FLST, 96-03 XL, 1996-up FXD, 1997-07 FL
26-2186	As Above	Black	As Above
26-2163	45044-96	Chrome	1996-14 FXST, FLST; 1996-13 FLT; 1996-up FXD 1996-2003 XL

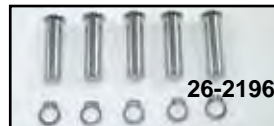

26-2212  
26-2211

**Chrome Clutch Handle Assembly** includes mount bracket, clamp and handle, assembled.

VT No.	Fits
26-2158	1996-14 FXST, FLST; 1996-up FXD; 1996-07 FLT
26-2205	2006-13 FLT
26-2158	1996-03 XL
26-2182	2004-2006 XL
26-2204	2007-13 XL
26-2211	2014-up XL
26-2212	As Above Black
32-1219	Switch; 1996-10 FXST, FLST, 1996-09 FLT, 1996-11 FXD, 1996-03 XL

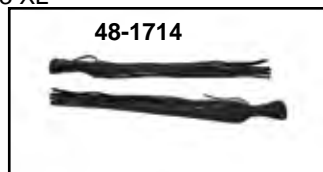

## Black Leather Accessories.

VT No.	Description
48-0550	Lever Covers
48-1714	Lever Covers with 16" fringe

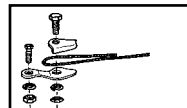

**Brake Cable Clamp** is a universal style clamp.  
VT No. 26-0508



**Chrome Lever Pins** are allen style for pivot point on 1982-14 FXST, 1986-14 FLST, 1991-14 FXD, 1982-07 FLT and 1982-03 XL.

VT No. 37-8823



**Cable Clamp** fits to hand lever for emergency or permanent use. Easy to install .460" diameter, 1 pair.

VT No. 26-0509



**Allen Screw Set for Lever Clamp** is a four piece set for 1965-72 levers.

VT No. 8797-4

## 2004-13 Chrome Pieces for XL's.

VT No.	OEM	Item	Fits
26-2194	42807-04	Clamp/Bracket	2004-13
26-2195	38671-04	Bracket	2004-13
26-2196	42807-04	Lever Pin	2004-13
26-2198	45799-04	Spring	2004-13

## Lever Control Hardware

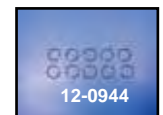
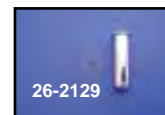

**Hand Lever Pivot Pins** for brake and clutch sides.

VT No.	OEM	Item	U/M
26-1979	45032-82	1982-14 Pin	5 pack
26-0507	45031-65	1965-81 Pin and Clip	10 pack
26-0544	—	1965-81 Pivot Pin Set w/grease fitting	
12-0939	11036	Clip for Above	10 pack
26-2129	45032-82	Pin 1982-14	Each
12-0944	11143	Snap Ring for Above	10 pack

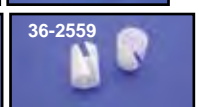
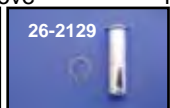
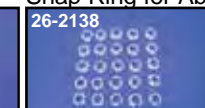
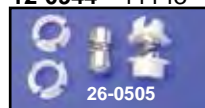

## Lever Pins/Bushings

VT No.	OEM	Item	Year	U/M
26-0505	45036-68	Bushings	1968-87	10
26-2138	45039-68	Nylon Bushing	1968-87	25
26-2129	—	Pin	1982-14	Each
26-1979	—	Pin	1982-14	5
26-2132*	45036-88	Bushings	1988-up	Each
36-2559	45423-92	Lever Bushings	1992-up	10

\*Note: Teflon pin fits 1988-up eyelet clutch cables





# Hand Lever Set for 1996-up



Chrome Smooth



Chrome Skull



Black Skull



Chrome Drilled



Black Drilled

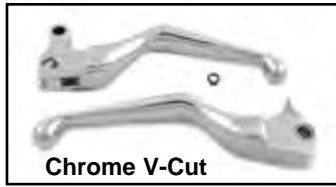

Chrome V-Cut

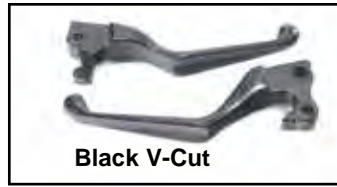

Black V-Cut



Chrome 5 Hole

Contour Levers designed for easy grip, pairs.

Fits Softail-FXD models.

Chrome	Black	Year	Type
26-2178	—	1996-07	Smooth
26-2189	26-2109	1996-07	Skull Ends
26-0787	26-1156	1996-07	Skull Ends
26-0788	26-0984	1996-07	Drilled
26-0789	26-0111	1996-07	Slotted
26-0780	26-0982	1996-07	V-Cut
26-0781	—	2008-14	Slotted
26-0785	—	1997-07	5 Hole
26-0743	—	2008-14	V-Cut
—	26-1186	2008-14	Skull Ends

Fits Sportster

Chrome	Black	Year	Type
26-2178	—	1996-03	Smooth
26-0788	26-0984	1996-03	Drilled
26-0789	26-0111	1996-03	Slotted
26-2189	26-2109	1996-03	Skull Ends
26-0787	26-1156	1996-03	Skull Ends
26-0780	26-0982	1996-03	V-Cut
26-0785	—	1996-03	5 Hole
26-2193	—	2004-06	Smooth
26-0783	26-0819	2004-06	Drilled
26-0782	—	2004-06	Slotted
26-0784	26-0114	2007-13	Slotted
26-2203	26-0983	2007-13	V-Cut
26-0797	26-0980	2007-13	Smooth
26-0786	26-0820	2007-13	4 Hole
26-0466	26-0467	2014-up	Smooth
26-0802	26-0805	2014-up	OEM Style
26-0803	26-0806	2014-up	2 Slot
26-0804	26-0807	2014-up	4 Hole

Fits Touring models.

Chrome	Black	Year	Type
26-2156	—	1985-95	Skull Girder Style
26-2178	—	1996-07	Smooth
26-0788	26-0984	1996-07	Drilled
26-0789	26-0111	1996-07	Slotted
26-0741	26-0981	2007-13	Smooth
26-0895	26-2113	2008-13	Slotted
26-0763	26-0762	2008-13	4 Hole
26-0765	26-0940	2014-up	Smooth
—	26-0768	2014-up	Smooth



Trigger Lever Sets replace stock levers. Fit 1996-07. VT No. 26-0415



Chrome Billet Flame Control Set fits 1996-07 FX-FXD and 1996-03 XL. VT No. 26-0989

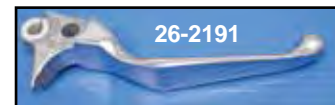

VT No.	Year	Type
26-2190	1996-07	Clutch
26-2191	1996-07	Brake



**1941-64 Replica Brake Clutch Handle** features accurately formed clamp and cadmium plated hardware. Replaces 45002-41.

**VT No. Item**  
**26-0541** Lever Assembly  
**26-0947** Pin Kit



**Replica Lever Assemblies** include slotted lever bushing as original with small hole for brake or clutch.

VT No.	#	OEM	Finish
26-2127	A	45002-41	Chrome, Complete
26-2126	A	45002-41	Polished, Complete
26-0583*	—	—	Parkerized *Note: Bushing is not included.
26-0948	—	—	Front Hand Parking

**Ball End Stainless Style Assemblies**

26-0522	B	5/16"	Polished, Complete
26-0152	—	—	Polished, Screw-In Type
26-0779	—	3/8"	Hole Polished

**Ball End Levers.**

26-2192	—	—	Chrome Stock Lever Only
26-2206	—	—	Polished Stock Lever Only
26-0542	—	—	Lever Clamp Strap
26-0344	—	—	Lever Strap, Parkerized
26-0342	—	—	Lever Strap, Zinc
8819-4	45031-41	1941-64	Pin and Nut, Cadmium
26-0506	45033-49	1949-64	Lever Bushing with cotter
2809-3	—	1949-64	Bushing, Cadmium
2730-3	—	1941-48	Bushing, Cadmium
26-0423	Kit	—	Rebuild



**1965-72 Glide Cable/Handle Assembly.**

**VT No. Finish**  
**36-0576** Polish  
**36-0577** Chrome



**Alloy Lever Assemblies** exact as original.

VT No.	Year	Finish
26-0950	1941-48	Polish
26-0951	1941-48	Chrome
26-0953	1949-64	Polish
26-0954	1949-64	Chrome
26-0957	1940-43	Polish

# Handlebar Lever



**Clutch and Brake Lever Assemblies** include cable pin. Available with 3/8" or 5/16" hole sizes for cable entry. 26-2167 & 26-2168 accept front brake switch.

Chrome	Polished	OEM	Hole	Fits
26-0523	26-0524	38608-68	3/8"	1968-72 Big Twin Clutch
26-0525	26-0526	45002-65	5/16"	1941-68 Big Twin Brake 1952-67 Big Twin Clutch
26-2167	26-2168	45002-69	5/16"	1969-72 Big Twin Brake
—	26-0426	—	5/16"	Parking

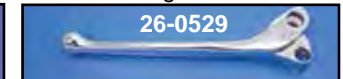

**Clutch and Brake Levers** are available in polish or chrome.

VT No.	OEM	Years	Finish
26-0530	45024-65A	1965-81	Polished
26-0529	45024-65A	1965-81	Chrome



**Replica Brake Lever Complete Assembly** is an authentic reproduction, complete as pictured for 1928-40 Spring fork models.

VT No.	Finish
26-2134	Chrome
26-0945	Parkerized
36-0453	Kit, Parkerized



**Spring Fork Cable and Handle Kit** for 1941-48 Big Twin. Includes replica style cable with oiler fitting and end ferrules, polished or chrome handle and clamps to attach cable to bars and fork leg.

VT No.	Type
36-0414	Polished
36-0418	Chrome



**Chrome Skeleton Brake and Clutch Hand Lever Set.** Fits 2004-13 XL.  
**VT No. 26-0119**



**Hand Lever Assembly** is for brake or hand clutch use and features a burnished finish. Fits 1941-1964 FL.  
**VT No. 26-0739**





# Control Dress Kit



**Dress Kit** with switch housings fits 1996-05 FXST, FLST, 1996-03 XL models. with single disc.

**VT No. 26-0546**



**1996-up Chrome Control Dress Up Kit** includes clutch lever bracket, handlebar control clamps, master cylinder top and body cover with levers and hardware for disc models as noted.

VT No.	Year	Model	Disc
26-0538	1996-03	XL	Single
	1996-05	FXST-FLST	Single
	1996-05	FXD	
26-0549	1996-03	XL	Dual
	1996-05	FXST-FLST	Dual
	1996-05	FXD	



**32-1667**



**32-1668**

**Extended Turn Signal Caps.**

**Chrome Black Fits**

**32-1666 32-1667** 2012-up FXD, 2011-up FXST, FLST

**32-1668 32-1669** 1996-up XL, 1996-2013 FL, 1996-11 FXD



**26-0115**



**26-0116**

**Chrome Adjustable Lever Set.** Features hidden adjustment screw that allows the lever to be moved in closer to handlebar controls.

**26-0115** 1996-12 BT

**26-0116** 2004-12 XL

**26-0117** 2008-up FLT



**Standard Backlit LED Handlebar Switches and Wiring Harness** without switch housing. LED is amber and wires are 60" in length.

**VT No. Models**

**32-1135** 2007-up FXST-FXD

**32-1272** 1996-06 FXST-FXD

**32-1273** 1996-06 FXST-FXD



**26-0580**

**Chrome Power Wide Lever Sets** replace stock levers on 1972-81.

**VT No. 26-0580**

## 1972-95 Lever



**26-2170**



**26-2171**



**26-2162**

**Chrome Contour Levers** designed for easy grip, pairs.

**VT No. Year**

**26-2170** 1972-81

**26-2171** 1982-95

**26-2162** 1982-95 Polished

**26-2110** 1982-95



**26-1975**



**26-1974**

**Chrome Soft Pad Hand Levers** feature a comfortable rubber insert  $\frac{3}{8}$ " thick locked into a tongue-and-groove channel.

**VT No Fits**

**26-1975** 1982-95

**26-1974** 1972-81

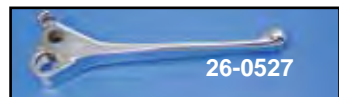

**26-0527**



**26-0528**



**26-0519**



**26-0531**

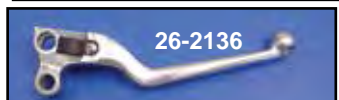

**26-2136**

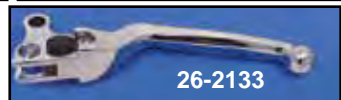

**26-2133**

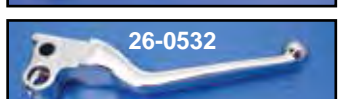

**26-0532**

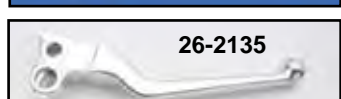

**26-2135**

**Clutch and Brake Levers** are available in polished or chrome. Sold individually.

Chrome	Polish	OEM	Years	Type
26-0527	<b>26-0528</b>	45016-72	1972-81	Brake
	<b>26-0517</b>	Power	1972-81	Brake
	<b>26-0519</b>	Power	1972-81	Brake
<b>26-0531</b>	<b>26-2136</b>	45017-82	1982-95	Clutch
<b>26-2133</b>		45017-88	1988-95	Clutch
<b>26-0532</b>		45016-82	1982-95	Brake
	<b>26-2135</b>	45016-82	1982-95	Brake



**Chopped Handlebar Master Cylinder and Control Housing Set** for 1996-10 models. Fits 1996-10 FXST, FLST, 1996-up FXD, 1996-up FLT without cruise radio controls, 1996-03 XL.

VT No.	Bore
22-0813	9/16"
22-0814	1 1/16"



**Hand Lever Set** fits 2014-up FLT.

**Chrome Black Style**

26-0798	26-0799	Vortex Lever Set
26-0800	26-0801	Drilled Lever Set
26-0803	26-0806	Slotted Lever Set
26-0804	26-0807	Drilled Lever Set
26-0802		OE Style

# Handlebar Control



**Chrome Handlebar Control Cover Kits** include master cylinder cover, clutch mount and two clamps for single disc application.

VT No.	Model	Disc
26-0746	2008-up FLST-FXST	Single
26-0180	2006-07 FXD, FLST, FXST	Single
22-0876	2007-13 XL	Single
26-0536	1996-05 FXST, FLST, FXD 1996-03 XL	Single
26-0537	1996-05 FXST, FLST, FXD 1996-03 XL	Dual



**Black Front Master Cylinder** has a 1/2" bore and includes the brake lever, stop light switch, reservoir cover, and all internal components. OEM# 45010-73. Fits 1972-1981 FL, FX, XL, VT No. 26-2097





# Control Kit



22-0822  
Smooth Contour Handlebar Control Kit for custom applications.  
VT No. 22-0822

Models & Description	Bore Size	Kit without wiring	
		Chrome	Black
82-83 Dual Disc	3/4"	22-1069	
84-95 Single Disc	5/8"	22-1076	22-1164
84-95 Dual Disc	11/16"	22-1099	
96-06 Single Disc	9/16"	22-0804	22-1165
96-06 Dual Disc	11/16"	22-0803	22-1166
96-06 Single Disc with slight hole	9/16"	22-0820	22-1161
96-06 Dual Disc with slight hole	11/16"	22-0821	
96-06 Single Disc chopped down	9/16"	22-0813	
96-06 Dual Disc chopped down	11/16"	22-0814	
07-up Single Disc	9/16"	22-0877	22-1160
96-07 FLT Dual Disc with radio	11/16"	22-0883	
96-07 FLT Dual Disc with radio & cruise	11/16"	22-0881	
08-up FLT Dual Disc with radio	15mm	22-0880	
08-up FLT Dual Disc with radio & cruise	15mm	22-0882	



For XL			
Models & Description	Bore Size	Kit without wiring	
		Chrome	Black
04-06 XL Single Disc	1/2"	22-0825	22-0835
04-06 XL Dual Disc	9/16"	22-0826	22-0836
07-13 XL Single Disc	1/2"	22-0876	22-0837
07-13 XL Dual Disc	9/16"	22-0884	22-0838
2014-up XL without ABS	1/2"	22-0839	22-0840
2014-up XL without ABS	14mm	22-0841	22-0842



# Control Kit



22-0823

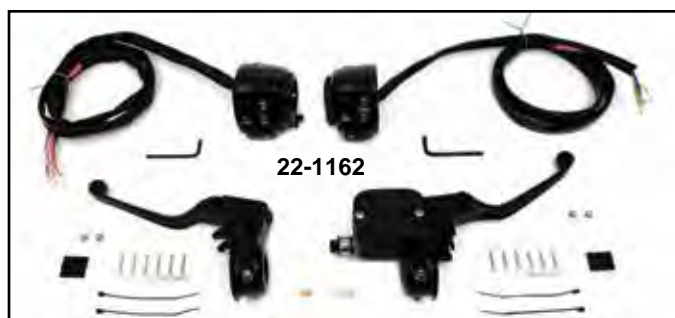

22-1162

Fits	Bore Size	Kit with wiring		Brake Assembly	
		Chrome	Black	Chrome	Black
82-83 Dual Disc	3/4"			26-2145	26-2153
84-95 Single Disc	5/8"			26-2120	26-2122
84-95 Dual Disc	1 1/16"				26-2154
96-06 Single Disc	9/16"	22-0823	22-1162	26-2180	
96-06 Dual Disc	1 1/16"	22-0824	22-1167	26-2179	
96-06 Single Disc with slight hole	9/16"	22-0817	22-1168		
96-06 Dual Disc with slight hole	1 1/16"	22-0818			
07-13 Single Disc	9/16"	22-0894	22-1163		

## For XL

Fits	Bore Size	Kit with wiring		Brake Assembly	
		Chrome	Black	Chrome	Black
04-06 XL Single Disc	1/2"	22-0857			
04-06 XL Dual Disc	9/16"	22-0858			
07-13 XL Single Disc	1/2"	22-1524			
07-13 XL Dual Disc	9/16"	22-0885			
2014-up XL without ABS	1/2"			26-2213	26-2214
2014-up XL with ABS				26-2215	26-2216

# Switch Housings

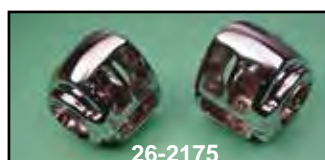

26-2175

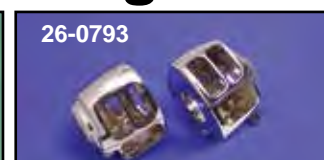

26-0793



26-0796

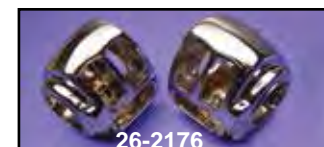

26-2176



26-2177



26-0127



26-0128

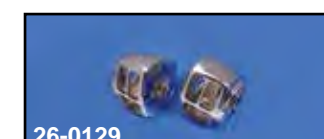

26-0129

**1996-up Switch Housing Kits** includes left and right upper lower housing. Order switches, wiring and adjuster separately.

VT No.	OEM	Type	Fits
26-2175	70222-96	Stock	1996-2006 VRSC, XL, XR, FXD and FLHR models. 1996-2006 ST models. Does not fit FXSTDSE and FLHRSEI2 models
26-0793*	70222-96B	Stock	2007-2011 FXD, XL, VRSC models, 2007-2010 ST models
26-0796*	70222-96B	Stock	As Above w/OE style throttle lock screw
26-2176	70222-96C	Stock	1996-2007, FLHTC & 2006-up FLHX FLHXXX & FLTRX models without cruise control
26-2177	70228-96C	Smooth	1996-2007 FLHTCU, FLHTCUTG, FLHTK, FLTR, FLTRU and 2002-up FLHRC models. 2002-up FLHR models equipped with cruise control
26-0127		Smooth	2008-up FLTCU, FLHTCUTG, FLHTK, FLTR, FLTRU and 2002-up FLHRC, 2002-up FLHR models equipped w/o cruise control
26-0128		Smooth	2008-up FLHTCU, FLHTCUTG, FLHTK, FLTR, FLTRU and 2002-up FLHRC models. 2002-up FLHR models equipped with cruise control
26-0129		Smooth	2008-up FLHR
26-0986	71826-11	Smooth	2012 FXD & 2011-up ST models
26-0007			Handlebar Throttle Adjuster Screw Kit Adjuster

\*Note: Has provision for clutch lock-out switch.

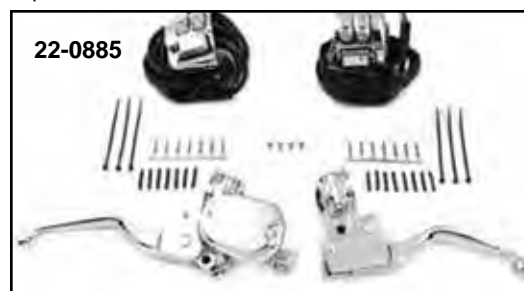

22-0885





# 1996-up Control Kit



22-0378



26-0590

**Chrome Smooth-Contour Control Kit** features a hidden underside mounting on the switch housings for an unobstructed smooth, rounded surface on the top housing. Switch housings use stock or chrome rounded switches (introduced on 1996 models). Complete kits include clutch and brake levers, master cylinder, hydraulic clutch, switch housings, brackets and hardware. Both master cylinders have 1/16" bore for single or dual disc.

VT No.	Style
22-0378	Contour
26-0590	Lever Set



32-0263

32-0264



32-1360



32-1364



32-1378



32-1380



35-0856



35-0857

**Button Switches.**

VT No.	Finish	#
32-0263	Chrome	2
32-0264	Black	2
32-1360	Black	1
32-1364	Black	2
32-1378	Chrome	1
32-1380	Chrome	2
35-0856	Black Throttle Housing	
35-0857	Chrome Throttle Housing	



22-0804



22-0823

**Chrome Handlebar Control Kit** includes complete chrome master cylinder, clutch handle with clamp and two pairs of chrome switch housings. Available with or without chrome switches as listed. **All kits include stainless steel hardware.**

With	Without	Fits	Bore	Disc
22-0823	22-0804	1996-06 FXST-FLST 1/16"		Single
		1996-03 XL, 1996-05 FXD		
22-0894	22-0877	2007-10 FXST-FLST 1/16"		Single
		2006-up FXD		



26-1012



26-1013

**Vintage Style Control Kits** are available in black or chrome finish.

9/16" Bore	Finish
26-1012	Chrome
26-1013	Black

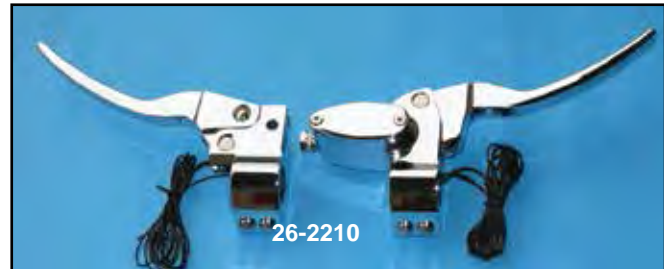

26-2210

**Chrome Handlebar Control Kit** includes 5/8" brake master cylinder and micro switches on right and left sides.

VT No. 26-2210



**Chrome Billet Handlebar Control Kit** fits 1982-95 and 1996-up with the purchase of 1982-95 style switches and some modification. Master cylinder is 5/8" bore. 23-0631 includes top and gasket.

VT No.	Item/Type
22-0759	Kit Cable
23-0631	Master Cylinder Rebuild

# Handlebar Control for 1996-up FX-XL

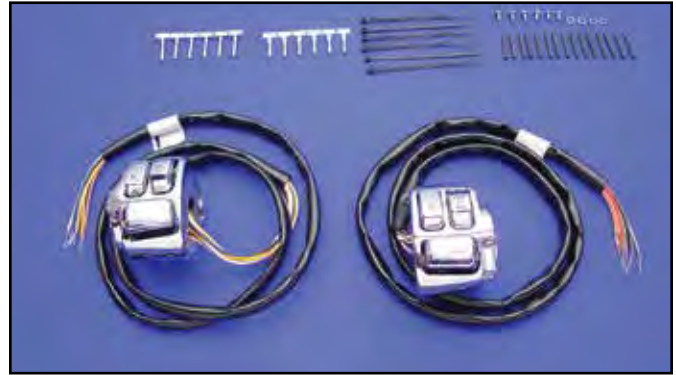

**1996-up FX-XL Chrome Switch Housing Kit** includes 48" long wiring harness, chrome switch housings with chrome switches and hardware. screws.

VT No. **32-0561**



**Switch Housing Kits** includes left and right upper lower housing. Order switches, wiring and adjuster separately.

VT No.	Model	Style	Type	Year
26-2175	FXST	Stock	Stock	1996-10
26-0796	As Above	Stock	Stock	1996-10
26-0793*As Above	As Above	Stock	Stock	1996-10
26-0986	Chrome	Stock		2011-up
26-0988	Black	Stock	Stock	2011-up
26-0843	Chrome			2016-up
26-0847	Black			2016-up

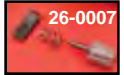

**26-0007** Kit Adjuster

\*Note: Has provision for clutch lock-out switch

**Allen Chrome Handlebar Switch Housing Screw Kit** fits 1996-up. VT No. **9776-10**



**Throttle Adjuster Kit.**  
VT No. **26-0007**

## Handlebar Switch Kits with wiring.

VT No.	OEM	Year/Model	Item	Finish
32-0752	Set	1996-06	7 Piece Set, (60")	Black
32-0540	Set	1996-06	7 Piece Set, (48")	Chrome
32-0816	Set	1996-06	7 Piece Set, (106")	Chrome
32-0578	Set	1996-06	7 Piece Set, (60")	Chrome
32-1272	Set	1996-up LED	60"	Chrome
32-1273	Set	1996-up LED	60"	Black
32-0848	Set	2007-up XL, FXD		Chrome
32-0849	Set	2007-up XL, FXD		Black
32-0996	71685-06	2006-up FXD	Left	
32-7000	71589-96		Engine-Start-Stop	Black
32-7001	71590-96		Stop Light 6" Wire	Black
37-0994	71509-00		Stop Switch Shim	
32-7002	71591-96		Right Turn Signal	Black
32-7003	71597-96		Dimmer Horn	Black
32-7004	71598-96		Left Turn Signal	Black
37-0882	2955		Switch Mounting Screw, 10 pack	
32-1219	71584-96B		Clutch Handle Switch	



## Chrome Handlebar Control and Reservoir Cover Set

includes clutch lever bracket, handlebar control clamps, master cylinder top and body cover, and hardware for complete installation. Fits 1996-05 FXST, FLST, FXD, 1996-03 XL models.

VT No.	Disc
26-0536	Single
26-0537	Dual



**Chrome Switch Cover Set.** Snap on covers replace existing black switch covers. Fits FX-XL-FXD.

VT No.	Year
32-0562	1996-10
26-0990	2011
26-0991	2012-up
26-0844	2012-up

MULTI FIT/CHOPPER





# 1982-95 Control Kit



**1982-95 Chrome Switch Housings and Chrome Switch Assembly** includes 48" long leader wires and internal mount screws.  
**VT No. 32-0560**



**Chrome Handlebar Control Kit** includes complete chrome master cylinder, clutch handle with clamp and 2 pairs of chrome switch housings. Master cylinder includes a clamp with both a 10mm and a 12mm bolt. All kits include stainless steel hardware.

VT No.	Years	Item	Bore
22-1069	1982-83	Kit	3/4"
22-1076	1984-95	Kit	5/8"
22-1099	1982-95	Kit, Dual Disc	1 1/16"

*When rebuilding 1982-95 front master cylinder check that bleed back passage is clear*



**1982-95 Handlebar Switch Housing Set** is a four piece chrome set, replace upper and lower of right and left sides including stainless buttonhead screws. Use existing wiring and switches for assembly.

VT No.	Item
26-2149	1982-95 Set, All Models
26-0548	1982-95 Set, All Models
37-8940	25 Screws, OEM 2508 (Buttonhead Stainless)

**Chrome Allen Switch Housing Screw Sets** for 1982-95.  
**VT No. 8767-10**

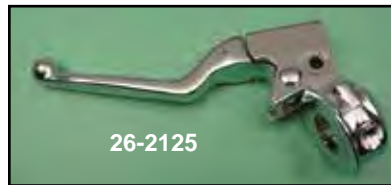

**Clutch Lever Assembly** for 1982-95 models.

VT No.	Item	Finish
26-2125	Assembly	Chrome
26-2188	Assembly	Black
26-2137	Clamp and Bracket	Chrome
26-2165	Clamp and Bracket	Black



**1982-95 Handlebar Switch Kit** includes complete right and left switch assemblies, brake light switch, mounting screws and clips. Individual switches also available.

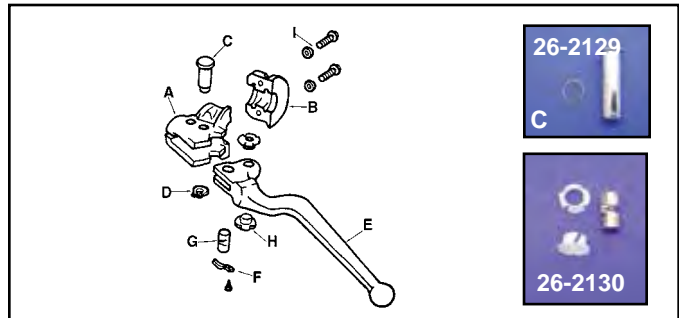

Black	Chrome	Item
32-8084	32-9208	1982-95 Switch Kit
32-8000	32-9070	Left turn signal
32-8001	—	Engine, Stop-Start
32-8002	—	Right turn signal
32-8003	—	Dimmer and Horn
32-7782	—	Stop switch, front

**Hardware for Above, Note: Finish is Not Black**

37-8966	—	25 screws pack, zinc
37-0006	—	Spacer, zinc, 5 pack

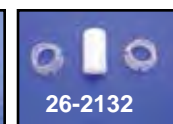
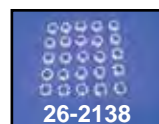

**Clutch Lever Components for 1982-95.**

VT No.	#	OEM	Item
26-2137	A	38608-82A	Bracket and
	B	45044-82	Clamp, Chrome
26-2165		As Above	Black
26-2146	B	45044-82	Black Clamp
26-2147	B	45044-82	1982-95 Chrome Clamp
26-2129	C	45032-82	Lever Pin with snap ring
26-1979		45032-82	Lever Pins Only five pack
12-0944	D	11143	Snap Ring
26-0531	E	45017-82	1982-88 Clutch Lever
26-2133		45017-88	1988-up Clutch Lever
26-2164		45017-93	Clutch Lever
26-2140	F	45021-86	Anti-Rattle Spring
26-2130	G	45036-82	Cable Pin
26-2132		45036-88	Nylon Cable Pin
26-2138	H	45039-68	Pin Bushing
26-0400	I	Kit	Chrome Kit, four piece



**Handlebar Wiring Harness Kits** are color coded.

VT No.	Years	Type
32-8010	1982-90	Stock
32-8009	1982-90	Extended



# 1972-81 Control

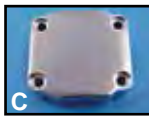
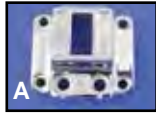

## Switch Housing

VT No.	#	Years	Finish	Item
26-0513	A	1973-81	Chrome	Switch Housing
26-2093			Black	
26-0628	A	1973-81	Black	As Above
26-0642	A	1973-81	Polished	As Above
26-0631	B	1972	Chrome	Horizontal Switch Housing
26-0629	B	1972	Black	As Above
26-0514	C	Smooth	Chrome	Plain Switch
26-0630	C	Smooth	Black	As Above
26-2160	C	Smooth	Polished	As Above

## 32-8071



**Handlebar Wiring Harness** with chrome or black switches and hardware which already having soldering done. Includes wire connectors, buttons, screws, stop light switch rubber boot and switch retaining plates. Fits 1973-81

Big Twin is color coded to match stock wires at 40" long, kit will fit tall handlebars.

VT No.	Type
32-8071	Black
32-8208	Chrome



**Control Box Decal Set** includes decals for both right and left handlebar switch boxes for Twins 1973-81.  
VT No. 48-0415

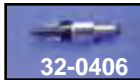
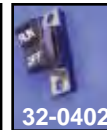
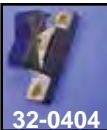
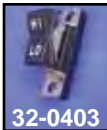

**Handlebar Switches** for 1972-81 models. Available with or without wire. \*Note: 32-0395 is 5 pack.

W/o wire	W/o wire	With wire	Type	Style
10 pack	Each	Each		
32-0395*	32-0403	32-8933	Hi-Low	Rocker
32-0391	32-0404	—	Plain	Rocker
32-0394	32-0402	32-8931	Run-off	Rocker
32-0392	32-0406	32-8930	Brake	Button
32-0393	32-0405	32-8919	Starter	Button
32-0393	32-0405	32-8920	Horn	Button
32-0408	—	—	Long	Button
			Cap 5/16"	1972-Early1973
32-0407	—	—	Short	Button
			3/16" Late 73-81	

**Switch Control Assortment** for 1972-81 models saves time and money on dimmer, starter-horn button hardware. Note quantities supplied. Included are the following:

VT No. 32-0320 for entire assortment

Qty	Switch	Quantity	OEM	Switch
2	Hi-Low	10	71535-72	Long
6	Brake	10	71534-72	Short
2	Run-off	2	71482-72	Plain
6	Starter and Horn			



**Handlebar Wiring Harness Kits** are color coded.

VT No.	Years	Type
32-9316	1970-71	Handlebar Wires Stock
32-8005	1973-81	Stock
32-0708	1973-81	Extended



**Handlebar Control Kit** for 1972-81 includes complete master cylinder with clamp, clutch handle with clamp, switch housings and bracket. Order with or without black switch kit.

VT No.	Item	Finish
26-2148	Without Switch Wiring	Chrome
26-2185	With Switch Wiring	Chrome
26-2187	Without Switch Wiring	Polished
26-2209	With Switch Wiring	Polished
26-2093	Without Switch	Black



**1973-81 Clutch Lever Assembly** order switch housing separately from the above list.

VT No.	Finish	Item
26-0535	Chrome	Clutch Lever Assembly
26-2131	Polished	As Above
26-0511	Chrome	Clutch Lever Mount
26-0512	Polished	As Above
26-0627	Black	As Above



**Handlebar Switch Repair Kit** includes four screws, two retainer clips for button switches (71533-72) and 4 button black caps. Fits 1973-81.

VT No.	Item
32-1555	Kit
31-1988	Clips, 10 pack



**Chrome Switch Housing Screw Sets** for 1973-81.

Colony	VT No.	Style
8766-10	8766-10T	Allen

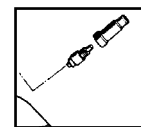

**Rubber Stop Switch Caps** protects the stop switch from moisture.

VT No.	Application
28-2114	1972-81 Front
32-0748	Switch Terminal

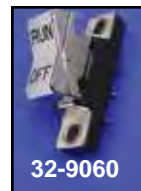

**Chrome Switches and Buttons** for 1972-81.

VT No.	Item	Type
32-9060	Rocker Switch	Run-off
32-9061	Rocker Switch	Hi-Low
32-9062	Rocker Switch	Plain
32-9063	Button Cap (10)	Long
32-9064	Button Cap (10)	Short







# Master Cylinder Cover



## Front Master Cylinder Covers.

Smooth	Years	Type
23-9188	1972-81	FX-FL-XL
23-9189	1982-84	FX-FL-XL
23-9187	1985-95	FX-FL-XL
24-0649	1985-95	FX-FL-XL
23-0901	1985-95	FX-FL-XL
23-0794	1985-95	FX-FL-XL
24-0604**	1996-05	FX-FL-XL
23-0779**	1996-05	FX-FL-XL
24-1279	1996-05	FX-FL-XL

\*\*Note: Fits 1996-03 Sportster models, 1996-2004 FLT models and 1996-05 FXST, FLST.

Smooth	Years	Type
23-0969	2008-up	FLT Brake
23-0782**	1996-05	XL-FX-FL
23-9263*	2004-06	XL
23-0944	2004-16	XL
23-9267	2007-up	XL
26-0179	2005-07	FLT
	2006-14	FXST-FLST
24-1764	2015-up	FXST-FLST
23-9317	2014-16	FLT Clutch
23-9426	2017-up	Trike



Milled	Years	Type
24-0927	1985-95	
23-0781*	1996-05	
23-9160	1984-95	
Finned		
24-0601	1979-84 Rear FL, 80-82 Rear FXWG	
23-9190	1982-96 Rear	
23-0617	1979-84 Rear FL, 80-82 FXWG	

\*Note: Includes top gasket, view plug and screw.



Eagle Spirit Master Cylinder Covers are available for the years listed in chrome or with gold inlay.

Chrome	Gold	Years/Type
—	24-0631	1982-85 Front
24-0629	24-0632	1985-95 Front

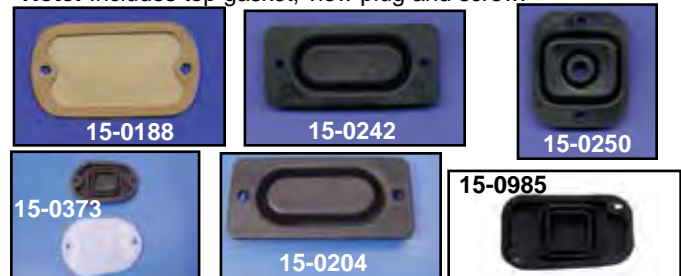

## Front Master Cylinder and Reservoir Top Gaskets.

VT No.	Year
15-0188	1972-81
15-0204	1982-84
15-0242	1985-95
15-0250*	1996-2005
15-0373	2004-up (Sportster Only)
15-0985	2015-up FLT-FXST



# GMA Handlebar Control



GMA Master Cylinders with switch housing to accept stock switches. Order matching clutch lever assembly and left side switch housing separately.

VT No.	Bore	Year	Lever Assy	Year
—	3/4"	1982-95	26-0641	1996-up
26-0638	5/8"	1996-up		
26-0639	3/4"	1996-up		
23-1716	3/4"	Rebuild Kit		



# Front Master Cylinder

Front Master Cylinder Assemblies complete with internals and lever, assembled.

VT No.	OEM	Item	Finish
1972-81			
26-0624	45010-73	Assembly	Chrome
26-2099	45010-73	Assembly	Polish
26-0110	45010-73	Body Only	Raw
26-0513	Vertical	Switch Housing 1973-81	Chrome
26-0631	Horizontal	Switch Housing 1972 only	Chrome
26-0514		Smooth Cover	Chrome
23-1719	45063-72	Rebuild Kit for Above	
1982-95			
26-2145	45013-82A	3/4" Bore, 10mm banjo line	Chrome
26-2153	As Above		Black
26-2120	45019-85	5/8" Bore, 12mm banjo line	Chrome
26-2122	As Above		Black
26-2166	45013-85B	1 1/16" Bore, 12mm banjo line	Chrome
26-2154	As Above		Black
26-2146	45044-82	Clamp	Black
26-2147	45044-82	Clamp	Chrome
26-0400		Screw Kit for Clamp	
32-7782	71574-82	Front Brake Switch	
23-1716	45063-82	Rebuild kit 3/4"	
23-3021	45069-84	Rebuild kit 5/8"	
23-3020	45006-87A	Rebuild kit 1 1/16"	
1996-2003 XL	1996-10 FXST, FLST, 1996-up FXD, FLT		
26-2179	45013-96	Complete 1 1/16" bore, Dual	Chrome
26-2180	45019-96	Complete 9/16" bore, Single	Chrome
23-1714	45006-96	Rebuild Kit 9/16"	
23-1715	45072-96	Rebuild Kit 1 1/16"	
26-2163	45044-96	Clamp	Chrome
2004-06 XL Only			
26-0576	42307-04	Complete, Single	Chrome
26-2201	45052-04	Complete, Dual	Chrome
23-1788	42803-04	Rebuild Kit, Single	
23-1787	42809-04	Rebuild Kit, Dual	
2007-up XL Only			
26-0582	45146-07	Complete, Dual	Chrome
23-0288	42803-07	Rebuild Kit, Single	Chrome
2008-up Touring			
23-1055	44551-08	Dual Disc	Chrome

## Rebuild Kit



Handlebar Master Cylinder Rebuild Kits. Each kit contains parts necessary for complete rebuild.

VT No.	OEM	Years	Fits
23-1738	Complete	1972-81	FL
23-1988	Fitting	1972-81	FL
23-1719	45063-72	1972-81	All
23-1739	Complete	1972-81	XL/FX
26-0622	Fitting	1972-81	XL/FX
23-1716	45063-82	1982-85	3/4" Bore
23-3021	45072-87	1985-95	All 5/8" Bore
		1996-up	FXST, FXD, FLT
23-1714	45006-96	1996-2003	XL, 9/16" Bore
		1996-up	FXST, FXD, FLT
23-1715	45072-96	1996-2003	XL, 1 1/16" Bore
		1996-up	FXST, FXD, FLT
23-1787	42803-04	2004-06	XL, Dual Disc
23-1788	42809-04	2004-06	XL, Single Disc
		2007-up	XL
23-1825	42809-07	2007-13	XL, Dual Disc
23-1826	4170087	2014	XL, Single Disc Non ABS
23-1827	4170084	2014-up	XL, Single Disc w/ABS
23-1825	42809-07A	2007-13	XL, Dual Disc
23-1826	4170087	2014	XL, Single Non-ABS
23-1827	4170084	2014-up	XL, Single With ABS
12-0984	11063		Retaining Ring, 1972-81
23-0590	45059-72		Spring Cup
23-0825	45056-77		Piston Cup
28-2002	45042-82		Fluid Level Window, 1982-2005 with seal
13-0152	45071-72A		Plunger Spring 1972-81

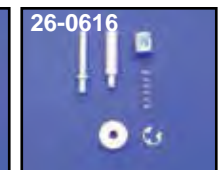

Master Cylinder Plunger Assembly Complete Kit includes all parts pictured. Fits 1972-81.

VT No.	Type
26-0547	W/MC Rebuild
26-0616	Hardware Only

## 1982-95 Front Brake Pushrod Parts.

VT No.	OEM	#	Item
26-2141	Kit		A&B Rod Barrel Set
	45051-82	A	Pushrod
	45031-82	B	Pivot Barrel
26-2139	45031-82	B	Pivot Barrel

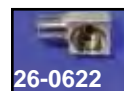
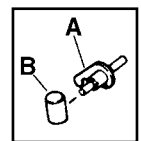

Brake Hose Fittings for front master cylinder, chrome.

VT No.	OEM	Model	Type
26-0622	43307-78	FX-XL	Angle
23-1988	63609-72	FLH	Straight
23-0517			Converts 10mm late threads to 1/8" NPT with inverted flare, early thread hose type, straight.





# Primary Chain



19-0583



19-0362



19-0932

## Diamond Endless Primary Chains

VT No.	Size	Year	Model
19-0361	428x2-76	1979-06	FLT-FXR
19-0368	428x2-74	1994-06	FLT
19-0360	428x2-82	1986-06	Softail
		1991-05	FXD
19-0786	428x2-92	2007-up	Softail
19-0583	428x2-86	2007-up	FLT

## Primary Chains for XL.

VT No.	Year	Brand	Length
19-0362	1957-03	Diamond	94
19-0932	1957-03	TYK	94
19-0369	2004-up	Diamond	96

# Rear Chain



"530 QR" Solid Roller Chains is a solid roller chain recommended exclusively for motorcycles originally equipped with non-O-Ring chain. Heat treated and shot peened for greater durability, pre-stressed and pre-stretched to minimize initial stretch.

QR	Size
19-0512	108
19-0514	112
19-0559	130



**Replacement Safe-T-Lock Spring Clip** for use with any Tsubaki as an added safety precaution. Assures the master link does not come apart and adds extra strength to the master link. This clip should not be used more than once, 50 pack.  
VT No. 19-0551



**530 Sigma O-Ring Chain** with 10,600 lbs. tensile strength, features heavy-duty, wide-waist link plates for increased durability. Solid and projected shouldered bushings utilize Tsubaki's unique

Micron Control technology for concentricity and cylindrical accuracy. Micron Control production technology has decreased initial stretch to .01% and increased wear life up to 100% over conventional chain. Sigma is perfectly proportioned to provide extraordinary strength with minimum weight.

Standard S Series	Size	Standard S Series	Size
19-0540	102	19-0554	130
19-0541	104	19-0555	150
19-0542	106	19-0547	Connecting Link
19-0543	108		
19-0545	112		



**530 HSL Tsubaki** is a virtually maintenance free chain that has heavy duty shot-peened side plates sintered metal bushings and quad-staked riveting.

**Nickel-plated HSL/NP** is available in a gleaming rustless finish. Average tensile strength: 7,040 lbs. HSL series is recommended exclusively for bikes originally equipped with non O-Ring chain.

HSL	Size
19-0528	110
19-0529	112
19-0530	120
19-0531	Connecting Link



# Rear Chain

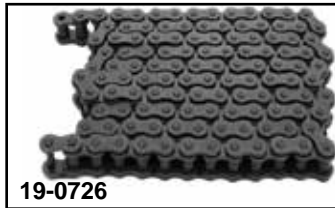

V-Twin Mfg. Chain is 120 links by 530 with master link.

VT No.	Finish	Type
19-0723	Chrome	STD
19-0725	Nickel	STD
19-0726	Parkerized	STD
19-0832	Chrome	H.D.
19-0457	Natural	H.D.
19-0458	Natural	O-Ring
19-0823	Silver	O-Ring
19-0824	Nickel	O-Ring
19-0829	Gold	O-Ring



**530 Standard Diamond** is the mainstay of the motorcycle chain. It has been continuously upgraded by raw material selection, improved heat treating methods and innovative manufacturing and production techniques, which have been patented by Diamond, to keep it in step with the demands of today's motorcycles.

manufacturing and production techniques, which have been patented by Diamond, to keep it in step with the demands of today's motorcycles.

VT No.	Links	VT No.	Links
19-0320	100	19-0327	108
19-0321	102	19-0324	110
19-0322	104	19-0325	112
19-0323	106	19-0326	120



**530 XDL Self Lube** eliminates the possibility of hit and miss lubrication, as it has a constant and consistent lubrication in the pin bushing (wear) area.

Combines the high strength and capacity of Diamond's proven performance with the advantages of fewer adjustment and less maintenance. Added strength is made possible by thicker and redesigned contour inside link plates.

VT No.	Links	VT No.	Links
19-0330	100	19-0334	108
19-0331	102	19-0335	110
19-0332	104	19-0336	112
19-0333	106	19-0337	120



19-0354

**530 XLO Diamond O-Ring Chain** includes a .214 pin which has been produced using a special alloy steel and case hardened for optimum strength, heavy series inside and outside link plates, special constructed extended solid bushings, solid rollers, quad stakes pin heading. 9300 lbs. average tensile strength.

VT No.	Links	VT No.	Links
19-0354	102	19-0357	110
19-0355	104	19-0358	112
19-0348	106	19-0398	120
19-0349	108		



19-0343

**530 Diamond Nickel Plated Chain** offers rust-proof protection along with a nickel finish. Each part of the nickel plated chain is individually plated before assembly to insure maximum coverage.

VT No.	Size	Links	VT No.	Size	Links
19-0340	50ENP	100	19-0344	50ENP	108
19-0341	50ENP	102	19-0347	50ENP	120
19-0342	50ENP	104			
19-0343	50ENP	106			

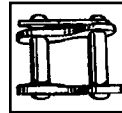

**Master Links.** Replacement link for #50 530 chain. Note: sold in 10 packs unless noted otherwise.

VT No.	Fits Chain Type
19-0350	Standard
19-0351	Nickel
19-0375	XDL Self Lube
19-0353	XLO O-Ring, each
19-0376	N.O.S. Repair Link with 2 Masterlinks OEM, 40052-15



**Diamond Spare Parts Kit** includes two master links, one link and one offset link for all 530 heavy-duty chain.  
VT No. 19-0352





# Big Twin Hi-Way Bar



**FXD Hiway Bar Kit with pegs fits 1991-up.**  
VT No. 27-0571



**Mini Footpeg Clevis Set** accepts all male end pegs. Smooth design with flush allen screws.  
VT No. 27-0671



**Installed**  
27-0625



**Chrome Footpeg 4" Extension** places peg position on FXST 3 1/4" wider and 2" forward. Shown installed on 22-1001 forward controls.  
VT No. 27-1589



**Chrome Mustache Bars** include a Cats Paw Peg Set. Bars are not to be used with a front engine bar.  
VT No. Fits

- 27-0625 1986-99 FLST, 1986-up FXST
- 27-0626 1958-84 FX-FL
- 27-1277 2000-up FLST, FXST
- 27-0649 Bracket



**Clamp On Peg Mount Kit** fits 1 1/4" engine bars. Order pegs separately.  
VT No. Item

- 27-1452 Kit
- 27-0666 Clamp Set
- 27-0673 Clamp Set
- 27-0661 Clamp with mounts
- 27-1005 Clevis



**Hi-way Bar Kits** include 2 chrome plates, chrome extension bars and pegs. Fits 1971-84 models. Available with either O-ring, stock rubber peg with chrome end caps or cats paw style featuring soft rubber inserts.

VT No.	Model	Peg Type
27-1641	FXE	O-Ring
27-1537	FXE	Rubber
27-1642	FXE	Cats Paw
27-1792	FXE	Without
27-0604	Support Bars, Pair	



**Chrome Offset Footpeg Mounts** are 2" offset with 3" extension. Set accepts 1/2" x 13 bolts. Use with 3 piece clamp for 360° rotation. VT No. 27-0617



**3 Piece Engine Bar Clamp Set** with 1 1/4" engine guards.  
VT No. 27-0072



# Footpeg Mount

Chrome	Black	Inner Diameter
27-0701		1"
27-0654	27-1788	1 1/4"
27-0702		1 1/2"



**Footpeg Mount Kit** allows male-type pegs to be mounted to 1 1/4" diameter engine bar.  
**VT No. 27-0651**



**Footpeg Arm Mount Studs** feature spline with 1/2" threaded end, longer type is keyed (for FXR models), overall length shown.  
**VT No. Length**  
 27-0046 2 7/8"  
 27-1648 2 3/8"



**Chrome Billet Footpeg Extension Clamps** attach to 1 1/4" engine bar and accept male pegs.  
**VT No. 31-1254**



**Chrome Footpeg Mount Kits** include clamp set and 3.5" extension bars to accept male pegs.  
**VT No. Size**  
 27-0032 1"  
 27-0033 1 1/8"  
 27-0034 1 1/4"



**Chrome Billet Engine Bar Footpeg Mount** fits on 1 1/4" engine bars to accept male pegs.  
**VT No. Item**  
 27-0654 Mounts  
 27-0660 Kit with pegs



**Chrome Footpeg Mounting Shoulder Bolt & Nut Kit** features shoulder bolts and locknuts to mount driver and passenger pegs.  
**VT No. Type Driver**  
 8850-4 Female FXE  
 8851-4 Male FXST  
 37-0020 Male FXST

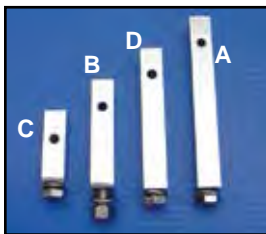

**Chrome Footpeg Bars** are chrome 5/8" square steel, 3/8" thread, pair.  
**VT No. Size #**  
 27-1559 5" A  
 27-1557 2" C  
 27-1558 4" D  
 27-1590 3" B



**Mounting Stud Sets** for footpegs are available in a 3/8" or 1/2" thread. Order shoulder bolts separately.

VT No.	#	Finish	Item
9965-4	A	Cadmium	Bolts
37-0012	A	Chrome	Bolts
27-0050	B	Zinc	3/8" 1965-up FL-FX Stud
27-1604		Chrome	3/8" 1965-up FL-FX Stud
27-0049	B	Zinc	1/2" 1974-up FL-FX Stud
27-1605		Chrome	1/2" 1974-up FL-FX Stud



**Chrome Footpeg Mounting Yokes** are available in 3/8" and 1/2" mounting sizes. Sold in pairs.

VT No.	Thread	Length
27-0051	1/2"	1"
27-1534	3/8"	1"
27-1719*	1/2" x 13	1"
27-3563	3/8"	2 3/4"

\*Note: With studs.



5/16" frame hole inner diameter. \*Note: Unthreaded use with allen threw bolt, threads into mount on bike.

VT No.	Length
27-0062*	1 7/8"
27-3563*	2 3/4"

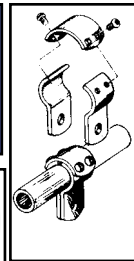
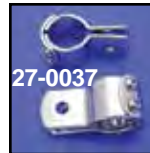

**Three Piece Frame Bracket** is chrome plated super heavy-duty clamps. The unique three piece design eliminates spreading the clamp to fit over frames and safety bars for quick easy installation and a long-lasting custom appearance. Mount hole size noted.



1/2" Mount Hole	3/8" Mount Hole	Black	Inner Dia
27-0052	27-0039	27-0001	1"
27-0053	27-0038	27-0002	1 1/8"
27-0054	27-0037	27-0003	1 1/4"
27-0066	—	27-0004	1 1/2"

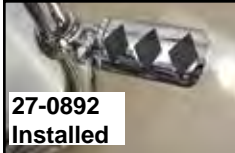

**Bar Clamps** fit 1 1/4" engine bars to mount male peg sets. Peg kit includes soft pegs.  
**VT No. Item**  
 27-0892 Clamp Set  
 27-0895 Peg Kit

Order diamond adjustable pegs separately 27-3549.



**Engine Bar 3 Piece Clamp Set** with male footpeg mounts. Footpeg mount mounts to clamp with 1/2" bolts included.

**VT No. 27-0072**



**Chrome Steel Mount Clamp** for 1" or 1 1/4" diameter tubes with 3/8" mount hole. Sold in pairs.

VT No.	Size (Inner Diameter)
27-0057	1"
27-0059	1 1/4"



**Footpeg Mount Blocks** fit 1996-up FLT models to use with male peg sets.

**VT No. 27-0623**



**Billet Clamps** on footpeg mounts, fit 1 1/4" frame or engine bar, mounts are 3.5" long and accept male pegs.  
**VT No. 27-0983**



**Chrome Footpeg Mount Bars** are 3 1/2" long and accept male mount pegs and mount with 1/2" x 13 bolts.  
**VT No. 27-0030**





# Hi-Way Bar for XL

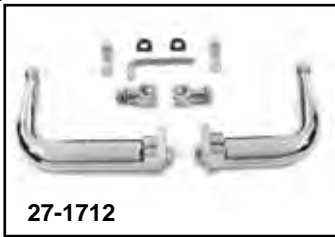

**Adjustable Hi-way FootPeg Kit** for XL models with mid mount brake and shifter controls. Adjusts quickly into 3" height positions and can be used with engine guard. Order soft pegs separately, 27-1582.

VT No.	Fits
27-1712	1984-2003
27-1728	2004-up



**Hi-way Bars for Evolution Sportster.** Chrome pair mounts to front motor mount factory style. Includes O-Ring pegs for 1985-2003 883-1100-1200.

VT No.	Type
27-0611	O-Ring Style
27-1630	Cats Paw Style



**1984-2003 Forward Footpegs for Sportster.** Chrome one piece design, bolts to motor mount bolts for firm mounting, features O-ring pegs for all 883, 1100, and 1200cc. VT No. 27-1572



**Hi-way Bar Kits** include chrome mount plates, peg extension bars and O-Ring peg set.

VT No.	Year
27-0609	1952-81
27-0610	1982-84



**Chrome Foot Rest Support Bars Set.** Right and left support bar set for use on all XL's with welded square insert on motor mount plate which has a filter for 1983-Early 84. **Foot Rest Support Bar** is a set of 2 for Hi-way Bars on FX-FXR's, 1977-up heavy duty and chrome 3/4" long.

VT No.	Item
27-0604	Support Bar Set
27-0635	Bar Set
27-1227	Peg Set
8851-4	Bolt Set
13-9185	Spring Washer
40-0301	Engine Mount with filter

# Rear Footpeg Mount for XL

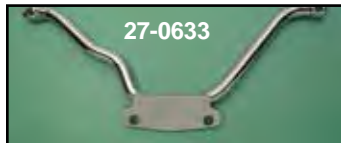

VT No. 27-0634 Shown on motorcycle

**Chrome Rear Footpeg Brackets** bolts to rear motor mount bolts, for use on Rigid or Swing Arm frames.

VT No.	Fits
27-0633	1957-78 Sportster, uses large female Driver pegs 27-1215, 27-1220 and 27-1581
27-0634	1982-90 XL use 27-1227 Small Male Pegs
27-0631	1957-81 except 1979 use 27-1227 Small Male Pegs



**Rear Passenger Footpeg Mounts (D)** Replaces 50610-86 on 1986-2003 models, to mount rear passenger pegs to swing arm. Choose pegs to complete or order kit.

VT No.	#	Item
27-1686	C-A	Kit
27-1685	C-B	Kit
27-1687	C-D	Kit
27-1561	C	Mounts Only



**Chrome Passenger Peg Mount Bracket Sets Only.** Use with male style peg.

VT No.	Item
27-1564	2004-13
27-0485	2014-up



# Stirrup Set



**Chrome Footpeg Set with Heel Rest** features rubber insert and retractable heel rest to fit female peg mounts.

VT No. 27-0765

## Combat



27-0432



27-0433



27-0521



27-0241

**Combat Vintage Pegs** are all made of steel. These hollow style pegs fit male peg applications.

VT No.	Finish
27-0432	Black Oxide
27-0433	Chrome
21-0521	Parkerized Shifter
27-0241	Combat Peg Set Parkerized



27-1813



27-1812



27-1529



27-0792



27-1815

**Heel Stirrups** fit driver footpeg mount or hi-way bars where a small peg is used, adjustable heel pad. Sold as pairs.

VT No.	Type
27-1813	Stirrups with large pegs
27-1812	Stirrups with small pegs
27-1529	Stirrups with small pegs
27-0792	Stirrups without pegs
27-1815	Replacement Soft Pad Inserts





# Comfort Footpeg™



27-0797  
Installed

**Flame Heel Rest and Footpeg Kit** includes right and left heel rest arms and serrated clevis which will allow the heel rests to be fixed at the drivers selection. Kit mounts on FXST, FXDWG or XL models with forward controls which accept male pegs. Kit includes flame rider male peg set to complement the flame heel rest set.

**VT No. 27-0797**



27-0797



27-0146



27-0142

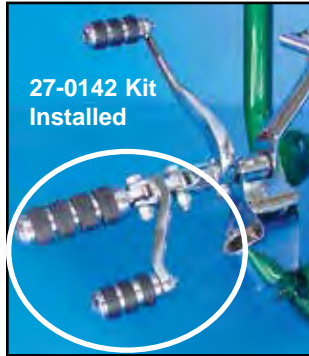

27-0142 Kit  
Installed

**Heel Rest Kit** allows extra set of pegs to be used for rider position on FXST-FXDWG or where male peg is used on forward control. Order appropriate matching foot and shift pegs to complete installation.

VT No.	Item
27-0146	Peg and Bracket Kit, Fits male applications
27-0142	Bracket and Arm Kit
27-1582	Footpegs
21-2025	Shift Peg



27-0558

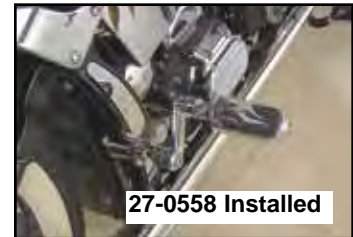

27-0558 Installed



27-0559



23-0466



27-0560

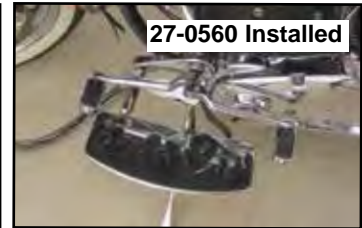

27-0560 Installed

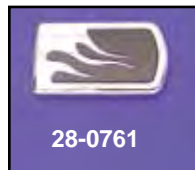

28-0761

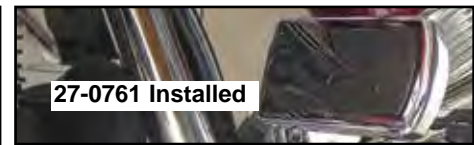

27-0761 Installed

**Flame Footpegs** feature smooth black rubber which accents the chrome flame pattern. The rubber relief allows foot grip at surface.

VT No.	Fits
27-0558	Models w/male mount style footpeg
27-0559	Shifter Peg
27-0560	Heel Rest Kit
23-0466	1984-up FXST, 1996-up FXDWG Brake
28-0761	1980-up FLT, 1986-up FLST Brake Pedal



27-0553



27-0554



27-0555



27-0556

**Diamond Insert Footpeg Sets** feature rubber inlaid insert in chrome body of peg and shaft.

VT No.	Type
27-0553	Male Passenger
27-0554	Female Driver
27-0555	Hiway Bar Peg 5/8"
27-0556	Male Driver
21-0260	Shifter Peg



21-0260

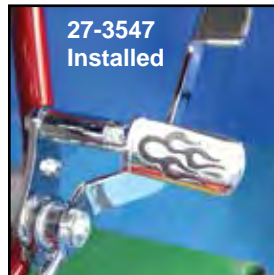

27-3547  
Installed



27-3547

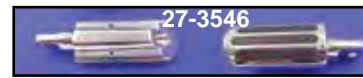

27-3546



27-3549



27-3560

**Chrome Adjustable Footpeg Sets** feature molded rubber inserts. Pegs feature 180 degrees of spline to allow mounting at different angles. Peg set sold complete with splined straight shaft.

Mount	Rail	Diamond	Flame
Male Driver	27-3546	27-3549	27-3547
Female	—	27-3560	27-3550



# Shifter Peg



Shifter Footpegs are the short stud type.

VT No.	Style
27-1633	Railer
21-2025	Cats Paw
21-1665	Cats Paw, extended
21-0407	Chrome Cap
21-0402	O-Ring
21-0640	O-Ring (Rotates)
21-0408	Pirate
21-0689	Bullet Shift Peg
21-0790	Skull
21-0587	Deco
21-0260	Diamond
21-0542	Dagger
21-0540	Batique Grooved
21-0641	Druid
21-0674	Swiss Cheese, Chrome
21-0725	Swiss Cheese, Stainless Steel
21-0789	Flame
21-0541	Contour
21-0683	Hollow Flame
27-0559	Rectangular Flame
21-0620	Slasher
21-0277	Ball Milled
21-0278	Colt 45
21-0279	Contour Groove
21-0280	Convex Knurled
21-0281	Teardrop
21-0289	Flange Knurled
21-0292	Concave
21-0339	Black Contour Grooved
21-0340	Black 5 Groove
21-0357	Chrome 5 Groove
21-0341	Black 4 Groove
21-0569	Chrome 4 Groove
21-0344	Black Tribal
21-0345	Black Form Druid
21-0346	Black Flame
21-0347	Black Spike Agostinni
21-0358	Chrome Spike Agostinni
21-0350	Black Concave
21-0351	Black Contour
21-0352	Black Agostinni
21-0353	Black Deep Groove
21-0354	Black AK-47
21-0355	Black Swiss Cheese
21-0356	Black Railroad
21-0287	Brass Contour
21-0288	Brass Swiss Cheese
21-0285	Brass Concave
21-0654	Brass Shot
21-0926	Black Cobra Shifter Peg



21-2025 shown installed with 21-0386



**Stock Rubber Shifter Footpegs** are in white or black, long or short stud. The 7/8" long stud is used when the lever is unthreaded and stud accepts a nut. Short 5/8" thread screw into lever. Includes a 10 pack of 5 long and 5 short.

VT No.	Color	Type
21-0901	Black	Short
21-0317	Black	10 pack, includes 5 long, 5 short
21-0902	White	Short
21-0903	Black	Long
21-0908	Black	Long
21-0904	White	Long



Shifter Pegs include 1/4" x 28 threaded end stud.

VT No.	Type
21-0749	Shooter
21-0910	Speeder
21-0952	Comfort
21-0620	Slasher
21-0872	Skull







# Docking Hardware



## Docking Point Bushing Set

VT No.	OEM	Item
31-1300	53685-96	Narrow Bushings
31-1301	53697-06	Tapered Narrow Bushings
31-1302	53942-04	Tapered Narrow Bushings
31-1303	53943-04	Wide Tapered Bushings
31-1312	53967-06	Narrow Bushings

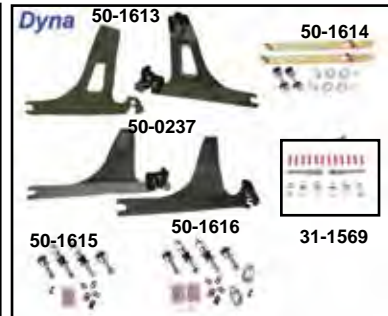

## Sissy Bar Detachable Side Plates

50-1609	2000-2007 FLST
50-1617	1984-99 FLST except FLSTS
50-1616	F/SIDE PLATES F*ST00-UP
50-1611	F/SIDE PLATES F*ST03-UP

## Docking Hardware Kits

50-1620	1984-99 FXST
50-1618	1986-99 FLST
50-1619	1984-99 FXSTS
50-1612	2003-up FLSTC
50-1610	F*ST00-UP
50-1611	F*ST03-UP
31-1739	53964-06A 2006-08 FXDWG, 2008-up FXD
50-1615	93-01 FXDWG 53858-01
31-1568	2000-02 FLSTC
50-1615	53858-01 93-01 FXDWG
50-1616	53882-02A FXDWG

VT No.	OEM	Fits
50-1622	53529-04	2004-up XL
50-1624		Kit F/SIDE PLATES XL 95-03
31-1740		Includes Detachable Racks and side plates
50-1613		Includes detachable side plate 2006-up Dyna
50-1614	53961-06	2006-up FXD#
50-0237		1993-05 FXDWG
50-1608		2000 FXST
31-1568		2000-02FLSTC



# Footpeg Set



21-2100



27-2103



27-2104



27-2105



27-2106



27-0603



27-1543

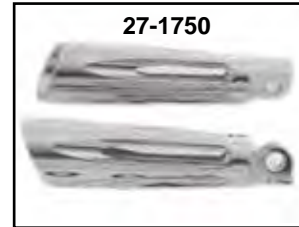

27-1750



27-1009



27-0747

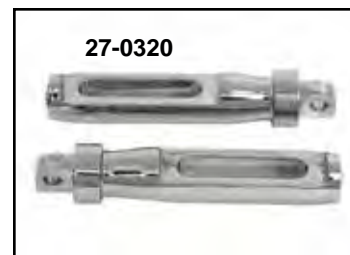

27-0320

**Silver Knurled Four Groove Footpeg Set** featured a silver anodized finish.

- VT No. Style**
- 21-2100 Shifter Peg
- 27-2103 Large Male Mount Footpeg Set
- 27-2104 Large Female Footpeg Set
- 27-2105 Small Male Mount Footpeg Set
- 27-2106 Small Female Mount Footpeg Set



27-0857



27-0006



27-0403

**Offset Driver Peg Set** are male style pegs that "drop" the footpeg height.

- VT No. Type**
- 27-0857 Stock
- 27-0006 Soft Peg
- 27-0403 Railer



27-1584

**Chrome End Foam Soft Touch Footpegs** are die-cast, fully chromed 1-piece peg sets. Soft covers are smooth-finished in 3/8" closed-cell black foam. May also be used as passenger pegs or hi-way bars on FX-XL-FXR models. Fits 1981-up Driver FXR, large.

**VT No. 27-1584**



27-0028

**Replica Chrome Rear Footpeg Mount** will add both style and comfort to your ride. Fits custom application utilizes a 1/2" mounting hole.

**VT No. 27-0028**



**Chrome Passenger Footpeg Support** fits 2007-up FXST. Order passenger footpeg mount kit separately.

**VT No. 27-3564**

**Billet Peg Set** features male ends.

- VT No. Style**
- 27-0603 Batique, male
- 27-1543 Comfort, male
- 27-1750 Slasher, male
- 27-1009 Raw Cut Black Cobra, male
- 27-0747 Chrome Spike, male
- 27-0272 Steel Dimpled
- 27-0320 Batique, male
- 27-0753 Highway Bar Footpeg Mount Set
- 27-0776 Form Factor Female Footpeg Set
- 27-0829 Black Druid Style Style, Female



27-1554



27-0327



27-0325

**Male Style Footpegs** in chrome

- VT No. Style**
- 27-1554 Slotted
- 27-0327 Passenger Rubber Insert, Small 4 1/8"
- 27-0325 Peg Set
- 27-0326 Peg Set

**Rear Passenger Footpeg Support** with a 3/8"-16 stud features a black finish. Fits 1986-2003 XL.

**VT No. 27-0830**



**Black Footpeg Extension Set** fits 2014-up XL.

**VT No. 27-0975**





# Footpeg Set

Note: All footpegs on this page feature male end mount. Order by VT No.

27-0043



27-0321

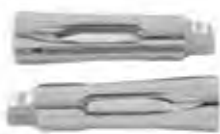

27-0322



27-0574



27-0582



27-0621



27-0658



27-0663



27-0699



27-0715



27-0716



27-0717



27-0718



27-0719



27-0720



27-0721



27-0722



27-0723



27-0724



27-0725



27-0726



27-0727



27-0728



27-0729



27-0730



27-0731



27-0732



27-0733



27-0734



27-0735



27-0736



27-0738



27-0739



27-0775



27-0777



27-0799



27-0821



27-0865



27-0874



27-0970



Note: All footpegs on this page feature male end mount. Order by VT No.

# Footpeg Set



27-0971



27-0972



27-0973



27-0997



27-1056



27-1057



27-1058



27-1059



27-1060



27-1061



27-1062



27-1063



27-1064



27-1065



27-1066



27-1067



27-1068



27-1069



27-1070



27-1071



27-1072



27-1073



27-1074



27-1075



27-1076



27-1079



27-1080



27-1081



27-1082



27-1208



27-1543



27-1765



27-0083

- VT No. Style
- 27-0043 Chrome Contour
- 27-0083 Chrome Contour
- 27-0321 Chrome Deep Cut
- 27-0322 Chrome Bullet Style 357 Magnum
- 27-0574 Chrome Druid
- 27-0582 Chrome Flame
- 27-0621 Chrome Knuckle
- 27-0658 Chrome Maltese Ends
- 27-0663 Chrome Bullet Style w/rubber buttons
- 27-0699 Chrome Speed-Line (rubber insert)
- 27-0716 Chrome Colt 45
- 27-0715 Chrome Form Factor
- 27-0717 Chrome Spike Gladiator Vibra
- 27-0718 Chrome Contour Grooved Deep Cut
- 27-0719 Chrome Micro Grooved
- 27-0720 Chrome Ball Milled
- 27-0721 Chrome Micro Holes
- 27-0722 Chrome Dagger Slot
- 27-0723 Chrome Spoon
- 27-0724 Chrome Hollow Knurled
- 27-0725 Chrome Contour end
- 27-0726 Chrome Banded Skull End
- 27-0727 Chrome Flange Knurled
- 27-0728 Chrome Spiral Point O-Ring
- 27-0729 Chrome Light Grooves

- 27-0730 Chrome Form Factor Teardrop
- 27-0731 Chrome Long Torpedo Style
- 27-0732 Chrome Silence
- 27-0733 Chrome Dagger Drilled
- 27-0734 Chrome Groove Contour Cushion
- 27-0735 Chrome Agostinni
- 27-0736 Chrome Convex Knurled
- 27-0738 Brass Concave
- 27-0739 Chrome Taper Cushion Peg
- 27-0775 Brass Pirate
- 27-0769 Hollow Flame
- 27-0777 Brass Contour
- 27-0799 Heel Rest
- 27-0821 Chrome Skull
- 27-0865 Edge Cut
- 27-0874 Chrome Smooth
- 27-0970 Chrome Hourglass
- 27-0971 Chrome Tribal
- 27-0972 Chrome Concave
- 27-0973 AK 47
- 27-0997 Slugger w/rubber inlay
- 27-1056 Black Contour Grooved Deep Cut
- 27-1057 Knurled Five Grooved
- 27-1058 Knurled Four Grooved
- 27-1059 Double Wide Cats Paw
- 27-1060 Contour Agostinni w/ring

- 27-1061 Tribal Style w/ chrome highlights
- 27-1062 Black Form Factor Druid Style
- 27-1063 Black Flame Style
- 27-1064 Black Agostinni Spike Style
- 27-1065 Black Form Factor Teardrop
- 27-1066 Black Tribal Style
- 27-1067 Deep Cut Style
- 27-1068 Black Deep Cut Slasher
- 27-1069 Black Concave Style
- 27-1070 Black Swiss Cheese
- 27-1071 Black Contour
- 27-1072 Black Contour Agostinni
- 27-1073 Black Agostinni Spike Gladiator Solid
- 27-1074 Three Band Style
- 27-1075 Black Deep Groove
- 27-1076 Black Hollow Knurled
- 27-1079 Black Bullet Style 357 Magnum
- 27-1080 Black Spike Xtreme
- 27-1081 Micro Holes (Black w/woven)
- 27-1082 Black Railroad Style
- 27-1208 Black Knuckle
- 27-1543 Chrome Three Band
- 27-1763 Stainless Steel Swiss Cheese
- 27-1764 Brass with knurling
- 27-1765 Brass Swiss Cheese
- 27-2100 Double Wide Cats Paw

27-2100



27-1763



27-1764



27-0769







# Footpegs

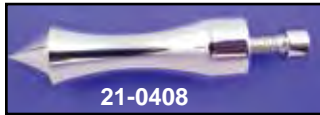
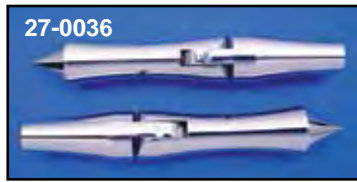

**Pirate Spike Footpeg Set** features full billet construction for male type application.

VT No.	Item	Type	Length
27-0035	Peg Set	Male	6"
27-0036	Peg Set	Folding	8.5"
27-0069	Peg Set	Folding	6.5"
21-0408	Shift		3.25"



**Clamp On Footpeg Sets.** Chrome plated peg with zinc clamps and hardware, features the folding type mount block,

VT No.	Style	VT No.	Style
27-1214	Holes	27-1212	Spoon
27-1211	Diamond	27-1213	Ribbed

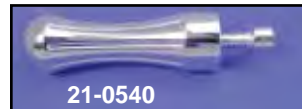
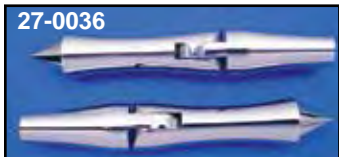

**Folding Billet Footpeg Set** feature 3" clevis for use on Wyatt Gatling forward controls. Order shift peg separately.

VT No.	Style	Shift Peg
27-0036	Pirate	21-0408
27-0602	Batique	21-0540



**Chrome Steel Stock Style Footpegs** for front engine bars.

VT No.	OEM	Size	Clamps
27-1504	49100-58	1"	27-1505
27-1503	49102-73	1 1/4"	27-1506
27-0847	Male Peg Set		



**Chrome Billet Slugger Footpeg Sets** feature rubber inlay on male style pegs.

VT No.	Style
27-0935	Bar
27-0936	Diamond
27-0937	Rib
27-0997	Oval
27-0938	Shifter, Bar
27-0939	Shifter, Diamond

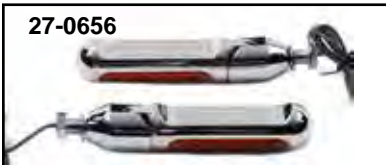

**Chrome Billet Chopper Footpegs** feature LED lamps built in.

VT No.	Color
27-0656	Amber
27-0657	Red



**Folding Chrome Hex Chopper Footpegs** include threaded mount block.

VT No.
27-0176



**Rubber Insert Footpegs.**

VT No.	Type
27-0979	Clamp
27-0981	Male
27-0982	Male with clevis mount rotated 30°
27-1524	Clevis Only



**Authentic Chopper Footpegs** feature original sand cast finish with mounting blocks. Thread is 7/16" x 20.

VT No.	Type	Brand
27-1501	7/16" x 20	Anderson
27-1507	Peg with Clamp	V-Twin



**Footpeg Yokes** for steel dimpled pegs.

VT No.	Type
27-0746	Male
27-1524	5/8" Bar
27-1454	3/8" x 24



# Billet Footpeg Set



**Red Baron™ Footpeg Set** features billet construction with steel shaft and male peg ends.

VT No. 27-0954

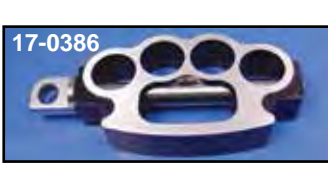

**Billet Machine Footpegs, Shifter and Brake Pedals** can be used as replacements on billet controls or adapted to other kits. Footpegs include pivot yokes with  $\frac{3}{8}$ " bolts, shift brake pedals have  $\frac{5}{16}$ " threads. Sold in pairs.

VT No.	Type
27-1657	Footpegs
27-1658	Shift Brake Pedal
27-1659	Front Pegs with Male End
27-0435	Footpeg Set with hardware
27-0942	Footpeg Set without hardware

## Billet Footpeg Sets.

VT No.	Item	Style	Finish
27-0620	Peg Set	Skull	Chrome
27-1207	Peg Set	Knuckle	Polished
27-1208	Peg Set	Knuckle	Black
27-0621	Peg Set	Knuckle	Chrome
27-0694	Peg Set	Skull	Chrome
27-0846	Peg Set	Skull	Black
17-0386	Kicker	Knuckle	Alloy

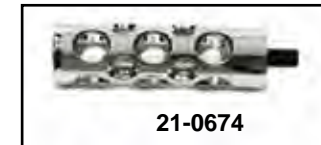
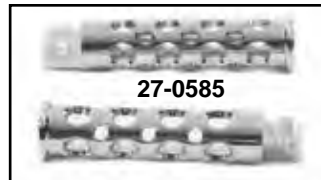

## Railroad Spike Billet Footpeg Set with male ends.

VT No.	Item
27-0785	Railroad Peg, 4.02"
27-0310	Railroad, Stud Mount
27-0014	Large Railroad, 5.625", Classic Male
21-0653	Shifter Peg

## Chrome Hole Shot Billet Footpeg Set features male style ends.

Hole Shot	Shooter	Item
Chrome	27-0745	Peg Set
21-0674	21-0749	Shifter Peg
Black		
21-0355		Shifter
27-1051		Footpeg

MULTI FIT/CHOPPER





# O-Ring Footpeg



- 27-1223 3/8" Stud Mount Pegs
- 27-1580 Pegs only fit 5/8" square blocks
- 27-1585 FXR 1991-94 and large driver peg, male end
- 21-0402 O-Ring Shift Peg each, 1/2" stud
- 14-0901 O-Rings for Large Pegs, 100 pieces
- 14-0902 O-Rings for Flat Kick Pedal, 100 pieces

**Chrome O-Rings Footpeg Sets** feature die-cast pegs with o-rings installed.

- | VT No.  | Type/Model  |
|---------|---|
| 28-2011 | Pair Handgrip Set, 1974-up  |
| 27-1221 | Rear Passenger Pegs FX<br>FXST front driver, Hi-way-Bar male end, small dia |
| 27-1626 | Extended As Above, 1 1/2" long  |
| 27-1220 | Large FX 1952-90 Driver peg, female   |
| 17-0299 | Flat Kicker Pedal   |
| 27-1222 | Clamp on Set 1"   |



**Diamond O-Ring Footpegs** include clamp set.

- | VT No.  | Style  |
|---------|--------|
| 27-0896 | V-Twin |
| 27-0897 | Plain  |

# Magna Footpeg Set



**Magna Ring Footpegs** feature heavy duty flat rubber ring with chrome center shaft and tapered end cap, pairs.

- | VT No.  | Style                      |
|---------|----------------------------|
| 27-1661 | Driver, male               |
| 27-1660 | Driver, female             |
| 27-1662 | 5/8" square mount, female  |
| 27-1716 | Passenger Male 1" Extended |



# 1" Extended Footpeg



**Extended Footpegs** are 1" longer than stock male yoke end pegs. Fit FX-FXST passenger and FXST-FXWG Driver peg. Available in pairs.

- | VT No.  | Style                                    |
|---------|--|
| 27-1601 | Rubber with Chrome Caps                  |
| 27-1509 | Rubber without Chrome Caps               |
| 27-1626 | O-Ring style                             |
| 27-1627 | Cats Paw Style with Yokes                |
| 27-1643 | Extended Yoke only for above             |
| 21-1665 | Extended Cats Paw Shifter                |
| 27-1717 | Cats Paw Style Peg, Male End 1" Extended |





**Brake Pedal Pad** features chrome die cast backing with black rubber insert pads for FLT-FLST.

VT No.	Model	
28-2226	1965-up FLH	
28-0761	1980-up FLT Flame	
28-2252	1980-up FLT	
28-2233	1983-up FLT, Pad Only	
28-2257	1986-up FLT-FLST	
28-0591	1980-up FLT, 1986-up FLST	
28-0886	1980-up FLT, Kit	
Chrome	Black	
28-0823	28-0824	Small Crest
28-0825	28-0826	Large Crest



**Slide On Black Brake Pedal Pad** replaces 36954-62 on 1936-84 FL and Rigid brake pedals, slides on.

VT No.	Type
28-0304	Stock
28-0457	"H"

# Brake Pedal Pad



**Skull Pedal Pad** is constructed of neoprene. Sold each.

VT No.	Type
23-0823	FXST
23-0824	FLST-FLH

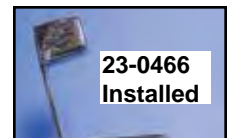

**Brake Pedal Rubber.**

VT No.	Type	Model
28-0548	With stud	FXST
23-0466	Bolt on	FXST-FXDWG
28-0054		FXST

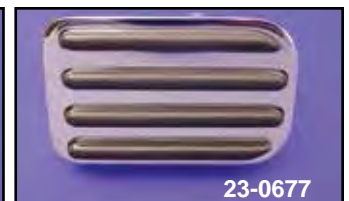

**Brake Pedal Pads** feature die cast chrome with rubber inserts to match pegs. Fits 1984-up FXST.

VT No.	Style
23-0676	Diamond
23-0677	Rail





# Driver Footpeg Support



27-1624



27-1735

**Driver Peg Support Bars** are the splined type, less pegs fit 1952-74. Replaces 50948-71 left, 50949-67 right. Use with large female type driver pegs.

VT No.	Finish
27-1624	Zinc
27-1735	Chrome



**Chrome Forward Control Footrest Support** fits XLC models with forward controls.

VT No. 27-0010

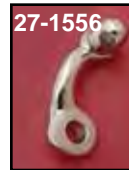

27-1556

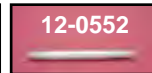

12-0552



12-2117

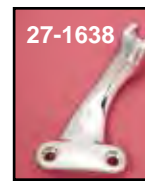

27-1638

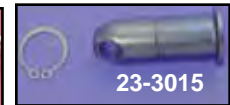

23-3015

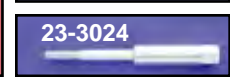

23-3024



23-1728

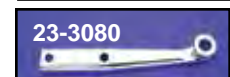

23-3080

## Foot Rest Supports and Studs.

VT No.	OEM	Years	Item
<b>Left Side</b>			
27-1556	50948-75	1977-85	Support
12-0552	24752-75	1977-85	Stud
27-1638	50951-90	1991-03	Support
27-0817	42972-04	2004-up	Support
<b>Right Side</b>			
23-3024	34886-86A	1986-90	Stud
27-1577	50949-75	1977-79	Support
12-2117	247751-75	1977-79	Stud
23-3079	42441-90A	1991-03	Peg Clevis
23-3015*	42441-80	1980-90	Pivot-Stud
23-0780	42971-04	2004-up	Support
23-1728	34909-83	1983-90	MC Support Bracket
23-3080	34909-90	1991-03	MC Support Bracket



27-1577

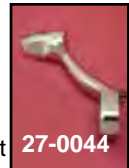

27-0044

\*Note: Acts as foot support brake pivot.

# Replica Footpeg Mount

**Chrome FXR Driver Footpeg Mount Brackets** fit 1982-94 all FXR. Use with male style pegs.

VT No.	#	OEM	Type
27-0640	A	50531-81	Right Mount
27-0639	B	50636-81A	Right Extension
27-0638	C	50639-81	Left Extension
27-0641	A,B,C		Three Piece Set



27-0804

**1990-up FXD Driver Footpeg Mount Set.**

VT No. 27-0804

# Replica Footpeg

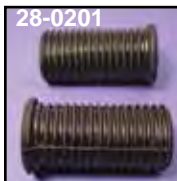

28-0201

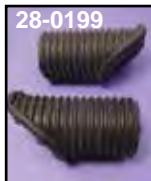

28-0199



28-0204



28-0202



27-1616



27-1615

**Stock Footpeg Rubbers** are available in pairs.

VT No.	OEM	Color	Models
28-0201	50940-52	Black	FX-XL Driver large diameter
28-1954	10 pack	Black	FX-XL Driver large diameter
28-0202	—	White	FX-XL Driver large diameter
28-0199	50646-82	Black	FXR Driver
28-0204	33187-63A	Black	FX Passenger
28-0205	—	White	FL Kick 1963-up
28-1953	10 pack	Black	

\*Note: Fit black rubber pegs on 1952-89 FX models, on rubber type 28-0201.

**Shaker Driver Footpegs** are vibration absorbing pegs with chrome end caps. Both male driver pegs are larger diameter. With extra cushion built into the rubber shank.

VT No.	Fits
27-1616	FXR, XL
27-1615	FXST



**FX Driver Footpeg** replaces 50939-52. Fits 1952-84 K and XL except FXR and 1971-84 FX models.

VT No.	Type
27-1225	Chrome
27-1226	Zinc



27-1215



21-0407

**Chrome Cap Footpegs** are rubber covered with chrome end caps.

VT No.	Item
27-1215	1952-84 Driver, Large Female
21-0407	Shifter Peg, 1/2" Stud



27-1227

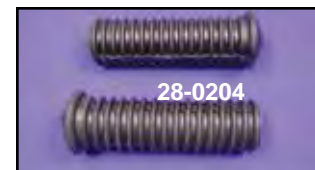

28-0204

**Replica Footpeg Sets** fit passenger 1969-up, 1980-up driver on WG.

VT No.	Style
27-1227	Chrome End Cap
28-0204	Rubber Set Only
37-0020	Bolt Set



# Footpeg



27-1664



27-1632



17-9150



27-1631



27-1669



27-1633

**Krome-Railers** are designed with chrome body with rubber "rails" inserted for good grip.

VT No.	Item	Type	Fits
27-1664	Male Pegs	Large pegs	FXR driver and 1991-up XL
27-1632	Female Pegs	Large Driver	1952-90 XL
27-1631	Male Pegs	Small Pegs	FXST Driver
28-2229	Handlebar Grips		
17-9150	Rail Kicker Pedal		
27-1633	Shift Peg		
27-1669	Peg for 5/8" Square bar		



27-0674



27-0675



27-0676



27-0677



27-0678



27-0682

**Footpeg-Shifter Ensemble** includes a male peg set and matching shifter peg to fit forward controls.

VT No.	Type	VT No.	Type
27-0674	Pirate	27-0677	Hole Shot
27-0675	Druid	27-0678	Bullet
27-0676	Band	27-0682	Batique

# Mega Footpeg



27-1234



27-1232



27-1233



27-1232

**Mega Footpegs** feature molded rubber inserts in a chrome die cast metal peg. Units feature adjustable angle position which is accomplished through a center allen screw.

VT No.	Type
27-1234	Female Driver
27-1232	Male Driver
27-1233	Universal 5/8" Square



27-0893

**Gothic Billet Footpeg Sets** with rubber inserts to fit male applications.  
VT No. 27-0893



**Billet Rocket Footpegs** with male ends. Heavy duty O-rings included.  
VT No. 27-0786





# Cat Paw Peg

**Cat Paw Footpegs.** Unique soft rubber pad is an inserted cleat isolastically mounted on chrome allen socket bolt and yoke stem. Vibration is reduced. Sold in pairs, matching shifter sold each.

- | VT No.  | Type  |
|---------|---|
| 27-1581 | Large driver female end 1952-90 FX  |
| 27-0042 | Mount Yoke for above, female  |
| 27-1586 | Large Driver, male, 1982-94 FXR   |
| 27-0041 | Male Yokes for Above Footpegs   |
| 27-1582 | Passenger, Rear, 1973-up FX-FXST-FXWG, Front 1981-up male end, stock type Hi-way Footpegs           |
| 27-1768 | As Above ET Brand   |
| 27-0041 | Stock size Mount Yokes for Above, male  |
| 27-1457 | Passenger Black, small  |
| 27-1646 | Kicker Pedal  |
| 27-1583 | 5/8" Female type for custom Hi-way Footpegs   |
| 27-1623 | As above, Clamp-on set  |
| 27-1699 | 3/8" x 24 Stud Mount Footpeg Set  |
| 27-1700 | 1/2" x 20 Stud Mount Footpeg Set  |
| 21-2025 | Shifter Footpeg Complete  |
| 21-1665 | Shifter Footpeg 1" longer   |
| 27-0961 | Male Yoke, +1" small  |
| 27-0960 | Male Yoke, +1" large  |
| 28-2008 | 27-1581 1586, Rubber only 8 piece   |
| 28-2009 | 27-1582 1583, Rubber only 8 piece   |
| 28-2018 | 21-2025, Rubber only 3 piece  |
| 27-1280 | Cat's Paw Footpeg includes a large cats paw footpeg set with bracket and clamps for frame mounting. |
| 27-1800 | Small ISO Footpeg, male   |
| 27-0873 | Mount Kit for 27-1582 & 27-1586   |



**Large Cat Paw Footpegs** available with 3/8 flush mounts for forward controls and kicker pedal.

- | VT No.  | Type               |
|---------|--------------------|
| 27-1646 | Kick Starter Pedal |
| 27-1647 | Flush Mount        |

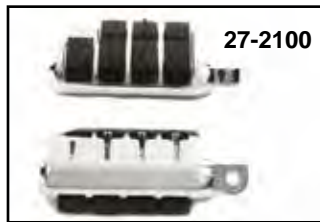

**Lion's Paw Footpeg.** Wider style for male peg application.

- | VT No.  | Finish |
|---------|--------|
| 27-2100 | Chrome |
| 27-1059 | Black  |



**Offset Driver Peg Set** are male style pegs that "drop" the footpeg height.  
VT No. 27-0006

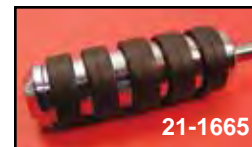

**Chrome Footpeg Kit** includes offset mount bracket and 1 1/8" clamp set. Fits Custom application for 1 1/8" bar  
VT No. 27-0986



# Cat Paw Peg Kit



### Male Mount Foot Peg

- 27-0096 Black with clear cuts
- 27-0097 Stealth Tone Black
- 27-0098 Shot Peened, Chrome

### Brake and Shifter Peg

- 21-0261 Chrome
- 21-0262 Black with clear cuts
- 21-0263 Stealth Tone Black
- 21-0264 Shot Peened, Chrome



**Authentic Chopper Footpegs** feature original sand cast finish with mounting blocks. Thread is  $\frac{7}{16}$  x 20. Peg with clamp.  
**VT No. 27-1507**



**Soft Footpeg Set** includes male peg set with a matching shifter peg.  
**VT No. 27-0583**



**Male End Mount Footpegs** features cat paw style pegs with a unique soft rubber pad to reduce vibrations and includes chrome brackets and ISO chrome pegs. Additional hardware may be required. Passenger bolts included. Fits 1994-2005 FXD, 1994-2005 FXDWG  
**VT No. 27-0439**

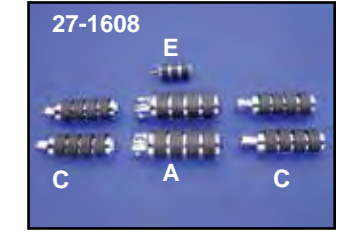
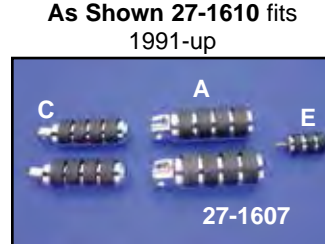
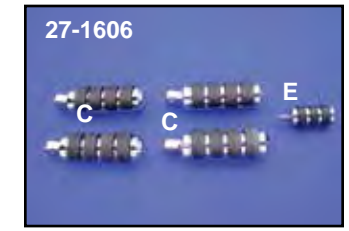
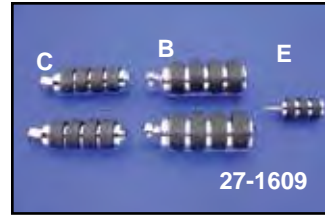

As Shown 27-1610 fits 1991-up

**Cat Paw Footpeg Kits** include chrome and soft rubber insert pegs display packaged as complete kits. Included are a driver, passenger, and shifter peg, also available with our optional hi-way bar peg sets. Type of pegs are denoted by the following VT No.'s: (A) 27-1581, (B) 27-1586, (C) 27-1582, (D) 27-1583 and (E) 21-2025. See page 1017 for full description of peg and model year fit.

VT No.	Year	Model	Includes
27-1606	1980-86	FXWG	2 C, E
	1985-up	FXST	
27-1607	1970-90	XLH-FXE	A, E, C
27-1608*	1970-90	XLH-FXE	A, E, (2) C
27-1611*	1970-90	XLH	A, E, C, D
27-1609	1991-up	XLH-FXR	B, E, C
27-1610*	1991-up	XLH-FXR	B, E, (2) C

\*Note: Includes extra peg set for hi-way bar (27-1582) kit. 27-1611 includes (27-1583)  $\frac{5}{8}$ " type for hi-way bar.



### Rubber Insert Footpegs.

- VT No. Type
- 27-0979 Clamp
- 27-0981 Male
- 27-0982 Male with clevis mount rotated 30°
- 27-1524 Clevis Only





# Rear Footpeg Mount Kit

27-1277



**Highway Bar Kit** includes black frame bracket assembly with chrome forged foot peg arms. Accepts male style foot pegs. Fits 2000-up FLST, FXST. VT No. 27-1277



**Hiway Bar Kits** clamp on 1 1/4" diameter tubes. VT No. 27-1013



27-0860 Installed



**1986-06 Softail Rear Footpeg Mounts** bolts to rear frame and repositions pegs in more comfortable position. VT No. 27-0860



27-1698 Installed



**Footpeg Pin Kit** is 6 pieces, includes 2 pins, 2 snap rings and 2 springs washers. VT No. 27-0967



27-1696



27-1698

**Adjustable Chrome Footpeg Mount Kits** feature a detent locking system that allows pegs to be rotated to different positions. The new yoke provided fits into the stock female footpeg clevis on models that accept a male end peg. Order flame pegs VT No. 27-0558 separately.

VT No.	Year	Model	Type
27-1696	1983-07	FXST	Front
	1994-07	FXDWG	
27-1698	1984-99	FXST	Rear
	1986-99	FLST	



**Driver Footpeg Relocation Mounts** allow footpegs to move towards or away from driver, 2" from stock location. Chrome plated and includes mounting pins. Use on all 1984-up FXST. Fits 1993-up FXDWG. VT No. 27-0455



27-1450

**Passenger Footboard Support Kit** for 2008-up FLST, FXST models for use with OEM type passenger footboards.

VT No. Finish  
 27-1450 Black Gloss  
 27-1459 Chrome



**Passenger Peg Mount Kit** mounts to rear existing mount to accept a male peg set. Kit allows 360° rotation to raise or lower peg height. Fits 2007-up FXST.

VT No. 27-1544

# Rear Footpeg Mount



27-0875 Installed

**Rear Footpeg Relocation Kit** includes chrome brackets and cat paws soft pegs.

**VT No. 27-0875**



27-0858 Installed



27-0858



**Passenger Footpeg Relocation Kit** offers an extra peg location by using the unused seat mounting hole in front of strut of 1984-99 FXST. Available as Peg or Stud Conversion kit.

**VT No. Item**

27-1719 Clevis Kit with studs

37-8859 Stud Kit only



27-1719



27-0861

**2006-up Chrome Peg Mount Set** fits FXD-FXDWG models. Order male pegs separately.

**VT No. Item**

27-0858 Mounts Stock Height

27-0861 Mounts, Raised Height

27-1232 Peg Set

37-0020 Mount Bolts

27-1010 Foot Board Set



Left

27-0475 Installed

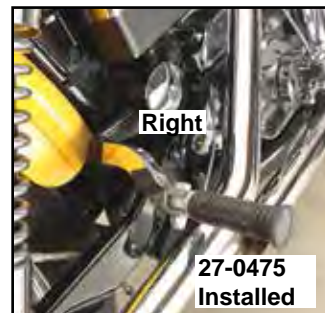

Right

27-0475 Installed



31-5019



27-0060

**Rear Footpeg Relocation Brackets** place pegs in a more comfortable position, chrome, pair.

**VT No. Fits**

31-5019 1984-up FXST

27-0061 1986-up FLST

27-0060 1973-84 FXE

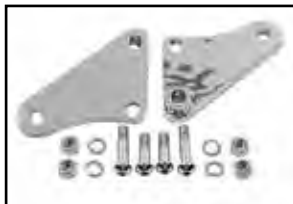

**FXR Passenger Footpeg Kit** includes chrome brackets and bolts, which moves passenger footpeg higher and more forward. Stock or custom 1/2" stud footpegs can be used.

**VT No. 27-1531**



**Chrome Rigid Frame Rear Footpeg Mount Bolts** to 4-Speed transmission plate or can be mounted behind transmission on custom frames by fabrication of mount strap.

**VT No. 27-0632**



**Weld On Footpeg Mounts** can be welded to 1958-77 Big Twin swing arm frames to utilize the stock FXE mount to raise peg position.

**VT No. 51-0504**



27-0475



27-0439

**1994-05 Rear Footpeg Mount Kit** includes right and left bracket. Order pegs separately.

**VT No. Item**

27-0475 Bracket Kit

27-0439 Mount Kit with Pegs

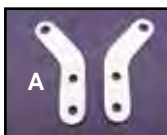

A

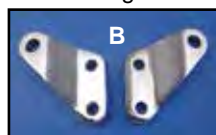

B



C



D

**Chrome Rear Footpegs and Mounts** fit 1977-84 FX models. Mount blocks 51-0504 can be welded to FL-FX frames 1958-84 for peg mounting. The 27-0060 elevates peg position for custom exhaust.

**VT No. # Item**

27-0060 A Elevated Peg Brackets

27-0056 B Stock Peg Brackets

27-0051 C Mount Yoke 1/2 x 20"

27-1534 C Mount Yoke 3/8 x 24"

27-1228 D Peg Set 1/2" Yokes w/clevis

27-3563 Yoke Set





# Mini Footboard



**Mini Footboards** are fully adjustable foot pad is full rubber on foot surface with chrome design on back side.

**VT No. Type**  
27-3544 Large  
27-3545 Small  
27-1441 Small

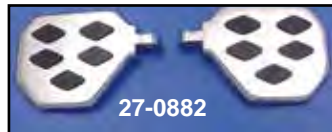
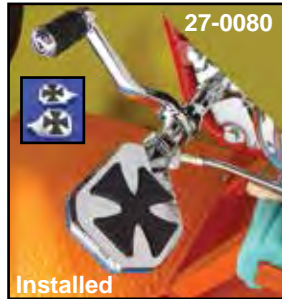

**Chrome Mini Bullet Footboards** are used to replace passenger pegs with male clevis mount. Can also be installed on engine guards with appropriate clamps. Boards are machined from solid billet.

VT No.	Style	VT No.	Style
27-0691	3 Pad	27-0880	5-Rail
27-0080	Maltese	27-0882	Diamond
27-0881	Wave	27-0883	Flame



**D Style Passenger Style Size.**  
VT No. 27-0741



**Male Footpeg** with heel rest.  
VT No. 27-0799



**Mini Footboard Set.**

Chrome	Black	Size
27-0479	27-0481	4"
27-0482	27-0483	3"



**Billet Mini Footboards** fit passenger peg mounts that accept male pegs.

VT No.	Style
27-0793	Chrome with black
27-1759	Black with black



**Mini Footboards.**  
**Chrome Black**  
27-0477 27-0478  
**Rear Passenger Mount Kit.**  
27-0440 27-0441



**Adjustable Driver's Mini-Footboard Kit** measures 7¼" x 3½" male end. Fits into stock female footpeg clevis on models with forward controls and features 7/8" of fore-to-aft movement, they may be rotated in a 360° arc.

VT No. 27-0669

# Passenger Mini Footboard Set

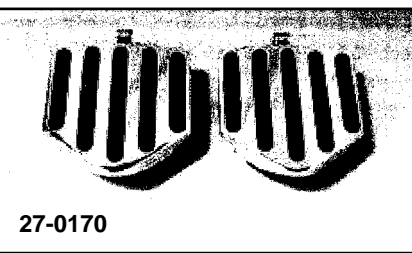
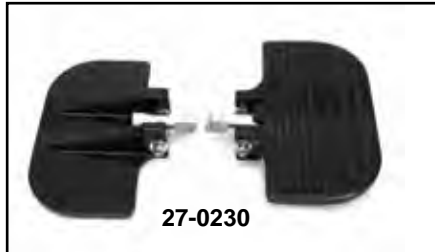
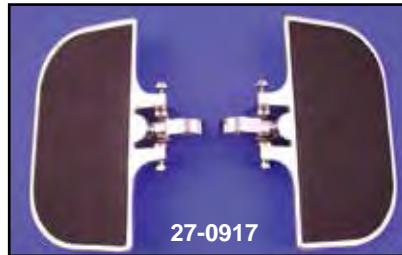

**Chrome Passenger Mini-Footboards** feature non-slip rubber surface and mounting studs. VT No. 27-0909 for use with 27-0056, 27-0060, 27-1531, or on front type with 27-0607, 27-0609, 27-0610, 27-0608 or on existing plates which have hole for stud type mounting. Boards measure 8" x 4 1/4" overall.

**VT No. Type**

- |                                 |                               |                                      |
|---------------------------------|-------------------------------|--------------------------------------|
| <b>27-0909</b> Stud Type        | <b>27-0930</b> Diamond Style  | <b>27-0170</b> 360° rotation, chrome |
| <b>27-0917</b> Rubber Style     | <b>27-0852</b> Wave           | <b>27-0171</b> 360° rotation, black  |
| <b>27-0928</b> Flame (Outside)  | <b>27-0950</b> Rubber         | <b>27-1760</b> Black Slot Inverted   |
| <b>27-0929</b> Rail Style       | <b>27-0993</b> Flame (Inside) | <b>27-1006</b> Black Stud Mount      |
| <b>27-0230</b> Black Rail Style | <b>27-1239</b> Slot Inverted  | <b>28-0613</b> Black Rubbers         |





# 1965-84 FLH Passenger Footboards



**Rear Footboards** are passenger type, chrome steel. Attach by sliding into lower frame tube & bolting to same. Fit 1968-84 FLH.

**VT No. Item**

**27-1532** Footboard Set

**28-0420** Passenger Footboard Mats



**1977-84 FLH Passenger Footboard Kit** includes brackets and chrome boards with rubber pads.

**VT No. Item**

**27-0618** Kit

**27-0856** Adapter Stud



**FLH Passenger Footpeg Brackets** are fully adjustable for 1977-84 FLH.

**VT No. OEM Side**

**27-1578** 52686-77A Right

**27-1579** 52690-77A Left

**27-1592** Chrome Set

**27-0064** Polished Set

## Early Footboard



27-0901



27-0966



27-0902

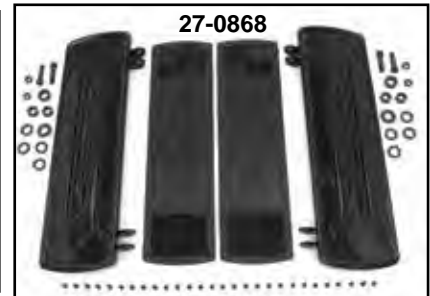

27-0868

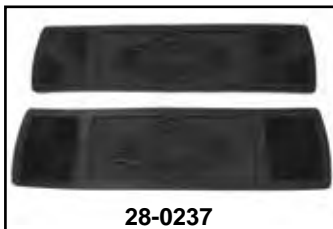

28-0237

**Early Square Type 1914 Footboards** fit 1941-85 FL models.

Rubber pads not included except with 27-0868.

**VT No. Item**

**27-0901** Raw

**27-0966** Black

**27-0902** Chrome

**28-0237** World's Fair Rubber Pads

**27-0868** World's Fair Style

**9886-12** Bolts

**27-0757** Raw Cleat Set



# Footboard

## Footboard Mat

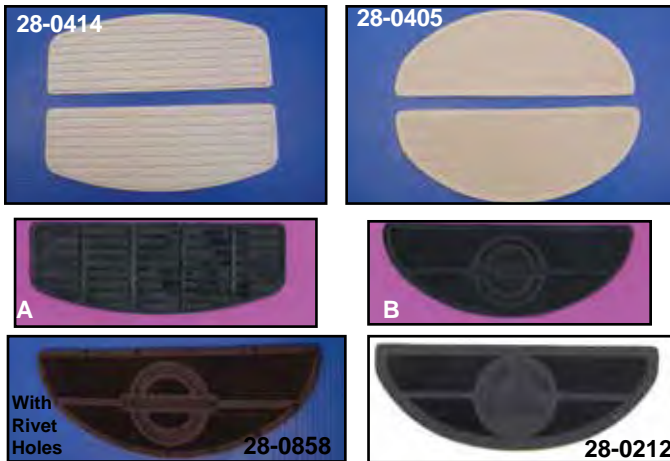

**Footboard Mats** sold in pairs. Must be affixed by adhesive or rivets, on earlier models.

VT No.	#	Year	Color
28-0413	A	1966-up	Black
28-0414	A	1966-up	White
28-0429	A	1966-up	Teal
28-0430	A	1966-up	Orange
28-0431	A	1966-up	Blue
28-0432	A	1966-up	Yellow
28-0404	B	1940-65	Black, H-D
28-0672	B	1940-65	Black, Plain
28-0858	B	1940-65	Black, H-D
28-0672	B	1940-65	Black, H-D
28-0405	B	1940-65	White, Plain
28-0212		1940-65	Black
28-0459		1940-65	Straight Rib Design
28-0868		1941-65	Footboard Mat, black



**Footboard Rivets** for use 1914-65 replaces 50616-14, 28 pieces.

VT No.	Finish
27-0597	Black
27-1272	Stainless

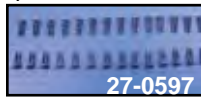

## Footboard Inserts

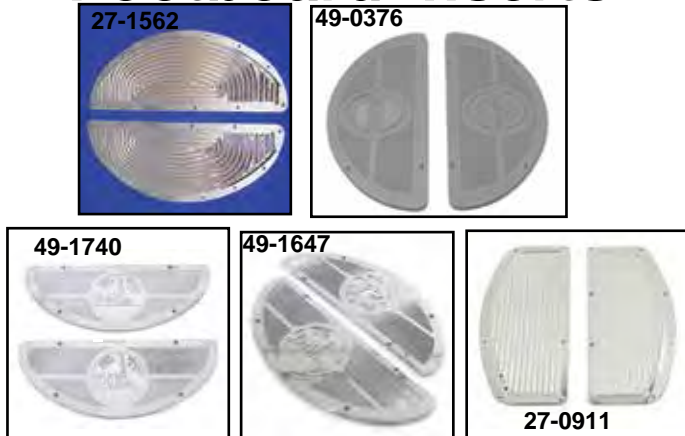

**Half Moon Inserts.** Pairs.

VT No.	Style	Finish
27-1562	Rib	Chrome
49-0376	Deluxe	Alloy
49-0436	Deluxe	Chrome
49-1740	World's Fair	Alloy
49-1647	World's Fair	Chrome
<b>D-Shaped 1966-73</b>		
27-0911	Rib	Chrome

## Insert

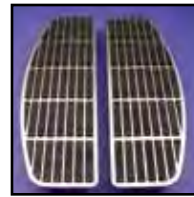

**Chrome Footboard Trim.** Footboard Set inserts are fitted to an iso-mount footboard top to fit 1974-up FL-FLT-FLST.  
VT No. 27-1705



**Chrome Billet Footboard Pad Set** features Billet construction with built in rubber strips on surface. Rubber Iso-Mount included which plug into stock board on 1980-up FLT, 1986-up FLST.  
VT No. 27-0924



**Chrome Billet Footboard Pads** include Iso bushings for 1966-84 Big Twins.

VT No.	Item	Year
27-1054	Board Set with pads	1966-84
27-0570	Pad Set	1974-05



27-1574



27-1666



Bottom

**Upper Footboard Plate** for 1974-91. Includes eight iso-buds with two upper plates and rubber mats, 1992-up has iso-buds molded in for updated design.

VT No.	Fits	U/M
27-1574	1974-91 FL-FLT	Pair
27-1666*	1992-up FLST-FLT 1980-up Touring	Each

\*Note: Can be used on all 1974-up type Iso footboards.

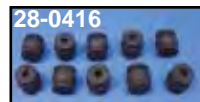

28-0416

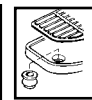

**Iso-Mount Buds.** Set of 10 for footboards, 1974-up FLH-FLT.  
VT No. 28-0416

Iso Boards and Replacement Parts first offered by V-Twin in 1985.





# Chrome 'D' Driver Footboard

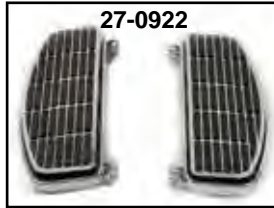

**Chrome 'D' Shaped Footboard Set.** Fit 1966-84 FLH, 1941-73 FL. Pair.  
**VT No. Style**  
**27-0922** Iso  
**27-1799** Flame



**Chrome 'D' Shaped Footboards** include rubber pads. The Iso boards feature a raised footboard pad with anti-vibration rubbers. Sold in pairs.

VT No.	Year/Model	Type
27-0904	1966-73 FL	Solid
27-0826	1966-72 FL	Black
27-1545		Solid
27-0903	1966-85 FL	Iso Type
27-0918	1966-85 FL	Kit with brackets
27-0749	1966-85 FL	Pans Only

**"D" Shape Billet Footboard Set** is chrome with black molded rubber insert.

VT No.	Shape
27-1204	Diamond
27-1203	Rail
27-1205	Flame



**"Chain Drive" Chrome Half Moon Footboards** are 1940's style with welded chain trim. Order rubber pads or chrome inserts separately.

VT No.	Item
27-0921	Board Set
27-0371	Kit

**Vintage Footboard Sets** feature classic half moon design with "shaker" Iso-mount cushion area. Black pads included.

VT No.	Fits	Type
27-0912	1940-84 FLH	No Bullseye
27-0927	1940-84 FL	Bullseye
27-0863		Rail Trim

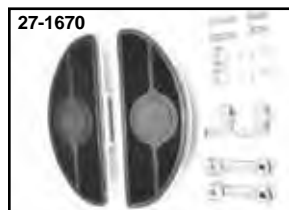
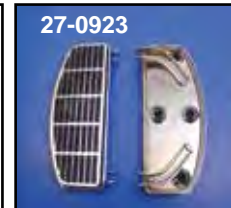

**Adjustable Footboard Kits** permit a full 7" fore-aft adjustment along with angle and height adjustability. Kits are designed to fit 1980-86 FXWG, 1984-up FXST and 1990-up FLST and fit wherever a male clevis style footpeg mounts. Complete w/hardware.

VT No.	Item	Type
27-1595	Half Moon	Shaker
27-1594	D Style	Shaker
27-1612	D Style	Solid
27-1670	Half Moon	Solid
27-0784	—	Brackets



**'D' Shaped Footboards.** Chrome finish unless noted.

VT No.	Fits
27-0798*	Pans, 2002-up FLT
27-0992	Iso, 2006-up FLST, FLT
27-0923	Iso 1980-up FLT, 1986-up FLST
27-0906	1980-up FLT, Iso Type 1986-up FLST
27-0914	Black Iso 1980-up FLT, 1986-up FLST
27-1000	Black Iso, 2006-up FLT, FLST
27-1798	Flame, 1980-up FLT, FLST



\*Note: Extends the footboard forward by 1 inch from stock location. Require the re-use of upper floorboard pan.

# 1940-84 Driver Half Moon Footboard



**Half Moon Style Shape Footboards** fit the stock mounting brackets on 1940-84 FL and 1940-65 45" models.

Black	Chrome	Note
27-0907	27-0908	Rubber Mat with bullseye
—	27-0884	Rubber Mat
27-0915	—	Metal Top
—	27-0900	Rubber H-D Logo Mat
27-0916	27-0949	Metal H-D Logo Mat
27-0947	27-0781	Board Only
27-0684	—	Rubber Logo Mat
27-0943	—	Footboard Only

**Half Moon Board Kits** with pads.

Black	Chrome	Note
27-1240	27-1535	Deluxe
27-0751	—	Alloy Deluxe
27-1517	—	World's Fair Rubber
27-0752	27-1049	World's Fair Chrome
27-0372	27-0373	Chrome Ribbed
—	27-0371	Chrome Chain Ribbed
27-1542	—	World's Fair Chrome Alloy
27-0869	27-0867	World's Fair Black Alloy
—	27-1794	Ribbed Steel
27-0756	—	Raw Footboard Cleat Set (4)





# Footboard Bracket for 1965-84



**Footboard Mount Kit** for aluminum primary models 1965-84 FL-FX, when using custom pipes, includes extended front footboard bracket for needed clearance.  
VT No. 27-0599

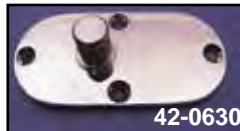
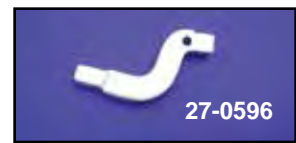
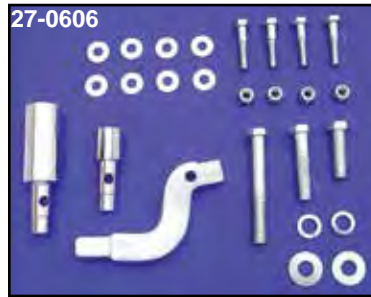

**Chrome Splined Footpeg Supports** for FX-FL.

VT No.	Side/Item	Type	Image
27-0055	Right, Support	Straight	
27-0045	Right, Support	Offset	
27-1563	Right, Bracket	Plate	
42-0630	Left, Chrome Inspection Cover	With spline	
37-0155	Chrome Screws	For Above	
27-0046*	FXR Stud	With spline	
12-0201	Key for Above		

\*Note: Stud is keyed for positive mount.

**Aluminum Primary Footboard Mounting Kit** fits Big Twin 1965-84 FLH-FXE models equipped with FL type forward controls and primary cover with footboard tab.

VT No.	Item	Fits
27-0606*	Complete Kit	
27-0636	Stud, short	Right
27-0596	Rear Bracket	Right
27-1621	Front Stud, zinc	Right

\*Note: Includes extended rear footboard bracket when using custom drag or muffler pipes.

**Rear Footboard Brackets** fit 1970-84 FLH, 31-0098 is for use with drag or custom pipe sets when footboards are used. Zinc plated.

VT No.	Type
27-0596	Stock
31-0098	Custom Drag Pipe

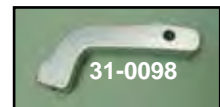

## 1936-57 Rigid

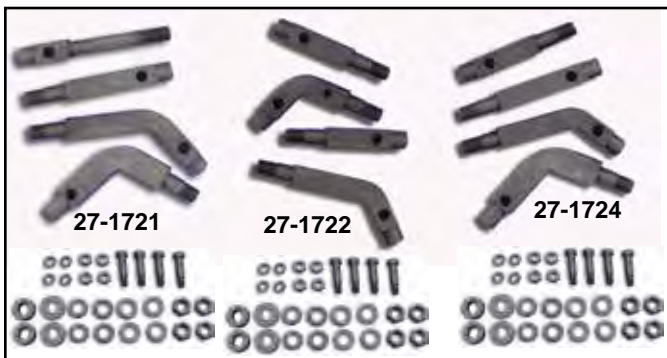

**Replica Footboard Mount Bracket Kits** include four brackets and related mount hardware for Big Twins.

VT No.	Fits
27-1722	1936-54 Rigid
27-1724	1955-57 Rigid
27-1721	1958-64 Swingarm

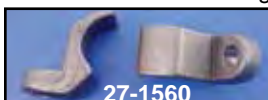

**Footboard Tabs** can be welded on 1936-84 Big Twins. Available in stamped or authentic forged steel construction for custom or stock frames. Sold in pairs.

VT No.	Dia.	Type
27-1560	1 1/8"	Forged, exact
27-0311		Stamped tabs
27-0664	1"	Forged, exact

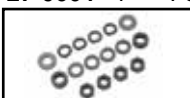

**Footboard Bracket Stud Nut and Washer Kits**, parkerized. Fits 1936-57 Big Twin  
VT No. 9905-16

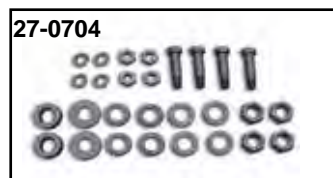

**Footboard Mount Bracket Kit** fits 1936-64 Big Twin models with stamped steel primary. 5 Piece Kits include both brackets for mechanical or hydraulic brake models.

VT No.	Finish	Years	Pieces
27-0605	Chrome	1936-64	5
27-1702	Parkerized	1936-64	5
8773-12*	Cadmium	Bolt Set, Hex	
9685-12*	Parkerized	Bolt Set, Hex	
9886-12*	Parkerized	Bolt Set, Slot	
27-0704	Parkerized	Bolt Set, Hex	

\*Note: Mounts footboards to brackets

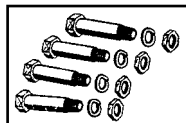

**Footboard Bolt Set.** Four piece set of hinge bolts with nuts. Replaces 50635-14.

VT No.	Type
8773-12	Cadmium
9685-12	Parkerized
2125-12	Zinc



# Throttle



**Radii Billet Throttle** accepts single 1982-95 throttle cable.  
VT No. 35-0255



**Chrome Throttle Housing** custom design for single cable operation.  
VT No. 36-0151



**Dual Billet Throttle Housing** for use with idle and throttle cable.  
VT No. 36-0564



28-0116



28-0786



35-0261



28-0002



28-0003



28-0004

**Original Jack Hammer Handlebar Grips** include grip. Thick black rubber. 1960's style.

VT No. Type

- 35-0071 Grip Throttle
- 28-0786 Grip Set with tube
- 28-0116 Grip Set
- 35-0347 Grip Kit
- 28-0002 Brown
- 28-0003 Red
- 28-0004 White
- 7/8"
- 28-0182 Grip Set
- 35-0261 Grip and Throttle



**Anderson Motorcycle Supply**  
Patch. VT No. 48-1358



**Flanders Patch.**  
VT No. 48-1787



35-0253



35-0254

**Chrome Throttle Clamps and Tube Set** feature smooth design, upper and lower pieces with screws and nylon throttle tube, for single or dual cable application. For use with 1982-up type cables.

VT No. Type

- 35-0253 Single
- 35-0254 Dual



36-0790



35-9871

**Electronic Throttle Assembly** with gear and wire for 2008-up Touring models with "TBW" throttle by wire.

VT No. Item  
36-0790 Throttle  
35-9871 Tube



32-1202



32-1204

**Throttle by Wire Extension "TBW" Harness Kits** will plug in to the existing 6 position Molex connector. These wire extensions will not cause interference to motorcycles computer when installing taller handlebars.

VT No. Extension

- 32-1205 +4"
- 32-1202 +8"
- 32-1206 +12"
- 32-1204 +16"

## Internal Throttle



36-0570



36-0595

VT No. 36-0570 **Internal Throttle Sleeve.** Custom design allows pull action of throttle cable for use with billet grips.

VT No. Item  
36-0570 Throttle  
36-0595 Ball Bearing

1. Cut 2 3/8" off end of handlebar. Remove end of throttle handle that would attach to throttle cables.
2. Mark handlebar for inner throttle sleeve. Drill a hole for the set screw, this will hold throttle on the handlebar.
3. Remove set screw from the outer sleeve of spiral. Slide grip on & mark end of grip on the handlebar. Measure from this mark back to set screw in outer sleeve. This measurement will be used to mark & drill the throttle grip. Once drilled install grip. Use a small amount of Loctite® on set screw for final installation.
4. Note Set Screw (A) do not tighten so as to make contact with handlebar it will prevent throttle from turning.



Inner Sleeve

A



36-0575



36-0598



36-0789

**Internal Throttle/Clutch Unit** features ball and needle bearing construction with built in return spring.

VT No. Type Item

- 36-0575 Throttle Assembly Uses 3 types of bearings  
36-0598 (4), 36-0591 (1), 36-0590 (1)
- 36-0598 Bearing Assembly Refer to H in installation instructions
- 36-0789 Clutch Assembly
- 36-0590 Bearing 5/8 x 1 3/16 x 5/8
- 36-0591 Bearing 5/8 x 7/8 x 9/32





# Bar Grip Set



**Chrome Handlebar Grip Set** is constructed of billet alloy with chrome spike ends.  
VT No. 28-0945



**Skull Chrome End Handlebar Grip Sets.** Order throttle inner sleeve separately.  
VT No. Item  
28-0144 Grip Set  
28-1981 Inner Sleeve



**Shooter Handlebar Grip Set** feature brushed metal finish with holes.  
VT No. 28-0590



**O-Ring Handlebar Grips** machined chrome grips with O-Rings. For show use. 1" and 1 1/8" size for 1974-up controls. Show use only.  
VT No. 28-2011

## Handlebar Grips 2008-up TBW "Throttle By Wire"

**Handlebar Grip Sets** for Touring models 2008-up feature the built in serrations in the throttle side to twist the "TBW" throttle by wire electronic throttle assembly.

- | VT No.  | Style                |
|---------|----------------------|
| 28-0298 | Banded               |
| 28-0857 | Flame                |
| 28-0647 | Diamond              |
| 28-0891 | Chrome Dome          |
| 28-0988 | Swiss Cheese, Billet |
| 28-0856 | Vintage              |
| 28-0846 | Stock Replica        |
| 28-0646 | Iso Bar              |
| 28-0645 | V-Tech               |
| 28-0654 | Eagle Passion        |
| 28-0640 | Tornado              |
| 28-0664 | Slasher              |
| 35-9871 | Tube                 |



**Black Cobra Grip.**  
VT No. 28-0926

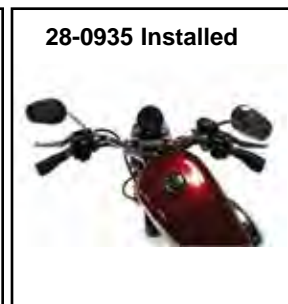
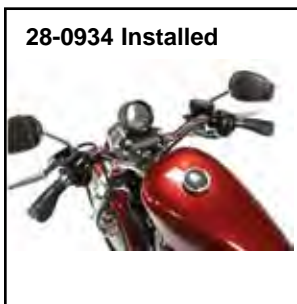

**Donkey Handlebar Grip Set** with chrome end caps.  
VT No. Type  
28-0934 Dual Cable  
28-0935 TBW



28-0297



28-1506



28-0799

**Chrome Handlebar Grip Set** is constructed of billet alloy with chrome.

**VT No. Style**

**28-0297** Band

**28-0001** Band Wrist

**28-1506** Banded, Skull

**28-0799** Wrist Rest



**Banded Grip Set** includes wrist rest.

**VT No. 28-0001**



28-0785 Installed



**Billet Gripster Set** features contour shape for firm grip to accept single or dual throttle cable assemblies.

**VT No. 28-0785**



**Odins Contour Handlebar Grip Set** is constructed of billet alloy with chrome.

**VT No. 28-0784**



**Billet 6 Rail Handlebar Grip Set.**

**VT No. 28-0796**



28-0785



28-0784

# Billet Grip Set



28-0607

**Iso-Billet Handlebar Grip Set Design** matches 22-0755 forward control set. Fits dual throttle.

**VT No. 28-0607**



**Billet Rocket Handlebar Grip** features jumbo O-rings for good grip.

**VT No. 28-0588**



28-0278



28-0280

**Chrome Billet Pirate Handlebar Grip Set** to accept single or dual throttle cable assemblies.

**VT No. Type**

**28-0278** Groove

**28-0280** XGroove



35-9073



35-9870



28-1981



35-9871



35-9870

**Nylon Throttle Tubes.**

**VT No. Type**

**35-9073** Single 1976-81

**28-1981** Dual 1982-95

**35-9870** Dual 1996-up (Black)

**35-9871** Throttle by Wire 2008-up



**Chrome Billet Slasher Grip Set** are designed for throttle by wire applications.

**VT No. 28-0664**



**Brass Swiss Cheese Grip Set** fits custom applications.

**VT No. 28-0631**

MULTI FIT/CHOPPER

**Billet Grip Sets.**

Chrome	Type
28-0785	Gripster
28-0784	Odins

Note: All Billet Grip Sets are designed for show and off road use only.





# Handlebar Grip



**Dual Hot Rod Flame Handlebar Grip Set** features molded cushion rubber inner sleeve with chrome flame outer sleeve, for looks and comfort.

**VT No. Year**  
**28-0454** 1982-95  
**28-0451** 1996-up



**Profile Barrel Handlebar Grips** feature chrome accents with barrel shape rubber insert for comfort.

**VT No. Shape**  
**28-0570** Rail  
**28-0571** Twist



**Metal Flake Handlebar Grip Sets.**

**VT No. Color**  
**28-0792** Charcoal  
**28-0793** Red  
**28-0798** Yellow  
**VT No. Color**  
**28-0794** Silver  
**28-0795** Blue  
**28-0797** Aqua



**Black Rubber Hillclimber Grip Set** feature original 1940's design for Spring Fork handlebars with Beck logo.



**VT No. Year**  
**28-0481** pre1935 1 1/8" (2)  
**28-0480** 1936-48 1 1/8" (2)  
**28-0479** 1976-98 1" and 1 1/8" (Set)



**Chrome Diamond Insert Handlebar Grips** are die cast construction for 1974-up models.

**VT No. Type**  
**28-0563** Die Cast  
**28-0446** PVC



**Chrome Eagle Spirit Sets** feature full foam grips with chrome or gold inlay end caps.

**VT No. Type**  
**28-0573** Smooth  
**28-0891** Smooth 2008-up Touring



**Chrome Rail Grip Set** use with 28-1981 nylon tube.  
**VT No. 28-0742**

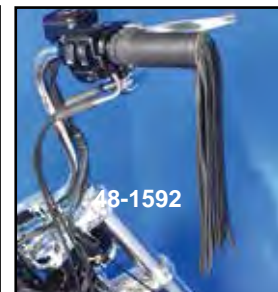

**Handlebar Grip Covers** are in leather. Available with or without fringe.

**VT No. Type**  
**48-0449** No Fringe  
**48-1592** 10" Fringe



**Handlebar Grip Adhesive** fastens grips to bars.

**VT No. 41-0190**





# Billet Grip Set



Chrome Billet Grip Sets accept single or dual cable assemblies.

<b>VT No.</b>	<b>Style</b>	<b>28-0678</b>	Slugger	<b>28-0759</b>	Skull
<b>28-0579</b>	Spiral	<b>28-0567</b>	Phat	<b>28-0595</b>	Ventilated
<b>28-0580</b>	Diamond	<b>28-0586</b>	Faceted	<b>28-0596</b>	Vintage with Grooves
<b>28-0581</b>	Smoothie	<b>28-0279</b>	Druid	<b>28-0597</b>	Slugger with Grooves
<b>28-0057</b>	Maltese	<b>28-0569</b>	Batique	<b>28-0630</b>	Brass Spearhead
<b>28-1987</b>	Swiss Cheese	<b>28-0326</b>	Flame		
<b>28-0578</b>	Spike	<b>28-0741</b>	Flame		

# Vintage Grip Set



**Vintage Style Handlebar Grips** feature retro molded rubber design with a chrome accent band throttle grip includes nylon sleeve for dual cable operation.

<b>VT No.</b>	<b>Year</b>	<b>Model</b>
<b>28-0148</b>	1996-up	Softtail-XL
<b>28-0149</b>	1973-95	Softtail-XL



**Vintage Style Handlebar Grip Set** is the 1909 style for use on 1974-up with a 1" & 1 1/8" size for twist grip assemblies. Translucent colors as noted.

<b>VT No.</b>	<b>Color</b>
<b>28-0594</b>	Black, dual cable
<b>28-0107</b>	Black
<b>28-0108</b>	White
<b>28-0160</b>	Red
<b>28-0972</b>	Brown
<b>28-0973</b>	Yellow
<b>28-0974</b>	Blue
<b>28-0975</b>	Grey

MULTI FIT/CHOPPER





# Handlebar Grip



28-0241



28-0242



28-0243



28-0244



28-0245



28-0246



28-0247



28-0248

## Handlebar Grip Sets.

### 2008-up Touring with TBW

- 28-0241 Plain, Chrome
  - 28-0242 Shot Peened, Chrome
  - 28-0243 Black with cut
  - 28-0244 Stealth Tone Black
- 1982-15
- 28-0245 Plain, Chrome
  - 28-0246 Shot Peened, Chrome
  - 28-0247 Black With cut
  - 28-0248 Stealth Tone Black



**Chrome O-Ring Insert Handlebar Grip Set** includes nylon throttle tube for dual or single cable operation.  
**VT No. 28-0585**



28-0452



28-0150



28-0206



28-0456



28-0456

## Custom Handlebar Grip Sets.

VT No.	Item	Years
28-0452	Iso Bar	1996-up
28-0150	Deco	1996-up
28-0206	Chrome End	—
28-0456	Chrome End	2004-up XL



28-0113



28-0114



28-2021

**1962-72 Handlebar Grip Sets** are 1 1/8" ID on both sides to fit internal throttle control. 28-0113, 28-0114 include chrome end plugs.

VT No.	Color	Note
28-0113	Black	With plugs
28-0114	White	With plugs
28-2021	Black	Without hole



28-0601



28-0602



28-2000



28-2016



28-0131



28-0628



28-2126

**Replica Stock Handlebar Grip Set** includes chrome plugs 1 1/8" and 1" size for 1974-up replacing 56206-74 for FX-FL models.

Black	White	Fits
28-0601	28-0602	1974-up
28-2000*		1974-up
28-2016**		1981-up
28-0131***		1974-80, left side, each
28-2126**		1981-96, left side, each
28-0628		2004-up XL

\*Note: Grip set less plugs.

\*\*Note: Does not accept chrome plugs

\*\*\*Note: Order chrome plugs separately.



**Flame Billet Handlebar Grip Set** for single or dual throttle application.

VT No.	Style
28-0741	Barrel
28-0845	Flanged



**Fat Billet Grips** match outside diameter of large bars for symmetry. Both have inner diameter for fit ends and accept single or dual throttle cable.

VT No.	Size
28-0583	1 1/4"
28-0582	1 1/2"



28-0642



28-0643

**Billet Handlebar Grip Set** with multi-band.

VT No.	Type
28-0642	Multi-band
28-0643	6 flats bands.

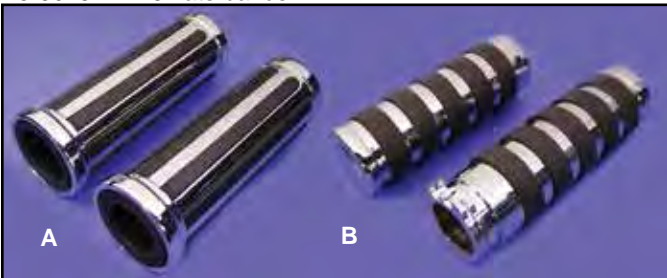

**Chrome V-Tech Handlebar Grips.** *Type B* features flat O-Rings for a firm grip. *Type A* is a rubber rail design set in a chrome die cast grip.

VT No.	#	Type
28-2229	A	Iso
28-2251	B	Chrome



**Chrome Delta Handlebar Grip Set** feature a 3 point eccentric form with rubber cushion inserts.

VT No. 28-0153

# Handlebar Grip

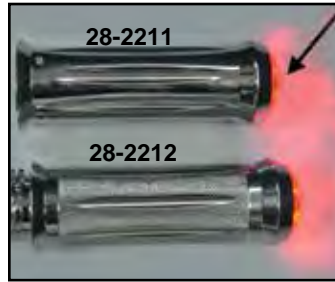

5 LED's Powered by 3 small batteries the end caps light up when pressed. There are 3 options:

1. On steady
2. Flashing on/off
3. One light flashing in circular pattern
4. Off



28-2211



28-2212

**Billet Handlebar Grip Sets** feature 4 position LED end lights.

VT No.	Style
28-2211	Groove
28-2212	Knurl



28-0051



28-0576



28-0050



28-0052



28-0584

**Chrome Billet Throttle Handlebar Grip Set** for single or dual cable use.

VT No.	Type
28-0051	Twist
28-0576	Flame
28-0050	Groove
28-0052	Groove Grips
28-0584	Diamond





# Stock Grip



### 1962-72 Rib Style Grips.

VT No. Color  
 28-0118 Black  
 28-0119 White

28-0184 Red  
 28-0185 Blue  
 28-0186 Yellow  
 28-0187 Green



**Replica Waffle Handlebar Grips** are replacement for 56212-53. on 1949-61, in 1 1/8" x 1 1/8" size or 1974-up late type 1"-1 1/8" size. Available in pairs.

VT No.	Color	Year	Size
28-0159	Black without plug hole	1949-72	1 1/8"
28-0110	Black with plug hole	1949-72	1 1/8"
28-0111	White	1949-72	1 1/8"
28-1985	Black	1974-up	1" and 1 1/8"
28-0121	White	1974-up	1" and 1 1/8"



### Beck Plastic Grip Set.

VT No.	Color	Year	Color	Year	Color
28-0931	Black	28-0958	Blue	28-0960	Green
28-0957	Red	28-0959	Yellow	28-0961	White



**Original Jack Hammer Handlebar Grips** include grip. Thick black rubber. 1960's style.

VT No. Type  
 35-0071 Grip Throttle  
 28-0786 Grip Set with tube  
 28-0116 Grip Set  
 28-0002 Brown  
 28-0003 Red  
 28-0004 White  
 7/8"  
 28-0182 Grip Set  
 35-0261 Grip and Throttle

**28-0618 Chrome Handlebar End Plug.** Sold in pairs. Plain Chrome, 10 pack  
 VT No. 28-0618

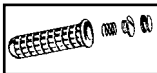

**1953-61 Grip Hole Plugs** are zinc plated with groove, pair. Replaces 56239-53.

VT No. 28-0625



**Heated Handlebar Grip Set** fits 1996-up models. Includes end caps. Fits FXST 1996-up FXST, FLST, FXD, XL and 1996-2007 FLT.

VT No. 28-0589



**Chrome End Handlebar Grip Sets** feature soft touch grip area with foam or leather covering to reduce vibration.

Available in chrome plated end cap with smooth cap or embossed emblem. Fit 1974-up models.

VT No. Type  
 28-0125 Embossed Cap  
 28-0124 Smooth Cap  
 28-2015 Smooth Cap, Leather  
 28-0445 Pebble  
 28-0446 Diamond



24-0503  
Installed

# 1960-84 FLH Headlamp Cowl



24-0500

**1948-84 FLH Headlamp Cowl Kit** available with complete lamp assembly with rim, chrome or polished housing set with matching top handlebar cover as pictured. Choose bulb or H-4 type



24-1960

**Complete 1960-84 FLH Headlamp Cowl Assembly** includes chrome or polished cowl set, top handlebar clamp cover, complete headlamp assembly with chrome rim and spot lamp, signal lamp set. Kit includes the hardware necessary for installation.

VT No.	Item
24-0502	Chrome Kit
24-0503	Polished Kit
33-2028	Spot Lamp Kit, 12 volt complete with signals
24-0281	Handlebar Cover, Polished
24-0250	Handlebar Cover, Chrome



24-0251



24-0255

**1960-84 FLH Headlamp Cowl Set** are die cast replicas in polished or chrome finish.

VT No.	Finish
24-0251	Chrome
24-0255	Polished

Bulb	H-4	Item
24-0500	24-1565	Chrome Kit
24-0501	24-1566	Polished Kit
	24-1960	Black Kit
37-0808		Screw Kit, Stainless Steel
37-0815		Screw Kit, Chrome
37-0949		Screw Kit, Replica

Slider Cover Sets	
24-0190	Chrome
24-9962	Stainless



24-0250



24-1862



24-0330



24-0281



33-2004



33-2014



33-3041

**Handlebar Clamp Cover** replaces original type FLH 1960-84 Wide Glide Forks.

VT No.	Year	Type
24-0250	1960-79	Chrome Smooth
24-1862	1960-79	Black
24-0281	1960-79	Polished Smooth
24-9963*	1960-79	Chrome with Damper Hole
24-0330	1980-84	Chrome Smooth
24-1086	1960-84	Chrome/Hole
37-8701	1960-84	Chrome Screws for Above

\*Note: Uses 24-0202 Damper Kit.

**FLH Headlamp Assembly** includes parts pictured to fit housings on 1960-84 FLH. Available Halogen, standard sealed beam or H-4 unit.\*Note: Rim not included.

VT No.	Type
33-2004	H-4
33-2014	Sealed Beam
33-3041*	H-4

## 7" Round Internals

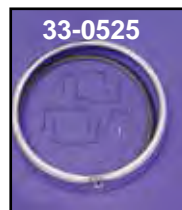

33-0525



33-2004 Complete Kit



**Headlamp Wire Connector Block** for Hi-Low beam headlamp.  
VT No. 32-8037

**FLH Headlamp.**

VT No.	#	Note
33-0036	A	Headlamp Body
33-0525	B	Chrome Rim
33-2003	C	Headlamp Mounting Ring
33-0527	D	Retaining Ring
37-8921	E	Adjuster Screw, pair
33-2004*	F	Complete Light Unit
33-2014	F	Complete Light Unit with Seal Beam
15-0303	G	Gasket, 5 pack
13-9256	H	Door Spring

\*Note: Includes all items and is Halogen.



33-2014 Assembled



**Headlamp Adapter Ring** is of cast construction to fit 1960-84(VT No. 24-0255) Headlamp cowl to allow use of adjustable triple trees (raked) for headlamp adjustment.  
VT No. 33-0156





# Headlamp Rims

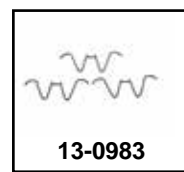
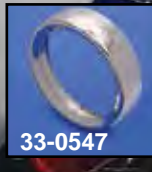

Frenched Headlamp Ring fits 83-up models VT No. 33-0547



7" Headlamp Trim Rings for Touring models.

2014-up 1996-13  
Chrome

Type

	33-1174	LED
	33-0080	Contour
	33-2134	Stock
33-0808	33-1174	Deep Dish
33-1116	33-0812	Visor
<b>Black</b>		
33-1113	33-1112	Visor
33-1115	33-1114	Deep Dish
	13-0983	Clip
<b>Spotlamp</b>		
	33-0811	Visor
	33-0546	Deep Dish





# 7" Vintage Lamp



33-0037



33-0023



33-0020



33-0603



33-0023



Cycle Ray™ and Guide Logo™ are used under license from General Motors.



7" Vintage Headlamp fit WG forks, 12V.

VT No. Item

33-0020 Bulb

33-0603 FLH With High Beam Indicator

33-1548 With High Beam H-4



33-0067



2006-3

7" Headlamps include a sealed beam. Order mount brackets separately.

VT No. Fits

33-0037 1949-59 FLH, 6V

33-0023 1949-59 FL, 6V Replica, Chrome

33-0067 1949-59 FL, 6V Replica, Black

33-2120 6V K Model

33-0072 7" K Model, black with chrome rim

33-1998 Inner Door

33-0524 Outer Rim

33-2009 12V Halogen, Beam Only

2006-3 Stem Mount Nut Kit

Head Lamp Shells Only

VT No. Fits Finish

33-0068 FL Chrome

33-2254 K Black

33-2120A K Chrome

32-0676 Socket Wire, replaces 67753-48



33-0067



33-2120



33-0072



33-1998



33-0524



33-2009



33-2254



33-2120A

Lamps listed are for show or decorative use only, and not D.O.T. approved.





# Fork Cover Set for FLST



24-9958



24-9959

**Chrome Fork Cover Kits** fit 1986-up FLST in 3 piece tin set or 5 piece which includes slider covers, stock length.

- |               |                                 |
|---------------|---------------------------------|
| <b>VT No.</b> | <b>Item/Style</b>               |
| 24-9958       | 3 Piece Set                     |
| 24-9959       | 5 Piece Set                     |
| 31-0404       | Rear Panel Mount Brackets, pair |
| 37-0571       | Complete Fork Cover Mount Kit   |
| 9981-8        | Chrome Screw Kit only           |



24-0838



24-1039

**1986-up FLST Complete Chrome Cover Kit** includes front panel, left and right panel, upper slider covers and side trim strips.

- |               |                      |
|---------------|----------------------|
| <b>VT No.</b> | <b>Item</b>          |
| 24-0838       | Kit                  |
| 24-1266       | Cover Set Only       |
| 24-1039       | Black                |
| 24-7944       | Black, 2010-up FLSTF |

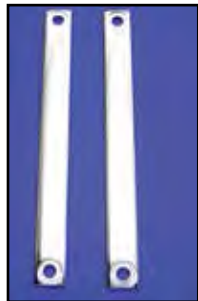

**Side Strips** fits 1986-up FLST.

- |               |               |
|---------------|---------------|
| <b>VT No.</b> | <b>Finish</b> |
| 24-9911       | Chrome        |
| 24-1362       | Black         |



24-9047



24-9050

**FLST Smooth Chrome Fork Cover Kit.** Three piece kit includes front panel and matching left and right panels. Fits all 2000-up FLST models.

- |               |               |
|---------------|---------------|
| <b>VT No.</b> | <b>Finish</b> |
| 24-9047       | Chrome        |
| 24-9050       | Black         |



24-9960



24-9986



24-1752



24-0386

**Slider Covers** fit 1986-up FLST model forks. Stock length is 6<sup>5</sup>/<sub>8</sub>" overall.

- |               |               |              |
|---------------|---------------|--------------|
| <b>VT No.</b> | <b>Finish</b> | <b>Style</b> |
| 24-9960       | Chrome        | Smooth       |
| 24-9986       | Stainless     | Smooth       |
| 24-1752       | Black         | Smooth       |
| 24-0386       | Chrome        | Flame        |



# 7" Headlamp for FLST



**1986-99 FLST Type Chrome Headlamp Assembly.**  
7" Lamp features fork type yoke mounting to fit lower triple tree, replaces 67789-91. Includes sealed 12V beam installed. Order mount block separately.

VT No.	Type
33-2122	Bulb
33-2197	H-4
33-2196	H-4 Visor
33-2255	Black
33-3050	Black
31-3981	Mount Block 67768-86
33-2135	Chrome Rim, Outer
33-0505	Rim, Inner



**Replica FLST Headlamp Assembly** includes deco visor and H-4 unit installed.  
**VT No. 33-2196**

**FLST Chrome Cowl Assembly Kit** fits 1986-up FLST-FLSTF.

VT No.	Item
33-0279	Cowl Kit w/Lamp and Riser Cover
33-1820	Cowl Kit Complete, Black
33-0092	Cowl, Chrome
33-0093	Cowl, Black
33-0430*	Hardware Only
24-0648	Riser Cover

**\*Note:** Required when installing Spotlamps and Windshields.



**FLST Frenched Headlamp Trim Ring** for 1994-up models.  
**VT No. 33-0548**



Lamps listed are for show or decorative use only, not D.O.T. approved.



**Chrome 7" Frenched Outer Headlamp Trim Rim** offers recessed look of the 1950's. Fits 1983-2013 FLT, 1994-2013 FLHR, 1986-up FLST with headlamp nacelle.  
**VT No. 33-0547**



**Headlamp Visor Ornament** fits 7" headlamp visors. Must be affixed with adhesive tape.

VT No.	Type
33-1936	Skull
33-1020	Bat





# 4.5" Headlamp



33-4071



33-4072



33-4073

## 4.5" Round Headlamp.

VT No.	Type
33-4071	Chrome
33-4072	Black
33-4073	Copper
33-4074	Visor



33-4074



**4 1/2" Chrome Bullet Headlamps** feature 12 volt bulbs with steel trim ring with 35/35 T-19 bulb.

VT No.	Item
33-0596	Lamp Complete
33-1721	Dual, Steel
33-0012	Single, Steel
33-0287	35/25 Bulb



**4.5" Torpedo Lamp** features 35 watt bulb.

VT No. 33-0051



33-0659



33-0997



33-0660

**Chrome Billet Headlamp.** Available with visor or plain no visor type. Features seamless type construction and includes and halogen bulb. Headlamp is 4 1/2" in diameter.

VT No.	Visor
33-0659	Pointed
33-0997	Smooth
33-0660	Without

33-0997  
Installed



33-0960

**4.5 Cyclops Headlamp** is 8.5" long with 55/60 W H-4 bulb.

VT No. 33-0960



33-0925  
Installed



**4.5" Billet Projection Headlamp** include bracket and 75 watt H-1 bulb for bottom mounting.

VT No. 33-0925



33-0012



33-0054

**Custom Driving Lamp** is 4 1/2" diameter bottom mount and features 12 volt sealed dual beam indicator and stud mount. Sold each.

VT No. Type

33-0054	Headlamp Shell
33-0012	Complete Light with Bulb
33-0153	Bulb for Above



33-0923



33-0924

**3.5 Billet Headlamps** include 55/60 H-4 bulb.

VT No. Type

33-0923	Visor
33-0924	Plain



**4-1/2" LED Daylight Headlamp Unit** with horizontal D-shape lens and features a black finish.

VT No. 33-1102

# 4" Headlamp



33-0030



33-0030 Front

**Chrome Deco 4" Bottom Mount Headlamp** features a longer tapered shell fitted with a 12 volt H-4 60/55 watt bulb. Includes mount block and stud.

VT No.	Item
33-0030	Lamp, chrome
33-0077	Lamp, black



33-0079

**Chrome 4" Round Diamond Cut Style Headlamp.** Top it off in style and add a custom touch to your bike with this chrome 4" diamond cut halogen headlamp. Headlamp includes 12 volt 60/55 watt H-4 bulb and mount stud.

VT No. 33-0079



33-0030



33-1466

**4" Chrome Halogen Lamp** includes H-4 12 volt 60/55 watt bulb and mount stud.

VT No. Style

33-0030	No visor
33-1466	With visor



**4" Billet Headlamp** features bottom mounting with 60/55 watt H-4 bulb and 5 watt marker lamp.

VT No. 33-0102



32-0487

**Deutsch Headlamp Connector** use when installing custom lamps on 1996-up models.

VT No. 32-0487

Lamps listed are for show or decorative use only, not D.O.T. approved.



33-1014



33-1013



33-1015

# 5<sup>3</sup>/<sub>4</sub>" Teardrop Headlamp



33-2155



33-2178 Halogen H-4



33-2250



33-0085

**5<sup>3</sup>/<sub>4</sub>" LED Headlamps.** These universal tear drop lights are machined from billet and feature LED lighting installed.

VT No.	Finish
33-1013	Black
33-1014	Chrome
33-1015	Insert (LED)



**4<sup>1</sup>/<sub>2</sub>" Daymaker Projector LED Headlamp Unit** fits FXD and FLH models with dual headlamp. Headlamp includes black backplate and features two "D" shaped optical lenses. Replaces 67700145A.  
**VT No. 33-1029**

**Teardrop Headlamp** includes mount eye bolt. Complete with bulb. 12 volt.

VT No.	Type
33-2155*	Paughco
33-2178	Halogen H-4
33-2250	As Above Black
33-0200	Lamp Unit with glass lens for VT No. 33-2178
33-0085	Diamond Cut
33-0536	Lens Retainer Clip Set

\*Note: Does not include mounting eye bolt

## For FXSTS



33-2159



33-3052



33-2248



33-0541



33-0777



33-1173



31-0465

**FXSTS Style Lamp** fits 1996-99 FXSTS. Features lamp with chrome teardrop shape shell with updated mounting design. Note: use with bracket 31-0465 available separately.

Chrome	Black	Type	Item
33-2159	—	H-4	Complete Lamp fits 1993-99
33-3052	33-2248	H-4	1996-99
31-0465	—	Zinc	Bracket



31-3982



31-0465

### FXSTS Headlamp Brackets.

VT No.	Year
31-3982	1988-92
31-0465	1993-07



### 2.5" Lowered FXSTS



31-0465

**5<sup>3</sup>/<sub>4</sub>" Lowered Spring Fork Style Headlamp** is primarily designed for FXSTS models, but can be installed wherever 5<sup>3</sup>/<sub>4</sub>" yoke mount lamps are used. Mounts 2<sup>1</sup>/<sub>2</sub>" lower than typical bottom mount lamps. Order bracket separately. Includes H-4 bulb.

VT No.	Item	Style
33-0541	Lamp	Billet
33-0777	Lamp	Bates Chrome
33-1173	Lamp	Bates Black
31-0465	Bracket	

Tail lamps/Headlamps listed are for show or decorative use only, and not D.O.T. approved.





# Billet Headlamp

## Round Visor



33-0658

**5 3/4" Tear Drop Billet Headlamp** available with visor or without visor. Includes Halogen bulb and features seamless type construction.

**VT No. Type**  
**33-0658** With visor  
**33-0985** With visor  
**33-5051** Repl. Mount Block



33-1614



33-1615



33-1616



33-1617



**4 1/2" Protolyte** includes 55/60 W H-4 bulb with tri bar lens, mount included.  
**VT No. 33-5050**

Lamps listed are for show or decorative use only, and are not D.O.T. approved.

**5 3/4" Synapse Style Headlamp** features a outer ring lamp, which acts as a marker light, with a 60/55 watt H-4 bulb.

**Black Chrome Type**  
**33-1614 33-1616** LED  
**33-1615 33-1617** CCFL

A cold cathode fluorescent lamp (CCFL) is a lighting system that uses two phenomena: electron discharge and fluorescence. CCFLs are mainly used as light sources for backlights, because they are smaller and have longer lifetimes than ordinary fluorescent lamps.



33-0664



33-1205

**5 1/4" Billet Rocket Headlamp.** Features H-4 60/55 bulb and bottom mount.

**VT No. Watt**  
**33-0664** 60/55  
**33-1205** 100/55



31-4028

**Chrome Billet Half Moon Headlamp** features a 7 1/4" deep housing with a clear bottom lens. Includes H-4 bulb.

**VT No. Item**  
**33-0050** Lamp  
**31-4028** Bracket (Short)

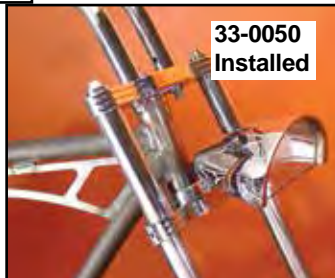

33-0050  
Installed



33-1541



33-1542



33-1543



33-1544

**Oval Style Headlamp.**  
**Chrome Black**

**33-1541 33-1542** 60/55 watt H-4 bulb and clear lens  
**33-1543 33-1544** 60/55 watt H-4 bulb and blue lens



**Axel's Billet Headlamp** features ovalistic design with 60/55 H-4 bulb installed.  
**VT No. 33-0647**



33-0786

**Bi-Focal Headlamp** includes mount and 55-55W H-3 bulb.  
**VT No. Lens**  
**33-0784** Clear  
**33-0786** Blue

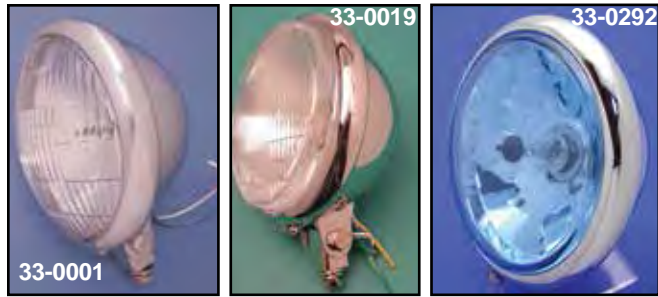

**5<sup>3</sup>/<sub>4</sub>" Bates Style Headlamp Assembly** includes indicator bulb and mounting eye bolt and beam assembled. 60/55W H-4 installed

\*Note: Hi-Beam does not have indicator lamp.

**VT No. Type**

**Chrome**

- 33-0001 Wagner (12 volt)
- 33-0002 Wagner (6 volt)
- 33-2058 Faceted
- 33-0019\* Bates Replica
- 33-1197 Clear Dome
- 33-0292\* Blue Faceted
- 33-0293\* Clear Faceted
- 33-1172 Clear Faceted
- 33-0958 Reverse Cup
- 33-0229 Shell only
- 33-0003 Complete with Sealed Beam

**Components**

- 33-0520 Rim only, chrome
- 33-0518 Mounting Eye Bolt, chrome
- 37-8457 Rim Screw (10 pack)

\*Note: Hi-Beam does not have indicator lamp.



42-0201 Visor Installed on Bates Headlamp



33-1321



33-1321

**5<sup>3</sup>/<sub>4</sub>" Headlights** are H-4 designed.

**VT No. Finish**

- 33-0078 Black with brass rim
- 33-1321 Chrome Stretched, H-4 bulb

# 5<sup>3</sup>/<sub>4</sub>" Headlamp

## Original Bates Style!



**Black 5<sup>3</sup>/<sub>4</sub>" Bates Style Headlamp Assembly.**

- 33-3042 Black Headlamp
- 33-0078 Black Faceted Headlamp with copper rim
- 33-1297 Black Faceted Headlamp



48-1325



**5<sup>3</sup>/<sub>4</sub>" Headlamps Diamond Cut with H-4 bulb installed.**

- | VT No.  | Item              |
|---------|-------------------|
| 33-4075 | Chrome            |
| 33-4076 | Black             |
| 33-4078 | Chrome with Visor |



**Teardrop 5<sup>3</sup>/<sub>4</sub>" Headlamp** features tear drop design with milled grooves. Includes H-4 12V 60/55 watt bulb.  
**VT No. 33-0606**



**5<sup>3</sup>/<sub>4</sub>" H-4 Headlamp** features domed glass and built in visor.  
**VT No. 33-2038**

Lamps listed are for show or decorative use only, and not D.O.T. approved.

MULTI FIT/CHOPPER





# Headlamp



33-0628

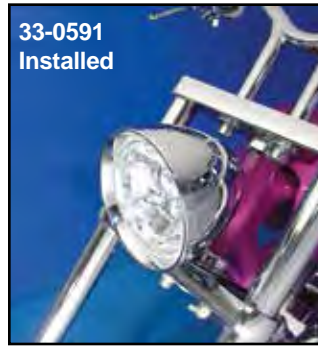

33-0591  
Installed



33-0928



33-0591



33-0591



31-0642



31-0796

5 1/4" Billet Headlamps include H-4 60/55 bulb with trim ring.

VT No.	Style	Type
33-0628	Rocket	Billet
33-0928	Bullet	Billet
33-0591	Bullet	Steel
31-0642	Bracket (33-0585), (33-0681)	
31-0796	Bracket (Extended)	



33-0981



33-0982

**Wyatt's Glow Style Headlamp Assembly.** 33-0981 includes 5 watt parking bulb.

VT No.	Type	Bulb
33-0981	5 3/4" Round	H-4 60/55
33-0982	7" Rectangular	H-3 55W

# Headlamp for Sportster

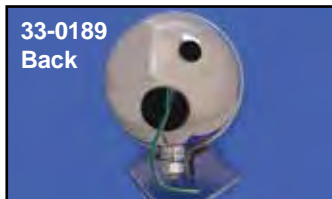

33-0189  
Back



33-0196  
Back

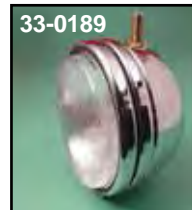

33-0189



33-0197  
Back



33-1418



33-0232



33-0231



33-0230

33-0231  
Back



5 3/4" Stock Headlamp fits FX-FXE-FXD-XL-includes 12 volt sealed beam, late type replaces 67705-74, has rectangular hole in shell for wiring, early type has two connections on back of shell. Order rubber insert 28-2004 for the late type separately.

VT No.	Finish	Year
33-0232	Chrome	1971-73
33-0233	Black	1954-73
33-0231	Chrome	1974-84
33-0230	Black	1974-84
28-2004	Rubber Boot	1974-83
28-0223	Rubber Ring	1954-83
33-0522	Chrome, Outer Rim Set	1963-up XL



28-0223

\*Note: Features halogen bulb and 2 holes in shell for wiring.

**Stock Chrome Replacement Headlamp** with H-4 unit.

Chrome	Black	Year	Fits
33-0189		1995-2003	XL
33-0196	33-1418	1974-84	XL-FX
33-0197	33-1419	1954-73	XL-FX



33-1419



5 3/4" LED daylight headlamp unit with black shaded reflector and daytime running light LED ring. Fits 1985-up.  
VT No. 33-1043

Tail lamps/Headlamps listed are for show or decorative use only, and not D.O.T. approved.



# Headlamp Visor



**Chrome Die Cast Headlamp Bracket** for FX Narrow Glide models.

VT No.	OEM	Years	Type
42-0422	Plain		Without Light Holes
42-0423	67807-73	1971-73	Two Large Holes
42-0424	67809-75	1975-8	Two 1/2" Holes
42-0069	67805-86	1986-91	4-Light
42-0838	67805-92	1992-up	With Slot



**Headlamp Bracket Extender** fits 1971-up FX-XL-FXD.  
VT No. 31-0143

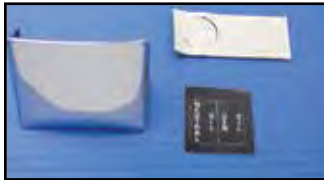

**Chrome Sunvisor** shields the LED's on the headlamp mounting bracket from the sun.  
VT No. 42-0321



**Chrome Headlamp Mount Kit** includes nut, tapered spacer, lockwasher and chrome cap plug.

VT No.	Year
37-8855	1954-88
37-9006	1989-up



**Chrome Headlamp Visor Plug** fits die cast headlamp mounting visor center hole.

VT No.	Years
28-1500	1954-88
37-0538	1989-up



**Chrome Headlamp Visor Mount Bolts** for use on all XL-FX-FXR 1959-up.

VT No.	Type
8717-4	Acorn
9783-4	Allen



**Chrome Headlamp Visor Cover** fits over existing head light visor on 1971-up FX models. Available with or without cutaway for oil and generator lights.

VT No.	Cutout
42-0306	With
42-0307	Without

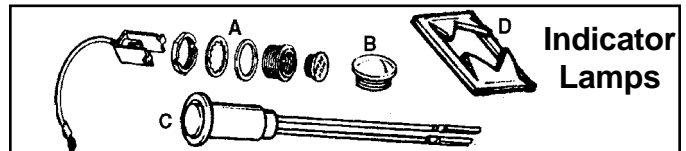

**Indicator Lamps**



**Indicator Lamps** fit visors and dash for high beam, neutral and generator.

VT No.	OEM	Color	Type	Fits
33-1961	67891-68	Red	HiBeam	A-1972-74 FX
33-2172	67899-68A	Red	HiBeam	B-Fits Above
33-1962	68536-72	Red	Generator	A-1972-74 FX
39-0122	67891-75B	Blue	HiBeam	A-1977-up FX
33-1956	67851-75	Green	Neutral	C-1975-83 FX
33-1957	68536-75	Red	Oil Pressure	C-1975-83 FX
33-2022	68489-86	Red	Oil Pressure	C-1986-up FXR
33-2023	68574-86	Green	Neutral	C-1986-up FXR
33-2024	68023-92	Blue	HiBeam	C-1986-up FXR
33-2026	68002-92A	Red		1986-up FXR
33-2025	68695-91	Green	Turn Sig	C-1991-up FXR
12-0553	7614		Speed Nut 1/2	D-1975-83





# Frenched Headlamp Rims

33-0545



33-0607



Chrome "Frenched" Headlamp Rims offers with recessed look of the 1950's. Also available with built in visor.

VT No.	Type	Fits
33-0547	Frenched	1986-up FLST with Headlamp Nacelle
33-0812	Frenched with visor	1994-up FLHR
33-1424	Black	2014-up FLHT, FLHX
33-0548	Frenched	1994-up FLST
33-0813	Frenched with visor	As Above
33-0545	Frenched	1994-up FXST, FXD
33-0607	Frenched	1971-up FXE, 1982-up FXR
33-1476	7" Chrome Burst Headlamp Trim Ring	
33-1477	7" Black Anodize Burst Headlamp Trim Ring	
33-1478	7" Chrome Burst Headlamp Trim Ring	
33-1479	7" Black Anodize Burst Headlamp Trim Ring	

## Caddy™ Headlamp



**Tri Angle Headlamp** includes lower mount and 12v 35/35w H-6 bulb. Sold each.

VT No.	Beam
33-1122	2
33-4077	1



**Dual Headlamp** measures 9" x 5" x 4" deep. Unit includes twin bulb at 60/55 watt, each.  
VT No. 33-1134



**Chrome Caddy Type Rectangular 12V Beam Headlamp** has bottom or side mounting, measures 4½" x 7½" outside. Includes sealed beam bulb and highbeam indicator light on bulb type lamps.

VT No.	Item
33-1323	Bottom Mount
33-1211	Side Mount
33-1212	Replacement Bulb

### Warranty

All Lighting (Headlamps, Tail lamps, Signals, Spotlight, Marker) sold as individual pieces or in kits are covered under our warranty "Replacement Only" Provision. All item part numbers begin with a 33 prefix. No credit will be issued for these items as they are exchange only.



# 7" Chrome Steel Headlamps

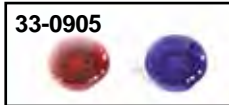

**7" Deco Headlamp** features H-4 bulb with visor. Fits universal bottom mount applications, FLH, not FLST.

VT No.	Item	Type
33-0042	Assembly	Custom
42-0209	Visor Only	



**7" Vintage Headlamps** fit Wideglide forks, 12 Volt.

VT No.	Type/Note
33-0020	Bulb
33-0945	H-4 includes parking lamp with Blue Hi-Beam Indicator
33-0603	Bulb, 12 Volt
33-0905	Indicator Lens Set
33-1345	H-4



**7" Sealed Beam Headlamp** includes 12V seal beam unit and high beam indicator with stud type mount as early spring fork style.  
VT No. 33-2156



# 7" Billet Headlamp



**7" Billet Bullet Tri Bar Headlamps** include H-4 60/55 bulbs.  
VT No. 33-1053



**7" Headlamps** include a sealed beam. Order mount brackets separately.

VT No.	Fits
33-0037	1949-59 FLH, 6V
33-0023	1949-59 FL, 6V Replica, Guide
33-0067	1949-59 FL, 6V Replica, Black

**7" Guide Cycle Beam Headlamp Beam Bulbs** are reproduced under the Guide license agreement, molded as original 60/55 watt.

33-1030	6 Volt
33-1032	12 Volt

Tail lamps/Headlamps listed are for show or decorative use only, and not D.O.T. approved.





# Spring Fork Lamp

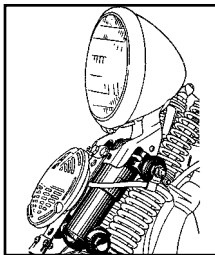

**Complete Spring Fork Headlamp** includes lens, glass reflector assembled with bulb.

VT No.	OEM	Item	Finish
49-0920	67701-35	Assembly	Chrome
33-2176	6Volt	H-4 Halogen Complete	Chrome
33-1925	12 Volt	H-4 Assembly	Chrome
49-0921	67701-35	Assembly	Black

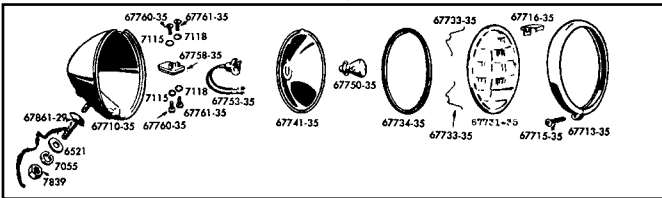

### Parts Available Separately

49-0922	67713-35	Rim
13-0231	67733-35	Lens Springs
49-0923	67731-35	Glass Lens
15-0320	67734-35	Lens Gasket
49-0924	67741-35	Reflector
49-2538	67753-35	Light Socket
49-0355	67758-35	Terminal Block
33-1218	—	6 Volt H-4 Bulb
33-0141	—	12 Volt Bulb
33-1823	10 pack	12 Volt Bulb
33-0140	67750-35	6 Volt Bulb
33-1448	5 pack	6 Volt Bulb
33-0154	67750-35	6 Volt Bulb, Replica
8943-27	67861-29	Bolt and Hardware Kit
49-0760	—	Nut and Washer
49-1648	VT	Nut and Washer
33-1293	—	Reflector 6 1/2"

### Replacement Glass Lenses.

VT No.	OEM	Type
49-2511	67731-35	Cycle Ray
49-0672	Red	Cycle Ray

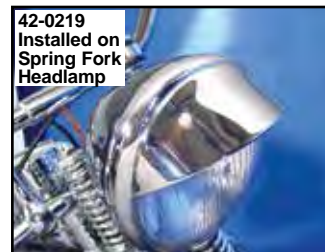
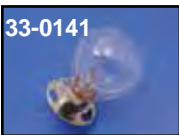
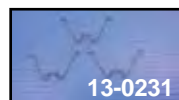

### Visor (VT No. 42-0219) Shown Spring Fork Headlamp Mount Bracket.

VT No.	Finish	Years
49-0098	Black	1936-44
49-0047	Black	1936-44
49-0021	Chrome	1936-44
49-0103	Black	1945-57
49-0048	Black	1945-57
49-0020	Chrome	1945-57
49-0012	Raw	1945-57
31-1298	—	1936-57
31-0935	Parkerized	1936-57

### Bolt Kits.

VT No.	Colony	Item	Finish
37-0527	2776-9	Bolt Kit	Chrome
	2777-9	Bolt Kit	Cadmium



**Headlamp Socket Kit** includes wire, reflector and socket.

**VT No. 49-0286**



**H-4 Conversion** fits Spring Fork headlamp.

**VT No. Item**

33-2098	12 volt Kit
33-1218	6 volt H-4 55-60 watt bulb only
33-0942	Reflector fits 33-2098 & 33-2029 only
33-0181	12 volt H-4 bulb only
33-2040	H-4 Clip

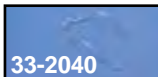

**Headlamp Restoration and Mounting Kit** features cadmium plated hardware to restore bucket and mount headlamp on Big Twin and 45 Spring Forks 1935-52.

**VT No. 8943-27**

**Replica Reflector Kit** includes reflector, socket, gasket, glass lens, and 12 volt T-19 bulb.

**VT No. 49-0906**



**Headlamp and Horn Bracket Insulator Terminal Kit with Fender Lamp Wires** for Headlamp bracket to fender light on 1945-48 Big Twins and 1945-57 Servi-Car.

**VT No. 2096-14**



**Springer Lens Kit** includes lens, springs, gasket, reflector, bulb socket, and nut/washer for mount stud.

**VT No. 49-1741**

Tail lamps/Headlamps listed are for show or decorative use only, not D.O.T. approved.

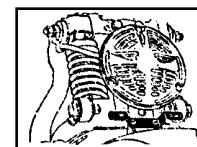

**Front License Plate Holder** replaces 91586-49. Fits spring forks equipped with stock horn and bracket. Parkerized finish.

**VT No. 49-2570**



# Headlamp

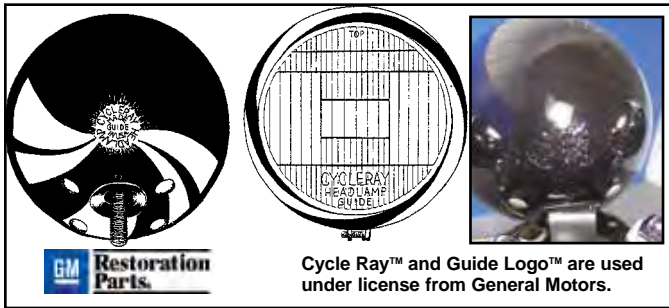

Cycle Ray™ and Guide Logo™ are used under license from General Motors.

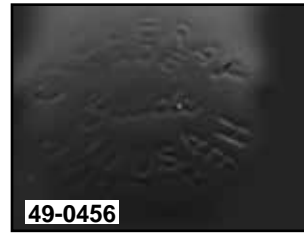

49-0456



Features Script Guide Logo!

**Black Headlamp** with Cycle Ray lens and visor.  
VT No. 49-1254



49-0312



48-1478



33-1539



33-1540



49-0312



49-2511

**7" Diamond Cut Headlamp Assembly** with a universal mount to fit all models.

VT No. Finish  
33-1539 Chrome  
33-1540 Black

**Cycle Ray Headlamp** is an authentic replica with Guide and Cycle Ray Logos on lamp housing, also included are a chrome rim, reflector and factory style riveting, 6 volt.

VT No. Item

- 49-0456 Lamp Black Complete
- 49-0312 Lamp Chrome Complete
- 49-1781 Lamp Black Complete
- 49-2511 Lens Only
- 48-1478 Cloth Patch, pair

**Chrome Springer Headlamp** to fit OE springer mount brackets.

VT No. Item

- 33-2176 6 Volt
- 33-1925 12 Volt



31-1298

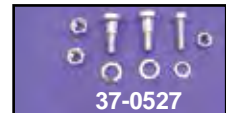

37-0527



33-2176



42-0219 Installed on Spring Fork Headlamp



37-0525

Visor (VT No. 42-0219) Shown

**Stud Mount Headlamp Bracket** for custom application.

VT No.	Finish	Years
31-1298		1936-57
31-0935	Parkerized	1936-57

VT No.	Colony	Item	Finish
37-0527	2776-9	Bolt Kit	Chrome
	2777-9	Bolt Kit	Cadmium



33-2029



33-2253



33-2253

**6½" Headlamp Assembly**

Chrome Black Item

- 33-2029 33-2253 Assembly
- 33-0942 Replacement Reflector



33-0963



33-0962



33-0962

**6" Steel Chrome Headlamps** include H-4 unit.

VT No. Visor

- 33-0963 With
- 33-0962 Without

# 6"





# 7" Lamp Unit



**Diamond Cut Lamp Unit** feature H-4 bulb and white LED ring. VT No. 33-0948



**7" Faceted H-4 Lamp Unit** features 60/55 bulb with parking lamp. VT No. 33-0206



33-3071



33-3072

Round Sealed Beams are replacement type.

VT No.	10 Pack	Volt	Watt	Brand
33-2009*	—	12 Volt	60/55	Wagner
33-3071	33-1425	6 Volt		Beck
33-3072	33-1426	12 Volt		Beck
33-1030	—	6 Volt		Cycle Beam
33-1032	—	12 Volt		Cycle Beam
33-1295		6 Volt		Guide Bulb

\*Note: Halogen Type Sealed Beam



**7" H-4 Headlamp Unit** with black housing to fit cowl assembly. Chrome rim not included. VT No. 33-3041



**Halogen Headlamps Units** by Candle Power for FLH-FLT and fairing models. H-4 bulb included and available separately. VT No. 33-0110



**7" Chrome Bullet Style Headlamp Trim** is held in place by existing headlamp bulb & rim. VT No. 33-0174

Caution: Do not touch any Halogen bulb glass with bare hands during installation or replacement. The manufacturer advises that the light unit is not washed with a water hose as the unit is not a sealed beam unit.

Lamps listed are for show or decorative use only, and not D.O.T. approved.



**7" Glide Chrome Deco Headlamp Visor** fits lamps in chrome shells or in cowls. VT No. 42-0209



33-1008

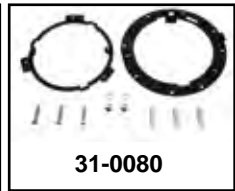

31-0080



33-1415



33-1416



33-1044



33-1783



33-1428

### LED Units

33-1008	White
33-1019	Black
33-1415	Black
33-1416	Black with signal
33-1044	Clear
31-0080	Bracket
33-1783	White
<b>Touring</b>	
33-1104	1994-13
33-1106	2014-up
33-1428	Light Spinner LED Controller



33-0850



33-0201



33-0888



33-1557

**7" Tri-Bar Halogen Lamp Units** feature early styling and H-4, 55-60 watt replaceable bulb included. Both fit stock or custom headlamp shells. Shell is not included.

VT No.	Type	Bulb
N/A	Tri-Bar	33-2168
33-0850	Blue Dot	33-2170
33-0201	Flat	33-2170
33-0888	Center Cup	33-2170
33-1557	Flat	33-2170
33-3041	Flat	33-2170
33-4080	Amber	33-2170
33-4081	Black	



33-4080



33-4081



**Visors 42-0200 and 42-0202 installed**



**42-9925 Signal Lamp**

**Chrome Lamp Visors** are easy-to-install.

VT No.	Type
42-0200	7" FLH Headlamp
42-9925	1963-85 FL Signal
42-9942	Signal 1986-up FL



# 5<sup>3</sup>/<sub>4</sub>" Lamp Unit



**Diamond Cut Reflector Lamp Units** include 12 volt H-4 60-55 watt bulb.

VT No.	Type
33-0881	Tri-Cut
33-0203	Reverse Cup/Diamond Cut
33-0755	Faceted



33-1065, 33-1064

**Round Sealed Beams** are replacement type.

Each	Volt	Watt	Brand
33-1065	12 volt	50/35	Beck
33-1097	12 volt	50/35	Beck
33-0121	12 volt		Wagner
33-1064	6 volt	40/30	Beck



**Rainbow H-4 Insert** allows lamp to radiate soft colorful light.

VT No.	Item
33-0112	Pair
33-0144	Each



**H-4 Replacement Bulbs.**

VT No.	Watt	Volt
33-0181	55-60	12
33-1217	55-100	12
33-1218	55-60	6V
33-1191	LED	Clear Daylight Bulb 6000k
33-1782	LED	Clear
33-1439	H11	68881-01



**5<sup>3</sup>/<sub>4</sub>" Chrome Bullet Style Headlamp Trim** is held in place by existing headlamp bulb and rim.  
VT No. 33-0173



**LED Units.**

33-0834	Bates H-4 Insert
33-1015	Complete Kit
33-1040	Complete
33-1043	5 <sup>3</sup> / <sub>4</sub> " Headlamp Unit
33-1029	OE Type



**H-4 Lamp Unit** features glass lens 55/60 W bulb included.

VT No.	Lens
33-0200	Flat
33-0340	Round
33-0100	Round by Candle Power
33-0894	Tri Bar with H-4 Bulb
33-0472	Rubber Boot Only



**H-4 Xenon Blue Bulb** is for superior night visibility. In the construction of the Xenon Blue Bulb, the Xenon gas is used to cool the filament and allow the halogen process to produce a higher light output. The special blue coating increases the whiteness of the light with only a trace of blue at the headlamp periphery. Unit fits all H-4 applications.

VT No.	Type
33-1234	60/55
33-1235	100/55
33-1238	100/90
33-1242	130/90
33-1191	Cyron



**ABS Bucket Headlamp** fits 2001-up V-Rod.  
VT No. Finish  
33-1306 Black  
33-1307 Chrome  
33-1407 Black ABS 2002-2015 except VRSCD/X/F

Lamps listed are for show or decorative use only, not D.O.T. approved.





# Headamp Bracket and Mount Block

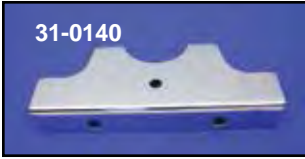

**Chrome FXWG-FXST Headlamp Bracket** mounts bottom mount headlamps on fork, also covers rough casting on lower tree.

VT No.	Years
31-0140	1980-up
31-9991*	1986-93

**\*Note:** Does not have holes for front mounting. Mounts by headlamp eye bolt only and acts as tree cover.

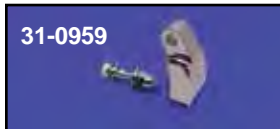

**Billet Headlamp Mounts** adapt to stock forks. **Note:** Tall bracket can be reversed for some applications.

VT No.	OEM	Fits	Type
31-0958	68595-06	FXDWG-FXST	Short
31-0959	69611-06	06-up FXD-FXWG	Tall



**Extended Billet Headlamp Mount** fits FXST models and allows lower lamp position. For use with custom lamps with narrow spacing.  
**VT No. 31-0944**



**Headlamp Mount Eye** is 5/8" square top with 3/8" mount bolt provision.  
**VT No. 33-0518**

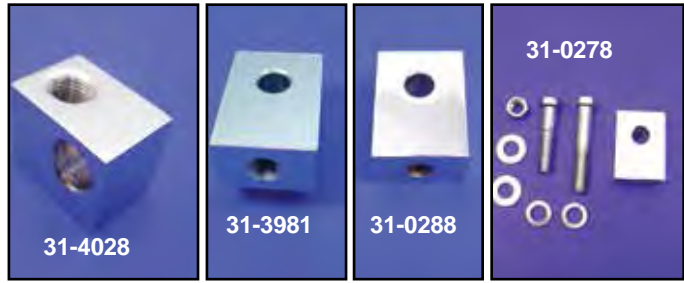

**Headlamp Mount Blocks** for use on 1980-up FXST- FXWG- FXSTS models. All are chrome except as noted.

VT No.	Year/Model
31-4028	1980-up FXWG-FXST
31-3981	1986-96 FLST, Zinc
31-0288	1986-96 FLST
31-0278	1997-up FLST
31-3982	1988-92 FXSTS
31-0465	1993-up FXSTS, Zinc
31-0656	2000-up FXSTD
31-0576	1987-up XL-FXD
31-0793	1988-up XL FXD
31-0794	Softtail Glides
31-0852	2006-up XLH Custom

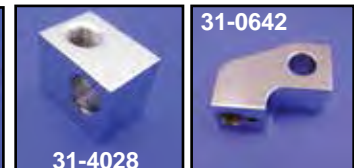

**Billet Headlamp Brackets.**

VT No.	Fits
31-0642	33-0681
31-4028	33-0050
31-0796	33-0585, 33-0681



**Billet Headlamp Mount** fits 1987-up FXST, FXDWG models 1987-up.  
**VT No. 31-0719**

# Headlamp Connector



**Deutsch Headlamp Connector** use when installing custom lamps on 1996-up models.  
**VT No. 32-0487**



**Headlamp Connector** with 3 wires for Hi-Low beam headlamp.  
**VT No. OEM Year**  
32-0676 67753-48 1948-59  
32-8037\* 72047-71 1960-84  
**\*Note:** Features cloth cover loiring.



**Chrome Headlamp Brackets** by Paughco feature indent on rear side of eye bolt mount stud hole.

- | VT No.  | Fits                        |
|---------|-----------------------------|
| 31-0521 | Late FX mount hole, 5" c/c  |
| 31-0523 | FXWG-ST, 4" c/c             |
| 31-0522 | Wide Glide, 2½" c/c         |
| 31-0586 | Paughco Spring Fork, single |



**Chrome Headlamp Bracket Adapter Strap** allows use of 7" type brackets on 1952-86 FX-XL models.  
VT No. 31-0330



**Headlamp Brackets** for Spring Forks as custom application.  
VT No. Type  
31-0146 Single  
31-0545 Dual



**1948-59 Headlamp Bracket** features large mount holes for isolation mounting exact for these years, zinc plated. Replaces 67810-48A, order mount kit separately.

- | VT No.  | Item                    |
|---------|-------------------------|
| 31-0432 | Mount Bracket           |
| 2108-12 | Mount Kit with Bushings |
| 2006-3  | Lamp Nut                |



**Clamp-On Side Mount Headlamp Brackets** are chrome plated for any side mount style headlamp, custom or stock.  
VT No. 31-0147



- | VT No.  | Item                         |
|---------|------------------------------|
| 31-0028 | Spotlamp Bracket, Cadmium    |
| 31-1276 | Guide Stanchion Set, Cadmium |

# Headamp Bracket

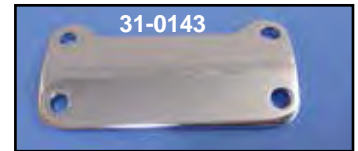

## Chrome Headlamp Brackets

- | VT No.  | Type       | Model             |
|---------|------------|-------------------|
| 31-0141 | 2½" c/c    | 1948-up FLH       |
| 31-0263 | 4" c/c     | 1980-up FXWG-FXST |
| 31-4032 | Conversion | 1971-84 FX        |
| 31-0142 | 67810-48   | 1949-59 stock FLH |
| 31-0143 | Extender   | 1971-84 FX        |
| 31-0139 | 4¾" c/c    | 1952-86 FX        |

VT No. 31-4032 allows use of 31-0142 bracket on FX triple tree to fit 7" lamp.

VT No. 31-0143 is for headlamp adjustment angle on models with extended forks.

VT No. 31-0142 fits under FLH tin covers on 1948-up FLH



**Chrome Bottom Mount Headlamp Bracket** fits 1957-86, 35mm and 33mm forks.  
VT No. 31-4192



**Chrome Side Mount Headlamp Bracket** is one piece to fit Bates style lights.  
VT No. 31-0603



**Side Mount Headlamp Bracket Set** clamps on to 39 and 41 mm fork tubes.  
VT No. Item  
31-1351 Black  
31-1353 Chrome

- | VT No.  | Item                    |
|---------|-------------------------|
| 31-0670 | Chrome Taillamp Bracket |

# HID Lighting

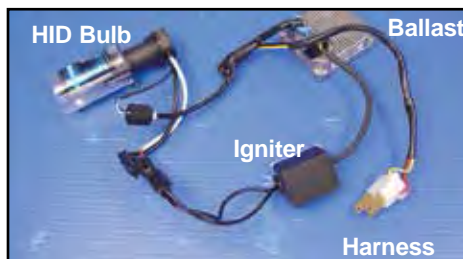

**HID (High Intensity Discharge) Unit** fits 7" alloy cowl assemblies of FL and FLST models. Kit includes bulb and socket. VT No. 33-0986



**HID (High Intensity Discharge) Lamp Insert** includes bulb.  
VT No. Item  
33-1055 Kit  
33-1060 Bulb Only





# Spotlamp Kit



**Police Pursuit Lamp Kits** include chrome brackets with mount hardware, two spotlamps with red, blue or clear seal beams, 12 volt.

VT No.	Item	Color	Year
33-2087	Kit	Clear	1964-84
33-1993		Red	1964-84
33-1033	Kit	Includes brackets	1964-84
33-1552	Kit	Includes brackets	1949-63



**4 1/2" Spotlamp Set** features sealed clear 12 Volt beams and chrome visors.

VT No.	Item
33-0017	Spotlamp Set with Visor
42-0202	Visor Set

**V-Twin Mfg.™ Spotlamp Kits** include chrome mounting bracket, two spotlamps with genuine Wagner single filament clear seal beams and the necessary hardware to mount lamps to bracket and assembly to fork. Kits 33-2032 include on/off switch with leads which clamps on handlebar.

VT No.	Note	Year	Model	Fork
33-2031	E and F	1980-up	FXWG-FXST	Glide
33-2030	E and F	1986-up	FLST	Glide
33-2205	D and F	1986-up	FLST	Glide
33-2036	D and F	1986-93	FLHS	Glide
33-2037	D and F	1994-up	FLHR	Glide
33-2033	B,E	1948-64	FLH	Glide
33-2087	C and E	1948-67	FLH	Glide
33-2028	D and F	1949-84	FLH	Glide

**Notes:**

- A. Includes early spotlamps (VT No. 33-0022) with 6 volt bulbs and integral switches to fit Spring Fork models with shock.
- B. Includes two piece brackets and early spotlamps. (VT No. 33-0021) with 6 volt bulbs and integral switches.
- C. Includes two piece brackets which mount to right and left sides.
- D. Includes amber turn signal assembly.
- E. Turn signal not included.
- F. Features one piece chrome spotlamp bar.



**4" Spotlamp** features integral deep dish rim and H-3 bulb with diamond cut lens.

VT No. 33-0909



**Chrome Deco Spotlamp Visor** features a beaded edge. Sold in pairs.

VT No. 42-0208



**4 1/2" Chrome Bullet Style Spotlamp Trim Set** is held in place by existing headlamp bulb and rim.

VT No. 33-0172



# Spotlamp



**Spotlamp Trim Ring Set** allow installation of visors on 1987-up models, sold as pair.  
**VT No. Item**  
**33-0551** Rings  
**42-0202** Visors, pair



**33-0546**  
Installed



**Spotlamp Dress Ring** features a recessed "frenched" deep design. Also available with built in visor.

**VT No. Type**  
**33-0546** Frenched  
**33-0811** Frenched with visor



**33-0546** Installed



**4½" Chrome Bullet Style Spotlamp Trim Set** is held in place by existing headlamp bulb and rim.

**VT No. 33-0172**



**33-1245**



**33-1246**



**33-1436**



**33-1427**



**33-1438**

**Chrome Spotlamp** features H-3 bulb, 55 watt. Sold each.

**VT No. Type**  
**33-1245** Inset  
**33-1246** Visor  
**33-1436** Wide  
**33-1427** Narrow  
**33-1438** With Visor Speed Grooves



**33-0066**



**33-0073**



**33-1016**



**33-1732**

**12 Volt Spotlamp Assembly** with mount spacer and clear bulb. Sold as pair unless noted.

VT No.	Finish	Year	Model
<b>33-0066</b>		1986-up	FLST
<b>33-3051</b>	Black	1979-up	FLT
<b>33-0073</b>	Chrome	1979-up	FLT
<b>33-1016</b>		1979-up	FL
<b>33-1732</b>		1979-up	FL
<b>33-1597</b>			

Blue  
 4.5" LED each  
 4.5" LED set  
 LED Set



**33-0076**



**Starship Style Chrome Billet Driving Light** with bottom mount and a high beam. Available as single beam 55 watt H-3 spotlamp or a dual beam H-3 55 watt driving light.

**VT No. Item**  
**33-0076** Dual Beam Driving Light  
**33-0075** Single Beam Fog Light



**33-0075**

**4.5" Billet Spotlamp** feature 35/55 watt T-19 bulb, billet rim which screws on for positive seal.

**VT No. 33-0776**



**33-1184**



**33-1545**

**4.5" LED Spotlamp Assembly** is 12 volt, 55/60W, and features an H4 bulb. Fits 1960-up FL.

**VT No. U/M**  
**33-1184** Each  
**33-1545** Set





# Spotlamp Bracket

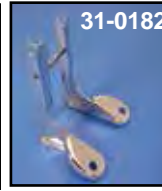
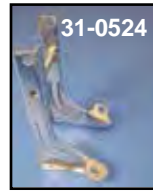
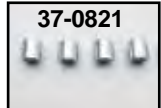
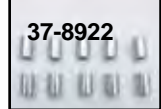
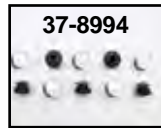

**Spotlamp Bracket Sets** include right and left sides for front fork triple tree mounting.

Chrome	Black	Fits
31-0524	31-1013	1949-59 FL
31-0182	31-1014	1949-84 FLH
37-8793		1949-84 FLH Mounting Hardware
31-0196		1971-84 FX
31-0197		1957-85 XL

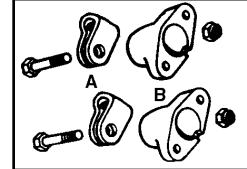

**FLH Turn Lamp Chrome Mounting Kit** for turn signal lights 1968 and later, has chrome base, clamp and mounting bolt. Replaces 68518-68. Necessary for mounting turn signal below Spotlamp unit

VT No.	#	Item
31-0180	A and B	Complete Kit
31-3974	A	Clamps only, pair
31-0266	B	Stantions only



**Tapered Washers** will allow alignment of spotlamp base to bracket.

VT No.	OEM	Use	U/M
37-8832	67815-59A	Headlamp, FX	5
37-8833*	68721-62	Spotlamp block	2
37-8903*	68720-62	Spotlamp clamp	5

\*Note: One of each used on BT Spotlamp 1962-up.



**Chrome Universal Spotlamp Mounting Bracket Set** clamps to 1" frame rail or engine bar. **VT No. 31-0185**

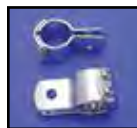

**Spotlamp Mount Clamp** will fit 1 1/4" tubing. **VT No. 27-0037**

**Chrome Spotlamp Mount Bracket** is one piece type. Use VT No. 33-0010 Spotlamp.

VT No.	Fits
31-0183	1949-84 FLH
37-8994	Hole Plugs for Above
31-0424	1949-84 FLH
31-4013	1986-01 FLST-FLSTF-FLSTN Does not fit FLSTS
31-1175	2002-up FLST-FLSTF
37-1424	Hardware for 31-1175
37-8922	Spacers for Above, 10 pack
31-9915*	1980-84 FXWG, 1984-up FXST
37-0821	Spacer for Above
31-0462	1988-96 FXSTS
31-0549	Clamps for 1997-up FLSTS
31-0550	Spacers for 1997-up FLSTS

\*Note: Includes brackets which mount to lower pinch bolts.



# Spotlamp



**H-3 Spotlamp Set** with 55 watt H-3 bulbs. Sold in a pair.

- | VT No.  | Item                         |
|---------|------------------------------|
| 33-0278 | Spotlamp Complete            |
| 33-0974 | Replacement Beam w/H-3, each |
| 33-1723 | H-3 Spotlamp Set             |



**33-0095**  
**Replica Guide Clear Spotlamp Set** includes 12 volt bulb.  
 VT No. 33-0095

## Guide



**4.5" Tri Bar Spotlamp** features diamond cut reflector reversion cup and blue dot. 55W H-3 bulb included.  
 VT No. Type  
 33-0863 Tri Bar  
 33-0318 Without

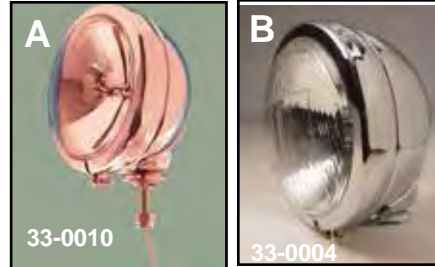

**Chrome 6" Rectangular Spotlamp** includes 55 watt single beam. Measures 6 1/2" L x 3 1/2" W x 3" Deep.  
 VT No. Item Volt  
 33-0906 Lamp 6  
 33-0564 6V Bulb  
 33-0565 12V Bulb

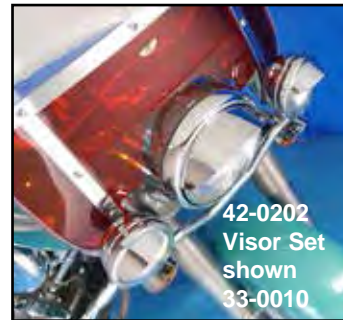

**Chrome FLH Spotlamp Assemblies** include mt spacer and choice of clear or fluted 4 1/2" Wagner bulb. Replaces 68652-68B.

- | VT No.  | # | Item                     |
|---------|---|--------------------------|
| 33-0010 | A | Lamp 12V, Clear          |
| 33-0066 | A | Lamp, Clear              |
| 33-0004 | B | Lamp 12 V, H-3, 55W      |
| 33-2015 | A | Lamp 6V, Clear           |
| 33-0071 |   | Lamp, 12V, Blue          |
| 33-0013 |   | Lamp Shell only          |
| 33-0903 |   | Lamp Shell               |
| 33-0521 |   | Rim Only 68725-62        |
| 37-8932 |   | Collar Mount Kit, 2 pair |
| 42-0202 |   | Visor Set                |



**4.5" Chrome Spotlamp** features single 55 watt H-3 lamp with bottom mount tear drop shell with embossed speed grooves.

- | VT No.  | Type                      |
|---------|---------------------------|
| 33-0045 | Clear                     |
| 33-0883 | Blue                      |
| 33-1300 | H-3                       |
| 33-1302 | Diamond Cut               |
| 33-1300 | Clear H-3                 |
| 33-1302 | Tri Bar H-8               |
| 33-0903 | Assembly 881 27 watt bulb |
| 33-1042 | Inner Ring                |
| 14-0341 | Seal Set                  |



**Chrome Ornament** fits visors, each.

- | VT No.  | Fits | Item  |
|---------|------|-------|
| 33-1932 | 4"   | Skull |
| 33-1936 | 7"   | Skul  |
| 33-1021 | 5"   | Bat   |
| 33-1020 | 7"   | Bat   |

Lamps Listed Are For Show Or Off Road Use and are not D.O.T. approved.

MULTI FIT/CHOPPER





# Spotlamp Bulbs



33-0160



33-0297



33-1087



33-0152

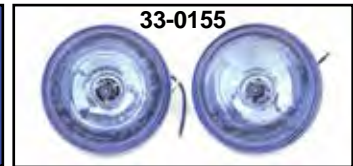

33-0155



33-0976



33-0125



33-0918

**Spotlamp Bulb** single filament seal beam type replaces 68726-64, on stock 4½" spotlamps 1964-up type.

VT No.	Volt	Type
33-1087	12V	Clear 60 watt, pair
33-0161	12V	Fluted 60 watt, pair
33-1088	12V	Clear 30 Watt set has a single filament
33-0298	12V	Blue 30 watt Single Filament Pursuit
33-0116	12V	Red 30 watt, Single Filament Pursuit
33-0297	12V	Amber 30 watt
33-0118	12V	Clear 37.5 watt, Halogen
33-0117	12V	Clear 50 watt, Halogen
33-0116	12V	Red Clear
33-0162*	12V	Dual Beam
33-0114	6V	Clear
33-0160	6V	Fluted Lens
33-0290	6V	Amber with Flute Lens
33-0152	12V	Clear H-3 Halogen Unit, pair
33-0974	12V	Clear H-3 Halogen Unit, each
33-0125	12V	H-3 Bulb 55 Watt (Tri-Bar)
33-0918	12V	H-3 Bulb 55 Watt (Set)
33-0907	6V	H-3 Bulb 35 Watt
33-1459		H-3 Bulb 27 Watt

\*Note: Fits 33-0011 lamp, all other bulbs fit VT No. 33-0010.



33-0127



33-3070

**Tri-Bar Halogen Unit** fits 4½" spotlamps.

VT No.	Item
33-0127	Lamp with blue dot, each
33-0125	H-3, each
33-3070	Lamp with blue dot, pair



**National Spotlamp Kit** make your motorcycle visible after dark with this kit. Kit is fully assembled and wired complete with turn signals and features a 35 watt halogen bulb to provide bright light

without overtaxing the electrical system. All light bars are designed to be compatible with any heavy duty or switchblade windshields. Use with 39mm forks. Fits 1988-up XL, 1988-1994 FXR, 1991-up FXD.

VT No. 33-2184



**Billet Spotlamp Trim Ring Set** features a black finish with milled high lites. Can be used for original style 4½" spotlamps. Fits 1962-up FL.

VT No. 33-1198



33-0907



33-1304



33-1190



33-0098



33-1144

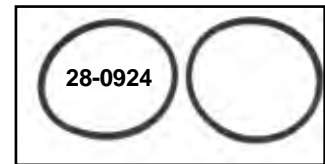

28-0924

**H-3 Halogen Spotlamp Set** by V-Twin includes (2) two 55W, 4½" bulbs for installation in stock type spotlamps shells.

Note: Colored lenses are for show use only.

VT No.	Type	Wire Connector. VT No. 32-1688
33-0152	Clear	
33-0155	Blue	
33-0976	Blue (Dark)	
33-0125	H-3 55 W Bulb, each	
33-0918	H-3 55 W Bulb Set	
33-0907	H-3 6V 35 W Bulb Set	
33-1304	881 12 Volt	
33-1190*	Cyron 881 LED 12 Volt	
33-0098**	881 12 Volt Kit	
33-1144	LED Set	
28-0924	Lens Gasket Set	
33-1183	LED Spotlamp Bulb	
33-1089	Spotlamp Bulb Set, Sealed Beam, Clear	
33-1184	4.5" LED Spotlamp Assembly	
33-1427	4.5" H-4 Spotlamp Assembly, Chrome	

\*Note: LED set bright white beam 6000K  
 \*\*Note: Includes harness that allows spotlamp to stay on when high beam is used.



33-1735

**Chrome 12 Volt Spotlamp** with mount spacer and amber running lamp. Fits 1964-1984 FL, 1979-up FLT, 1986-up FLST.

VT No. U/M

33-1282 Each

33-1735 Pair

Lamps Listed On This Page Are For Show Or Off Road Use and are not D.O.T. approved.



# Vintage Spotlamp



VT No. 33-0022 and 33-0021 are complete lamps



**1938-48 Replica Chrome Spotlamp Set** is a duplicate of the early Guide RH-5 model including factory markings, swivel and hardware. Order cross bar separately. Replica swivel set available separately.

VT No.	OEM	Item
33-0099	Kit	Spotlamp
33-1520	Set	Spotlamp Assembly, 6V
33-0038	11366-38	Spotlamp Assembly, 6V
33-0167	68694-38 (Kit)	Swivel Set with Hardware
33-1981	68715-49	6V Bulb
33-1437	10 pk	6V Bulb
33-1979	68668-38	Chrome Bezel
33-1222	68660-38	Clear Glass, Order lens gasket 15-0541
33-2002	68662-38	Red Glass
15-0541	68673-38	Lens Gasket
37-0858	—	Mount Bolt
15-0542	—	Clamp Rubber
2568-24	Rebuild	Kit

**Chrome Early Spotlamp** for 1938-57 Spring Fork and 1949-63 Big Twin Glide. Spotlamp is complete with clamps and toggle switch. Brackets are for mounting to ride control, or shock assembly on Spring Forks.

VT No.	OEM	Item	Type
33-1041	Set	Complete Lamp	6V, 35 w
33-0022	11366-38	Complete Lamp	6V, each
33-1613	Set	Complete Lamp	6V
33-0021	11366-38	Complete Lamp	12V, each
33-1610	Set	Complete Lamp	12V
33-0063	Amber	Complete Lamp	6V
33-0064	Amber	Complete Lamp	12V
33-1421	Red	Complete Lamp	12V
33-1422	Clear/Clear	Black Lamp	6V 35 w
33-1420	Clear/Red	Chrome Lamp	6V 35 w
31-0416	68702-38	Clamp Set	4 piece
33-0113	68692-38	Swivel only	
33-1222	68660-38	Lens only	Clear
33-2002	68668-38	Lens only	Red
33-0062	Pair	Lens only	Amber
33-1979	68668-38	Bezel	Chrome
33-1434	Bracket	Kit	Tall
49-0479	Bracket	Each	Tall



## Replica Spotlamp Parts.

VT No.	Item
32-0792	Switch Set
33-0167	Swivel Set

## Brackets



**Early Spotlamp Bulbs, single filament.**

VT No.	OEM	Type	Volts	U/M
33-0164	68715-20	1938-48	6	Pair
33-1981	68715-49	1949-64	6	Each
33-1980		1949-64	12	Each
33-1437	68715-49	1947-64	6	10 pk



VT No. 33-0022 Spotlamp shown with optional red lens 33-2002

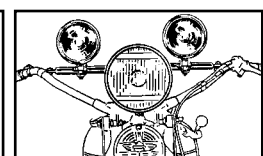
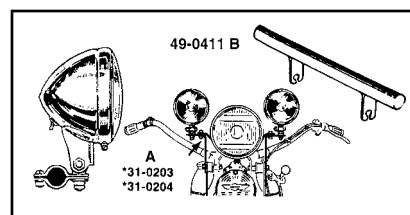

Spotlamps shown mounted on VT No. 49-0153 Cross Bar

### Spotlamp Brackets Only

31-0203	11369-38	Black bracket set, ride control
31-0204	As Above	Chrome bracket set, ride control
49-0411	68616-46	Cross bar, chrome for shock
33-2032	Kit	Kit with Cross Bar
49-0223	68620-46	Nuts for Above, Parkerized
2757-6	68620-46	Bolt and Nut Kit, Chrome
2758-6	68620-46	Bolt and Nut Kit, Cadmium
33-1404	Kit	6V
49-0380	Bar	Bar

Lamps listed on this page are for show or off road use and not D.O.T. approved.





# Tail Lamp



33-0990



33-0991

**Radii Style Tail Lamp Assemblies** feature LED installed.

VT No.	Year	Type	Includes
33-0990	1978-98	Complete	4" wires
33-0991	1999-up	Lens/LED Only	36" Wire, no OE plug



33-1523



33-1524

**LED Tail Lamp Assembly** features webbed design reflector and clear lens.

VT No.	Window
33-1523	Top
33-1524	Bottom
33-1600	FXSTD



33-1600



33-0940



33-0939

**LED Slimline Tail Lamps** fit 1989-2010

Smoke	Red	Clear Lens
33-0940	33-0939	33-1084



33-1531



33-1549

**LED Lamps** with chrome body

VT No.	Lens
33-1531	Red
33-1549	Smoke



31-0160



31-4012

**FXWG-FXST Tail Lamp Brackets** are chrome plated unless noted, tail lamp required for 1980-99.

VT No.	Type
31-0160	Stock
31-4012	Accepts Cateye or Diamond



33-2018



33-0543

**The Slice** is an assembly for all FXDWG-FXWG-FXST with Bobbed rear fenders. Can be adapted to other models equipped with bobbed style fenders. Fills the entire fender contour.

VT No.	Item	Year	Type
33-2018	FXST-FXWG Kit	1980-99	Bulb
33-0543	Lamp Only		Bulb
33-0623	Lamp Only		LED



**Chrome Adjustable Bobbed Tail Lamp Bracket** adjusts 7.5" to 9" wide to accept cateye or similar tail lamps. **VT No. 31-0097**



33-0301

31-0271

**Chrome License Plate Bracket Kit** includes stock style 3-hole bracket assembly, backing plate, frame and four krommets. Order tail lamp and blue dot lens separately. Fits 1973-up.

VT No.	Item
31-0271	Plate Kit
33-0301	Tail Lamp
33-0507	Blue Dot Lens



31-0160 Installed

Lamps Listed On This Page Are For Show Or Off Road Use and not D.O.T. approved.

**Warranty**  
LED Boards will be warranted only. No credit will be issued on any lamps or components with the 33 prefix. Lamps will either be exchanged or repaired and returned to the dealer.



**1980-99 Softail Snake Eye License Plate and Tail Bracket Kit.**

**VT No. Item**  
**33-0438 Kit**  
**33-0439 Tail Lamp Only**

# Tail Lamp and Bracket Kit for Bobbed Fender



33-0379

**Radii Chrome Oval Tail Lamp Assembly** features chrome bracket with billet oval tail lamp with LED red lamp and amber LED directional signals installed.

VT No.	Year	Model
33-0379	1980-99	WG-Softail
33-0390	2000-up	WG-Softail
33-0380	1993-99	FXDWG
33-0391	2000-up	FXDWG



**Maltese Lamp Kits** fit Softail models 1980-99. Units feature clear lens with red LED units and clear LEDs for license plate illumination.

VT No.	Item	Color
33-0104	Kit	Clear
33-0105	Lamp Only	Clear
33-0106	Lamp Only	Red



33-0891

**Slice Style Assembly** fits 1980-99 FXST-FXWG.

VT No.	Item	Type
33-0799	Assembly	LED
33-0891	Assembly	Bulb
31-4012	Bracket	



33-0833

**LED Conversion** fits 1999-up XL, FXD, FXST, 1996-07 FLT.

**VT No. Color**  
**33-0832 Red**  
**33-0833 Smoke**  
**33-0831 Clear**



33-0832



33-0831



33-2199



31-4012



31-3192

**Chrome Deco Tail Lamp Mount** is designed to accept Lucas style or Cateye tail lamp, with license plate. Cleanly mounts under fender. Lamp is included with kit.

VT No.	Item	Model
33-2199	Cateye Assembly Kit	1980-99 WG-Softail
33-0610	Cateye Assembly Kit	1993-99 FXDWG
31-4012	Bracket Only	1980-99 WG-ST
33-0584	Bracket Only	1993-99 FXDWG
31-3192	Bracket Only	2000-05 FXDWG
31-3194	Bracket Only	2006-up Softail
33-1017	Lamp Kit	2006-up
33-0306	Cateye Tail Lamp	
33-0302	Lucas Style Tail Lamp	



Back Side 33-0891 View

**LED Tail Lamp Kit** fits 1973-99 by removing stock tail lamp. Covers existing lamp cut out.  
**VT No. 33-0892**

Lamps listed on this page are for show or off road use and not D.O.T. approved.  
**Warranty**  
 LED Boards will be warranted only. No credit will be issued on any lamps or components with the 33 prefix. Lamps will either be exchanged or repaired and returned to the dealer.





# Tail Lamp

Lamps listed are for show or decorative use only, and not D.O.T. approved.



**Chrome Radium™ Tail Lamp Assembly** features full LED matrix with amber turn signal bulb built in. Lamp measures 6" long by 2½" wide at the center.  
**VT No. 33-0605**



**Thin Cateye Tail Lamp** is only ¾" thick with LED.  
**VT No. 33-0807**



33-0306



33-0028



33-1966



33-0286



33-1967



33-1996

**Chrome Cat Eye Tail Lamp** made of heavy die cast. Parts available separately.

VT No.	Item	Type
33-0306	Light	Complete
33-0028	Light	Complete, LED
33-1966	Red	Lens Plain
33-0286	Grill	Arrow
33-1967	Red	Lens with Blue Dot
33-1996	Clear	Top Lens
15-0665	Gasket, 5 pack	

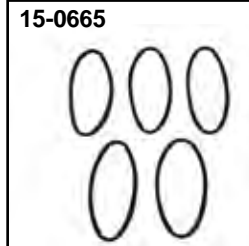

33-0886



33-0887

**Cyclops Tail Lamps.** Both have studs for mounting.

VT No.	Type	Mounting Studs
33-0886	LED	5½" C-C
33-0887	Bulb	4¾" C-C



**Red Slice Style Tail Lamp** with LED running and brake light and red lens. Features low profile design to mount to the edge of a chopped rear fender. Replaces 73420-11. **VT No. 33-1550**

### Warranty

LED Boards will be warranted only. No credit will be issued on any lamps or components with the 33 prefix. Lamps will either be exchanged or repaired and returned to the dealer.



**Chrome Billet Oval Tail Lamp** features LED array with clear window. 12 volt.

VT No.	Item
33-0443	Tail Lamp
33-0655	LED Array Only



33-0680

**Cateye Tail Lamp** features smooth red lens with LED board installed. Chrome body has stepped design for updated look.

**VT No. 33-0680**  
**Clear Lens Type.**  
**VT No. 33-0919**



33-0919



33-0749



33-0750

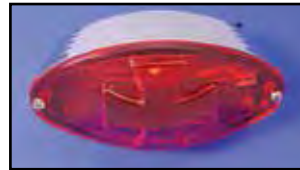

33-0587

### Maltese Inset Oval Tail Lamp.

VT No.	Color	Type	Style
33-0749	Red	With clear	Cross
33-0750	Clear	With red	Cross
33-0751	Red	With red	Cross
33-0587	Red	With bulb	Skull
33-0031	Red	LED	Skull



33-1325



33-1326



33-1093



33-1094



33-1096



33-1099

### Tail Lamps.

VT No.	Item
33-1325	Chrome Round Tail lamp
33-1326	Black Round Tail lamp
33-1093	LED type with bracket red plastic lens & chrome housing
33-1094	LED type with bracket red plastic lens & black housing
33-1096	Chrome Universal Tail lamp
33-1099	Black Universal Tail lamp



**Chrome Die Cast Box Tail Lamp,**  
12 Volt.  
**VT No. Item**  
**33-0310** Lamp  
**33-2119** Lens



**33-1972**  
**Replica Lucas Lamps.**  
**VT No. Style**  
**33-1972** Large  
**33-0302** Small



**Cat Face Tail Lamp** mounts on flat plate.  
**VT No. 33-0915**



**Diamond Rear Lamp** features a red lens, 12 volt, bolts to stock FXWG-FXST or to cateye mount holes.  
**33-0344**

**VT No. Item**  
**33-2128** Complete Lamp  
**33-0344** Complete Lamp (LED)  
**33-2143** Red Lens Only

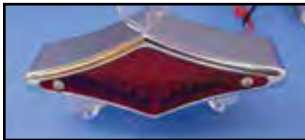

**Diamond LED Tail Lamp** has bolt pattern to fit cateye applications.  
**VT No. Back**  
**33-0354** Flat  
**33-0858** Angled



**Spike Tail Lamp** with license plate lamp.  
**VT No. 33-0619**



**Iron Cross Oval Tail Lamp** features LED design with red lens and two clear LEDs for plate illumination. Mounts where any cateye tail lamp with mount.  
**VT No. 33-0477**

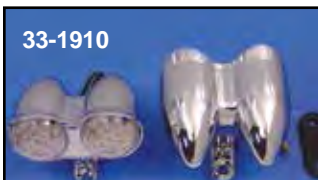

**Oval Chrome Tail Lamps** feature visor and LED internals.  
**VT No. LED Lens**  
**33-1910** Red Clear  
**33-1911** Red W/turn signal



# Tail Lamp



**Chrome Big Eye Tail Lamp** are constructed of ABS.  
**VT No. Lens Type**  
**33-0643** Clear LED  
**33-0644** Red Bulb



**33-0767**  
**Kateyza Tail Lamp** with LED. Measures 6.5" x 1.5" with 2" center to center.  
**VT No. 33-0767**



**Maltese Lamps** fit flush mount to steel backing plates.  
**VT No. Finish**  
**33-0312** Light  
**33-0343** Light (LED)  
**33-0595** Lens Only

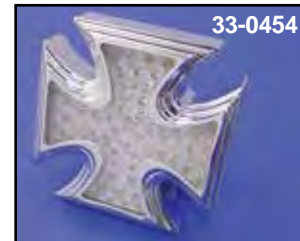

**VT No. 33-0454** Wire Functions  
**Black Wire** - Ground  
**White Wire** - Running Light  
**Orange Wire** - Brake Light  
**Red Wire** - Blinker Brake Light  
**Green Wire** - Blue LED Light

**Warranty**  
**LED Boards** will be warranted only. No credit will be issued on any lamps or components with the 33 prefix. Lamps will either be exchanged or repaired and returned to the dealer.

**4" Maltese Billet Tail Lamp** features center portion acting as brake lamp. 33-0456 features red lens and all red LEDs. 33-0454 features clear lens and red/blue LEDs.

**VT No. Lens**  
**33-0454** Clear  
**33-0456** Red



**2 3/8" Square Maltese LED Tail Lamp.**  
**VT No. 33-0820**



**Maltese Tail Lamps** with LED  
**VT No. Lens**  
**33-0964** Clear  
**33-0965** Red





# Model "A" Tail Lamp



33-1312



33-1313



33-0900



33-0901



33-1314

**Model "A" Retro Tail Light** with glass lens.  
**VT No. Finish**  
 33-1312 Chrome  
 33-1313 Black  
 33-1314 Stainless

**Model "A" Style Chrome Round Tail Lamps.**  
**VT No. Lens**  
 33-0900 Red  
 33-0901 Red with dot

# Side Mount XL Tail Lamp



**Warranty**  
 LED Boards will be warranted only. No credit will be issued on any lamps or components with the 33 prefix. Lamps will either be exchanged or repaired and returned to the dealer.



**Vertical Side Mount Tail Lamp** fits 2004-up.  
**VT No. 33-1811**



**Cat Eye Side Mount Lamp Kits** bolt to primary cover on 2004-up XL models.  
**VT No. 33-0852**

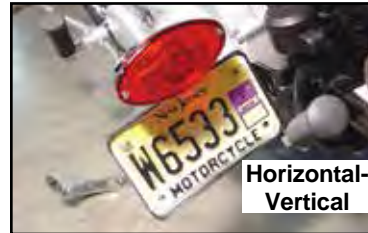

Horizontal-Vertical

**Chrome Billet Vertical Side Mount Tail Lamp Assemblies** feature LED lamps with plate illumination and unique mounting design which incorporate adjuster block. Tail Lamp and plate available without bracket.

79-96 XL	Style	Type	Plate/Lamp
33-0773	Diamond	Vertical	33-0222
—	Cat Eye	Vertical	33-0461
—	Maltese	Vertical	33-0357
33-0768	Iron Cross	Horizontal	33-0263
33-0769	Maltese	Horizontal	33-0262
33-0770	Mini	Horizontal	33-0264
33-0771	Slice	Horizontal	33-0265
33-0772	Diamond	Horizontal	33-0266



*Remote Inspection Tag Holder First Offered by V-Twin Mfg. in 1969*

## Inspection Tag Holders



31-0201

31-0264

31-0282

31-0983

31-0933

**Inspection Tag Holder** is available in stainless or chrome. Measuring 3½" square with ½" or ⅜" mounting hole which can mount to footpeg or shock studs. 31-0282 is square type which clamps on to 1" to 1½" tube with worm clamp included.

VT No.	Item	Type
31-0201	Stainless	.5"
31-0264	Chrome	.5"
31-0983	Chrome	⅜"
31-0282	Chrome	Clamp
31-0933	Black	.5"



# Side Mount Lamp Assembly



33-0896



33-0951



33-0955



33-0955  
Installed



33-0841



33-0953 Installed



31-0856  
Bracket  
Installed with  
33-0489



31-0986 shown with maltese curved plate



**Side Mount Tail Lamp Bracket and Plate Kit** bolts to Softail and FXD outer primary covers. Fits 1989-06 Softail and 1989-05 Dynaglide. Kit includes 31-0790 bracket shown.

Kit	Replacement Plate/Lamp	Item
33-0896	33-0805	Slice
33-0951	33-0222	Diamond
33-0952	33-0461	Cateye Lamp
33-0953	33-0357	Maltese Lamp
33-0954	33-0489	Odin Lamp
33-0955	33-0490	Katz Eyez
33-0841	—	Pirate

**LED**

### Warranty

LED Boards will be warranted only. No credit will be issued on any lamps or components with the 33 prefix. Lamps will either be exchanged or repaired and returned to the dealer.

**Side Mount Brackets** will mount vertical flat side mount units to Softail or FXD primary or Softail pivot pin on left side. Bracket 31-0791 shown installed with 33-0357 lamp.

VT No.	Type	Year	Model
31-0790	Primary	1989-06 1989-05	Softail FXD
31-0986	Primary	1986-06 1989-05	Softail FXD
31-0891	Primary	2006-up	FXD
31-0791	Pivot	1987-99	Softail
31-0856	Primary	1965-88	Big Twin
31-0896	—	Bolts	Softail
31-0721	Belt Drum	1986-up	Softail





**LED**

# Side Mount Tail Lamp



33-0569

**Chrome Side Mount Tail Lamp Assembly** features LED billet oval lamp, curved plated area to fit 3/4" or 1" axle on 1986-up Softail models.

VT No. 33-0569



33-0282

**Curved Lady Luck LED Tail Lamp Assemblies** to fit Softail models with 3/4" or 1" axle.

VT No. 33-0282



**Chrome Vertical Side Mount Tail Lamp Assembly** features total billet construction including LED billet oval tail lamp with flat lens. Fits 1986-up Softail models.

VT No. **Item**  
33-0588 Assembly  
33-0443 Lamp Only



33-0210



33-0217



33-0215

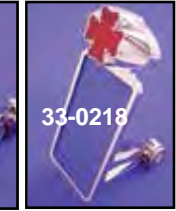

33-0218

**Iron Cross Side Mount Lamp Assemblies** fit 1986-up Softail models with 3/4" or 1" axle.

VT No. **Style**  
33-0210 Vertical  
33-0217 Horizontal  
33-0215 Curved Vertical  
33-0218 Vertical



**Shoulder Nut** allows mounting of Billet side mount tail lamp assemblies to early model rear axles. Fits Billet type with 1" to 3/4" sleeve type mount brackets. Use VT No. 44-0755 on 1" axles fitted to 06-up FXD models.

VT No. **Size** **Axle**  
44-0376 5/8 x 18 3/4"  
44-0755 3/4 x 16 1"

## Billet Side Mount



33-0458



33-0459



33-0457

**Katzeyz LED Assemblies** available as side mounts 1986-up Softail units or as tail lamp only. Tail lamp features full LED with license plate light with 2" center to center mount holes, to fit where cateye or similar lamps will install.

VT No. **Type**  
33-0458 Vertical  
33-0459 Curved  
33-0457 Horizontal  
33-0767 Tail Lamp Only  
33-0460 Fender Mount



33-0767



**Chrome Radii™ Side Mount License Plate Assembly** fits 3/4" axle on 1986-up Softail models.  
VT No. 33-0630

**Warranty:** LED Boards will be warranted only. No credit will be issued on any lamps or components with the 33 prefix. Lamps will either be exchanged or repaired and returned to the dealer.



33-0792



33-0843

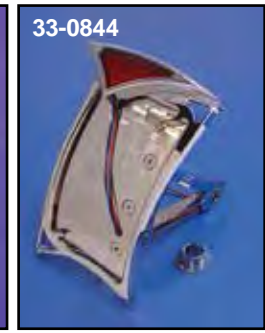

33-0844

**Tail Lamp Assembly** fits Softail models with 3/4" or 1" axle.

VT No. **Style** **Style**  
33-0792 Spike Curve  
33-0843 Pirate Flat  
33-0844 Pirate Curve



33-0469



33-0898

**Incurvate License Plate Bracket** includes LED diamond lamp to fit 1986-up Softail models with 3/4" or 1" axle.

VT No. **Style**  
33-0469 Diamond  
33-0898 Slice

Lamps listed are for show or decorative use only, and not D.O.T. approved.



# Side Mount Tail Lamp



33-0363

**Vertical Side Mount Maltese Tail Lamp** includes light, chrome backing plate and side mount bracket to fit 5/8" axles.

**VT No. 33-0363**



33-0347 Installed



Originally developed in 1970 by Clown Cycle, NYC.

**Chrome Side Mount Tail Lamp Kit** fits right or left side.

**VT No. 33-0307**



33-0345

**Side Mount Cateye Tail Lamp Kit** feature die cast cateye lamp with chrome recessed plate. To fit 5/8" axles.

<b>VT No.</b>	<b>Style</b>
33-0345	Horizontal
33-0364	Vertical



33-0611

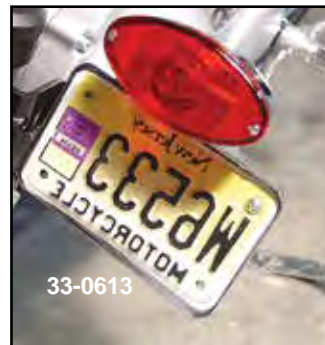

33-0613

**Tail Lamp and Mounting Plate Set** includes lamp and backing plate which may be sissy bar or side mounted (by purchase of bracket).

<b>VT No</b>	<b>Type</b>	<b>Size</b>
33-0611	Lucas	4" x 7"
33-0612	Lucas	5" x 7"
33-0613	Cateye	4" x 7"



33-1031



42-1525

**Swivel Side Mount Bracket Kit** will mount in horizontal or vertical position with a set screw mounts to side mount brackets.

**VT No. Item**  
**33-1929** Bracket Kit  
**42-1525** Plate Holder Only  
**33-1031** Chrome Kit



33-0414



33-0347

**Maltese Side Mount Kit** includes chrome steel plate, bracket and lamp with bulb.

<b>VT No.</b>	<b>Type</b>
33-0414	With Bracket
33-0347	Without Bracket
31-0175	Bracket Only



**Chrome Bushing Kit** allows use of 3/8" or 1/2" bolt mounting of Softail type billet side mount assemblies.  
**VT No. 37-0048**



**Chrome Side Mount Tail Lamp Kit** fits 1986-99 Softail models mount bracket replaces left side axle adjuster.  
**VT No. 31-0595**





LED

# Billet Side Mount

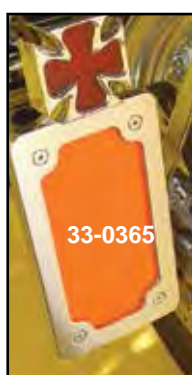

**33-0455**



**Warranty**  
LED Boards will be warranted only. No credit will be issued on any lamps or components with the 33 prefix. Lamps will either be exchanged or repaired and returned to the dealer.

Chrome Billet Side Mount Assembly features 2.5" square LED Maltese lamp.

VT No.	Type	Mounting Type
33-0361	Vertical	Softail
33-0766	Vertical	Softail
33-0362	Horizontal	Softail
33-1917	Horizontal	Softail
33-0764	Vertical Curved	Softail
33-0367	Vertical	1/2" or 3/8" Stud
33-0365	Vertical	3/8" Axle Nut
33-0366	Horizontal	Axle Nut
33-0455	Lamp Only	—

# Brackets



Chrome Mount Bracket mounts to Softail belt guard mounts on 1986-99.  
VT No. 31-0647



Side Mount Tail Lamp Clamp Sets will mount 31-0647 to frame rear sections. Accepts 3-bolt plate and lamp assemblies.

VT No	Size
31-0695	1"
31-0696	1 1/8"
31-0697	1 1/4"
31-0698	1 3/8"



Chrome Billet Side Mount Brackets fit into stock swing arm.

VT No.	Year	Model
31-0714	1991-05	FXD
31-0727	1973-84	FX-FL
	1979-96	XL
44-0682	5/16 x 24	Nut Set
44-0683	5/16 x 18	Nut Set



Chrome Lay Down Tubing Mounts will attach vertical Billet side mount tail lamps from our catalog to 1" and 1 1/8" tubing. Mounting requires drilling and tapping two 1/4" x 20 holes.

VT No.	Size
31-0769	1"
31-0770	1 1/8"



Billet Side Mount Brackets feature 1/2" hole with a 3/8" adapter bushing so bracket can mount to shock bolts on swing arm models. Use for mounting side mount units on FXR-FXD models. Brackets fit flat backed Billet lamp assemblies: 33-0582, 33-0588, 33-0568, 33-0566, 33-0352

VT No. 31-0716 3/8" or 1/2"



Billet Clamp On Side License Plate Mount will accept 3-bolt plate units for left side mounting. Order flat or curved lamp assembly separate.

VT No.	Fits
31-0914	Curved
31-1204	Flat



**Billet Side Mount Bracket.**

VT No.	Style
31-0729	Flat
31-0732	Curved
44-0660	3/4" -1" Bushing



# LED Side Mount Tail Lamp



**Note:** Side Mount Units available with bracket to mount to shock bolt with 3/8" or 1/2" thread on 1979-up models or with 5/8" x 20" acorn nut to axle on 1967-78 XL's or Rigid applications. Softail types fit 1986-up Softail models.

**Side Mount Billet Chrome Tail Lamp Assemblies** feature mini rectangular lamp.

VT No	Type	Mounting Type
33-0383	Skull	Softail
33-0384	Plain	Softail
33-0722	Skull	1/2" or 3/8" Stud
33-0723	Plain	1/2" or 3/8" Stud
33-0640	Skull	5/8" Axle Nut
33-0641	Plain	5/8" Axle Nut
33-0654	LED	Array only for Above

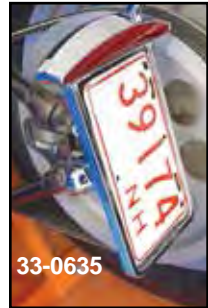

**Billet Noid Side Mount Units** fit 1986-up Softail.

VT No.	Style
33-0394	Vertical
33-0396	Curved
33-0395	Horizontal

**Chrome Billet Vertical Tail Lamp Assembly** to fit 1986-up Softail models. Features LED slice tail lamp.

VT No.	Mounting Type
33-0582	Flat
33-1135	Flat
33-0593	Curved
33-1918	Flat
33-0635	5/8" Axle Nut
33-0724	1/2" or 3/8" Stud
33-0653	LED Array Only

**Billet Side Mount Lamp** features LED with 1/2" mount hole, with 1/2" x 1" spacer for shock or frame mounting.

VT No. 33-1249



**Side Mount Billet Tail Lamp Bracket** fits left side of 1986-99 FXST or can be attached with clamps. Order clamps separately. Utilizes 3-bolt plate and lamp assembly. Builder must use clamps or fabricate brackets to attach to frames. Lamps include 3 hole plate to mount to 31-0647.

VT No.	Item	Style
31-0647	Bracket	—
33-0353	Lamp	Diamond
33-0385	Lamp	Skull
33-0567	Lamp	Slice

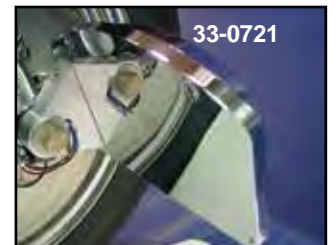

**Billet LED Slice Side Mount Tail Lamp Assembly.**

VT No.	Mounting Type	Finish
33-0568	Softail fits 3/4" or 1" axle	Chrome
33-1525	Softail fits 3/4" or 1" axle	Black
33-0639	As Above 5/8" Axle Nut	Chrome
33-0721	1/2" or 3/8" Stud	Chrome
33-1136	Softail fits 3/4" or 1" axle	Chrome

### Warranty

LED Boards will be warranted only. No credit will be issued on any Lamps or components with the 33 prefix. Lamps will either be exchanged or repaired and returned to the dealer.





# LED Tail Lamp



33-0371



33-0416



33-0373



33-0416 Installed



33-0350



33-0351



33-0352



33-0631



33-0726



33-0727

**Diamond LED Billet Tail Lamp Assemblies.** Full 12 volt LED array installed. Plate and lamp set does not include mount bracket.

VT No.	Style	Mounting Type	Plate/Lamp
33-0350	Vertical Curved	FXST-FLST	33-0234
33-0351	Vertical	FXST-FLST	33-0222
33-0352	Horizontal	FXST-FLST	33-0266
33-0631	Vertical Curved	5/8" Axle Nut	
33-0632	Vertical	5/8" Axle Nut	
33-0633	Horizontal	5/8" Axle Nut	
33-0726	Vertical	1/2" or 3/8" Stud	
33-0727	Horizontal	1/2" or 3/8" Stud	
33-0858	Lamp Only		
33-0895	Lens Only		
33-0652	LED Array		

**4 X 4 Red Baron Cross Lamp Assemblies.** Softtail styles feature bushing to accept 1" or 3/4" axle with brake and tail lamp only.

VT No.	Style	Type
33-0371	Curved Vertical	Side, Softtail
33-0416	Flat Vertical	Side, Softtail
33-0373	Flat Vertical	



33-0566



33-0725

**Chrome Billet Side Mount Tail Lamp Kit** features vertical plate area with cat eye LED tail lamp.

VT No.	Mounting Type
33-0566	Softtail
33-0638	5/8" Axle Nut
33-0725	1/2" or 3/8" Stud

**Warranty**  
LED Boards will be warranted only. No credit will be issued on any lamps or components with the 33 prefix. Lamps will either be exchanged or repaired and returned to the dealer.



**Skull Tail Lamp** fits  
VT No. 33-1475



33-0741



33-0741  
Back



33-0742



33-0742  
Back

**Billet Side Mount Tail Lamps** fit FXD 1991-05 models, vertical type.

VT No.	Style
33-0741	Diamond
33-0742	Cateye

# LED Curved Side Mount

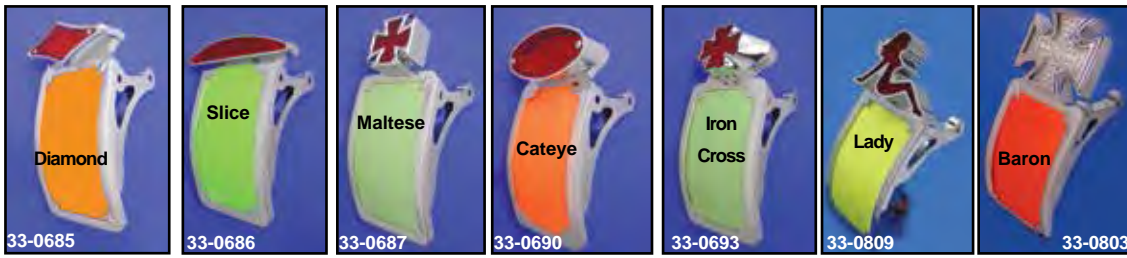

**Chrome Billet Curved Tail Lamp Assembly** mounts to outboard starter housing on York, BDL and Primo 3", 3 $\frac{3}{8}$ " and 3 $\frac{1}{2}$ " belt drives. Complete assembly includes curved plate/tail lamp holder and mounting bracket. Curved Plate/Tail Lamp Assembly also sold separate.

**VT No. Type**  
**33-0685** Diamond  
**33-0686** Slice  
**33-0687** Maltese  
**33-0690** Cateye  
**33-0693** Iron Cross

**VT No. Type**  
**33-0462** Odin  
**33-0463** Katz  
**33-0795** Spike  
**33-0809** Lady  
**33-0803** Baron

**Warranty**  
**LED Boards** will be warranted only. No credit will be issued on any Lamps or components with the 33 prefix. Lamps will either be exchanged or repaired and returned to the dealer.

## Side Mount

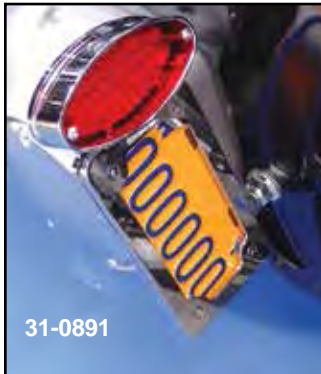

**Flat Side Mount Lamp Bracket** adapts vertical LED units to 2006-up FXD-FXDWG and 2007-up Softtail's. Order lamp assembly separately.  
**VT No. 31-0891**

**31-0891** bracket use to mount **33-0588** Lamp assembly on 2007 Softail or 2006-up FXD

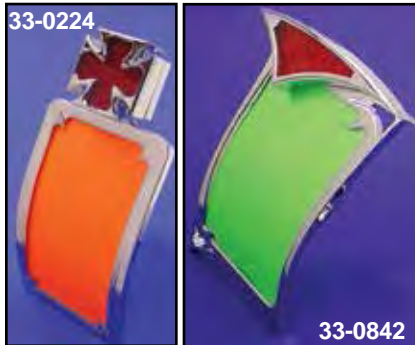

Lamps Listed On This Page Are For Show Or Off Road Use and not D.O.T. approved.



**Plate and Lamp Set** available separately without bracket.

**Plate/Lamp Type**  
**33-0234** Diamond  
**33-0223** Slice  
**33-0224** Maltese  
**33-0225** Cateye  
**33-0226** Iron Cross  
**33-0487** Odin

**Plate/Lamp Type**  
**33-0488** Katz  
**33-0800** Spike  
**33-0802** Lady  
**33-0801** Baron  
**33-0842** Pirate  
**31-0721** Bracket for Belt Drive Mount  
**31-0732** Bracket for Axle Mount

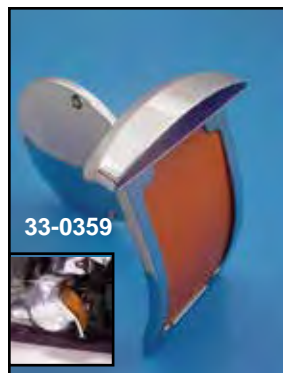

## LED Derby Mount Tail Lamp

**Billet Chrome License Plate Assemblies** with derby cover mount. Available with 3 or 5 hole design. **\*Note:** 1999-06 will not fit 2007-up.

3 Hole Derby	5 Hole Derby*	Lamp
1970-98	1999-2006	
<b>33-0355</b>	—	Diamond
<b>33-0359</b>	<b>33-0360</b>	Slice
<b>33-1007</b>	—	Box

**Warranty**  
**LED Boards** will be warranted only. No credit will be issued on any Lamps or components with the 33 prefix. Lamps will either be exchanged or repaired and returned to the dealer.





# Chopper Tail Lamp

**Chopper 12 Volt Tail Lamp** with red lens are not DOT approved and are for decoration or show use only.

Chrome	Black	Item
33-1022		Warbird LED
	33-1023	Finger LED
	33-1024	Warbird with hinged
33-1025		Maltese LED
	33-1026	"FCUK" LED
33-1028	33-1027	Round



## Tail Lamp Wire

**Tail Lamps Wires.** Cotton Braided Wires

32-9306	1936-47	All
32-9307	1948-69	All
32-7553	1934-69	Servi-car and Sidecar

**PVC Covered Tail Lamp Wires** fit 1970-up.

32-9309	1970-72 FL, 1971-72 FX, 1973-77 FL	
32-9310	1973-77 FX-FXE	
32-9311	1978-84 FL	
32-9313	1978-84 FX-FXE	
32-9331	1987-90 ST	
32-9336	1991-95 ST	
32-0486	1996-up ST	



**Tail Lamp Connector** includes wire harness to be spliced to replacement.

VT No.	Type
32-0491	Deutsch
32-0944	6 Pin Amp

## LED Side Mount Lamp

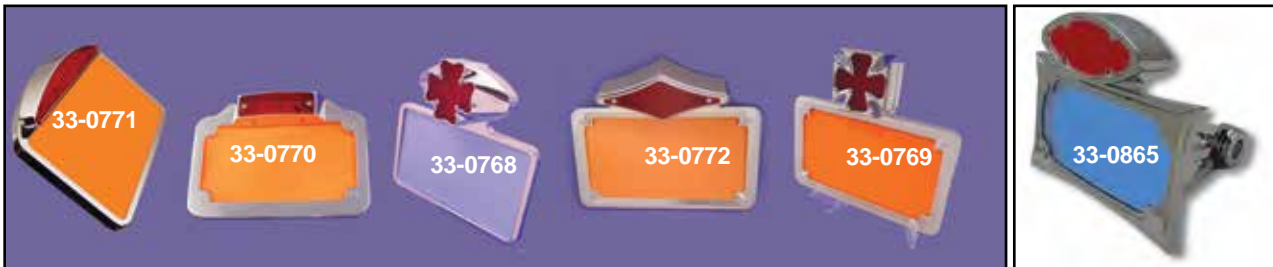

**Chrome Billet Vertical Side Mount Tail Lamp Assemblies** feature LED lamps with plate illumination and unique mounting design which incorporate adjuster block. Tail lamp and plate available without bracket.

**1973-84 Big Twin**

1979-96 XL	Style	Type	Plate/Lamp
33-0773	Diamond	Vertical	33-0222
—	Cat Eye	Vertical	33-0461
—	Maltese	Vertical	33-0357
33-0768	Iron Cross	Horizontal	33-0263
33-0769	Maltese	Horizontal	33-0262
33-0770	Mini	Horizontal	33-0264
33-0771	Slice	Horizontal	33-0265
33-0772	Diamond	Horizontal	33-0266



**Odins FXST Side Mount Tail Lamp Assembly** features 12 volt LED tail lamp and either vertical or horizontal mounting type.

VT No.	Item
33-0864	Vertical Softail
33-0865	Horizontal Softail
33-0866	Vertical Curve Softail
33-0867	Lamp Only



**Warranty**  
LED Boards will be warranted only. No credit will be issued on any lamps or components with the 33 prefix. Lamps will either be exchanged or repaired and returned to the dealer.



# Retro Fender Mount Taillamps



**LED Round Tail Lamp**  
**Chrome Black Lens**  
 33-1526 33-1527 Red (Two Bolt )  
 33-1528 33-1529 Smoke

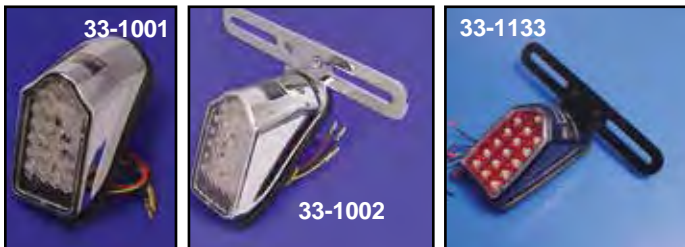

**Mini Tombstone** measures 4.5" long by 2.5" wide. Order bracket 31-0200 to fit 33-1001 lamp.

VT No.	Type	Finish
33-1001	Without bracket	Chrome
33-1002	With bracket	Chrome
33-1133	With bracket	Black



**Stoplight Sensor.**  
 VT No. 33-1181



Chrome	Black	Item
33-1036		Round Tail Lamp
33-1037		Torpedo Bullet Style
33-1038		Round Tail Lamp with 12 volt bulb
33-1039		Wipac British Style



**Aluminum PK Tail Lamp.** Original 1940's styling with cone shaped glass lens, 12 volt.

VT No.	Finish
33-1010	Polish
33-1018	Chrome



**Mini Cateye Tail Lamp Kit** includes chrome tail lamp and alloy mount bracket. Not approved for street use.

VT No.	Size	Item
33-0315	Small	Kit
33-0316	Large	Kit
33-0381	Small	Lamp Only
33-0382	Large	Lamp Only
33-0087		"STOP" Kit





# Tail Lamp



**33-0820 Maltese LED Lamp Kit** is 2 3/8" square with red lens mounted black bracket separately.  
**VT No. Item**  
**33-0824 Kit**  
**33-0820 Maltese**  
**31-0866 Bracket**



**33-0061 Tail Lamp** with red bulb with a red lens. Lamp has swivel 2 hole mounting bracket.  
**VT No. 33-0061**

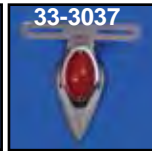

**Fresno Chrome Teardrop Tail Lamp Assembly** features die case construction and stainless strap license plate bracket.

VT No.	Item	Type	Lens
33-3036	Lamp	Bulb	Red
33-0198	Lamp	LED	Clear
33-3037	Lamp	LED	Red
31-0663	Bracket		

# Fender Mount Tail Lamp

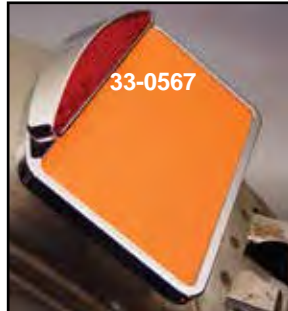

**Chrome Billet Fender Mount LED Tail Lamps** mount to 3 bolt position on stock fenders. Rubber pad included.

VT No.	Item	33-0216	Iron Cross
33-0353	Diamond	33-0289	Zoid
33-0567	Slice	33-0460	Katzeyez
33-0385	Skull	33-1919	Clear
33-0765	Maltese	33-1904	Slice



**Chrome Fender Mount Oval Tail Lamp Assembly** mounts to stock 3 hole style pattern.  
**VT No. 33-1905**



**Radii LED Fender Mount Tail Lamp** features Billet bracket with Billet oval LED lamp with LED amber turn signals.  
**VT No. 33-0609**

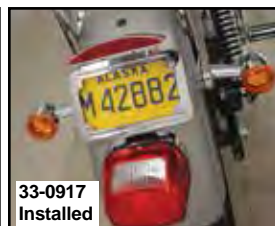

**Chrome Billet Fender Mount Tail Lamp** features LED slice tail lamp. Unit bolts in 3 hole license plate bracket location.

**VT No. 33-0917**  
**1130**

**Warranty**  
**LED Boards** will be warranted only. No credit will be issued on any Lamps or components with the 33 prefix. Lamps will either be exchanged or repaired and returned to the dealer.

Lamps listed are for show or decorative use only, not D.O.T. approved.



# Fender Mount Tail Lamp



33-1977



33-2140



33-0600



33-0617



33-0885



33-0621



33-1972



**Chrome Fender Mount Tail Lamp** features clear lens red LED bulb.  
VT No. 33-0885



33-0622



33-0302



33-0911



33-0912

**Mini-LED Cat Eye Tail Lamp** features 15 LEDs, in a 4½" W x 1" H lamp with an alloy plate mount with 6¾" width.

VT No.	Lens
33-0911	Clear
33-0912	Red



**Chrome Fender Mount Tail Lamp Assembly** includes license plate mount and fender bracket in chrome steel.  
VT No. 33-0308

**Sport Tail Lamp Assembly** features aluminum body and lamp, for show use only.

VT No.	Item
33-2140	Complete, Aluminum, large
33-1977	Complete, Chrome, large
33-0600	Complete, Aluminum, small
33-0617	Complete, Chrome, small
15-0577	Gasket for 33-2140 and 33-1977
33-1972	Lamp Only for 33-2140/33-1977
33-2126	Lens Only for 33-2140 & 33-1977
33-0302	Lamp Cpt for 33-0600/33-0617
15-0543	Lens Gasket for 33-1972
33-0621	Complete Chrome, 12 V with cateye
33-0622	Complete Chrome LED with cateye



**Snake Eye Tail Lamp.** Lens measures 16 cm x 4 cm, with alloy license plate bracket.

VT No.	Item	Type
33-0435	Kit	Bulb
33-0651	Kit	LED
33-0439	Lamp Only	LED
33-0902	Lamp Only	LED

Lamps listed are for show or decorative use only, and not D.O.T. approved.





# Fender Mount Sparto Lamp

33-1079



**Sparto Tail Lamp** with red lens mounts to fender. Bulb type.  
VT No. 33-1079



33-0334



33-1290



33-1278



© 2001

**P-K Sport Tail Lamp** features red lens with clear license plate window.

VT No.	Type	Lens	Finish
33-0334	Bulb	Red	Chrome
33-1290	Bulb	Red	Black
33-1278	LED	Clear	Chrome



**Mini Round Tail Lamp** includes brake and tail lamp with 12 volt bulb.  
VT No. 33-0676

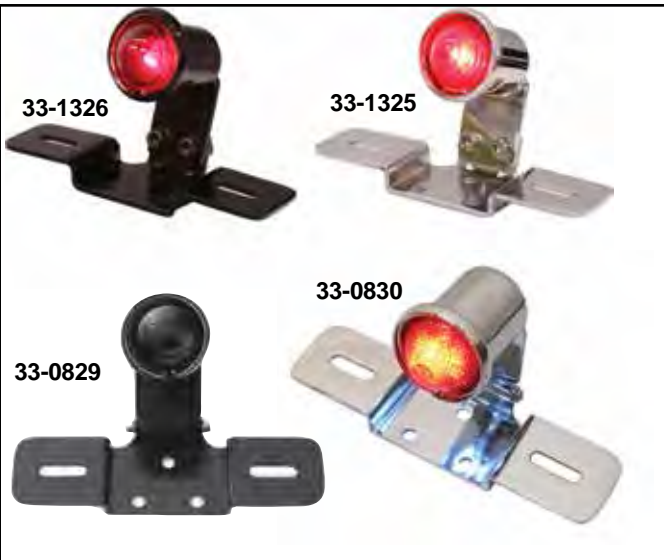

33-1326

33-1325

33-0830

33-0829

**Round Bobber Tail Lamp.**  
Bulb LED Finish  
33-1325 33-0830 Chrome  
33-1326 33-0829 Black



33-1940



33-1941



33-1322

**Replica Crocker Fender Mount Tail Lamp** features accurate cast alloy housing with glass lens installed and license plate bracket included.

VT No.	Item
33-1940	Polished
33-1941	Chrome
33-1322	Chrome with facets
15-0546	Gasket



33-0327



33-0331



33-1289

**Replica Sparto Tail Lamp** features red lens with license plate clear window.

VT No.	Finish
33-0327	Polished
33-0331	Chrome
33-1289	Black



33-0041



33-0303



33-2000

**Sparto Style Tail Lamp** features die cast housing in polished or chrome with gasket for fender mounting.

VT No.	Item	Type
33-0041	Chrome	LED
33-0303	Polished	Bulb
33-2000	Chrome	Bulb
33-0326	Black	Bulb
33-0510	Red Lens	
15-0709	Mount Gasket, each	



33-0326



33-0510



# Vintage Style Tail Lamp



## Tail Lamps.

VT No.	Finish	Type
33-2245	Black	Surface Mount, Dual Filament
33-2235	Black	1" Round, Black with Black Flange Base
33-2236	Black	1.5" Round, Black with Black 2 1/4" Flange Base
33-2237	Black	2" Round, Black with Round Black Base
33-2238	Black	Teardrop, Black with Red Lens and Base, Order License Plate Bracket Separately
33-2243	Chrome	Teardrop, Black with Red Lens and Base, Order License Plate Bracket Separately
33-2239		Red Lens Star 3.5" Wider Mound Stud 1.5" apart
33-2240		Mini 4" Wide with Mount Studs 3.5" apart
33-2241		Step Lamp with White LED with Two Screws 1.5" Long x 5" Wide 8000 MCD
33-2242		Fender Mount with Alloy Bracket and Clear Lens LED
33-0900	Chrome	Round "Stop", Model "A" Style
33-0901	Chrome	Round "Stop Lamp, Model "A" Style with Blue Dot
33-1059		Chrome Skull Style Bobber, includes black mounting bracket
33-1346	Black	Round "Stop" LED Lamp
33-1423	Black	Vintage BMW



**Stop Tail Lamp** for fender mounting with 12 volt bulb.  
VT No. 33-1927

## Bates LED Tail Lamp.

VT No.	Finish
33-1045	Chrome
33-1046	Black



**Bobber Black Tail lamp** with bezel. Universal fender mounting type.  
VT No. Bezel  
33-1347 Alloy  
33-1050 Black  
33-1051 Copper

**Bobber Mini Tail lamps** not with red lens and black bracket for highway use.

LED	Bulb	Size
33-1085	33-1061	1"
33-1086	33-1062	1.5"
—	33-1063	2"
33-1301	—	1"



**Twin Round Tail Lamp** with mounting bracket. Features two mini round tail lamps and alloy number plate bracket for fender mounting.  
VT No. 33-0744





# Tombstone Tail Lamp

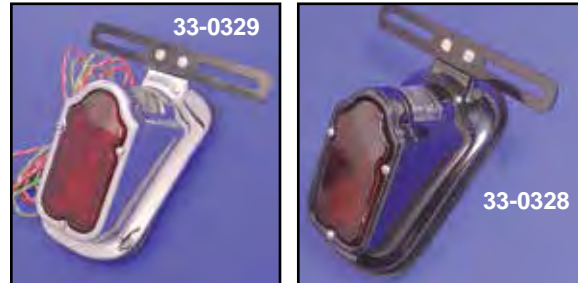

Replica Tail Lamp feature black license plate bracket, glass lens and cloth wire loom. Tombstone tail lamp components available separately.

VT No.	OEM	Finish
33-0329	68002-47B	Chrome
33-0328	68002-47A	Black



Components for Replica Tail Lamp.

33-1284		Black Rim
33-0558	68085-47	Raw Rim
33-0528	68086-47	Chrome Rim
33-0840		Guide
33-0502	68090-47	Red Lens, Glass
33-0480	—	Red Lens, Glass, Tombstone
33-2108	68090-47	Red Lens, Glass, Maltese
33-2124	68093-47	Red Lens, Plastic
33-0146*	68093-47	Clear Top Lens, Glass
33-2079	68093-47	Clear Top Lens, Plastic, Kit
15-0413	68121-47	Clear Top Lens, Plastic
15-0305	68122-47	Clear Top Lens, Gasket
15-0208	68123-47	Red Lens Gasket
15-0323	68123-47	Beaded Mount Gasket
33-0498	68135-47	Replica Foam Mount Gasket
31-0241	68150-49	Top Lens Clip
31-0324	—	Replica Plate Bracket
31-0047	—	Plate Bracket
12-2526	68672-38	Plate Bracket
32-9307	—	Chrome Rim Screw
32-0959	—	Cloth Wire
33-0840	—	Cloth Wire Assembly
33-1057	—	Glass Lens, Red
28-0666	—	Bulb Socket
33-1399	Kit	Bushing
		1947-49

\*Note: Includes plastic lens, gasket and mounting clip.

Tombstone Tail Lamp Complete Assembly includes license plate mount bracket. Bullet lamps are not LED.

VT No.	Type	Finish
33-0305	Bulb	Chrome
33-0332	LED	Chrome
33-0597	Bulb	Chrome with Bullet Light
33-0663	LED	Chrome with Bullet Light
33-6063	LED	Chrome with Bullet Light
33-1973	Bulb	Black
33-1341	Bulb	Chrome
33-1342	Bulb	Black
31-0200	—	Plate Bracket, Chrome
31-0095	—	Plate Bracket, Black
33-0949	—	Red Lens Set for 33-0597



Tombstone Rebuild Kits.

VT No.	Year
33-1309	V-Twin Type
33-1399	1947-49
33-1315	1950-54



Tombstone Lamps with glass lens and guide bracket.

VT No.	Year
33-1471	Chrome
33-1472	Black



Black Die Cast Tombstone Tail Lamp with a 12 volt 23/8 watt clear bulb and a red lens features a black finish. License plate cross bracket and gasket are included.

VT No. 33-1473



31-0324



31-0241



31-0047



31-0047 Close Up

License Plate Brackets for tombstone tail lamps.

VT No.	Finish	Brand	Fits
31-0324	Black	VT	1947-49
31-0241	Black	Guide	1949-54
31-0200	Chrome	VT	1947-48
31-0095	Black	VT	1947-54
31-0047	Black	VT	1947-50

Lamps listed are for show or decorative use only, not D.O.T. approved.



# Tombstone Tail Lamp



33-0171

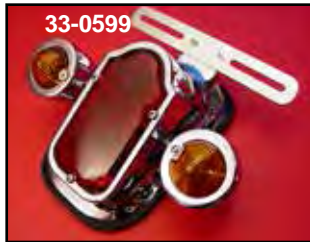

33-0599



33-0185



33-2162

**Tombstone Tail Lamp Kit** includes die cast chrome tail Lamp license plate bracket and chrome plated steel adapter plate which will mount to all Big Twin stock rear fenders, to replace the original style Lamp.

VT No.	Item	Type	Year	Note:
33-0171	Kit	Bulb	1973-98	33-0185 fits 99-up stock fenders with rectangular cut out for tail Lamp
33-0599	LED		1973-98 with Signal	
33-0185	Kit	Bulb	1999-up	
33-2162	Adapter only		1973-98	

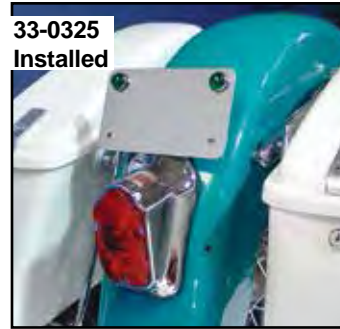

33-0325 Installed



33-0338,  
33-0325  
33-0333  
33-0339  
Installed



33-0339



33-0941

**Tombstone Tail Lamp Assembly** is larger than conventional size tombstone and is used with stock 31-0158 chrome license plate bracket to fit 1973-98 models. 33-0311, 33-0599 and 33-0182 include chrome cross bracket.

VT No.	Type	Year/Fender
33-0325	Bulb	1973-98
33-0333	LED	1973-98
33-0311	Bulb	Smooth
33-0338	Bulb	1999-up FXD
33-0339	LED	1999-up FXD
33-0941	Bulb	Without Window
33-0646	Lens Only	All

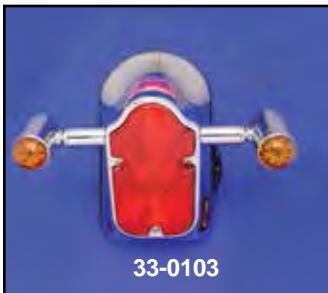

33-0103



**Wide Tombstone Tail Lamp Assembly** feature LED units in turn signal lights to fit stock 1973-99 rear tail lamp cutout.

**VT No. 33-0103**



33-1247

**Tombstone Tail Lamp** features full red lens, to give side view when lit.

VT No.	Type
33-1247	Bulb
33-1248	LED (48 mA)
33-2208	Lens



33-0205

**Skull Clear Face Tombstone Lamp** features die cast construction with LED board.

**VT No. 33-0205**



33-0434



33-2161

**Skull Rim** is available with or without blue dot fits early style tombstone tail lamps 33-0305, 33-0171, 33-0185 and 33-0599.

VT No.	Type
33-0434	With Dot
33-2161	Without Dot



**Chrome Tombstone Tail Lamp** includes skull rim lens grill. Kits include die cast chrome tail lamp license plate bracket and chrome plated steel adapter plate which will mount to all Big Twin and XL stock rear fenders, to replace the original style lamp.

VT No.	Item	Fits
33-0313	Tail Lamp	Custom
33-0190	Kit	1973-98
33-0191	Kit	1999-up

Lamps listed are for show or decorative use only, and not D.O.T. approved.





# Tail Lamp



**Bobber Tail Lamp** is a replica version of late 1940's black tail lamp with chrome bullet hood and glass lens. Mounts to fender and includes license mount plate slots.

**VT No. Finish**

**33-2160** Chrome

**33-2152** Black

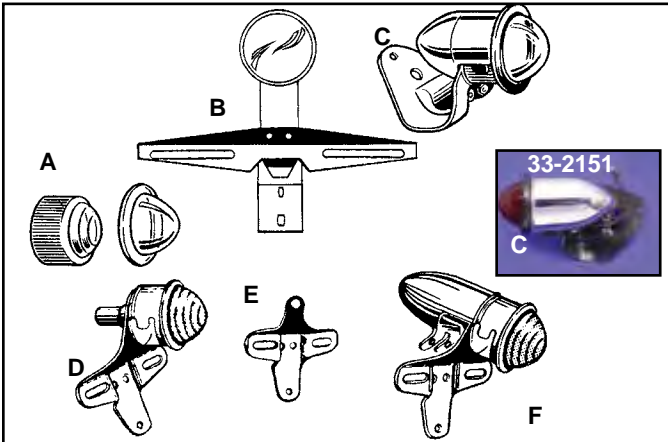

**Early Tail Lamps and Parts.** All complete lamps include glass lenses and bulb socket. **Note:** Lenses are in glass.

VT No.	#	OEM	Year
33-1521	A	—	1924-27
33-2154	A	68092-25	1935-38
		68091-20	Lens Set
15-0582			1925-38 Gasket Set, Round Style
15-0719		68126-36	Gasket
15-0718		68125-25	Gasket
33-2147		68105-20	Lens Ring
33-2150	B		Complete 1915-33, dual
33-3034			Tail Lamp Complete, faceted
33-2151	C		K Tail Lamp 1952-54 Kit with Chrome Hood
31-0237		59991-52	1952-54 K License Plate Bracket
33-2174	D		Complete 1934-38 Complete VL, Single
33-2152	D		Complete 1934-38 Complete VL, Dual
33-2177	D		Complete As Above with Chrome Cup
49-2545	E	—	1934-38 Bracket Only
33-2160	F		Complete 1947-55 Hummer with Chrome Hood
33-0972			Clear Cup Lens
33-1951			Morse Nut



**Bracket** for vintage sconce tail lamp assembly. Fits 1999-up FXD and XL.

**VT No. 31-0594**

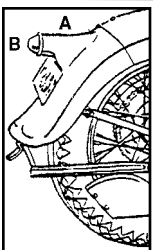

**1934-38 Tail Lamp & Shroud.** Shroud must be welded to fender, tail lamp bolts on underneath. Order separately.

**VT No. # Item**

**49-2589** A Shroud

**33-2152** B Complete Tail Lamp



**Beehive Tail Lamp** bracket included as on 1939-46 models, for decorative use only, not D.O.T. approved. 33-0740 steel lamp has a glass lens, but does not include a 31-9998 bracket.

VT No.	Item	Type	Lens
33-0304	Complete	Chrome	Plastic
33-0980	Complete	Chrome	Glass
33-0950	Replica	Chrome	Plastic
33-0735	Replica	Black	Plastic
33-0740*	Replica	Black	Glass

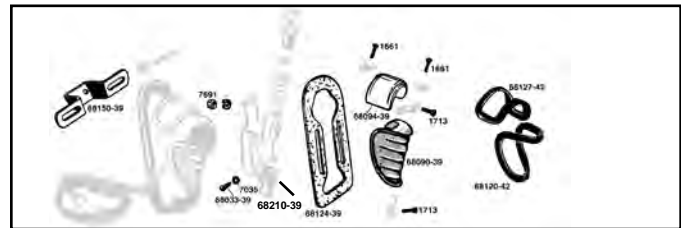

**Parts for 1939-48 Beehive Tail Lamp** available separately.

VT No.	OEM	Item	Type
33-1987	68094-39	Top Lens	Plastic
33-1988	68090-39	Red Lens	Plastic
33-2051	68094-39	Top Lens	Glass
33-2052	68090-39	Red Lens	Glass
15-0667	68127-42	Top Lens	Gasket
15-1330	68120-42	Red Lens	Gasket
31-0401	68150-39	Bracket	Chrome
31-9998	68150-39	Bracket	Parkerized
9813-12	68033-39	Mount Bolt Kit	Parkerized
15-0325	5056-39	Mount Gasket	Paper
15-0291	5056-39	Mount Gasket	Rubber
32-0959		Cloth Wire	Assembly
32-9307		Cloth Wire	Assembly
33-1336		Kit	Lens
33-2256	68210-39	Lamp Base	

**Beehive Tail Lamp Mounting Kit** for 1936-46. Screws also fit 1936-38 dash cover.

**VT No. 9813-12**

Lamps listed are for show or decorative use only, not D.O.T. approved.

# 1955-72 Tail Lamp and Plate Holder



33-0300



33-0299



33-1949



33-1916

"Stop" Tail Lamp Round Style as used on early bobbers.

- VT No. Item**  
**33-1950** Kit, Bulb  
**33-3039** Kit, LED  
**33-1949** Lamp  
**33-1346** Lamp LED  
**33-1916** Lens Kit

**Stock Type Tail Lamp** fits 1955-72 FL-XL models, includes lens housing and internals, complete.

- VT No. Item**  
**33-0300** Chrome Complete Lamp  
**33-0299** Primer Complete Lamp  
**33-0838** Chrome with Blue Dot  
**15-0209** Fender Gasket (Rubber)  
**15-0322** Fender Gasket (Foam)  
**15-0760** Fender Gasket (Sponge)  
**15-0301** Lens Gasket, 5 pack  
**33-1963** Red Lens Glass  
**33-0504** Red Plastic Lens  
**33-0519** Blue Dot Red Plastic Lens  
**33-1964** Chrome Rim  
**33-0530** Clear Top Lens only, 1969-72  
**15-0302** Top Lens Gasket



33-0838



33-0519



33-1949

31-0874



33-1949

"Stop" Tail Lamp Round Style as used on early bobbers.

- VT No. Item**  
**33-1949** Lamp, bulb  
**33-1346** Lamp, LED  
**33-1324** LED  
**31-0874** Fender Mount Bracket  
**33-3055** LED



**Blue Dot Tail Lamp.** VT No. 33-1435



**Lens and Rim Kit** includes two (2) screws, chrome rim, lens gasket and red lens. Fits 1955-72.

VT No. 33-0550



**Chrome Tail Lamp and License Plate Bracket Kit** use on all 1955-72 FL-XL models.

VT No. 33-1955



**Chrome Tail Lamp Visor** shown installed on VT No. 33-0300 lamp. Fits 1955-72.

VT No. 42-0206



**Blue Dots** feature plastic dots with rim.

- VT No. Rim**  
**33-0283** Chrome  
**33-0509** Gold



33-3055

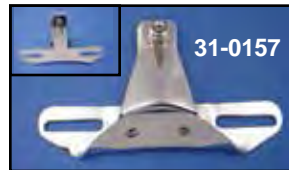

31-0157



31-0158

**License Plate Brackets** for fender mounting.

Chrome	Black	Years	Type
31-0157	31-0476	1955-72	2 Bolt
31-0158	31-0086	1973-up	3 Bolt

Tail Lamps/HeadLamps listed are for show or decorative use only, and not D.O.T. approved.

## Replica Glass Lens

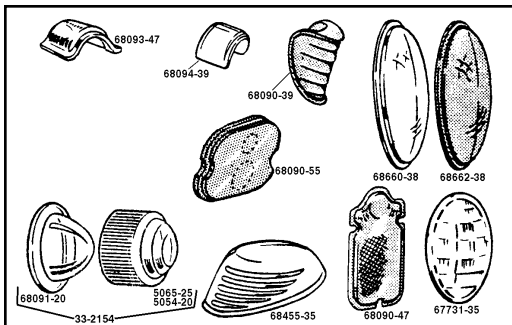

33-1963

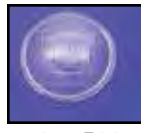

49-2511



33-2154



33-1942



33-1047



33-1942 Installed



33-0502

**Replica Glass Lens** for antique applications, for show use only, not D.O.T. approved.

VT No.	OEM	Year	Type	Use
33-2154	68091-20	1935-38	Red	Rear
	68092-25	1935-38	Clear	Rear
33-2051	68094-39	1939-46	Clear	Rear
33-2052	68090-39	1939-46	Red	Rear
33-0502	68090-47	1947-54	Red	Rear
33-2124	68093-47	1947-54	Clear	Rear
33-1963	68090-55	1955-68	Red	Rear
33-2125	68455-35	1935-66	Frosted	Front
49-2511	67731-35	1935-47	Clear	Head Lamp Replica
49-0923	67731-35	1935-47	Clear	Head Lamp
33-1222	68660-38	1938-62	Clear	Spot
33-2002	68662-38	1936-62	Red	Spot
33-1942	—	1935-38	Red	Rear
33-0972	—	1925-38	Clear Cup	
33-1402	—	1935-38	Red	Lens Rear
33-1047	—	1920-34	Red	Lens

**Warranty**  
 All Lighting (Headlights, Tail Lamps, Signals, Spot Lamp, Marker) sold as individual pieces or in kits are covered under our warranty "Replacement Only" Provision. All item part numbers begin with a 33 prefix. No credit will be issued for these items as they are exchange only.

MULTI FIT/CHOPPER





# Stock Tail Lamp

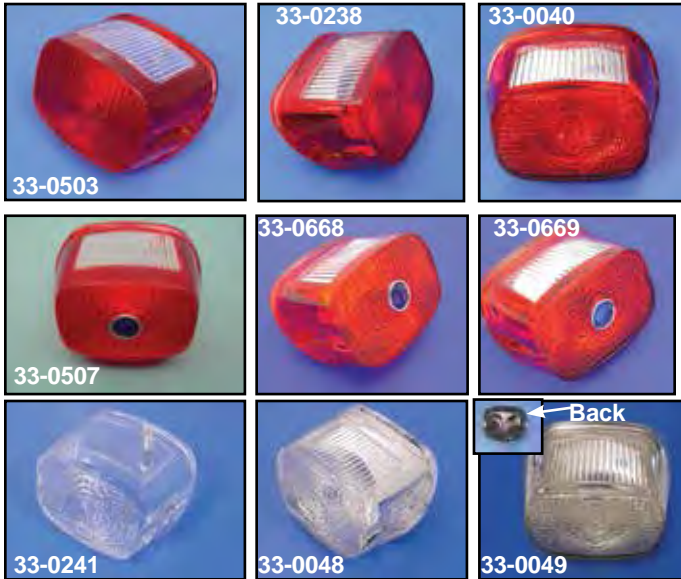

Lens are red, clear or red with a blue dot installed.

Stock	Dot	Clear	Type
33-0503	33-0507	33-0241	1973-98 Big Twin 1973-98 XL-FXD
33-0238	33-0668	33-0048	1999-E03 FXST, FLT, XL, FXD
33-0040	33-0669	33-0049	L2003-04 FXST-FLT-XL-FXD accepts wedge bulb

**Caution: Blue dot lens may not be approved for use in your state.**

**Chrome Lens Grill** available as lens with blue dot and grill assembled or as grill only for 1973-up.

VT No.	Type	Style
33-2021	With Dot	V
33-2020	Grill only	V
33-0109	Grill	Slot



33-0624  
Installed



**Radii LED Tail Lamp** fits FXD-FX models. Includes clear LED's for license plate illumination. Fits 1973-98.  
VT No 33-0624



**Deco Style Lay-Down Tail Lamp Assembly** fits in stock location.

VT No.	Year
33-0335	1973-98
33-0336*	1999-up
31-0594	1999-up Bracket Only

\*Note: Requires wiring harness modification

Lens Screws are available in 10 pack.

VT No.	Year	Use
12-2520	1973-98	Tail Lamp
12-0590	1999-up	Tail Lamp
12-2526	1939-72	Tail Lamp
12-2521	1973-85	Signals



**1973-up FX-FL-XL Tail Lamp** includes chrome base, lens, wire and bulb. Utilizes 12-0575 speed nuts for mounting as stock.

VT No.	Item	Type
33-0301	Complete Lamp 1973-92	Bulb
33-0029	Complete	LED



**Chrome Tail Lamp** with red LED.

VT No.	Year	Lens
33-1531	1999-up	Lamp, Red
33-1549	1999-up	Lamp, Smoke



42-0216

42-9966

42-0000

42-0000  
Installed



**Chrome Tail Lamp Visors** for 1973-up units in plain and louvered for FX models, FXST-FXWG fits with inverted light.

VT No.	Model	Type
42-0216	FX	Smooth
42-9966	FX	Louvered
42-0000	FXST	Smooth

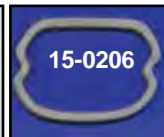

**Tail Lamp Hardware and Gasket.**

VT No.	Item	Fits
12-2520	Lens Screw	1973-up Big Twin and 1973-98 XL
15-0206	Lens Gasket	1973-89 All Twin
12-0575	Mount Nuts	1973-up Big Twin and 1973-98 XL
15-0207	Beaded Rubber Base Gasket	1973-up Big Twin and 1973-98 XL

Lamps listed are for show or decorative use only, and not D.O.T. approved.

**Laydown Tail Lamp Lenses** matches the rear angle of saddlebags and fender. Also works well with laydown type license plate mounts. Feature original type or horizontal slim lens optics design for a sleek look. Available in red, red with blue dot, clear or smoke and either up, down or no license plate windows.

# Lens



## Original Lens



Red facing up



Red with blue dot facing up



Clear facing up



Smoke facing up



Clear facing down



Smoke facing down



Red facing down



Red w/blue dot facing down

Lens Color	License Lens Facing	Fit 1973-98 models		Fits 1999-Early 2003		Fits Late 2003-08	
		Original	Horizontal Slim	Original	Horizontal Slim	Original	Horizontal Slim
Red	up	33-1150	33-0247	33-1157	33-0239		33-0254
	down	33-1151	33-0258	33-1158	33-0257		33-0256
Red with blue dot	up	33-1152	33-0248	33-1159	33-0240	33-1165	33-1170
	down	33-1153	33-0249	33-1160	33-0252	33-1166	33-1171
Clear	up	33-0246	33-0242	33-1161	33-0250	33-1167	33-0253
	down	33-1154	33-1155	33-1162	33-0251	33-1168	33-0255
Smoke	up	—	33-1156	—	33-0929	—	33-0933
	down	—	—	—	—	33-1169	—



**Horizontal Slim Lens without license lens**  
**Lens Color** 1999-Early 03 Late 2003-07  
**Red** 33-0930 33-0935  
**Clear** 33-0931 33-0934  
**Smoke** 33-0932 33-0936



**LED Laydown Tail Lamp Assembly.** Fit 1999-up FLT only.

VT No.	Lens Color	Tail Lamp
33-1603	Red	Up
33-1604	Red	Down
33-1605	Smoked	Up
33-1606	Smoked	Down



**Smooth Tail Lamp Lens** fit 2000-up FXSTD & 2002-up V-Rod.

**VT No. Color**  
**33-0869** Clear  
**33-0870** Smoke



**Lay Back Tail Lamp Lens** with LED internals.

**VT No. Color**  
**33-0831** Clear  
**33-0832** Red  
**33-0833** Smoke





Rotating type features LED's that rotate and reverse direction every two seconds and when brake light is activated the LED's pulse 2 two times per second.



LED Bulb is not affected by vibration for long life. Available in 1157 (brake and tail lamp) or 1156 (signal lamp) types.

VT No.	Volt	Color	Type
33-0158	12	Red	Brake
33-1292	6V	Red	Brake
33-0165	1157 Rotator	Red	Brake
33-0168	12V	Amber	Brake
33-0188	12V	Amber	Brake (5 pack)



**Tail Lamp Bulb for 2004-up** is the push in wedge style to replace 3157.

VT No.	Type	Qty
33-0194	Stock	10 pack
33-0195	LED	Each

## 12 Volt Bulbs, filament type

VT No.	OEM	Description
33-0116	68727-64	4½" Spotlamp Seal Beam Red Clear, Single Filament
33-0297		4½" Spotlamp Seal Beam, Single Filament amber, bulb with clear smooth lens
33-0161		4½" Spotlamp Seal Beam, Single Filament Two prong screw type with fluted lens with a 30 watt bulb
33-1980		4½" Spotlamp Bulb, Early Single Function
33-0153		4½" Seal Beam for Round Headlamp 35w
33-0134	53439-79	Speedo Tach, 84-up FXR, 83-up FX Hi Beam Indicator
33-0137	68024-94	1994-up Speedo and Indicator Lamp
33-0131	68165-64	Brake and Tail Lamp
33-0056	68165-64	2 filament
33-0138		For 33-0408 Front Fender Light, 65-up FL
33-0136		Turn Signal Indicator, 84-up FXST, 80-up FXWG, 1971-72 FX, 1965-up FL Bullet Light
33-1971		Bullet, dual filament w/offset mounting pins
33-1982		As Above with inline mounting pins
33-1913		Mini Bulb for Mini-gauge
33-2047		Directional for Turn Signal, Single
33-0170	68572-64A	Directional for Turn Signal, Dual
33-1958	71099-74	Speedo 71-72 FX, 84-up FXST, 80-up FXWG,
33-0133	71090-64	Hi Beam Mini Indicator, 75-up XL, 65-up FL Speedo, 73-82 Speedo
33-0135	71092-68A	Hi-beam Mini Bulb, 83-up FLH, 84-up FXST, 80-up FXWG, 73-up FX Speed
33-0138	71099-74	Tachometer, 74-up All FX, Hi beam indicator. Bates Style Headlamp

## LED Tail Lamp Bulb



**Lazer LED Bulb** features colored LEDs with clear band for license plate. \*Note: Does include clear band for license plate.

Flux	VT No.	Type	Fit	Year	Color
33-1266	33-0207*	1157	Tail-Brake	1965-02	Red
33-1267		1157	Tail Lamp	1965-02	Clear
	33-0208	1156	Signal	1965-up	Amber
33-1268	33-0219*	3157	Tail-Brake	2004-up	Red
33-1269		3157	Tail Lamp	2004-up	Clear



Lamp Shape

	Lollypop	OEM	Color	Type
33-0211	33-0169	1156	Amber	Turn Signal
33-0212	33-0193	1157	Red	Tail Lamp



**LED Valve Stem Cover Cap Set** includes battery.

VT No.	Color
33-0944	Blue
33-0946	Red

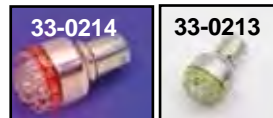

**LED Turn Signal Bulb.**

VT No.	OEM	Color
33-0214	1156	Red
33-0213	1156	Amber



**12V Halogen Tail Lamp Bulb.** Extra bright with stop and tail lamp.  
VT No. 33-2105

## Tail Lamp Wire



**Tail Lamp Connector** includes wire harness to be spliced to replacement.

VT No.	Type
32-0491	Deutsch
32-0944	6 Pin Amp

**PVC Covered Tail Lamp Wires** fit 1970-up.

32-9309	1970-72 FL, 1971-72 FX, 1973-77 FL
32-9310	1973-77 FX-FXE
32-9311	1978-84 FL
32-9313	1978-84 FX-FXE
32-9331	1987-90 ST
32-9336	1991-95 ST
32-0486	1996-up ST

**Tail Lamps Wires.** Cotton Braided Wires

32-9306	1936-47	All
32-9307	1948-69	All
32-7553	1934-69	Servi-car and Sidecar







# License Plate Frame



**Billet License Plate Frames** with milled accent.  
**VT No. Type**  
42-0974 No Mount Holes  
42-0998 With Mount Holes



**Billet Spade License Plate Mount** will attach to 3 bolt holes stock rear fender.  
**VT No. 42-0986**



**Billet License Plate Frame** with hidden mount.  
**VT No. Type**  
42-0949 Smooth  
42-0164 4 Point  
42-0997 6 Point

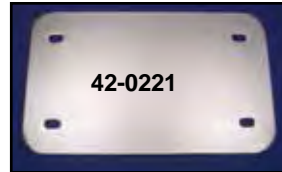

**Chrome License Plate Backing Plates.**  
**VT No. Type**  
42-0213 Smooth  
42-0031 Louvered



**Chrome License Plate Frame with Side Lights.**  
**VT No. 33-0323**

**Large Plate Frame.**

**VT No. Type**  
42-0221 Backing Plate, (4 $\frac{3}{4}$ " x 8")  
42-0153 Frame, (4 $\frac{1}{2}$ " x 8")  
42-0976 Frame, Billet (4 $\frac{1}{2}$ " x 8")

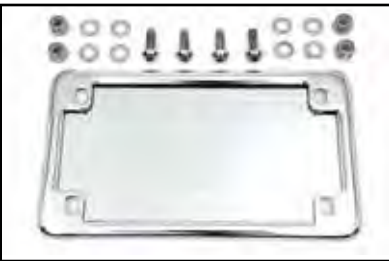

**Chrome Frame and Plate Set** fits 7 $\frac{1}{4}$ " x 4" plates.  
**VT No. 42-0066**



**Fender Mount License Plate Holder** with clear LEDs.  
**VT No. 42-1525**

# License Plate and Tail Lamp Holder



**Chrome Tail Lamp and License Plate Holder** are constructed of steel, chromed for 7 $\frac{1}{4}$ " x 4" plate size except as noted.

**VT No. Type**

31-0173 Lucas and Cat Eye

31-0637 Lucas (5" x 7")

31-0632 Lucas (Recessed)

31-0631 Cateye (Recessed)

31-0605 Maltese (Recessed)

31-0309 Maltese (Horizontal)

31-0711 Maltese (Vertical)

31-0872 Cateye (Vertical)

31-0175 Side mount bracket

31-0634 Side mount bracket





# License Plate Frame

All Frames fit standard 4" x 7" size unless noted.



License Plate Frame.	VT No.	Finish	Style	VT No.	Finish	Style
	42-0210	Chrome	Plain	42-1060	Chrome	Chain
	42-0271	Black	Plain	42-9971	Chrome	Eagle Spirit
	42-0211	Chrome	Plain	42-9972	Gold Inlay	Eagle Spirit
	42-0061	Gold Inlay	Live to Ride	42-1037	Chrome	Flying Eagle
	42-0062	Chrome	Live to Ride	42-1067	Chrome	Viper
	42-0063	Chrome	Tubular	42-1068	Chrome	Skull
	42-1070	Chrome	Skull	42-1070	Chrome	Skull
	42-1071	Chrome	Chain	42-0163	Chrome	Indian
	42-1574	Chrome	Flame	42-5046	Stainless	Round
	42-1575	Chrome	Maltese	42-1574	Chrome	Flame
	42-1576	Chrome	Smooth	42-1575	Chrome	Maltese
				42-1576	Chrome	Smooth

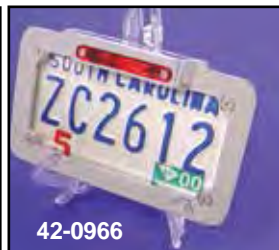

**Chrome Billet License Frame** with red LED top lamp.

VT No.	Type
42-0923	Brake/Tail Lamp Combo with 3 wires
42-0966	Brake/Tail Lamp Combo with 3 wires
42-1007	Tail Lamp Only with 1 wire



**License Plate Auxilliary Lamp.** VT No. 33-0086

**Chrome License Plate Brackets** for fender mounting.

VT No.	OEM	Years	Type
31-0157	59995-55A	1955-72	2 Bolt
31-0476	As Above	Black Finish	
31-0158	59983-75	1973-up	3 Bolt





# Lay Down License Plate Holder

All Frames fit standard 4" x 7" size unless noted.



Large tombstone covers stock tail lamp cutout, VT No. 33-0333



**Chrome Lay Down License Plate Bracket** features faceted back shape to allow for countersunk mount holes.

VT No. 31-0627



31-0773

**Curved Billet License Plate Mounts** mount to stock with hidden screws. Mounts to 3 hole tag mount on stock fenders. Billet style with surface screws.

VT No. 31-0773



**Chrome Mini License Lamp** is stud mount style, each.

VT No. Length  
33-0978 1 3/4"  
33-0983 3/4"



33-1535



33-1536



33-1537

**Mini LED Lights with M6-P1.0 threaded stud.**

VT No. Type  
33-1535 Pointed  
33-1536 Domed  
33-1537 Socket



Installed

**Chrome Fender Mount License Plate Bracket Kit.** Includes a rubber anti-vibration block to cushion it against fender. Replaces stock three piece unit, bolts to same three holes, and uses light from stock tail lamp.

VT No. 31-3943



33-0348

**Deco Style Lay Down Tail Lamp and License Plate Mount Kit** includes complete lamp and die cast plate holder with rubber mount block mounts to FX-FXD models.

VT No. Type  
33-0348 1973-98  
33-0349 1999-up



**Black License Plate Blank** is 4" x 7". Topper sold separately.

VT No. 42-0019



**Chrome Layback License Plate Mounting Kit** bolts to stock license plate mounting holes on rear fender for models listed. Fits 7 1/4" x 4 1/4" license plates. Fits 1999-up FXD.

VT No. 31-4077



33-1080

33-1083

33-1081

33-1082

**LED Indicator Lamp Sets** sold in set of 4. All 2 wire type for panel mounting.

3 mm	6 mm	Color
33-1812	33-1080	Red
33-1813	33-1081	Green
33-1814	33-1082	Blue
33-1815	33-1083	Orange



**Curved License Plate Bracket** mounts to three hole tag mount on stock fenders.

VT No. 42-1009

Lamps listed are for show or decorative use only, and not D.O.T. approved.

# License Plate Reflectors

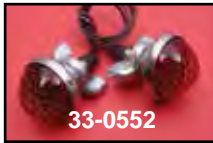

**33-2063**  
Installed



**33-0553**  
Installed



**33-2064**  
Installed

**Jewel Glass License Plate Bolt Set** features 1" outside diameter stainless bezel with a 12V lighted red faceted glass lens, sold in pairs.

**VT No. Color**

- 33-0552** Red
- 33-0553** Amber
- 33-0554** Green
- 33-0555** Blue

**Krommet-Light Studs.** 12 volt mini lamps with krommet base to attach license plates and accessories. Set of 4.

- |                |              |
|----------------|--------------|
| <b>VT No.</b>  | <b>Color</b> |
| <b>33-2062</b> | Amber        |
| <b>33-2063</b> | Red          |
| <b>33-2064</b> | Blue         |



**Glass License Plate Reflector Sets.** Real Glass! Original faceted style.

Reflector	LED 12V	Color
<b>37-1964</b>	<b>37-1428</b>	Red
<b>37-2102</b>	<b>37-1429</b>	Amber
<b>37-2103</b>	<b>37-1430</b>	Blue
<b>37-2104</b>	<b>37-1431</b>	Green
<b>37-2105</b>	<b>37-2107</b>	Purple
<b>37-0044</b>		Hex Body

**Gum Drop Shape Glass License Plate Reflector Sets.** Real Glass!

VT No.	Color
<b>37-0933</b>	Red
<b>37-0934</b>	Amber
<b>37-0935</b>	Green
<b>37-0936</b>	Blue
<b>37-2110</b>	Purple
<b>33-0984</b>	LED

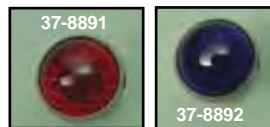

**Real Glass License Plate Reflectors** have 10-24 stud with nuts and washers, sold as pair unless noted.



VT No.	Color
<b>37-8891</b>	Red
<b>37-8892</b>	Blue
<b>37-8893</b>	Green
<b>37-8894</b>	Amber



**33-1258** Installed

**Mount Bolts** feature a LED lamp built in, single wire type with a 8 mm stud for mounting sold in pair unless noted.

VT No.	Color
<b>33-1255</b>	Red
<b>33-1256</b>	Blue
<b>33-1257</b>	Green
<b>33-1258</b>	Amber
<b>33-1403</b>	Clear LED





# License Plate Bolt

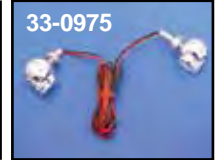

### License Bolt Set.

- |               |                |
|---------------|----------------|
| <b>VT No.</b> | <b>Style</b>   |
| 37-1960       | Skull          |
| 48-1624       | Skull Brass    |
| 48-1625       | Skull Polished |
| 48-1629       | Skull LED      |



**Chrome Maltese License Plate Mount Bolt Set** features 1/4 x 20 Nyloc nuts.  
**VT No. 37-1958**

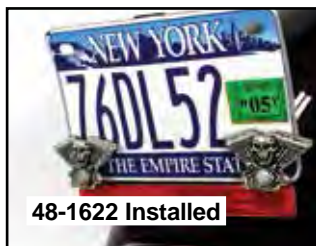

### Large Krommet Sets

- |               |             |
|---------------|-------------|
| <b>VT No.</b> | <b>Type</b> |
| 48-1622       | Skull/Motor |
| 48-1620       | Skull       |
| 48-1621       | Skull/Star  |



**Skull Krommets** feature LED eyes, pair.

- |                    |              |
|--------------------|--------------|
| <b>VT No.</b>      | <b>Color</b> |
| 33-0856            | Amber        |
| 33-0857            | Red          |
| 33-0975            | Red          |
| <b>Without LED</b> |              |
| 37-9076            | Chrome       |
| 37-9077            | Gold         |



**License Plate Mounting Hardware Kit** includes chrome plated rubber insulators to reduce vibration.

- |               |              |
|---------------|--------------|
| <b>VT No.</b> | <b>Item</b>  |
| 7815-4        | Acorn Style  |
| 9871-10       | Custom       |
| 9872-10       | Button Allen |

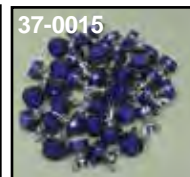

**License Plate Reflectors** for attaching license plate. Available in red or blue.

- |               |              |            |
|---------------|--------------|------------|
| <b>VT No.</b> | <b>Color</b> | <b>Qty</b> |
| 37-0014       | Red          | 40         |
| 37-0015       | Blue         | 40         |

Does soldered a LED into your project backward? It can really mess up a good day! If you don't know, LEDs have a positive side and a negative side, and will only light up when wired correctly. Most LEDs have one longer lead to indicate the polarity, but not all!

## Did you know?

LED lights are polarity sensitive. It is a smart idea to test LED assemblies, is not color coded prior to assembly.

### LED Polarity

Ever soldered a LED into your project backward it can really mess up a good day! If you don't know, LED's have a positive and a negative side, and will only light when wired correctly. Most LED's have one longer lead to indicate the polarity, but not all.

### Warranty

**LED Boards** will be warranted only. No credit will be issued on any lamps or components with the 33 prefix. Lamps will either be exchanged or repaired and returned to the dealer.

This item contains a chemical that is known to cause cancer, or birth defects or other reproductive harm.



# Toppers



37-1967



37-1968



37-1963



37-1971



37-1973



37-9382



33-1607

### Krommets.

- | VT No.  | Type    | Finish         |
|---------|---------|----------------|
| 37-1967 | Maltese | Black, 4 pack  |
| 37-9382 | Maltese | Chrome, set    |
| 37-1968 | Dice    | Chrome, 4 pack |
| 37-1963 | Shield  | Chrome, 2 pack |
| 37-1971 | Pearl   | Chrome, 4 pack |
| 37-1973 | Dollar  | Chrome, 4 pack |
| 33-1607 | Rocket  | Pair           |



### Chrome Skull License Plate Bolt Set. Sold as a pair.

VT No. 48-0923



**Skull Medallion** mounts with an adhesive backing.  
VT No. 37-1953



48-0924

### Skull License Plate Bolt Kit includes two bolts and a wrench.

- | VT No.  | Finish |
|---------|--------|
| 48-0924 | Chrome |
| 48-0927 | Black  |



**Skull Medallion** included 1/4" mounting stud.  
VT No. 37-1532



**World's Fair License Plate Topper Kit** includes 1940 World's Fair topper, blank 4" x 7" steel plate frame bracket, and reflector set.  
VT No. 42-0479



**Silver Dollar Concho Set** features full size 1921 silver dollar faces front and rear.  
VT No. 48-0133



48-1940



42-1743



48-1606

48-1607

48-1608

48-1609



48-1644



48-1618



42-1523

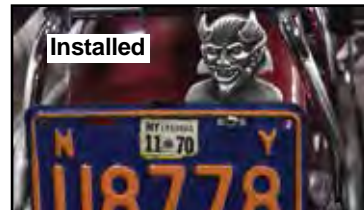

Installed



Installed



48-0840



48-0841

**License Plate Topper** fits New York and other standard size plates.

- | VT No.  | Type   |
|---------|--|
| 48-1940 | World's Fair                                       |
| 42-1743 | World's Fair Topper Kit, includes green reflectors |
| 48-1606 | Route 66   |
| 48-1607 | Devil with red shirt                               |
| 48-1608 | Safety   |
| 48-1609 | Piston   |
| 48-1618 | Safety w/reflector                                 |
| 48-1644 | AMC, brass,  |
| 42-1523 | Devil with red eyes                                |
| 48-0840 | Wing Topper 2"                                     |
| 48-0841 | Devil Ornament 3" x 1/4"                           |

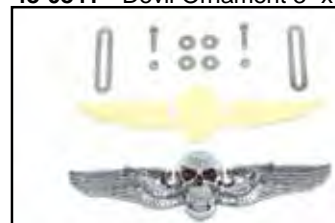

**Skull Wing Topper** with red eyes for auto license plate.  
VT No. 42-1530







# Marker Lamp



**Snake Eye Lamps** deco chrome are 1.75 x 2.25 long, with 1/4" stud mount, sold pairs.

**VT No. Color**  
33-2131 Amber  
33-2132 Red



**Chrome Marker Lamps** features clear lens, includes 12 volt 20 watt halogen bulb. 2 1/4" diameter and 3 3/4" long, pairs.  
**VT No. 33-0580**



**Mini-Square Marker Lamp Set** is 12 volt set with chrome body.  
**VT No. 33-0672**



**Baby Bullet** measure 1 1/8" diameter x 2 1/4" from tip to top with a 5/16" - 18 x 1" long mounting stud and features a glass lens with a chrome body. Sold in pairs.

**VT No. Type**  
33-0440 Red  
33-0441 Amber  
33-0442 Blue



**Mini Speeder Bullet Lamp Set** includes a red lens.

**VT No. Filament**  
33-0629 Single  
33-0665 Dual  
33-0728 Amber Lens



**Evil Eye Marker Lamp Set** with amber LED, and clear lens.  
**VT No. 33-1130**



**Black Missile Light Set**  
**VT No. 33-1334**



**Mini Marker Lamp** feature rounded profile and smooth half moon lenses. They mount to any flat surface single filament lamps. Comes with both amber and red lenses, mounting hardware and rubber base gasket. 1" diameter lens, 3 1/4" overall length.

**VT No. 33-0819**



33-0436



33-0437

**Bullet Lamp** features built in 360° turnable visor, with clear lens and an extra yellow lens, pair, 1 7/8" diameter.

**VT No. Type**  
33-0436 Grooved  
33-0437 Smooth  
33-0143 Bulb Set



33-1003



33-1009

**LED Bullet Lamp Set** measures 1.5" OD x 2.75" long with clear lens and amber LED.

**VT No. Finish**  
33-1003 Chrome  
33-1009 Black



**Clear Bullet Lamp Set** features red LED bulbs. Pair. Includes turn signal load equalizer.  
**VT No. 33-0674**



**LED Arrow Lamps** include clear lens with 28 colored LED units.

**VT No. Color**  
33-0846 Red  
33-0847 Amber



**Black Mini Bullet Lite Set**  
**VT No. 33-3045**

Lamps listed for show or decorative use only, and not D.O.T. approved.



# Marker Lamp

All custom turn signal/lights require load equalizer.



**A** 33-0418



33-0418  
Side View  
Note: Sold Each



**B** 33-0423



**C** 33-0420



33-0420  
Side View  
Note: Sold Each



33-0419



33-0419  
Side View  
Note: Sold Each



33-0421

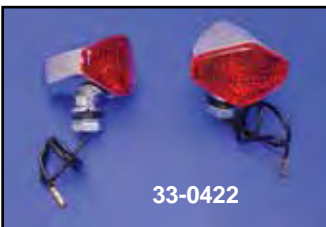

33-0422

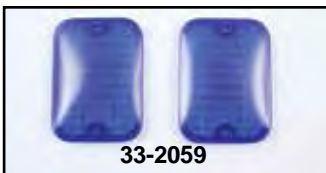

33-2059

**Chrome Die Cast Tour Lamps** available in mini, standard or diamond shape. Wire exits through mount for sanitary mounting. Amber or red, 12 volt.

VT No.	Type	Lens	U/M
33-0418	Standard	Amber (A)	Pair
33-0419	Standard	Red	Pair
33-0420	Mini	Amber (C)	Each
33-0421	Mini	Red	Each
33-0423	Diamond	Amber (B)	Pair
33-0422	Diamond	Red	Pair
33-2059	Standard	Blue Lens	Pair
33-2061	Diamond	Blue Lens	Pair
33-2085	Standard	Amber Lens	Pair
33-2060	Mini	Blue Lens	Pair
33-1131	Mini	Red Lenses	Pair
33-0138	Replacement	Bulb for Above	Pack



**Hot Spot Indicator Lamp Set** feature 12V mini bulb with amber lens.

VT No. 33-0947



33-0682

**LED Micro Lamp Set** features 12V LED units.

VT No.	Color	Lens
33-0683	Red	Clear



33-0274

**LED Center Mount Marker Lamps.** Sold as pairs.

VT No.	Color
33-0271	Amber
33-0272	Green
33-0273	Blue
33-0274	Orange
33-0275	Purple
33-0276	Red
33-0277	Clear



33-0058



33-0059



33-0060

**Universal LED Round Hi-Glide Lamps,** sold each.

VT No.	Size	Color	Lens
33-0058	1.50 D x 2.75L	Amber	Amber
33-0059	1.50 D x 2.55 L	Amber	Clear
33-0060	1.60 D x 3.00 L	Amber, Dual	Clear



**Chrome Pony Lamp Set** measure 2 1/4" L x 3/4" H, single filament with red and amber lens sets.

VT No. 33-0761



33-0761  
Installed



33-1310



33-1311

**Missile Head LED Marker Light Set.** Features a chrome 4" long body and is available with either amber or red lens. Includes 5/16" mounting stud and two wire leads for either running light, brake, light or turn signal use.

VT No.	Lens Color
33-1310	Amber
33-1311	Red

Lamps listed are for show or decorative use only, and not D.O.T. approved.





# Marker Lamp

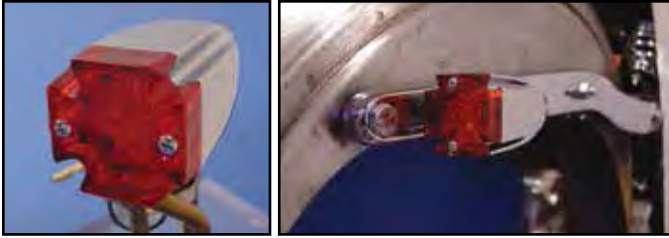

**Maltese Bullet Lamps** feature LED bulbs with red lens. Pair.

VT No. LED  
 33-0675 Amber  
 33-0688 Red

**LED**



**2" Chrome Skull Marker Lamp Set** is for decoration only, lighted eyes.

VT No. Type  
 33-2146 Bulb  
 33-0626 LED



**Chrome Mini Decoration Lamps** is ABS assembly with LED. This light operates by air wind without wiring system.

VT No. Color  
 33-0879 Amber  
 33-0880 Green  
 33-0876 Blue  
 33-0877 Red  
 33-0878 White

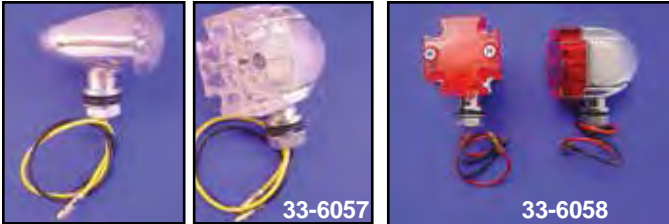

**Mini-Marker Lamp Sets** feature amber bulbs.

VT No. Style Lens LED  
 33-6056 Cat Eye Amber Amber  
 33-6057 Maltese Clear Red  
 33-6058 Maltese Red Red



**Chrome Bullet Lamp Set** includes LED units, body measures 2 1/4" outside diameter x 3 3/4" long.  
 VT No. 33-0763

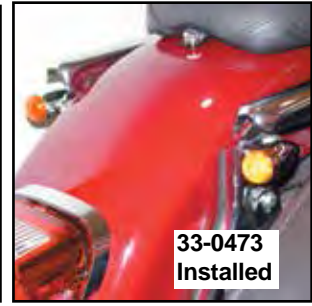

LED Type	Wire	Black Body	Wire	Bulb Type	Wire Color
Chrome Body				Chrome Body	
33-0473	1	33-3044	2	33-0450	1 Amber
33-0474	1	—		33-0451	1 Blue
33-0475	1	33-3047	2	33-0452	1 Red
33-0476	1	33-3048		33-0453	1 Clear
33-0486	2	—	3		Amber
33-1912	3	—			Clear
33-0959		Lens Set		6 pieces	3 Color



**Hyper Lamp Sets** features four choices of lens color; amber, red, smoke and clear. Total of eight pieces of lens.

VT No. Type  
 33-2209 Large  
 33-2212 Mini



**Firefighter Marker Lamp Set** features 3" x 3" red lens with full LED matrix.  
 VT No. 33-0874



**Chrome Maltese Marker Lamps** feature LED design and measure 2.5" x 2.5".

VT No. Item  
 33-0671 Lamp Set  
 33-0679 Mount Bolt Set

Tail Lamps/Headlamps listed are for show or decorative use only, and not D.O.T. approved.



33-2011



33-2012

**Flush Mount Marker Lamps** are die cast and chrome, measuring 3½" L x 1" W x 2¼" D, sold in pairs, mounts to any flat surface with ease. Gasket included.

VT No.	Color
33-2011	Red
33-2012	Amber



33-0446



33-0447



33-0448

**LED Diamond Marker Lamp Sets** feature colored lenses with LED bulb.

VT No.	Color
33-0446	Red
33-0447	Amber
33-0448	Blue



33-1004

**Missile Maker Lamp Set** feature LED construction with stud mounting.

VT No.	Color
33-1004	Red
33-1005	Amber

## Marker Lamp



**Torpedo Lamp Set** measures 4 x 2<sup>5</sup>/<sub>16</sub> body with 12 volt halogen bulb.

VT No.	Item	Type
33-0618	Lamp Set	35W
33-0987	Lamp Set	50W
33-0988	Bulb Set	50W



**Mini Cateye Winker Lamp Set.**

VT No. 33-6493



33-0692

33-0681

Length

**Eagle Eye Lamp Set** features amber lens and billet extension stem.

VT No.	Length
33-0681	2.75"
33-0692	3.75"

Lamps listed are for show or decorative use only, and are not D.O.T. approved.

## Deco Lamp



All custom turn signal/lights require load equalizer.



33-0556

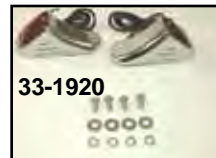

33-1920



33-1056

**Flush Lens Deco Lamp Set.** \*Note: with two sets of lenses, one red set and one amber set, 12V.

VT No.	Item	Lens	Type
33-0556*	Set	Red-Amber	Bulb
33-1920	Set	Red	Bulb
33-1056	Set	Red	Bulb



A



33-2090  
Installed



33-2210



33-2092



33-2093

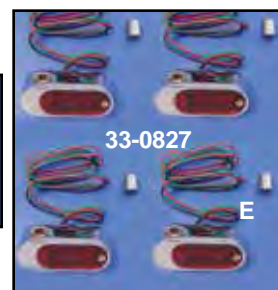

33-0827

**Styler Marker Lamps** are die cast and chrome. Styler Lamp I are 2¾" long 1" wide and 1½" deep. Red lamps have 3/8" mount holes for strut mounting. Amber have 5/16" holes for front fork mounting. Styler Lamp II flush mounts to fender struts or flat surfaces. Pairs.

VT No.	Type	Filament	#
33-2089	Red I	2	A
33-2090	Amber I	1	A
33-2091	Amber I	2	A
33-2092	Red II	1	D
33-2093	Amber II	1	C
33-2210	Amber II	1	C
33-0827	Red	LED	E
33-2094	Bulb 10 pack	1	



33-0065



33-0074

**Universal Skull Billet LED.**

LED marker lamp set is a 3 or 4 wire type for use as a brake light or marker lamp. These can be installed in any flat panel such as saddlebags, tourpaks or fender surface. Features threaded back with aluminum panel mounting nut. Requires a two 1/8" hole for mounting. Sold in pairs.

VT No.	Style	Finish
33-0065	3-Wire	Chrome
33-0074	4-Wire	Red





# Bullet Lamps



**Bullet Lamps.** The original chromed favorites feature metal construction with single bottom stud mounting. Sold each.

Chrome	Black	Type	Wire	Color
33-0400	33-3049	A	1	Amber
33-0966	—	A	2	Amber
33-0968	—	A	3 LED	Amber
33-0967	—	A	2 LED	Red
33-0969	—	A	3 LED	Red
33-0401	—	A	1	Red
33-0433	—	A	1	Amber with visor
33-0320	33-3043	A	2	Red
33-0413	—	B	1	Amber, 3 Fin
33-2005	—	B	1 Amber, 2 Fin	With visor
42-0204	—	D	Visors	Chrome, pair
33-1971	—		12V Bulb	Single, 10 pack
33-1291	—		SMD, Clear	Single, pair
33-1922	—		SMD, Red	Single, pair
33-1923	—		SMD, Amber	Single, pair
33-1970	—		6V Bulb	Single, 10 pack
33-1982	—		12V Bulb	Double, 10 pack
31-0153	—		Chrome	Bracket fits Late Plate Mount
33-2050	—		Bracket	Kit with two 33-0400

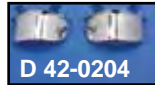

**"Egg" Bullet Lamp with Stem.** Small shape as Grade 'A' egg. Includes amber and red lenses. Pairs.  
VT No. 33-0677



**Shielded Chrome Bullet Lamp Set.** 12 volt.  
VT No. Color  
33-0752 Amber  
33-0753 Red

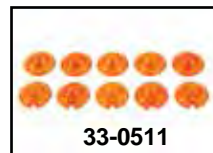
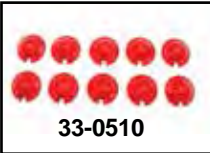

**Plastic Bullet Lamp Lens** sold in pairs or 10 pack.

10 Pack	Pair	Color
33-0510	—	Red
33-0514	33-0572	Green
33-0513	—	Blue
33-0512	33-0574	Clear
33-0511	33-0575	Amber



**Bullet Lamps** feature red lenses, chrome or black body and rim. Type (B) is replica style with brackets riveted on, 68566-50 left, 68567-50 right. Sold in pairs.

Chrome	Black	Style/Filament
33-1976	33-1412	Right & Left/Single
33-0424	33-1411	with stem/Single
33-0425	33-1410	with stem/Dual
33-0677	—	Egg Style
—	33-1414	Bullet Set
—	33-1413	Set with Stem



**Amber Marker Lamp Lens Set** with blue dot bullet style. Sold as pair  
VT No. 33-1975



**Chrome Bullet Lamp Visor** features rim with built in visor to fit standard bullet lamps. Pair.  
VT No. 42-0218



**Chrome Torpedo Style Lamp Set** features 12 volt 50 watt clear halogen single filament bulb and clear lens. Measures 4" X 2 5/16". Mount stud is 1 1/4" x 16 TPI.  
VT No. 33-0987

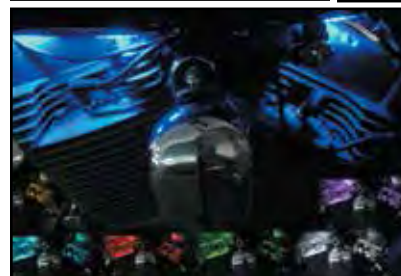

**LED Light Pod Set** features a seven color changeable array by push button switch.  
VT No. Qty  
33-1908 4 Pods  
33-0908 6 Pods  
33-1928 Switch/Control Panel

Lamps listed are for show or decorative use only, and not D.O.T. approved.

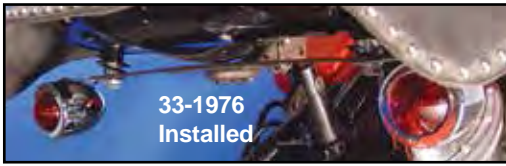

**Red Bullet Lamps with brackets.**  
VT No. 33-1976



33-0145



33-1344

**Chrome Bullet Lamps** feature 1 $\frac{3}{4}$  round lamps with brackets attached. Can be mounted as shown. Units replace 11402-38 with red glass lenses.

VT No. Type  
33-0145 VT  
33-1344 Replica

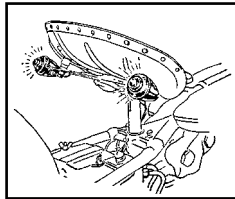

33-1394



33-1405

**Front Bullet Light Set**

VT No. Type  
33-1394 Red  
33-1405 Amber



33-1296



33-1296  
Close Up



33-1298

**Bullet Lamps with Guide Markings.**

VT No. Type  
33-1296 Red DH-49  
33-1298 Amber DH-49  
33-1802 Gasket Kit



**Chrome Bullet Lamp Mounting Kit** includes all hardware to mount bullet type lights on the top fork clamp and rear fender struts on FX. Marker lights sold separately.  
VT No. 31-0202



**Captain America Rear Lamp Kit** includes right and left brackets and 4 red bullet lamps to be wired for brake and tail lamps.

VT No. Item  
31-1206 Bracket Set  
33-0577 Kit

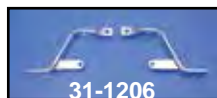

31-1206



**Bullet Lamp Bracket Kit** includes two single filament lamps and a chrome bracket 9 $\frac{1}{2}$ " wide, mounting to license plate bracket.

VT No. Item  
33-2050 Kit  
31-0153 Bracket, Chrome  
31-0389 Bracket, Raw  
33-1394 Red  
33-1405 Amber

## Lamp Bar



42-0421

**Chrome Dresser Lamp Bar** with four bullet lights and license plate backing plate. Mounts on stock FLH or FLT license plate bracket. For 7 $\frac{1}{4}$ " x 8" license plate. Fits 1958-84 FLH.

VT No. 42-0421

VT No. 31-1753 Chrome Step Brackets for Bullet Lights



33-0097



33-1123



48-1478

Guide Patch.  
VT No. 48-1478

## Bullet Lens



33-1285



33-1463



33-1464



33-1465



33-1140



33-1142



33-1141



33-1224



33-1225



33-1226



33-2049



33-1219

OE Style Lens	Bullet	Replica Guide Bullet	Color
33-1285	33-1128	33-1224	Red
33-1463		33-1225	Clear
33-1464		33-1226	White
33-1465	33-1139	33-2049	Amber
33-1140	33-1140		Blue
		33-1219	Cobalt
	33-1142		Purple
	33-1141		Green
33-1123		Bullet Light Gasket Kit	
33-1128		Red Faceted Lens Set	
33-0097		Lens Assortment	





# Marker Light



33-1124



33-1125



33-1126



33-1127



33-1138



33-1137



33-1327



33-1328



33-1329



33-1330



33-1331

**Bates Turn Signal Lamps, pairs.**  
Amber Smoke Red  
Black 33-1125 33-1127 33-1138  
Chrome 33-1124 33-1126 33-1137

**Chrome Mini LED Marker Lamp Set.**

VT No. Lens Color  
33-1327 Amber  
33-1328 Blue  
33-1329 Red  
33-1330 Clear  
33-1331 Set includes amber, blue, clear, and red lenses



33-1337



33-1339



33-1338



33-1340

**LED Turn Signal Lens Conversion.**

Chrome Black Lens  
33-1337 33-1339 Red  
33-1338 33-1340 Amber



33-1045



33-1046

**Bates LED Tail Lamp.**

VT No. Finish  
33-1045 Chrome  
33-1046 Black



**LED Gear Indicator Kit** features a chrome housing and a bright LED display. Kit control module, housing, and wire harness for easy plug and play installation. Fits 2007-up FLT, 2007-11 FXD, 2007-10 FXST, FLST and 2007-up XL models. VT No. 32-0296



**Tail Gunner Light Set**  
Die Cast and Chromed.  
Exact as original  
VT No. Lens Color  
33-1429 Red  
33-1803 Amber



33-1532



33-1534

**Black Die Cast Lamp.**

VT No. Type  
33-1532 Torpedo Bullet Style Marker Lamp Set, Yellow  
33-1534 Rocket Tail Lamp, Red



**Black Bullet Smooth Type Marker Lamp Set** features built in 360° adjustable visor with yellow lens and an extra pair of clear lenses. VT No. 33-0084



# Signal Lamps

All custom turn signal/lights require load equalizer.



33-0479



33-0479

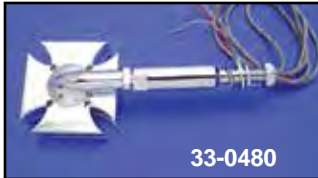

33-0480



33-0480



33-0481



33-0481



33-0482



33-0482

**Maltese LED Lamp Set** sold as pairs w/clear lens.

VT No.	Type	LED
33-0479	Turn Signal with 86mm Short Stud	Red
33-0480	Turn Signal with 96mm Long Stud	Red
33-0481	Turn Signal with 41mm Clamp Kit	Amber
33-0267	Turn Signal with 39mm Clamp Kit	Amber
33-0482	Turn Signal Only	Amber



31-0051



31-0052

**Chrome Turn Signal Relocation Mounts** move turn signal mount location to lower triple tree for a cleaner appearance.

**VT No. Fits**

31-0051 1986-05 FXD, 1986-10 XL

31-0052 2008-10 FXDL, FXDF



**Chrome 49mm Clamp on Signal Kit** with amber lens. Mounts to forks.

**VT No. 33-0904**

### Warranty

All Lighting (Headlight, Taillight, Signal, Spotlamp and Marker) sold as individual pieces or in kits are covered under our warranty "Replacement Only" Provision. All lighting related items part numbers begin with a 33 prefix. No credit will be issued for these items as they are exchange only.



33-0484



33-0485



**Fireman Turn Signal Sets** to fit OE style mounts.  
**Note:** Fork mount types have clear lens, amber LED. Rear stud mount have clear lens with red LED.

**Sold as pairs.**

VT No.	Style	Type
33-0483	Turn Signal Mount	Short Stud
33-0484	Turn Signal Mount	Long Stud
33-0485	Turn Signal Mount	41mm Clamp Kit
33-0268	Turn Signal Mount	39mm Clamp Kit
33-0269	Turn Signal Only	



33-0780



33-0781

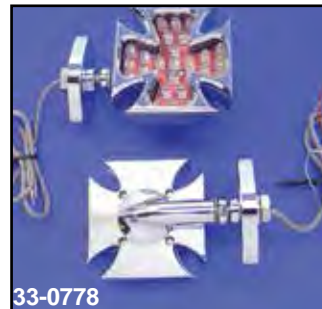

33-0778



33-0781

**Maltese or Squire LED Turn Signals** with mount base.

VT No.	Style	LED
33-0778	Maltese	Amber/Yellow
33-0780	Firefighter	Amber/Yellow
33-0781	Firefighter	Red

MULTI FIT/CHOPPER

Lamps listed are for show or decorative use only and not D.O.T. approved.





# Turn Signal Set



LED Bullet Turn Signal Sets with clear lens.

VT No.	Color	Type
33-4111	Amber with 39mm Fork Clamp	—
33-4112	Amber with 41mm Fork Clamp	—
33-4113	Red with short stud mount	FX-XL
33-4114	Red with long stud mount	FX-XL
33-4115	Amber with headlamp mount	—
33-4116	Amber with stand off mount	FLH
33-4117	Red FL Mount Base	1991-up FXD
33-4118	Amber Swivel Mount	
33-4119	Clear Lens Set	

Lamps listed are for show or decorative use only, and not D.O.T. approved.

## Lamps and Miscellaneous.

VT No.	Item
33-1299	REPLICA GUIDE BULLET MARKER LAMP DHT
33-1533	BULLET MARKER LAMP SET, CHROME
33-2251	1" ROUND TAIL LAMP, RED LENS, BLACK
33-1035	STAR MARKER LAMP SET
33-1011	CHROME TAIL LAMP
33-1095	KNUCKLE TAIL LAMP WITH 4 LED INSERTS
33-1183	LED SPOTLAMP BULB
33-0368	HORIZONTAL SIDE MOUNT TAIL LAMP KIT
33-1108	7" HEADLAMP BULB UNIT, LED



LED Turn Signal Sets for FLT Touring. Front replaces original featuring dual function with smoke lens. Rear has tail lamp and turn signal functions.

Chrome	Black	Item
33-1440	33-1444	Combo Tail/Turn Signal Lamp
33-1441	33-1445	Front Turn Signal, Dual Function
33-1443	33-1446	Rear Turn Signal, Signal Function



LED Revox Bullet Style Turn Signal Lamp Kit fits 1994-2013 FLH, FLT, 1996-UP FLST

Chrome	Black	Lens Color	Fits
33-5001	33-5004	Amber	Front and Rear
33-5002	33-5005	Amber	Front
33-5003	33-5006	Amber	Rear
33-5007	33-5010	Clear	Front and Rear
33-5008	33-5011	Clear	Front
33-5009	33-5012	Clear	Rear
33-5013	33-5016	Smoke	Front and Rear
33-5014	33-5017	Smoke	Front
33-5015	33-5018	Smoke	Rear



Replica Guide Signal Lamp Set.  
VT No. 33-1417

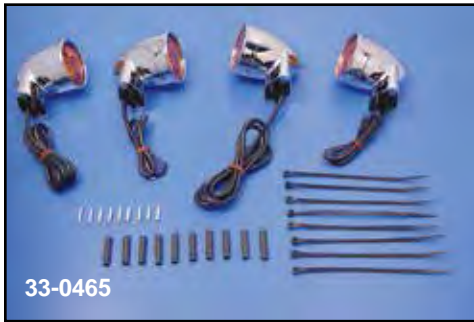

**Turn Signal Lamp Kits** fit 1994-up FLHT and 1996-up FLST. Features an amber lens and a clear bulb.  
**VT No. 33-0465**



**33-0005**



**33-0006**



**33-0007**



**33-0027**



**33-2107**  
for 1963-85 FLH

**Turn Signal Kits** include 4 complete amber assemblies and 2 extra red lenses. 33-2117, 33-2107 include wires for other kits order VT No. 32-0524.

**VT No. Style**

- 33-0006** 1973-85 type, FX
- 33-0005** 1986-up type, FX
- 33-2106** 1986-up type, FLST without hardware
- 33-2117** 1958-73 FLH
- 33-2107** 1974-85 FLH as shown
- 33-0027** 1958-85 Universal FLH Kit
- 33-2200** 2000-up Deuce
- 33-0007** Flat Lens Turn Signal Kit



**33-0592**



**33-0598**



**33-3046**

**Amber Torpedo FXSTD Bullet Signal Lamp.**

VT No. 33-0875 features clear lens with amber LED.

VT No.	Item	Fits	U/M
<b>33-0592</b>	Lamp	Rear	Pair
<b>33-3046</b>	Lamp	Rear	Pair, <b>Note: Black</b>
<b>33-0608</b>	Lamp LED	Rear	Pair
<b>33-0598</b>	With stem	Front	Each
<b>33-0875</b>	Lamp	Front	Pair

# Signal Kit



**33-0150**

**Flat Lens Turn Signal Kit** includes two single filament and two double filament amber lamp assemblies. Fits all 1973-up FX and FXST models. Replaces 68432-95.

**VT No. Item**

- 33-0150** Kit
- 33-2186** Amber Lamp Only Single Filament
- 33-0170** Bulb For Above Lamp



**33-2217**

**33-2223**

**33-2219**

**33-2225**

**33-2221**

**33-2227**



**33-2229**



**33-2233**



**33-2231**

**LED Bullet Signal Set** feature *textured lens*.

VT No.	LED Color	Mount
<b>33-2217</b>	Amber	41mm clamp
<b>33-2219</b>	Amber	Swivel Mount
<b>33-2221</b>	Red	FL Mount
<b>33-2223</b>	Amber	Stand Off Mount
<b>33-2225</b>	Amber	Headlight Mount
<b>33-2227</b>	Red	Lens with Short Stud
<b>33-2229</b>	Amber	39mm clamp
<b>33-2231</b>	Red	Long Stud
<b>33-2233</b>	Amber	49mm clamp

Lamps listed are for show or decorative use only and not D.O.T. approved.





# Turn Signal Lens



## FX Signal Lens.

VT No.	OEM	Color	Years/Model
33-0500	Stock	Red	1973-85 FX
33-0492	With dot	Amber	1973-85 FX
33-1236	With dot	Red	1973-85 FX
33-1220	Stock	Amber	1986-up FX
33-1221	Stock	Red	1986-up FX
33-2203	Stock	Amber	2000-up Deuce
33-2204	Stock	Red	2000-up Deuce

**Smoked Lens Kits** include translucent smoked lens and amber turn signal bulbs which will show amber through lens. Set of 4 lens and 4 amber bulbs.

VT No.	Year	Model
33-1054	1973-85	FX-XL
33-0614	1986-99	FX
	1986-01	XL
33-0615	2000-up	FXST-FXD
		XL
33-0616	86-up	FLST
33-1209		Amber Bulb Set

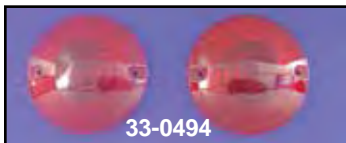

**Chrome Turn Signal Trim Rings** for 1986-up FX-FXR, pairs.  
VT No. 33-1995



**Signal Lens Screw and O-Rings** 10 pack 1986-up.

VT No.	OEM	Item
14-0562	68425-86	O-Ring for Screw, All
14-0548	68451-86	Lens O-Ring, FL
12-1189	68452-86	Screw, All
14-0549	68455-86	Lens O-Ring, FX

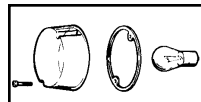
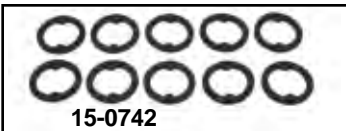

**1973-85 Turn Signal Parts** 10 pack

VT No.	Item
15-0187	Gasket
33-0170	Bulbs
12-2521	Screws

**FLH Signal Lenses** replace stock style.

VT No.	Type	Color	Years
33-0494	Stock	Red	1963-85
33-0495	Stock	Amber	1965-85
33-1974	With dot	Amber	1986-up
33-1965	Stock	Amber	1986-up
33-1978	Stock	Red	1986-up
33-0979	With Skull	Amber	1986-up FLT
15-0742	Stock	Gasket	1963-85
12-1189	Stock	Screw	1986-up



**Chrome Turn Signal Lens Grille Set** fits front or rear turn signals on all 1986-09 FLT and FLST models. Features universal mounting that allows the grilles to be mounted vertically or horizontally.  
VT No. 42-1085



**Chrome Turn Signal Block Off Bevel Style Plates** are used on 1994-up FLTR when front fairing mounted turn signals are removed and relocated.  
VT No. 31-0075

Lamps listed are for show or decorative use only, and not D.O.T. approved.



# Signal Lamp



42-9942  
Installed



42-0199



42-0203



42-9942

**Chrome Turn Signal Visors** order by proper year. Sold in pairs.

VT No.	Years
42-0203	1973-85 FX
42-9925	1963-85 FL
42-9941	1986-up FLT Front
42-9942	1986-up FX
42-0199	1986-up FLT, Front and Rear



42-9925

**Spotlamp  
Rim Set**  
VT No.  
33-0546



VT No. 33-0578



**Frenched Turn Signal Trim Ring Kit** includes chrome plated rings fit front or rear on 1988-up FLT and FLST models.

VT No. 33-0578



**Chrome Die-Cast Turn Signal Visors** feature four mounting bosses that are at right angles to each other permitting the installation of the visors to stock housings in 90° increments. For FL-FLST models from 1986-up with original flat turn signal lenses. Sold in pairs.

VT No. 33-0557

Lamps listed are for show or decorative use only, and not D.O.T. approved.

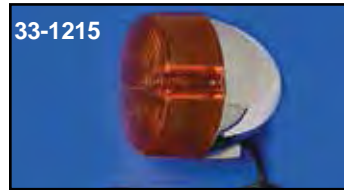

33-1215



33-0412



33-0428

**Chrome FX Turn Signal Assemblies** are an amber replacement turn signal unit. Check factory parts books for the application. Single or dual contacts as noted.

## Front

VT No.	Year	Model	Side
33-0412	1973-E84	FX	Right or Left
	1982-83	FXR	Right or Left
33-1213	As Above	Dual Contact	Right or Left
33-1215	1986-93	FXR	Right or Left
33-1216	1986-up	FXWG	Right or Left
	1986-93	FXRS	Right or Left
33-1227	1987-up	FLST	Left
33-1228	1987-up	FLST	Right
33-0431	1991-00	FXD, FXST	Right or Left
33-0046	2000-up	Deuce FXSTD/FXD	Right or Left
33-0053	2000-up	Deuce FXSTD/FXD (Front)	Right or Left

## Rear

33-0428	1986-93	FXR with Ground Style	Right or Left
33-0411	1986-93	Softail Turn Signal	Right or Left
33-0432	1991-00	FXD, FXST	Right or Left
33-1048	As Above	Dual Contact	Right or Left
33-0053	2000-up	Deuce FXSTD/FXD	Right or Left

**Note:** 33-0412, 33-1216 have threaded body, 33-1215 are unthreaded at mount hole. 33-1215 and 33-1216 are double filament type.



33-2102



33-1232



33-0410

**1964-85 FLH, 1986-up FLT Chrome Turn Signal Assembly** with lens and 12 volt bulb. In either single or dual contacts.

## Front

VT No.	Years	Type	Fits
33-0410	1964-85	Amber, Single	Front and Rear
33-0409	1964-85	Amber, Dual	Front and Rear
33-1232	1964-85	Red, Single	Front and Rear
33-2102	1986-93	Amber, Single	Front and Rear
33-1240	1994-up	Amber, Single	Front
33-1241	1994-up	Amber, Dual	Front

## Rear

33-0410	1964-85	Amber, Single	Rear
33-0409	1964-85	Amber, Dual	Rear
33-1232	1964-85	Red, Single	Rear
33-2101	1986-up	Red, Single	Rear
33-2102	1986-up	Amber, Single	Rear
33-2103	1986-up	Red, Dual	Rear
33-2104	1986-up	Amber, Dual	Rear





# Turn Signal



**Chrome Fork Mount Turn Marker Lamp Set** is a die cast two piece housing with 12 volt bulb, to attach to 35, 39 and 41 mm fork tubes.

VT No.	Type	Bulb	Type
33-0581	Front Panel	Single	Bulb
33-0047	Side Panel	Dual	Bulb

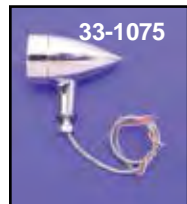

## LED Turn Signal Set.

VT No.	Style
33-1075	Bullet, Amber, each
33-1076	Bullet, Red, each
33-1077	Maltese Amber
33-1070	Bullet, Amber with light mount
33-1071	Bullet Amber with mount base
33-1072	Bullet with 41mm clamp
33-1074	Bullet Red with stud
33-1073	Bullet, Red with long stud



**Chrome Turn Signal Assemblies** are an amber replacement turn signal unit. Check factory parts books for the application. Single or dual contacts.

## Front

VT No.	Filament	Use
33-0412	Single	1973-83-XL
33-1213	Dual	1973-83-XL
33-1215	Dual	1986-93 XL
33-1216	Dual	1986-93 XL1100
33-0431	Single	1994-00 XL
33-0046	Dual	2001-up XL
33-1318	Dual	1994-00, 2 wire
33-1319	Single	1994-00, 1 wire

## Rear

33-0432	Single	1994-01 XL
---------	--------	------------

**Note:** 33-0412, 33-1216 have threaded body, 33-1214 and 33-1215 are unthreaded at mount hole.



**LED Rear Turn Signal Set** fits FLT, FLST models.

VT No.	Type	LED
33-0760	Amber Lens	Clear
33-1279	Clear Lens	Red
33-1280	Clear Lens	Amber

Lamps listed are for show or decorative use only, and not D.O.T. approved.

## Warranty

All Lighting (Headlamp, Tail Lamp, Signal, Spotlamp and Marker) sold as individual pieces or in kits are covered under our warranty "Replacement Only" Provision. All lighting related items part numbers begin with a 33 prefix. No credit will be issued for these items as they are exchange only.



# Bullet Turn Signal Kit

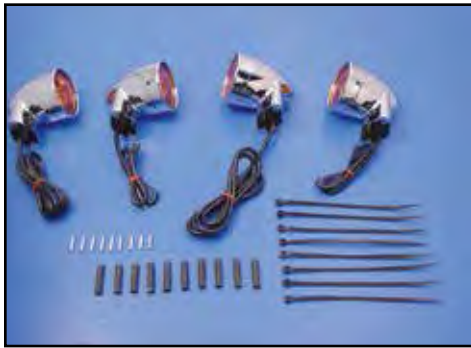

**Turn Signal Lamp Kits** fit 1994-up FLHT and 1996-up FLST. Features an amber lens and a clear bulb.  
**VT No. 33-0465**



**33-0589**



**33-0590**

**Bullet Style Turn Signal Kit** includes housings, lenses and supports. Stock on most 2002 models.

VT No.	Year	Model
<b>33-0589</b>	2000-up	Softail
	1991-01	Dynaglide
<b>33-0590</b>	1988-99	Softail except FLSTC



**Smoked Lens Kits** include translucent smoked lens and amber turn signal bulbs which will show amber through lens. Set of 4 lens and 4 amber bulbs. Fits 2000-up dome bullet type.

**VT No. 33-0615**



**33-0107**

Front

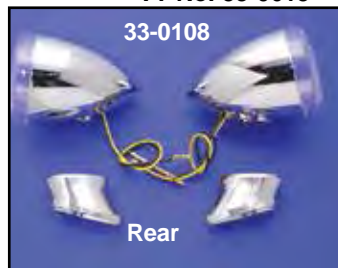

**33-0108**

Rear

**LED Bullet Style Turn Signal Kits.**

VT No.	Fits	Lens	LED
<b>33-0107</b>	Front	Amber	Amber
<b>33-0108</b>	Rear	Amber	Amber
<b>33-0090</b>	Front	Clear	Amber
<b>33-0091</b>	Rear	Clear	Red



**33-0590**

**Amber Torpedo FXSTD Style Bullet Signal Lamp.**

VT No.	Item	Item	U/M
<b>33-0592</b>	Bullet Lamp	Lamp	Pair
<b>33-0608</b>	Bullet LED Lamp	Lamp	Each
<b>33-0598</b>	With Stem Lamp	Lamp	Each
<b>33-3061</b>	Clear Lens	Lens	Pair
<b>33-3062</b>	Amber Lens	Lens	Pair
<b>33-3063</b>	Red Lens	Lens	Pair
<b>33-3064</b>	Smoke Lens	Lens	Pair

**LED**



**33-0757**



**33-0875**

**Bullet Style LED Turn Signal Lamps** fit VRSC models, 2002-up.

VT No.	Item	Type	Wire
<b>33-0757</b>	Rear	Clear	2
<b>33-0875</b>	Front	Clear	3
<b>31-0717</b>	Rear Mounts	Chrome	



**33-0718 Installed**



**Bullet Style Visor Set.**

**VT No. 33-0718**



**33-1270**



**33-1272**



**33-1273**



**33-1274**



**33-1276**



**33-1277**

**Turn Signal Ring** with side view lens fits FXSTD torpedo signal lamps.

VT No.	Color
<b>33-1270</b>	Amber
<b>33-1272</b>	Red
<b>33-1273</b>	Smoke
<b>33-1274</b>	Amber Chrome Mirror
<b>33-1276</b>	Red Chrome Mirror
<b>33-1277</b>	Smoke Chrome Mirror

Lamps listed are for show or decorative use only and not D.O.T. approved.





# Front Signal Mount



**Amber Front Turn Signal Kits** clamp to fork tubes.

VT No.	Slice
33-0913	39mm
33-0914	41mm
33-0904	49mm



**Grooved Billet Fork Clamps.**

Chrome Black	Size
31-0333	41mm
31-0334	39mm
31-0323	49mm
31-0094 31-0092	49mm

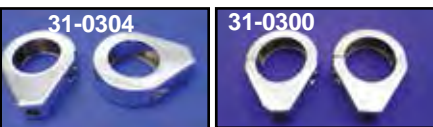

**Chrome Turn Signal Clamp Kits** will mount stock or custom turn signals to fork tubes, pairs.

VT No.	Size	
31-0304	35mm	
31-0300	39mm	8.5mm
31-0345	39mm	10mm
31-0320	41mm	
31-0346	41mm	10mm
31-0347	49mm	
31-1190*	49mm	

\*Note: Black

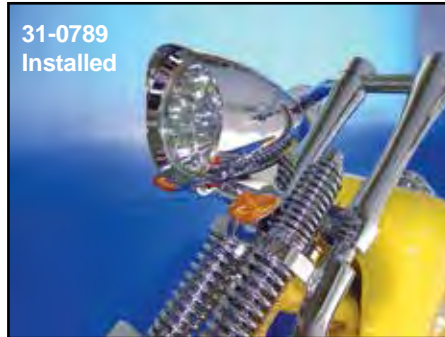

**Front Turn Signal Mount Kit** bolts to Billet headlamp lower mount.

VT No.	Length
31-0788	8.5"
31-0789	5.5"



**Chrome Turn Signal Relocation Mounts** move the turn signal mount location to the lower triple tree for cleaner appearance.

VT No.	Fits
31-0051	1986-05 FXD, 1986-10 XL
31-0052	2008-up FXDL, FXDF

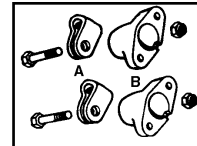

**FLH Turn Lamp Chrome Mounting Kit** for turn signal lights 1968-85, has chrome base, clamp and mounting bolt. Replaces 68518-68. Necessary for mounting turn signal below Spotlamp unit.

VT No.	#	Item
31-0180	A&B	Complete Kit
31-3974	A	Clamps only, pair
31-0266	B	Stanchions only
31-0352	B	Stanchions, Black



**FLH Signal Mounts.** Chrome steel for front or rear use 1963-84. Available pairs.

VT No.	OEM	Type
31-0179	68527-63	Flat
31-0195	68527-63B	90°



**Chrome Turn Signal Mount Set** allows bullet style turn signals to be located under control boxes on bars for XL 1988-03, FXST 1986-up and Dyna 1991-up models. Replaces 68266-03.

VT No. 31-0687



**Chrome Shortie Rear Turn Signal Mounts** fit 1986-up FLST, 1985-up FLT-FLHT-FLHS. Hardware included.

VT No. 31-0421



**Chrome Turn Signal Relocation Kit** will move turn signals to post mounted to top of triple tree. Chrome mount posts wiring and hardware included. Replaces 68517-94A.

VT No. 31-9935



**Clamp Set** will clamp to 1/2" bar for custom mounting.

VT No. 31-0956



# Signal Mount



**Chrome Turn Signal Bracket Set** fits 1997-13 Road King Nacelle models. Mount holes are 6 $\frac{3}{4}$ ".  
**VT No. 31-0964**



**Chrome Turn Signal Swivel Mount Assembly** for 1988-up FXST and 1991-up FXD models.  
**VT No. 31-0582**

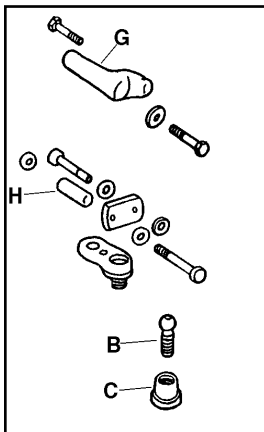

**1988-up Front Signal Mount Parts** for Sportster models.

- | VT No.  | # | Item                    |
|---------|---|-------------------------|
| 31-4067 | B | Ball Stud, 2 pack       |
| 31-0582 | C | Clamp, Ball Stud 2 pack |
| 31-4072 | G | Support, Front, each    |
| 31-4073 | H | Spacer, Front 2 pack    |



**Chrome Short Rear Turn Signal Mounts** move turn signals in 1 $\frac{1}{2}$ " on each side for 1984-98 FXST, 1973-85 FX models, pair.  
**VT No. 31-0554**



31-9913



31-9986



31-9925

**Directional Signal Relocation Kits** includes special hardware and extension for models listed to provide clearance for saddlebags.

VT No.	Fits	Model
31-9913	1979-89	FXR
31-9986	1986-up	FXST
31-9925	1994-03	XL



31-0181



31-0255



31-0163



31-0161



31-0162



31-9979



31-9962

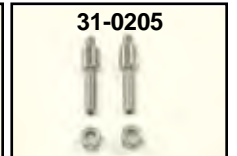

31-0205

**Turn Signal Mounting Hardware** fits models from 1973 to present.

- | VT No.  | Item  |
|---------|---|
| 31-0181 | Bracket fits between turn sign lamp and handlebar clamp |
| 31-0255 | Clamp screw, 2 short, 2 long, four pieces               |
| 31-0163 | Stud kit with spacer                                    |
| 31-0161 | Rear support with screw                                 |
| 31-0479 | 1993-up Bracket with screw, pair                        |
| 31-0162 | Clamp Set, 1973-81                                      |
| 31-9980 | Clamp Set, 1982-up                                      |
| 31-9979 | Rear Turn Signal Stud, each                             |
| 31-9962 | Rear Turn Signal Stud; $\frac{1}{2}$ " shorter          |
| 31-0205 | Rear Turn Signal Stud; $\frac{3}{8}$ " long             |
| 37-0574 | Spacer  |



31-0327



31-0328



37-9095

- | VT No.  | Fits             |
|---------|------------------|
| 31-0327 | FXSTD, Rear      |
| 31-0328 | Softail, Rear    |
| 37-9095 | XL Rear Extended |



**Front Turn Signal Relocation Kits** fits 1996-up FLT.

- | VT No.  | Fits                  |
|---------|-----------------------|
| 31-0353 | With Spot Lamp Bar    |
| 31-0354 | Without Spot Lamp Bar |





# Rear Signal Mount

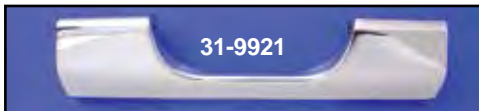
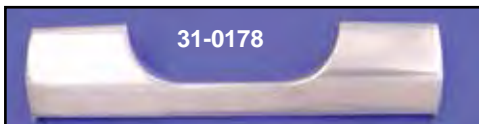
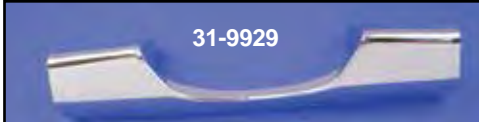
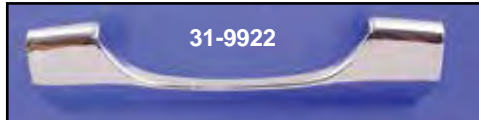
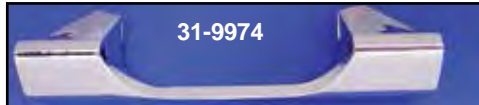
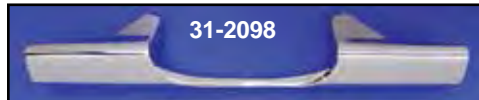
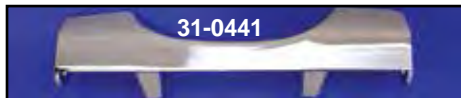
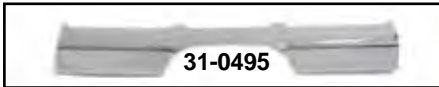
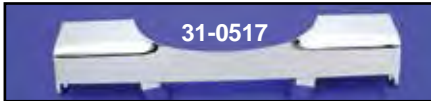
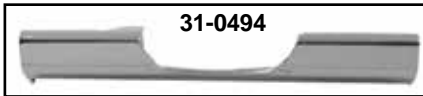

**Chrome Rear Directional Signal Mount Bars.** Die cast construction unless noted as steel.

\*Note: Polish. \*\*Note: Steel

VT No.	Length	Fits
31-0494**	13"	1974-84 FL 1986-up FLST-FSTN-FLSTF
31-0495**	13"	1987-84 FL 1986-91 FLST
31-3987	13"	1985-90 FLHS-FLT
31-4006*	12 <sup>7</sup> / <sub>8</sub> "	1974-84 FLH, 1986-up FLST 1991-up FLT-FLHS-FLHR
31-2098	12 <sup>7</sup> / <sub>8</sub> "	1974-84 FL
31-9929	10"	1974-84 FL, 1986-up FLST, 1991-up FLHR
31-3935	9"	1985-90 FLHS-FLT
31-9974	9"	1974-84 FL, 1986-up FLST, 1991-up FLHR
31-9922	8 <sup>1</sup> / <sub>4</sub> "	1974-84 FL, 1986-up FLST, 1991-up FLHR
31-0441	8 <sup>1</sup> / <sub>4</sub> "	1985-90 FLHS-FLT
31-0517**	8 <sup>3</sup> / <sub>4</sub> "	1974-84 FL, 1986-up FLST, 1991-up FLHR
31-0178*	8 <sup>7</sup> / <sub>8</sub> "	1963-73 FLH
31-9921	8 <sup>7</sup> / <sub>8</sub> "	1963-73 FLH

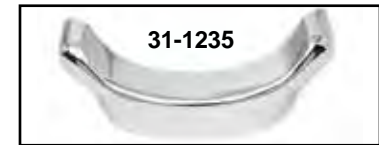
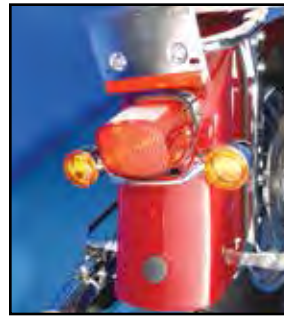

**FLT Chrome Rear Turn Signal Bar** fits 1999-up models.

VT No.	Type
33-1288	LED
33-3035	Bulb
31-0865	Bracket Only
31-1235	Bracket



**4" Shorter Chrome Rear Turn Signal Mount Bar** replaces 68510-74 on FLH, FLST models, is 4" shorter.  
VT No. 31-9922

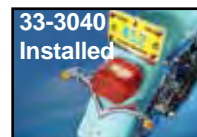

**V-Shape Rear Turn Signal Kit** fits FLST, FXST, FLH, FLT. Includes red/amber LED bulb lamps.

VT No.	Item
33-3040	Kit
33-0762	LED Lamp Set

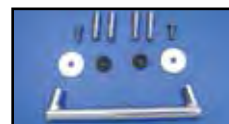

**Chrome Round Signal Bars** include hollow bolts to mount custom turn signals. Fits 1991-04 FLT.  
VT No. 31-0329



**Chrome Low Boyz Turn Signal Bar** replacing 68430-89 and is threaded to accept stock turn signals and mounts to license plate bracket holes.

VT No.	Item	Length	Note:
31-0206	Bar	12"	
31-0776	Bar Kit	7"	
37-0561	End Nuts		
31-1289	Bar Kit	9.72"	
31-0777	Bar	7"	Replacement for 31-0776



**42-0206** Chrome Light Visors designed smartly and are easy-to-install.

**Headlamp** (each)

**VT No. Type**

**42-0200** 7" FLH

**42-0209** 1947-59 Headlight

**42-0201** 5" XL-FX Bates Headlight

**Spotlamp** (pair)

**42-0202** 4" FLH

**33-1316** 4.5" Tech Glide

**Turn Signal** (pair)

**42-0203** 1973-85 FX-XL

**42-9925** 1963-85 FL

**42-9941** 1986-up FLT Front

**42-9942** 1986-up FX-XL

**42-0199** 1986-up FLT, Rear

**Bullet Lamp** (pair)

**42-0204** 1 3/4"

**Tail Lamp** (each)

**42-0205** 1947-54 Tombstone

**42-0206** 1955-72 FL-XL

**42-0216** 1973-up FL-FX-XL

**42-9966** As Above Louvered

**42-0000** FXWG-FXST Tail Lamp

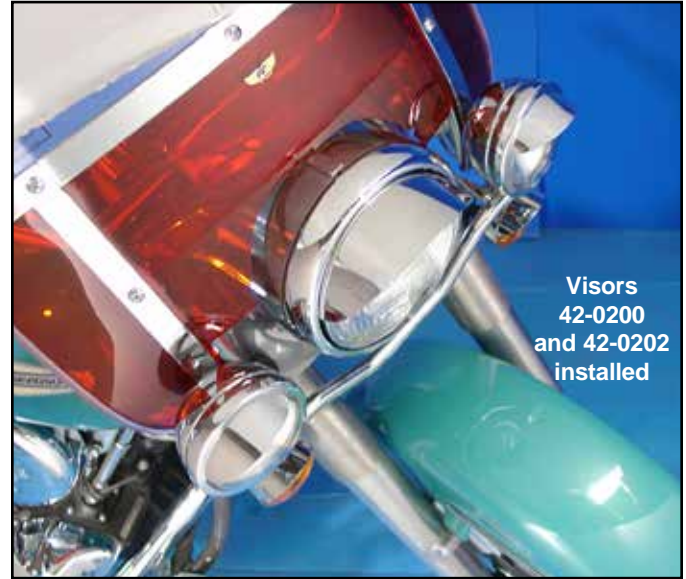

Visors 42-0200 and 42-0202 installed



42-9925 Signal Lamp

## Gaskets

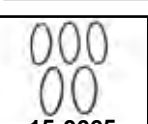
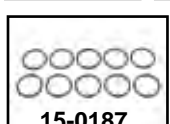
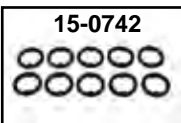
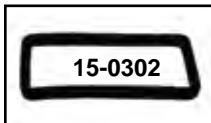
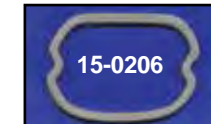
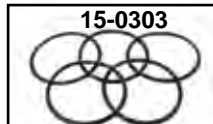

### Turn Signal/Fender Light/ Tail Lamp Gaskets

GB Stock	GB Beaded	Fits
—	<b>15-0289</b>	1968-84 Front Fender Lamp
<b>15-0303</b>	—	1960-84 FL Headlamp Mt Ring
<b>15-0206</b>	—	1973-up Tail Lamp Lens
<b>15-0302</b>	—	1955-72 Tail Lamp Top Lens
<b>15-0301</b>	—	1955-72 Tail Lamp Lens
<b>15-0224</b>	<b>15-0207</b>	1973-up Tail Lamp Mounting
<b>15-0742</b>	—	1968-85 FL Turn Signal Lens
<b>15-0723</b>	—	Front Fender Lamp
<b>15-0187</b>	—	1973-85 FX-XL Turn Signal Lens
—	<b>15-0577</b>	Sport Tail Lamp Mounting
<b>15-0665</b>	—	Cateye Tail Lamp Lens
<b>15-0709</b>	—	Sparto Tail Lamp Mounting

## Visor

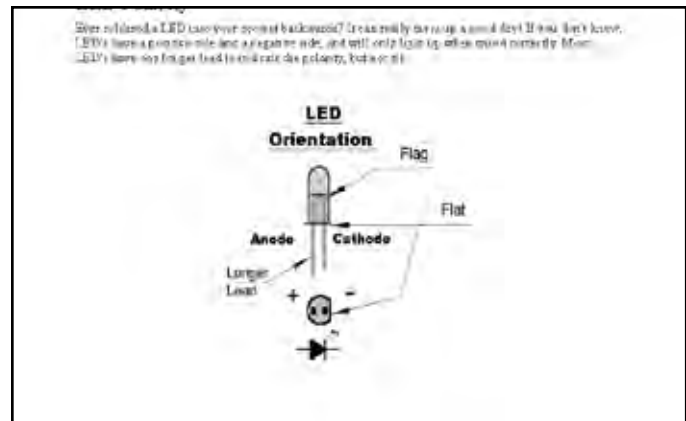

### Did you know?

LED lights are polarity sensitive. It is a smart idea to test LED assemblies, is not color coded prior to assembly.

#### LED Polarity

Ever soldered a LED into your project backward it can really mess up a good day! If you don't know, LED's have a positive and a negative side, and will only light when wired correctly. Most LED's have one longer lead to indicate the polarity, but not all.

#### Warranty

**LED Boards** will be warranted only. No credit will be issued on any lamps or components with the 33 prefix. Lamps will either be exchanged or repaired and returned to the dealer.





# Signal Flasher



33-0399



33-2198



33-2173



33-0398



33-0397

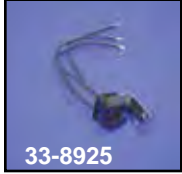

33-8925

Flashers for turn indicator lamps.

VT No.	OEM	Item	Volt	U/M
33-0399	68543-64A	Round	12	Each
33-0848	68543-64A	Round	12	10 pack
33-0916	68543-64C	12V, Round Solid State	12	Each
33-2198	As Above	Rectangle, Replica	12	Each
33-2173	As Above	Rectangle, Plastic	12	Each
33-0398	68543-61A	Round	6	Each

Flasher for hazard or four flashing lights.

33-0397 68541-64 Round 12 Each

Flasher Connector and Mount.

VT No. 32-8925

12 Volt 2 Pin Flasher Units with built in bulb failure indicator.

33-2350 10 Watts

33-2351 21-23 Watts

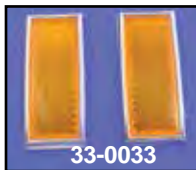

33-0033

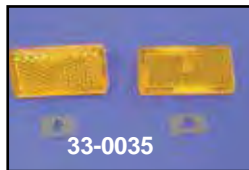

33-0035



33-2097



33-0016



33-0221

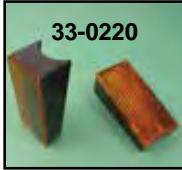

33-0220

Reflectors are adhesive backed OE type, DOT approved.

Sold in pairs.

VT No. Type

33-0033	Front, Amber 1972-up FX-FL Chrome frame
33-0039	Rear Red
33-0035	Front, Amber 1969-71 FL
33-2097	Rear Amber, XL-FX-FL
33-0016	Rear Red 1990-91 XL
33-0221	Rear Red 1992-up XL, FXR 1993-13 FLT
33-0220	Amber Front FXST



32-1542



32-1543

Mini Push Button Switch Kits include 25" colored wires.

Black	Chrome	Button
32-1541	32-1543	Dual
32-1542	32-1544	Single



Wiring Flasher Connector is 3 prong type with mounting bracket riveted on. Flasher connector includes bracket and plug. VT No. 32-0570



Turn Signal Flasher for use with LED turn signals. 2 pin type attaches by tie wrap. VT No. 33-0938



33-0713



33-0816

Illuminator Module allows turn signals to be used as running and brake lights, without losing their turn signal abilities. Features built in load equalizer and works with stock or custom turn signals. Security system compatible.

VT No. Module Type Fits

33-0713	Hardwire	1973-96 All FL, FX; 1973-98 XL and all custom wiring applications without self cancelling turn signals
33-0815	Plug & Play	1986-96 FXST, FXR, FXD, 1986-90 FLT and 1986-90 XL
33-0816	Plug & Play	1997-10 FXST, 1997-13 FLT & 1999-03 XL, 1996-12 FXD
33-0817	Plug & Play	2004-13 XL
33-1192	Plug & Play	1994-96 FLT
33-1193	Plug & Play	1991-93 FLT, 1993-95 FXD
33-1194	Plug & Play	2011-up FXST, FLST, 2012-up FXD
33-1195	Plug & Play	2014-up XL
33-1196	Plug & Play	2014-up FLTR



33-2071

Badlands ATS-03 Self Cancelling Modules are designed to provide a less expensive alternative to the factory flasher module. The ATS-03 module not only has a built in 11-second flasher but it also is a Load Equalizer which allows you to use small incandescent bulbs, halogen bulbs or LED's without any rapid-flashing issues. The ATS-03 also has a 4-way flasher feature for safety or parade mode just like the factory flasher unit. Note: Be sure to identify which connector is on the bike before purchasing as the factory was not consistent during 1994-2000 with connector.

VT No.	Description	Fits
33-2071	Hand-Wire Self Cancelling	Universal on 1973-90 models without self cancelling module on custom bikes
<b>Plug &amp; Play Self Cancelling Modules</b>		
33-2276	Amp Style 6 Pin Plug	1987-93 FLT, 1990-93 FXST 1990-93 FLST, 1990-93 FXD 1990-93 FXR, 1992-93 XL
33-2277	8 Postion Male Deutsch Connector w/Delphi TSM	1994-00 FLT, FXST, FLST, FXD;1997-00 XL
33-2278	8 Postion Female Deutsch Connector w/Delphi TSM	As Above
33-2279	12 pin Deutsch Plug Plug w/Delphi TSM	As Above



# Turn Signal Equalizer



**Intensifier Hi-Low Modules** convert single function LEDs, Halogen or Incandescent bulbs to high and low dual functions (run & stop, run & turn or high and low). Works for tail lamps, signals, marker lamps, rear fender tip, neon accent lighting or driving lights.

### VT No. Application

**33-2215** Single Input/Single Output will run single or multiple driving lights for high and low, single or multiple marker lights for run and stop. Also can do run and turn on a pair of turn signals but 2 units are required. Will run up to 50 watts total for driving lights.

**33-2216** Dual Inputs/Dual Outputs does run and stop or high & low. Does run & turn for a pair of turn signals with one module. Runs up to 100 watts total for driving lights.



**Turn Signal Load Equalizer III** designed to specifically work on all Twins with OEM Alarm System or self cancelling turn signal module. Solid state design works with Halogen or LED signals and eliminates erratic blinking of signals. **All Equalizers** are Plug and Play except 33-2138 and 33-2014 which are hardwire.

### VT No. Brand Fits

**33-2138** Badlands 1988-13 FLT, 1991-10 FXST, 1994-11 Dyna, 1991-03 XL

**32-2014** Volt Tech As Above

**33-2213** Badlands 1997-13 FLH, 1996-10 FXST, FLST 1997-11 Dyna, 1999-03 XL

**33-2214** Badlands 2004-13 XL

**32-2143** Badlands 2010-13 FLTR only (Street Glides & Road Glides only)

**32-2144\*** Badlands 2011-up FXST, FLST, 2012-up

**32-2145\*** Badlands 2012-up FXSB, 2011-up FLS only

**32-2146\*** Badlands 2014 FLT

**32-2147\*** Badlands 2014- XL

**\*NOTE:** The ONLY time a load equalizer is needed is when you install aftermarket turn signals on a 2011-UP FXST, 2012-UP Dyna or ANY 2014-UP model and you have rapid flashing turn signal indicator lights. The bike will also throw a trouble code. Unlike earlier equalizer modules, CAN/Bus bikes require (1) module for front and (1) module for the rear turn signals.



**Turn Signal Load Equalizer** returns amperage draw to correct factory specifications when aftermarket marker lamps are used to replace stock turn signals in bikes with self-cancelling systems (1991-99). **Note:** For all 2000-up models and 1991-99 models using LED signals use load equalizer III only.

### VT No. Brand

**33-2137** Badland LE-01

**32-1558\*** Volt Tech

**32-0874** Volt Tech

**32-2142** Badlands LE-02 for models with 4 way flashers same features as LE-01

**32-2148** 2 Pin for LED turn signals on bikes

**32-2149** 3 Pin for use with 7 amp batteries or higher.

**\*Note:** Black wire is ground and two yellow wires.

## Power Outlets/Lighter

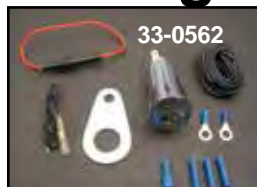

**Universal Cigarette Lighter** available for panel mounting.

### VT No. Type

**33-0561** Without bracket

**33-0562** With bracket

**12V Receptacle** for cell phone, MP3 player or lighter.

### VT No. Item

**32-0845** 12V

**32-1632**



**Traffic Light Sensor** will trigger stoplight from motorcycle when on traffic light pad.

**VT No. 32-1352**



**Illuminator Pro Module.** This module control features automatic cancelling of signals. Front running lights and turn signals on single filament halogen on incandescent

bulbs and LED's. Rear running lights, brake light function and turn signals on single filament halogen or incandescent bulbs as well as LED's. Built in load equalizer runs LED's up to 50 watts per lamp and emergency flasher mode that does not build up heat. Use on all Twins without self canceller.

**VT No 33-2207**

## Canceller



**Turn Signal Canceller** replaces stock units as equipped on the following model years.

### VT No. OEM Fits

**32-7508** 68537-89G 1991-up FXR-FXST-Dynaglide 1989-93 FLT

**32-1523** 68537-89G As Above

**32-7516** 68570-94B 1994-00 FLT

**32-7517** 68540-96 1996-00 All





# Indicator Lamp

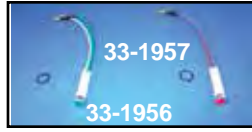
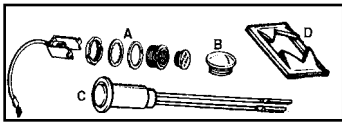

Indicator Lamps fit visors and dash for high beam, neutral and generator.

VT No.	OEM	Color	Type	Fits
33-1961	67891-68	Red	HiBeam	A-1972-74 FX
33-2172	67899-68A	Red	HiBeam	B-Fits Above
33-1962	68536-72	Red	Gen	A-1972-74 FX
39-0122	67891-75B	Blue	HiBeam	A-1977-up FX
33-1956	67851-75	Green	Neutral	C-1975-83 FX
33-1957	68536-75	Red	Oil Pressure	C-1975-83 FX
12-0553	7614		Speed Nut 1/2"	D-1975-83



## 3/8" Indicator Lamps.

VT No.	OEM	Color	Type	Fits
33-2022	68489-86	Red	Oil Pressure	1986-up FXR
33-2023	68574-86	Green	Neutral	1986-up FXR
33-2024	68023-92	Blue	HiBeam	1986-up FXR
33-2025	68695-91	Green	Turn Sig	1991-up FXR
33-2026	68002-92A	Red		1991-up FXR



Speedometer and Tachometer Lamp Sockets fit FX-XL models or FL as noted.

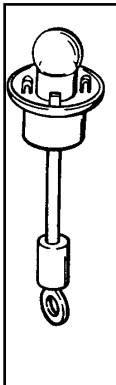

VT No.	OEM	Fits	Model
33-1959	67327-78	1979-85	FX-XL
33-1960	92045-76	1976-77	FX-XL
33-0537	71158-86A	1986-95	FLST
33-2171	67034-83	1983-86	FX-XL
33-1933	67202-86	1986-90	FX-XL
33-1934	67107-83	1983-90	FX-XL
39-0135	71151-67B	1967-73	FX-XL
33-2008	Mini Gauge	48mm	—
33-2039	Mini Gauge	60mm	—
33-0531	71151-48	1948-85	FLH
33-0529*	—	1948-85	FLH

\*Note: Cloth covered wire all other numbers are vinyl covered

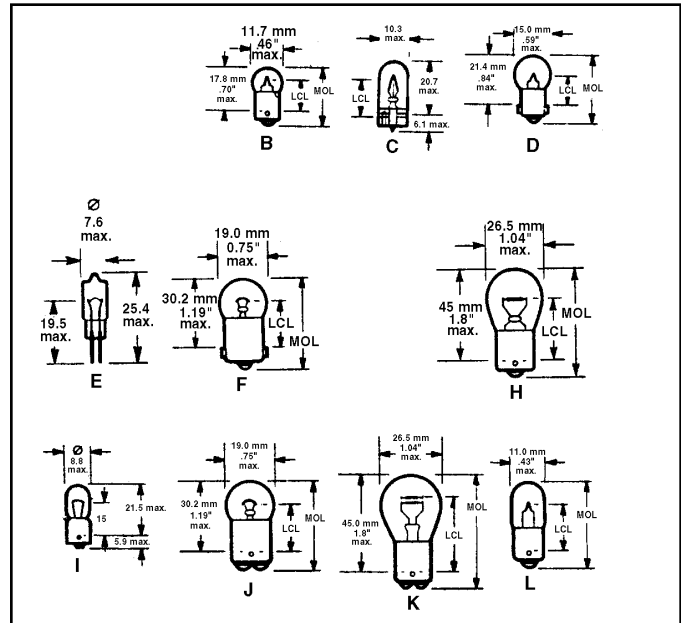

Miniature Bulbs available in 10 packs.

VT No.	#	OEM	Application
33-2068	H	5058-34	6V 2 Pin NLN, Single
33-0142	H		6V 2 Pin NLN, Dual
33-0134	C	53439-79	12V Speedo-Tach 1984-up FXR, 83-up FX Hi-Beam Indicator
33-0137	E	68024-94	94-up Speedo and Indicator Lamp
33-0130	K	68165-47	6V Brake and Tail lamp
33-0131	K	68165-64	12V Brake and Tail lamp
33-2105	K	—	As Above, Halogen 12V
33-2046	F	68165-15	6V Early Dash and FF light
33-0139	B	68462-49	6V 33-0408 FF light
33-0138	B	—	12V 33-0408 FF light
33-0136	B	68462-64	12V Turn Sig, Ind. 84-up FXST, 80-up FXWG, 71-72 FX, 65-up FL
33-1970	H	68572-50	6V Bullet Light
33-1971	H	—	12V Bullet Light
33-1982	J	—	12V Bullet, dual filament with offset mounting pins
33-1913	J	—	As Above with inline mounting pins
33-2047	E	—	12V Mini-gauge
33-0170	H	68572-64A	12V Directional, Single
33-1958	K	—	12V Directional, Dual
33-0132	I	71090-47	6V Speedo and Hi Beam
33-0133	L	71090-64	12V Speedo 71-72 FX, 84-up FXST, 80-up FXWG, Hi-Beam Ind 75-up XL, 65-up FL Speedo 73-82 FX, Speedo,
33-0135	D	71092-68A	12V Hi-beam ind 83-up FLH, 84-up FXST 80-up FXWG, 73-up FX
33-0138	D	71099-74	12V Tachometer 74-up All FX High-Beam Indicator
33-0139	B	68462-49	Bates Style Headlamp 6V High-Beam Indicator
33-0244		68561-50	6V 1948-64 Dash Base
33-2055	C	—	12V Micro VT No. 33-2132



# Fender Lamp



**Replica Fender Lamps** features a die cast chrome shell and includes mount gasket.

VT No.	OEM	Lens	Year
33-0408*	68450-49	Clear	1949-57
33-1969*	68450-49	Amber	1949-57
33-0407		Amber	Custom

\*Note: Replica of original with light up Deco-fin.



**Replica Fender Lamp** replaces 5926B-68 on 1968-up FLH front fender & late side car fenders 1979-up, classic type 12V.

VT No.	Item
33-0402	Lamp complete
15-0289	Gasket, each

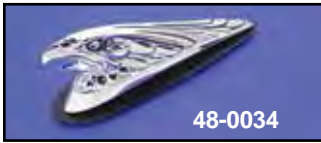

48-0034



48-0195



48-0039



48-0141

**Eagle Front Fender Ornament** 2 bolt stud mounting with gasket in chrome or with gold inlay.

VT No.	Type
48-0034	Chrome, Small
48-0039	Gold inlay, Small
48-0195	Gold, Small
48-0141	Black, Small



49-4021



49-4123

**Replica Indian Face Lamp** is constructed with chrome die cast body mounted to original style base with wire fitting.

VT No.	Item
49-4021	Lamp, white
33-1182	Lamp, red
49-4123	Lens, red
33-1406	Lens, white
33-0828	Base



33-1182



**Indian Face Front Fender Lamp** of die cast chrome, complete, 12 volt.

VT No.	Item
33-2145	Lamp, White Lens
33-1185	White Lens



33-2194



33-1451



33-1452

**Indian Face Front Fender Lamps.**

VT No.	Lens
33-2194	White
33-1451	Amber
33-1452	Blue



33-0405



33-0406



33-0429



33-1250



33-2125



33-1250

**Early Fender Lamps** are reproductions formed of brass and chrome plated. Includes rubber mount gasket and frosted plastic lens.

VT No.	#	OEM	Type
33-0405	A	68450-34	Front fender lamp, 1936-48
9786-11			Wire Kit for Above
33-0429		68450-34	Replica Lamp with Glass Lens, Wire and Hardware Kit
33-1250			Lamp
33-0406	B	68448-35	Side car light
33-1408			Side car lamp assembly
33-2125		68455-35	Front Frosted Glass
49-0597		68455-35	Front Plastic Lens
15-0205		68459-47	Mount gasket, Rubber
15-0724		68459-47	Mount gasket, Foam
15-0723		68456-35	Lens gasket
33-1034			Front Lamp



**Front Fender Lamp Wire Kit** includes steel tube, clamps, nuts, connectors, wire and loom will secure wire to fender as original. Fits 1935-47 all models. Instructions included.

VT No. 9786-11



**Eagle Fender Ornament** made of cast pewter with one stud mounting. Finished in a bronze patina. Mounts to any flat or curved surface.

VT No. 48-1790



33-1598



33-1599

**Red LED Fender Edge Lamp Kit.**  
VT No. Lens Color  
33-1598 Smoked  
33-1599 Red



**Skull Fender Lamp** features a skull face design with either feather headdress or bone hand, chrome metal body and plastic lens with 12 volt bulb measures 6½ long, 2¼ wide and 3" tall.

VT No.	Type
33-1449	Feather Headress
33-1450	Bone Hand





# Mini Horn



**Universal Horns** feature chrome faces with rear tab for universal mounting.

VT No.	Volt	Tab
33-0700	6 V	2 hole
33-0701	12 V	2 hole
33-0739	12 V	1 hole
33-2099	12 V	1 hole
33-0737	6 V	1 hole
33-0738	12 V	1 hole
33-0711	12 V	2 hole
33-2114	12 V	Black



**Chrome Round Horns** include chrome strap and bracket.

VT No.	Outside Diameter
33-1229	4"
33-1230	2.5"
33-1332	4"
33-1333	4"
33-0837	4"



**Chrome 12 Volt Twin Horn Set** produces 107 decibels. Universal style includes relay brackets and hardware.  
**VT No. 33-0648**



**Chrome Horn Relocation** will mount OEM or custom horn to rear swing arm behind transmission on 1984-up Softail models. May require drilling frame or axis tube.  
**VT No. 31-0638**



**Chrome Face Horn** with grill look. Grill will fit late model XL horn.

VT No.	Item
33-2099	Complete Horn
33-2100	Grill only



**12 V Chrome Mini Horn** is 65 mm in diameter with single tab mount.

VT No.	Type
33-0579	Smooth
33-0586	Slotted



**5 3/4" Classic Style Horns** include 2 hole bracket as shown.

VT No.	Volt	Type
33-0704	6V	B
33-0899	6V	A
33-0705	12V	B
33-0710	12V	A
33-0977	12V	A



**Horn Kit for Softail Springer** includes horn and wiring. Replaces 69036-88. Fits 1988-up FXSTS.

**VT No. 33-0009**



**FXSTS Horn Bracket Kit** replaces 69036-88 for 1988-up models. Does not fit FLSTS.

**VT No. 31-0542**



**Replica Horn Kits** include bracket, horn cover and iso mount rubber stud. \*Note: Without cover.

VT No.	Year	Model
33-2188*	1976-84	FL
33-2190	1976-84	FX
33-2191	All	Horn only



**Replica Horn Kit** fits 1991-up ST, FLT, FXD.

VT No. 33-0798



**Stock Replacement Horns.** Order covers separately.

Horn.	Cover	OEM	Fits
33-2109	42-0303	69000-76 Low Note	1976-84 All FL-FX
33-2110	42-0304	69016-76 High Note	1976-84 All FL-FX 1980-90 All FLT 1984-90 All FXST
33-2116	42-0755	69060-90D	1991-up All FLT-FXR-FXD



**Complete Horn Kit** includes 12 volt compressor, 150mm and 195mm chrome horn set, bracket and cover.

VT No. 33-0922



**33-1909 Chrome Air Horn Kit** includes 12V compressor. 150 mm and 195 mm horns.

VT No.	Item
33-1909	Horn Kit
42-5043	Cover
31-1178	Bracket



**Dual Horn Cover** fits 33-1909 horn kit.

VT No. 42-5043



**Chrome Air Scoop** mounts on left side top motor mount studs on 1991-up Touring models. Will act as scoop for improved cooling and horn cover.

VT No. 42-1010



**33-0562 Universal Cigarette Lighter** available for panel mounting.

VT No.	Finish
33-0561	Chrome
33-0562	Chrome with bracket
33-1551	LED Mini Flashlight
33-1725	FLH, 1960-84



**12V Receptacle** for cell phone, MP3 player or lighter.

VT No. 32-0845



**Cigarette Lighter** for Glide models fits 1949-59 FL stock riser top cap studs.

VT No. 32-1725

# Horn



**Chrome Horn Relocation** will mount OEM or custom horn to rear swingarm behind transmission on 1984-up ST models. May require drilling frame or axis tube. VT No. 31-0638



**FLH Horn Bracket** replaces 69131-68 on 1965-84.

VT No. 31-0520

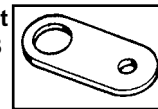

**Horn Mounting Plate** replaces 69117-65. Fits 1971-72 FX-FL.

VT No. 31-0129



**Horn Mount Nut** for mounting stock horns.

VT No.	OEM	Year
12-0550	69149-65	1965-90 BT
12-0624	7495	1991-up BT



**Horn Mount Bracket**

replaces 69006-82. Fits 1982-94 FXR-FXE models.

VT No. 31-0123



**FLST-FXST Horn Mount Brackets** in chrome.

VT No.	#	OEM	Year
31-0548	A	69118-84	1984-90
31-0547	B	69120-91	1991-up FXST-FXD FLT
28-2247		69125-65	Iso Mount Stud, 1984-91
28-0453		69123-92	Iso Mount Stud, 1992-up

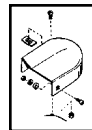

**Horn Cover Mounting Hardware** includes (3) 1719W screws, (8) 7015 lockwashers, (2) 7608 nuts, (1) 8125 nut and (1) spacer. Use to mount 1965-up FX-FL horns.

VT No.	Fits
37-8804	Kit
12-0554	Nut Only



**Chrome Trumpet Horn Kit.** Original 1950's bugle style 12 Volt horn kit can be fitted with stock exhaust and air cleaner on all 1984-99 FXWG-FXST-FLST Evo models. Includes power pack and all necessary mounting hardware.

VT No.	Item
33-0008	Complete Kit
33-0736	12 Volt Horn Pack



33-0736



**Horn Pack** for trumpet horn kit, 6 volt.

VT No. 33-1985

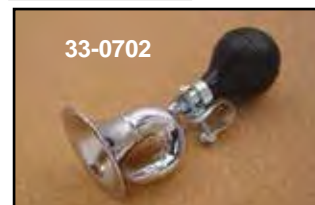

33-0702



33-0703

**Classic Squeeze Horns** in chrome or brass finish bugle style, 1" mounting clamp.

VT No.	Type
33-0702	Chrome
33-0703	Brass





# Horn Covers

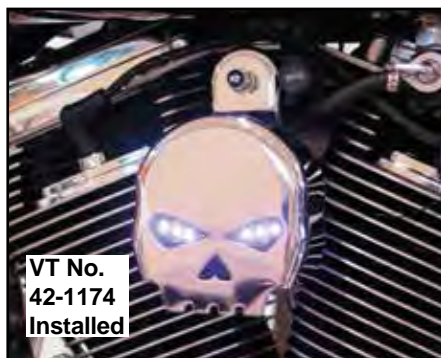

Chrome Round Cover fits 1991-up ST.

**VT No. Style**

42-0588 Smooth

42-1036 Skull

42-1526 Skull

42-1527 Flame

42-1182 Black Gloss

42-1194 Black Wrinkle



**Universal Horns.**

**VT No. Finish**

33-1469 Chrome

33-1470 Black

## Chrome Horn Covers.

VT No.	OEM	Fits
42-0015	69012-86A	1986-92 FXST
42-0755	69012-93A	1993-up FXST-FLST
42-1053	Evo	1993-up FXST
42-5041	Skull	1993-up All
42-5047	Skull	1999-up Black
42-1174	Skull	1993-up (LED)
42-0305	69141-70	1970-76 FL Hi-Note Horn 1971-84 FX Hi-Note Horn
42-9936	69138-65	1971-76 FX
42-9939		As Above
42-0304	69017-76	1984-90 FXST-FLT, 76-84 FX-FL Hi-Note Horn
42-0303	69140-76	1976-80 FX Low-Note Horn
42-1106	Skull	1976-84 FX

**Warranty**  
All Horns are covered under our warranty "Replacement Only" Provision. All electrical related item part numbers begin with a 32 or 33 prefix. No credit will be issued for these items as they are exchange only.



**Chrome Face Horn** with grill look. Grill will fit late model XL horn.

VT No.	Item
33-2099	Complete Horn
33-2100	Grill only



**Left Side Horn Kit** include bracket and horn. Fits 1952-85 XL.

VT No.	Volts
33-0697	12
33-0696	6



**Replica Horn Kits** include bracket, horn cover and iso mount rubber stud.

VT No.	Year	Model
33-2189	1971-85	XL
33-2191	All	Horn only



31-0369



31-0299

**Horn and Bracket** fits 2004-up 883-1200 models.

VT No.	Item	Finish
33-0324	Horn	Black
33-0369	Horn	Chrome
31-0299	Bracket	Chrome



34-1039



33-1468

**Horn Kit** includes bracket, horn cover and related hardware for installation

VT No.	Year	OEM
34-1039	1986-91	69014-88A
33-1468	1993-up	69112-95E



33-0699



42-9924

**Chrome Trumpet Horn Kit** includes bugle, power pack and mount hardware. Fits 1957-85.

VT No.	Item
33-2013	6V
33-0699	12V
33-1985	6V Horn Pack
33-0736	12V Horn Pack
42-9924	Horn Cover



**Trumpet Horn Mount Bracket** fits 1954-66 XL. Power Pack. Replaces 69031-57.

VT No. 31-5012



**2004-up XL Horn Mount Bracket** replaces 69135-04. VT No. 31-0299



**Horn Bumper Bracket** replaces 69041-73 on 1973-85 XL's.

VT No. 31-0133



**Horn Mounting Plate** replaces 69117-65. Use on all 1965-85. VT No. 31-0129

# Horns for XL



**Stock Replacement Horns.** Order covers separately.

Horn.	Cover	OEM	Fits
33-2109	42-0303	69000-76	1965-85 All XL Low Note
33-2110	42-0304	69016-76	1965-78 All XL High Note
33-2116	42-0755	69060-90D	1991-up XL 1200
33-2206	—	Chrome	1991-up XL 1200



33-2110

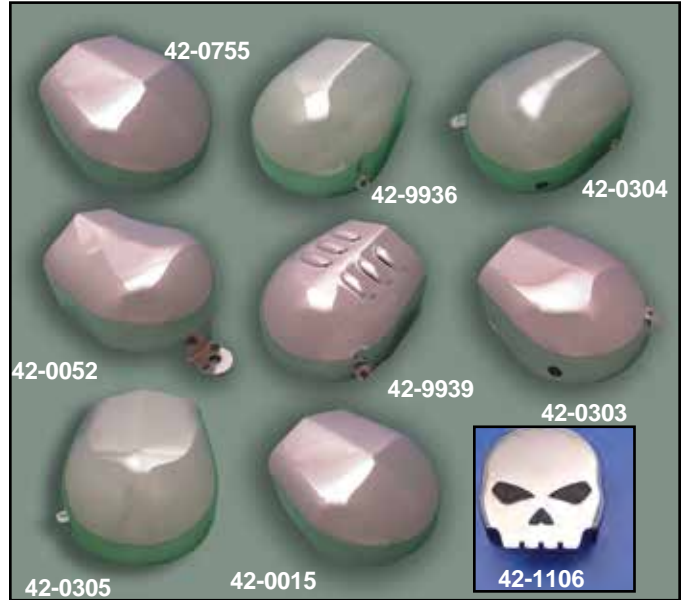

42-1174



## Chrome Horn Covers.

VT No.	OEM	Fits
42-0015	69012-86	1988-92 XL
42-0755	69012-93A	1993-up XL
42-0305	69141-70	1970-76 XL Hi-Note Horn
42-1174	Skull	1993-up (LED)
42-9936	69138-65	1965-76 XL
42-9939		As Above
42-0304	69017-76	1965-78 XL Hi-Note Horn
42-0052	69012-86	1986-92 XL 1100, 1988-up 1200 With Tab
42-0303	69140-76	1976-85 XL Low Note Horn
42-1106	Skull	1976-85 XL Low Note Horn



**Horn Mount Nut** for mounting stock horns.

VT No.	OEM	Year
12-0550	69149-65	1965-85
12-0624	7495	1986-up

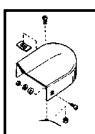

**Horn Cover Mounting Hardware** includes (3) 1719W screws, (8) 7015 lockwashers, (2) 7608 nuts, (1) 8125 nut and (1) spacer. Use to mount 1965-up XL horns.

VT No.	Fits
37-8804	Kit
12-0554	Nut Only





# Replica Horns



## Guide™ Replicas



Cycle Ray™ and Guide Logo™ are used under license from General Motors.

**Early Horns** feature chrome grill with wings order brackets separately. \*Note: Replica type as noted

VT No.	Volt	Year
33-1460	6V	1931-41 Replica
33-1456	6V	1942-57
33-1608	6V	1942-57
49-0412		Rear Bracket, Parkerized



VT No.	Item
33-0704	6 Volt Horn only
33-0705	12 Volt Horn only
33-0707	6 Volt Horn kit



**Replica Delco Remy Chrome 6 Volt Horn** features is 6 bolt style. A rear black strap bracket is attached with rivets. Order chrome winged grill for 1948-1953 FL applications, separately.  
**VT No. 33-1457**

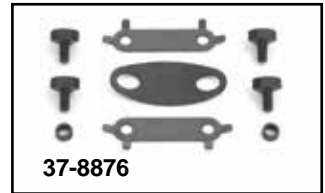
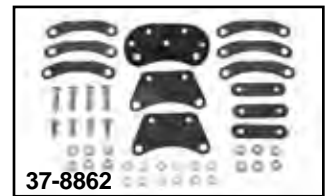
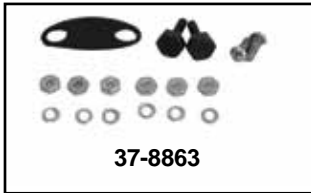

### Horn Mount and Hardware Kits.

VT No.	Models
37-8861	1930-36 VL
37-8862	1936-41 All
37-8863	1942-45 All
37-8977*	1942-45 All
37-8878	1946-48 All
37-8876	1949-51 Big Twin
37-9328*	1949-51 Big Twin
37-0063	Installation Washer

\*Note: Chrome



**Eagle Fender Ornament** made of cast pewter with one stud mounting. Finished in a bronze patina. Mounts to any flat or curved surface.  
**VT No. 48-1790**

### The Hot List

V-Twin Mfg. since 1977

1st Offered	Item	Sales
1977	Police Solo	25,000
1976	Cast Piston Set	112,000
1980	Fender Lamp	11,000
1980	Star Hub	11,000
1980	Linkert Needle & Seat	21,000
1996	Replica Frames	9,800
2003	Knuckleheads	460
2013	10mm Spark Plug Set	900

### Watch Us on YouTube!



<http://www.youtube.com/watch?v=oyA9qU7Y4q0&list=UUo-KfvCXCqOKPF5smOwNON1A&feature=share&index=1>



# Early Horn



**Headlamp and Horn Bracket Insulator Terminal Kit with Fender Lamp Wires** for Headlamp bracket to fender light on 1945-48 Big Twins and 1945-57 Servi-Car.  
VT No. 2096-14



**Horn Mount Bracket Sets.**  
VT No. Year  
49-1253 1945-48  
49-1257 1941-44

**Horn and Brackets** for 1936-48 Spring Forks.

VT No.	OEM	Item/Years
33-0708	—	12 Volt Horn kit
42-0012	—	Chrome Plain Grill
49-0783	—	Chrome Wing Grill
33-1281	—	Black Wing Grill
49-0114	69130-36	Upper Bracket, 1936-45
49-0112	69120-36	Lower, 1936-45
49-0115	69120-45	Lower, 1945-57
49-1260	69120-45	Lower 1945-57
2096-14	Kit	Mount Kit for Above
49-0420	+4"	Lower, 1936-48
49-1260	69120-45	Lower, 1945-59
37-0543	Kit	Lower Bracket, 36-45 with screw
37-0544	Kit	Lower Bracket, 46-48 with screw
49-1670		Lower, 1946-52
49-0410	69132-36	Terminal plate, 1936-41
49-2537	69124-36	Reinforcement plate, all
49-2535	69037-42	Terminal plate, 1942-48



**Vintage Horn Kit** includes chrome face and rear bracket for 1942-52 or custom use.  
VT No. Year  
33-0707 6V  
33-0708 12V

# Vintage Horn



33-0709 Installed

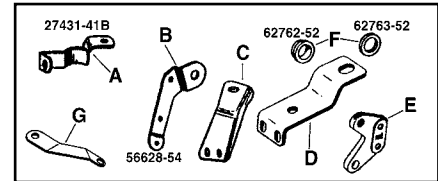

**Chrome Trumpet Horn Kit** includes bugle, power pack and mount hardware.

VT No.	Item
33-0709	12V Shovelhead Big Twin
33-0698	6V Panhead
33-0736	12V Horn Power Pack
33-1985	6v Horn Power Pack
42-9924	Horn Cover
49-1944	Horn Bugle

**Trumpet Horn Mount Brackets.**

VT No.	#	OEM	Fits	Type
9010-5	A	27431-41B	1954-65 Big Twin	Carburetor
31-0552	A	27431-41B	1954-65 Big Twin	Carburetor
31-5013	B	56628-54	1954-64 Big Twin	Timer
31-5011	C	Pan/Shovelhead	1954-up Big Twin	Power Pk Bracket
31-5012	D	69031-57	1954-66 XL	Power Pack
31-9919	E	69013-54	1954-64 Big Twin	Rubber Mount
28-2245	F	62762-52 62763-52	1954-64 Big Twin	Grommet
31-0331	G	Shovelhead	1966-84 Big Twin	Bracket
31-5010		Panhead	1954-65	Bracket





# Mirror

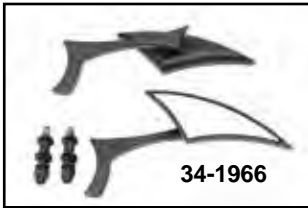

**Odins Mirror Set** features offset billet stems with curved mirrors.

**VT No. Finish**  
 34-0858 Chrome  
 34-1966 Black



**Odins Arrow Style Mirror.**  
 VT No. 34-0717



**Chrome Convex Tinted Mirror Set** includes billet stems.  
 VT No. 34-0371



**Flame Stem Mirror.** Sold each. Fits right or left side.

**VT No. Style**  
 34-0433 Tear Drop  
 34-0446 Diamond

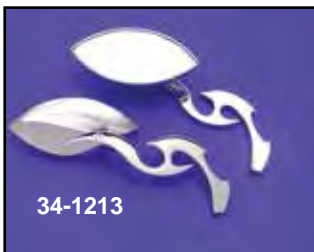

**Eagle Eye Shaped Mirrors** with stem sold in pairs.  
**VT No. Style**  
 34-1212 With long and short  
 34-1213 Crane Stem  
 34-1214 Twisted Stem  
 34-1215 Spear Stem  
 34-1216 Sickle Stem

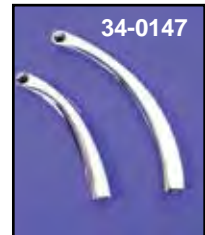
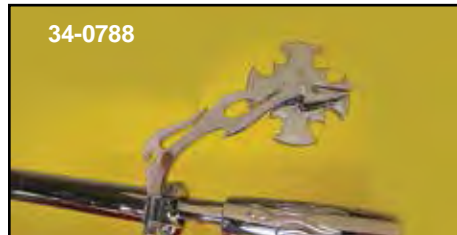

**Chrome Billet Mirrors** include stem. Crescent style sold in sets. Rotar style sold each and can be used for either right or left hand side.

Crescent	Rotar	Stem Only
34-0152	34-0788	—
34-0154	34-0789	34-0145
34-0151	34-0790	34-0146
34-0143	34-0791	34-0147
34-0153	34-0794	34-0148



**Chrome Die Cast Cobra Mirror Set.**  
 VT No. 34-0697



# Mirror



2 Stems  
Included  
with  
mirrors!

34-0356  
Oval



Diamond



34-0143

**Chrome Slim Line Mirrors** include 2 stem sets, 5" and 3 3/4" long with complete mount hardware to fit right or left side. Sold each unless noted.

VT No.	Style
34-0342	Smooth
34-0343	Axe
34-0344	Diamond
34-0356	Oval
34-0143	Crescent, Sold as pair

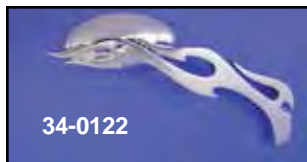

34-0122

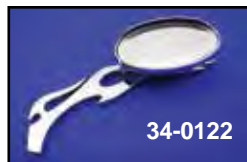

34-0122



34-0123

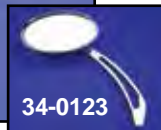

34-0123



34-0124



**Chrome Snake Eye Mirror Set** features billet stems.  
VT No. 34-0369



34-0125



34-0129

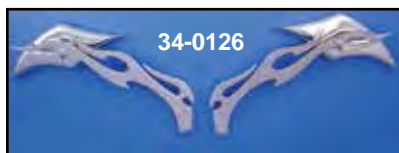

34-0126



34-0126



34-0128



34-0128

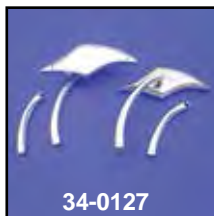

34-0127



34-8011



34-8012



34-8014



34-8015

**Oval Mirrors** fit right or left, sold each.

VT No.	Stem Style
34-8011	Maltese
34-8012	Spear
34-8014	Slot
34-8015	Sickle

## Chrome Billet Mirrors.

VT No.	Style	U/M
34-0122	Oval, Right/Left	Each
34-0123	Oval, Right/Left	Each
34-0124	Oval, Right/Left	Each
34-0125	Diamond Right and Left	Set
34-0126	Diamond, Right and Left	Set
34-0127	Diamond, Right and Left	Set
34-0128	Oval, Right and Left,	Set
34-0129	Diamond, Right and Left	Set



**Radii Mirror Set** measures 7" long and 3" wide at widest point.  
VT No. 34-0785

All Mirrors are covered under "Replacement Only" Provision. No credit will be issued for these items as they are exchange only.





# Mirror



**Chrome Billet Maltese Mirror Set** features built in LED turn signal matrix on back side  
**VT No. 34-0681**

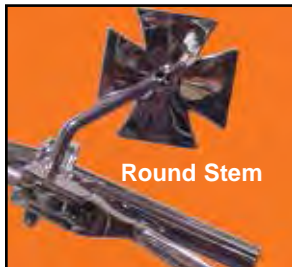

Round Stem

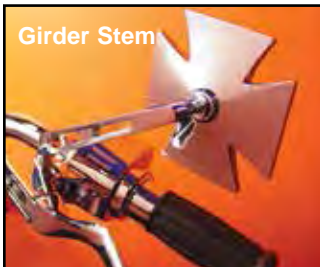

Girder Stem

“Chopper Chrome” Die Cast Maltese Mirror available with round or girder stem, each.

**VT No. Stem**  
**34-0345 Round**  
**34-0351 Girder**



34-0120



34-0121



34-0450 Back



34-0450 Front

**Red Baron™ Billet Mirrors** are sold each which include billet stem(s) as noted.

**VT No. Stem Note**  
**34-0450 Billet 2 stems**  
**34-0120 Girder Each**  
**34-0121 LED Each**



34-8007



34-8008



34-8009

**Kaiser Billet Mirrors** include stem fit right and left side.

**VT No. Stem**  
**34-8007 Ball Milled**  
**34-8008 Curve Stem**  
**34-8009 Maltese**



**Chrome Firefighter Billet Mirror** includes 2 stems, one long and one short.  
**VT No. 34-0390**



**Chrome Maltese Mirror Set** includes curved stems.  
**VT No. 34-0382**



**Chrome Maltese Mirror Set** includes Billet stems.  
**VT No. 34-0370**



**Black Wrinkle Maltese Mirror** features black wrinkle finish, plastic head with chrome stem and clamp.  
**VT No. 34-0315**



**Maltese Mirror Set** is 3.5 x 3" profile. Sold as pair.  
**VT No. 34-0796**



**Mini Red Baron™ Mirror** is 2.5" square and includes 2 stems.  
**VT No. 34-0757**



# Mirror



**Billet Oval Mirror Set** features a 3-slot stem, sold as right and left pair. Replaces 91513-99.

**VT No. Finish**  
**34-0328 Chrome**  
**34-1955 Black**



34-0354

**Chrome Bullet Mirror Set** features sculpted stems.

**VT No. Finish**  
**34-0354 Chrome**  
**34-1964 Black**

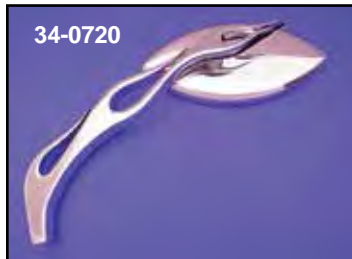

34-0720



34-0721

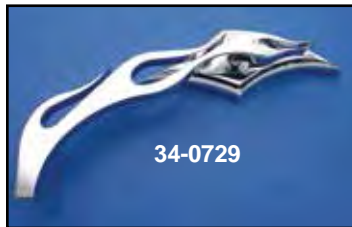

34-0729



34-0727



34-0730

**Billet Druid Mirrors** for left side. Sold each for left side or as pair.

VT No.	Style	U/M
34-0720	Oval Flame	Each
34-0721	Druid Spear	Each
34-0729	Druid Flame	Each
34-0727	Oval Flame	Pair
34-0730	Druid Flame	Pair

**Teardrop Mirrors** with tribunal design.

**VT No. Finish**  
**34-1541 Chrome**  
**34-1542 Black**

**Cafe Style Mirrors.**

**VT No. Finish**  
**34-1969 Black, Set, 3"**  
**34-1970 Chrome, As Above, 1"**  
**34-1971 Black, 7/8"**  
**34-1972 Chrome, 7/8"**



34-1011



34-1013

**Chrome Styler Mirror Set** feature girder stem design. Pairs.

**VT No. Type**  
**34-1011 Eagle Spirit**  
**34-1013 Smooth Back**



**Radium™ Oval Mirror Set** features contour round stem with oval face. Hardware included. Sold in pairs.

**Chrome Black**  
**34-0331 34-1961**

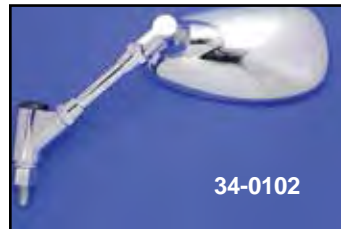

34-0102

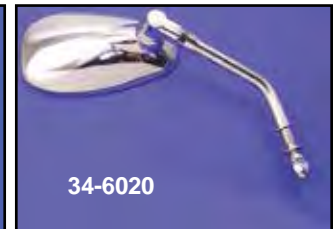

34-6020

**Billet Mirror** includes adjustable stem.

**VT No. Type**  
**34-0102 Isolated**  
**34-6020 Stock**



**Teardrop Mirrors** with offset stems. Apache style with offset stems.  
**VT No. 34-1566**



34-1594



34-1595



34-1597

**Billet Mirrors.**

**VT No. Type**  
**34-1594 Teardrop Tribal Mirror with Short Slotted Stem**  
**34-1595 Teardrop Tribal Mirror with Sickle Stem**  
**34-1597 Sickle Mirror with Spear**

All Mirrors are covered under "Replacement Only" Provision. No credit will be issued for these items as they are exchange only.





# Skull Mirror



**Round Skull Mirror Set** is 3 $\frac{3}{16}$ " diameter features bone stem, pair.

**VT No. 34-0367**



**Skull Mirror** includes two length stems to fit right or left side.

**VT No. 34-0111**



**Skull Teardrop Mirror Sets** include stems.

**VT No. 34-0759**



**Chrome Billet Gothic Mirrors** with tri skull stems, sold as a pair, fit right and left.

**VT No. 34-0760**

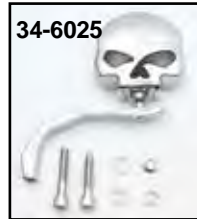

34-6025



34-1952



34-6024



34-1953

**Skull Mirrors** feature offset stems.

**VT No. Stem**

34-6025 Worm

34-1952 As Above, Black

34-6024 Wing

34-1953 Skull w/ billet stem



34-6022



34-1565



34-1564



34-1954

**Skull Billet Mirror** fits right or left side complete with stem.

**VT No. Skull Stem**

34-6022 5 Worm

34-1565 3 Wing

34-1564 3 Worm

34-1954 5 Skull w/worm stem



34-0782



34-0783



34-0784



34-1319

**Skeleton Mirror Set** with bone shaped stems.

**VT No. Type**

34-0782 Chrome

34-0783 Gold Inlay

34-0784 Black

34-1319 Black/Chrome



34-1274

**Chrome Black Eyes Skull Mirror Set** with bone stem includes right and left sides. Additional hardware is included for installation on metric bikes. Stem is 4" long and is adjustable.

**VT No. 34-1274**



# Mirror



**Chrome Tear Drop Mirror Set** available with curved stems and mount hardware. VT No. 34-0357



**Micro Tear Drop Mirror** features slotted stem. Sold each. Fits right or left side. VT No. 34-0359



**Chrome Billet Mirror Set** feature stock style steel stems for right and left fitment. VT No. 34-0373



**Billet Style Cateye Mirror** with tinted glass and girder stem, mirror measures 2 3/4" x 5". Each fits right or left. VT No. 34-0347



**Oval Mirror Set** features adjustable lens. VT No. 34-8019



**Tear Drop Mirror Set** features retro styling. Sold in set for right and left sides for 1982-up models. Use on pre1982 models requires spacer VT No.37-0587.

Chrome	Black	Item
34-0330	34-1962	Mirror Set
37-0587		Spacer Set



**Chrome Tear Drop Mirror Set** features radii stems, right and left. VT No. 34-0358



**Tear Drop Mirror** fits right and left sides. Each. VT No. 34-0360



34-0294



**Billet Mirror Set** feature oblong shape and slotted stem to fit 1982-up control handles, sold in pairs.

**Chrome Black**  
34-0675 34-1963



34-0320

**Chrome Oval Mirror.** Fits right and left sides 1965-up.

VT No. Type  
34-0320 Smooth  
34-0327 Stem w/yoke



34-0388



34-0396

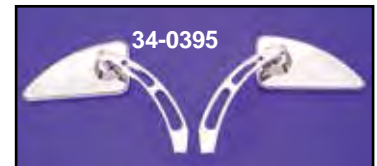

34-0395

**Billet Profile Mirror Set** features hidden mount bolt mounting.

VT No. Stem  
34-0388 Smooth  
34-0395 Slotted  
34-0396 Slotted





# Mirror



34-0391



34-1959



34-0392



34-1960



34-0393



34-0402



34-0403



34-0404

Wyatt Gatling Mirror available with stock or billet stems.

### Chrome Black Stem

34-0391 34-1959 Short Stock

34-0392 34-1960 Long Stock

34-0393 34-1961 Billet

34-0402 Short Round

34-0403 Billet

34-0404 Short Round



34-1310



34-1311

### Teardrop Mirrors.

VT No. Item

34-1310 Chrome

34-1311 Black



34-1833



34-1834

### Chrome Billet Slasher Mirror

VT No. Type U/M

34-1833 Oval Pair, Slotted Stem

34-1834 Oval Pair



Oval Vision Deep Dish Mirror with radius stem. Sold each for right or left side.

VT No. 34-0348



Chrome Billet Replica Mirror Set.

VT No. 34-0758



Chrome Deco Mirror Set features adjustable ball swivel for head. Includes right and left.

VT No. 34-0724



34-1581



34-1582

### Billet Mirror.

VT No. Type U/M

34-1581 Axe Pair

34-1582 Oval Each



34-8214

Chrome Curvado Mirror Sets. VT No. 34-8214



Siege Billet Mirror Set with twisted stem. VT No. 34-6016



Chrome Oval Mirror with ring and billet 3 slot stem. Use for the right or left side.

VT No. 34-0384



Rectangular Mirror Set includes billet stems.

VT No. 34-0386



Taper Mirror Set features billet stems.

VT No. 34-0333

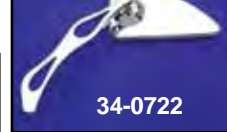

34-0722

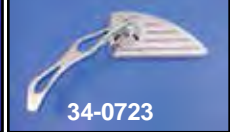

34-0723

Ace Mirrors for left side use feature billet stem.

VT No. Style

34-0722 Smooth

34-0723 Ball Milled



34-1217



34-1218



34-1219

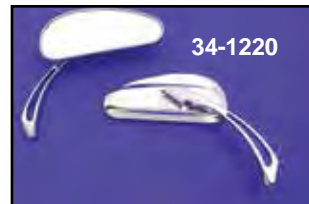

34-1220

Deco Shaped Mirrors with stem sold in pairs.

VT No. Stem

34-1217 With long and short

34-1218 Sickle

34-1219 Slot

34-1220 Spear

# LED

# Lighted Mirror



All custom turn signal/lights require load equalizer.



**Billet Mirror Set** features sequential LED turn signal on back side.

**VT No. Style**  
**34-9157** Slotted  
**34-9163** Oval



**34-8219**

**34-8220**

**Billet Mirror Sets** features drilled stems with teardrop shape head with built in LED in back side.

**VT No. Type**  
**34-8219** Set with LED  
**34-8220** Set with LED on both sides

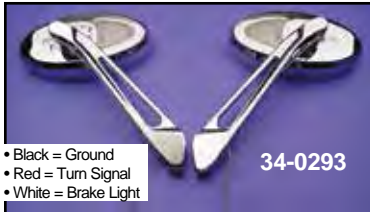

- Black = Ground
- Red = Turn Signal
- White = Brake Light

**34-0293**



**34-6019**

**Ellipse Chrome Mirror Set** features built in LED turn signal. Mirror measures 5" x 2 3/4", with 7" long stem.

**VT No. Lens LED**  
**34-0293** Clear Amber  
**34-6019** Amber Clear



**Round Mirror** has lighted turn signal strip in stem. Stem is die cast. Fits right or left side. Sold Each.

**VT No. 34-0387**



**34-1378**



**34-1353**

**Billet Mirror Set** features amber lens with full LED for use as turn signals.

**VT No. Type**  
**34-1378** Flash  
**34-1353** Rotating



**Chrome Billet Maltese Mirror Set** features built in LED turn signal matrix on back side

**VT No. 34-0681**



**34-1950**



**34-1951**

**Black LED Billet Mirror Set.**

**VT No. Style**  
**34-1950** LED Round  
**34-1951** LED Tear Drop

All Mirrors are covered under "Replacement Only" Provision. No credit will be issued for these items as they are exchange only.



**34-0021**



**34-0022**

**Evil Eye Mirror Set** is chrome plated die cast mirror, right and left, available with or without LED turn signals.

**VT No. Type**  
**34-0021** Without LED  
**34-0022** With LED Turn Signals



**34-1832**

**Evil Eye Shaped Chrome Mirror set** features amber LED turn signals built into the stems.

**VT No. 34-1832**



**LED Skull Mirror Set.**  
**VT No. 34-0072**





# Billet Mirror

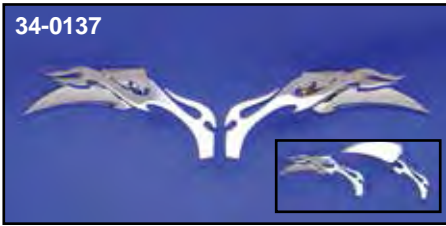
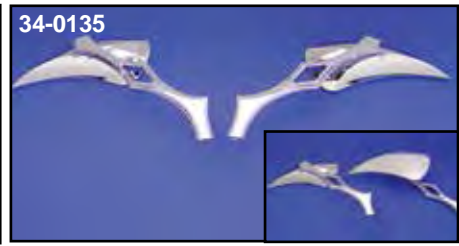
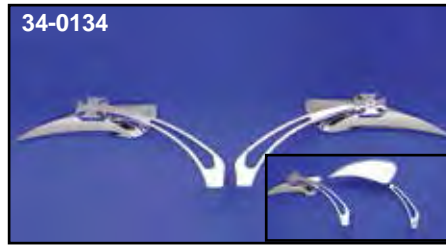
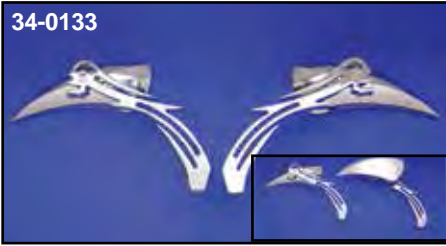

Gold Detail  
Shown on  
34-0860

**Billet Mirrors.** Sold as pairs.

Flame	Smooth	Face	Stem
34-0863	34-0133	Tear Drop	Skull
34-0864	—	Gold Inlay	Skull
34-0867	34-0134	Tear Drop	Cross Head
34-0868	—	Gold Inlay	Cross Head
34-0861	34-0135	Tear Drop	Twisted
34-0859	34-0136	Tear Drop	Normal and Short Stem
34-0860	—	Gold Inlay	Two Stems
34-0865	34-0137	Tear Drop	Flame
34-0866	—	Gold Inlay	Flame
34-0869	—	Tear Drop	Spear
34-0870	—	Gold Inlay	Spear

**Oval Girder Mirrors** include mount stems and have a chrome structural brace. Stems included but sold separately. Note: R/L fits right or left.

**VT No. Style**

34-1058 Oval Smooth Flat Back

34-2023 Oval Smooth Flat Back

34-0719 Oval Smooth Flat Back

34-1059 Oval Groove, Back

34-0323 Smooth Oval Radius Back

34-0324 Smooth Oval Radius Back

34-0994 Stem only, 6"

**Type**

Right/Left

Right

Left

Left

Right

Left

Right



34-1059

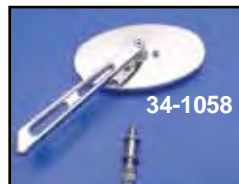

34-1058

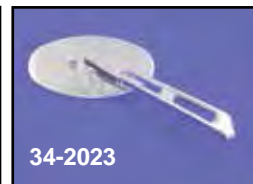

34-2023



34-0324



# Flame Mirror

*Walt Stalling*



34-1245



34-0786



34-0398



34-1590



34-1593



34-0490



34-0489

## Fireball Mirror Set.

- VT No. Type**  
**34-1245** Overlay  
**34-0786** Chrome  
**34-1590** Chrome Over Black  
**34-1593** Black Flame

**Fire Ball Mirror Sets** are available with long flame stems or curved stems types. Include both long and short stems. Mirrors feature full chrome, chrome with gold inlay or black finish.

- | VT No.  | Stem     | Finish     | Stems            |
|---------|----------|------------|------------------|
| 34-0398 | Curved   | Chrome     | Long and Short   |
| 34-0490 | Curved   | Gold Inlay | Long and Short   |
| 34-0489 | Flame    | Chrome     | Long Flame Stems |
| 34-1958 | Fireball | Black      | Long Flame Stems |



34-1586



34-1588



34-1589

**Chrome Mirror Sets** include billet stems.

- VT No. Type**  
**34-1586** Lazer Wing  
**34-1588** Flame  
**34-1589** Oval



34-0366

**Flame Tear Drop Mirror Sets** feature slotted stem with full chrome or gold inlay finish.

- | VT No.  | Finish     |
|---------|------------|
| 34-0365 | Chrome     |
| 34-0366 | Gold Inlay |



42-0747



42-0748



42-0743

**Flame Cover Set** includes 3-hole derby, inspection and points cover for 1970-98 Big Twin, FX-FL models, 4-Speed.

**VT No. 42-0743**



42-0969



42-0749 Installed



42-0817 Installed



42-0816



42-0751



42-0922

**Chrome Flame Covers** feature die cast designs for 1970-up Big Twins.

## Chrome Flame Derby and Inspection Oval Set.

**Note:** Screws included.

VT No.	Item	Years
42-0747	Derby, 3-Hole	1970-98
42-0922	Derby, 5-Hole	1999-up
42-0748	Points Cover	1970-98
42-0969	Points Cover, 5-Hole	1999-up
42-0749	Inspection Cover	1986-up
42-0751	5 Speed Transmission End Cover	1986-up

VT No.	Year	Model
42-0817	1965-98	FL and Softail
42-0816	1999-up	Softail
	1999-05	FXD





# Split Vision Mirror



**Iso-Mirrors** feature isolated mirror at head mount with far view. Viewing area encircled.  
**VT No. 34-1225**

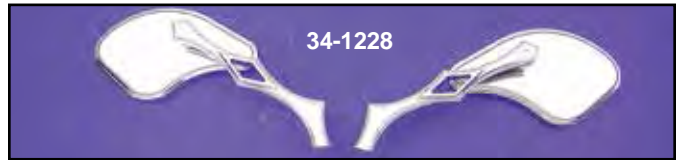
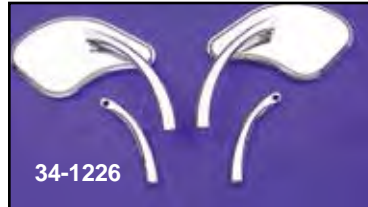

**Pork Chop Mirror Sets** features billet stems. Sold as right and left set.

**VT No. Stem**  
**34-1226** Long Short  
**34-1228** Twisted

**VT No. Stem**  
**34-1229** Spear  
**34-1230** 3-Skull

**Split Vision Mirror Set** features out board convex mirror for wide angle view. Split Vision Mirror has small outboard inset for seeing panoramic view of the scene behind you. The main mirror is for normal view and the small convex inset shows wider field.

**VT No. Stem Type**  
**34-8119** With 2 Stems  
**34-8120** Slot Stem  
**34-8121** Spear Stem  
**34-8122** Sickle Stem



**Split Vision Mirror with lower convex.**  
**VT No. 34-1592**

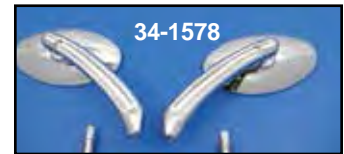

**Billet Mirror Set.**  
**VT No. Finish**  
**34-1835** Black  
**34-1836** Chrome

## Mirror Sets.

VT No.	Item	Stem
34-1577	Parallelogram Mirror Set, Chrome	5"
34-1578	Teardrop Mirror Set, Chrome	4"
34-1579	Teardrop Mirror Set, Chrome with Steel Stems	6"
34-1580	Round Mirror Set, Chrome	4"
34-1574	Oval Mirror Set, Chrome	4"
34-1575	Oval Mirror Set, Chrome	5"



**One Piece Parallelogram Style Mirror** with pyramid design. Pair.  
**VT No. 34-0346**



# Billet Mirror

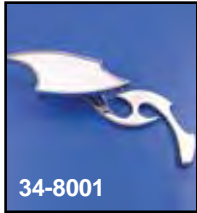

34-8001



34-8002



34-8003

**Lucifer Billet Mirror Sets** include right and left side with stems.

VT No.	Stem
34-8001	Scroll
34-8002	Curve Stem
34-8003	Sickle



34-8113



34-8114



34-8116

**Mirror Sets** include stems.

VT No.	Stem
34-8113	Angle
34-8114	Curve
34-8116	Wide Curve



**Cross Back Style Oval Mirror Set** with steel round stems.  
VT No. 34-1375



34-0389



34-0698

**Chrome Billet Mirror** features adjustable angle face. Sold as pairs.

VT No.	Type
34-0389	Ball Milled
34-0698	Smooth



34-8004



34-8005



34-8006

**Zoid Mirrors** sold each with stem.

VT No.	Stem
34-8004	Sickle
34-8005	Smooth
34-8006	Spike



34-0887

**Billet Deco Mirror Set.**  
VT No. 34-0887



34-0872



34-0873



34-0874



34-8010

**Oblique Mirrors** sold as pairs.

VT No.	Stem Type	VT No.	Stem Type
34-0872	Plain	34-0874	Diamond
34-0873	Girder	34-8010	Slot



34-0164



34-0165



34-0167



34-0166

**Die Cast Mirrors.**

VT No.	Style
34-0164	Chrome Oval
34-0165	Chrome Rectangle
34-0167	Black Rectangle
34-0166	Black Teardrop



34-0416

**Black Powder Coated Triangle Shaped Mirror Set** is PVC type. Set includes right and left sides with hardware.

VT No. 34-0416





# Mirror



**Chrome Billet Mirrors.** Sold each, fit right and left.

VT No.	Stem	Style
34-0130	Skull	Maltese
34-0131	Maltese	Maltese
34-0132	Skull	Fireman
34-0129	Maltese	Spear



**Mod Custom Mirrors.** Chrome with stem included, in pairs.  
VT No. 34-0349



**Billet Fire Fighter Mirror** includes both 3" and 5" arms. Sold each.  
VT No. 34-0394

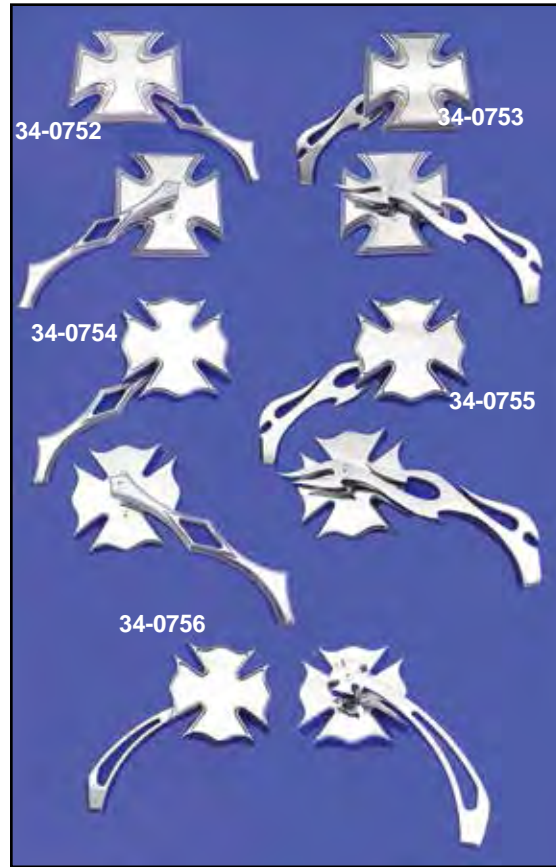

**Billet Mirrors.** Sold each

Chrome	Black	Stem	Style
34-0752		Diamond	Maltese
34-0753		Flame	Maltese
34-0754		Diamond	Fireman
34-0755	34-1957	Flame	Fireman
34-0756		Maltese	Fireman



**Billet Mirror Stems** fits Wyatt's Mirrors. Sold each.

VT No.	Style	VT No.	Style	VT No.	Style
34-0145	Spear	34-0148	Maltese	34-0871	3-Spade
34-0146	Diamond	34-0159	Lady Luck	34-0761	Tri Skull
34-0147	Curved	34-0856	Spinner Lady		

All Mirrors are covered under "Replacement Only" Provision. No credit will be issued for these items as they are exchange only.



# Billet Mirror



Inset Style as denoted by 34-0138

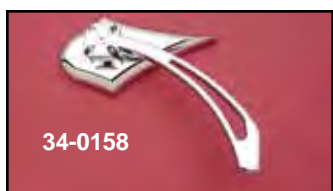
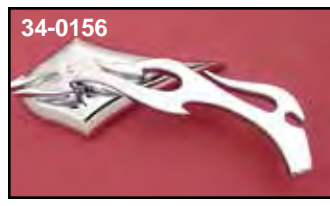
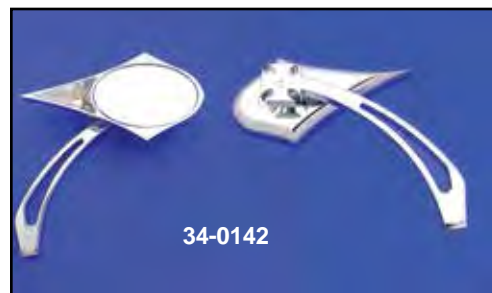

Billet Baroque Mirror Set with billet stems.  
VT No. 34-0777



Chrome Billet Spike Oval Face Mirror featuring smooth face or face with inset. Sold each.

Full Face	Face w/Inset	Stem	U/M
34-0160	34-0138	2-Stems	Each
34-0155	34-0139	Twisted	Each
34-0156	34-0140	Flame	Each
34-0157	34-0141	Skull Stem	Each
34-0158	34-0142	Cross Head	Each

Villain Style Mirror Sets.

VT No.	Stem
34-0768	Long and Short
34-0769	Spear

All Mirrors are covered under "Replacement Only" Provision. No credit will be issued for these items as they are exchange only.

MULTI FIT/CHOPPER





# Mirror



**Billet Eclipse Mirror Set** includes stems.  
**Chrome Black**  
34-0380 34-1967



**Racer Mirror Set** include adjustable face.  
VT No. 34-0397



**2" Cone Billet Mirrors.**  
VT No. Type U/M  
34-0368 Cone Pair  
34-0383 Tear Drop Each  
34-0793 Tear Drop Each



**Chrome Billet "S" Curve Mirror Set**  
includes stems.  
VT No. 34-0381



**Chrome 3D Style Mirror Set** is a die cast  
3D style mirror (left and right).  
VT No. 34-0350



**Teardrop Mirror Sets** include stems.  
VT No. Stem  
34-0885 Flame with Lady Luck  
34-0759 Skull  
34-0212 Rogue  
34-1232 Rogue, Raised Design



**Lady Luck Mirrors Sets** feature billet  
stems.  
VT No. Stem  
34-0797 Long-Short  
34-0798 Spear  
34-0795 Body Set Only



**Replica 4" Mirror** includes stem and clamp.

**VT No. Finish**

**34-0329** Chrome

**34-1584** Stainless

**34-1313** Clamp Kit

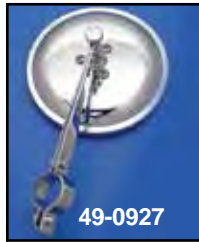

**Replica Early Mirror** is a duplicate of 11350-34, original accessory in 1936 catalog, parkerized stem clamps to 1" bar with 5" black round face included.

VT No.	Item	Finish
49-0912	5" Mirror Complete	Black
49-0927	Mirror Complete	Chrome
34-0600	Mirror Face	Chrome
49-0913	5" Mirror Face	Black, 1/4"X28" hole
49-0949	Stem	Black



**Replica Mirror** includes clamp set and stem.

VT No.	Item
49-0273	Mirror Complete, Black Shiny Stem
49-0952	Black Face Only



**Spring Stock Fork Mirrors** are the original style with black finish, great for restoration. Replaces 11350-34

VT No.	Type
49-0917	Face Only, Black
34-0600	Face Only, Chrome
49-0435	Face Only, Replica



**Vintage Mirror** with a black oxide finish.

Great for restoration projects.

**VT No. Fits Item**

**34-1831** 1" 3" Mirror Kit

**34-1534** 7/8" Stud Nut Only

**34-1514** 3" Face

**49-0949** 1" Stud

**34-1513** 7/8" Mirror Stem without hardware



# Vintage Mirror



**Chrome Round Mirrors** are large size which actually allows you to see something.

**VT No. Size/Type**

**34-0352** 4" Stock Type Stem  
(Right and Left Set)

**34-0353** 4.5" Sliding Stem

**34-0449** Telescope Design



**4" Round Mirrors** feature threaded end for mounting. By National Cycle Brand.

**VT No. Side**

**34-1567** Left

**34-1570** Right



**Military Mirror** features black finish with adjustable stem and clamp set.

**VT No. Type**

**49-0138** VT

**49-0478** Replica

**49-0274** Replica Military Style

**49-0952** Black Face Only



## For Indian

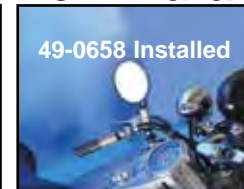

**Mirrors for Indian.**

**VT No. Style Finish**

**49-0658** Left Black

**49-0660** Replica Chrome

**49-0660**





# Mirror



### "Ride Free" Mirror Set

VT No. Finish  
 34-1234 Chrome  
 34-1235 Gold Inlay



**Eagle Mirrors** include stems and acorn nuts for handlebar lever mounting. Available in sets, right and left sides, the eagle faces to outside of bike.

VT No.	Type	Stem	Style
34-1069	Chrome Set	Girder	Spirit
34-0298	Chrome Set	Stock	Spirit
34-0297	Gold Inlay Set	Stock	Spirit
34-0988	Chrome, Right	Stock	Spirit
34-0989	Chrome, Left	Stock	Spirit
34-0731	Chrome	Head	Right



### Oval Mirror Sets.

VT No.	Finish
34-1376	Chrome, round stems, right and left sides
34-1377	Black, round stems, right and left sides

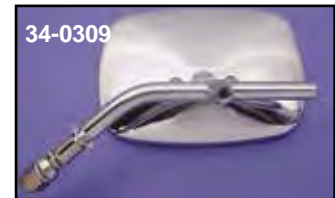
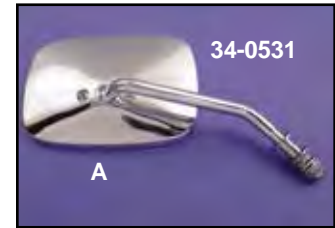
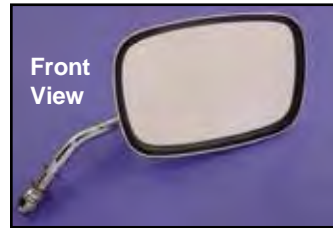

**Replica Die-Cast Chrome Mirrors** are one piece-swivel head design as original for 1965-up all models.

VT No.	#	Item	Type	Note
34-0531	A	Each	Short	Right
34-0319	A	Each	Short	Left
34-0295	A	Set	Short	Set
34-0309	C	Stock	Short	Plain
34-0314	B	Each	Long	Right
34-0317	B	Each	Long	Left
34-0296	B	Set	Long	Left/Right
34-0318	Each	Long	Long	Black Left/Right

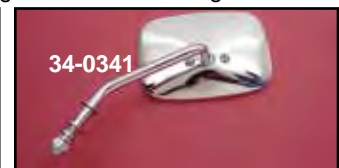

### 1988-up Convex Style Mirrors.

VT No.	Side
34-0340	Right
34-0341	Left



**Chrome Steel Mirror** mounts on hand lever through existing hole.

VT No.	Type
34-0301	Stock
34-0302	Clamp on
34-0310	Stock Scroll



**Chrome Mirror Stems** with acorn nut, pairs.

VT No.	Length	Rise
34-0334	11"	8"
34-0335	8"	4"

All Mirrors are covered under "Replacement Only" Provision. No credit will be issued for these items as they are exchange only.



# Mirror

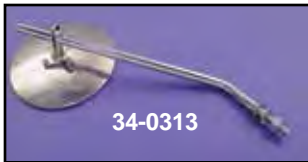

34-0313

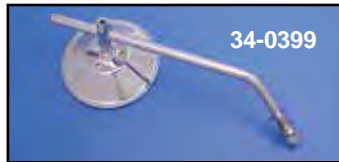

34-0399



34-0312



34-0306

**4" Round Chrome Mirrors** include stems in either clamp on, or with threaded end to fit stock lever brackets.

VT No.	Type
34-0313	With stud
34-0399	With stud
34-0312	With stud
34-0306	With clamp



34-0995



34-0997



34-0999

**Round Mirrors** are available as clamp on long or short stem in right or left mounting.

Chrome	Stainless	Side	Type/Stem
34-0995	34-1573	Set	Clamp on
—	34-1572	Right and Left	Stud and Nut
34-1317	—	Right and Left	Telescope
34-0997	—	Right	Short
34-0998	—	Left	Short
34-0999	—	Right	Long
34-1000	34-1569	Left	Long

**Note:** All mirrors sold each unless noted as set or pair.



34-1598



34-1599

**Mini Tapered Mirror.**

VT No.	Item
34-1598	Short Slot Stem
34-1599	Long Slot Stem



34-0419



34-0333



34-0459



34-0417

**Triangle Shaped Mirror Set** with round steel stems, includes right and left sides with hardware top mount to handlebar controls. Note: The back is plastic.

Chrome Black	Type
34-0333 34-0459	Rectangle, Taper

VT No.	Finish
34-0419	Black
34-0417	Chrome





# Round Mirror

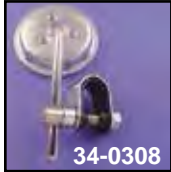

**Chrome Round Mirror**  
with billet stem.  
VT No. 34-1585



**3" Round Chrome Mini-Mirrors** with clamp or stock stem to fit standard lever mount.

- |               |                    |
|---------------|--------------------|
| <b>VT No.</b> | <b>Type</b>        |
| 34-0308       | Clamp on           |
| 34-0418       | Clamp Black        |
| 34-0300       | Lever Mount        |
| 34-6014       | Lever Mount, Black |
| 34-1514       | Mirror Head        |



**Round Flame Mirrors** are 4 $\frac{3}{8}$ " outside diameter.

VT No.	Finish	Type	U/M
34-0376	Chrome	Round	Pair
34-0377	Gold	Round	Each
34-0378	Chrome	Slot	Each
34-0379	Gold	Slot	Each

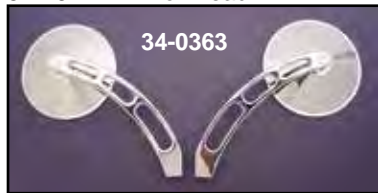

**Billet Smooth Round Mirror Set** is die cast construction and curved stem, pair.

- |               |             |
|---------------|-------------|
| <b>VT No.</b> | <b>Size</b> |
| 34-0363       | 3.5"        |
| 34-0037       | 2.75"       |



**Black Round Mirror.**

- |               |  |
|---------------|--|
| <b>VT No.</b> | <b>Fits</b>                                  |
| 34-0426       | Clamp on round stem for stock lever brackets |
| 34-0427       | Custom round style, 4" round stem            |



**Billet Babyface Mirror 3.5"**  
with round stem. Use for right  
or left side.  
VT No. 34-0716



**Chrome Groove Back Mirror Set** features die cast construction and 4 $\frac{3}{4}$ " slotted stems set. Includes right and left side.

VT No. 34-0361



**3" Billet Round Mirror**  
with flame stem, sold  
each.  
VT No. 34-0448



**Billet AirFlow Mirror Sets.** Chrome mirror sets have 4" diameter face and available with straight or curved billet stems or round billet stem. Features raised center portion with relief cuts.

- |               |                  |
|---------------|------------------|
| <b>VT No.</b> | <b>Style</b>     |
| 34-0016       | Straight Stem    |
| 34-0017       | Curved Stem      |
| 34-0018       | Round Steel Stem |

V-Twin Mfg. supplied components for every aftermarket motorcycle company who sprang up due to the shortage of Harley-Davidson motorcycles.

Startups included:

- Big Dog (1994-2011)
- Excelsior-Henderson
- Ultra
- American Iron Horse (1995-2008)
- Confederate
- Gilroy Indian Co (1999-2003)



# Mirror



34-0289



34-0299



34-0291



34-0290

**Rectangle Mirror**  
**Black Chrome**  
34-0289 34-0299  
34-0291 34-0290



34-1837



34-1838

**Chrome Bullet Mirror Set** features sculpted stems.  
**VT No. Finish**  
34-1837 Chrome  
34-1838 Black

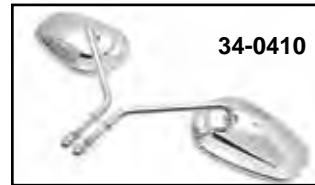

34-0410



34-0411



34-0412



34-0413

**Taper Convex Mirror Set.**  
**Chrome Black Type**  
34-0410 34-0411 Long  
34-0412 34-0413 Short



34-6023

**Chrome Rectangular Mirror** sold each.  
**VT No. Type Stem**  
34-0294 Die Cast Round  
34-6023 Die Cast Billet

## Mirror Extensions and Mounts



**Mirror Extension Kit** replaces 91907-87 for relocating mirrors 2" higher on all models.

**VT No.**  
37-9188  
37-9397

**Finish**  
Chrome

**Mirror Mount Block** fits 1996-2007 handlebar master cylinder to allow use of custom mirrors with larger than stock stem by moving the mirror stem up and out from the master cylinder.

**VT No. Item**  
31-0519 Right  
34-9158 Right and Left  
34-1968 As Above, black



31-0519



34-9158

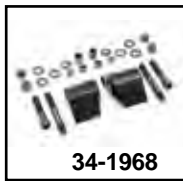

34-1968



31-0390



31-0391



31-0392



31-0393

**Mirror Bracket Extensions** for FXD-FXST models with skulls or plain.

**Chrome Black**  
31-0390 31-0391 Skull  
31-0392 31-0393 Plain



31-0045



31-4025

**Deco Mirror Bracket** is die cast will attach any stock stud mirror mount to 1" handlebars.

**VT No. Finish**  
31-4025 Chrome  
31-0045 Black



**Black Deco Clamp** is die cast and is used to clamp to 1" handlebars to mount a mirror with stud.

**VT No. 31-4180**



**Metric Adapter Kit** adapts mirrors to Honda, Yamaha and Kawasaki models.

**VT No. 34-0454**



**Metric Adapter Kit** will adapt mirrors to Japanese models. Three piece kit includes two left hand thread and one right hand thread studs.

**VT No. 34-0149**



34-0019



34-0020

**Mirror Relocation Kit** fits 2006-up FXD, FLST, FXST, FLHR.  
**Black Chrome**  
34-0019 34-0020





# Petcock

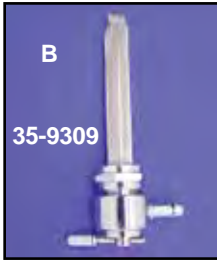

**Pingel® Fuel Valve** with nut fits 1975-94 and without nut is 3/8" NPT for 1975 and down. Unit features a metric nut utilizing right and left hand thread, so once installed adapter nut can be loosened, valve put in the desired position and nut retightened. No need to use teflon tapes meaning less chance of leakage.

**Note:** For use with 5/16" fuel line.

Chrome B-Smth	Chrome A-Hex	Polished A-Hex	Tank Spigot	Type
35-9309	35-9083	35-9082	Left	Nut
35-9310	35-9090	35-9091	Left	NPT
35-9311	35-9085	35-9084	Right	Nut
35-9312	35-9092	35-9093	Right	NPT
35-9313	35-9088	35-9089	Under	Nut
35-9314	35-9178	35-0398	Under	NPT
—	35-9087	35-9086	Down	Nut
—	35-9094	35-9095	Down	NPT
35-0218	35-0218	35-0218	Adapter, Nut Kit	
14-0571	14-0571	14-0571	Nylon Washer for Above	

**Note:** All descriptions and designs are made for a seated position on the motorcycle with the hose outlet facing a direction to ease fuel line hookup.



**Pingel® Fuel Valve Rebuild Kit** designed to work with single or dual outlet Pingel® reserve fuel valves. Rebuild kit includes enough rebuilding parts for three fuel valves plus all tools, photos and instructions are included.

VT No.	Item
35-9290	Complete Fuel Valve Rebuild Kit
35-9291*	Fuel valve rebuild components

\***Note:** Components kit has enough parts for five valves.



**Mini Petcocks** are 1/4" NPT with ball shut off. **Note:** For use with 5/16" fuel line.

VT No.	Reserve	Style
35-9071	With	Straight
35-9072	Without	90°



35-0396



35-0397

**1/4" Chrome Petcocks.**  
**Note:** For use with 5/16" fuel line.

VT No.	Type
35-0396	90°
35-0397	Straight



## POWER-FLO™



**Pingel® Power Flow Valve** has a single outlet with reserve (U-Type) is manufactured as a 1 piece billet brass unit featuring a -6AN threaded fitting for fuel line hook up using stainless steel hose fittings, line and S&S carb fitting for Super 'E' & 'G' models. Sold separately.

VT No.	Item
35-0420	Petcock
35-0421	S&S Carburetor Fitting

**Pingel® Vacuum Operated Chrome Fuel Valve** features high fuel flow with same safety features as original valve. Nut included. **Note:** For use with 5/16" fuel line.

VT No.	Side	Spigot
35-0166	L	Left
35-0167	R	Left
35-0168	D	Left or Right



**Pingel In-line Fuel Valve.** Chrome plated fuel valve for in line use features simple on/off operation without a reserve capacity and no filter. **Note:** For use with 5/16" fuel line.

**VT No. 35-0040**

**Pingel® Fuel Delivery Systems** are covered under on or more of the following patents: 4,250,921; 4,957,137; other patents pending.

Warranty on all Pingel® Products is handled by Pingel Enterprises, Inc., directly for the retail consumer.

**Petcock (Fuel Valve)** direction is determined by direction hose comes off valve when sitting on motorcycle.



**Brass Petcock for S&S "E" Carburetor bolts** directly to bowl. **Note:** For use with 5/16" fuel line.

**VT No. 35-0935**

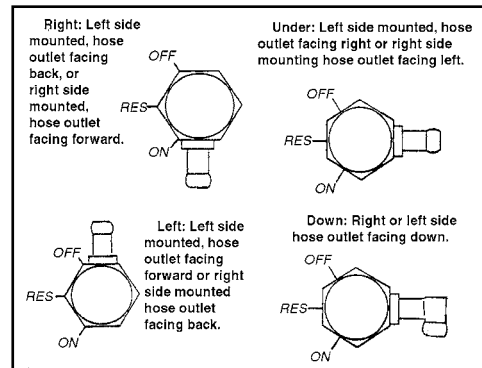

**Petcock Left Outlet with Nut Alloy** with 90° left outlet and nut. Includes nylon filter screen, washer, and reserve position.

**VT No. 35-9167**



**Wyatt's Billet Chrome Grooved Petcock** fits 1975-94 application with side exit. Nut included.  
**Note:** For use with 5/16" fuel line.  
 VT No. 35-0951



# Billet Petcock

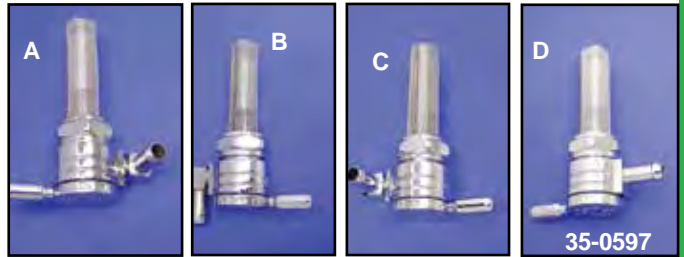

**A Backward B Downward C Forward D Straight**

**Sifton Chrome Ball Petcocks** feature a stainless steel ball bearing mechanism that provides a secure on/off seal and prevents valve from freezing in the open or closed position. Available with 3/8" NPT (Pre1975) or with 22 mm nut for 1975-94 and four outlet positions for any application. Also available with 6AN threaded fitting for fuel line hookup using stainless steel hose fittings. **Note:** For use with 5/16" fuel line.

VT No.	#	Type
35-0590	A	NPT
35-0591	A	Nut
35-0592	B	NPT
35-0593	B	Nut
35-0594	C	NPT
35-0595	C	Nut
35-0596	D	NPT
35-0597	D	Nut
35-0598		Nut/6AN



**V-Twin Hi Flow Petcocks** feature three position knob (On, Off, Reserve) with a 5/16" fuel out. Fit most stock tanks or custom tanks with a 22 mm outlet and are available in hex type with either a black or chrome finish.

Hex Type	Hex Type	Outlet
Chrome	Black	Inward Facing
35-0636	35-0639	Downward Facing
35-0637	35-0640	Forward Facing
35-0638	35-0641	



**Sifton Hex Petcock** are constructed of forged brass with screen and a brass hose spigot. **Note:** For use with 5/16" fuel line.

### Chrome

Type	Down	Rear Facing	Forward Facing
NPT	35-0685	35-0687	35-0689
Nut	35-0686	35-0688	35-0690

### Brass

Type	Down	Rear Facing	Forward Facing
NPT	—	35-0756	35-0757
Nut	35-0758	35-0759	—



**Sifton Chrome Billet Petcock** features solid brass construction and ON/OFF and reserve positions, screen and a 3/8" fitting.

**Note:** for 3/8" fuel line.

W/Nut	3/8" NPT	Outlet
35-0160	35-0579	Rear Facing
35-0575	35-0580	Forward Facing
35-0577	35-0581	Down Facing

All Petcocks are warranted for Replacement Only.

MULTI FIT/CHOPPER





# Petcock

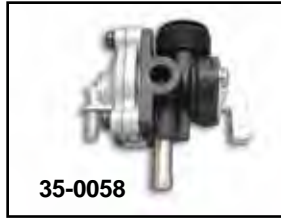

35-0838  
35-0568



**Petcocks** include nut and screen. **Note:** For use with stock fuel line.

### VT No. Fits

**35-0222** 1995-01, 02-up Big Twin

**35-0058** 1995-up XL

**35-0568** Screen, 1995-01 FXST, FLST, FLT, FXD

### Replacement Screens Only

**35-0838** Screen, 2002-06 FLT

**35-1459** 2002-06 FLT

**Petcock (Fuel Valve)** direction is determined by direction hose comes off valve when sitting on motorcycle.

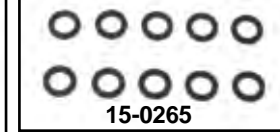

**Replica Fuel Petcocks** feature nylon filter screen, washer and reserve position. Available in chrome or natural alloy finish. **Note:** For use with 5/16" line.

Alloy	Chrome	Black	Outlet	Type
<b>35-9190</b>	<b>35-0402</b>	<b>35-0186</b>	Straight	Nut
<b>35-9165</b>	<b>35-0403</b>	<b>35-0188</b>	Right	Nut
<b>35-9193</b>	<b>35-0498</b>	<b>35-0187</b>	Left	Nut
<b>35-9167</b>	—	—	Left	Nut
—	<b>35-0405</b>	<b>35-0570</b>	1955-74 Right 3/8"	NPT
—	<b>35-0404</b>	<b>35-0549</b>	1955-74 Straight 3/8"	NPT
—	<b>15-0265</b>	—	Gasket, 10 pack	1984-up
—	<b>35-0095</b>	—	Nut, each	

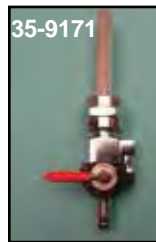

**Accel-Hi-Flow Fuel Valve** is chrome plated, high-volume, and includes nut, for 1975-94 models. **Note:** The 90° type has a 360° swivel fitting. **Note:** For use with 5/16" line.

**VT No. Type**  
**35-9171** Straight  
**35-9074** 90°



**Inner Petcock Seal** constructed for other custom style petcocks.

**VT No. Hole Type**  
**14-0909** 4 OE  
**14-0007** 3 V-Twin



### Screens Only

**35-0835** For use with the 3/8" NPT Petcocks

**35-0834** For use with the 13/16" Nut Petcocks

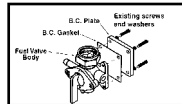

**Fuel Valve Body Vacuum By-Pass Kit** includes plate, gasket, vacuum hose plug and instructions.

**VT No. 35-0426**



**Adapter Bushing** allows use of carb type petcock on electronic fuel injection models.

**VT No. Model**

**35-0748** FX-FL

**35-0750** XL



**Weld In Petcock Inserts.**

**VT No. Type Thread**  
**38-0221** Male 1975-up  
**38-0309** Female 3/8" NPT



**Wing Type Petcock** includes screen and 2 handles, sliding valve control with reserve. Replaces 62125-55B. **Note:** For use with 5/16" fuel line.

**VT No. Type Finish**  
**35-0400** 1955-74 Chrome  
**35-9247** 1955-74 Zinc  
**35-9248** Screen only Plastic



**Replica VL-UL Petcocks** machined from brass as 3601-16 for 1916-36 models and right side 1936-39 OHV, 3601-36 fits left side 1936-39 OHV.

**VT No. OEM Type Thread**  
**35-0881** 3601-16 Zinc 1/8" x 27 NPT (Side Fitting)  
**35-0882** 3601-16 Nickel 1/8" x 27 NPT (Side Fitting)  
**35-0883** 3601-36 Cadmium 3/8" x 18 NPT  
**35-0932** Extension Fuel Shut-Off Rod

## Antique

**Petcock (Fuel Valve)** direction is determined by direction hose comes off valve when sitting on motorcycle.

All Petcocks are warranted for Replacement Only.



# Fuel Filter & Valves

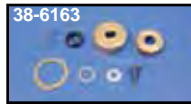
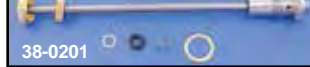
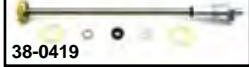
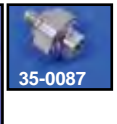
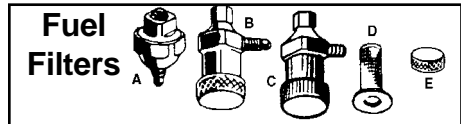
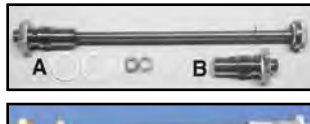

**Bob Fuel Valves** include complete shut off rod and seat assembly with left tank reserve. Includes spring and sealing washers. Replica™ Kits are cad plated.

VT No.	OEM	Fits
38-0419	Shut off Kit	1941-49 BT
38-0201	Shut off Kit	1950-65 BT
38-0232	Shut off Kit	1941-49 Big Twin, Replica
38-0231	Shut off Kit	1950-65 Big Twin, Replica
38-0198	Shut off Kit	1950-57 45 models
38-7009	Shut off Kit	1941-49 45 models
38-6653	Shut off Kit	1941-57 45 models
35-0097	62096-40	Seat Spacer
14-0153	62085-40	Brass washer, 10 pack
14-0661	62085-40	Brass washer James
35-9080		(A) Rod Hardware kit
35-0089	62075-40	Cadmium Shut off rod seat 1941-49
35-9078	62075-50	(B) Chrome Shut off rod seat 1950-65
35-9116	62075-50	(B) Cadmium Shut Off Rod Set 1950-65
38-6163		Knob and Cap
38-0416	Big Twin	Rod Only
38-0418	Big Twin	Rod Only, Viton
38-0417	45	Rod Only

**Viton Tipped**

38-0470	1941-49 BT	Viton
38-0471	1941-49 45	Viton
38-0472	1955-65 BT	Viton
35-0291		Tip Only



Fuel Strainer is complete with cap. \*Note: Screen not included.

VT No.	#	OEM	Year	Item
9659-1	B	3623-32	1932-38	Nickel Strainer
35-0087	A	3623-39	1939-41	Zinc Strainer
9661-1	A	As Above	Colony	Cadmium
35-0209*	B	62250-41	1942-49	Zinc Strainer
9660-1	B	As Above	Colony	Cadmium
35-0195*	C	62250-50	1950-65	Zinc Strainer
9662-1	C	As Above	Colony	Cadmium
8927-3	D	62265-32	All	Screen
8925-3	E	62268-32	All	Chrome Cap
15-0676		62270-32	All	Strainer Gasket (GB)
15-1157		62270-32	All	Strainer Gasket (James)
15-1100		3613-39	1939-41	Strainer Gasket
9731-3		3627-39	1939-41	Screen and Fuel Kit
2212-1				Fuel Strainer with barb fitting for hose



**Chrome Fuel Shut Off Kit** replaces old style rod type shut off on 1940-65 Big Twins with 3.5 gallon tanks. Includes line, cover for hole, fittings and valve.

VT No. 38-0202



**Fuel Tank Fitting Kit** is designed to utilize flexible hose on original style shut off valves and tanks used on 1940-65.

VT No.	Type
7807-3	Tank Fitting
7158-2	Carburetor Fitting
2821-3	Fitting

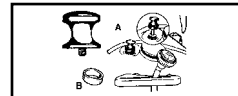

**Shut Off Hardware** for 1940-65 tanks.

VT No.	#	OEM	Item
7801-2	A	91690-49	Chrome Knob
35-0097	B	62096-40	45" Shut Off Spacer



**Fuel Valve Shut Off Tool** replaces 96365-42 to correct alignment of bottom and top holes of 1940-65 fuel tanks.

VT No.	Type
16-0615	OE
16-0182	Shop



**1941-65 Shut Off Rod Knob Kit** includes all pieces listed, knob and seal cap.

VT No.	Finish
35-0651	Chrome
38-6163	Brass
35-0691	Deco Knob



**Kleer-Thru Filter.** Glass and chrome fuel filter features nylon filter unit.

VT No.	Size
35-0517	1/4
35-0518	5/16



**Chrome Performance Fuel Filters.** Alloy case fuel filter with replaceable bronze filter element. Available in 2 fuel sizes. Outstanding filtration with a high tech look.

VT No.	Size
35-0515	1/4"
35-0516	5/16"



**Pingel® In-Line Fuel Filters** are available in chrome or polished finish, 1 1/8" long for 5/16" fuel line.

VT No.	Type
35-0519	Chrome
35-0520	Polished
35-0521	Element



**Chrome Billet Filter** radius style fits 5/16" hose with filter.

VT No. 35-0544



**Sifton Polished Compact Fuel Filter** features stainless steel filter that is washable and reusable. Machined aluminum and polished. Lengths are available in mini (1.750") or micro mini (.875").

Mini	Micro Mini	Fuel Line
35-0677	35-0676	1/4"
	35-0678	5/16"



**Chrome Billet Fuel Filter** features high flow design for 5/16" line.

VT No. 35-0635

MULTI FIT/CHOPPER





# Fuel Clamp



**Chrome Econo-Seal Hose Ends** act as clamp and finished end when stainless jacket rubber hose is cut. Micro clamp is hidden under chrome end.

Smooth	Hex	Fits	Qty
40-0222	40-0213	1/4"	6
40-0248	—	5/16"	6
40-0223	40-0214	3/8"	6
40-0224	40-0218	1/4"	2
40-0249	—	5/16"	2
40-0225	40-0219	3/8"	2
—	40-0220	1 3/16" inner diameter	1
—	40-0591	15mm	2
—	40-0592	17mm	2



**Chrome Oil Line Fitting Set** allow use of 3/8" braided steel lines. Built in compression fitting so no need for clamps. Reusable three piece set.

VT No.	Size	Fits
40-0575	1/2" NPT Thread	TC-88
40-0583	1/8" NPT Thread	Early
40-0584	1/4" NPT Thread	TC-88



**Radii Polished Stainless Steel Hose Lock** is a compression fitting that replaces conventional hose clamps. Feature a cleaner appearance and superior sealing performance. \*Note: Fits S&S Super "E" carburetor fitting

Pair	Each	Size	Pair	Each	Size
35-0180	35-0175	1/4"	35-0183*		5/16"
35-0181		5/16"	35-0182		3/8"



**Oil Fuel Line Clamp Assortment** includes pliers. Refill for clamps as noted by Oetiker#.

VT No.	Oetiker No.
16-0080	Service Kit
16-0083	Pliers only
16-0062	16700995
16-0084	16700999
16-0081	15500003
16-0085	15500009
16-0053	16701009



**Oil and Gas Hose Pliers.**  
VT No. 16-0000

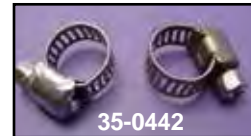

**Stainless Hose Clamps** are available in Worm Gear type, Nickel Spring type, Torro drive type. Torro drive clamps feature pressed tooth and raised band edges to prevent damage to hose. Available in two sizes and sold in packs.

Stainless Worm Gear	Nickel Spring	Size	Line
35-0442	35-8036	1/4"	Fuel
35-0413	—	7/32"- 5/8"	Fuel
35-8031	—	5/8"	Oil
—	35-8037	3/8"	
—	35-8038	5/16"	



# Vintage Steel Fuel Line

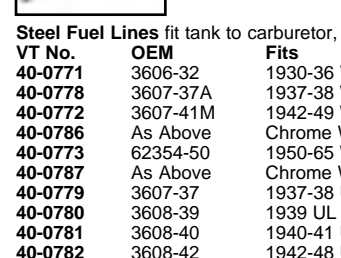
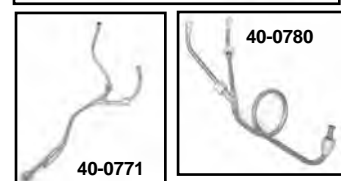
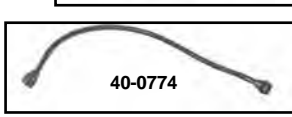
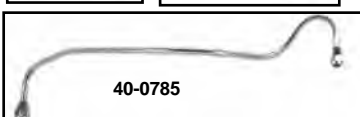
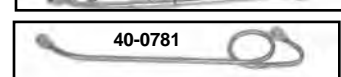
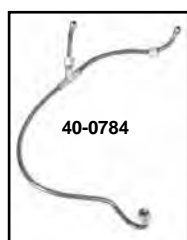

**1936-47 OHV Fuel Lines** finished in tin plate as original, unless noted as chrome.

VT No.	OEM	Year/Type
40-0783	3607-36	1936-38 (Y)
40-0784	3607-39	1939 (Y)
40-0785	3607-40	1940-41
40-0774	3607-41A	1942-49
40-0788	As Above	Chrome
40-0775	62352-50	1950-65
40-0789	As Above	Chrome
40-0903	62361-50	Fuel Line Nut, Cadmium
14-0530	62360-50	Fuel Line Rubber Sleeve fit 1950-65

**Steel Fuel Lines** fit tank to carburetor, tin or chrome finish.

VT No.	OEM	Fits
40-0771	3606-32	1930-36 VL (Y)
40-0778	3607-37A	1937-38 WL
40-0772	3607-41M	1942-49 WL, GE
40-0786	As Above	Chrome WL, GE
40-0773	62354-50	1950-65 WL, 1953-65 GE
40-0787	As Above	Chrome WL, 1953-65 GE
40-0779	3607-37	1937-38 UL (Y)
40-0780	3608-39	1939 UL
40-0781	3608-40	1940-41 UL
40-0782	3608-42	1942-48 UL
<b>Crossover (Tank to Tank)</b>		
40-0776	62355-40	1940-47
40-0905	As Above	Chrome
40-0906	62355-48	1948
40-0907	62355-48A	1949-56
40-0777	62355-48B	1957-65
38-0203	As Above	Chrome

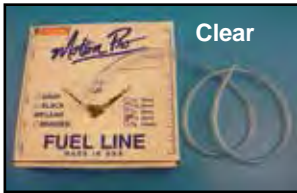

Clear



Black

**Fuel & Oil Line** is sold in 25 foot shop rolls in reinforced black or clear. \*Note: 10 foot roll.

Black	Clear	Size
40-9999*	—	1/8"
40-0117	40-1250	3/16"
40-0118	—	1/4"
40-0119	40-1252	5/16"
40-0120	—	3/8"
40-0253	—	3/8" (6')
40-0126	—	1/2"



**Braided Stainless Hose** in bulk lengths to be cut to length as needed. Use Econo-seal ends or hose clamps to attach to fitting. **Warning:** Not for use in brake systems.

VT No.	Size	Feet	Type	VT No.	Size	Feet	Type
40-0202	1/4"	10	V-Twin	40-1282	5/16"	25	Fuel
40-0200	5/16"	5	V-Twin	40-0210	3/8"	10	V-Twin
40-0245	5/16"	25	V-Twin	40-0244	3/8"	25	V-Twin

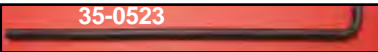

35-0523



35-0562

**Fuel Line** has a 90° pre-formed bend which is kink resistant.

VT No.	Type	Size
35-0523	S&S	19" x 1/4"
35-0561	Clear	20" x 5/16"
35-0562	Black	20" x 5/16"



**Flex Chrome Hose Covering** features heavy gauge mylar construction with chrome finish, 25 foot length.

VT No.	Size
36-0552	1/4"
36-0553	3/8"
36-0554	1/2"

# Oil and Fuel Line



35-9170

**Stainless Braided Fuel Line Kit** includes braided covered line and Econo seal chrome end clamps.

VT No.	Type	Size	Length
35-9170	Gas	5/16"	24"
35-0680	Crossover	1/4"	16"

**Braided Steel Cross Over Lines** includes chrome ends and seals.

VT No.	Model	Years
35-0242	FXD	1993-03
35-0128	FXD	2004-05
35-0244	Softail	1986-99

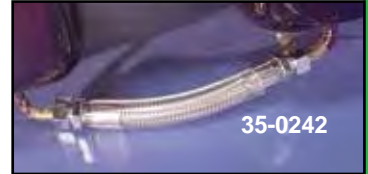

35-0242



40-0418

**Stainless Oil Line Kit** includes (1) 10 feet of 3/8" braided hose, (6) chrome econo-seal hose ends.  
**VT No. 40-0418**



**Snimp Hose Cutter** is a hand held device which quickly cuts any size rubber or nylon hose up to 3/4" diameter. Leaves hose perfectly clean and square.

**VT No. 16-0049**

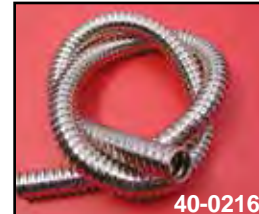

40-0216

**Chrome Metal Hose Cover** is a flexible, spring loaded covering. To install, cut to same length as hose, hose cover will compress under tension to allow installation of hose clamps for snug fit. Three feet length.

VT No.	Type
40-0215	1/4", Fuel
40-0216	3/8", Oil





# Replica Gas Caps 1936-82



1936-72 Cap Style



1973-82 Cap Style



38-7034



38-7004



38-7004 Backside



38-0315

**Chrome Stock-Style Gas Caps** fit FL type Bobbed tanks. Vented cap fits right side of dual or single cap tanks. Non-vented fits left side of Bobbed tanks.



38-7036



38-7051



38-7054

VT No.	Type
38-0310	Right, Vented
38-0534	Painted, Black
38-0311	Left, Non-Vented
38-0313	Right, Vented
38-0314	Left, Non-Vented
38-0315	Set, 1973-82
38-0312	Set, 1965-72, Chrome
38-0420	Set, 1965-72, Black
38-0540	Set, 1973-82, Black



38-7055



38-7030



38-7017



38-7033



38-0435



38-0440

**1936-82 Deluxe Chrome Gas Cap** with vent replaces bayonet type early caps.  
VT No. 38-0304

**Replica Chrome Caps** are the taller profile for the authentic look replacing 61103-36. VT No. 38-7004 vented fits right and left 36-64 FL-FLH stock tanks.



38-6688



38-6690

**Eagle Spirit Gas Caps** for bayonet style 1936-82 tanks.

Vented	Set	Type
38-6687	38-6688	Chrome
—	38-6690	Gold Inlay

**1952-70 Large Cap.**  
VT No. Finish  
38-0329 Chrome  
38-0751 Black

VT No.	Item	Year
38-7034	Vented Cap Set	1936-38
38-7047	Vented Cap Set	1941-53
38-7004	Vented Cap	1939-64
38-0751	Vented Cap Set	1939-64
38-7036	Vented Cap Set	1939-64
38-7051	Cap Set, Parkerized	1936-64
38-7054	Cap Set, Brass with zinc insert	1965-72
38-7030	Vented Cap Set	1965-72
	Vented/Non-Vented	
38-7017	Non-Vented Cap	1965-72
38-7033	Vented Cap	1965-72
38-0435	Vented Cap Set	1936-41
38-0440	Vented Cap Set	1953-64
38-0535	Vented Each	1965-70
38-0751	Black Set	1941-52
38-7049	Chrome Set	1941-52
38-0607	Black Set	1941-52



Replicas!!

**Replica Eaton Style Gas Caps** with correct knurls, depth and markings. Cam lock style.



Krommet

Satellite



38-0336 Installed

**Chrome Gas Cap Covers** fit over existing caps. Krommet has bullets. Satellite has ring.

VT No.	Years	Type	U/M
38-0551	1983-up	Krommet	Each
38-0302	1936-72	Krommet	Pair
38-0303	1973-82	Krommet	Pair
38-0336	1973-82	Krommet	Each
38-0335	1936-72	Krommet	Each
38-0300	1936-72	Satellite	Each
38-0301	1973-82	Satellite	Pair



38-0926



38-0928

**Skull Style Vented and Non-Vented Gas Cap Set**

includes a vented and non-vented cap, bayonet type. Cap body is black or chrome with a chrome or black mesh insert skull with black or chrome eyes.

Chrome	Black	U/M
38-0926	38-0928	Set
38-0927	—	Vented, each
38-1132	—	Skull, Black



**Chrome Wing Bayonet Type Gas Cap** feature a wing design. Fits 1962-1982 XL, 1936-1983 FL.  
VT No. 38-6719



38-0539

**Smooth Vented Gas Cap** fits FL type bobbed tanks. The gas cap is for the right hand side of a dual or single cap tank. This cap features a black finish. 1973-82 FL, FX, XL.

VT No. 38-0539



# Gas Cap

## 1983-up



**Chrome Steel Gas Cap Sets** are ratcheting type, vented (right) and non-vented (left) sides.

**VT No. Year**  
**38-0321** 1983-95  
**38-0320** 1996-99



**Chrome Spinner Gas Cap** fits bung style tanks.  
**VT No. Years Type**  
**38-0409** 1983-95 Vented  
**38-0429** 1983-95 Set



**1983-up Eagle Spirit Gas Caps.** Die cast design, vented or non-vented, chrome or gold plated inlay. 38-0367, 38-0368 for 1996-up w/left side dummy cap to replace fuel gauge.

VT No.	Style	Year	Type
<b>38-7000</b>	Chrome	1983-95	Set
<b>38-7001</b>	Chrome	1983-95	Right, Vent
<b>38-7037</b>	Chrome	1983-95	Left, Non Vented
<b>38-0357</b>	Chrome	1996-99	Set
<b>38-0367</b>	Chrome	1996-99	Set
<b>38-7002</b>	Gold Inlay	1983-95	Set
<b>38-0354</b>	Gold Inlay	1996-99	Set
<b>38-0368</b>	Gold Inlay	1996-99	Set
<b>38-7003</b>	Gold Inlay	1983-95	Right, Vent
<b>38-7038</b>	Gold Inlay	1996-99	Right, Vent
<b>38-0399</b>	Gold Inlay	1983-95	Left Non Vented
<b>38-0412</b>	Gold Inlay	2000-up	Left Dummy

## Air Craft Gas Caps

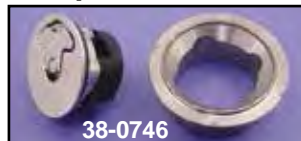

**Chrome Aircraft Style Caps** fit our tanks which accept air craft style caps.

**Caps without mount rings.**

**VT No. Description**

**38-0337** Pair Caps, Vented and Non-vented  
**38-0350** Vented Cap Only

**Caps include mount ring, gasket and screws.**

**38-0348** Pair Caps, Vented and Non-vented  
**38-0347** Vented Cap with ring, gasket and screw, without keys  
**38-0426** Vented Cap Only with lock  
**38-0352** Vented Cap Only with lock  
**14-0188** Gasket and Seal Set



**Chrome Locking Gas Caps** fit 1983-up models with bung type filler caps, supplied with two keys each.

**VT No. Type**

**38-7027** Set, Vented & Non-vented, 1983-95  
**38-7028** Vented Cap Only, 1996-up  
**38-7039** Die Cast Set, 1983-95



**Flame Gas Caps** fit vented applications.

**VT No. Type**  
**38-0541** Vented, 1996-up  
**38-0550** Set, 1996-99



**Billet Flame Cap Set** fits 1984-99 with a vented right and non-vented left threads. 38-0750 fits 2000-up with left side dummy cap to replace fuel gauge.

VT No.	Year	U/M/Type
<b>38-0747</b>	1984-99	Set
<b>38-0750</b>	2000-up	Set
<b>38-0405</b>	1983-99	Each Vented
<b>38-0940</b>	1984-99	Vented
<b>38-0941</b>	1996-99	Vented
<b>38-0942</b>	2000-up	Set



**Chrome Gas Cap Set.** Fits 1996-99 FXST.

**VT No. 38-0449**



**Gas Cap Gasket** replaces 61109-85, on 1983-up ratcheting caps.  
**VT No. 14-0561**





# Chrome Billet Cap



**Billet Chrome Kap™ Kit** features a uniquely designed insert which is permanently installed in the existing bung on bobbed tank sets on 1983-up models of Big Twin. Inserts will prevent flaking around the filler neck or conceal existing damage to finish in this area. The chrome caps thread into this insert and act as the actual gas cap. Sold in pairs.

**VT No. Year**

**38-0327** 1983-99

**38-0233** 1983-99

**16-0742** Wrench

**15-1508** Seal Ring



## Profile Gas Cap



**Low Profile Cap Set** feature polished stainless construction and peaked center.

**VT No. Year**

**38-0394** 1983-95

**38-0396** 1996-99



**Lone Star Low Profile Cap Set** available in pairs (vented or non-vented). Features star type emblem on low profile pointed style gas cap. Fits all 1996-99 all models.

**VT No. 38-0276**



**Chrome Vented Retro Gas Cap** with air craft style ring.

**VT No. 38-0745**



### Gas Tank Gaskets.

GB No.	James	OEM	Fits
14-0561	15-1065	61109-85	1983-up Gas Cap
15-0182	15-1066	61111-77	1941-82 Gas Cap
—	15-1156	61114-48	1941-82 Gas Cap Thin
15-0183	15-1067	61116-65	1965-82 Gas Cap Left
15-0265	15-1068	62172-75	1975-up Fuel Valve
15-0328	15-0201	62628-66	1966-82 BT Oil Filler Cap

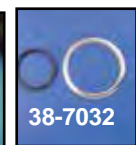
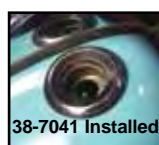

**Gas Tank Filler Rings** are of polished stainless steel, prevent paint from blistering and flaking around the filler neck and will also conceal existing paint damage in this area.

**VT No. Year Type**

**38-7029** 1936-82 Bayonet

**38-7041** 1983-96 Bung

**38-7032** 1996<sup>1/2</sup>-up Bung (Smooth Top Tanks)



**Chrome Red Baron™ Billet Caps.**

**VT No. Year Item**

**38-0422** 1983-99 Pair

**38-0424** 2000-up Pair

**38-0423** 1983-up Vented (each)



**Chrome Billet Cap Sets** are constructed from solid bar and machined for 1983-99 right and left sides.

**VT No. Style**

**38-0358** Low

**38-0359** Medium

**38-0360** Tall

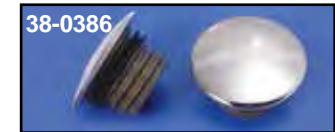
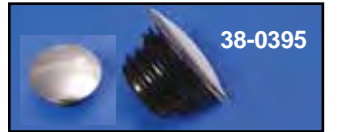

**Low Profile Cap Set** for Bob tanks 1984-up right and left side. 38-0369 features right side cap and left side dummy cap to replace fuel gauge. All sets are polished except 38-0369, 38-0378, 38-0386 and 38-0395 which is chrome.

VT No.	Year	Item	Finish
<b>38-0328</b>	1983-95	Set	Stainless Steel
<b>38-0369</b>	2000-up	Set	Chrome
<b>38-0334</b>	1996-99	Set	Stainless Steel
<b>38-0378</b>	1996-99	Set	Chrome
<b>38-0344</b>	1983-95	Vented Cap	Stainless Steel
<b>38-0343</b>	1996-up	Vented Cap	Stainless Steel
<b>38-0395</b>	1983-95	Vented Cap	Chrome
<b>38-0398</b>	1983-95	Set	Chrome
<b>38-0386</b>	2000-up	Set	Chrome



# Pop-Up Gas Cap



38-0404



38-0369



38-0366



38-0367



38-0413



38-0368

**Dummy  
Cap  
Snaps In!**

**2000-up Chrome Cap Sets** feature screw in right side with left side dummy to replace fuel gauge.

**VT No. Style**

**38-0404** Pop-Up

**38-0369** Low Profile

**38-0366** Maltese Cross

**38-0367** Chrome Left to Right

**38-0413** Peaked

**38-0368** Dummy

## Billet Cap



38-0451



38-0452

**Flush Mount Caps** are bung style and include locking tool which is also a bottle opener.

**VT No. Type**

**38-0451** Right, 1983-95

**38-0452** Set 1983-95



**Weld In Air Craft Cap Kit** includes machined insert and chrome vented aircraft cap. Insert must be welded in.  
**VT No. 38-0746**



**Mini-Screw In Gas Cap** includes weld in bung. **VT No. 38-0749**



**Chrome Pop Up Cap** fits 1996-up XL models with 2.4 gallon tank.  
**VT No. 38-5551**



38-0494



38-0493

**Air Flow Gas Cap** features a raised center section with contrast relief lines with in either a black or chrome finish. Available as a set of one vented and one non vented cap or as a vented cap only.

**Cap Sets 1996-99**

**38-0494** Black

**38-0493** Chrome

**Vented Cap Only 1996-up**

**38-0490** Chrome

**38-0489** Black



38-0355

**Chrome Pop-up Cap Set** fits right and left side on 1983-99 tank sets by pushing in center cap, the knurled portion appears and allows turning of the cap.

VT No.	Item	Year
<b>38-0355</b>	Set	1983-99
<b>38-0361</b>	Vented Only	1983-95
<b>14-0585</b>	O-Ring	All (Fits bottom portion)

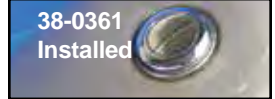

**38-0361  
Installed**



**38-0757  
Installed**



**38-0757  
Shown with  
Sealing Ring**



38-0110

**Chrome Pop-Up Cap Sets** feature built in dress ring with O-ring for seal at cap area. Sold each or set.

VT No.	Year	Item	Type
<b>38-0756</b>	1996-99	Left	Non-Vented
<b>38-0757</b>	1996-up	Right	Vented
<b>38-0110</b>	1996-99	Set	Set



38-0401



38-0402



38-0403



38-0404

**Smooth Pop Style Cap Sets** by Wyatt Gatling. 38-0404 is set with left side dummy.

VT No.	Type	Year
<b>38-0401</b>	Set	1982-95
<b>38-0411</b>	Set	1996-99
<b>38-0402</b>	Vented	1982-95
<b>38-0403</b>	Vented	1996-05
<b>38-0404</b>	Set	2000-up
<b>38-0397</b>	Dummy	2000-up



**Black Pop Up Gas Cap** is vented. Cap features a smooth finish. Fits 1996-up FXST, FLST, FXD and XL.

**VT No. 38-0565**





# Skull Cap Set



Black



Chrome



38-0926



Back

38-0926



Skull Gas Caps by Wyatt Gatling.

Chrome	Black	Year	Type
38-0953	38-0954	1984-95	Vent
38-0955	38-0956	1996-12	Vent
38-0957	38-0958	1984-95	Set
38-0959	38-0960	1996-12	Set
38-0961*	38-0962*	1996-up	Vent and Dummy

\*Note: Sets include vented cap and dummy cap for left side to replace fuel gauge.



38-0928



38-0927



38-0793



38-0789



38-0794



38-0790



38-0791



38-0436



38-1134



38-0437



38-0438

**Skull Style Vented and Non-Vented Gas Cap Set** includes a vented and non-vented cap, bayonet type. Cap body is black or chrome with a chrome or black mesh insert skull with black or chrome eyes.

Chrome	Black	U/M
38-0926	38-0928	Set
38-0927	38-1132	Vented, each



38-0439



38-0789 Installed



38-0957

Skull Gas Caps.

Black	Chrome	Type
38-0793	38-0789	Vented (Right)
38-0794	38-0790	1996-99 Left and Right
	38-0791	Right and Left Dummy
	38-0436	Set, 1984-96
	38-0437	Vented 1984-96
	38-0438	Set 1997-up
	38-0439	Vented 1997-up



Chrome	Black	Style	Years
—	<b>38-0459</b>	Vented	1941-82
<b>38-0460</b>	<b>38-0461</b>	Non-Vented	1965-82
<b>38-0409</b>	—	Vented	1983-95
<b>38-0429</b>	—	Set	1983-95



**1983-up Ratcheting Style Gas Caps** are of steel which feature low pressure relief vent recessed in cap to clear the filler neck vent tube on 1985 and later tanks. **\*Note:** For 96-99 models

VT No.	Type	Finish	Type
<b>38-0538</b>	Right and Left	Black	Metal
<b>38-0321</b>	Right and Left	Chrome	Metal
<b>38-0322</b>	Left, Non-Vented	Chrome	Metal
<b>38-0317</b>	Right, Vented	Chrome	Metal
<b>38-0307</b>	Right, Vented	Chrome	Plastic
<b>38-6685</b>	Left, Non-Vented	Stainless	Metal
<b>38-6684</b>	Right, Vented	Stainless	Metal
<b>38-0325*</b>	Right, Vented	Chrome	Metal
<b>38-0320*</b>	Right and Left Set	Chrome	Metal
<b>38-0551</b>	Krommet	Chrome	Metal

**Note: XL's use one vented cap.**



**Chrome Billet Gas Cap** features cross design. **38-0366** includes right side vented cap and dummy cap for left side fuel gauge replacement.

VT No.	Item
<b>38-0391</b>	1996-up XL-FXD, each
<b>38-0392</b>	1983-95, Set
<b>38-0366</b>	2000-up, Softail-FXDWG Right and Left side which replaces fuel gauge

# Gas Caps



**Raised Flame Gas Cap Set for 1983-95.**

- VT No. Style**  
**38-1343** Chrome Raised Flames on chrome  
**38-1342** Black Raised Flames on chrome  
**38-0936** Chrome Raised Flames on black



**Gas Caps Sets** include one vented and non-vented cap for 1983-95 Big Twins.

Chrome	Black	Style
—	<b>38-0468</b>	Techno
<b>38-0445</b>	—	Hexagon
<b>38-0446</b>	—	Button Head Hexagon
<b>38-0447</b>	<b>38-0462</b>	Techno
<b>38-0448</b>	<b>38-0466</b>	Solid Techno Style
—	<b>38-0465</b>	Black Techno with aluminum hi-lites
<b>38-0449</b>	—	Peaked Center
<b>38-0443*</b>	—	Peaked Center <b>*Note:</b> Brass Finish
—	<b>38-0463</b>	Black Techno with aluminum hi-lites
—	<b>38-0464</b>	Gear Cut
—	<b>38-0467</b>	Prismatic with aluminum hi-lites





# Emblem



**Tank Emblem Sets** include steel mount strips that can be installed with adhesive strips supplied or welded on. We suggest welding.

VT No.	Year	Color	38-0807	1966-72	Black/Off White
38-0800	1959-60	Red	38-0943	1940-46	Chrome Steel
38-0801	1961-62	Black/White	38-0384		World's Fair
38-0802	1951-54	Chrome	38-0937	Kit	World's Fair fits curved tanks
38-0803	1963-65	Black/Off White	38-0944	Kit	World's Fair fits flat tanks
38-0804	1940-46	Red/Black	38-0834		#1 World's Fair Gas Tank Emblem Set
38-0805	1947-50	Chrome	38-1643		Liberty Gas Tank Emblem Set
38-0806	1955-56	Chrome			

38-0943



**Emblems Only.**

VT No.	Type
38-0943	Chrome
38-0924	Parkerized
38-0970	Kit, chrome 1940-46
38-0946	Kit, chrome, 1936-52

# Emblem Mounts

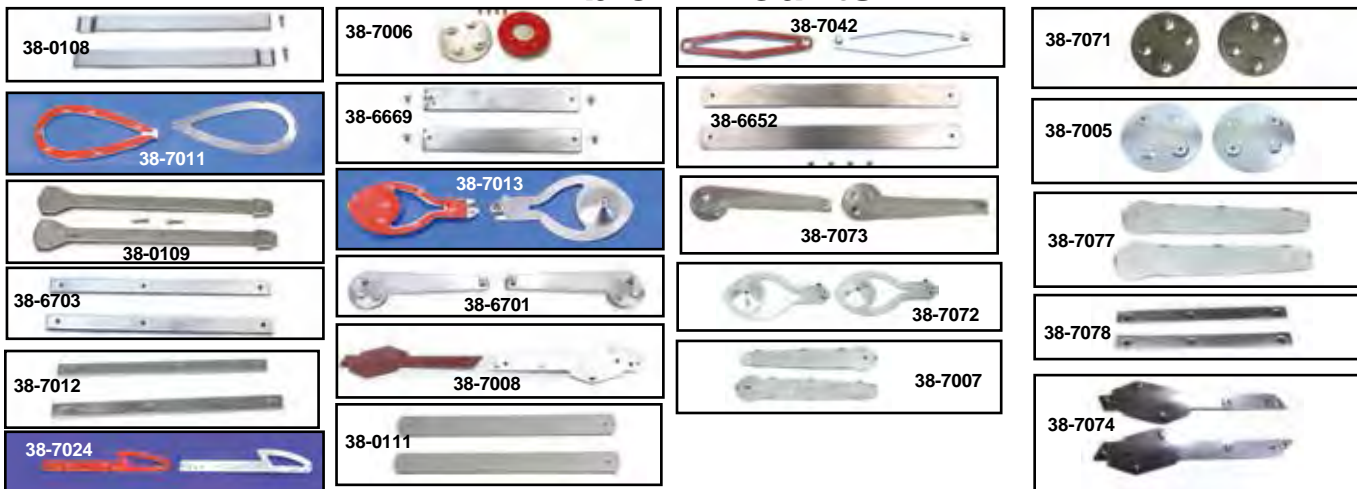

**Weld On Emblem Mounts** can be spot welded or blazed to Bobbed Tank sets. Order emblems and screws separately.

\*Note: Denotes Adhesive Mounts. NOS = New Old Stock

38-0108	1940-46 NOS	38-7024*	1955-56	38-7013*	1959-60	38-6652	1979-84 Thick
38-7011*	1940-46	38-7071	1957-58	38-7073	1961-62	38-7077	1947-50
38-0109	1947-50	38-7005*	1957-58 Curved	38-6701*	1961-62	38-7078	1951-53
38-7007*	1947-50	38-7006*	1957-58 (Original Flat)	38-7008*	1963-65	38-7074	1963-65
38-6703	1951-54	38-6669	1959-60 NOS	38-0111	1966-71		
38-7012	1951-54	38-7072	1959-60	38-7042*	1966-71		



# Emblem



**Gas Tank Emblems and Mounts.** Stock type, in pairs. Mount strips available separately with adhesive back or to be welded on. Note color of letters. Order screws separately.

Emblem	Mount	Note	Years	#	Color
38-6670	38-6669,	1	1959-60	H	Red
	38-7013	2			
	38-7072	1			
38-6162	38-6701	2	1961-62	I	Black/White
	38-7073	1			
38-1961	38-6701		1961-62		Patina
	38-7008	2	1963-65	N	Silver
	38-6703	1	1951-54	D	Chrome
	38-7012	2	1951-54		
38-7044	38-6704	1	Strips	E	Stainless
38-7045	38-6704	1	Strips		Chrome
38-6696	38-0108	1	1940-46	A	Red
	38-7011	2			
15-1095	Gaskets		For Above		
38-7022	38-7024	2	1955-56	F	Chrome
38-6698	38-7005	2, 3	1958	G	Black/Gold/Silver
	38-7006	2, 4	1957-58		For Above
38-6699	38-0109	1	1947-50	C	Red
	38-7007	2			
15-1096	Gaskets		For Above		
38-6682	38-0111	1	1966-71	J	Black
	38-7042	2			
38-6679	38-6681	1	1941-46	B	Stainless Set
	4 Pieces		Tank Trim		

**Tank Emblem Mount Screws** for years listed.

VT No.	Years
37-8829	1940-46 EL, FL
37-8828*	1947-50 EL, FL, FLH
37-9504	1951-56 EL, FL, FLH
37-8826	1959-62 FL, FLH
37-8825	1963-80 FL, FLH, FX, FXE

\*Note: Use with mounts.

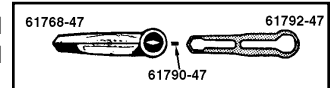

**Oil Tank Decals.**  
FLH style.  
Sold 5 pack.



**Oil Tank Decal Set.** Decal measures 3<sup>3</sup>/<sub>16</sub>" x 1<sup>3</sup>/<sub>8</sub>", pair.  
VT No. 48-0958



**Patches.**  
VT No. Style  
48-1972 Drain Oil  
48-1974 FLH  
48-1329 H Racing  
48-1328 R Racing

### Mount Type Note

1. Weld On Type
2. Adhesive Backed Type Mount
3. For Curved Surface Application
4. For Flat Surface Application



**1941-46 Tank Trim.** Stainless steel trim, emblems and mounting strips available separately.

VT No.	Item
38-6679	Stainless Steel Trim, 4-Piece
38-6681	Four Piece Mounting Strips For Above
38-6696	Emblem Set
38-0108	Mount Strips For Above
38-0943	Emblem Set





**AVON**  
TYRES



Avon 120/70 H-21  
Installed

**Avon AM-41 Tubeless Tire.** The Venom series symbolizes Avon's leading line of cruising and high load touring tires. The unique sequential tread pattern produces an exceptionally quiet ride. The multi arc tread contour provides a light, neutral turn in and exceptional cornering stability. Advanced casing technology provides for low rolling resistance, cooler running and high mileage, yet soft enough to yield high levels of grip. HB and VB are Aramid Belted.

**AM 41 Front Bias (TL)**

VT No.	Size	Note
46-0512	100/90 H-9	Wide Whitewall
46-0504	MH90H-21	Blackwall
46-0542	120/70H-21	Blackwall
46-0839*	120/70H-21	Blackwall
46-0585	130/60R-23	Blackwall

\*Note: Features high load rating than 46-0542



**Avon Cobra Tires** features a stylized tread design that balances the need of rapid water dispersal as well as tire stability and maximum resistance to wear. Available for front or rear fitment.

\*Note: Feature higher load rating than 46-0826

**AV71 Front**

VT No. Size

46-0832 MH90-21BW

**AV 72 Rear**

46-0830 250/40R18BW



**Avon AM-21 Roadrunner**  
130/90H x16" **Rear Tire** is H-rated and bears the legendary Roadrunner name and is a perfect complement to the Avon AM-20 Roadrunner front tire. Tire is blackwall only and tubeless.

VT No. 46-0221

**Tedd Cycle, the original Avon Tyre distributor since 1976!**



46-0507

**Rear AM-42 Tire**

VT No.

46-0507 MT90B16 Wide Whitewall

46-0517 150/80VB16 Blackwall (154mm)

Note

Rim Width

Min-Max

2.50-3.50"

3.00-4.00"



46-0582

**Avon Wide Whitewall Factory DA Tires** feature same quality construction as a first line tire but with just a small smudge in whitewall area.

VT No. Size

46-0582 150/80-16

Type

AM-42



46-0319

**Avon AM-20 Front Roadrunner Tire** is H-rated for speeds up to 130 mph and is designed specifically for front fitment Only. For best results, fit as a pair with the Roadrunner AM-21 rear tire. Fit only in accordance with rotation direction arrow on sidewall. The tire is blackwall and tubeless.

VT No. Size

46-0319 130/90 H16

Fits under stock fenders



**Avon Speedmaster MkII Tire** intended for front wheel fitment only. Tube type. Classic rib-style front tire.

VT No. Size

46-0015 3.25S-19

46-0018 3.50S-19

46-0016 3.00S-21



46-0359



46-0060

**Avon Safety Mileage MkII Tire** features the classic height and profile for all Big Twin and full four ply construction. For rear applications only and tube type.

VT No. Size

46-0060 5.00"-16"

46-0359 4.00"-18"

46-0360 3.50"-19"

46-0361 4.00"-19"



**Dunlop American Elite Premium Replacement Touring Tires**

- The only replacement motorcycle tire designed in America, made in America and tested in America
- Dunlop's decades-long engineering experience with bikes is the foundation for the all-new Dunlop American Elite line of replacement tires
- All-new tread design provides even tread wear and quiet operation in all conditions, both wet and dry
- Rear tire built with Multi-Tread technology with long-wearing center compound and lateral-grip shoulder compounds
- H rated for speeds up to 130 mph

VT No.	Size	Type
<b>Front</b>		
46-0443	MT90B16	Blackwall
46-0247	130/90B16	Wide whitewall
46-0235	130/80B17	Blackwall
46-0248	130/80B17	Narrow whitewall
<b>Rear</b>		
46-0444	MT90B16	Blackwall
46-0445	MU85B16	Blackwall
46-0244	180/65B16	Blackwall
46-0245	180/65B16	Narrow whitewall
46-0246	180/65B16	Wide whitewall
46-0224	200/55R17	Blackwall

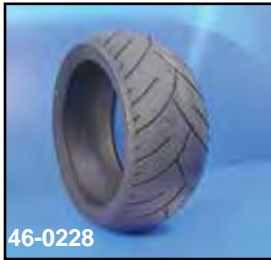

**Dunlop Elite 3 Blackwall Tires** features E3 thread pattern for superior wet pavement performance.

Front	Size
46-0233	90/90 x 21"
46-0238	130/70B x 18"
Rear	Size
46-0226	MT90HB x16"
46-0227	MV90HB x 16"
46-0237	200/50R x 18"
46-0234	240/40VR x 18"
46-0228	250/40VR x18"



**Dunlop K491 Elite II Tire** features H speed rated, front and rear tires have similar tread patterns.

46-0353

Front	VT No.	Size	Type
	46-0353	MT90-HB16	Raised White Lettering



**Dunlop K591 Rear Tire** features excellent performance under cornering stress and higher speeds. Has directional tread pattern for better wet grip, cornering and traction.

VT No.	Size	Type	OEM
46-0608	100/90V19	Front	43110-96B
46-0609	130/90VB16	Rear	40550-96B
46-0605	150/80VB16	Rear	43043-98B
46-0607	160/70VB17	Rear	42169-00A

# Dunlop Tire



**Wide White Tires** by Dunlop Touring Elite II are the stock replacements in the D402 Series.

VT No.	Type	Size
46-0339	Front	MT90HB X 16"
46-0340	Rear	MT90HB X 16"



**Dunlop D402 Touring Elite II Tire** features a new tread pattern that emphasizes better wet traction and increased rain groove stability.

VT No.	Size	Front Type
46-0308	MT90HB16	Blackwall
46-0309	MT90HB16	Single White Stripe
46-0339	MT90HB16	Wide Whitewall
46-0446	130/70B18	Blackwall
46-0447	MH90x21	Whitewall
46-0350	MH90-21	Blackwall
<b>Rear</b>		
46-0340	MT90HB16	Wide Whitewall
46-0310	MT90HB16	Blackwall
46-0311	MT90HB16	Single White Stripe
46-0624	MU85B16	Wide Whitewall
46-0415	MU85B16	Blackwall
46-0416	MU85B16	Single White Stripe

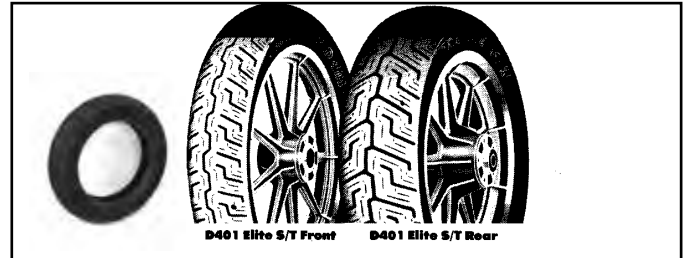

**Dunlop D401 Tire** features an advanced tread pattern and compound for improved wet and dry road grip. Front and rear have offset center groove for improved stability in rain. Rear tire has 3 ply nylon and 2 fiber-glass belts and a H-Speed rating.

VT No.	Size	Type
46-0611	150/80 B16	Blackwall
46-0448	150/80 B16	Whitewall
46-0449	150/80 B16	Wide Whitewall
46-0313	130/90 B16	Blackwall
46-0461	160/70 B17	Blackwall
46-0236	200/55 R17	Blackwall
<b>Front</b>		
46-0075	90/90 H19	Blackwall
46-0314	100/90 H19	Blackwall
46-0462	100/90 H19	Wide Whitewall



**Dunlop D207ZR Radial Tires** features aggressive tread pattern for excellent handling. Available in blackwall only.

VT No.	Size
46-0612	120/70 ZR19
46-0613	180/55 ZR18





# Metzeler

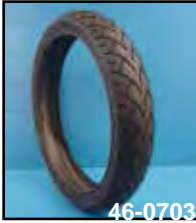

**Metzeler ME880 XXL High Performance Custom Tires** feature Silica tread compound for improved wet grip. Front tires feature rounded tread profile for smooth, neutral steering.

### Front

VT No.	Size
46-0711	140/70HB x 18"
46-0701	110/90 H x 19"
46-0702	90/90 H x 21"
46-0703	120/70 V x 21"

### Rear

46-0239	150/80B x 16"
46-0704	200/60VR x 16"
46-0706	240/50VR x 16"
46-0230	160/60VR x 18"
46-0705	200/50VR x 18"
46-0707	240/40VR x 18"
46-0229	260/40VR x 18"
46-0710	280/35VR x 18"
46-0713	300/35R x 18"



### Metzeler ME 888 Marathon Ultra Tire

- Ultra high mileage coupled with Metzeler performance and handling
- Specifically designed for custom touring bikes
- Technology offering consistent performance throughout tire's life
- Outstanding high and low speed stability and smooth handling
- H-rated and designed for speeds up to 130 MPH.

Blackwall	White	Size
46-0425	46-0417	MT90B x 16"
46-0426	46-0418	130/90B x 16"
46-0420		180/60R x 16"
46-0421		130/70R x 18"
46-0427	46-0419	130/80B x 17"
46-0428	46-0422	100/90 x 16"
46-0424	46-0423	MH90 x 21"
46-0434		130/60 x 23"
Rear		
46-0429	46-0435	MU85 x B16"
46-0430	46-0436	MT90B x 16"
46-0431	46-0437	130/90B x 16"
46-0432	46-0438	150/80B x 16"
46-0440	46-0441	140/90 x 16"
46-0442		160/70 x 17"
46-0433	46-0439	180/65B x 16"



**Metzeler ME 880 Front Tires** feature rounded tread profile for smooth steering. **Rear Tires** feature flatter tread profile and larger contact patch for better traction. Tread pattern on both front and rear tires have excellent water displacement ability. All are tube-tubeless.

### ME 880 Rear

VT No.	Size	Type
46-0625	MT90 B16	Black
46-0600	130/90 HB16	Black
46-0614	130/90 HB16	Wide Whitewall
46-0623	MU85B-16	Black
46-0601	140/90 HB16	Black
46-0700	140/90 HB16	Wide Whitewall
46-0231	140/90 HB16	Narrow Whitewall
46-0239	150/80 B16	Black
46-0240	180/65 B16	Black
46-0241	200/55 R17	Black

### ME 880 Front

VT No.	Size	Type
46-0626	MT90B16	Black
46-0602	130/90 H16	Black
46-0615	130/90 H16	Wide Whitewall
46-0232	130/90 H16	Narrow Whitewall
46-0604	80/90H21	Black
46-0242	130/80B17	Black
46-0243	140/75R17	Black



**Michelin Commander II** are designed for extended mileage and feature aramid tread plied to resist centrifugal growth and provides excellent stability. Also features a square bead wire that improves casing rigidity and ease of installation. Tubeless construction and available in H rated (up to 130 MPH) and V rated (up to 149 MPH).

### Front

VT No.	Size	Speed	Type
46-0900	MT90 B16	H	Blackwall
46-0901	130/80 B16	H	Blackwall
46-0902	100/90 B19	H	Blackwall
46-0903	MH90-20	H	Blackwall

### Rear

46-0904	130/90 B16 (MT90x16)	H	Blackwall
46-0905	140/90 B16	H	Blackwall
46-0906	150/80 B16	H	Blackwall
46-0907	180/65 B16	H	Blackwall
46-0908	160/70 B17	V	Blackwall
46-0909*	200/55 R17	V	Blackwall

\*Note: Radial

# Continental Tire



## Conti Twins™

Continental Twins available in tube-tubeless design, 510 x 16" rear profile and H rated.

VT No.	Size	Type
46-0104	MT-90 x 16" K112	Rear
46-0003	3.25 x 19" RB-2	Front



**Continental "Milestone" Whitewall Tires** available for front or rear fitment in wide or single whitewall. Features excellent wet grip and load carrying capacity.

VT No.	Size	Type
<b>Rear</b>		
46-0180	130/90 x 16"	1¾" Wide
<b>Front</b>		
46-0182	130/90 x 16"	1¾" Wide



**Black Conti Tour Tires** available in tube/tubeless and six ply rated for loads up to 990 lbs. and extended mileage. It offers exceptional wet road grip and braking. TK17 Rear, 130/90H x 16"  
VT No. 46-0334

Permissible Rim Widths	Metric	Alpha	Standard Inch	Low Profile Inch
1.60, 1.85	70	MG	2.75	—
1.60, 1.85	80	MH	3.00	3.60
1.85, 2.15	90	MJ	3.25	3.60
1.85, 2.15	90	ML	3.50	4.10
2.15, 2.50	100	MM	3.75	4.10
2.15, 2.50, 2.75	110	MN	4.00	4.60
2.15, 2.50, 2.75	110	MP	4.25	4.25/85
2.15, 2.50, 2.75	120	MR	4.50	4.25/85
2.15, 2.50, 2.75	120	MS	4.75	5.10
2.50, 2.75, 3.00	130	MT	5.00	5.10
2.75, 3.00, 3.50	140	MU	5.50	—
3.50, 4.00	150	MV	6.00	—
4.00, 4.50	160	-	6.25	—

# Tire

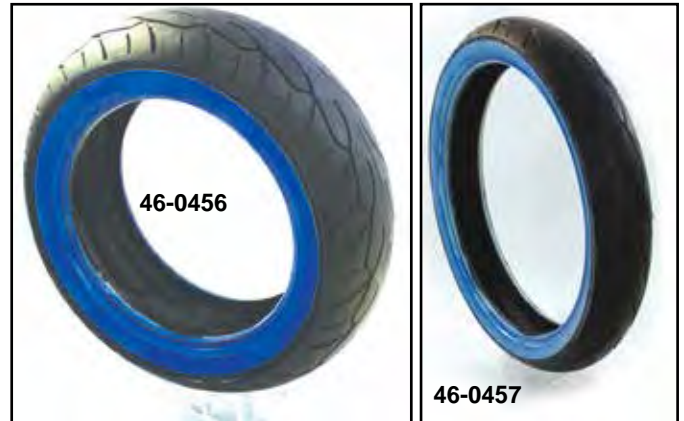

**Vee Rubber VRM302 Whitewall** featured specially formulated compound to deliver great grip in day and wet riding, all weather tread pattern, H rated construction and heavy duty sidewall construction for superior weight carrying capacity for larger displacement motorcycles.

Tubeless Construction

### VRM302 Rear Tires

VT No.	Size
46-0450	150/60B x 18"
46-0451	180/50R x 18"
46-0452	200/50R x 18"
46-0453	200/55R x 17"
46-0454	MT90HB x 16"
46-0455	150/80HB x 16"
46-0456	200/60B x 16"

### VRM302 Front Tire

46-0457	120/70H x 21"
46-0458	130/50B x 23"
46-0459*	130/70H x 18"
46-0460	MT90HB x 16"

\*Note: Can be installed on front or rear wheels.



### Shinko SR77

Blackwall	Whitewall	Size
46-0475	46-0476	130/90H x 16" Rear
46-0477		140/90H x 16" Rear
46-0478	46-0479	150/80H x 16" Rear
46-0480	46-0481	180/65H x 16" Rear
46-0482		160/70H x 17" Rear
46-0483	46-0484	130/90H x 16" Front
46-0485	46-0486	130/80H x 17" Front
46-0487	46-0488	100/90H x 19" Front
46-0489	46-0490	90/90H x 21" Front
46-0491	46-0492	120/70V x 21" Front





# Replica Tire



### Replica Coker Tires.

VT No.	Size	Type	Style
46-0256	4.00" x 18"	Goodyear	Blackwall
46-0007	4.00" x 19"	Goodyear	Blackwall
46-0342	4.50" x 18"	Good Year	Blackwall
46-0532	4.50" X 18"	Beck	2" Wide Whitewall
46-0533	4.00" X 18"	Beck	1½" Wide Whitewall



### Firestone Replica Tires, Blackwall

VT No.	Size
46-0056	4.00" x 19"
46-0057	4.50" x 18"
46-0058	4.00" x 18"
46-0059	5.00" x 16"



# Replica Tire



46-0300



46-0301



46-0302

**H.D. 240 Classic Tires** are replicas "Speed Grip" designs of the 1960's, 510 x 16 (MT-90-16) by Shinko.

VT No.	Item
46-0300	Wide Whitewall, 1.20"
46-0301	Dual White Stripe
46-0302	Blackwall



46-0304



46-0305



46-0306



46-0307



46-0322



46-0323



46-0304

**Super Eagle Replica Tires** feature classic Goodyear style of the 1960's. Available in black, wide and pinstripe whitewall, full 5.00 x 16" height and profile for the needed ground clearance on full dress models. Choose Coker or Shinko HD 270.

Coker	HD270	Type
46-0304	46-0322	Blackwall
46-0305	—	3/8" Double Whitewall
46-0306	—	1 3/4" Wide Whitewall
46-0307	—	1" Narrow Whitewall
—	46-0323	1 1/4" Narrow Whitewall
—	46-0125	Replica Super Eagle 5.00 x 16" Blackwall
—	46-0039	Safety Mileage



46-0255



46-0037

**16" Coker Tire** is available 2" wide whitewall or blackwall. Full height is 5.00" x 16" profile. V-Twin was the first to use the term **GANGSTER WHITEWALL** for motorcycle tires in 1985.

VT No.	Type
46-0255	2" Wide Whitewall
46-0037	Blackwall

**\*\*WARNING:** Newly fitted tires should not be subjected to sudden acceleration, hard cornering, or maximum power or braking for at least 100 dry miles. Loss of control and serious injury or death may be a result in doing so. By waiting till the 100 mile break in the rider will become accustomed to the feel of the new tires or tire combination. You should check and adjust inflation pressure to recommended levels after tires cool for at least 3 hours following run in.

## The original "Gangster" since 1985!



**Mini Air Compressor** powered by cigarette lighter socket or connects to battery with cables supplied. Features a compact design to fit inside a saddlebag. **VT No. 16-1634**





# Replica Tire



46-0407



46-0408



46-0411



Indian Script  
Detail



46-0000



46-0001



Diamond 46-0002

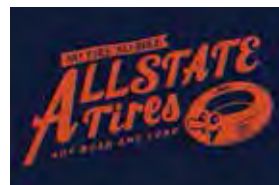

46-0002

## Firestone Replicas.

- 46-0407 5.00" x 16" Black
- 46-0408 4.00" x 18" Black
- 46-0409 4.50" x 18" Black
- 46-0410 4.00" x 19" Black
- 46-0411 5.00" x 16" Indian Script
- 46-0412 4.00" x 18" Indian Script

## All State Tires.

- | VT No.  | Size/Style               |
|---------|--------------------------|
| 46-0000 | 4.00" x 18" Dirtman Tire |
| 46-0001 | 5.00" x 16" Dirtman Tire |
| 46-0002 | 5.00" x 16" Diamond Tire |



**Wheel Balance Weights** for spoke wheels available in 10 pack.

VT No.	Oz.	Finish
37-8887	½	Chrome
37-8888	¾	Chrome
37-8889	1	Chrome
37-9099	¾	Lead
37-9100	1	Lead



**Chrome Mag Steel Wheel Type, Tape-A-Weight.**

**VT No. Weight U/M**

37-8529	5 g	360 piece
37-8530	¼	360 piece

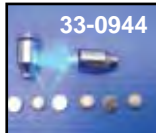

**LED Valve Stem Cover Cap**

Sets include battery.

**VT No. Color**

33-0946 Red

33-0944 Blue



**Bullet Valve Stem Cap Set.**

**VT No. 42-5040**

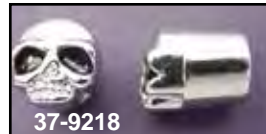
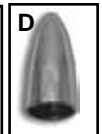

**Chrome Valve Stem Covers.**

VT No.	#	Type	U/M
37-9091	A	Steel	Each
37-9092	B	Steel	Each
42-0207	C	Rubber	10 pack
42-0016	D	Steel	10 pack
37-9218		Skull	Pair
42-2037		Piston	Pair



**Maltese Cross Valve Stem Cover Set.** Matte finish with raised outline. Fits all types of tire valve stems measures ¾" tall x ¾" wide x ½" thick.

**VT No. Type**

37-9380 Black with white outline

37-9381 Chrome



**Bead Breaker** is made of heavy duty cast iron.

**VT No. 16-1778**

# Inner Tube



**Inner Tubes** available in side (SV) or center valve (CV).

VT No.	Size	Item	Stem	Type
46-0114	16"	5.10-16	Rubber	SV
46-0115	16"	5.10-16	Metal	SV
46-0120	16"	5.10-16	Metal	CV
46-0121	16"	200/60	Metal	CV
46-0133	16"		Metal	CV
46-0160	17"	130/80	Metal	CV
46-0147	17"	160/70 & 180/60	Metal	CV
46-0161	17"	200/55R17	Metal	CV
46-0132	17"		Metal	CV
46-0122	18"	180/55	Metal	CV
46-0123	18"	240/40	Metal	CV
46-0127	18"	3.00/3.50	Metal	CV
46-0116*	18"	3.75/4.00	Rubber	CV
46-0101*	18"	3.75/4.00	Rubber	CV
46-0129	18"	3.75/4.00	Metal	CV
46-0117	19"	3.25/50-19	Metal	CV
46-0131	19"		Metal	CV
46-0118*	19"	3.25/50-19	Rubber	CV
46-0124*	19"	3.25/50-19	Rubber	CV
46-0119	21"	MH80/90 x 2	Metal	CV



46-0150	21"	100/90-21 (3.50)	Metal	CV
46-0158	21"	120/70-21	Metal	CV
46-0159	23"	130/60-23	Metal	CV
46-0065	23"	3.25/3.50-23	Metal	CV

\*Note: VT No. 46-0116 and 46-0118 have a 11.5 mm diameter valve stem for OEM type rims. VT No. 46-0124 and 46-0101 have a 16 mm valve for custom rims.

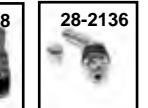

**Tubeless Tire Valves** are replacement type for mag style tubeless tire rims, use as required by factory number.

**VT No. Type**

28-2130	Stock
28-2131	Stock
28-2132	Stock
28-2137	Chrome Inner Type
28-2138	Chrome Outer Type
28-2136	Chrome Angle Type
28-2139	Inner Type ¼"



**Rim Strips.** Thick, rubber rim strips protect inner tube.

VT No.	Size	Rim	Stem Location	U/M
46-0190	16"	3"	Side	10
46-0197	16"	4"	Side	10
46-0194	16"	4"	Side	Pair
46-0189	16"	3"	Center	10
46-0196	16"	3"	Center	Pair
46-0199	16" & 21"	3"/2.15"	—	Set
46-0149	17"	4"	Center	10
46-0144	18"	5"	Center	10
46-0145	18"	6"	Center	10
46-0191	18"	3"	Center	10
46-0195	18" & 19"	3"/2.50"	Center	Pair
46-0192	19"	2.50"	Center	10
46-0193	21"	2.50"/1.85"	Center	10
46-0198	21"	2.50"/1.85"	Center	Pair

**Stock Width Rim Strip Assortment** includes two of each type stock width, ten pieces.

**VT No. 46-0188**





# Spool Wheel

52-0235



52-0200



52-0231



52-0360



52-0173

**Chrome Spool Wheels** feature billet hub with 3/4" inner diameter bearings. The wheels have 40 spokes.

VT No.	Size	Bearing
52-0235	21" x 1.85"	3/4"
52-0061	21" x 1.85"	3/4"
52-0200	21" x 2.15"	3/4"
52-0231	23" x 3.00"	3/4"
52-0055	23" x 3.00"	3/4"
52-0771	17" Wheel with tire	No
52-0173	21" x 1.85" Flat Rim	5/8"
52-0360	21" x 2.15" Drop Center	5/8"



44-0211



44-0210

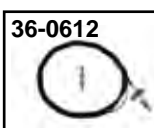

36-0612



12-0163



44-0332



23-0588

## Parts for Spool Wheels.

- 12-0163 Bearing (5/8"), pair
- 36-0612 Brake Cable for Above
- 23-0588 Front Brake Arm
- 23-0589 Front Brake Stay Bar
- 26-0522 SS Handle Assembly
- 44-0210 5/8" - 9" Acorn Style Axle
- 44-0211 5/8" - 9" Pike Style Axle
- 44-0332 Axle Spacers
- 45-0290 5/8" Spool Hub
- 45-0105 3/4" Spool Hub
- 45-0106 front spool hub for 1957-72 XL



26-0522



23-0589

Wheel Builders



Since 1969



52-0183



52-0358



52-0383



52-0186



**Chopper Style Wheels** with chrome hub, spokes and rim 27/8" wide mini brake design which includes anchor bar and cable. Both include 5/8" inner diameter bearings.

## Mini-Brake Wheel

- | Wheel   | Bearing/Axle Size |
|---------|-------------------|
| 52-0183 | 21" x 1.85"       |
| 52-0358 | 21" x 2.15"       |
| 52-0186 | 19" x 1.85"       |
| 52-0382 | 21" x 1.85"       |
| 52-0383 | 21" x 2.15"       |
| 52-0384 | 19" x 1.85"       |
| 23-3081 | Shoes For Above   |

## Bearing/Axle Size

23-3081





# Spring Fork Kits



**Spring Fork Kits** include 1" stem for use on BT and XL model, 1982-03. Order 24-0192 7/8" stem to adapt kit to 52-77 XL models. **Kit includes: Fork, Caliper Kit, SS Rotor, Fender, 21" Wheel, Axle, Riser Studs and Avon AM20 Tire**

VT No.	Length
24-1300	28"
24-1301	30"
24-1302	32"
24-1303	34"
24-1304	36"
24-1305	38"



**Chrome Fender Mount Clamps** fit front 3/4" legs to mount 50-0176 fender.  
VT No. 31-0861



- Length of fork is measured from top triple tree to rear rocker stud.
- Includes 1" stem which fits 1936-up BT, FL-FX-FXWG (except FXR-FLT)
- Unit is shipped assembled.
- Includes neck post, top nut, crown nut and top for clamp without ears.
- Outside width is 9.5".
- Fender, axle kit, risers, brake disc, wheel, headlight and mounting bracket must be ordered separately.



24-0788



**Chrome Spring Fork Assembly** by Paughco with shock.

VT No.	Item
24-0788	30" Fork Assembly Stock FXSTS Length
24-0877	36" Fork Assembly, +9" Overstock
24-0878	39" Fork Assembly, +12" Overstock

**Parts List**

44-2016	Axle Kit
23-4516	GMA Caliper Kit
23-1099	Edart Caliper Kit
50-0176	Fender
37-1961	Fender Bolts
23-8947	Stainless Brake Line
23-0319	Stainless Brake Rotor
8794-10	Rotor Mounting Screws
52-0185	21" Chrome Wheel
37-1009	1/2" — 13 Riser Studs
25-2201	5" Post Riser
31-3982	Headlight Mount
33-2155	5 3/4" Headlight



50-0176



50-0794

**Fender for Spring Fork.**

VT No.	Type
50-0176	Smooth
50-0794	Vintage

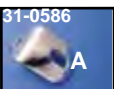

31-0586



31-0146



31-0545

**Spring Fork Headlamp Brackets** to fit Bates bottom mount lamps.

VT No.	Type
31-0586 A	
31-0146 B	



44-2016 Axle Kit



**Square Springs.** OE type springs wound with square wire with AEE chopper style!

VT No. 13-0960

**Additional Components** for Spring Fork Kits available separately.

VT No.	Item
46-0179	Avon Tire
46-0119	Tube
23-8947	SS Brake line
31-3982	Headlamp Mt
44-2016	Axle Kit
23-4516	GMA Brake Kit
37-1009	Riser Studs
36-2553	Speedo Drive



**Wide Spring Fork Assembly** features fully chromed tapered style rear legs and is available without fender mounts. Forks include 1" stem, chrome springs, top tree and bottom rockers. Accepts 1984-99 single disc brake caliper and 21" wheel. Measurement is from top tree (A) to axle center (B). Order stem kit separately to fit 1952-77 chopper model XL's.

VT No.	Length
NA	32.5" stock
24-1297	34.5"
24-1298	36.5"
24-1291	40.5"
24-1292	42.5"



25-0782



25-0783

**Tee Bar Clamp** is used in mounting tee bar handlebars with built in risers to custom Paughco or Wyatt Gatling spring forks which have 1/2" — 20 threaded hole in top. Top clamp fits on top of existing triple tree.

VT No.	Item
25-0782	T-Bar Clamp
25-0783	Mounting Hardware Kit

## Wide Spring Fork



24-1258



24-1254

**Note:** Paughco Fork Assembly utilizes a 21" wheel and solid mount fender VT No. 50-0176.

**Chrome Wide Spring Fork** with tapered oval rear legs. Features 7 3/4" inside width, 10" width between rockers, chrome plated front and rear leg, chrome springs, neck stem and top tree. Available with or without shock. Fits all Big Twins except FLT and FXR models. Rockers fit 3/4" axles only as noted.



24-1250

Without Shock	With Shock	Length Stock	Total Length
24-1250	24-1260	27"	27"
24-1253	24-1261	+6"	33"
24-1254	24-1262	+9"	36"
	24-1263	+12"	39"
	24-1263	+15"	42"
24-1256	24-1264	+18"	45"
24-1257	24-1265	+21"	48"





# Springer Components



50-1213



50-0680

**Stock Skirted Front Fender** to fit 1997-up FLSTS models. Replaces 59164-97.

**VT No. Item**

50-1213 VT

50-0680 Bushings



50-0176



50-0268



50-1568



50-0570



50-2011



50-2012

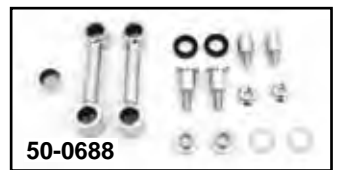

50-0688

**Raw Fenders** for FXSTS models for use with 21" wheels.

**VT No. Year Bracket**

50-0176\* 1989-92 Chrome

50-0268 1989-92 Raw

50-1568 1988-92 Chrome

50-1204\* 1989-92 Chrome

50-0570 1993-up Raw

50-2011 1993-up Raw

50-2012 1997-up Chrome

\*Note: Chrome fender with chrome brackets.

**Front Fender Chrome Mount Kit** for 1988-up FXSTS.

**VT No. 50-0688**



33-0533

Installed



**Chrome Front Signal Relocation Mount** fits 1988-up FXSTS models with factory Spring Fork. These chrome brackets move the signals to the spring bracket behind the springs. Order light separately.

**VT No. 33-0533**



23-1099



23-4516



23-1099 Installed



23-4516 Installed



23-0940

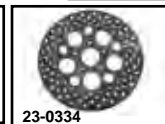

23-0334



23-0538

## Chrome Caliper Kit

includes chrome 2-piston caliper and brackets.

**VT No. Brand Finish**

23-4516 GMA Anodized

23-1099 Edart Chrome

23-0940 Chrome

23-0334 Rotor Stainless

23-0538 Rotor 2000-up

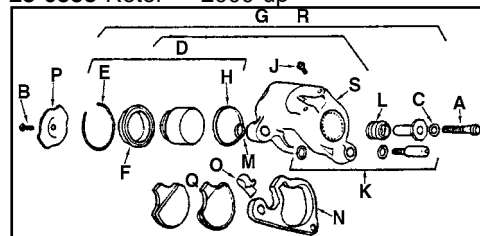

## 1984-99 Front Calipers and Components.

VT No.	#	OEM	Item
37-8822	A	855	Screw
Kit	B	3517	Screw
1983-92	C	6019	Washer
37-0800		As Above	1993-99
23-2279	D	44020-83	Piston Rebuild Kit
12-0977	E	44021-83	Retainer
23-2275	F&H	44047-83	Dust Boot with Seal
23-1981		—	Caliper Strap, FXSTS, 1993-up
23-3083	G	44077-88D	Right, 1988-99 FXSTS, Black Complete
23-1982			Caliper Anchor, FXSTS, 1993-up
23-1981			Caliper Strap, FXSTS, 1993-up
23-1572			Strap Kit
23-0455		44030-88	FXSTS 1988-up Caliper Bracket
		Bushing	
23-1731	J	44048-83	1991-99 FXDWG-FXDG (Black) Bleeder, 10 pack
23-2274	K	44053-83	Guide Pin Kit for 1984-92 Big Twin, 1993-up FXSTS
23-9226	K	44053-92	Guide Pin Kit for 1993-99 All Big Twin except FXSTS
28-2133	L	44054-83	Boot, each
14-0563	M	44059-83	O-Ring
23-2308	N	44072-92A	Bracket, Left
23-9925	N	44073-92A	Bracket, Right
23-2306	O	44061-83	Spring Clip
23-2307	P	44062-83	Retaining Pad
23-0512	Q	44063-83	Pad Set with B

# Calipers



23-3083

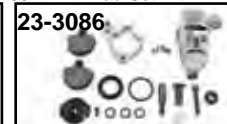

23-3086



23-3087

**Front Calipers** include all internal components.

VT No.	OEM	Side
23-3083	44077-88D	Right, FXSTS 1988-07, Black
23-3086		Right, FXSTS 1988-06, Chrome
23-3087	44079-97B	Left FLSTS 1997-06, Black
23-3088	44079-97B	Left FLSTS, 1997-06, Chrome

# Spring Fork



### Fork Components.

Year	Model	Leg
49-0521	49-0523	FLSTS Front
49-2192	49-0527	FXSTS Rear
49-1172		Sleeve for reinforcing rear leg
49-0844		1997-2005 FLSTS Black
49-0866		FLSTS Black
49-0840		FLSTS Black/Chrome
24-1462		1988-up FXSTS
24-1463		FLSTS 1997-up chrome
24-1600		Rear Leg, FLSTS 97-2008
49-0030		Kit with 21" wheel
49-1517		Rocker and Stud Kit
49-1612		Rear Leg
49-1785		Chrome Damper Cover Kit

### Axles.

Year/Model	Kit	Spacer	Nut	Kit Axle	MM	OD
2000-up FXSTS	44-0615	—	2032-4	44-0083	—	.750"
2000-05 FLSTS	44-0631	—	—	44-0358	41	.750"
1997-99 FLSTS	44-0939	2364-5	—	44-0358	41	1.00

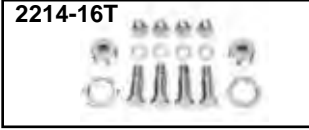

**Chrome Complete Rocker Bolt Kit** includes all components needed to mount rockers.

VT No.	VT No.	Year	Model
2213-16	2213-16T	1997-up	FLSTS
2214-16	2214-16T	1988-2006	FXSTS

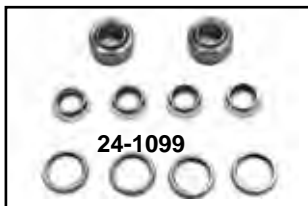
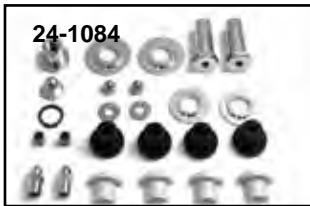

### Hardware Kits.

- 24-1084 Complete
- 24-1099 Rocker Bearing Kit
- 49-0463 Rocker Set, FXSTS, chrome
- 49-0870 Rocker Set, FLSTS
- 49-0738 Rocker Set, FLSTS, Black

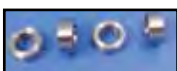

**Solid Handlebar Mount Kit** fits 1997-up FLSTS models. Risers not included.  
VT No. 28-0656

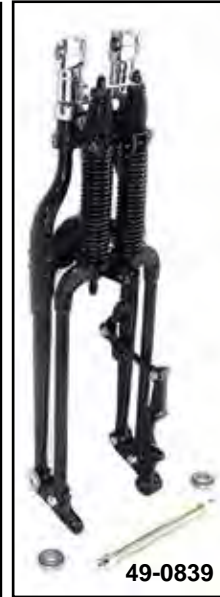

**Complete Spring Fork** \*Note: Includes chrome springs and rockers.

Chrome Black	Black with chrome	Fits
49-0843	49-0839	49-0835
49-0844	49-0866	49-0840
		FLSTS
		FXSTS

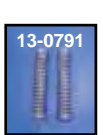
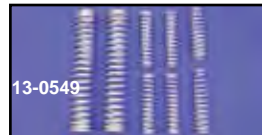

**Complete Spring Set** includes upper, lower, and inner, a 8 piece set. Fits 1988-2006 FXSTS.

VT No.	Qty	Type
13-0549	8pc	Complete
13-0790	4pc	Inner
13-0791	2pc	Lower
13-0934	6pc	4 inner, 2 large lower
13-0935	2pc	2 Upper
24-1061		Bushing Set
24-1062	2pc	Rod Set



**Riser Stud Conversion** for 1988-2006 FXSTS will accept 1/2 x 13 threaded inner diameter studs.  
VT No. 37-0899



**Billet Top Tree** fits 1988-up FXSTS models to allow risers or one piece bars with 3.5" center distance to be installed.

VT No.	Year	Model
24-0994	1988-2006	FXSTS
24-0995	1997-2003	FLSTS



**Riser Stud Kit** fits 1988-2006 FXSTS models with stock risers. Kit includes studs and poly Iso bushing set for a more firmer riser mount.  
VT No. 28-0289



**Replica Riser Stud Set** fits 1988-06 FXSTS.  
VT No. 28-0879





# Retro Rigid™



Cincy Flyer from the 2008 show, built with the 51-1957 frame.



**Replica Retro Rigid Frame** features original style construction including forged parts in neck, side car mounts and rear axle areas. 10¼" between the rear axle plate. Order rear mount for TC-88 models separately.

Frame will accept:

- Evolution or TC-88 engine, Shovelhead, Panhead, Knucklehead
- 5 or 6 Speed Softtail Transmission
- Flatside Tanks
- Softtail Oil Tank
- 230 Rear Tire with chain
- 200 Rear Tire with belt
- +2" Raised Neck
- Stock Rake, 30°
- Order related parts separately.
- **31-0859** Oil Tank Bracket
- **44-1942** axle kit
- **44-1946** axle collars

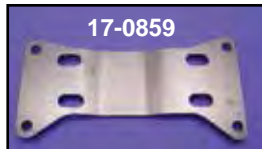

### VT No. Style

**51-1948** Wishbone

**51-1957\*** Straight Leg

\*Note: Will not accept seat post

• **Related Parts for 1" offset.**

### VT No. Item

**17-0859** 5 Speed Plate

**19-0570** Motor Spacer

**31-0859** Oil Tank Bracket



## Skid Plate



**Steel Skid Plates** replaces 24490-36, 1936-99 Big Twins.

### VT No. Finish

**42-0101** Chrome

**42-0098** Stainless

**42-0117** Black

**42-0777** Chrome, Smooth



# Rigid Frame



**Protective Sleeve Tubing** will protect frame tubes from damage when installing motor. 10 foot tube is sliced to fit over frame tube.

VT No.	Size
51-0700	1 1/8" Inner Diameter
51-0701	1 1/2" Inner Diameter

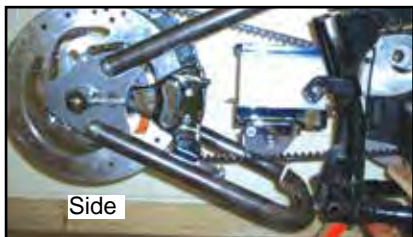

## FXD



**Bolt On Hard Tail Units** to 1990-98 FXD-FXDWG models. Use stock rear wheel or fit up to 200mm width. Order battery box separately.

VT No. 51-0786



**Frame Inserts.** Right angle design allows to be cut for neck or rear axle plate reinforcements.

VT No.	Type
51-3542	Flame
51-3543	Web
51-5549	Maltese

**Stock Rigid Frames** are available in either wishbone or straight leg style. Features stock neck for Wide Glide triple trees and bobbed mounts. No stretch or rake. Does not accept a seat post. Evolution style accepts flatside fuel tanks.

### 4-Speed Rear Chain Drive

Wishbone Type	Straight Leg	Motor	Brake
51-2151		Evolution	Disc

### 5-Speed Rear Belt Drive

51-2155*	Evolution	Disc
----------	-----------	------

\*Note: Can only be used with FXST transmission mount and FXST Style Oil Tank, 40-0394 or 40-0396. Accepts flat side tanks.

## Weld On Mounts

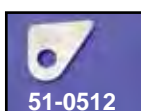
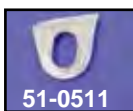

**Weld On Mount Tabs** fit Rigid Frames when mounting brake units.

VT No.	Type	Year	Axle
51-0511	Hydraulic Rear Back Plate	1958-72	
51-0512	Caliper Arm Tab	1973-99	
51-0513	22-0582 Caliper Mt Strap, Right Side	1987-99	3/4"
51-0846	Caliper Mount Strap, Right Side	2000-05	
51-0673	Mount Strap, Right Side	2006-up	
51-0845	22-0763 Caliper Mt Tab, Left Side		3/4"



**250 Ultra-wide 38° Rigid Frame** by Wyatt Gatling. Made of 1020 DOM (Drawn Over Mandrel) steel tubing. Frame is single tube. Legs are 1 3/8" outside diameter, .125" thick wall and 8" stretch. Backbone is 1 1/2" outside diameter with .219" thick wall and 26" long. 1" rear axle included. TIG welded. Accepts 11" fender. Softail style oil tank and 250 rear tire with full width 1.5" belt. Integral 5th bolt mounting within reinforced offset transmission plate. Requires a 1 1/4" engine-to-inner primary spacer. Requires gas tank mounts, coil mounts and regulator mounts must be determined by the builder.

VT No. 51-0115





# Hard Tails

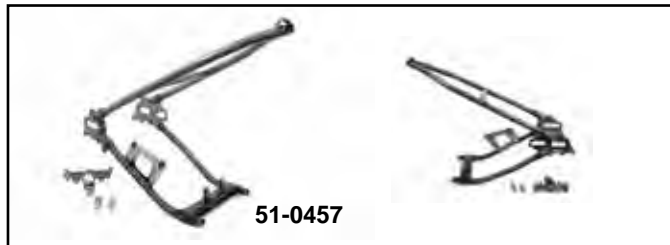

**Bolt On Hard Tail Units** to 1990-98 FXD-FXDWG models. Use stock rear wheel or fit up to 200mm width. Order battery box separately. Bottom attaches to swingarm pivot point to aid in alignment.

**VT No. 51-0786**

**Note:** Attachment points, we recommend installation be completed by a qualified technician.

**Big Twin Weld-On Hardtails** fit to stock frames for 1958-85.

VT No.	Drive	Style	Year
51-0920	Chain	Drum	1958-84
51-0781	Drum	Drum	1958-84
51-0782	Belt	Disc	1985-99
51-0457	Chain	Drum	1958-84

# Big Twin Custom Rigid Frame



**Big Twin Custom Rigid Frames.** Straight leg style rigid frame for 4 or 5-Speed with or without bobbed mounts. Features 2 1/4 stretch in front down tubes and 35° rake. Stock is 30°. Stock type neck accepts Wide Glide trees. Evolution style accepts flat side tanks, Shovelhead style accepts 1936-83 bob tanks.

**4-Speed Rear Chain Drive**

W/Bobbed	Without Bobbed Mt	Motor Type	Brake Type
51-2156		Pan/Shovelhead	Juice/Disc
51-2157	51-2159	Evolution	Disc

**4-Speed Rear Belt Drive**

Motor Type	Brake Type
51-2160	51-2162
	51-2163

**5-Speed Rear Belt Drive**

Motor Type	Brake Type
51-2164	51-2165
	51-2167



# Tall Chopper Frame



**Tall Chopper Frames** feature 4" stretch in backbone, 8" stretch in downtubes and 45° rake. Available for Evolution type motors. Accept Softail oil tank, 6° billet trees with internal fork stops and should be used with +16" overstock fork.

VT No.	Type/Speed/Drive	Tire
51-2186	Evolution Softail 5 Spd Brake Belt	180
17-6661	Transmission Mount Plate for 51-2186	
24-0067	Billet Trees	
24-0968	+16" Fork Tube Assembly	



# 300 RSD Frame



**300 Right Side Drive Chopper Frame by Wyatt Gatling** features full rigid styling with single or double tube motor carriage. Frame will accept round oil tank and up to 4" extended gas tanks. Neck is drilled for internal stop kit. Motor and transmission are in the stock position and no offset is required when using the right side drive transmission. 1" axle included. Both styles include billet front motor mount. The **51-3502** 300 Series features 1 3/8" tubing with 1 1/2" backbone. **51-3502** features 4" stretch in backbone and 6" in downtubes.

**VT No. 51-3502**

**Recommended Parts List.**

VT No.	Type
20-0586	Belt 1.125" 133T
44-0669	Adjuster, 2 piece
44-0676	Axle (300)
52-0682	Wheel (or 52-0684) (300)
46-0709	Tire, Avon (300)

17-0455	Transmission
44-0688	330 Right Side Spacer
44-0689	330 Left Side Spacer
27-1729	Kickstand Stop
27-1785	Weld On Kickstand



**Frames include a one piece billet front mount which bolts in.**



**Single Tube Chopper Frame** features full rigid styling by Wyatt Gatling. Frame will accept round oil tank, and up to 4" stretch gas tanks. Neck is drilled for internal stop kit. Frame has built in 3/4" offset to accommodate the 200 tire. Order inner primary or motor spacer plate with 3/4" offset. Frame details include: 1 3/8" tubing, billet rear axle plates, billet front motor mount, accepts 200 series tires w/1.5" belt, 4" stretch in downtubes, 38° rake, 2" stretch (backbone). Axle included.

**VT No. 51-3501**

**Order related components separately.**

VT No.	Item
44-0393	Rear Axle
20-0478	133T Belt (1.5")
20-0586	133T Belt (1.125")
19-0564	Alternator Flange Offset Plate
44-0669	Wheel Adjuster Set
40-0476	Chrome Oil Tank
40-0477	Raw Oil Tank



**Transmission Mounting Plate** for Paughco Frame 51-0113 which is not available.

**VT No. 17-9957**

# 200 Frame



**200 Wide Drive Frame** available with Bob mounts. Features rake of 34 degrees. 4" stretch downtubes. Made of 1026 DOM (Drawn Over Mandrel) steel tubing. Legs are 1.25" outside diameter with .125" thick wall. Backbone is

1.500" outside with .187" thick wall. Seat post is 1.500" with .187" wall. Included additionally rear axle and front oil tank mounts. Special features include TIG welded at stress points. Accepts 9" fender and 1984-up flat side gas tanks. Accepts Softail style oil tank, Softail style rear brake 87-up and up to 200 series tire with belt. Accepts 200 series tire with use of 1/2" offset kit not included. **VT No. 51-2050**





# Toolbox



**Replica Oval Tool Boxes** are for right side use and include keys, 48-3094 is leather pouch insert for oval tool boxes. Tools not included.

VT No.	OEM	Type
50-0600	64205-40C	Chrome
50-0605	As above	Left Side
50-0601	64205-40A	Black
50-0615*	64205-40B	Raw
50-0608*	64205-40B	Chrome
50-0603	64340-26	Key Set
50-0620	Parkerized	Keys
48-0570	Nylon Liner	
50-1544	Right	Round Key, Chrome
50-1547	Left	Round Key
16-1007		Tool Kit

\*Note: Requires purchase of appropriate mounting kit which includes correct knob as listed.



**Rigid Toolbox Kit** includes a raw bracket and a tool box.

VT No.	Finish	Type
50-0926	Chrome	Oval, 1941-57
50-1186	Black	Oval
50-0621	Black	Oval, 1941-57
50-0341	Black	Rectangle
50-0041	Black	Rectangle

1226



**FXST-FLST Tool Box Kit** is chrome ribbed. Includes 2 keys, mount bracket, footpeg spacer and hardware.

VT No.	Item
1984-99	
50-0604*	Right Side Kit
50-1012	Left Side Kit

\*Note: Fits all 1984-99 FXST models except FLSTF & FLSTN.  
**2006-up FXD, FXDWG**  
 50-2025 Right Side



**1977-84 FLH Toolbox Kit** fits right side and contours rear shock and bolts to rear battery tray and exhaust tube mount. Kit allows use of FXE or FLH exhaust.  
**VT No. 50-2022**



**Brackets Only for Toolbox** mounting on 1984-99 Softails.

VT No.	Kit	Side
31-1986	Kit	Right
31-1990	Bracket	Right
31-1991	Kit	Left
31-1989	Bracket	Left
31-1992	Bracket	Right

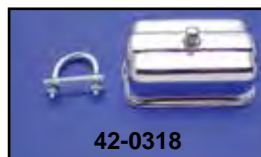

**Spark Plug Holder** clamps to the rear frame tube on Rigid Big Twins. Holds two spark plugs.

VT No.	Finish
42-0318	Chrome
42-1537	Black



# Rigid Sissy Bar

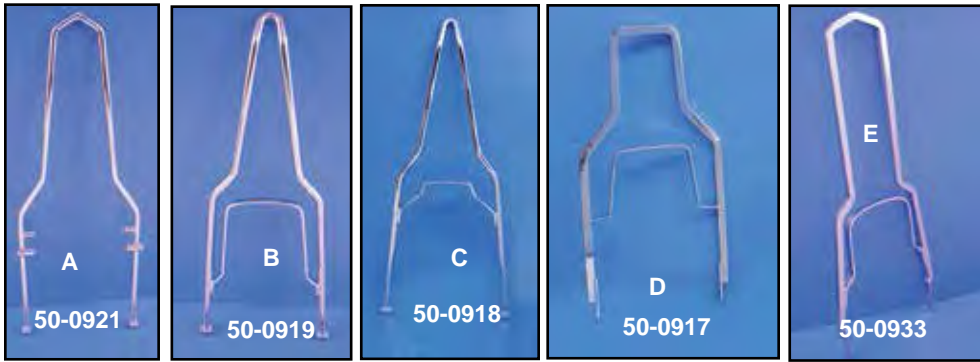

**Chrome Round Sissy Bar** is constructed of 1/2" round steel to fit flat fender with belt drive. Height is 31" and width is 8-9".  
**VT No. 50-0944**

**Rigid Frame Sissy Bars** of 9/16 solid steel bar for Bobbed or 5" or 6" flat steel fenders.

**Note:** Height is measured from bottom of bar to top.

VT No.	#	Style	Type	Height	Stock
50-0921*	A	New Style	Bobbed	28"	Round
50-0919	B	Tilt Top	Bobbed	28"	Round
50-0918	C	Tilt Top	6" Flat	26"	Round
50-0917	D	Square Top	Bobbed		23" Square
50-0933	E	Square Top	Bobbed		28" Square

\*Note: Bolts through side of fender.

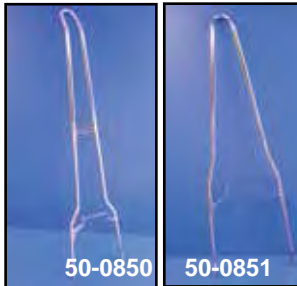

**Chrome Round Stock Sissy Bar** for use on Captain America replicas. For Rigid frames only with 5" or 6" flat or ribbed fender.

VT No.	Height
50-0850	49"
50-0851	33"

Use Cross Bar on Sissy Bars to Mount Tail Lamp Bracket and Lamp



**Round Sissy Bars** by Paughco are of 1/2 round stock 24" tall and 10" wide at bottom for belt or chain applications.

VT No.	Style
50-0936	Bobbed
50-0937	Flat Fenders, 5" and 6"

## Fender Braces

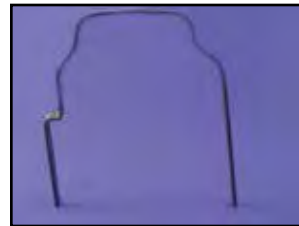

**Raw Fender Brace** features off-set for pulley and wide wheel with 9" fender.

**VT No. 50-0534**

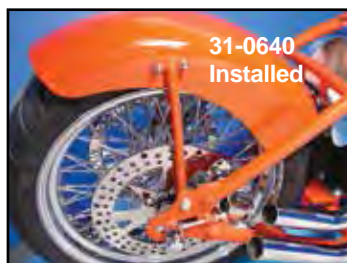

**Rigid Rear Fender Brace Set** is a two piece style which allows any width fender to be bolted to these bars.

VT No.	Finish
31-0559	Chrome, 9.5" long, Top Mount Holes 5/16" Diameter
31-0640	Raw, 9.5" long

**Rigid Fender Braces** are chrome plated steel with preformed bends of heavy 1/4" steel. Available for bobbed or flat fender.

VT No.	Fender Type	Finish
50-0922	Bobbed	Chrome
50-1217	Bobbed	Black
50-0939	Flat, 7	Raw
31-1051	Tab Set	



**Dog Bone Strut Set** for Rigid.

VT No.	Finish
31-1053	Raw
31-1054	Chrome





# Front Fender

Wyatt Gatling Steel Front Fenders. Laser cut from full one piece blanks. Spacers required for use on 41 mm glide forks for 19" or 21" wheels. **Note:** We suggest pre-fitting all fenders before painting.

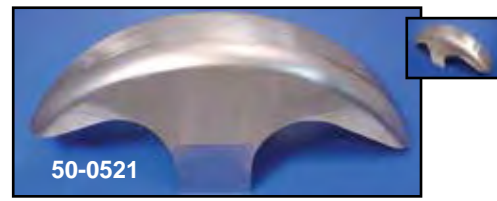
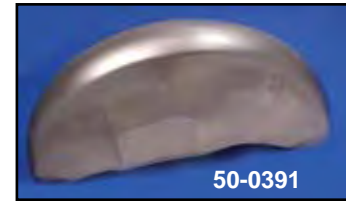
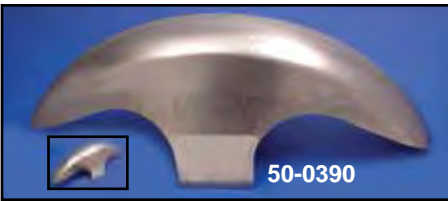
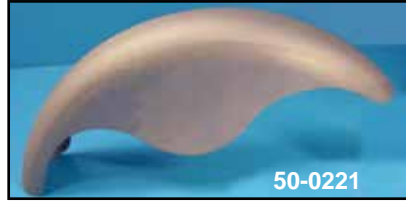

Chrome Fender Mounts are to mount custom fenders to wide glide forks.

All Fenders Require Determination of Hole Location and Drilling to Mount

VT No.	Thick
50-0579	.750"
50-2230	.375"
50-2231	.25"
50-2232	1.00"
50-2233	.750"

VT No.	Degree Coverage	Wheel Diameter	Outside Diameter of Bracket	Inside Width of Fender
50-0256	140°	19"	5 1/2"	4 3/4"
50-0221	140°	19"	5 1/2"	4 3/4"
50-0223	168°	19"	5"	4 7/8"
50-0225	168°	19"	5"	4 7/8"
50-2047	168°	19"	4 7/8"	4 3/4"
50-0111	180°	19"	5"	4 7/8"
50-0389		21"		
50-0390		21"		
50-0391		21"		
50-0521	140°	21"	8"	4 7/8"

## Universal Front Fenders



Spring Style Front Fender fits 18", 19", and 21" wheels. Brackets must be fabricated.

VT No. 50-0780

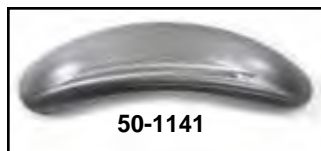

Universal Sport Style Front Fender is rolled on edge and in front. Chrome and primer. The brackets are not included.

VT No.	Type
50-0133	Chrome (drilled)
50-0195	Plain
50-0196	Chrome
50-1141	Plain (48)

Wyatt Gatling 9" Custom Round Profile Sabre Rear Fender features a raw steel finish.

VT No. 50-0038

Plain Front Fender is 6" wide, use brackets to mount FXWG or FLH lower legs with 16" wheels less brackets.

VT No.	Type
50-0769	Flat
50-0883	Round without mount holes



Decorative Skull Emblem for fender. VT No. 48-0250



5" Steel Ribbed Fender features a raw finish with a rolled edge. VT No. 50-0433

**Note: All Items Shipped with a Raw Finish may have some oxidation (rust on surface)!**

# Strutless Rear Fender



2mm Thick Steel Strutless Rear Fenders for Softtail models.

VT No.	Width	Tire
50-0216	8¾"	200
50-0251	9"	200
50-0217	10"	230
50-0242	12½"	280-300

50-0242 use 50-0248 extension brackets to mount 50-0242 to wider frames



**Dresser Style Rear Fender** undrilled, fits models with modification.

VT No.	Width
50-0942	6.5"
50-0471	7.5"
50-0860	8.0"
50-1517	8.6"
50-1525	9.0"
50-1190	9.0"

**Note: All Items Shipped with a Raw Finish may have some oxidation (rust on surface)!**

# Rounded Fenders



**All Fenders are Steel!**  
**Ready for mock up...in raw finish**



**Round Profile Chopper Fender** features round British style, raw finish.

Smooth	Ribbed	Width
—	50-0281	4"
—	50-1586	4"
50-0584	—	5"
50-0519	50-1579	6"
50-0611	50-1578	7"
—	50-1580	8"
—	50-1581	9"
—	50-1582	10"



7" Rib Fender installed on Rigid Frame with 31-0559 chrome bars

**All Fenders are Steel!**

# Hardware

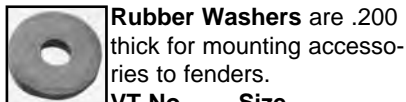

**Rubber Washers** are .200 thick for mounting accessories to fenders.

VT No.	Size
37-8869	¼", 20 pack
37-8870	⅝", 20 pack



**Weld On Mount Spool** with ⅝" x 24 thread.  
VT No. 51-0588



**Custom Fender Mount Kit** includes rubber bushings.  
VT No. 31-0718

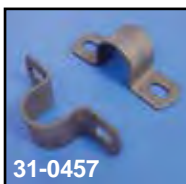
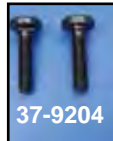
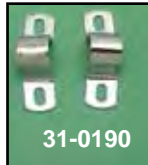

**Fender U Clamp** is used on 1936-57 Rigid models. Secures rear fender to frame cross tube. Replaces 59800-36.

VT No.	Finish	Note
31-0190	Chrome	Order chrome carriage bolts separately
31-0457	Parkerized	Rear Fender Mount U-Clamps
37-9204	Parkerized	Bolt set, when using rear frame bar
37-1507	Chrome	Carriage bolts



**Flat Washers** used for mounting fenders and rails. Measures 1¼" diameter with a ⅝" bolt hole, sold in 10 packs.  
VT No. 40-0604

MULTI FIT/CHOPPER





# Rear Fender



50-2044

Custom Round Profile Fenders, raw steel.

VT No.	Width"	8.5" thru 12" fenders spacing may be required!
50-2046	11"	
50-2044	11.5"	

## Flat Fenders



50-0167  
Plain End



50-0161



Plain  
Bobbed  
50-0166



8.5"  
50-0209  
Plain  
Bobbed

Unfinished Heavy Duty Flat Fenders are rolled of 16 gauge steel, available in 5", 6", 8", or 9" widths and may require trimming and finishing for chain relief. **Note:** The 5" and 6" fenders are 1/4 deep, the 7", 8", and 9" are 1/8" deep. Note: End shape.

VT No.	#	Width	Finish
50-0160	A	5"	Plain
50-0162	A	6"	Plain
50-0161	A	6"	Chrome
50-0166	B	6"	Plain Bobbed
50-0208	B	7.5"	Plain Bobbed
50-0209	B	8.5"	Plain Bobbed
50-0243	B	9"	Plain Bobbed



Chrome Set U Clamp Set is used on Rigid models to secure rear fender to 1" frame cross tube. VT No. 31-0190



50-0213



50-2052

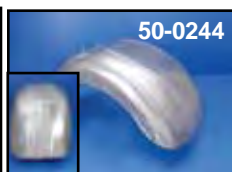

50-0244

Rear Steel Fenders by Wyatt Gatling. Smooth formed and undrilled for builders application. Length is tip to tip. End to end is 27.5".

VT No.	Width	Length
50-0213	10"	34"
50-2052	12.75"	38"
50-0244	13.5"	38"

1230



Pro Stretch Fender is 11" wide constructed of 2mm steel. VT No. 50-2045



50-0583  
Installed



Curved Strut Set fit 11" fenders on Softail models. VT No. 50-0583



Rigid Bobbed Left Rear Fender for is 7 1/4 wide by 5 1/2" deep with raw finish, with left cutout, 50-0928 includes bracket to accept tail lamp plate.

VT No. Item  
50-0152 Plain  
50-0928 With bracket



9" Wide Steel Rear Fender Bobbed Style fits FXST struts when used on 1986-99 wide style frames for 200 series tire, sold without holes. VT No. 50-0112



27-0111



27-0100

Chrome Chain Guard with bracket fit Big Twin custom rigids.

VT No. Type  
27-0111 Original  
27-0100 Universal



48-0490

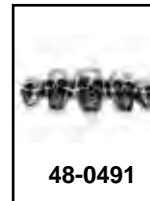

48-0491



48-0492



48-0493



48-0494

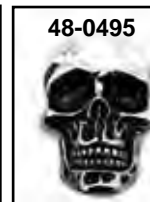

48-0495

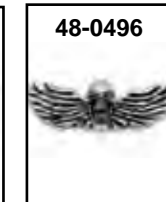

48-0496



48-0497

Pewter Emblems with adhesive backing.

VT No.	Size	Style
48-0490	4" x 3"	Skull with sickle
48-0491	3" x 1"	5 Skulls
48-0492	2" x 3"	Grim Reaper
48-0493	1.5" x 2.5"	Skull
48-0494	2.5" x 2.5"	Maltese Cross with Skull
48-0495	1.5" x 1"	Skull
48-0496	3" x 1"	Winged Skull
48-0497	5" x 2"	Bat Wing



# Axed Tank



38-0195



38-0592

**3.3 Gallon Axed Tank** features dual cap design and universal mount tabs. Use 3/8" NPT petcock.

**VT No. Petcock Cap**  
**38-0195** Right Side Dual  
**38-0591** Left Side Single  
**38-0592** Left Side Dual  
**38-0310** Cap



38-0591



38-0244



38-0247

**Mustang Style Gas Tank** features single chrome pop up cap installed.

**VT No. Gallon**  
**38-0244** 2.4  
**38-0247** 3.3



**3 Gallon Axed Gas Tank** features oval caps, measures 16.5" long 12" wide and 7" deep.  
**VT No. 38-0383**



38-0679



38-0681

**Center Ribbed Axed Tanks.**

**VT No. Bung**  
**38-0679** Screw  
**38-0681** Pop-Up



38-0693

38-0694



38-0783

**Chopper Axed Gas Tanks** include universal tab front and rear.

**VT No. Cap Gallon Type**  
**38-0693** Single 2.2 Axed  
**38-0694** Dual 2.2 Axed  
**38-0783** Single 2.0 Peanut



**Replica Axed Gas Tank** features 4 bolt bottom Iso mount straps. 5" tunnel at the front. Dual bung. Order Iso-mount straps separately.

**VT No. Item**  
**38-0031** Tank  
**38-0214** Strap Set



38-0263



38-0678

**Chopper 2.2 Gallon Axed Gas Tank** accepts 38-0310 gas cap and 2 1/4" petcocks.

**VT No. Brand**  
**38-0263** Paughco  
**38-0678** Wyatt



**Replica Captain America Gas Tank** features 2.2 gallon capacity with two 1/4" petcock outlets, straight mount tabs front and rear, and center fill gas cap location.

**VT No. Item**  
**38-0185** Tank  
**38-0310** Cap



38-0310



38-0382

**Chopper Gas Tanks** with dual caps.

**VT No. Style**  
**38-0382** 3.5  
**38-0385** 4.0  
**38-0310** Cap



38-5060

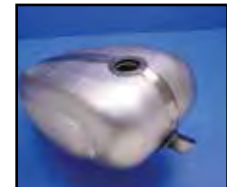

38-5061



**Saga "Dish Gas Tank"** is 3 gallon and features dished sides.

**VT No. Cap**  
**38-5060** Bung  
**38-5061** Pop-Up





# Stretch Gas Tank



38-0264



38-0265



38-0252



38-0253

Wyatt Gatling Image Gas Tanks include flush mount lower mounts and pop up cap. Order spinner 38-0410 separately.

VT No. Stretch

38-0264 4.5"

38-0265 4"

38-0252 6"

38-0253 7.5"



Iso Mount Strap Set fits tanks VT No. 38-0196, 38-0187, 38-0197.  
VT No. 38-0214



Wyatt's Teardrop Tank features curved underside with recessed mount holes. 27.5" long with right hand bung  
VT No. 38-0279



Pop-Up Gas Cap Only  
VT No. 38-0748



Replica Gas Tank features the classic XR 750 design with steel construction. The petcock is on the left side. Does not include mounts.  
VT No. 38-0636

## Weld On Pieces



40-1255



38-0206



38-0221



38-0309

Gas Tank Pieces can be welded on stock and aftermarket pieces.

VT No. Item

40-1255 Filler Neck, Bayonet

38-0206 Filler Neck, Late Bung type, right and left, pair

38-0221 Petcock Fitting, male, 1975-up

38-0309 Petcock Fitting, female 3/8 NPT



Weld-On Mount Spool with 5/16 x 24 thread.  
VT No. 51-0588



38-0221



38-0309

Weld-On Petcock Inserts.

VT No. Type Thread

38-0221 Male 1975-up

38-0309 Female 3/8 NPT



Weld-On Bracket Set includes bushings and steel sleeves.  
VT No. 51-0631



38-0789 Installed

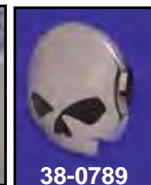

38-0789

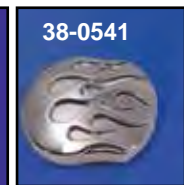

38-0541



38-0757



Tanks listed on this page accept bung style vented cap.

VT No. Style

38-0402 Pop-Up

38-0405 Flame

38-0423 Maltese

38-7001 Eagle Spirit

VT No. Style

38-0789 Skull

38-0757 Pop-Up (Vented)

38-0541 Flame



38-0409

Chrome Spinner Gas Caps are sold each.

VT No. Year

38-0409 1983-95

38-0410 Custom, 1 1/2 threaded

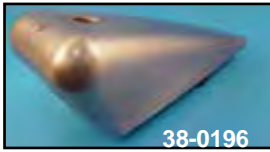

**Stretch Tank** features flat bottom for universal mounting on extended neck frames, 24" long. Right hand bung.  
**VT No. 38-0196**

# Stretched Tanks



**Wyatt's Shooter Tank** includes hidden mount strap mounting. Right hand bung.  
**VT No. 38-0876**



**3" Stretch Tank** fits custom application with 5" backbone and 0-2" down tube length. Total length is 23" with tunnel width of 2.5". Right hand bung.  
**VT No. 38-0978**

**Ready for Mock Up...  
 Tanks supplied in raw finish!**

# Prism Gas Tank

**38-0187, 38-0197 include strap type mount system.**



**Wyatt's Pirate Gas Tank** features mini design allows for full engine view. Measures 22" long with a 19 1/2" tunnel length. 2.2 gallon capacity with front and rear tab mount.  
**VT No. 38-0242**



**Wyatt Gatling Point Prism Gas Tank** is 2.0 gallon with 25" x 5" deep tunnel length and 12" at widest point.  
**VT No. 38-0187**



**Tall Koffin Style Gas Tank** features Iso mount strap system.  
**VT No. 38-0199**



**Koffin Style Gas Tank** fits 1 1/2" top frame tubes and accepts 1/4" petcocks. Measures 17 1/2" long x 9" wide. Raw finish. Mounting is by single front tab and rear U bracket. 2.2 gallon capacity.

**VT No. 38-0172** Tank (2.2 gallon)  
**38-0317** Cap

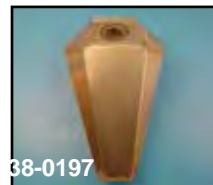

**Mount Kit**



**Wyatt Gatling Prism Gas Tank** features 4 bolt mounting and 2.2 gallon capacity with dimensions of 21" x 11.5" x 8".  
**VT No. 38-0197**

Above tanks have 5" deep tunnel at front



**Flush Mount Insert Kit** is 4 pieces with 5/16" x 24 threads. These can be welded to a flat bottom tank for a clean look. Fits custom application for flat bottom tanks  
**VT No. 38-0236**





# Sporty Shape Gas Tanks

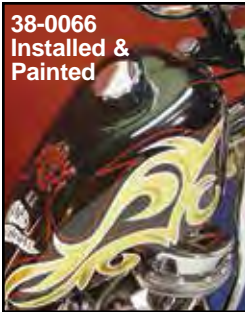

38-0066 Shown Installed on Old School Chopper  
 Universal Gas Tanks available in 3.1 or 2.5 gallon capacity.

VT No.	Size	Type	Tabs
38-0019	2.5	Stock, Forward, Bayonet	Side
38-0021	2.5	Stock, Forward	Side
38-0066	2.5	Stock	F & R
38-0098	3.1	King	F & R

## Peanut Tanks



Vintage Style Peanut Tank accepts vented cap.

VT No.	Gallon	Tunnel	Cap
38-0783	2	High	Bayonet
38-0948	1.8	Low	Screw In
38-0950	1.6	High	Screw In
38-0920	1.7	Mid	Screw In

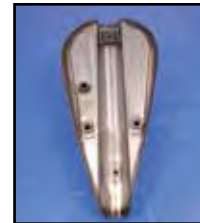

Mini Sporty Tank features bottom mount design with 2.5 gallon capacity.

VT No.	Style	Type
38-0476	Screw In	Center
38-0479	Bayonet	Center
38-0963	Bayonet	Offset



Bobber Gas Tanks are 2.4 gallon and feature 4 bolt mount strap system to be welded on to frame. Use mount kit 38-0214 included with tanks.

VT No.	Style	Side	Note
38-0825	Bung	Smooth	Order Cap Separate
38-0826	Bung	Indented	Order Cap Separate
38-0827	Pop Up	Smooth	Includes Special Cap
38-0828	Pop Up	Indented	Includes Special Cap



Bobber Style Tanks feature axed style with single center bung.  
 VT No. Item  
 38-0065\* Single Cap  
 38-0025 Dual Cap  
 \*Note: Right Hand Bung





# Corbin-Gentry for Rigids

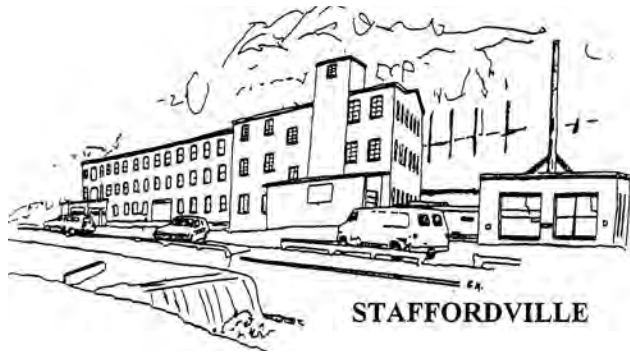

Corbin-Gentry Factory in Staffordville, Connecticut. Original 35,000 square foot brick mill housing the production of Leather Solos and Replica Rigid Frames



## Rigid Stinger Saddles



Original Stinger II Design on Rigid XL by Ron Yurich of New Britain, CT 1970.

**High Back Seat Replica of Captain America Style of 1969** features chrome buttons and 14" back height for Rigid Frames only. Requires tall sissy bar recommended for support. Chrome sissy bar and gas tank also available.

VT No.	Item
47-0052	Seat, 14"
50-0850	Sissy Bar
38-0185	Axed Tank



**Stinger Saddles.** Original designs by Corbin-Gentry are a smaller type of rigid seat available as thin profile MK I, or the thick version MK II or MK III. Stinger III is fully buttoned with an intricate pattern in durable Naugahyde.

VT No.	Type
47-0745	Chrome Button Diamond Pattern/MK I
47-0047	Smooth

**Front Nose Bracket** mounts custom seats to stock or replica rigid frames 1936-57.  
VT No. 31-1244







# Solo Seat

## Velocipede Solo

Leather Velocipede Solo Seats feature metal base plates. Will mount to rigid or swingarm frames with mount kits available separately. Seats measure 9.5" wide by 13" long.



<b>Black</b>	<b>Brown</b>	<b>White</b>
47-0761		
47-0762	47-0772	
	47-0833	47-0834
47-0109		

<b>Thickness</b>
1.5"
1"
1"
2"



CH Style Solo Seat features ribbed metal baseplate, genuine leather cover with rolled sewn edge. Measures 13.5" x 13.5".

<b>VT No.</b>	<b>Color</b>
47-0158	Black
47-0164	Brown
47-0841	Cowboy
47-0184	Black, Tuck and Roll

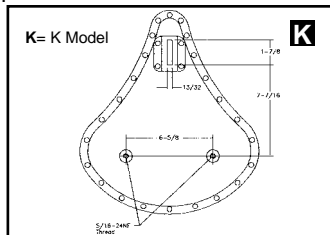
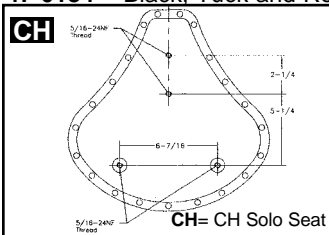

Bare Bones Solo Saddles with rivets. 9.5" long by 13.5" wide. VT No. Leather 47-0779 Brown 47-0780 Black



Solo Seat Kit includes seat mini-bracket kit, 3" coil springs and weld on spring stanchions. VT No. 47-0785

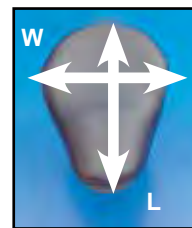

Black Solo Seats feature a metal baseplate which includes studs for mounting springs and nose brackets. Order mount kits separately. 47-0902 has leather cover. Nose bracket available separately.

<b>VT No.</b>	<b>Size</b>
47-0099	12" L x 9" W
47-0758	14" L x 13" W
47-0759	13" L x 10" W
47-0902	Leather



<b>VT No.</b>	<b>Color</b>
47-0021	Black Vinyl
47-0022	Black Leather
CH= CH Solo Seat	
K= K Model Solo Seat	

# Chrome Alloy Solo

# Velocipede Solo



Forging is a Multi Step Process!



**Chrome Alloy Solo Seat** is a one piece aluminum forging not a casting. Features recesses to fit padded inserts. Seat measures 11 x 11 inches.

VT No. 47-0791



47-0895



47-0765



**Velocipede Leather Solo Seat** features steel base plate, with ground edge design and .5" foam padding.

VT No.	CG	Color
47-0888	47-0765	Brown
47-0895	—	Black



47-0159

K



47-0748



47-0925



47-0926

**Replica K-R Saddle** features thin profile with leather construction on stock formed steel baseplate. Edge is original cobbler style with ground and sanded edge. Seat measures 13" W x 16" L with 6<sup>5</sup>/<sub>16</sub>" c/c on rear bolt holes. By Corbin-Gentry.

VT No.	Type
47-0159	Brown
47-0748	Black
47-0923	Cowboy Brown

**Bare Bones**

47-0925	Black
47-0926	Brown



**Black Solo Seat** fits Big Twin and XL Rigid frames. Includes mount kit with hair pin springs included. Solo measures 14" x 13".

VT No. Item  
47-0152 Seat Kit  
31-0608 Mount Kit



47-0768

CH

**Velocipede Leather Solo Seat** features metal base plate measuring 14" x 14" x 1/2" thick with threaded studs at front and rear.

VT No.	Color
47-0768	Brown
47-0165	Black



47-0263

**Chrome Seat Rail Kit** fits small solo seats as VT No.'s 47-0110, 47-0112. Mount tabs may be required for some applications. Rail and mount tabs are available separately.

VT No. Item  
47-0263 Seat Kit  
31-0978 Rail

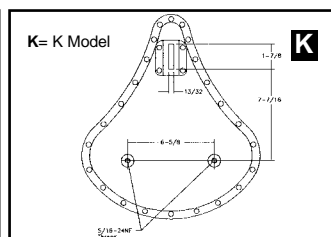
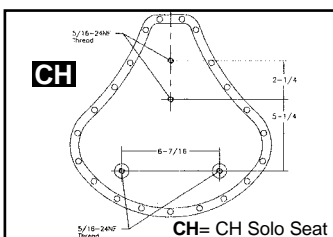





# Leather Solo



**Velo Racer** features thin profile with leather construction on stock formed steel baseplate. Edge is original cobbler style with ground and sanded edge. Seat measures 13" W x 16" L with 6 $\frac{5}{8}$ " c/c on rear bolt holes.

VT No.	Type
47-0157	Black
47-0159	Brown
47-0605	Brown Kit
47-0606	Black Kit



**Constructed with Formed Metal Base!**



**K-Model Solo Seat** is covered with genuine black leather on a stock formed steel ribbed baseplate, constructed as original with rolled sewn edge with riveted under strip, replaces 52000-40. Available in black which bolts to any stock seat tee as custom or stock replacement.

VT No.	Color
47-0110	Black
47-0517	Brown
47-0112	CG Black

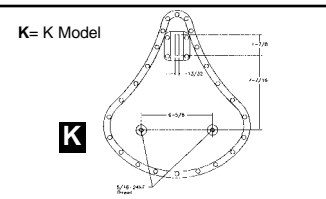
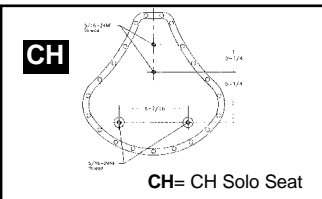

**Metro Solos** are covered with genuine leather on a stock formed steel ribbed baseplate with a rolled and sewn edge and black leather skirt decorated.

Black	Brown	White	Style Skirt
47-0229	—	—	Black Spots and Red Rosettes
47-0114	—	47-0831	Spears and Rectangular spots
47-0543	47-0825	47-0830	Chrome Spots with Fringe
—	47-0699	—	Brown, 3 piece
—	47-0833	47-0834	Chopper Solo
—	47-0828	—	K Model Solo, Rolled Sewn Edge
47-0827	47-0829	—	K Model Solo, Ground Edge
—	47-0842	47-0832	Bates Style K Model Solo
—	—	47-0342	Black Spots



# BATES Replica Solo Seat



**Bates Style Solo** measures 13" long by 9.5" wide. Order springs and nose brackets separately.

VT No. Item  
47-0773 Seat  
13-0548 Springs



**Solo Seat** fits custom application.

Smooth	Tuck and Roll	Flame	Type
47-0070	47-0083	47-0072	Thin
47-0071	47-0084	47-0085	Thick
Large Solo Seat			
47-0055	47-0057	47-0059	Thin
47-0056	47-0058	47-0060	Thick



**Bates Style Tuck and Roll** feature genuine leather, solo measures 13" wide x 16" long with mount holes 6 $\frac{5}{8}$  c/c.

VT No. Item Type  
47-0162 Seat VT  
47-0601 Seat Kit VT  
48-1325 Bates Patch



**Solo Seat and Pad Set**, in black vinyl.

Set	Seat	Pad
47-0790	47-0759	47-0786
47-0792	47-0758	47-0786



**Wyatt Buttoned Solo Seat.**

VT No.	Size	Thickness
47-0824	Small	Thin
47-0064	Small	Thin
47-0065	Large	Thin

**Seat Pad** measures 5" x 11" and mounts by  $\frac{5}{16}$  bolts on under side. Order mount kit separately.  
VT No. 47-0088



**Wyatts Solo Seats** feature black vinyl covering on a steel base plate.

Tuck	Plain	Size	Thickness
47-0362	47-0062	Small	6 cm
47-0363	47-0758	Large	8 cm
47-0364		Large	6 cm



**Solo Three Button Style Seat** in Naugahyde with a metal base-plate.  
VT No. 47-0089



**Micro Solo Seat by Corbin-Gentry** features detailed stitches and button pattern. Size is 13" L x 8.5" W x 2" H.  
VT No. 47-0988

MULTI FIT/CHOPPER





# Rear Pads

# Sissy Bar Pads



47-0188

### Leather Rear Pads.

- | VT No.  | Type                 |
|---------|----------------------|
| 47-0913 | Smooth               |
| 47-0914 | Tuck and Roll        |
| 47-0188 | Tuck and Roll, wider |



**Pillion Rear Seat Pad** is smooth vinyl and has a welted edge. Bolt holes in the steel baseplate are used for direct fender mount. Size is 5" W x 9" L with a 2" thickness.

VT No. 47-0786



**Replica Pads.** The 47-0098 is K-Replica in leather.

- | VT No.  | Type               | Size         |
|---------|--------------------|--------------|
| 47-0098 | K-Replica, Leather | 7½" W x 9" L |
| 47-0045 | K-Tuck n' Roll     | 7½" W x 9" L |

**Button Sissy Bar Pads** mount to square stock sissy bars, Mini fits 12" bar, 2 button fits 16" bar. Chrome mount clamps included, black only.

- | VT No.  | Type                   |
|---------|------------------------|
| 47-1963 | Mini                   |
| 47-1964 | 2-Button               |
| 47-1972 | Smooth                 |
| 47-0457 | Buttoned               |
| 31-1987 | Brackets for Above     |
| 47-0478 | Sissy Bar Buttoned Pad |



**Mini Back Rest** in black features a stainless steel insert with chrome frame mounting system for short sissy bars. VT No. 47-0753



**Stick-On Rear Passenger Pillion Pad**, in vinyl with suction cups. For custom applications.

- | VT No.  | Size           |
|---------|----------------|
| 47-0348 | 9" x 6" x 2⅜"  |
| 47-0349 | 9" x 5¼" x 2⅜" |



### Black Seat Tee with Shock Kit

- |         |            |
|---------|------------|
| 31-1761 | 1941-80 FL |
| 31-1765 | 1941-80 FL |
| 31-1781 | 1936-52 W  |



# Seat Mount for Softtail models



**Solo Seat Mount Kit** for 1984-99 FLST-FXST includes heavy duty seat "T" and pivot mount, 5" chrome springs and all related hardware. Accepts our standard Police Solo size seats. K model styles such as 47-0110 require use of 31-0478 cross bracket. Mounting allows adequate distance between seat fender. Auxiliary spring kit may be mounted to this seat mounting assembly for dresser look. Bracket VT No. 31-0177 required to mount nose buddy seat.\*\*Note: Relay Pack may have to be relocated to 1994-05 FXST-FLST models. Order chrome frame cover VT No. 42-0671 separately for 1984-99.

VT No.	Fits	Cover
31-4019	1984-99 5" Springs	42-0671
31-4190	2000-05 2" Springs	42-0942

**Solo Seat Kit** includes leather seat and mount kit for 1986-99 FLST.  
VT No. 47-0135

## Seat 'Tee' Kit



**Seat Tee and Piston Kit** fits Softtail models. Includes black 'tee', cylinder with internal spring, nose mount and related hardware. Drilling and tapping of frame required.

VT No.	Item	Years
31-0293	Chrome	1984-99
31-0688	Black	1984-99
31-0313	Black	2000-up
42-0671	Chrome Cover	1984-99

47-0231 Solo Mounted on 31-0293 Mount Kit

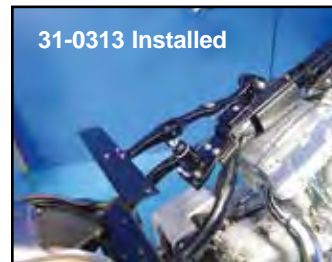

VT No. 31-0688  
Seat Post Kit shown with Replica Saddle VT No. 47-0531 installed.



**Black Police Solo Seat Kit** includes black piston and tee with leather police solo seat. Fits 1984-99.  
VT No. 47-0475

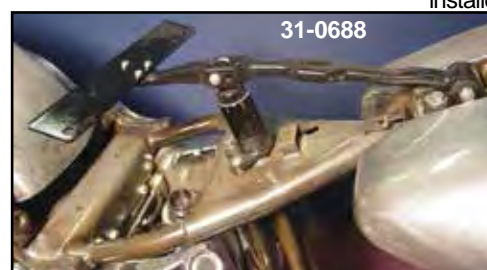

MULTI FIT/CHOPPER





# Seat Mount



**FX-FLST Solo Seat Kit** includes mount kit with 5" springs, frame cover and leather solo seat.

VT No.	Year
47-0548	1984-99
47-0549	2000-05



**Solo Seat and Mount Kit** includes leather Police Solo Seat. Order cover separately. Fits 1984-99 Softail.

**VT No. 47-0801**

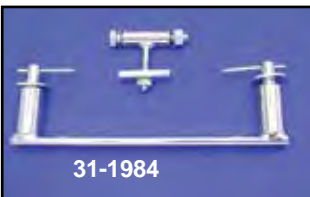

**FXST Solo Seat Bracket Kit** is used to mount solo seats on the 1984-99 FXST models. Note: Front 'Tee' can be used for a universal front seat mount on any frame.

VT No.	Item	Year
31-1984	A and B Complete Kit	1984-99
31-1985	B Front 'Tee'	1984-99

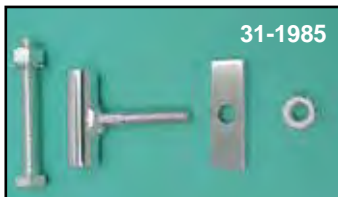

**Complete Kits.**

31-1308	Dual Shock 4"
31-1309	5"
31-0823	Black Shock Mount Bracket Set



**Solo Seat Kit** includes brackets and hardware to fit 2000-up Softail models. Use with solo seat styles such as VT No. 47-0110, 47-0158. Lower mount bracket includes integral frame cover. 4" seat springs supplied.

VT No.	Item
31-0942	Mount Kit Only
47-0793	Seat Kit

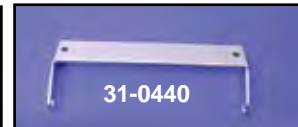
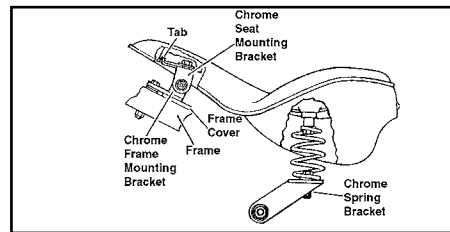

**Chrome Solo Seat Bracket** mounts all Police size Solo saddles on 1986-93 FXST and FLST models direct to the frame without the use of a seat 'Tee' bracket. Kit includes all necessary hardware, including chrome 4" springs and 2 chrome brackets.

VT No.	Item
31-0825	Front Bracket
31-0440	Spring Cross Support Only

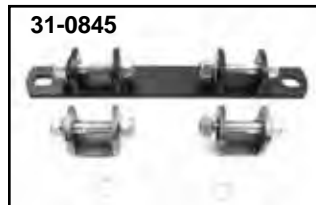

**Mini Shock Mount Kits** for Rigid Frame. Order shock or shock separately.

VT No.	Item	Type
31-0845	Shock Mount	Dual
31-0846	Shock Mount	Single
54-0655	Shock 4"	Each
54-0656	Shock 5"	Each
54-0950	Shock 4"	Each
31-1645	Bracket	3 piece, Raw

# Solo Seat Mount Kit 1958-84 Big Twin

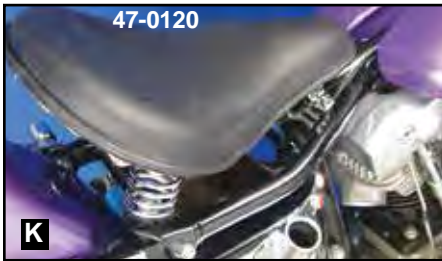

**K**



**Solo Seat Kit**  
includes leather seat  
and mount kit for  
1965-84 FL-FXE.  
VT No. 47-0120

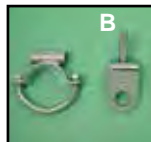
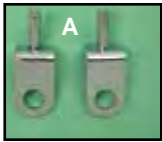

**Chrome Spring Mount Kit** includes mounts for spring perch which attach to top shock studs and front clamp for nose bracket. Fits 1958-84 FX-FL.

VT No. **Type**  
31-0502 A and B Complete Kit  
31-0174 B Front U Clamp Only

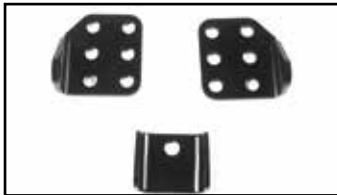

**Black Seat Mount Kit** fits 1958-84 Big Twin nose of sold seat. Includes seat bracket, right and left brackets.  
VT No. 31-4059



**Dual Shock Solo Seat Mount Kit** fits Rigid and Swingarm frames.

VT No.	Item	Size
31-1745	Shock Kit	4"
31-1746	Shock Kit	5"



**Solo Seat Mount Kits** for 1936-84 Big Twin include nose bracket, chrome springs and rear brackets to mount small type solos only such as 47-0089. To mount larger Police seats purchase cross bar separately VT No. 31-0473. To mount K-model type solo order 31-0478 cross bar. Fits 1973-84 FX.  
VT No. 31-4010



**Police Type Solo Seat Mounting Kits** for 1958-84 Big Twin. Include nose bracket, chrome springs and rear mount

VT No.	Spring Type
31-0580	2" Coil
31-0606	2" Hair Pin

**Note:** When installing wide solo seats, use 31-0473 in conjunction with solo seat "Tee" kits to extend rear strap on "Tee".

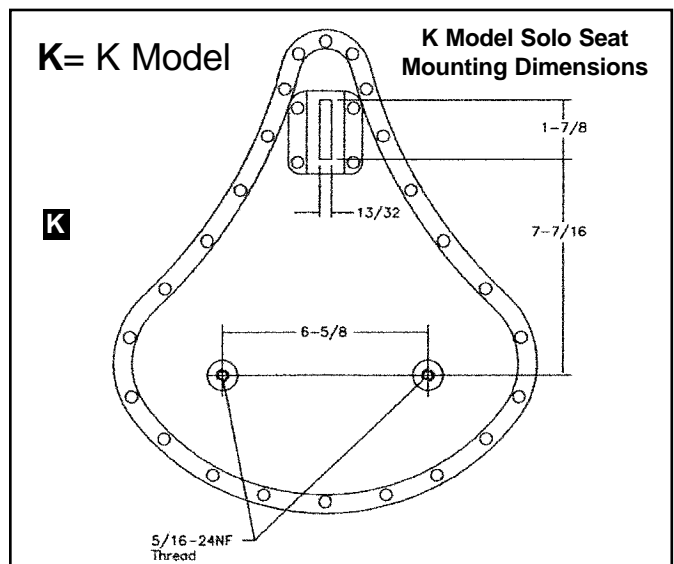
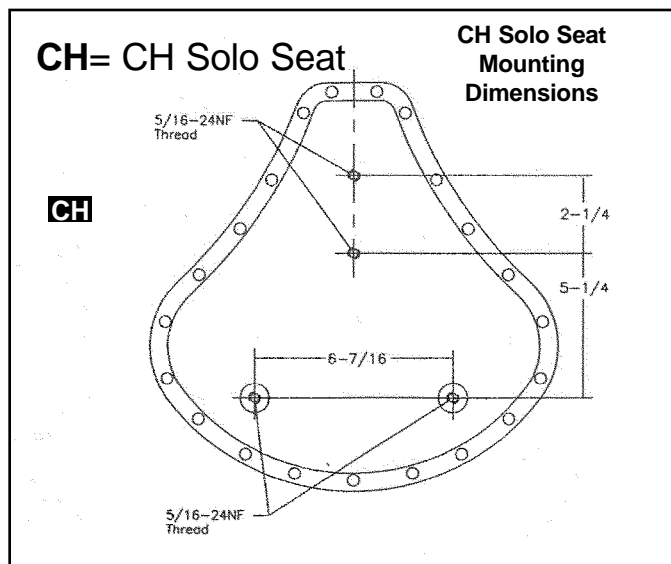





# Seat Mount FXD-FXDWG

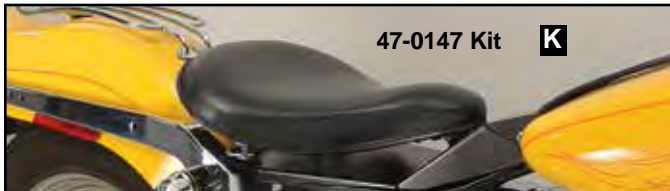
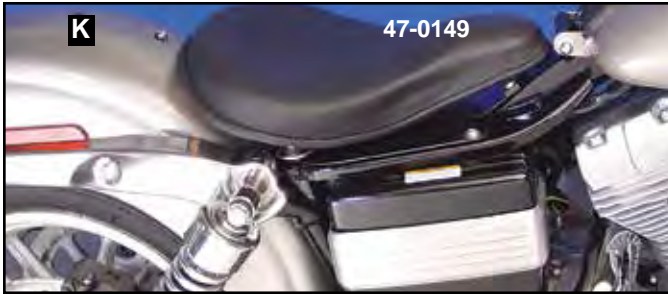

**Solo Seat Kits** include leather solo seat and mount kit for FXD-FXDWG models. Kits feature built in cover.

**VT No. Year**  
**47-0147** 1996-2005  
**47-0149** 2006-up

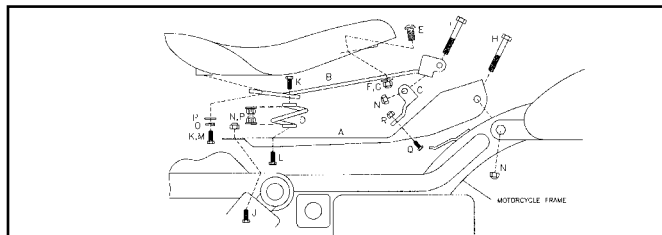
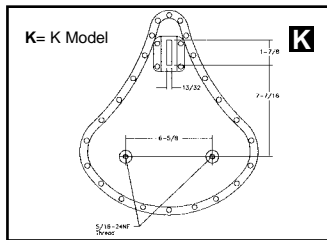
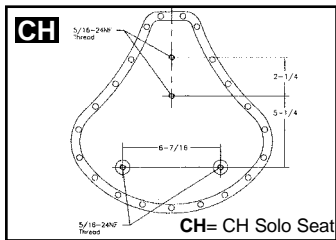

**Assembly Instructions**

- 1) Attach the hinge to the cover with the screws and nuts as shown.
- 2) Attach the springs to the cover with the screws, nuts and washers as shown.
- 3) Attach the seat "T" to the springs and hinge with the screws, nuts and washers as shown.
- 4) Attach the cover and seat "T" assembly to the motorcycle frame with the screws and nuts as shown.
- 5) The seat "T" will accept most solo seats sold separately. Hardware is provided in this kit to mount solo seats.

Item	Description	Qty	VT No.
1	Frame Cover	1	42-0981
2	Seat "T"	1	31-0992
3	Front Bracket	1	31-0915
4	1" Springs	2	13-0742
5	5/8-18NCx1 Carriage Screw	1	
6	3/8-18NC Nyloc Nut	1	
7	3/8 Flat Washer	1	
8	5/16-18NCx3 1/2 Hex Head Screw	1	
9	5/16-18NCx2 1/4 Hex Head Screw	1	
10	5/16-18NCx1 Hex Head Screw	1	
11	5/16-18NCx3/4 Hex Head Screw	4	
12	5/16-18NCx3/4 Hex Head Screw	4	
13	5/16-18NC Nyloc Nut	1	
14	5/16 Split Lock Washer	1	
15	3/4 Flat Washer	1	
16	3/4-20NCx3/8 Hex Head Screw	1	
17	1/4-20NC Nyloc Nut	1	

# Softail Frame Covers



**FL-FXST Frame Cover.**

**VT No. Type Finish**  
**42-0671** 1984-99 Chrome  
**42-0942** 2000-05 Black



**VT No. 31-1005** 1991-05  
 Dynaglide Solo Seat Kit

**Seat Mount Kit for FXD-FXDWG** includes all hardware to mount K model style solo seats. **Seat not included.**

**VT No. Year Note**  
**31-0434** 1991-95 No Springs Included  
**31-0087** 1991-95 1" Springs Included  
**31-1005** 1996-05 1" Springs Included  
**31-0774** 2006-up 2" Springs Included



# Solo for XL's

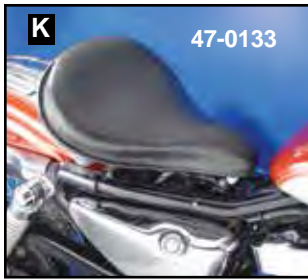

**Leather Solo Seat Kits** for XL models includes K-model seat, chrome 2" springs and mount hardware.

VT No.	Item	Cover
47-0131	1952-78	—
47-0132	1979-81	—
47-0133	1982-03	42-0979
47-0134	2004-06	Included



**Solo Seat Mount Hardware.** This seat tee and the weld on mount tabs provide a substantial mount system from K and XL models solos. Order pieces separately.



**Model 57 Solo Seat Kits** include replica genuine leather solo seat with complete mount kit. Replica seat is as offered on original 1957 Sportster 50 years ago. 47-0782 includes frame cover.

VT No.	Item	Cover
47-0781	1982-03	42-0979
47-0782	2004-06	Included

VT No.	Item
31-0512	"T"
37-9114	Pivot Bolt
51-0539	Mount Tab Set

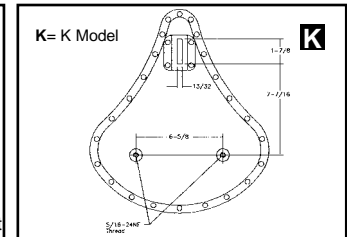
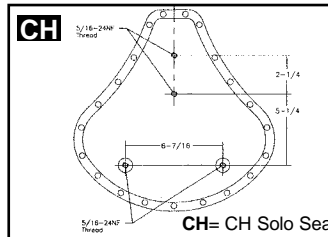

CH= CH Solo Seat  
K= K Model Solo Seat

# Solo Seat Mount Kits for Sportster

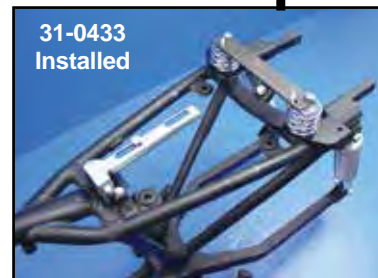

**Solo Hardware Mount Kits** include nose brackets, springs and rear brackets. To fit police style solos purchase cross bar 31-0473. 2" spring. 31-4063 includes black frame lower.

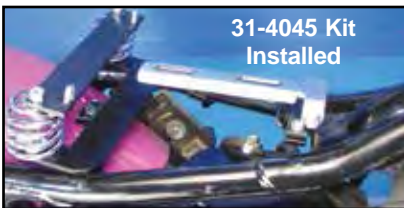

Bates Solo VT No. 47-8655 Shown Mounted with 31-4063 Mount Kit

VT No.	Model	Frame Cover
31-4044	1952-78	—
31-4045	1982-2003	42-0979
31-4063	2004-06	Included
31-0433	1979-81	—
31-4086	2010-up	Included



**Bracket Set** adapts VT No. 47-0122 seats to stock frame. 1982-2003 XL. VT No. 31-4023



**Chrome Swingarm Rear Spring Support Bar** for 1952-78 only. VT No. 31-0501

MULTI FIT/CHOPPER





# Rigid Solo Kit

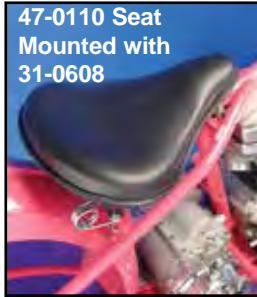

**Solo Seat Mount Kits** for Rigid frames include nose bracket, chrome springs and rear brackets to mount small type solos only such as VT No. 47-0089. To mount larger Police seats purchase cross bar separately VT No. 31-0473. To mount K-model type solo order VT No. 31-0478 cross bar.

VT No.	Spring	Type	Model
31-4043	3"	Coil	Rigid
31-0608	2"	Hair Pin	Rigid



**Rigid Frame Seat Mount Brackets**  
 VT No. Item  
 31-0503 Kit  
 31-0504 Rear Clamp



**Spring Mount Tail Lamp Clamp Sets** will mount springs to frame cross tube.

VT No	Size
31-0695	1"
31-0696	1 1/8"
31-0697	1 1/4"
31-0698	1 3/8"



**Rigid Frame Solo Seat and Mount Kit** includes chrome 3" hairpin springs, cross bar with spring dowels and 1" clamp set to mount to fender cross bar. Mount kit and seat are also sold separately.

VT No.	Item
47-0130	Seat Kit
31-0608	Mount Kit Only
47-0110	Replica Seat Only, 14" wide x 17" long
27-0039	Clamp Set, 1"
27-0038	Clamp Set, 1 1/8"

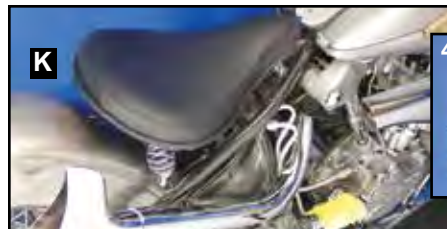

**Rigid Seat Kit** includes 3" springs and solo seat.

VT No.	Item
47-0119	Seat Kit
31-4043	Mount Kit Only
47-0110	Seat Only

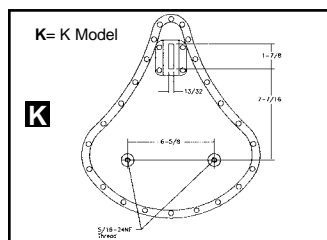

**K= K Model Solo Seat**



# Solo Seat Hardware



**Seat Bracket Mount** bolts to frame holes above seat post tube on all 1965-84 FLH-FXE frames. Seat nose bracket will swivel on this mount.

**VT No. Finish**  
**31-4009** Zinc  
**31-1234** Chrome



**Micro Front Solo Seat Mount Kit** includes weld on tabs and micro "T" with bushing.  
**VT No. 31-0875**



**31-0950**

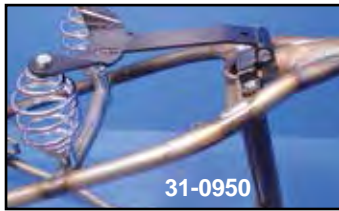

**31-0950**



**31-0947**



**31-0898**



**13-0548**

**Solo Mount Kit** includes nose bracket, seat "T" and rear mount bracket. Order springs and spring stanchions separately.

**VT No. Item**  
**31-0950** "T" Kit  
**31-0947** Bracket Front  
**13-0548** 5" Springs  
**31-0898** Stanchions



**31-0369**



**31-1575**

**Solo Seat Nose Bracket Cast and Polished Stainless Steel.**

**VT No. Item**  
**31-0369** Nose Bracket  
**31-0824** Mount Pivot  
**31-1575** Kit



**Raw Cast Steel Front Seat Mount Bracket** is to be welded onto 1 1/4" top frame tube. **VT No. 31-1757**

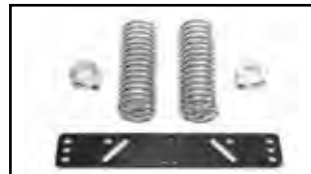

**Seat Spring Kit for Rigid Frames.**  
**VT No. 31-0827**

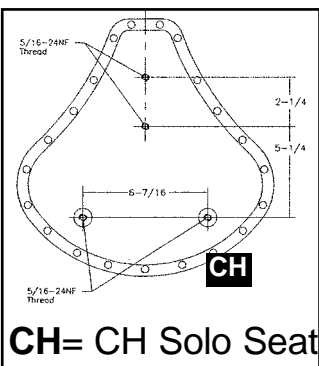

**CH= CH Solo Seat**

**CH Solo Seat Mounting Dimensions**

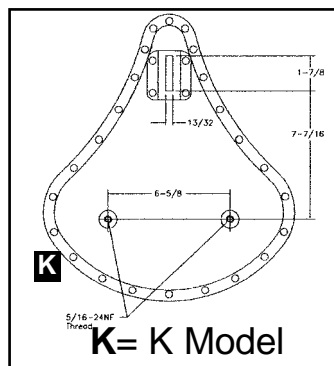

**K= K Model**

**K Model Solo Seat Mounting Dimensions**



**31-0510**

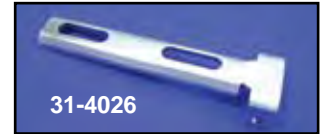

**31-4026**



**31-4080**



**31-4027**



**31-4194**

**Tilt Up Seat Nose Bracket** allows the solo seat to be mounted to frame tubes or mount brackets.

VT No.	Type	Width	Finish
<b>31-0510*</b>	Tube	1 3/4"	Chrome
<b>31-4026</b>	Low Profile	1 1/2"	Zinc
<b>31-4080</b>	Low Profile	1 1/2"	Zinc
<b>31-4027</b>	Wide Nose	2 1/2"	Zinc
<b>31-4194</b>	Low Profile	1 1/2"	Zinc

**\*Note:** Fits bracket VT No. 31-4009 which mounts to 1965-84 FX or FL frames.

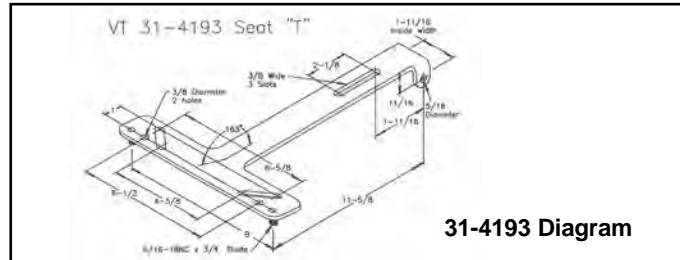

**31-4193 Diagram**



**31-4193**

**Universal Seat "T"** features slotted mounts to accept most solo seats.  
**VT No. 31-4193**



**31-0630**

**Solo Seat Mount and "T"** will adapt seat "T" to 1984-99 Softail models with split tanks.

**VT No. Item**  
**31-0630** "T"  
**31-0913** Mount



**31-0913**



**Solo Seat Mount Bracket** allows mounting of spring set to underside of solo seats, may be drilled for extra application. Adds support to spring perches. **VT No. 31-0326**



**Universal Solo Seat Front Mount** includes mount and tilt up seat bracket to fit most solo seats. Lower bracket is direct bolt on to 1965-84 FX-FLH frames.  
**VT No. 31-0654**





# Seat Springs

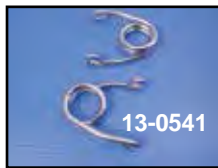
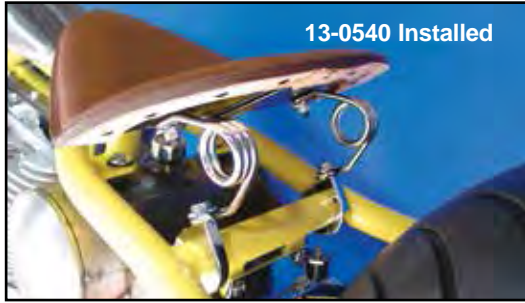
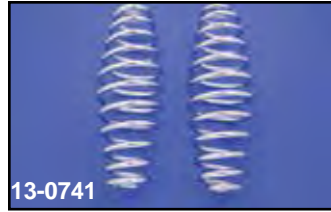
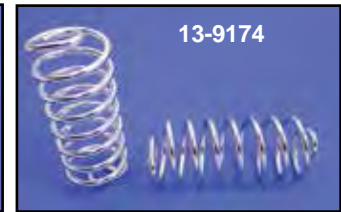
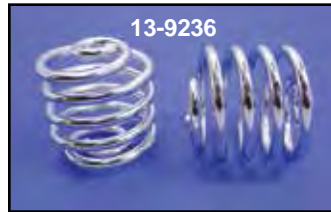
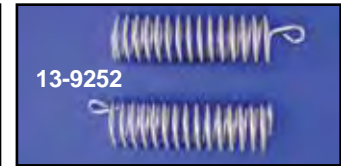
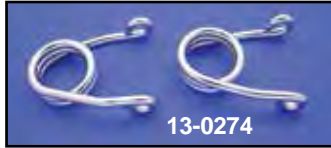

**Chrome Seat Springs** are original tapered barrel style in 2", 3" or 5" height. The 5" and 7" have a heavy duty 6.5 mm wire diameter for stable support.

## Chrome Torsion Type Seat Spring Set.

Standard	L & R	Size	Type
13-0273	13-0985	2"	Regular
	13-0276	2"	Brass
13-0274	13-0986	2"	Heavy
13-0541	13-0988	3"	Heavy
13-0540	13-0987	3.5"	Heavy
13-0542		4"	Heavy
13-0546		5"	Heavy
13-0852		2"	Heavy

Order various length spring sets as required for height change.

VT No.	Size
13-0742	1"
13-9236	2"
42-0033	3"
13-9243	4"
42-0055	5", 6.5 mm wire

13-0548	5", 6.5 mm wire, tapered
13-9174*	5"
13-0741	7"
13-9252	7", 5.5 mm wire

\*Note: Feature 5.71 mm wire.

# Rear Spring Mount



**Mount Clamp Sets** will mount springs to frame cross tube.

VT No	Size	VT No	Size
31-0695	1"	31-0697	1 1/4"
31-0696	1 1/8"	31-0698	1 3/8"



**Weld On Spring Mounts** contour to frame rails, raw.

VT No. 31-0342

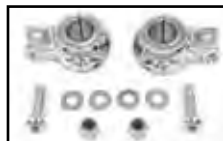

**Chrome Seat Shock Mount Clamp Set** fit 1" bars to mount seat shock sets.

VT No.	Item
27-1008	Dual
31-0014	Universal



**Weld On Seat Mount Brackets**, sold in pairs.

VT No.	Type
31-0048	Spring Perch Set
31-0056	Universal Weld On Bracket Set



**Weld-On Frame Seat Spring Mount** be welded to Rigid frame cross tube to mount solo seat springs. VT No. 51-0638

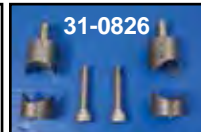

**Solo Seat Mount Stanchions** are bolt on design to fit 1" frame tubes on rigid frames.

VT No.	Finish
31-0898	Chrome
31-0826	Raw
31-0907	Chrome



**1" Solo Seat Coil Spring Mounting Stanchion Set** can be screwed on seat mounting bracket. Also works when installing solo seats on dresser models. Includes two 1" tall bungs with 5/16 -18 x 1" allen screws and two locking pins.



VT No. 31-4087  
**Solo Seat Mount Stud Set** has 5/16 x 24 thread at each end. VT No. 37-0957



# Solo Seat

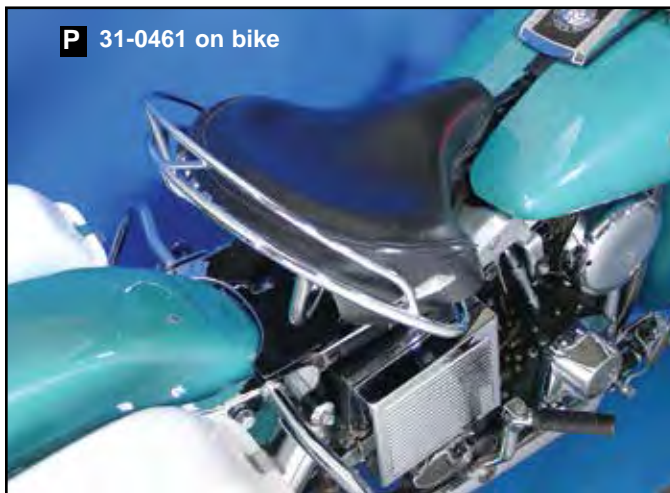
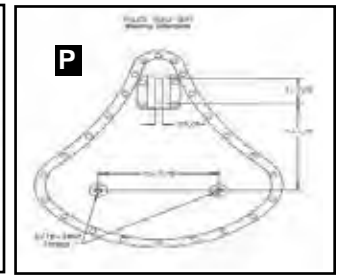
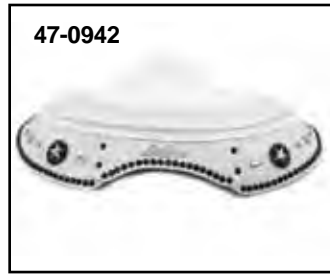
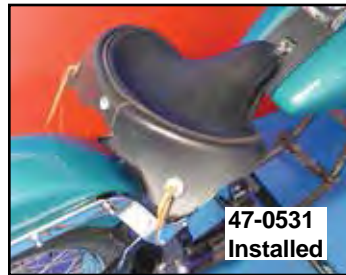

Replica Solo Seats feature metal ribbed baseplate and leather covering by Corbin-Gentry.

Black	White	Skirt
47-0531	—	Early
47-0945	—	Yellow and Green Concha
47-0953	47-0942	Deluxe

## When Custom Mounting Solo Seats...

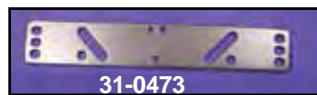

**Seat Cross Straps** will add extra support to Police and K Style seats when they are not used with a Tee bar, such as on custom seat mount kits. Straps have holes for spring and seat mount.

VT No.	Item	Length
31-0473	Police	11.5"
31-0613	XLCH Model	8"
31-0478	Custom	8"



**Seat Rail Mount Kit** allows attachment of our rail 31-0507 to seat Tee's, 31-0511 or replica type, 31-0415, when fitted with leather police style solo saddles with or without skirts.

VT No.	Item
31-0461	Mount Kit Only
31-0507	Seat Hand Rail, shown
49-0151	Handle Set, pair



### A Note about our Leather Solos

There are literally over 1000 different type of seats on the market today, but if you still want something really comfortable on long trips the old plunger style seats are very hard to beat. This leather covered contoured seat fits like a glove and the plunger action will keep your ribs from dropping to your knee caps by absorbing those large bumps such as rail-road tracks and manhole covers.

Our leather is top grade cow hide for a long lasting appearance. A chrome passenger rail is available for both styles. When you ask any cop, who has ridden the freeways and highways of the USA for 30 or more years, what he misses most on his late model, he will tell you short and simple: the seat.

-Ray Boone RBE 1987



**Chrome Seat Spring Kit** is for use with stock seat "T" on rigid frame models. Kit includes a set of two 7" seat springs with loop mounts for lower studs, a three piece 1" I.D. clamp set, seat stud set, spring stud set, nylock nuts and flat washers. Fits 1936-1952 EL, 1941-57 FL.

VT No. 31-0091





# Replica™ LEATHER Solo Seat

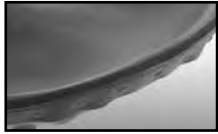

**Rolled Edge**  
Hermann Oak  
Leather used in  
seat construction.

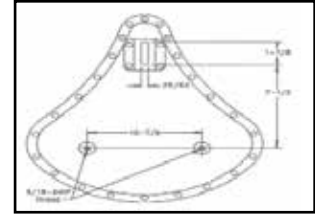
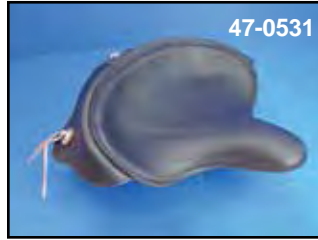

**Note:** All seats on  
this page are **P**.  
**P**= Police Solo Size.

## Over 25,000 sold since 1977!

Replica™ Early Leather Solo Rolled Seats by Corbin-Gentry are constructed using genuine drum dyed leather cover with padding on an accurate steel formed and ribbed baseplate with brackets riveted in place as original. Authentic style seams are accomplished by first riveting a leather strip to the seat pan and then form fitting the leather cover to the saddle, and finally sewing the cover to the strip. Edge is the "Rolled Edge" where the leather is covering the seam between the cover and fastening strip.

Black	Edge	Detail
VT No		
47-0431	Rolled	Leather Rivet Strip
47-0531	Leather	Early Style with rosettes

Brown		Note:
47-0509	Rolled	this is dark brown
47-0607	Rolled	this is bomber brown
47-0432	Rolled	
47-0535	Leather	Early Style with rosettes

## Leather Deluxe and Fringed Solo



**Thick Solo Seats** feature foam padding and full leather cover and mount strips.

VT No.	Color
47-0510	White
47-0516	Brown
47-0552	Black

**Deluxe Solo Saddle** with diamond spears complete as shown of genuine leather on factory steel ribbed baseplate.

VT No	Color	Skirt
47-0775	Black	Royalite Skirt
47-0787	Black	Leather Skirt
47-0264	White	Leather Skirt



Solo Seats.	VT No.	Color
	47-0749	Brown
	47-0450	Black w/orange rosettes



# Solo Seat



47-0450



47-0946



47-0947

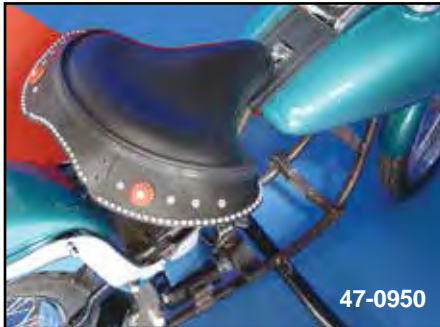

47-0950



47-0516



47-0237



47-0252

### A Note about our Leather Solos

There are literally over 1000 different type of seats on the market today, but if you still want something really comfortable on long trips the old plunger style seats are very hard to beat. This leather covered contoured seat fits like a glove and the plunger action will keep your ribs from dropping to your knee caps by absorbing those large bumps such as railroad tracks and manhole covers. Our leather is top grade cow hide for a long lasting appearance. A chrome passenger rail is available for both styles. When you ask any cop, who has ridden the freeways and highways of the USA for 30 or more years, what he misses most on his late model, he will tell you short and simple: the seat.

-Ray Boone RBE 1987

**Replica™ Leather Solo Seats by Corbin-Gentry** are constructed using genuine drum dyed leather cover with a molded foam pad on an accurate steel formed and ribbed base-plate with brackets riveted in place as original. Authentic style seams are accomplished by first riveting a leather strip to the seat pan and then form fitting for leather cover to the saddle, and finally sewing the cover to the strip. All seats measure 16" x 16" and fit stock seat T's. Skirts are constructed of Neo Royalite or leather as noted.

VT No.	Style	Skirt	Details
47-0450	Fringe	Leather	Black, Star-Rosette
47-0946	Spots	Leather	Black, Star-Rosette
47-0947	Spots		White, Star-Rosette
47-0950	Early Deluxe		Leather with conchas
47-0516			Brown

**\*Note:** Features cobbler seam edge accessorized with leather Skirt and 1 1/8" crystal jewel

47-0237	Fringe	White Leather, Blue Rosette
47-0252	Spots	White Leather, Blue Rosette



31-0473

**Seat Cross Strap** is required for extra support to Police and K style seats when they are not used with a T bar, such as on custom seat mount kits. Straps have holes for spring and seat mount. **VT No. 31-0473**

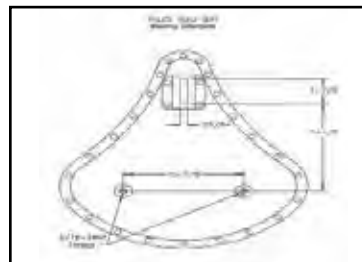

**Note:** All seats on page are **P**.  
**P**= Police Solo Size.  
Refer to Page for diagram







# LEATHER Early Solo

Solo Seats on this page measure 16" x 16" and feature replica steel ribbed baseplate, genuine leather cover.



47-0247



47-0128

P

Early Solo Seats feature thin profile on steel ribbed baseplate. The edges are ground as original, replaces 3181-25.

VT No. Color

47-0247 Brown

47-0128 Distressed Brown

47-0061 Brown (Thin)

P= Police Solo Size



Corbin-Gentry Leather Solo and Buddy Saddles are built on a replica style steel ribbed baseplate with brackets riveted in place. Original style seams are accomplished by riveting a leather strip to the seat pan and form fitting the leather cover to strip and sewing for authentic construction.



47-0529

P



47-0555

Army Style Solo Saddle features replica stock style ribbed baseplate, Leather and rivets as original. Replaces 3181-41. Order mount hardware separately.

VT No. Item

47-0529 Brown Seat

47-0555 Black Seat

31-0587 Mount Hardware

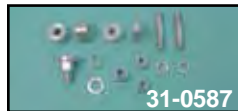

31-0587

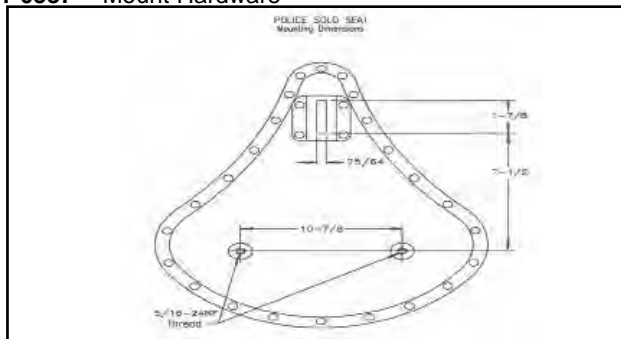

47-1938

Early Solo Seat feature OEM style pan without vent holes. Full leather construction as original.

VT No. Color

47-1938 Brown

47-0948 Black Leather Thin



47-0509

P



47-0607

P

Replica Leather Solo Seat as installed on the "Fireman Bike."

VT No. Color

47-0509 Dark Brown

47-0607 Bomber Brown



47-0783



47-0784

Black Leather Deluxe Solo Seat Kit includes leather solo seat, seat post and seat tee.

VT No. Fits

47-0783 BT

47-0784 45



# Leather Buddy



47-0744

**Original Buddy Seats** available with fringe or speedwing skirts. Measures 24" long, 16" wide and features genuine leather skirt, factory steel baseplate. Seats with fringe do not have holes in skirt. Order handrail separately.

VT No.	Item	Skirt
47-0223	Black Buddy	Fringe
47-0744	Brown Buddy	Fringe
31-0507	Handrail	Separately



47-0249



47-0248



47-0934

**Original "Thin" Buddy Seat.**

VT No.	Color
47-0249	Black
47-0248	Brown
47-0934	Black



31-0507

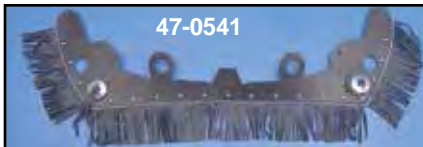

47-0541



47-0556



47-0557

**Heritage Buddy Seat Leather Skirt** is sold separately.

VT No.	Color	Item
47-0541	Black	Skirt
47-0556	Brown	Skirt
47-0557	White	Skirt
31-0507		Chrome Handrail



47-0520 Shown

**Original White Buddy Seat** is a replica of a 1940's reproduced by Corbin-Gentry, features stamped and formed steel replica baseplate with all brackets riveted in place. Foam is molded in a smooth contour and is covered with heavy top grade cowhide. Seams are factory style which is accomplished by riveting a leather strip to seat pan, then form fitting the leather top cover in place, finally sewing the top cover to the leather strip for the original look. Three piece accessorized skirt with 1 hole on each side with rosettes, accepts VT No. 31-0507 chrome handrail.

**VT No. 47-0520**



47-0232

**Original Black Buddy Seat** is a replica of the 1940's reproduced by Corbin-Gentry, features stamped and formed steel replica baseplate with all brackets riveted in place. Foam is molded in a smooth contour and is covered with heavy top grade cowhide. Seams are factory style which is accomplished by riveting a leather strip to seat pan, then form fitting the leather top cover in place, finally sewing the top cover to the leather strip for the original look. Accessorized skirt with 1 hole on each side with rosettes, accepts VT No. 31-0507 chrome handrail.

**VT No. 47-0232**



**Solo Seat Tee.**  
Universal fitment.

**VT No.**  
31-0957





# Buddy Seat



47-0538

**1960's Style Seat** features formed steel baseplate, 3 1/2" molded foam and naugahyde cover. Sewn pleated insert. Accomplished by riveting a leather strip to seat pan, then fitting the leather cover in place, finally sewing the cover to the leather strip. Seats can be mounted by use of our seat Tee's or seat Tee kits.

**VT No. Color**  
**47-0538** Black, Smooth  
**31-0507** Chrome Handrail



31-0507



**Original Buddy Seat** is in genuine leather as illustrated with 3 piece leather skirt with orange rosettes. Skirt has 2 holes on each side which accepts VT No. 49-0151 handle set as shown. Replica metal baseplate features original rib design with riveted rear cross bracket.

**VT No. Item**  
**47-0524** Black leather with three piece skirt  
**49-0151** Handle Set  
**31-0177** Front nose bracket



31-0507



49-0151



31-0507 Installed with 31-0461 on bike

**Seat Rail Mount Kit** allows attachment of our rail 31-0507 to seat T's, 31-0511 or replica type, 31-0415, when fitted with police style solo saddles with or without skirts.

**VT No. Item**  
**31-0461** Black Mount Kit Only  
**31-0507** Seat Handrail, shown



31-0461

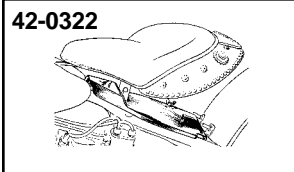

42-0322

**42-0322 Replica Battery and Oil Tank Cover** made of stainless to cover battery and oil tank. Can easily be removed for filling oil tank or battery.

**VT No. Type Year**  
**42-0322** Rigid 1936-57  
**42-1375** Swing Arm 1958-64



**Chrome Seat Handles** available as bolt on or buddy seats.

**VT No. Type**  
**31-0507** Rail  
**49-0151** Handles



**Front Nose Bracket** required to mount all Buddy Seats to stock seat tee's. Order separately.

**VT No. 31-0177**

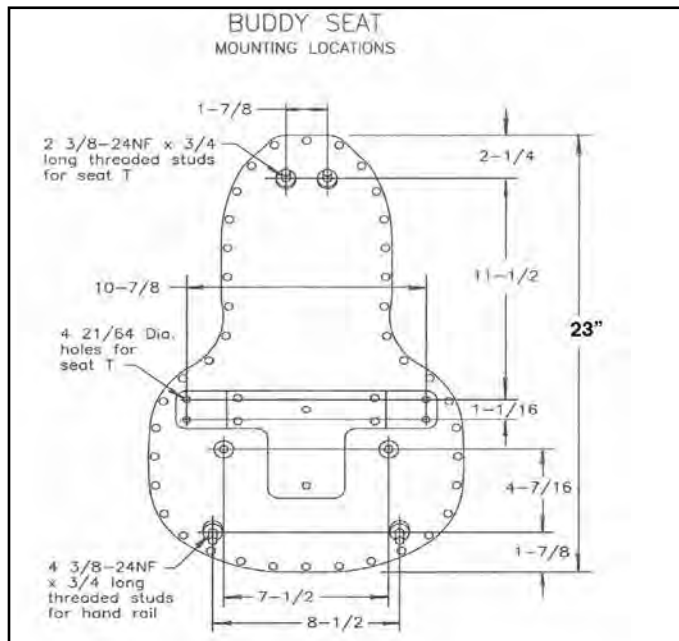



# Seat Tee

Note: Seat "Tee" Components are compatible with seat spring posts as fitted to 1930-80 models of Big Twins and 45 models. Big Twins 1930-80 are machined to fit a seat post bushing and seat post.

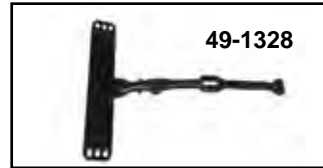
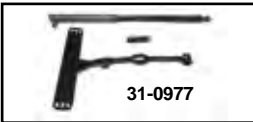

**Replica Seat Post and Tee Set** includes fully assembled post and replica forged steel seat Tee and related hardware. Cadmium kits include heavy duty cad plated post assembly with black tee.

Chrome Post	Black Post	Year	Model
31-0614	31-0616	1936-64	Big Twin
31-0615	31-0617	1965-80	Big Twin
31-1241	31-0977	1936-64	Big Twin
31-1341	31-0622	1929-73	45
	49-0978	1936-52	Big Twin

**Cadmium Post**

31-0618	1936-64	Big Twin
31-0619	1965-80	Big Twin



**Seat Tee Black Bar** will mount police an buddy seats to 1936-84 74 and 80 and 1929-73 45" equipped with seat posts. Fabricated from square solid steel and accepts a 3/8" bolt. Purchase VT No. 31-0177 separately to mount buddy seats. **VT No. 31-0511**

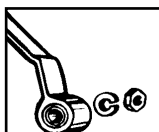

**Seat Tee Pivot Bolt and Bushing Kits.**

VT No.	Years	Use
8875-5	1937-64	Big Twin
	1929-52	45
8875-5T	1937-64	Big Twin
	1929-52	45
9676-5	As Above	Parkerized
8876-5*	1965-80	Big Twin

**Bushings Only**

10-2500	1937-64
10-2501	1965-80

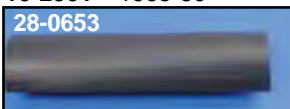

**Black Replica Tank Divider** replaces rubber filler strip when a seat tee bar is used. Replaces 61122-39.

**VT No. 28-0653**

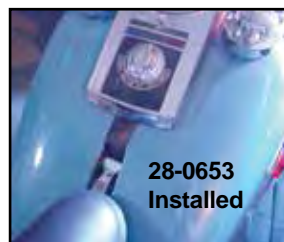

**Zinc Front Nose Bracket** required to mount all buddy seats to mount systems.

**VT No. 31-0177**

**Replica Forged Steel Seat Tee** features original construction and shape for the authentic look. Two stage front bushing included. 1936-64 includes 5/16" bolt 1965-80 includes 3/8" bolt.

VT No.	Fits	Finish	Model
49-1328	1936	Black	EL
49-1376	1937-38	Chrome	EL-UL
49-0270	1937-38	Black	EL-UL
31-0623	1930-46	Black	45
31-0630	1930-46	Chrome	45
31-0624	1938-39	Black	Big Twin
31-0569	1936-64	Black	Big Twin and 45
31-0570	1936-64	Chrome	Big Twin and 45
31-0415	1965-80	Black	Big Twin
31-0513	1965-80	Chrome	Big Twin
31-0081	1936-64	Raw Strap	



**45 Seat Mount U Clamp** to be welded on 1929-73 frames. Replaces 47066-26.

**VT No. 49-2527**

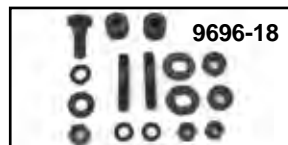

**Solo Hardware Kit** includes special 52098-34 bolt, (2) 52096-34 washers, (6) 52108-81 spacers & nuts to mount 47-0110 seats to stock tee bar.

VT No.	Finish	Item
8873-18	Cadmium Kit	Complete
31-0587	Cadmium Kit	Complete
9696-18	Parkerized Kit	Complete
49-0188	Zinc Bolt	Each





# Seat Post



**Heavy Duty Seat Post Spring Set** includes full set of springs and spacers.  
**VT No.** **Item**  
**13-9253** Kit  
**49-0263** Spacer Set



**Seat Post Bushings. Bronze.**

**VT No. Years Model**  
**8859-1** 1929-73 45  
**7708-1** 1936-57 Big Twin  
**7708-1T** 1936-57 Big Twin  
**10-1288** 1936-57 Big Twin  
**10-2497** 1958-79 Big Twin  
**2084-2** 1958-79 Big Twin



**Seat Post Bushing Installation Tools.**

**2086-1** 1936-57 Big Twin  
**2085-2** 1958-79 Big Twin



**Seat Clevis Pin and Spring** is a reproduction of seat pin and spring retainer used on all models with seat post 1929-up.

**VT No. Item**  
**8623-2** Kit  
**8623-2T** Kit, V-Twin  
**2731-2** Pin



**Seat Post Rod Lock Nut and Lockwasher** fits all models 1925-81 except FX, FL. Replaces 51674-25.



**VT No. Finish**  
**8874-2** Cadmium  
**8874-2T** Zinc  
**9691-2** Parkerized

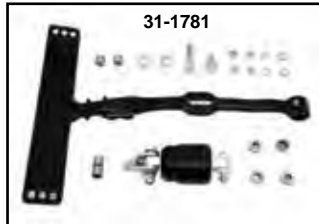

**Seat T and Shock Piston Set.**

**VT No. Finish**  
**31-0965** Chrome  
**31-1781** Black



**Mini-Shock** will replace Big Twin seat post in 1936-80 frames includes adapter clevis to connect to tee.



**VT No. Item**  
**54-0650** Mini-Shock  
**54-0955** Mini-Shock 4"  
**54-0407** Clevis

*Note: Seat "Tee" Components are compatible with the seat spring posts as fitted to 1930-80 models of Big Twins and 45 models. Big Twins 1930-80 are machined to fit a seat post bushing and seat post.*

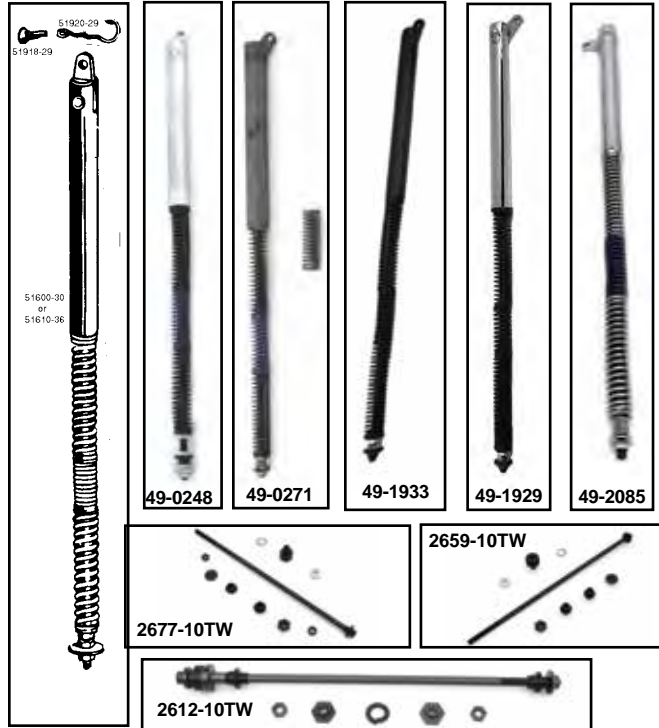

**Seat Posts for 74, 80 and 45 models** are assembled with springs and hardware. Top clevis pin and bottom nut are sold separately.

**Note:** 49-1933 post is diameter 1.060", 49-0181 and 49-1929 posts are 1.180" diameter

VT No.	OEM	Fits	Finish
<b>45 Solo &amp; Servi-Car</b>			
<b>49-1933</b>	51602-30	1930-73 45's	Black
<b>49-1926</b>	Heavy	1930-73 45's	Black
<b>49-2019</b>	Heavy	1930-73 45's	Chrome
<b>Big Twin</b>			
<b>49-1929</b>	51610-58	1936-80 Big Twin	Chrome
<b>49-0181</b>	51610-58	1936-80 Big Twin	Black
<b>49-0271</b>	—	1936-80 Big Twin	Heavy
<b>49-2085</b>	—	1936-80 Big Twin	Heavy, diameter 1.180"
<b>49-0247</b>	—	1936-64 Big Twin	Cadmium
<b>49-0248</b>	—	1936-64 Big Twin	Cadmium (Heavy Duty)
<b>13-0214</b>	Set	1936-80 Spring Set (6 piece)	Complete

### Replacement Parts

<b>49-1560</b>	Rebuild Kit
<b>49-0293</b>	Post Top, Big Twin
<b>13-0202</b>	51777-36 Recoil Spring Set Only
<b>13-0212</b>	51770-29 Big Twin and 45 Spring Lower Set, Stock
<b>49-1934</b>	51661-36 Big Twin Seat Post Inner Rod with Spacer
<b>8623-2</b>	51918-29 Top Clevis Pin, Parkerized and Spring Kit
<b>49-0242</b>	As Above Zinc
<b>49-0226</b>	51791-31 Spring Spacer

### Rod Kit

Colony	VT No	Size	Fits
<b>2659-10</b>	<b>2659-10TW</b>	15 <sup>7</sup> / <sub>8</sub> "	1929-73 G, 1929-52 W
<b>2677-10</b>	<b>2677-10TW</b>	16 <sup>7</sup> / <sub>8</sub> "	1941-80 FL, 1936-40 EL, 1937-48 UL
<b>2612-10</b>	<b>2612-10TW</b>	15 <sup>7</sup> / <sub>8</sub> "	1941-80 FL, 1936-40 EL, 1937-48 UL



# Auxiliary Seat Spring

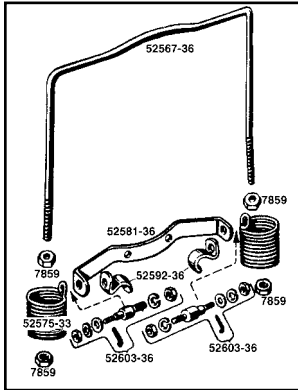

**Auxiliary Spring Assembly** includes parts pictured for 1936-57 Big Twin rigid frame. Order the Spring Clip Kit and spring hook separately.



VT No.	OEM	Item
31-3999	52560-36	Complete Assembly, 1936-57 Big Twin
31-4061	Chrome	Complete Assembly, 1936-57 Big Twin
13-9198	52575-33	Spring, Chrome, pair
13-9209	52575-33	Spring, Black, pair
31-3997	52581-36	Support Bracket
31-3996	52592-36	U Clamp, pair
31-3995	52603-36	Mount Stud, pair
31-0408	52588-38	Yoke Hook Set
	73341-36	1936-57
31-0198	52586-36	Yoke Hook, Chrome
31-0454	52586-36	As Above, Parkerized
31-3998	52567-36	Yoke
31-1311	52567-36	Yoke, Chrome
37-0862	7859	Nut, Four Piece
49-1744	—	Chrome Cups
49-0449	—	Dome Cover Set
31-0934	—	Seat Spring Yoke Bar W 1930-1952

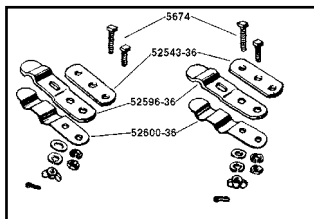

**Auxiliary Spring Clip Kit** includes 2 of each part listed 52600-36, 52596-36, 52543-36, and bolts and wing nuts for clipping spring yoke to bottom of buddy seats.

VT No. 31-3990



42-1375

**Chrome Frame Cover** include hardware as for Big Twin frames.

VT No.	Year	Type
42-0322	1936-57	Rigid, stainless
42-1375	1958-64	With seat post
31-9982	1958-80	Frame Cross Stud



**Chrome Front Solo Seat Mount Kit.** Fits 1986-up FXST.  
VT No. 31-0819



**Black Seat Post and T Kit** fits 1936-52.  
VT No. 31-0977

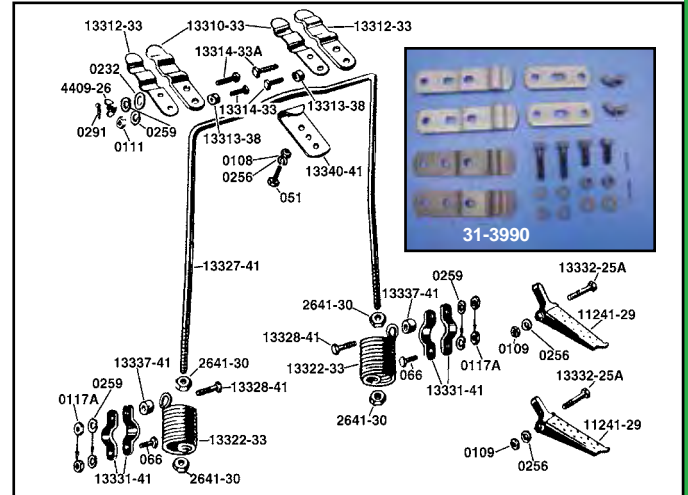

49-0177



13-9198



13-9209

**45 Auxiliary Seat Spring Kit** includes black finished parts with chrome springs. Order spring clip kit and spring hook separately.

VT No.	OEM	Item
31-3973	52562-33	Complete Assembly includes yoke bar, chrome springs and clamp set.
13-9198	52575-33	Chrome Springs
13-9209	52575-33	Black Springs
31-3972	52579-41	Frame Clamps, Four Piece
31-3958	52565-41	Spring Yoke Bar
<b>Order Related Parts Separately</b>		
31-0407	52585-41	Spring Hook
31-3990	52600-36	Spring Clip Kit
49-0177	52652-29	Rear Peg Set, Parkerized
27-1454	—	Peg Yoke Set

**Auxiliary Spring Assembly Kits Are Used With Seat Tee Bars for All Buddy and Police Size Solos.**

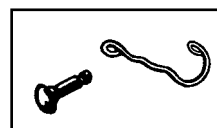

VT No. 8623-2



VT No. 31-0177



VT No. 31-0198



VT No. 31-0407  
Buddy Seat Hardware



VT No. 31-0408

VT No.	OEM	Item/Finish
8623-2	51918-29	Clevis pin with Spring
31-0177	52551-36	Front Bracket, Cadmium
31-0198	52586-36	Spring Hook, Chrome
31-0454	52586-36	As above, Parkerized
31-0408	52588-38	Spring Hook Set
	52887-36	1936-57, Parkerized
31-0407	52585-41	1941-52, 45 Solo
31-0156	—	3 hole Under Fender Mount Strip
31-1283	—	Seat and Hook Only





# Auxiliary Seat Spring Kit

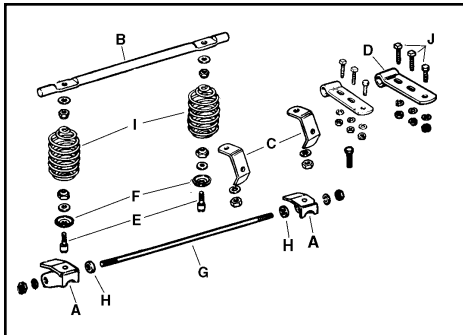
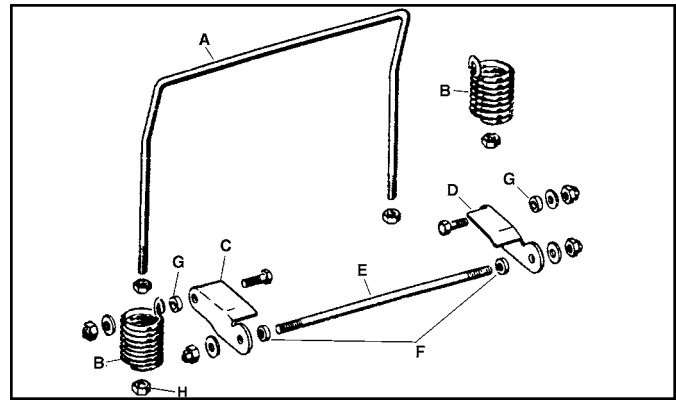
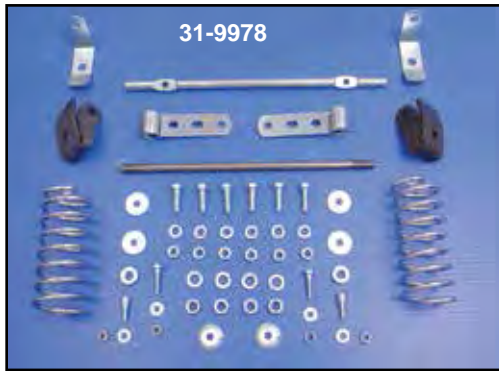

**Auxiliary Spring Kit** adapts to all plunger mounted buddy seats for extra weight Capacity. Includes all parts pictured to fit 1965-84 FLH frames. Zinc plated with chrome springs.



**Auxiliary Spring Bracket Assembly** fits 1958-64 Big Twins, order 31-3990 clip kit and hook separately.

VT No.	#	OEM	Item
31-9978	All	Complete	Kit
31-9967	A	52583-68 52584-68	Bracket Left Bracket Right
31-9968	B	52566-65	Bar
31-9969	C	52586-68	Spring Bracket (2)
31-9970	D	52596-65	Yoke (2)
37-8800	E	52608-68	Shoulder Bolt (2)
	F	52609-68	Cup Washer (2)
31-9982	G, H	52605-65 52605-68	Stud with Spacer
13-9174	I	52575-65	Spring, pair, chrome
37-8792	H	52605-58	Spacer Nut (2)
37-0510	J	5667	Square Head Bolt

VT No.	#	OEM	Item
31-0427		Kit	Complete
31-0429	A	52567-58	Spring Yoke
13-9240	B	52575-58	Spring Set, Chrome, pair
31-0428	C	52581-58	Right Support Bracket
	D	52582-58	Left Support Bracket
37-9110	E	52602-58	Stud Spring Mount
37-8792	F	52605-58	Support Stud Nut
37-9111	G	52606-58	Spring Support Spacer, pair
37-0862	H	7859	Nut, Black
37-0871	H	7859	Nut, Chrome

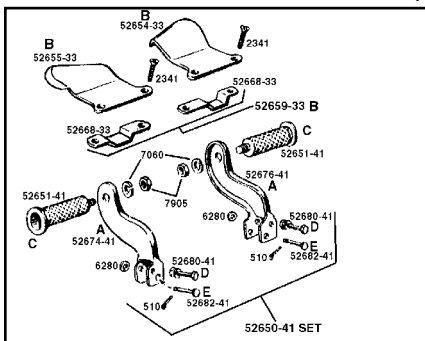

**Buddy Seat Foot Rest Brackets** mount to existing footboard brackets on 1936-64 Big Twins. Pair replaces 52674-41 and 52676-41.

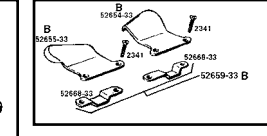
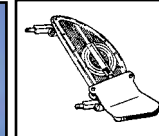

**Footboard Extension Pads** clamp on 1914-65 footboards.

VT No.	Finish
49-2556	Parkerized
49-2557	Chrome



**Footboard Hinge Bolt (Buddy Footrest Bolt) Kit** includes reproduction of special shoulder bolts, pins and bushings used to mount floor boards on 1941-64.

VT No.	Finish
8774-18	Cadmium
9722-18	Parkerized

VT No.	#	Item
27-1628	A	Chrome Brackets
27-1629	A	Black Brackets
49-2556	B	Footboard Pad, Parkerized
49-2557	B	Footboard Pad, Chrome
8774-18	D & E	Bolt Set, Cadmium
9722-18	D & E	Bolt Set, Parkerized
27-1676	C	Peg Set with Rubbers, Zinc
27-1680	C	Peg Set with Rubbers, Chrome
28-2127		Rubbers only



**Rear Foot Rests** include rubbers. Fit 1936-64 foot rest brackets.

VT No.	Finish
27-1676	Zinc
27-1680	Chrome
28-2127	Rubber Only



**Complete Buddy Footrest Kit.**  
VT No. Finish  
27-1252 Black  
27-1253 Chrome

# Tool Index

<b>A</b>	
ADVERTISING.....	1328
AIR FILTER	
Cleaner/Oil.....	1271
ALLEN SCREW LIST.....	1319
ALTERNATOR	
Repair.....	1279
Ring Replacement.....	1263
AXLE.....	1283,1304
<b>B</b>	
BATTERY.....	1297
BEARING.....	1277,1299,1300
BELT.....	1300
BELT BUCKLES.....	1325,1326,1327
BOLT LIST.....	1319
BOOK.....	1268-1270
BOTTLE OPENER.....	1328
BRAKE	
Caliper Piston.....	1301
Disc/Rotor Lock.....	1282
Fluid.....	1288
BREATHER	
Valve Service.....	1265
BUNGEE CORD.....	1314
BUSHING.....	1298
BUSHING LIST.....	1307
<b>C</b>	
CABLE OILER.....	1282
CAM.....	1280,1281
Bushing Replace.....	1264
Tune A Cam.....	1280
CAPS(Chrome).....	1318
CARBURETOR.....	1284
CASE	
Bearing Conversion.....	1275
Boring Service.....	1263
Lapping.....	1274
Seals.....	1316
CATALOG RACK.....	1328
CHAIN.....	1300
CLEANER/POLISH.....	1271
CLOCK.....	1324
CLOTH PATCH.....	1323
CLUTCH.....	1282,1300,1302
COLLECTIBLE	
Oil Can Coin Bank.....	1326
Metal Containers.....	1327
Pewter Items.....	1324,1325,1326,1327
Scale Models Trucks.....	1328
CONNECTING ROD.....	1261
COTTER PIN LIST.....	1316
COUNTER SHAFT.....	1282
COVER (Motorcycle).....	1266
CRANKCASE.....	1275,1285
CRANKSHAFT	
Balance Service.....	1262
Locking.....	1285
CYLINDER.....	1285-1286
Boring Service.....	1260
Gasket.....	1308,1312
Sleeving.....	1260
DEALER PROMOTION.....	1328
Bank.....	1328
Banner.....	1328
Catalog.....	1328
Catalog Rack.....	1328
Counter Mat.....	1328
Dealer Decal.....	1328
Labels.....	1328
Mat.....	1328
Patches.....	1328
Shop Bag.....	1328
Sign.....	1328
V-Twin Promotion.....	1328
Wire Tag.....	1328
DEUTSCH.....	1289,1292
DIAGNOSTIC.....	1289
DOWEL PIN LIST.....	1316
EARLY TOOL.....	1282

ELECTRICAL.....	1289
EMBLEM..621,646,781,1206,1208,1209	
ENGINE	
Gasket.....	1309
EXHAUST.....	1286
Port Replacement.....	1265
<b>F</b>	
FLYWHEEL.....	1261,1275
Balancing.....	1262
Locking.....	1275
Remanufacture.....	1261
FORK	
Leg Bushing.....	1265
Seal Driver.....	1303,1304
Spring Fork Rebuild.....	1265
FUEL.....	1284
Line.....	1284
Pump.....	1284
<b>G</b>	
GASTANK	
Line.....	1268
Sealant.....	1271
Shut Off.....	1283
GASKET LIST.....	1303-1313
Cam Cover.....	1309
Carburetor.....	1313
Derby Cover.....	1310
Exhaust.....	1310
Gas Tank Cap.....	1312
Locater.....	1283,1302
Manifold.....	1313
Master Cylinder.....	1312
Oil Pump.....	1309
Primary.....	1309,1313
Tail Lamp.....	1313
Transmission.....	1311,1313
Sealant.....	1271
GEAR OIL.....	1272
GIFT SETS.....	1326,1327
GOGGLE.....	1271
GREASE.....	1271
Fittings.....	1282
<b>H</b>	
HATS.....	1327
HEAD.....	1286
Gasket.....	1312
Remanufacture.....	1264
Resurfacing.....	1264
HELICOIL	
Installation Service.....	1264
HELMET NET/LOCK.....	1266
HOSE	
Clamp/Cutter.....	1284
<b>J</b>	
JET.....	1268
<b>K</b>	
KEY CHAIN/HOLDER.....	1324,1326
KEYS.....	1317
KROMMET.....	1316
<b>L</b>	
LAPEL PIN.....	1324
LAPPING.....	1278
LIFTS.....	1273,1274
Transmission/Motor.....	1273
V-Lift.....	1274
LOCK TAB LIST.....	1317
LOCKWASHER.....	1320
LUBRICATION.....	1282
Bearing Packer.....	1278
Cable/Oiler.....	1282
Gear.....	1282
Grease Fitting/Gun.....	1282
<b>M</b>	
MAINSHAFT.....	1299
MAGNETO.....	1294-1296
MASTER CYLINDER.....	1301
MOTOR PLAQUE SIGN.....	1328

<b>MOTOR SHOP SERVICE</b>	
Alternator Ring Replacement.....	1263
Breather Valve Machining.....	1265
Cam Bushing XL.....	1264
Cam Cover Bushing Big Twin.....	1264
Crankshaft Balance.....	1263
Case Boring.....	1263
Cylinder Boring.....	1260
Cylinder Sleeving.....	1260
Engine Remanufacture.....	1260
Exhaust Port Replacement.....	1265
Flywheel Balancing.....	1262
Flywheel Remanufacture.....	1261
Fork Leg Bushing Install.....	1265
4/5 Speed Rebuild Service.....	1265
5/6 Speed Conversion Service.....	1263
Generator Rebuild.....	1263
Head Remanufacturing.....	1264
Linkert Service.....	1263
Long Block Remanufacture.....	1260
Magneto Rebuild.....	1294
Short Block Remanufacture.....	1260
Spring Fork Rebuild.....	1265
Transmission Remanufacture.....	1265
Wheel Truing/Building.....	1265
MOTOR STAND.....	1273
MOVIE STUDIO LIGHTING.....	1269
<b>N</b>	
NUT LIST.....	1321,1322
<b>O</b>	
O-RING LIST.....	1314
OIL	
Drain Reserve.....	1272
Filter Wrench.....	1272
Motor/Transmission/Gear.....	1262,1272
Oil(Quarts).....	1262,1272
Pressure.....	1276
Primary/Fork.....	1276
Pump.....	1276
Seal List.....	1315
<b>P</b>	
PAINT.....	1271,1272
PARTS MANUAL.....	1268,1269
PATCHES (CLOTH).....	1323
PEWTER	
Clocks.....	1324
Key Chain.....	1324
Lapel Pin.....	1324
Motor.....	1324
PIN LIST.....	1316
PINION.....	1278
PISTON.....	1276
Ring.....	1276,1285
PRIMARY.....	1300
Gasket.....	1309,1313
PROMO.....	1328
<b>R</b>	
RACE.....	1298
RATCHET PLATE RIVET.....	1300
RIVET.....	1283,1286,1316
ROCKER ARM.....	1288
ROLLER DOLLY.....	1274
ROD	
Lapping.....	1278
ROTOR(BRAKE).....	1301
<b>S</b>	
SCALE MODEL...1294,1324,1326,1327	
SCREW LIST.....	1322
SEAL LIST.....	1315,1316
SEALANT.....	1271
Gasket.....	1271
SECURITY.....	1266
SERVICE MANUAL.....	1269,1270
SHIFT	
Fork Gauge.....	1297
Pawl.....	1298
Shaft.....	1299
SHIM LIST.....	1291

SHOCK.....	1304
SHOP SERVICE.....	1260-1265
SHOW BIKE BOLT KIT.....	1318
SKULL STUFF.....	1001-1006
SNAP CAPS.....	1302
SPACER LIST.....	1304
SPARK PLUG	
Helicoil Replacement.....	1264,1290
Plug/Tap.....	1305
Test/Firing/Index.....	1287
Thread Chaser.....	1306
SPOTLAMP.....	1284
SPRING FORK REBUILD.....	1298
SPROCKET.....	1282
STANDS(CENTER).....	1266
STARTER BEARING.....	1299
STUD LIST.....	1317
Installer.....	1317
SUSPENSION.....	1304
SWINGARM.....	1304
<b>T</b>	
TAP & DIE.....	1306
TAPPET(OIL SCREEN).....	1288
THREADING.....	1306
TIE DOWN.....	1274
TIMING.....	1287
TIRE	
Changer.....	1301
Repair.....	1301
TOOL KITS.....	1267,1282
TOOL ROLL.....	1267
TRANSMISSION.....	1298,1299
5-Speed Rebuild.....	1265
Oil.....	1272
Stand.....	1273
TWIN CAM	
Cam Clearance.....	1280
Lapping.....	1278
Pinion.....	1278
Wrist Pin.....	1276
<b>V</b>	
V-ROD.....	1302
V-TWIN PROMO.....	1328
Metal Signs.....	1328
VALVE.....	1287
Compression Release.....	1287
Cover Wrench.....	1282
Guide.....	1288
Lifter.....	1282
Seat Service.....	1264
VOLT METER.....	1297
<b>W</b>	
WASHER LIST.....	1320,1322
WALL OF DEATH MODEL.....	1327
WHEEL	
Bearing Greaser.....	1282
Building and Truing.....	1265
Chock.....	1267
Truing Stand.....	1301
WIRE	
Clamp.....	1280
Connector.....	1277-1279
WIRING.....	1284,1287
WRENCH.....	1256,1260,1266,1267, 1272,1282,1287,1288,1289
WRIST PIN.....	1266
<b>X</b>	
XL TOOL.....	929





# Motor Shop Cylinder Finishing



Power Stroke Hone



Kwik-way Boring Bar



### Shop Services Procedure:

- Call for Return Goods Authorization (RGA)#
- Obtain RGA # and return to

**Motor Shop Procedure**  
9 Scobie Drive

**Newburgh, New York 12550**

- Finished work order will be returned by UPS

**Cylinder Boring Service.** The V-Twin Motor Shop will bore and hone customers cylinder and fit to next oversize required pistons. Boring will done on a Kwik-way Boring Bar and honing will be done on a vertical Winona Van Norman Powerstroke Hone for a precision fit. Choose any brand of piston from our catalog section and note VT Part Number on Work Order/ Authorization Form. Work will be performed on sets of cylinders only. Pack cylinders with care as we are not responsible for broken fins in shipping.

**VT No. 60-0167**



### Motor Shop Ready Long Block or Short Remanufacturing Service.

Ship in your assembled long block or short block and we will disassemble and glass bead base, remanufacture fly-wheels, inspect oil pump and reassemble with new bearings, washers, races and internal hardware. Early lower ends (1936-69) will be fitted with new case races and line honed for proper fit. Long block remanufacturing service will include short block service plus the addition of a cylinder boring, new piston, valve job and assembly with new hardware. Call shop service for RA# prior to return.

Short Block Remanufacturing	Long Block Remanufacturing	Year
60-0176	60-0178	1936-57
60-0177	60-0179	1958-99



**Motor Shop Services Cylinder Sleeving.** Send in your worn out original cylinder and Motor Shop Services will bore and fit new LA sleeves liner. Cylinder will then be finished honed to V-Twin standard piston size. Work Order Authorization Number required before sending in. Pack carefully as we are not responsible for broken fins. Service is done per cylinder. Sleeves are also available separately.

Service	VT No	Bore	Application
	<b>Sleeve Only</b>		
60-0124	11-1175	2.745	45" Side Valve
60-0124	11-1176	3.312	61" Knucklehead
60-0124	11-1177	3.422	80" Side Valve
60-0124	11-1178	3.437	74" Overhead Valve
60-0124	11-1179	88.8 mm	80" Overhead Valve
60-0124	11-1180	3.00	900 cc Sportster
60-0124	11-1181	3.188	1000 cc Sportster

### FLYWHEEL REBUILDING SERVICE.

We will install new shafts, crank pin, rollers, cages and wrist pin bushings for years listed. Ship your rebuildable matched right and left Flywheels with connecting rods and we will return the Flywheel C.O.D. and notify you if any extra charges are incurred during the rebuilding. Tedd Cycle, Inc. original service since 1969 with a turn around time of 15 working days.

### V-Twin Motor Shop Twin Cam Flywheel Remanufacturing Services

**Flywheel** that are out of round or scissored can be repaired. The new flywheels on the 1999-up Big Twin are pressed together, but no match for our V-Twin Motor Shop. We will press apart and disassemble this style wheel assembly, inspect shafts, and crank pin components. V-Twin Motor Shop will rebuild your Twin Cam flywheel assembly to OEM specification using new bearings, crank pin and solid plugs, then balance and true. We can also weld the pin and plugs, if requested, at the flywheel and crank pin interface, for rigid power. We stock the bearings, cages and oversize crank pins to provide you with the components at hand when your flywheel arrives. We will hone the rods to allow the oversize pin to be fitted as required. Flywheel set will be trued and balanced. The final assembly and press is complete in our dedicated TC-88 flywheel fixture assembly.

We install new hardened crank pin and bearing set into the rebuildable rods. If required, new connecting rods can be installed with customer's authorization. We balance the wheels for the new parts and stock piston weight. We press the flywheel halved back together and true the bearing journals to .001" or less. Truing the bearing journal eliminates engine vibration at cruise speeds.

V-Twin Motor Shop can also install solid crank pin expansion plugs and then tig weld the pin and plugs so flywheels won't flex or scissor. This extra step can help prevent future problems. The rebuilt flywheel is stronger than stock OEM.

For a smoother running engine, high speed balancing is done on a Sunnen Dynamic Balancer. This service will require customer's piston or purchase of new piston kits from V-Twin.

We also offer several other machine shop services. V-Twin Motor Shop can also weld and repair all types of metal and aluminum parts like crank cases, cylinders and heads.

Our newly developed TC-88 Flywheel program allow Twin Cam model flywheels professionally rebuilt in V-Twin Motor Shop.

To Request a work order RA number, or for any questions call:  
1-800-833-8946 ext. 6

#### VT No. Service

- 60-0249** Twin Cam Remanufacturing Service
- 60-0248** TC Remanufacturing with New Connecting Rod Set
- 60-0247** Crank Pin/Plug Welding Service
- 60-0123** High Speed Balancing with a flywheel remanufacturing service



**Connecting Rod Set** includes crank pin, two solid caps, and bearings. The upper bushing is installed. Wrist pin bushings installed fits for twin cam Big Twin models. Set is crafted with high precision.

**VT No. 10-1607**

## Flywheel Rebuilding



### Motor Shop Flywheel

**Rebuilding Service.** We will install new shafts, crank pin, rollers, cages and wrist pin bushings for years listed. Service includes flywheel truing. Dynamic balancing is also available for any flywheel remanufacturing service for a smoother running engine.



#### VT No.

- | VT No.          | Item  |
|-----------------|---|
| <b>10-0115</b>  | 1929-73 45"                                 |
| <b>10-1110</b>  | 1930-36 VL                                  |
| <b>10-0114</b>  | 1936-48 74" and 80" Side Valve              |
| <b>10-0122</b>  | 1970-72 Shovelhead                          |
| <b>10-0123</b>  | 1973-84 Shovelhead                          |
| <b>10-1104</b>  | 1987-89 Evolution, 1340, 1985-86 Shovelhead |
| <b>10-1102</b>  | 1990-99 Evolution, 1340, 1985-86 Shovelhead |
| <b>10-0124</b>  | 1957-76 XL, XLH                             |
| <b>10-1100</b>  | 1977-80 XL                                  |
| <b>10-1101</b>  | 1981-86 XL                                  |
| <b>10-1103</b>  | 1987-99 XL                                  |
| <b>10-1120</b>  | 2000-up XL                                  |
| <b>10-1111</b>  | 1936-39 Knucklehead 61"                     |
| <b>10-0116</b>  | 1940-47 Knucklehead 61"                     |
| <b>10-1109</b>  | 1941-47 Knucklehead 74"                     |
| <b>10-0117</b>  | 1948-53 Panhead 74"                         |
| <b>10-0118</b>  | 1954-55 Panhead 74"                         |
| <b>10-0119</b>  | 1956-57 Panhead 74"                         |
| <b>10-0120</b>  | 1958-64 Panhead 74"                         |
| <b>10-0121</b>  | 1965-69 Pan and Early Shovelhead            |
| <b>60-0123*</b> | Dynamic Balancing for the Above             |

\*Note: Requires purchase of a V-Twin Piston Kit



### Flywheel Assembly Installation.

This service includes pressing flywheel shaft into left side bearing and setting up required crankshaft end play. Parts extra as required.

**VT No. 60-0173**







# Flywheel Balancing

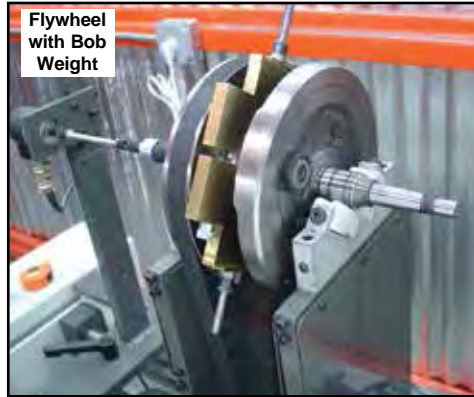
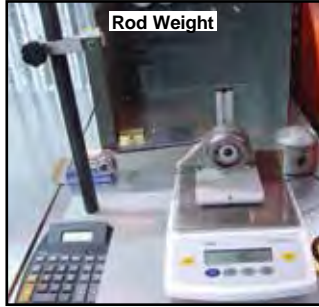

Motor Shop Oil. All are sold in case of six in quart size bottles.

VT No.	Type	Weight
41-0991	SynGold	20w50w
41-0992	Heavy Duty	60w
41-0993	Synthetic Gear Lube	Transmission/Primary
41-0994	Synthetic Clean	20w50w
41-0995	Heavy Duty	20w50w
41-0996	Heavy Duty/Synthetic	50w

Motor Shop Ready Transmission/Primary Formulated Lube is a synthetic blend lube to provide excellent lubricity for the anti-wear requires of transmission gears and primary components. Adds protection between moving parts and out performs conventional oils. Use in all Big Twin transmissions and primary chain case 1984-up Sportster transmission and primary case 1971-up.

VT No. 41-0993

**The V-Twin Motor Shop has the components in stock, at the Motor Shop, No Excuses for Parts Availability!**

**We have the machines, machinists and components to facilitate your rebuild!**  
1262

**Dynamic Flywheel Balancing.** We use the latest in Sunnen Technology to balance flywheels and rods with appropriate piston.

**VT No. Service**

**60-0169** True/Balance

**60-0173** Case Installing 1958-up

**60-0180** Case Installing 1936-57

**Motor Shop Ready Oil** is available in heavy duty, synthetic blend and full synthetic weights.

**Heavy Duty Oil** is designed and licensed to meet API service category SN specification. Meets SAE specifications and warranty requirements for gasoline engines.

**SynClean Synthetic Blend** type extends engine life significantly reduces engine wear, resists thermal breakdown and out performs conventional oils in engine cleanliness, fuel economy and protection between moving parts.

**SynGold Full Synthetic Oil** is uniquely designed to help provide outstanding levels of fuel economy performance, cleaning power and engine protection even during longer oil change intervals. *SynGold* is proven to significantly reduce wear and viscosity breakdown because of its advancements in oil technology.

All are sold in case of six. Our quart bottles designed for easy pouring and storage.

# Case Boring



## Precision Case Boring Service.

- V-Twin Motor Shop will use a vertical mill to enlarge the cylinder hole or head chamber to accept Big Bore Spigot barrels.
- Ship cases to V-Twin with a turn around time of 15 days.

VT No.	Type
60-0165	Case
60-0171	Heads

## Generator Rebuilding Service

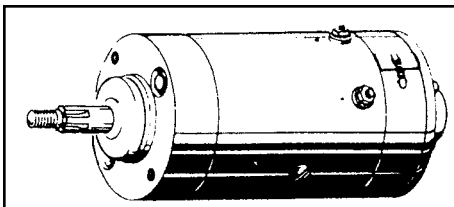

**Motor Shop Services.** We now offer generator rebuilding service for original H-D generators. Send us your old, tired, worn out generator and we will completely rebuild with new field coils, armature, brushes, seals, gear and corresponding regulator. All units are tested for correct output. Specify regulator type desires.

### VT No. Item

- 60-0200** 12 Volt 2 Brush for 1965-up Generator
- 60-0202** 6 Volt 2 Brush for 1958-64 Generator
- 60-0203** 6 Volt 3 Brush for 1930-57 Generator
- 60-0204** Convert 3 Brush 6 Volt to 2 Brush 12 Volt
- 60-0205** 6 Volt 2 Brush for Cooled Generator 1958-64



**Brake Drum Sprocket Replacement Service** for 1930-72 Big Twins, 1952-78 Sportster and 1935-52 45" Solo models. Send in your old brake drum and we will install new sprocket, splash or dust ring correctly with hot riveting as original. All drums inspected for suitability and customer notified if not serviceable. Work order number required before sending in. Contact Motor Shop Service Department prior to shipping your drum in.

**VT No. 60-0259**



**VT No. 60-0188**



**VT No. 60-0148**

**VT No. Carb 60-0195** M88, M51L, M41, M51 and M74  
**60-0345** M88, M51L, M41, M51 and M74

**Linkert M74**

**Linkert Rebuild Service.** Parts billed separately as required.

## Alternator Sealing Ring Service



**Motor Shop Alternator Sealing Ring Replacement Service.** Ship in 1970-up left hand case with damaged O-Ring lip and we will machine out and replace with new steel sealing ring.

**VT No. 60-0164**



**Big Twin Alternator Rotor Puller** uses the two threaded holes in rotor to allow removal of rotor.

**VT No. 16-0693**



**Big Twin Alternator Rotor Puller** uses the sprocket shaft end to center and the two threaded holes in rotor to allow removal of rotor.

**VT No. 16-1054**



**Alternator Repair Ring Only.**  
**VT No. 16-0692**





# Head Service

**Motor Shop Ready!**  
Ship Heads to V-Twin with turn around time of 15 working days. We will return by UPS!



**Spark Plug Hole Service.** Motor Shop will HeliCoil spark plug hole on head set that utilize 14 mm spark plugs. 15 day turn around time. Chose HeliCoil only or Weld-Up and HeliCoil.

**VT No. Type**  
**60-0168 HeliCoil**  
**60-0170 Weld/HeliCoil**



Service Performed on Sunnen VGS20



**Head Resurfacing Service** is performed on a Winona machine for accuracy and surface flatness .

**VT No. 60-0172**

**Shop Services Procedure:**

- Call for Return Goods Authorization (RGA)#
- Obtain RGA # and return to

**Motor Shop Service**

9 Scobie Drive

Newburgh, New York 12550

- Finished work order will be returned by UPS



**Motor Shop Ready Head Remanufacturing Service.** Available as a valve job only or as a valve seat/valve job remanufacturing service. We will glass bead heads, install new cast iron guides, nitrated coated valves, spring, collars and keepers for both services. For valve seat

service all of the above will be done with the addition of installing new no-lead valve seats. Heads must be in rebuildable condition and will be done in sets only. Service will be performed on a Sunnen Valve Machine that will insure correct valve stem to seat alignment.

For stock lift cams.

Valve Job Service	Valve Seat/Job Service	Item
11-9049	11-9050	1948-65 Panheads
11-9048	11-9051	1966-80 Shovelheads
11-9047	11-9052	1981-84 Shovelheads
11-9046	11-9055	1986-up Evolution Big Twin
11-9045	11-9053	1957-69 Sportster
11-9044	11-9057	1970-82 Sportster
11-9043	11-9054	1983-85 Sportster
11-9042	11-9056	1986-up Sportster

## Cam Bushing



**Motor Shop Cam Bushing Service** will replace bushings in Big Twin cam cover for 1936-up models.

**VT No. 60-0133**



**Motor Shop Cam Cover Bushing Service** will install new bushings in right side case and cam cover for 1957-up XL models.

**VT No. 60-0131**



## Breather Valve Service



**Motor Shop Ready Breather Valve Machining Service** can be performed on any 1936-99 Big Twin right hand case. Breather hole will be honed out and fitted with a +.030 steel breather valve. If Breather Hole will not clean up with oversize machining process we also offer sleeving service requires boring of breather hole and then fitting with sleeve. We will then final hone and fit with standard size breather valve. Ship in your right hand case and we will return to you by UPS with a turn around time of 15 working days.

O/S Service	Sleeving Service	Fits
60-0156	60-0159	1936-47
60-0157	60-0160	1948-77
60-0158	60-0161	1978-99

## Fork Bushing Service



**Fork Leg Bushing Service.** We will remove old bushings, install and size new bushings to standard inner diameter for new fork tubes. Service includes new bushings and labor.

VT No.	Years	Model
60-0150	1949-76	FL, FLH
60-0155	1984-up	FXST-FLT

### FX Models

60-0151	1952-72	FX
60-0152	1984-87	FX
60-0153	1988-up	FX

### XL Models

60-0151	1952-72	XL
60-0152	1984-87	XL
60-0153	1988-up	XL

**Leg Assembly Service.** We install internals and lower leg on to fork tubes. **VT No. 60-0166**



**Early Spring Fork Rebuilds.** Send us your early springer fork (pre1958) any model and we will rebuild completely. Includes new bushings, studs, bearings, locks and washers. Rockers and powder coating available at additional cost spring inspection assessment done replaceable at additional cost.

### VT No. Item

- 60-0190 Complete Spring Fork Rebuild
- 60-0191 As Above with New Rockers
- 60-0192 As Above with Powder Coating (Black Only) Strip/Phosphorize/Coat
- 60-0193 As Above with Powder Coating and New Rockers

## Wheel Truing



### Since 1969! Wheel Building Service

Select any of our hubs, a set of spokes including stainless steel, chrome, twirled or diamond spokes and rim. We will lace and true in our plant. The finished wheel can be shipped in 24 hours. Complete wheel will be billed as follows: Rim, spokes, hub and labor. Service limited to components in stock.

**VT No. 60-0125**

## Exhaust Port



**Exhaust Port Replacement Service.** Available for both Pan and Shovelhead applications. Ship in old disassembled cylinder heads and the broken or stripped exhaust ports will be replaced with new factory style exhaust ports. Service includes ports as shown.

### VT No. Replacement Service

- 60-0162 Panhead
- 60-0163 Shovelhead

## Transmission Remanufacturing



**Motor Shop Ready Big Twin Transmission Remanufacturing Service.** Ship in your fully assembled transmission and we will disassemble and glass bead case, replace mainshaft, countershaft, thrustwashers, bearings and reassemble with new hardware. All gears will be reused unless they are damaged and then customer will be advised of added cost early transmission (1936-76) will be fitted with new main drive race and sized for correct roller. Call shop service for RA# prior to return.

### VT No. Year Type

- 60-0174 1936-76 4-Speed Big Twin
- 60-0175 1977-84 4-Speed Big Twin
- 60-0183 1986-99 5-Speed Big Twin
- 60-0260 1929-73 3-Speed 45"



### 5 To 6 Speed Conversions

**1994-2005.** Ship in your 5 Speed Transmission and we will glass bead and install a complete 6 speed conversion kit. This service will be performed in house by our highly experienced machinist. Transmission will be shipped back to you fully assembly and tested ready to "bolt in." All you do is add oil. **VT No. 60-0184**





# Display Center Stands



16-1111



16-1600 Installed



16-1600



16-1109



16-1110



16-1116

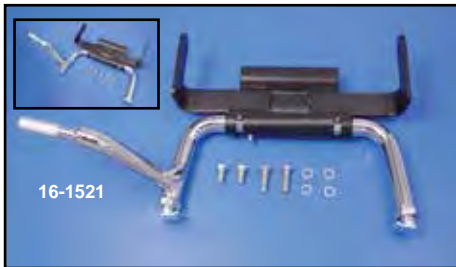

16-1521



16-1521 Installed



16-1522



16-1511

## Bungee Cord & Security

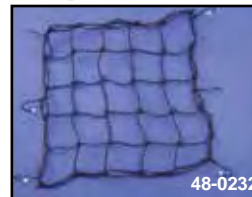

48-0232



48-1636

**Helmet Net** secures the helmet to the seat with elastic tension.

**VT No. Item Color**

48-0232 20" x 20" Black

48-0339 15" x 15" Black

48-1636 15" x 15" Yellow



37-8982

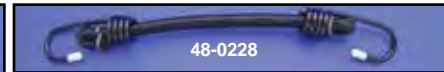

48-0228

**Bungee Cords** are black elastic sold in 10 packs.

**VT No. Item**

48-0228 12" Single

37-8982 Bungee Nut 3/8 x 24 mounts to stock studs

37-8983 Bungee Nut 3/8 x 16 mounts to stock studs



## DOWCO INC. Covers

**Guardian Custom Bike Cover** by Dowco. Available for custom bikes with wheel bases up to 72". This cover features soft cotton fabric interior lining to protect painted and chrome surfaces, shock cord hem along the bottom for easy installation, reinforced grommets for use with cable lock to help prevent theft and breathable material that lets damaging moisture escape. **VT No. 48-1228**



**Disc Brake Rotor Lock** acts as dead bolt through rotor.

**VT No. 48-0703**



**Chrome Helmet Lock** clamps to 7/8" through 1 1/4" diameter tubing, secures helmet. **VT No. 48-1732**



# Tool Kit

**V-Twin Rider Tool Kits.** Complete kits, supplied as appropriate for each year and model; includes tool roll. Entire kit fits individual kidney shaped tool box!

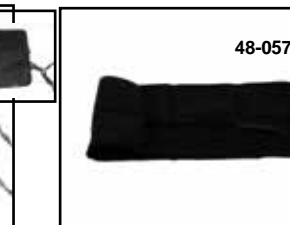

### Tool Kits

VT No.	Fits
16-0849	1957-70 XL
16-0846	1977-84 XL
16-0746	1986-up XL, TC-88 ST
16-0850	1979-84 FLT
16-0857	1985-up FLT
16-0854	1985-88 FXST, 1986-88 FLST
16-0856	1989-up FXST, 1989-up FLST
16-1007	1989-up Softail Tool Kit
16-0011	1999-13 FLT
16-0098	2014-up FLST

### Early Tool Kits.

16-0843	1936-57 61 and 74 OHV
16-0844	1958-72 OHV
16-0840	1929-73 45" and Solo
16-0841	1930-40 SV-VL-ULH
16-0842	1941-48 SV-VL-ULH
16-1270	Universal

### Tool Rolls and Pouches

48-0570	Nylon	Pouch
48-0571	Nylon	Roll
48-0572	Canvas	Roll



**13 in 1 Folding Tool.**  
VT No. 16-0078

# Tool Pouch & Roll



48-0582



48-0583

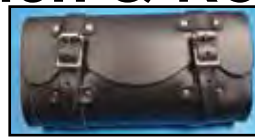

**Double Strap Tool Roll** with duo strap. Heavy leather roll, measures 10" x 4½" x 3" tall.  
VT No. 48-3112



**Heavy Leather Tool Bag** with duo strap measures 10" x 4½" x 3" and is 8 oz. leather. Full grain top leather is tanned oiled and wax treated. Features 4-way adjustable straps for easy mounting.  
VT No 48-3113



48-0812



48-0813



**Soft Leather Tool Roll** features fully padded inside zipper and velcro secured flap. Includes two heavy leather mount straps with roller buckles. The tool roll measures 11½ L x 4" W x 4¼" H.  
VT No. 48-3116



**FLH Windshield Pouch.** Windshield bag. Heavy oily leather, glued, sewn, riveted. Black, 9" x 3" x 6".  
VT No. 48-3125

### Replica FLH Windshield Bag.

Gold Trim	Silver Trim	Color
48-0582	48-0812	White
48-0583	48-0813	Black





# Big Twin



48-1740



48-1753

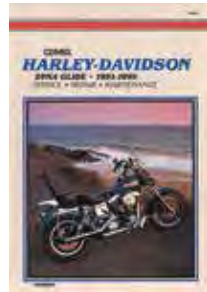

48-1711



48-1755

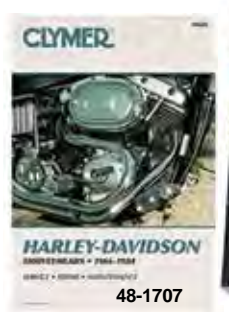

48-1707

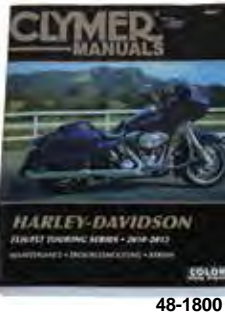

48-1800

Clymer Repair Manuals contain tips from engine tuning to complete wiring. Feature exploded views and photos, step by step instructions. New editions.

VT No.	Year/Model	VT No.	Year/Model
48-1707	1966-84 Shovelhead	48-1763	2006-11 Dynaglide
48-1740	1984-99 FXST-FLST	48-1753	1995-98 FLT-FXR
48-1759	2000-05 FXST-FLST	48-1754	1999-05 FLT
48-1761	2006-09 FXST-FLST	48-1762	2006-09 FLT
48-1711	1991-98 Dynaglide	48-1800	2010-13 FLT
48-1755	1999-10 Dynaglide		
48-1810	2011-up FXST-FLST		



**Bruce Palmer's How to Restore Your Harley-Davidson (Latest Edition).**  
VT No. 48-1356



**How to Rebuild & Restore Classic Harley-Davidson Big Twins Book** by Rick Schunk.  
VT No. 48-0579



**Q&A Repair** by Uncle Frank. This repair manual cover most Harley-Davidson and Indian tech tips. 216 pages.  
VT No. 48-0407



**How to Build a Motorcycle** is an 64 page book, with 100 color illustrations, by Saskia Lacey. Ages 6 and up.  
VT No. 48-0487



**Hard Covered Motorcycle Books.**  
VT No. Title  
48-0936 ABC 1920  
48-0935 1912  
48-0938 1906

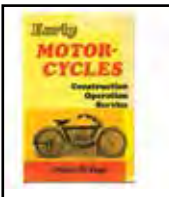

**Early Motorcycle Construction Operation Service** by Victor W. Pagé. 700 pages.  
VT No. 48-0366



**The Motorcycle Industry in New York State History** by Geoffrey N. Stein.  
VT No. 48-1242



**Bobby and Jean of Newburgh**, a children's book about Newburgh, New York written in 1937. 64 pages.  
VT No. 48-0985



**Temple Hill Booklet.** 32 pages about the historical landmarks in Newburgh, New York and surrounding areas. Special features regarding the dedication of the Temple Hill monument. Historical map of area where George Washington set up his camp.  
VT No. 48-2200

# Sportster



48-0587

48-0598

48-1760

Clymer Repair Manuals for XL's. Contain tips from engine tuning to complete wiring. Features lots of exploded views and photos, step by step instructions. New editions.

VT No.	Years
48-0587	1959-85
48-1760	1986-03
48-0598	2004-up

# Big Twin Parts Book

Spare Parts Books provide OEM numbers with exploded views to help identify exact parts required for each year application and range of fitment for each part.



48-0766

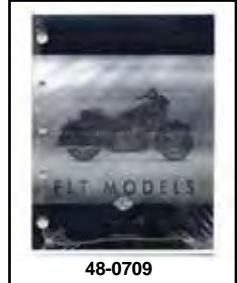

48-0709

Spare Parts Books provide detailed exploded views and OEM factory numbers for specific models.

VT No.	OEM	Years/Model
48-0520		45 Army Spare Parts Book
48-1245		Servi Car Spare Parts Book
48-1626		Spare Parts for 1941Knucklehead
48-0974	99439-86A	1984-86 FXR
48-0591	99426-99	1999 FXR <sup>2</sup>
48-0592	99427-99	1999 FXR <sup>3</sup>
48-0601	99429-00	2000 FXR <sup>4</sup>
48-1558	99450-92	1991-92 Big Twin
48-1590	99450-94	1993-94 1340 Big Twin
48-0971	99438-86B	1984-86 FLT
48-0709	99456-99A	1999 FLT
48-0602	99456-01	2001 FLT
48-0718	99456-03	2003 FLT
48-0951	99439-97	1997 Dynaglide
48-0811	99439-98A	1998 Dynaglide
48-0680	99439-00	2000 Dynaglide
48-0603	99439-01	2001 Dynaglide
48-0719	99439-03	2003 Dynaglide
48-0624	99439-04	2004 Dynaglide
48-0766	99439-07	2007 Dynaglide
48-0771	99439-08	2008 Dynaglide
48-1239	99439-09	2009 Dynaglide
48-0997	99455-98A	1998 Softail
48-0604	99455-01A	2001 Softail Deuce
48-0720	99455-03	2003 Softail
48-0623	99455-04	2004 Softail
48-0772	99455-08	2008 Softail
48-1240	99455-09	2009 Softail
48-0617	99457-02	2002 VRSC
48-0721	99457-03	2003 VRSC
48-0621	99457-04	2004 VRSC
48-0730	99457-05	2005 VRSC
48-0738	99457-06	2006 VRSC
48-0768	99457-07	2007 VRSC
48-0773	99457-08	2008 VRSC
48-1241	99457-09	2009 VRSC
48-1302	99457-10	2010 VRSC
48-1311	99457-11	2011 VRSC
48-0475		Motorshop Factory Tool Guide
48-1817		1970-73 FL Repair Guide
48-1880		Accessory Book
48-1573		Rider's Handbook



**Two Wheel Treasures** by Ed Youngblood for Antique Motorcycle Foundation, 88 pages.  
VT No. 48-0179

# Big Twin Factory Service Manual

# For XL



48-0627



48-0628



48-0713



48-0683



48-0992



48-0716



48-0715



48-0722

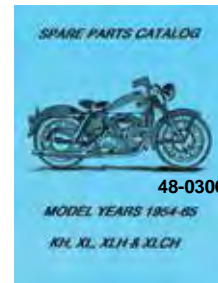

**Spare Parts Books** provide detailed exploded views and OEM factory numbers for specific models.

VT No.	OEM	Years
48-0306	—	1954-65
48-1557	99451-92	1991-92
48-1591	99451-93	1993-94
48-0953	99451-97	1997
48-0677	99451-00A	2000
48-0722	99451-03	2003
48-0724	99451-04	2004
48-0725	99451-05	2005
48-0739	99451-06	2006
48-0758	99451-07	2007
48-1232	99451-09	2009

**Service Manuals** for years listed. Manuals cover disassembly, renewal and reassembly procedures. Includes information about engines, electrical systems, frame and forks, fuel system, transmissions, wheels and more.

VT No.	OEM	Year/Model
48-0607	99480-00	2000 FXR <sup>4</sup>
48-0714	99483-03	2003 FLT
48-0731	99483-05	2005 FLT
48-0752	99483-06	2006 FLT
48-0852	2006-09	Side Cars
48-1577	99481-92	1991-92 Dynaglide
48-0707	99481-99A	1999 Dynaglide
48-0609	99481-01	2001 Dynaglide
48-0613	99481-02	2002 Dynaglide
48-0715	99481-03	2003 Dynaglide
48-0627	99481-04	2004 Dynaglide
48-0732	99481-05	2005 Dynaglide
48-0775	99481-07	2007 Dynaglide
48-1578	99965-89	1989 Big Twin International
48-0683	99482-00A	2000 FXST-FLST, deuce
48-0614	99482-02	2002 FXST-FLST
48-0716	99482-03	2003 FXST-FLST
48-0628	99482-04	2004 FXST-FLST
48-0615	99501-02	2002 VRSC
48-0717	99501-03	2003 VRSC
48-0629	99501-04	2004 VRSC
48-0777	99501-08	2008 VRSC
48-1237	99501-09	2009 VRSC
48-1298	99501-10	2010 VRSC

**Note: For our Product Descriptions “XL” denotes for Sportster models (including XLH, XLCH, XLS).**

## Movie Studio Lighting.

VT No.	Item
33-7000	DTW 150 Tungsten Light
33-7001	DTW 300 Tungsten Light
33-7002	DTW 650 Tungsten Light
33-7003	DTW 1000 Tungsten Light
33-7004	DTW 2000 Tungsten Light
33-7005	C-Stand
33-7007	600M High Overhead Roller Stand
33-7008	300M High Roller Stand
<b>Replacement Bulbs for Fresnel Tungsten lights</b>	
33-7020	150 watt bulb 120 volt
33-7021	300 watt bulb 120 volt
33-7022	650 watt bulb 120 volt
33-7023	1000 watt bulb 120 volt
33-7024	2000 watt bulb 120 volt
33-7015	Midi Pro Stand
33-7016	Stand
33-7017	Handy Stand

Spare Parts Books provide OEM numbers with exploded views to help identify exact parts required for each year application & range of fitment for each part.





# Book and Manual



48-1244 48-0299 48-0308 48-0310



48-0307 48-1718 48-0692 48-0521

Service Manuals for years listed.

VT No.	Years	Model
48-1244	1959-70	G
48-0299	1929-52	WL
48-0308	1940-47	FL and 1937-48 UL
48-0310	1940-58	1940-52 WL and 1940-58 G
48-0307	1948-57	FL, Rigid (version with service charge manual)
48-0373	1948-57	FL, Rigid
48-0477	1970-76	FLH
48-0835	1958-69	FL
48-1718	1959-69	FL
48-0521	1941-44	45 Army
48-1381	1959-65	EL
48-1719	1959-69	XL
48-0326	1959-69	XL
48-1573	1966-69	FL Rider's Guide



48-0323 48-0309 48-0314 48-0313



48-0304 48-0328 48-0319 48-0834

Spare Parts Books provide detailed exploded views and OEM factory numbers for specific models. Parts Books provide OEM numbers with exploded views to help identify exact parts required for each year application and range of fitment for each of those parts

VT No.	Years/Model
48-0336	1913-21 F, 1920-21 J
48-0328	1927-36 JD
48-0474	1930-36 VL, 1936-40 EL, UL, W
48-0834	1941
48-0323	1936-40 EL, 1937-48 UL, 1941-47 FL
48-0309	1941-48 UL, 1941-54 FL, 1941-54 WL
48-0835	1930-up W, V, FL, FX, G
48-0314	1949-57 FL
48-0313	1958-68 FL
48-0304	1940-52 WL
48-0319	1958-73 G
48-0525	1952-56 K
48-0933	1961-76
48-1382	1970-78
48-0333	1971-80 FX
48-0488	45" Parts and Guide



48-0488



48-0928 48-1166 48-1175 48-0832

Parts-Service Manual

48-0928	Knucklehead
48-1166	Panhead
48-1175	Shovelhead
48-0832	1909-1932



Mechanics and Owners Guide for 1941-1959 Harley-Davidson OHV Big Twins by Kirk Perry, drawings, photos and tips.

VT No.	Volume
48-1958	1
48-1959	2

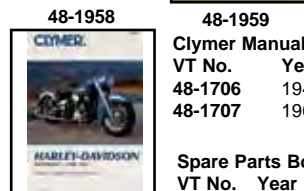

Clymer Manuals.

VT No.	Year/Model
48-1706	1948-65 Panhead
48-1707	1966-85 Shovelhead



48-0763 48-0473 48-0745



48-1271 48-0479 48-0478

Book Sets.

VT No.	Books	Type
48-0763	6	Flathead
48-0473	4	45"
48-0745	6	1948-65 Panhead
48-0478	3	Servi-Car
48-0531	5	WLA Set
48-0524	3	45" Army Manual Set
48-0943	3	Rigid Panhead
48-0941	3	1958-69 Set
48-0479	3	1936 Set
48-0941	3	1959-65 Set
48-0826	4	1941-80 FLH Library
48-1271	8	Set 8 books; Shop Parts Books Series
48-1648	3	Shovelhead
48-1471		Vintage Motorcycle Set



48-0826



Factory Service Bulletins. "Shop Dope" is a compilation of service tips from factory to dealers for years listed. Great for trouble shooting. Bound.

VT No.	Year	Volume
48-0329	1912-26 Twins	1
48-0311	1930-40 Twins	2
48-0305	1941-56 Twins	3
48-0320	1957-69 Twins	4
48-0740	Complete Series (4 Books)	
48-1331	Knucklehead Dope	
48-1520	Dope	5

Paint and Number Reference Manual includes cross reference of new numbers to old and old to new. Also included is the paint reference 1903-1976, 64 pages.

VT No. 48-1757



# Goggle



48-0222



48-0622

**Road Goggles** feature original designs with adjustable elastic straps. Face area available in either vinyl or leather, rim around the lens available in black or chrome.

VT No.	Type	Face	Rim	Lens
48-0222	Red Baron	Vinyl	Black	Split
48-0622	Aviator	Leather	Chrome	Smooth
48-0223	MK4		Chrome	Split, Stadium



48-0853



48-0854

**Retro Goggles** are available with smokey or clear lenses.

VT No.	Type
48-0853	Smokey
48-0854	Clear



**Original Stadium MK4 Goggles.**  
VT No. 48-0223



**PJ1 Blue Label** is heavy duty. Won't fly off.  
VT No. 41-0134  
8 oz.  
41-0135  
18 oz.



**Nevr-Dull Wadding Polish** is a cotton wadding to clean and polish chrome aluminum and brass. Tear off a small wad and rub surface to be cleaned, then polish with a dry cloth, leaving a protective film, 5 oz. can.  
VT No. 41-0119



**PJ1 Chain Lube** is a heavy duty chain lube for street or off road.  
VT No. 41-0132  
6 oz.  
41-0133  
17 oz.



**Super Cleaner by PJ1 Points and Spark Plug Cleaner** removes grease and dust, while displacing moisture. 13 oz. size.  
VT No. 41-0128



**PJ1 Cable Lube** cleans and lubricates in one application, 11 oz. can.  
VT No. 41-0175

# Chemical



**All Paints and Chemicals Shipped Ground Only!**



41-0123



41-0125



41-0149



41-0124



41-0126



41-0144

**VHT Special Finishes** 11 oz. size, each.

VT No.	VHT Finish
41-0123	Black wrinkle
41-0125	Flame proof 1350 flat
41-0149	Heat Silver finish
41-0124	Black oxide paint
41-0126	Black epoxy
41-0144	Black barrel paint satin restores factory look to cast iron cylinders



**Simi Chrome** is the original German formula. Available in case of 24 tubes in a display box.  
VT No. 41-0117



**Air Filter Oils and Cleaners.**  
K&N type is for paper elements. Unifilter type for foam elements.  
VT No. Size Item  
41-0171 12 oz. K&N Cleaner  
41-0172 6.5 oz. K&N Oil  
41-0173 16 oz. Unifilter Cleaner  
41-0174 5.5 oz. Unifilter

# Sealant



41-0151



41-0152

**Gasola Sealant** available in hard setting red varnish or soft set blue/white with teflon. Red Sealant is the original sealer for inside crank cases or cam covers for sealing pin holes on porous surfaces. Blue/White seals threaded joints on pipe threads and fittings. Both types are insoluble in oil, gas and solvents. The 1/4 pint can includes brush, each.

VT No.	Item
41-0151	Red Varnish
41-0152	Blue/White soft set



**GE Red RTV Hi-Temp Silicone** 2.8 oz. tube. VT No. 41-0182



41-8034



**Gasket Related Materials** by Permatex.

VT No.	Item/Size
41-8034	White Lithium Grease, 1.5 oz



**Gaseginch Gasket Sealer** in a 4 oz can sold each.

VT No. 41-0168

**Thread Lockers and Repair by Loctite.**

VT No.	Item/Size
41-1202	Tank Repair Flexible Ribbon Seals, .25 oz.



**Handlebar Grip Adhesive** fastens grips to bars.

VT No. 41-0190



41-0110



41-0112



41-0113

**Kreem Sealer and Kits.** Pint can of tank sealer, producing tank within a tank, stopping leaks and corrosion. Prep cleaner and conditioner sold as kit or as 3 piece combination kit.

VT No.	Item
41-0110	Kreem Sealer
41-0112	Prep
41-0113	Kit
41-0180	Tank Degreaser





# Motor Oil



**Motor Shop Oil.** All are sold in case of six in quart size bottles.

VT No.	Type	Weight
41-0991	Synthetic Gold	20w50w
41-0992	Heavy Duty	60w
41-0993	Synthetic Gear Lube	Transmission/Primary
41-0994	Synthetic Clean	20w50w
41-0995	Heavy Duty	20w50w
41-0996	Heavy Duty/Synthetic	50w

**Motor Shop Ready Transmission/Primary Formulated Lube** is a synthetic blend lube to provide excellent lubricity for the anti-wear requires of transmission gears and primary components. Adds protection between moving parts and out performs conventional oils. Use in all Big Twin transmissions and primary chain case 1984-up Sportster transmission and primary case 1971-up.

VT No. 41-0993



**Oil Change Service Kits.**

VT No.	Fits
41-0050	1984-88 FXST, 1980-98 FLT, 1982-94 FXR, 1984-up XL
41-0051	1991-98 Dynaglide
41-0052	1999-up All TC-88 Big Twins

**Complete Oil Change Kits**

41-0053	1984-98 FXST, FLT
41-0054	1999-06 FXST, FLST, FLT, FXD
41-0055	2007-up FXST, FLST, FLT, FXD



**Spectro Oils.** Special Blend in Premium or Golden synthetic blends, sold in quarts by case which is 12 or as each.



VT No.	Type	Blend	U/M
41-0108	70 wt	Premium	12
41-0114	60 wt	Premium	12
41-0115	50 wt	Premium	12
41-0109	20-50 wt	Premium	12
41-0155	20-50 wt	Synthetic Blend	12
41-0189	20-50 wt	Full Synthetic	12
41-0156	Primary	Big Twin for Wet Clutch 1984-up 5-Speed,	12
41-0160	Synthetic Trans Transmission	75W-140 GL-1 5 Speed Big Twin	1
41-0186	85W140	Premium Transmission Lube	12
41-0193	75W140	Platinum 6-Speed Transmission Lube	12
41-0195	75W140 GL-1	Sportster Trans/Primary Lube Platinum STL	1
41-0157	20 wt Fork Oil	Type E	12
41-0158	40 wt Fork Oil	Heavy	12
41-0194	DOT 5	Golden	12



**Synthetic Transmission Lube** OE type, including semi-synthetic transmissions lube for 4 and 5-Speed Big Twin FL-FXR-FXST models. Each. OEM # 99892-84.

VT No. 41-0162



**16 oz. Fork Oil.**  
VT No. Weight  
41-0148 10W  
41-0136 20W  
41-0116 30W



**Linkert Carb Black Paint.** VT No. 41-0144



**Brake Fluid** in DOT 4 for disc or drum, or DOT 5 for special requirements. Sold each.

VT No.	Size	Type
41-0142	12 oz.	DOT 4
41-0194	12 oz.	DOT 5



**Gear Oil SAE 90 Heavy Duty Gear Lube.** Non-foaming oil specially formulated for transmissions. Sold each.

VT No. 41-0130

# Tools



**Jims Engine Dipstick Socket** for FLT or FXD models. Allows easy removal of to hot exhaust pipe. Features 3/8" ratchet drive hole, 7/8" hex for wrench fitment and a cutout for clearance around exhaust piper. Use on all 2007-up FLT models and 2006-up FXD models.

VT No. 16-2759

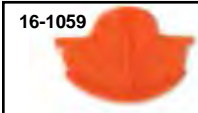

**Oil Fill Primary Funnel** allows the oil to be added to the primary cover with no mess or spills. This funnel snaps into the bottom of the derby cover hole. Use on 1970-84 FL, 1971-84 FX, 1991-up FXD, 1984-up FXST, 1986-up FLST, 1979-up FLT.

VT No. 16-1059



**Oil Catcher Pan** is used when removing oil filter to avoid spilling oil onto engine cases. 12" tube directs oil flow into oil drain pan.

VT No.	Fits
16-0094	2009-up FXD, 2004-up XL, 2009-16 FLT
16-0256	2017-up FLT



**Slim Design Oil Filter Wrench** features a slim 14 flute design to fit most filters, and 3/8 ratchet drive hole and slim design that allows more clearance for oil filter removal especially oil coolers and crank position sensors.

VT No. 16-1941



**Works Best!**

**Black Oxide Oil Filter Wrench** fits all spin on filters. 3/8" drive. Fits all models and TC-88.

VT No. 16-0743



**Oil Drain Spigot** fits 2009-up FLT.

VT No. 16-0096



**Oil Filter Wrench Pliers** fits all 60-90mm diameter filter. Features rubber coated handles and serrated jaws for better gripping. Removes stuck on oil filters easily.

VT No. 16-1125



**Oil Drain Reservoir.** 2.5 gallon. Low profile fits under frames on Softail and FLT models.

VT No. 16-0585

# Motor and Transmission Work Stand

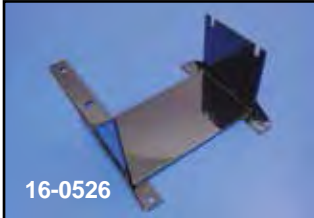
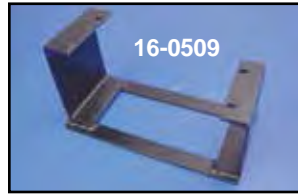

### Motor Stands

VT No.	Type
16-0507	1952-03 XL
16-0509	Big Twin Engine, Heavy
16-0501	Big Twin Engine, Standard
16-0526	TC-88 Engine
16-1285	45 Side Valve

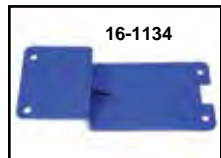

### Jims Rolling Buddy Engine Dummy Plate

VT No.	Fits
16-1134	1984-98 FLT, FXD, FXR
16-1135	1999-2006 FLT, 1999-2005 FXD
16-1136	2006-up FXD, 2007-up FLT



**Transmission Stands** are welded steel for shop use.

VT No.	Type
16-0506	4 Speed Trans, Vise Mount
16-0504	5-Speed Rubber Mount



### TC Beta Engine Stand

- Powder coated steel.
  - Clears the rear balancer housing of the Beta style TC case.
- VT No. 16-1273**



**Mini-Lift** use with table lift to raise bike while on table with 3" to 12" range 600lbs.

VT No.	Item
16-0211	Mini Lift
16-1907	Extender
16-0529	Mini Lift V-Twin Logo



**Roller Dolly** facilitates mounting your motorcycle on the kickstand for placement in your garage. Motorcycle dolly lift holds up to 1250 lbs.

**VT No. 16-1026**



**Note: Motor installed.**



**Motor Stand** with motor base fits 1936-99 Big Twin and 1999-up TC-88 solid mount engines. Will mount to most universal engine dollies which are available at most automotive outlets. Auto engine stand not included.

**VT No. 16-0543**



**Roller Dolly** with nylon wheel and has a capacity of 1250 lbs  
**VT No. 16-1999**

## Wheel Chock



**Pingel® Wheel Chock** features quick mounting and removal by sliding in and out of slotted mount pads. Chock is a chrome steel tube. Mounting kit also available separately. The appearance of the Wheel Chock including the cross brace is a trademark of Pingel Enterprises. The brackets used in the Wheel Chock are patented.

VT No.	Item
16-1501	Chock with mounts, 16", 18" or 19" wheels
16-1503	Chock with mounts, 21" wheel
16-1502	Mount Kit





# Lift



Mini-Lift use with table lift to raise bike while on table with 3" to 12" range 600lbs.

16-0211 in use

VT No.	Item
16-0211	Mini Lift
16-1907	Extender
16-0529	Mini Lift



Roller Dolly with nylon wheel and has a capacity of 1250 lbs  
VT No. 16-1999



Tie Downs are 1" x 5'6" in length, 1600 lb strength, 2 per set. Tie downs assist in pair of 12" black nylon straps which acts as cinch around part of the cycle first, then hook tie down to the other end of the loop, to prevent scratching.

VT No.	Item	Brand
48-0180	Tie Downs	V-Twin
48-0650	Tie Down Assist	Wright



16-2008



16-1993

# V-Lift

16"

Standard V-Lifts include a jack which features a foot operated pump and release mechanism. Both units include a stay bar to keep lift in full up position when in use. Units are 4 1/2" in their unextended height. Lift top is compatible with 1936-99 Big Twin frames FXST-FLT-FLST-FLH. The FXR, Sportster and Dyna models require adapters as noted.

VT No.	Height	Jack	Jack Replacement.
16-1993	16"	4 ton	16-2007 6 Ton
16-2008	24"	6 ton	16-2006 4 Ton



All C-G lifts are manufactured in the USA using structural steels that exceed the lifting requirements. The lift mechanism keeps the motorcycle in a vertical position relative to the lifting platform during the entire lifting range. For the safe operation of the lifts, the manufacturer recommends the use of tie downs on all models equipped with eyebolts and installation of hairpin cotter as supplied in safety bar when lift is in use.



VT No.	Item
16-1984	13" Front Extension



# Flywheel Tool



**Original Style Factory Type Crank Truing Machine** features cast iron construction. Designed to true stock style flywheels. 10" swing right side, 6" swing left side, 18" maximum center to center. Weighs over 80 pounds. Shipped truck only.  
**VT No. 16-0586**



**Flywheel Truing Hammer** is a three pound zinc aluminum that lasts longer than a lead hammer and is still soft enough so that it will not mar flywheels.  
**VT No. 16-1020**



**Crank Assembly Removal Tool** is used to press flywheels from cases, press cases apart and break sealant bond, for 1955-up Big Twin, by Jims.  
**VT No. 16-1839**



**Sprocket Shaft/Flywheel Holder** used to hold flywheel assembly in vise with or without left case attached. Can also be used to check case clearance on stroker flywheels. Use on all TC-88, 2006-up FXD's, 2007-up FL's and FXST's.  
**VT No. 16-0326**

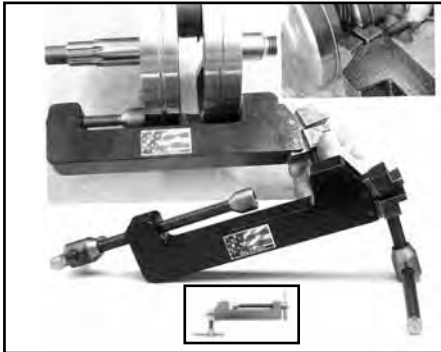

**Flywheel Truing Tool** to fine tune flywheel assemblies when truing. This tool features both a flywheel expander, and contractor in one easy to use package. Use on all tapered shaft flywheel assemblies.  
**VT No. 16-0325**



**Flywheel Nut Sockets** feature a low profile of 1" tall to give 100% nut contact, machined flat at nut ending end to eliminate rounding off the nut, by Jims.



**Jims Flywheel Runout Inspection Gauge** allows engine builder to check flywheel runout of the pinion shaft while assembled in engine

case. Also allows the checking of gear lash on gear driven cams on Twin Cam engines. Gauge fits 1970-84 FL, 1971-84 FX, 1984-up FXST, 1986-up FLST, 1991-up FXD, 1979-up FLT, 1982-94 FXR.

**VT No. 16-0383**



**1930-54 Big Twin Flywheel End Play Gauge.**  
**VT No. 16-0131**

**VT No. Nut OEM Fits Drive**

VT No.	Nut OEM	Fits	Drive
<b>16-1809</b>	23966-54A	1954-81 Big Twin	1/2"
<b>16-1810</b>	23969-83	1983-up Big Twin	1/2"
<b>16-1813</b>	23901-81	1981-up XL	1/2"
<b>16-0887</b>	23901-81	1981-up XL	3/4"

Pinion	Nut OEM	Fits	Drive
<b>16-1811</b>	24017-80	1981-89 Big Twin	1/2"
<b>16-0886</b>	24017-80	1981-89 Big Twin	3/4"

Sprocket	Nut OEM	Fits	Drive
<b>16-1812</b>	24017-80	1972-up Big Twin	3/4"



**Jims Twin Cam Flywheel Locking and Decommissioned Tool** locks the flywheel in place making service procedures easier. This tool is very visible

and useful to designate a bike as decommissioned. The bike will not start and clutch must be engaged in order to move bike when this tool is installed. Use on all Twin Cams 1999-up.  
**VT No. 16-2753**



**Jims Top Center Oversize Case Bolt and Spot Facer Tool.** Required when any Twin Cam case spigot hole is enlarged for Big Bore Cylinders Tool is need to spot face the right case so that bolt head will seat flat on the case surface.

VT No.	Item
<b>16-0380</b>	Oversize Case Bolt
<b>16-0381</b>	Spot Face Tool



**Flywheel Spreader Tool** spreads wheels while truing for Big Twins and XL's.  
**VT No. 16-0517**



**Jims Case Splitter.** Use this tool to break the case sealant by pushing apart both case halves. Use on 2006-up Dynaglide and 2007-up FXST-FLT models.  
**VT No. 16-1354**

# Rod Tool



**Rod Clamping Tool** allows rod to be held for straightening or to replace wrist pin bushing. 95952-33.  
**VT No. Item**  
**16-0029** Early Tool  
**37-1045** Thumb Screw Only



**Jims TC-88 Connecting Rod Bushing Tool** use to remove and replace wrist pin bushing without removing connecting rods from crankcase.  
**VT No. 16-1051**



**Jims TC-88 Wrist Pin Remover** allows easy removal of wrist pins on all TC-88.  
**VT No. 16-1276**



**Jims Timken Bearing Race Installer** is used to press race in straight in left crank case for 1969-up Big Twin, 1977-up XL's.  
**VT No. 16-0668**



**Jims Rod Race Press Tool** for easy installation or extraction of rod races makes it easy to support without bending rods for 74's and Sportsters.  
**VT No. 16-1838**

# For TC-88 B



**16-1375**

**Twin Cam Timken® Case Bearing Conversion Tool** is a must for the big cubic inch late model Twin Cam 88" or 96" engine. Utilizing the special Jims precision insert, it is designed to easily and accurately convert the left side crank roller bearing (OEM# 24604-00D) to the more durable Timken Bearing (OEM# 9028). This insert is manufactured from aerospace quality steel that is several times stronger than the aluminum case material the standard bearing rides in. The tool includes:

- A new steel bearing insert held under .002" TIR (total indicator reading).
- A press plate that will hold the bearing insert in line with the case bearing bore at the time it is being pressed into case.
- All the necessary drill bits to drill oil feed and return holes, hardware and detailed instructions.

*This job can be performed with normal hand tools, a hand drill and a 2 ton press.*

Use on Twin Cam engines 2003 to the present. Must also use existing Jims Tool (16-0668) for race installation. Order bearing inserts and Timken bearings separately.



**16-1379**

VT No.	Item
<b>16-1375</b>	Tool
<b>16-1379</b>	Bearing Insert
<b>60-0181</b>	Motor Shop Service to Machining Crankcase for above Insert requires work order number contact service dept





# Piston Pin Tool



**Rod Clamping Tool** allows rod to be held for straightening or to replace wrist pin bushing. **Bushing Piston Pin Tool** will remove and install bronze bushing.

VT No.	OEM	Tool	Brand
16-0029	95952-33	Clamping Tool	V-Twin
16-0539	Set	Clamp & Bushing	
16-0152	95970-32	Bushing Tool	Jims
16-0154	95970-32	Bushing Tool	V-Twin
16-0181	—	Bushing Tool	V-Twin

**Wrist Pin Bushing Reamer.**  
**VT No.**     **Fits**  
**16-0725**   1936-99 Big Twin  
**16-0216**   1936-99 Big Twin  
**16-0726**   1957-up XL  
**16-0727**   TC-88

**Piston Pin Lock Ring Installer Tools.**  
**VT No.**   **OEM**     **Type**   **Years**   **Model**  
**16-0142** 96780-32A Split   1932-51   All Models  
**16-1757** 96780-58A Spiral   1952-73   All Models  
Installs Ring, 22582-52, in piston with wrist pin of .515 I.D.  
**16-1831** 96781-72 Spiral   1973-77   All Models  
Installs Ring 22582-52 in piston with wrist pin of .535 I.D.  
**16-0987** 34623A Ring   1984-up   Evolution All



**Wire Type Wrist Pin Circlip Tool** easily installs and removes wrist pin clips without damage on 1984-up.  
**VT No. 16-0075**



**Jim Piston Ring End Gap Tool** makes measuring ring end gap faster, more accurate and eliminates guess work. The flanged design that allows the piston ring to fit squarely in the cylinder bore every time. This is the first tool that is designed to test oil ring gaps by propriety cutout feature. Just install any ring, top, 2nd, or oil control rails on the tool. Install tool into a cylinder bore and then view the ring end gap in the "Key Slot". Use a feeler gauge to get your end gap measurement. Each side of the tool is made for checking standard size piston rings. Fits Twin Cam standard size pistons for 95", 103" or 110" with 3.875" or 4.00" bore.  
**VT No. 16-3200**



**Piston Pin Align Tool** fits through wrist pin bushings.  
**VT No.**     **Type**  
**16-1747**     Early  
**16-1148**     TC-88



**Wrist Pin Bushing Rod Clamp Tool Set.**  
Fits 1936-73.  
**VT No. 16-0776**

# Oil Pump



**Sifton Oil Pump Check Ball Reseater** will recut the seat to allow the ball to sit properly to prevent sumping for Big Twin and XL aluminum and cast iron pumps.  
**VT No. 16-0519**



**Oil Pump Snap Ring Installer** makes it easy to install outer snap ring on oil pump shaft, without stretching the ring. Just apply oil to ring expander, holder up to the big end of ring expander, hold up to the end of the shaft, then push ring onto the shaft with sleeve. Use on Big Twin oil pumps.  
**VT No. 16-0889**



**Tappet Oil Screen Plug Tool.** Wide slot type to remove stock slotted plug without removing exhaust pipes.  
**VT No.**     **Brand**  
**16-0875**     V-Twin  
**16-0665**     Jims

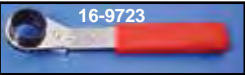

**Oil Pressure Sending Unit Wrenches.** These reversible ratcheting wrenches are used to install and remove oil pressure indicator lamp or gauge sending unit on all FL Touring models 1999-up.

VT No.	Year
16-9723	1999-up
16-9724	1984-98



**Oil Pump Seal Installer** easily installs oil pump seal perfectly below gear surface for no leak fit.  
**VT No. 16-0890**



**Oil Pump Drill Fixture** allows drilling of cases to accept late model stock or S&S oil pumps.  
**VT No. 16-0986**



**Oil Pump Drill Jig** replaces 94461-81 for installation of factory type updated pump VT No. 12-9900 on 1973-78 crank cases.  
**VT No. 16-1843**



**Ball Burnish Tool** will facilitate ball burnishing of the relief valve seat on cast iron pumps.  
**VT No. 16-1033**



**Main Bearing End Plug Tool** allows the setting of proper end play in Big Twin Timken Bearing Assemblies by selection of proper spacer from the catalog. Use when refitting bearings or bearing sets on late models when spacers are not included. Not needed for our VT No. 12-0309 or 12-0310 Timken sets, these are pre-spaced from the factory.

**VT No.**      **Fits**  
**16-1795**      Big Twin  
**16-1796**      1977-up XL



**Sprocket Shaft Bearing Adapter & Seal Installation Tool** upgrades Jims bearing installer tool (VT No. 16-1353) for work on fine-spined Twin Cam sprocket shafts. Allows for installation of Timken bearing (OEM# 8028) & roller bearing race assembly (OEM#24004-03) onto the

sprocket shaft. For Dynaglide; all 2007 Big Twin.

**VT No. 16-1364**



**Jims Crankshaft Bushing Remover/Installer** will facilitate removal and installation of bushing in cam support plate on TC-88 model engines.

**VT No. 16-0791**



**1990-up Big Twin Snap Ring Remover** will remove the Timken Bearing outer race snap ring without damage to the case.

**VT No.**  
**16-0705**



**Balancer Shaft Bearing Service Tool** use to remove and install bearing fits 2000-up Twin Cam Engines.

**VT No. 16-1915**



**Timken Bearing Removers** remove bearing from shaft without removing shaft from flywheels.

**VT No.**      **Fits**  
**16-0667**      1957-76 XL  
**16-1833**      1977-up XL  
**16-1834**      1955-85 Big Twin  
**16-0704**      1986-up Big Twin



**Sprocket Shaft Seal Installer** use this kit to install sprocket shaft seal to proper depth, and for holding the seal perfectly square, for a no leak fit. Driver sold separately, order 16-0664.

**VT No.**      **Use**  
**16-0661**      1995-up Sportster and Buell®  
**16-0664**      Driver Set



**Timken Bearing Simulator** allows quick and easy removal and replacement of flywheel assembly in the left crankcase when checking clearances before the final assembly. Constructed of Delrin plastic.

**VT No. 16-0706**



**Sprocket Shaft Holder** will hold the flywheel in vise, without left case attached. Use on Big Twin 1955-up. By Jims.

**VT No. 16-0683**



**Crank Pin Nut Clearance Gauge** fits 1937-57.

**VT No. 16-1855**

# Crankshaft Installer



**Sprocket Shaft Bearing Removal and Installation Tool.** Removes and installs engine sprocket shaft bearings from crankcase. Use with 33416 driver handle. Replaces 94547-80. 2 part set, 4 halves.

**VT No.**      **Item**  
**16-0058**      2 Part Set  
**16-0065**      Driver



**Bearing Race Press Plug** is used to remove and install Timken bearing outer race.

**VT No.**      **Fits**  
**16-0138**      1955-up Big Twin, (97194-57)  
**16-0045**      1957-76 XL  
**16-0046**      1977-up XL



**16-0140**



**16-1836**

**Sprocket Shaft Timken Bearing Installer Tool.**

VT No.	Jims	OEM	Year/Model
<b>16-0140</b>	—	97225-55	1955-up Big Twin
—	<b>16-1836</b>	As Above	Jims
—	<b>16-1837</b>	97081-54	Jims, 1954-76 XL
—	<b>16-1760*</b>	2.500 Long	1977-up XL
—	<b>16-1761*</b>	2.060 Long	1977-up XL

\*Note: Sold separately for 1977-up use with 16-0140 and 16-1837.





# Lapping Tool



**Lapping Tools** used for precision alignment of engine and transmission shafts. Engine unit replaces 96710-40 to lap right and left crankcase races for oversized bearings. Transmission tool insures proper fitting of oversized rollers with mainshaft races on Big Twin and Sportsters. The dual-purpose "Combo Lap" for both engine and transmission is also available. Rod laps not included.

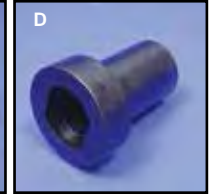
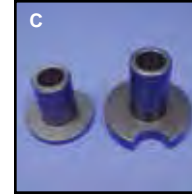

**Pinion Gear Puller** with collars, used to remove and install pinion gear on all Big Twins, and 1976 and earlier XL. Order nut wrench separately.

VT No.	Brand	#	Item
16-0129	VT	A	Puller Kit
16-0162	Jims	B	Puller Kit
16-1060	Sifton	B	Puller Kit
16-0406	VT	C	Collar Set
16-0141	VT	D	Nut Wrench
16-0168	Jims	D	Nut Wrench
16-0747	Motorshop		Puller Wrench Set

VT No.	#	Use	Model	Years
16-0135	C	Engine	Big Twin	1936-up
16-0119	B	Trans.	Big Twin	1936-77
			XL	1952-83
16-0039	A	Combo	C and B	As Above
16-0012		All	Spanner Wrench	
16-0204			Pilot Set	



**1958-up Big Twin Case Lap Tool** features a lap which is supported on both sides by a pilot on the bushing side and plate which locates on the case pins of the cam cover, by Jims. Order lap and pilot VT No. 16-0881 for 1937-early 77 4-speed main race separately.

VT No.	Item
16-1835	Big Twin Case Lap Tool
16-0893	Case Lap Head only
16-0892	4-Speed Lap Head only

# Pinion Tool



**Replacement Lapheads** are sold each. For Eastern tool only.

Laphead	Pilot#	Type	Fits
16-0032	1.750"	Engine	1958-up Big Twin
16-0026	1.50"	Engine	1940-54 Big Twin
16-0025	1.375"	Engine	1954-76 Sportster 1955-57 Big Twin 1929-73 45"
16-0018	1.562"	Engine	1987-up Sportster
16-0034	1.870"	Transmission	1936-77 Big Twin
16-0024	1.300"	Transmission	Sportster
16-0022	1.6250"	Rod	Big Twin XL
16-0021	1.50"	Rod	45"

**Rod Lapping Tool** includes arbor assembly 1.500 lap for 45", Indian and some case races, 1.625 lap for Big Twin, Sportster and K Model rods.

VT No.	Item
16-0027	Rod Tool
16-0012	Spanner Wrench

**Lap Head Pilots**, sold each. For Eastern tool only.

VT No.	OEM	Type	Years
16-1724	96727-56	Motor	1955-up Big Twin
16-1725	96728-56	Motor	1954-76 XL
16-1726	96715-40	1 1/2 Motor	1930-54 Big Twin
16-1727	96716-40	Motor	1955-57 45", Big Twin
16-1832		Motor	1987-up XL
16-0216		Pilot Shaft Only	
16-0219		Sunnen Portable Head Hone	

**Transmission Lap Head** includes pilot. For Eastern tool only.

VT No.	Size	Model
16-0020	1.870	Big Twin 74 and 80
16-0019	1.300	1957-85 Sportster



16-1672

**Crankshaft Locking Tool** locks all crankshafts by engaging the pinion shaft splines. This allows removal and torquing of the pinion nut during installation. Fits 1999-up. VT No. 16-1672



**Big Twin Pinion Bearing Race Removal and Installation Tool** is used to remove and install the outer race on 1958 and later models replaces 39958. VT No. 16-0648



**1991-99 Crankshaft Locking Tool** fits XL models by engaging the pinion shaft splines. This allows removal and torquing of the pinion nut during installation. Replaces 41506. VT No. 16-1055



**Jims TC-88 Crankshaft Guide** use to spread pinion bearing rollers while reassembling right side engine case on to flywheel assembly. VT No. 16-1281



**Jims Sportster Crankshaft Locking Tool.** Use on Pinion side of all 1991-up XL to keep crankshaft assembly from rotating during assembly on valve train repair. VT No. Fits 16-1666 1991-2002 16-1665 2003-up



**Pinion Shaft Race Installer** fits 1977-E81 Sportster models. Replaces 97080-77A. VT No. 16-0965



**Pinion Gear Lock Tool** fits 1954-up Big Twin, when applying torque to pinion nut. By Jims. VT No. 16-0659

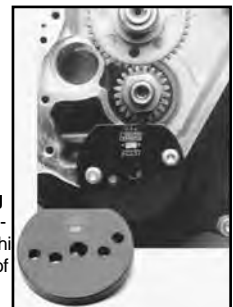



# Sprocket Shaft Tool



16-0153



**1955-up Sprocket Shaft Hard Cap** protects shaft when using press. By Jims.  
VT No. 16-0666



16-0150



16-1850



16-0888



16-1754



**Crankshaft Stabilizer Bracket** acts as third hand. Sliding over crank splines, and bolting to a primary mount hole prevents crank from turning while installing pistons, cylinders or rings.  
VT No 16-5051



**Twin Cam 24 Tooth Crankshaft Rotating Wrench** for use on all 2006-up Big

Twins with 24T spline sprocket shaft to check engine timing and parts clearance.

VT No. 16-9280



16-1378



16-1852

**Sprocket Shaft Seal and Lock Installers** for Big Twins.

VT No.	OEM	Years	Application
16-0153	97235-55B	1955-69	Installs Nut and Seal
16-0888	97235-55B	1955-69	As Above, Jims
16-1754*	39361-69	1970-up	Installs seal only, Jims

\*Note: Use with 16-0140 or 16-1836 to install seal.



**Jims Twin Cam Case Support Block for Balancer.** Engine 2000-up. These blocks properly support the case on a level plane when using a press for work.  
VT No. 16-1916



16-0883



16-0130

**Compensating Sprocket Wrench** to install or remove compensating sprockets. Replaces 94557-55 for 1955-69.

VT No.	Item
16-0130	Flat Type
16-0883	1/2" Drive Type, Jims



16-1378

**Shaft Turning Tool** fits spline or taper on assembled motor and allows engine to be turned over by 1/2" ratchet or impact driver. Sifton unless noted.

VT No.	Years	Type
16-0150	1930-54	Big Twin, Taper
16-1850	1955-05	Big Twin, Spline
16-1378*	2006-up	FXD, 2007-up FL, FXST
16-1852	1957-up	XL, Spline

\*Note: Jims



**Jims Balancer Shaft Inner Bearing Remover and Installer Tool** for all 2000-up Twin Cams. This tool will accurately remove and install the inner balancer bearing mounted in the left case.  
VT No. 16-1915

# Balance Tool



**Balancer Shaft Removal Tool** designed to remove both front and rear counter-balancer shaft bearing assembly, from the left engine case on the new 96" and 110" Beta engines.  
VT No. 16-1374



**Balancer Shaft Inner and Outer Bearing Remover and Installer** for TC-88B models 2000-up includes thrust bearing. Replaces 44066.  
VT No. 16-0540



**Outer Balancer Bearing Installer and Remover Tool** removes and installs the outboard balancer bearing on the new 96" and 110" "B" Softail engines chain guide support plate.  
VT No. 16-1376



**Jims TC-88 Balancer Shaft Alignment Tool** use for correct balancer drive assembly. Use on all 2000-up TC-88B models.  
VT No. 16-1166



**Balancing Shaft and Bearing Installer Tool** designed to align and safely install a new balancer bearing and counter balancer shaft into the new Twin Cam 96" or 110" "B" Softail engine case. For removal of balancer shaft from the engine case use Jims tool No. 960.  
VT No. 16-1377



**Balancer Shaft Retention Pin** use this tool to secure the engine balancers on TC-88B engines when servicing flywheel assembly. This tool locks into the balancers sprocket pin holes to prevent the balancer from turning out of sync with flywheel.  
VT No. 16-1163

# Alternator Repair



**Moto Shop Alternator Sealing Ring Replacement Service.** Ship in 1970-up left hand case with damaged O-Ring lip and we will machine out and replace with new steel sealing ring.  
VT No. 60-0164

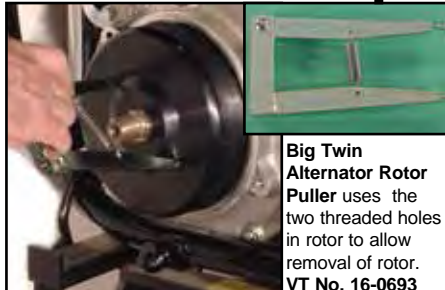

**Big Twin Alternator Rotor Puller** uses the two threaded holes in rotor to allow removal of rotor.  
VT No. 16-0693



**Big Twin Alternator Rotor Puller** uses the sprocket shaft end to center and the two threaded holes in rotor to allow removal of rotor.  
VT No. 16-1054



**Alternator Repair Ring Only.**  
VT No. 16-0692

**Left Side Case Repair Ring** for TC-88 engines at inner primary.  
VT No. 16-0562





# Cam Tool



**Jims Cam Bearing Installer Tool** presses the inner cam bearings smoothly into the right case with the bearings installed to the proper depth. **VT No. 16-0660**

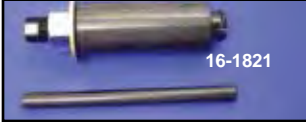

**Cam Bearing Puller Tool** removes inner cam bearing (Torrington type) without splitting cases while preventing rollers from coming out during removal. Not for Twin Cams.

VT No.	Fits
16-1821	1958-99 Big Twins
16-1840	1957-up XL



**Cam Shaft Needle Bearings and Bushing Tool.** Rods install needle bearings without damage. Bushing tool positions pinion bushing in cam cover on all 1970-up Big Twin to correct depth.

VT No.	OEM	Model	Brand
16-0126	97272-60	Big Twin Needle	Sifton
16-1841	97272-60	Big Twin Needle	Jims
16-0127	97273-60	XL Needle	Sifton
16-1857	97273-60	XL Needle	Jims
16-0711	—	Big Twin Bushing	Sifton



**Tune-A-Cam Kit** includes easy to read degree wheel dial indicator, T.D.C. locator, lightweight checking springs and packed in a plastic case. Also checks cam or crank end play, shaft and gear run out.

**VT No. 16-0970**



**Jims Cam Locking Tool** allows removal and torquing of cam sprocket bolts by locking camshaft and crankshaft sprockets. Use on 2006-up Dynaglide and 2007-up FXST-FLT models. **VT No. 16-1352**



**Inner Cam Bearing Remover Tool** allows removal of needle bearing and will also keep needles from falling into engine.

VT No.	Year
16-1821	1958-99 Big Twin (Jims)
16-1271	1958-99 Big Twin (Sifton)
16-1840	1957-up XL (Jims)
16-1351	2007-up Big Twin



**16-1271**



**16-0684**

**Cam Bearing Gauge** is a Go-No-Go gauge to check if the cam is too tight or too loose in the 9058 Torrington Bearing on 1958-up Big Twins. Set of 2.

**VT No. 16-0684**



**Cam Gear Check Pins** measure precise fit for selection. Sold in pairs.

VT No.	Size
16-1749	.105
16-1750	.108



**Crane Cams Installation Tool** comes with easy instructions for the mechanic to install Crane's adjustable pushrods without removing the gas tank or rocker covers. In all FL-FX with adjustable pushrods, the tool makes it easy for cam changes. No removal of pushrods, pushrod covers, tappets or tappet guides. Tappets never have to fall out of the guides while doing cam changes.

**VT No. 16-0030**



**Jims Cam Gear Remover and Alignment Tools.** The alignment tool is designed to index the cam gears position while removing or installing the cam gear. This tool will allow you to accurately

**16-1282**

position and or reposition the cam gear from one camshaft to another, as well as allowing you to retard or advance the gear position by up to 10 degrees with the accuracy of a ¼ degree. The cam gear remover tool is use to remove the cam gear from the camshaft. This tool acts as stable base to keep the camshaft perpendicular to the press.

VT No.	Item
16-1282	Alignment Tool
16-1283	Remover Tool



**Jims Big Twin Breather Chamber Reaming Tool** will size the hole to .030 so the oversize breather can be used for 1936-up models.

**VT No. 16-0695**

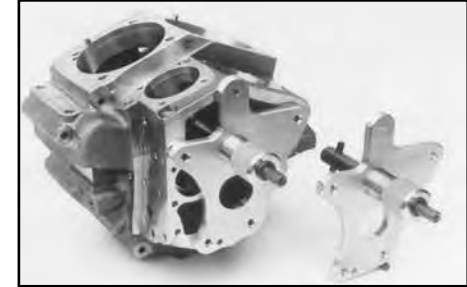

**Cam Clearance Cutter** bolts to 1970-up Big Twin cases and features an adjustable cutter and threaded depth feed. Power by ½" drill or use in milling machine.

**VT No. 16-0879**



**S&S Degree Wheel Kit** designed to fit the sprocket shaft of any Big Twin or XL model. Each kit also comes with pointer that is held in place by center crankcase bolt.

**VT No. 16-0909**



# Cam Shaft



**16-0790**  
**Jims Camshaft/Crankshaft Locking Tool** will lock the gear teeth on the TC 88 model engine. Instructions included.  
**VT No. 16-0790**



**Jims Cam Chain Tensioner Unloader** will hold the tension of the primary cam chain on the TC-88 model engine. Instruction included.  
**VT No. 16-0793**



**16-0792**  
**Jims Camshaft Remover and Installer Tool** allows removal and installation of cams in the TC-88 model engine. Tool is used in conjunction with VT No. 16-0793 cam chain tensioner unloader.  
**VT No. 16-0792**



**16-1275**  
**Jims TC-88 Camshaft Bearing Tool** designed to remove and replace the right crankcase bearing in and out with no damage to crankcase.  
**VT No. 16-1275**



**Jims Outer Balancer Bearing Installer and Remover Tool.** This tool removes and installs the outboard balancer bearing on 96" and 110" "B" Softail engines 2007-up.  
**VT No. 16-0324**



**16-1280**  
**Jims TC-88 Cam Bearing Puller** used to remove bearing from camshaft, this tool is designed to remove the bearing straight with no slipping or binding. Use on all TC-88.  
**VT No. 16-1280**



**16-1279**  
**Jims TC-88 Inner Cam Bearing Remover** replaces inner bearing easily without damage to crankcase and also prevents rollers from falling into crankcase. Use on TC-88.  
**VT No. 16-1279**



**16-1351**  
**Inner Cam Bearing Remover Tool** allows removal of needle bearing and will also keep needles from falling into engine.



**16-1271**

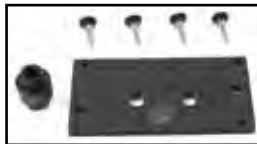

**Jims TC-88 Inner Cam Bearing Tool.** This tool will safely install the inner cam bearing in all 1999-up FXST-FLST and Dynaglide models. Installs bearings to the proper depth in case without damaging bearings.  
**VT No. 16-1384**



**Jims TC-88 Crankshaft Guide** use to spread pinion bearing rollers while reassembling right side engine case on to flywheel assembly.  
**VT No. 16-1281**

VT No	Year
16-1821	1958-99 Big Twin (Jims)
16-1271	1958-99 Big Twin (Sifton)
16-1840	1957-up XL (Jims)
16-1351	2007-up Big Twin

**Jims Cam Assembly Tool** for all 2006-up Dyna and 2007-up FXST, FLT models. Used to hold both cams in an upright position while lowering the cam support plate over cam journal.  
**VT No. 16-0323**

# Cam Bushing

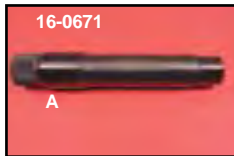
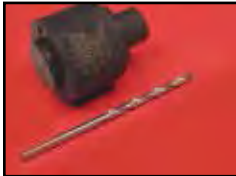

**16-0671**  
**1970-up Big Twin Cam Bearing and Bushing Alignment Tool** aligns to within .0003" of the center line. Any binding of this tool indicates misalignment of cam cover and or bushing. By Jims.  
**VT No. 16-0671 (A)**



**16-0669**  
**1936-69 Cam Cover Bushing Remover Tool** removes bushing in one operation. Fits Overhead Valve (OHV).  
**VT No. 16-0669 (B)**



**16-1822**  
**Pinion Bushing Puller** Tool is used to remove the pinion bushing from the cam cover on 1954-up Big Twins.  
**VT No. 16-1822**

VT No.	OEM	Year	Model
16-0982	94805-80A	1958-up	Big Twin
16-0981	94812-37A	1954-76	XL & 45"
16-0980	94812-80A	1977-85	Sportster
16-0979	94813-80A	1941-54	Big Twin
16-0978	94814-80A	1955-57	Big Twin
16-0962	94812-89	1986-up	Sportster
16-1791	—	1957-up	Sportster
		1-3-4	Cam Cover Bushing
16-1797	94802-70	1970-up	Big Twin Cam
16-1802	—	1936-69	BT Cam

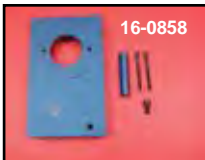

**16-0858**  
**Cam Cover Holding Tool** holds 1970-up Big Twin Covers while removing and installing bushings. Holds cover flat, to avoid scratches.  
**VT No. 16-0858**



**16-1823**  
**1991-up XL Crankshaft Bushing Plate Pilot and Reamer.** Reams in board camshaft and camshaft crankcase bushing, replaces 38871.  
**VT No. 16-1823**



**16-0839**  
**Sifton Cam Cover Puller** easily removes 74 and 80 cam cover on 1970-99 models.  
**VT No. 16-0839**

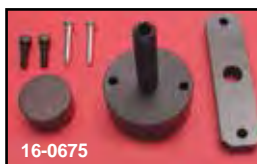

**16-0675**  
**Big Twin Cam Seal Installer Tool** can be used to remove or install seal and will also remove cover from case. Fits Big Twin, 1970-up.  
**VT No. 16-0675**

**Cam and Pinion Bushing Drill Jigs** allow the installation and drilling of a dowel pin to factory location supplied with #31 drill by Jims.

### Cam Bushing Drill Jigs

VT No.	Year	Models
16-1814	1936-69	Big Twin (Fits Overhead OHV)
16-1779	1970-99	Big Twin (Fits Overhead OHV)
16-1818	1954-up	XL

### Pinion Bushing Drill Jigs

VT No.	Fits
16-1820	1936-53 Big Twin
16-1780	1954-92 Big Twin
16-1817	1937-73 45"
16-1819	1937-48 74" and 80" Side Valve





# Lubrication



**Combination Oil Filter Wrench** includes drain plug hex at opposite end.  
VT No. 16-0451



**Swivel-Flex Oil Filter Wrenches** feature gripper teeth and a durable treated band with a vinyl covered flex handle which swivels to clear frame and exhaust obstructions. Replaces 96221-80. VT No. 16-0903



**E-Z Squeeze Bearing Packer.** Patented design greases all tapered bearings with a 5/8" or larger inner diameter Canister holds grease for clean operation.  
VT No. 16-0755



**Seal Puller Tool.** Simply insert the tip of the tool behind the oil or grease seal, press and pull leverage works for you. No more pounding, hammering and digging that might damage bearings. Two size tips reach in and fit nearly all seal applications.

VT No. 16-0838



**Wheel Bearing Greaser.** Fitting and spigot greases 1973-99 tapered bearings without removing seals, use existing seal spacer or purchase separately.

VT No. Item  
16-0803 Tool  
44-0303 Collar



**Grease Fittings.** Special thread.

VT No.	Year	Type	U/M
8770-6	1909-38	Nickel	6 pack
49-0595	1909-38	Nickel	10 pack
44-0533	1938-up	Zinc	10 pack
9864-6	1938-84	Cadmium	6 pack
9897-6	1938-84	Chrome	6 pack
44-0558	1938-up	Nickel	10 pack
37-0511	1938-up	67.5°, Zinc	5 pack
37-0521	1938-up	90°, Zinc	5 pack
49-0688	1936-37	90°	5 pack
49-0636	Cad	Straight	10 pack
49-0637	Cad	67.5°	10 pack
49-0687	Cad	Assortment	20 piece



44-0533



**Oil Drain Reservoir.** 2.5 gallon. Low profile fits under frames on Softail and FLT models.

VT No. 16-0585



**Oil Filter Wrench** use with 3/8" drive.  
VT No. 16-1941



16-0565



16-0566

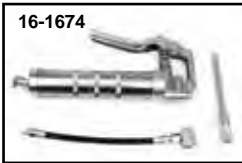

16-1674



16-0594

**Grease Kit and Metal Squirt Can.**

VT No. Item  
16-0565 Metal Squirt Oil Can  
16-0566 Squirt Oil Can with flexible nozzle  
16-1674 Grease Kit  
16-0594 500cc Can



**Flat Top Alemite Grease Fitting Adapter** is designed to be used on alemite grease fitting, 0340. Tapped 1/8" NPT to use with standard grease gun.

VT No. Brand/Item  
9929-1 Colony/Adapter  
9929-1T VT/Adapter



**Clone Speed Wrench** allows removal of head bolts on 1936-84 Overhead Valve models, after they are broken loose with wrench.

VT No. 16-0953



**Works Best!**

**Oil Filter Wrench** fits all spin on filters. 3/8" drive. Fits all models and TC-88.

VT No. 16-0743



**Clone Cycle! Original Design by Frank Andrus of New London, Ohio in the mid-1990's.**



**Cable Oiler** directs lubricant into the cable core.  
VT No. 16-0686

# Early Tools



16-1735

**Tappet Guide Puller** for 1930-73 45 Side Valve, 1930-40 Big Twin Side Valve. Note for use on all Flatheads with screw type valve covers. Replaces 11906-38.  
VT No. 16-1735



16-0840



16-0841



16-0842

**Side Valve Tool Kits** includes tool roll.

VT No. Fits  
16-0840 1929-73 45" & Solo  
16-0841 1930-40 SV-VL-ULH  
16-0842 1941-48 SV-VL-ULH



**Clutch Puller and Sprocket Nut Tool Kit** for Knucklehead and clutch Flathead models.  
VT No. 16-0571



16-0414



16-0805

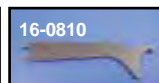

16-0810



16-0812

**Valve Cover Wrenches.**

VT No.	OEM	Type	Years	Model
16-0414	11806-31	Lower, Nut	1929-73	45
16-0805	11806-30	Upper, Nut	1930-38	74 and 80
16-0810	11806-30A	Lower, Hook	1930-38	74 and 80
16-0812	11959-39	Clip Type	1939-48	74 and 80



Adjust tappets so that there is .004" to .005" clearance between intake valve stems and tappets, and .007" to .008" clearance between exhaust valve stems and tappets.



16-0823



49-0366

**Big Twin Countershaft Sprocket Nut Tools** are factory style forged tools.

VT No. Models Use  
16-0823 1941-73 45  
49-0366 1936-40 Big Twin



**Clutch Puller** fits 1936-61 and 1937-40 Big Twins, except VL.  
VT No. 2556-1T



# Early Tools



16-0108



16-0141



**Eight Piece Factory Style Wrench Set** features exact replicas as the dealers used.

Fits:  
EL 1936-1952  
FL 1941-1984  
G 1941-1957  
W 1936-1952  
VT No. 16-1296

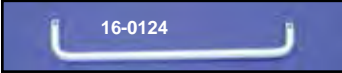

16-0124



16-0107



16-0804



16-0518



16-1019

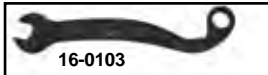

16-0103



**Left Rear Engine Mount Bolt Wrench** allows removal and installation of left rear motor mount bolt on Big Twins without removing the inner primary cover. VT No. 16-0518



16-1003

**Spring Fork Assembly Clamp** facilitates building of stock type forks by compressing upper and lower spring. Fits 1936-57.

VT No. 16-1003



**Fiberglass Saddlebag Rivets**, 50 pack.

VT No.	OEM	Length
37-0566	90965-63	5/16"
37-0567	90966-63	1/4"
37-0568	90967-64	3/8"



**Clutch and Brake Brass Rivets.**

VT No.	OEM	Type	Use
37-8805	—	Short 4-4 1/2	Brake
37-8806	41871-31	Long 4-5	Brake
37-8807*	8226	Short 7-4	Clutch

\*Note: For clutch hub friction disc.



16-1735

**Tappet Guide Puller Tool.**

11906-38. Fits 1930-73 45 Side Valve, 1930-40 Big Twin Side Valve. \*Note: Use on all Flatheads with screw type valve covers.

VT No. 16-1735\*



16-0615

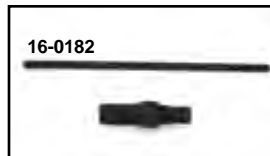

16-0182

**Gas Valve Shut Off Tool** replaces 96365-42 to correct alignment of bottom and top holes of 1940-65 gas tanks.

VT No.	Item
16-0615	OE Style
16-0182	Motor Shop



**Cone Nut Wrench** features pins to turn cog style cone nut 3/8" drive. Fits Big Twin.  
VT No. 16-0178



16-0638

**Generator Gear Puller Center Cap** use with claw type pullers. OEM# 95636-46.  
VT No. 16-0638



**Clutch Hub Wrench Kit** includes a factory style wrench and nut. Fits 1936-40 EL and UL.  
VT No. 16-1038

## Shop Wrenches.

VT No.	OEM	Use
16-0141	94555-55A	Big Twin Pinion Nut, 1954-up
16-0124	94590-73	3/8" Drive for Head Bolts
16-0107	94585-30	Cylinder Base, 5/8"
16-0875	—	Tappet Oil Screen, Plug
16-0108	94589-29A	Cylinder Base, Head Bolt fit 9/16" Nuts
16-0804	11929-29	Spark Plug and Tappet 1 5/32"
16-0103	94501-56	Circuit Breaker Big Twin 1 7/16" Hex
16-0067	12047-30	UL Head Bolt
16-0068	12047-36	OHV Head Bolt
16-1019	—	UL Head Bolt
16-0518	—	Rear Motor Mount

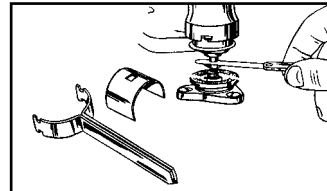

16-0812

Adjust tappets so that there is .004" to .005" clearance between intake valve stems and tappets, and .007" to .008" clearance between exhaust valve stems and tappets.

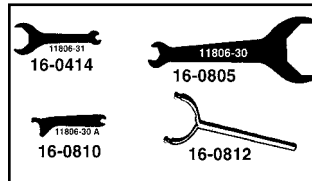

## Valve Cover Wrenches.

VT No.	OEM	Type	Years	Model
16-0414	11806-31	Lower, Nut	1929-73	45"
16-0805	11806-30	Upper, Nut	1930-38	74" and 80"
16-0810	11806-30A	Lower, Hook	1930-38	74" and 80"
16-0812	11959-39	Clip Type	1939-48	74" and 80"
16-0345	Set	U and L	1930-38	74" and 80"



**Rivet Set** will cap head of solid steel rivets for 3/8" round head size.

VT No. 16-0709



## Kit Tools Sold Separately.

VT No.	OEM	Use
16-0804	11929-39	45" Tappet and Spark Plug
16-0806	11904X	Tappet Wrench, pair
16-0816	12051-30	74" Axle Sleeve
16-0818	11814-35	45" Axle Sleeve
16-0817	11815-26	5/8" x 1 1/16" All Purpose
16-0808	11804X	9/16" x 1/2" All Purpose
16-0822	11814-26	45" Rear Axle
16-0814	94426-78	1 1/16" Rear Axle
16-0815	94427-78	1 5/16" Front Axle
16-0813	94428-78	3/4" Wrench
16-1286	—	Spark Plug
16-1345	—	Spark Plug Socket
49-0862	—	Socket, 18mm
16-1614	—	18mm
16-0371	—	18mm Spark Plug Wrench Set



16-1362

**Gasket Locator Tool (3 Piece Set)** will align primary, cam and transmission end cover gaskets, to prevent misalignment and oil leaks.

VT No. 16-1362



**Spring Fork Rocker Bushing Remover-Installer Tool** will replace stock steel bushings on 1930-57 Spring Forks.  
VT No. 7611-2





# Tool for EFI & Carburetor



**Slow Jet Screw Driver** facilitates removal of Keihin slow jets with no damage to jet.  
**VT No. 16-0546**



**Fuel Pressure Check GaugeTool** provides simple, fast, and accurate fuel pressure checks. Includes 100psi gauge, hose, and adapter. The adapter features stainless

steel springs and a push button that releases all fuel through the drain line. Fits all models with EFI.  
**VT No. 16-0591**



**Adjustable Main Jet Conversion Kit** fits all Bendix carburetors. Thumb screw adjustment makes tuning a five minute cinch.  
**VT No. Item**  
**35-0202** Jet Kit  
**16-0865** Jet Tap 3/32" x 32,  
Some early carbs require drilling and tapping for jet installation.



**Jims Fuel Pressure Test Gauge Tool** includes all the necessary hose connections and fittings to safely perform a fuel pressure test on all 2002-up FLT, 2004-up FXD and 2001-up FXST with fuel injection.  
**VT No. 16-0317**



16-0186



16-0316

**Fuel Pump Retainer Remover Tool.** Safely removes the retaining ring holding the fuel pump inside gas tank on all 2008-up FLT models. Use for quick and easy service of fuel filter and other fuel related parts.

**VT No. Item**  
**16-0316** Tool, Jims  
**16-0186** Wrench



**EFI Check Valve Rebuild Kit** for all EFI model Twin eliminates the need to replace the check valve and fuel line when only an o-ring is needed.  
**VT No. Item**  
**35-0446** Rebuild Kit  
**14-0586** Check Valve O-Rings only  
**16-0592** Installation Tool



## Hose



16-0050

**Hose Clamp and Tool.** Stock type clamp closing tool and clamps in bags in as sized (Inner Diameter (ID)).

VT No.	ID	Use/Fits
16-0053	1 1/16"	Feed Drain
16-0062	1 7/32"	Oil/Gas Hose
16-0061	7/16"	Oil Hose
16-0052	1 3/16"	Drain Hose
16-0064	4 5/64"	Oil Filter, 1979-up XL
16-0082	1 3/16"	Oil Hose, 1995-up XL
16-0063	1 9/32"	Brake Hose Reservoir 1982-up FLT-FXR-FXST



16-0000

37-8933	1/4"	Battery Vent Clamp
16-0081	1/2"	Cam Cover Fitting Oil Line Vent, 1993-up XL
16-0050		Tool, Pliers Only
16-0000		Oil and Gas Hose Pliers.



**Snimp Hose Cutter** is a hand held device which quickly cuts any size rubber or nylon hose up to 3/4" diameter. leaves hose perfectly clean and square.  
**VT No. 16-0049**



**Fuel Transfer Tool** for all 2001-up EFI Twins (except V-Rod). Attaches to the stock check valve and allows fuel transfer from one bike to another or to use for draining the fuel tank for seasonal storage. Transfer of fuel is at roughly one quart every 20 seconds. No modification required. **VT No. 16-0593**



**Oil Gas Line Clamp Assortment** includes pliers.

**VT No. Oetiker No.**  
**16-0080** Service Kit  
**16-0083** Pliers only



16-0083



**Fuel-Oil Line** are available in shop rolls in reinforced black or clear for fuel use.

Black	Clear	Size	Length
40-9999	—	1/8"	10'
40-0117	40-1250	3/16"	25'
40-0118	—	1/4"	25'
40-0119	40-1252	5/16"	25'
40-0120	—	3/8"	25'
40-0253	—	3/8"	6'
40-0126	—	1/2"	25'

## Hand Tool



**Stud Remover and Replacer** is a powerful tool that is designed to fit into the hard to reach spots and get out the hard to turn studs. Capacity from 1/4" to 3/4".  
**VT No. 16-0617**



16-1881



16-1610

**Saddlebag Latch Rivet Tool** gives secure fastening of rivets while providing a clean factory look.

**VT No. Type**  
**16-1881** Jims  
**16-1610** VT



**Safety Wire Tools.** Wire twisting pliers have an automatic twisting and playing motion which gives uniform twists without damaging wire, with an attractive end result. Bolt drill fixture allows drilling of 1/16" diameter holes in heads of hex, 12 point, or allen head cap screws from 3/16" to 5/8" shank diameter. Includes drills and bushings, which secure the bolts during the drilling operation. Tools sold separately.

**VT No. Item**  
**16-0749** Drill Fixture  
**16-0983** Twisting Pliers  
**16-0972** Tie Wire, .032  
**16-0971** Tie Wire, .041



# Cylinder



**Jims Twin Cam Case Boring Jig** used for boring out Twin Cam Case sets to accept 4" Bore Cylinders. This tool is designed to be used in a heavy duty 15" drill press. Works on TC-88 A&B Crank Cases. **VT No. 16-1177**



**Cylinder Head and Crankcase Boring Fixture** designed to simplify and reduce the time required to prepare the crankcase and cylinder heads for big bore kit installations. The boring plate is made of cast iron and is precision ground and machined with Panhead and Shovelhead head bolt patterns in one end. The other end has been finished with the cylinder base patterns of Knuckleheads, Panheads, Shovelheads and V2 Sportsters and Big Twins. When adapted to boring bar it is possible to bolt the crankcases or heads to the plate and perform the boring modifications necessary for 3 5/8" bore cylinders. V2s require use of spacers because of the extreme length of the cylinder and head spacer, part VT No. 16-1868. Big Twin V2's with male style studs require on spacer VT No. 16-1868 and one spacer VT No. 16-1869. Note: Big Twins V2's with female type studs must be changed to the male type of studs, when installing a sidewinder.

VT No.	Item
16-1867	Boring Plate with screws
16-1868	3 1/16" Spacer
16-1869	7/8" Spacer

**Figure 1: Identifying the correct oil passages**

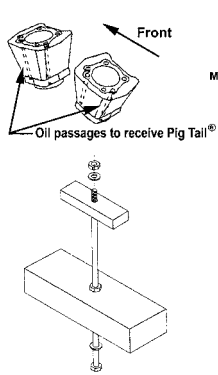

**Figure 2: Marking oil passage angle**

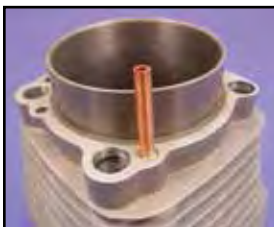
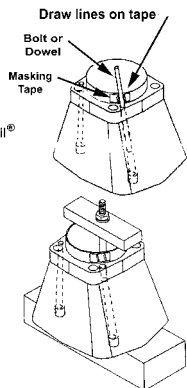

**VT No. 16-0911 Tube Installed**



**Evolution Cylinder Oil Passage Drain Tubes** for stock bore size cylinders only. Each kit is supplied with tap, hex wrench two drain tubes and instructions.

VT No.	Item
16-0911	Kit
16-0912	Pair Replacement Tubes only



**Jims TC-88 Cylinder Torque Plates** lasered with correct torquing sequence for TC-88 and TC-96 OEM cylinders. **VT No. 16-1287**



**Jims Evolution Case Cylinder Spigot Bore Tool** allows boring of cylinder spigot hole, up to 3.8125" by utilizing the stock cylinder stud holes. Use on all 1984-99 style Evolution crankcases. **VT No. 16-1409**



**Ring Groove Cleaner.** **VT No. 16-0619**



**16-1039**



**16-1264**

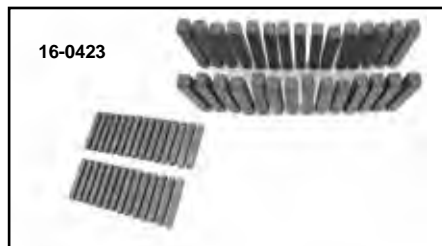

**16-0423**

**Motor Number Stamp Set for FL models.**

VT No.	Year
16-1039	1936-47
16-1264	1950-69
16-0423	1970-99



**S&S Evolution Cylinder Torque Plate Kit** simulates stress conditions when boring and honing Evolution Cylinders. Machined from chrome moly steel, fits all Big Twin 1340 and Sportster 883-1100-1200 cylinder, and 3 5/8" S&S cylinder.

**VT No. 16-0928**



**Cylinder Hold Down Nuts** are used to hold down cylinders during service. Allows motor to be turned over with heads off. Use on all Twin Cam and Evolution Twins. Set of 4.

**VT No. 16-0446**



**Cylinder Wall Flex Hone** features silicone carbide globules which allow the deglazing of cylinders 3" to 4 1/4" when powered by a 3/8" or larger drill, 180 Grit.

VT No.	Bore
16-0574	4 1/4"
16-0576	4"
16-0575	3 5/8" - 3 3/4"
16-0616	3 7/16" - 3 1/2"
16-0618	3" - 3 1/16"



**Piston Ring Installer Tool.** **VT No. 16-0628**



**Ring Compressor Kit.** **VT No. 16-0622**



**Jims Piston Support Plate** provides a non-marring flat support to push the bottom of the piston as rings and cylinder are installed over piston. **VT No. 16-1164**



**Piston Ring Grinder Tool.** **VT No. 16-0976**



**16-1264**





# Cylinder



16-1845



16-1846

**Evolution Cylinder Tools** allow installation of stud to correct height or removal by locking to stud.

- |               |                 |
|---------------|-----------------|
| <b>VT No.</b> | <b>Item</b>     |
| 16-1845       | Assembly Tool   |
| 16-1846       | Extracting Tool |



**Cylinder Jig Assembly** use to repair stripped damaged cylinder base threads up to a 4" bore, in engine case. This will hold centerline

and squareness to where the factory intended them to be. All this with the engine still in the frame using an angle head drill (drill not included). Use on all 1984-99 Big Twin Evolution and 1986-up XL.

**VT No. 16-0891**



**Exhaust Stud Drill Fixture** fits 1984-up Ex Big Twin and XL ports to align for drilling of broken exhaust stud.

**VT No. 16-0698**



**Head Bolt Torque Gauge** for all Evolutions. This gauge allows the measuring of 90° when tightening Evolution head bolts. Torquing sequence lasered on gauge. Use on all 1984-up Evolution models.

**VT No. 16-0679**

# Head



**Jims Compression Release Valve Tool** use this tool for machining all Twin Cam heads 1999-up for compression releases. Installs on front or rear head, with or without valves installed. Order

threaded tap tool and compression releases separately.

- |               |   |
|---------------|---|
| <b>VT No.</b> | <b>Item</b>                             |
| 16-1169       | Compression Release Tool                |
| 16-1170       | Threaded Tapping Tool                   |
| 16-1171       | Compression Release Valve, pair         |
| 60-0132       | Machine Head and Install Release Valves |



**Cylinder Head Support Stand** fits Evo, Shovelhead and Ironhead Sportsters. Adapters are to be used with a bar press and the stand included to push guides in and out in a straight line. Set includes stand and 6 adapters.

**VT No. 16-0651**



**Jims Rocker Box Alignment Tool Set.** Fits 1999-up FXST, FLST, FLT, FXD

**VT No. 16-1882**



16-1884

**Jims Exhaust Pipe Retaining Ring Tool** fits 1984-up FXST, FLT, 1986-up FLST, XL.

**VT No. 16-1884**



**Cylinder De-Glazer** feature spring action on the stones keep the stones against the cylinder wall at the correct pressure. Capacity 2" to 5½".

**VT No. 16-0610**



**Head Holder Tool** by Pingel® has 12 and 14mm ends to hold head through spark plug hole, by support in a vise. **VT No. 16-1842**



**Jims Beta Engine Interconnect Seal Leak Testing Tool** will check the sealing of interconnect seal 45359-00. This seal is required to seal the oil passage way from right case to the balancer plate in all Beta engines. After you have built the "B" lower end with flywheels, balancer assembly and then before you install the cam support, you will be using this new tool to inspect sealing of the rubber interconnect seal. You should also check this deal when installing a new cam set or any time you have the cam support off. If this new or old rubber interconnect seal is leaking it can cause over oiling of the lower end decreasing horse power from oil drag, and oil carry over (oil coming out the breathers). This taxes the other seals and gaskets and lower end oil pressure. Can also be used to check pressure lost at the balancer tension plate. Tool is easy to use, just screw tool to right case and install leakdown tester. Test time takes about the same as changing a set of spark plugs. Use on all Beta Twin engines 2000-up.

**VT No. 16-1859**



**Clone Speed Wrench** allows removal of head bolts on 1936-84 Overhead Valve models, after they are broken loose with wrench.

**VT No. 16-0953**



**Clone Cycle! Original Design by Frank Andrus of New London, Ohio in the mid-1990's.**



**Jims Beta Engine Hydraulic Balancer Retainer Tool** use these retainers to hold the hydraulic tensioners in place when repairing all Beta engines. The hydraulic tensioners are used to keep constant chain tension on the counter balancer system. Without the use of these retaining tools you will not be able to remove or install the balancing system. Use on all Beta Twin Cam engines 2000-up.

**VT No. 16-1858**

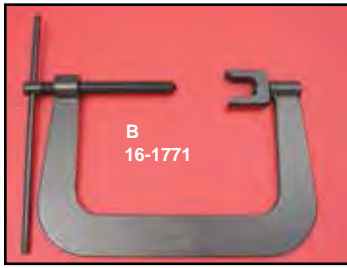

B  
16-1771



16-0320

**Conical Valve Spring Collar** add this to the Jims or Motorshop valve spring compressor tool (96600-36B) to remove and replace valves and conical valve springs (Bee Hive) OEM 18245-02. A must have tool for safe valve work. Use on all 2005-up Big Twin, except S.E. models and all 2004-up XL's.  
**VT No. 16-0320**



16-0146



16-1788

**Valve Spring Compressors** Factory style replaces 96600-36 for all Big Twins OHV.

VT No.	Fits	Brand	Fits
16-0146	1936-84	Replica	Big Twin
16-1771	1936	Jims	Big Twin/Evolution
16-1788	1936-up All	Sifton	Big Twin/Evolution
16-0320*	2005-up 2004-up		Big Twin XL

\*Note: Conical Valve Spring Adapter only to be used with 16-1771 valve spring compressors.



**Jims Exhaust Gasket Installer Tool** will correctly install exhaust port gaskets into cylinder heads, minimizes gasket distortion. Helps heads flow better.  
**VT No. 16-2112**



**Sunnen Valve Seat Driver Kit** includes driver, 1.50 x 1.625 ring, 1.75 x 1.875 ring and 2.00 x 2.215 ring.  
**VT No. 16-0523**

## Valve



16-0331

**Sifton Valve Spring Tool** is bench mounted to compress springs on 1936-up engines also used for checking valve travel and coil bind of the valve springs by placing a dial indicator on the top of the threaded shaft.

VT No.	Item
16-1774	Bench Tool
16-0331	Cone Adapter



**Rear Intake Valve Spring Compressor.** Compresses intake valve spring on the rear cylinder of the Softail so the rocker box can be removed while the engine is still in the frame. It does this without damage to the valve stem, valve spring, or rocker cover. Replaces 34641.

**VT No. 16-0868**



**Valve Grinding Stick** for hand grinding valves. Synthetic rubber vacuum cup is resistant to oil, grease and gasoline. 1/16" cup diameter.

**VT No. 16-0604**

## Timing

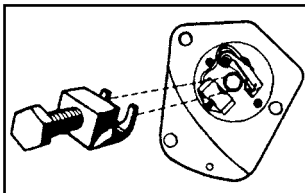

16-0161

**Acu-Time Device** locks advance mechanism on all 1970-78 models for accurate static timing. Includes instructions.

**VT No. 16-0161**



**Spark Plug Indexer** fits 14mm plugs allows electrode to be placed in proper position.

**VT No. Item**  
**16-0623** Tool  
**16-0676** Index Washer 30 Assorted



**Spark Plug Firing Indicator.** Captive type spark plug firing indicator. No need to puncture cable. Reads flashes from neon bulb to indicate plug firing.  
**VT No. 16-0624**



**Spark Tester** is adjustable for all voltages, gauge background makes spark easy to see for accurate measure.  
**VT No. 16-0991**



**Clear Timing Plugs** available long optically clear type or short standard version with or without the internal hex.

VT No.	Type	U/M
16-1731	Long	Each
16-0829	Hex	Each
16-0099	Standard	10 pack
16-0160	Standard	Each



**TDC Indicator** is a 14mm tool that locates top dead center of piston with heads on engine, when degreasing camshaft.

**VT No. 16-0047**



**Flywheel Locking Tool** screws into timing hole and allows holding of the crank for top dead center. It has a hollow center to allow view of timing mark.

**VT No. 16-1851**



**Timer Device** bolts inside primary cover on 1970-up Big Twin models. After installation, only inspection oval of outer primary has to be removed for accurate timing.

**VT No. 16-1736**



**Clean Time** pushes into timing hole and wipes flywheel clean for strobe timing.

**VT No. 16-0715**

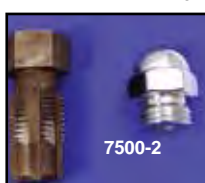

7500-2



7502-2

**Oversize Plugs with Tap.** Kit includes a tap and a chrome dome head plug.

VT No.	Type	Includes
7502-2	Engine Drain	Plug and Tap
7503-1	Engine Drain	Oversize Plug
7500-2	Timing	Tap and Plug, Acorn
7501-1	Timing	Acorn Plug, O.S.
9407-1	Timing	Tap only

16-7443



**Timing Tools.** Screw into timing axle, and are spring loaded for a positive location.

16-7444



VT No.	Type
16-7443	Slot
16-7444	Point





# Tappet Tool



**16-1024 Pushrod Cover Removal Tool** fits TC-88 models. VT No. 16-1024



**Sifton Tappet Guide/Oil Pump Alignment Tool.** Use to align tappet guide to engine case on all Evolution 1340 Big Twins and also aligns oil pump on TC-88 Big Twins. Also available in width 1/4 x 24 threads for after market crankcase sets. Sold in pairs.

**VT No. Fits**  
**16-0998** Evolution Tappet Guide/TC-88 Oil Pump  
**16-0977** 1/4" x 24



**16-0874 Sifton Tappet Roller Fixture.** Positions and holds roller and tappet for removal and reassembly for all Big Twins including Evolution. Instructions are included. Punch and drill not supplied. VT No. 16-0874



**Tappet Guide Puller Tool** for 1957-85 Sportster, replaces 95724-57. VT No. 16-0157

**Jims Tappet Adjuster Hand Tool** verifies proper adjustment on most hydraulic tappets for Evo and Twin Cam models. VT No. 16-1886



**Jims Tappet Test Stand Adapter** for 1984-98 Twins. **Note:** Adapter for use with tester on Evolution Style tappets that bled down. VT No. 16-1863

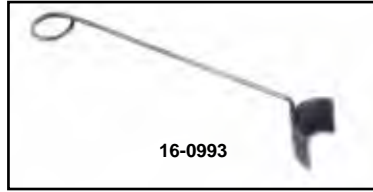

**16-0993 Sifton Pushrod Adjustment Gauge** for use on Big Twins 1953-84 with hydraulic lifter. Replaces 91438-79. Complete with instructions. VT No. 16-0993



**16-1035 Sifton Magnetic Tappet Lifter** holds tappets up while changing cam on all Evolution or TC-88 Engines. VT No. 16-1035

**Jims Twin Cam Oversize Reamer.** Designed to ream the case to fit a +.010 oversize Twin Cam tappet. Includes reamer and two flex hones. Tappet sold separate.

**VT No. Item**  
**16-2789** Tool  
**16-1811** Tappet



**Jims Pushrod Cover Clip Tool** allows installation and removal of pushrod tube clips on all Twins. Made of black delrin. This tool will not slip on main pushrod cover clips. VT No. 16-0384



**Sifton Pushrod Cover Compressor Tool** allows removal and installation of pushrod clip. VT No. 16-1728

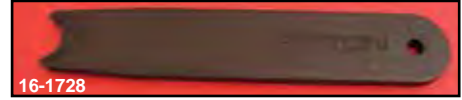

**16-1728 Pushrod Cover Compressor Tool** pushes against top rocker box to allow one hand operation. VT No. 16-1052



**16-0819 Sifton Pushrod Adjusting Wrench** eliminates the need for 3 hands, dual wrench holds 2 outer nuts. The inner is tightened with a separate wrench, fits 7/16" hex nuts and is fully adjustable for solid tappets. VT No. 16-0819



**Jims Tappet Position Holding Tool** for all 1991-up Twin Cam and 2000-up XL engines. This tool allows the tappets and anti-rotation pins to be safely and accurately stored for proper reinstallation. Tappet locations are clearly referenced on the tool, which also serves to protect the tappets from damage when removed from engine. VT No. 16-1031

## Rocker Arm



**Rocker Arm Bushing Reamer** fits Big Twin and Sportster Arms by Jims. VT No. 16-1804



**Cast Fin for Repair** cut to fit and weld in! VT No. 11-1710

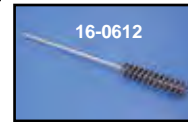
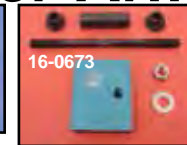

**16-0612 Rocker Arm Bushing and Roller Bearing Puller** for 1957-up Big Twin and XL. Replaces 95760-57. VT No. **Item**  
**16-1848** Puller  
**16-0673** Installer  
**16-0612** .554 Ball Hone

## Valve Guide



**16-0643 Valve Guide Driver Tool Set.** Three sizes of drift valve guides for Sportsters, 74's and 45's. Includes 5/16", 11/32", and 3/8" valve guide drive.

**VT No. Type**  
**16-0132** V-Twin  
**16-0643** Jims



**16-1745 Valve Guide Flex Hones** used to finish valves guides. Made from 180 grit silicon carbide to ensure smooth finish. VT No. **Size**  
**16-0403** 1948-79 Big Twin Kit  
**16-0404** 1980-84 Big Twin Kit  
**16-1745** 1985-up Big Twin and XL Evolution Kit  
**16-0405** 1957-84 XL Kit  
**16-0133** 1948-79 Big Twin Tool, Black, only  
**16-0134** 1957-84 Sportster and 1981-83 Big Twin  
**16-1746** 1984-up Evolution Tool

**Valve Guide Flex Hones** used to finish valves guides. Made from 180 grit silicon carbide to ensure smooth finish. VT No. **Size**  
**16-0759** 10mm Shovelheads  
**16-0760** 8mm Evolution and XL



**Valve Guide Seal Installer** installs valve guide seals to proper height without damage, for Shovel. OEM 35103. VT No. 16-0870

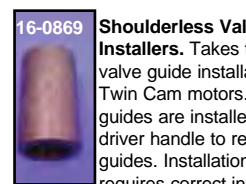

**16-0869 Shoulderless Valve Guide Remover and Installers.** Takes the guess work out of valve guide installation on all Evolution and Twin Cam motors. Insures that the valve guides are installed to proper depth. Use driver handle to remove or install valve guides. Installation of shoulderless guides requires correct installation socket.

**Installation Socket Driver Driver**  
**VT No. Handles VT No. Handles Fits**  
**16-0869** — Evolution  
**16-0321** **16-0322** 2005-up Twin Cam



**Valve Guide Driver and Sockets** install shoulderless 83-up XL and Evolution guides to correct depth. Includes three sockets and one driver. VT No. 16-0422

**Valve Guide Reams. Sold each.**

VT No.	Size	VT No.	Size
16-0761	.310	16-0769	.343
16-0762	.311	16-0770	.344
16-0763	.312	16-0771	.376
16-0764	.313	16-0772	.377
16-0765	.314	16-0773	.378
16-0766	.340	16-0774	.379
16-0767	.341	16-0775	.380
16-0768	.342	16-1860	7 mm



# Wiring Tools



**16-1258**  
Pin and Receptacle Extractor for Molex style connectors.

VT No.	Type
16-1258	Pin
16-1259	Receptacle

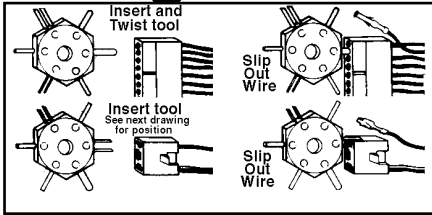

**Wire Terminal Tool** replaces 97362-71, depresses terminal lock tabs in disassembly of factory wiring harness.  
VT No. 16-0959



**Spark Plug Wire Tool** strips 7 and 8 mm ignition wire, crimps spark plug and distributor terminals.  
VT No. 16-0514



**Jims Ignition Switch and Fork Lock Tool** used to make installing or removing the ignition switch and fork lock a easy process.  
VT No. 16-1179

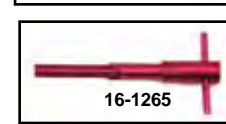

**Ignition Switch Housing Tool** will align the ignition switch housing as the retaining screws are being torqued. Use for proper alignment of switch knob with housing. Use on all 2003-13 FLT models and 2002-up V-Rods.

VT No.	Year	Type
16-0318	2003-13	Jims
16-0319	2003-up	Jims
16-0017	2003-13	VT
16-0003	2003-13	VT
16-1137	2014-up	Jims
16-1265	2014-up	VT



**Wire Terminal Tool** crimps factory style wire end.  
VT No. 16-0710



**Removal Tool Set** for Deutsch HD10, HD20, HD30 Connectors.  
VT No. 16-0090



**Deutsch Terminal Crimping Tool** is designed to correctly crimp Deutsch Connectors. Replaces 39965.  
VT No. 16-1295

## Deutsch Pin Tools.

VT No.	Size	Color
16-0087	20	Red
16-0088	16	Blue
16-0089	14	Green

# Deutsch Tools



**VO Scope Tool** allow the technician the ability to inside mot any hole that is larger than a 1/4". This is a live remote video with the following features high resolution, auto focus, color camera and 2 1/2" full color viewing monitor. Equipped

with a sealed, fluid proof, flexible 24" long 6mm diameter cable, high output LED illumination with dimming control. A mirror used to see 90 degrees and a magnet for picking up steel parts weighing less than 1/4 lb. Used for checking inside cylinders, cylinder heads, etc.

VT No 16-0385



16-0476

**Deutsch Terminal Tool** use with stamped type terminals  
VT No. 16-0476



16-0475

**Deutsch Terminal Tool** use with solid type terminals  
VT No. 16-0475



16-1618



16-1619



16-0478

## Wire Removal Terminal Tools.

VT No.	Style
16-1618	Mate-N-Lock
16-1619	Molex MX-150
16-0478	Delphi-Packard Weather Pack



**Computer Diagnostic Service Tool.** This tool is capable of diagnosing trouble codes for all 1994-99 computer controlled Big Twins. Available as a standard tool that includes scan tool, software cables, adapters, A/C power adapter and instruction manual. For USA 110v 60 cycles application.

VT No.	Item
16-5000	Scan tool
16-5002	Delphi System Cartridge 2001-2002 FXST



**Daytona Twin Tec Twin Scan II** for all 2001-up fuel injected models using Delphi system and 2003-06 carbureted models with 12 pin ignition modules reads and cleans diagnostic trouble codes from engine control unit, turn signal/security module, speedometer and tachometer. The Twin Scan II is especially useful for diagnosing hard to find intermittent trouble codes. The motorcycle can be operated while the unit is installed under normal condition (no trouble codes) the unit will store data of the last hour of operation. If a trouble code is set the unit automatically stop logging data 30 minutes after the code is set. This allows you examine data before and after the code was set. The Twin Scan II interfaces to a laptop PC minimum PC requirement is 300MHz Pentium running Windows 98/ME/XP with SVGA display and available USB port. Also available Twin Cam II and Tuning aid for Screamin' Eagle Race tuner includes all feature of Scan II but allows the tuner to analyze logged data and display front and rear cylinder air/fuel ratio and the required volumetric efficiency correction (in percent) with the same RPM rows and throttle position sensor columns used in the SERT tables. Twin Scan II+ includes WEGO IID dual channel wide ban exhaust gas oxygen sensor interface for logging AFR date along with engine date.

VT No.	Item	Fits
16-0376	Twin Scan 2	2001-12 with J1850 bus
16-0378*	Twin Scan II Plus	As Above
16-0379	Twin Scan 3	2011-u with CAN data bus

\*Note: Same features as Twin Scan II with the addition of extended data logging time, USB interface and waterproof construction.





# Electrical Connector

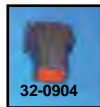

Pin Housings, each.		
# of Pins	OEM	VT No.
8	72108-94	32-0904
12	72109-94	32-0905



Socket Housings, each.		
# of Pins	OEM	VT No.
2	72112-94	32-0906
4	72114-94	32-0908
8	72118-94	32-0910
12	72119-94	32-0911

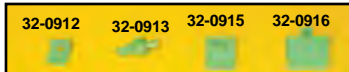

Pin Housing Locks, 10 pack.		
# of Pins	OEM	VT No.
2	72142-94	32-0912
3	72143-94	32-0913
4	72144-94	32-0914
6	72146-94	32-0915
8	72148-94	32-0916
12	72149-94	32-0917



Socket Housing Locks, 10 pack.		
# of Pins	OEM	VT No.
2	72152-94	32-0918
4	72154-94	32-0920

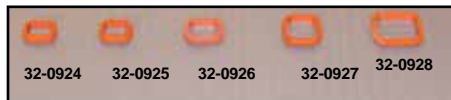

Deutsch Seal Rings		
Seal Rings, 10 pack.		
# of Pins	OEM	VT No.
2	72172-94	32-0924
3	72173-94	32-0925
4	72174-94	32-0926
6	72176-94	32-0927
8	72178-94	32-0928
12	72179-94	32-0929

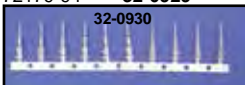

Pin and Socket, 10 pack.		
Item	OEM	VT No.
Pin	72190-94	32-0930
Socket	72191-94	32-0931
Pin	72990-01	32-7438
Socket	72991-01	32-7437

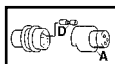

Regulator Connector Fittings.		
VT No.	# OEM	Item
32-9092	A 72051-77	Regulator Plug
32-9090	D 74539-77A	Regulator Connector Socket

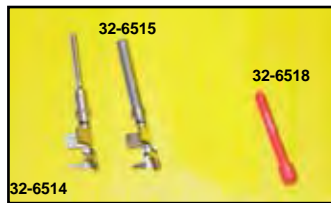

Deutsch	OEM#	VT No.	U/M
Pin	74190-98	32-6514	10
Socket	74191-98	32-6515	10
Pin blank	74195-98	32-6518	10



Pin Housing	OEM	VT No.	U/M
2	74102-98BK	32-6519	1
3	74103-98BK	32-6537	1
4	74104-98BK	32-6520	1
6	74106-98BK	32-6538	1
8	74108-98BK	32-6521	1
12	74109-98BK	32-6522	1



Socket Housing	OEM	VT No.	U/M
2	74112-98BK	32-6523	1
3 (Kit)	74113-98BK	32-6539	1
4	74114-98BK	32-6524	1
6 (Kit)	74106-98BK	32-6538	1
6 (Kit)	74116-98BK	32-6540	1
8	74118-98BK	32-6525	1
12	74119-98BK	32-6526	1



Pin lock	OEM#	VT No.	U/M
2	74142-98	32-6527	1
4	74144-98	32-6528	1
12	74149-98	32-6530	1



Socket lock	OEM	VT No.	U/M
2	74152-98	32-6531	1
4	74154-98	32-6532	1
8	74158-98	32-6533	10
12	74159-98	32-6534	1

**Socket Housing** replaces 4 socket for alternators. 72614-01. Black. Each.

**VT No. 32-7438**



**Fuel gauge**  
2 Pin housing 72902-01BK 32-6535 2

**Namz O2 Enrichment Device.** Recommended for bikes with high flow air cleaner performance exhaust systems. Reduces engine operating temperature between 20 to 30 degrees. Simply plug in between oxygen sensors and wiring harness. Works with stock ECM. Sold in sets.

VT No.	Fits
32-6533	2007-08 FLT, 2007-11 FXST, FLST
32-6554	As Above with Stage 1 Kit installed
32-6555	2010-up FLT, 2012-up FXST, FLST with Stage 1

**Replacement Fuses** for stock custom applications.

VT No.	Amps	Replacement OEM	Type
32-6561	1	72300-89	ATO
32-6562	3	72301-89	ATO
32-6563	5	72302-94	ATO
32-6564	10	72340-94	ATO
32-6565	15	72347-94	ATO
32-6566	40	72314-01	Maxi
32-6577		ATO Sealed Fuse Holder with leads	



**Deutsch Terminal Crimping Tool** is designed to correctly crimp Deutsch Connectors. Replaces 39965. VT No. 16-1295

## Wire Terminals

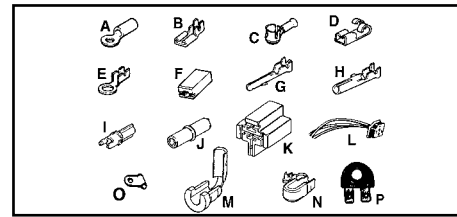

### Ring Type Terminals.

VT No.	#	OEM	U/M Item	Gauge
32-8015	A	9856	25 #6 eye	16-22
32-8016	A	9871	25 #6 eye	14-16
32-8017	A	9857	25 #10 eye	16-22
32-8018	A	9902	25 #10 eye	14-16
32-8019	A	9866	25 #10 eye	10-12
32-8020	A	9858	25 1/4" eye	16-22
32-8021	A	9862	25 1/4" eye	14-16
32-8022	A	9863	25 5/16" eye	14-16
32-8023	E	9945	25 5/16" eye	10-16
32-8101	A	9859	25 3/8" eye	16-22
32-8102	A	9864	25 3/8" eye	14-16
32-8103	A	9868	25 3/8" eye	10-12
32-8104	A	9892	25 5/16" eye	14-16

### Flag Type Terminals

32-8025	B	9904	10 1/8" Female Spade
32-9303	C	9905	5 Big Twin Neutral Switch
32-8027	B	9914	10 1/4" Female Spade
32-8028	D	9925	10 1/4" Right Angle Female Spade
32-8026	B	9930	10 3/16" Female Spade
32-8029	F	71774-77	10 Female Spade Insulator
32-8024	O	9901	25 5/32" Flag
32-8100	P	32604-78	10 Coil Adapter
32-8106		9907	10 1/4" Spade Insulator 16-22 gauge
32-8107		9885	10 Spade Insulator 16-22 gauge

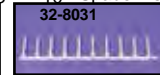
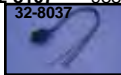

### Amp Mate-N-Lock Pins and Sockets

32-8030	G	72039-71	10 Pin
32-8031	H	72038-71	10 Socket
32-8032	I	72043-71	10 Single Pin Insulator
32-8033	J	72044-71	10 Single Socket Insulator
32-8036	K	72046-79	1 Starter Relay Connection
32-8037	L	72047-71	1 Head Lamp Connection
32-9333	M	72501-74	1 Harness Bushing Straight
32-9334	N	72502-74	1 Harness Bushing Right Angle

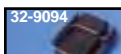

### Amp Mate-N-Lock Connector Blocks.

VT No.	OEM	Type
32-8032	72043-71	Single Pin Insulator, 10 pk
32-8033	72044-71	Single Socket Insulator, 10 pk
32-9095	72035-71	2 Pin Insulator
32-9094	72034-71	2 Pin Socket Insulator
32-6547	72036-71	3 Pin Socket Insulator
32-6548	72040-71	3 Pin Socket
32-6549	70292-89	4 Pin Socket Insulator
32-6550	70291-89	4 Pin Socket
32-8034	72041-71	6 Pin Insulator
32-8035	72037-71	6 Pin Socket Insulator
32-6551	70287-81A	8 Pin Socket Insulator
32-6552	70288-81A	8 Pin Socket
32-9097	70294-87	10 Pin Insulator
32-9096	70293-87	10 Pin Socket Insulator
32-9033	72276-74	12 Pin Insulator
32-9034	72278-74	12 Pin Socket Insulator



Amp 40 Series Connectors		
32-6542	2 Wire Plug	
32-6543	4 Wire Cap	
32-6544	4 Wire Cap Housing	

# Molex MX150 Wiring Connectors



**LED Gear Indicator Kit** features a chrome housing and a bright LED display. Kit control module, housing, and wire harness for easy plug and play installation. Fits 2007-up FLT, 2007-11 FXD, 2007-10 FXST, FLST and 2007-up XL models.  
**VT No. 32-0296**



**Front Turn Signal 36" Extension Harness** for all 2011-up FXST, FLST, and 2012-up FXD models with turn signals mounted under the handlebar switch housing. This extension harness will allow the installation of taller than stock bars and the relocation of turn signal assemblies. The only way to move the turn signals is to cut the turn signal wiring that is hard wired into the circuit board installed in the handlebar switch housing. This harness will allow you to cut the wiring, heat shrink the cut wire to prevent a short, solder on extension harness and simply connect the other end of the harness into the factory connector located under the fuel tank.  
**VT No. 32-3601**

## Molex Wiring Connectors

VT No.	OEM	Female Connectors	VT No.	OEM	Male Connectors
32-9673	72512-07BK	3 Position Black	32-9682	72511-07BK	3 Position Black
32-9697	72514-07GY	3 Position Grey	32-9694	72513-07GY	3 Position Grey
32-9675	72177-04BK	4 Position Black	32-9685	72175-07BK	4 Position Black
32-9677	72414-07BK	6 Position Black	32-9690	72188-07BK	6 Position Black
32-9678	72479-07BK	8 Position Black	32-9686	72478-07BK	8 Position Black
32-9691	72469-07GY	8 Position Grey	32-9687	72447-07GY	8 Position Grey
32-9679	72487-07BK	12 Position Black	32-9695	72488-07BK	12 Position Black
32-9692	72489-07GY	12 Position Grey	32-9688	72490-07GY	12 Position Grey
32-9680	72166-07BK	16 Position Black	32-9689	72177-07BK	16 Position Black
32-9693	72491-07GY	16 Position Grey	32-9698	72492-07GY	16 Position Grey
32-9681	72500-07BK	20 Position Black			
32-9699	72473-07	Blade Cavity Plugs			
32-9700	72169-07	16-20 Gauge			
32-9701	72168-07	16-20 Gauge			



**Auxiliary Lamp Wire Harness Kit** fits 1998-up FL when installing H-4 updated bulbs.  
**VT No.**    **OEM**    **tem**  
**33-0082**    69200441    Wire Harness  
**33-0083**    69200442    Wire Harness

# AMP Multi-Lock Wire Connectors

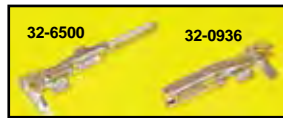

Pin Housing	AMP	OEM#	VT No.	U/M	AMP Pin Socket	OEM#	VT No.	U/M	Socket Housing	AMP	OEM#	VT No.	U/M
2		73102-96BK	32-6501	2		73190-96	32-6500	10	2		73152-96BK	32-6508	2
3		73103-96BK	32-6502	2		73191-96	32-0936	10	3		73153-96BK	32-6509	2
4		73104-96BK	32-6503	2					4		73153-96BK	32-6510	2
6		73106-96BK	32-6504	2					6		73156-96BK	32-6511	2
8		73108-96BK	32-6505	1					8		73158-96BK	32-6512	1

## AMP Wire Connectors

VT No.	OEM	Wiring Pin Housing
32-6501	73102-96BK	2 Position
32-6502	73103-96BK	3 Position
32-6503	73104-96BK	4 Position
32-6504	73106-96BK	6 Position
32-6505	73108-96BK	8 Position
VT No.	OEM	Wiring Socket Housing
32-6508	73152-96BK	2 Position
32-6509	73153-96BK	3 Position
	73154-96BK	4 position
32-6511	73156-96BK	6 Position
32-6512	73158-96BK	8 Position
32-6500	73190-96	16-20 Gauge (Pin Terminal Pack of 10)
32-0936	73191-96	16-20 Gauge (Socket Terminal Pack of 10)







# Deutsch Sealed Connector Components

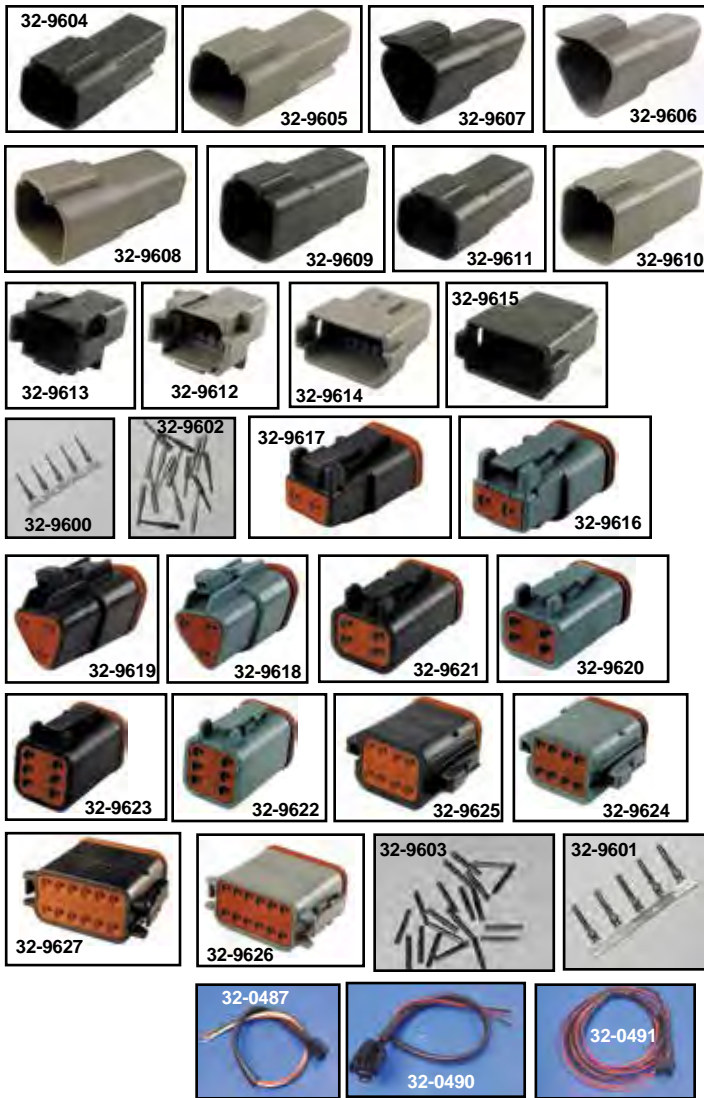

Deutsch Sealed Connector Components		
VT No.	OEM	Wiring Receptacles
32-9605	72102-94BK 72142-94 72172-94	2 Wire Receptacle, Seal and Wedglock-Black
32-9604	72122-94GY 72142-94 72172-94	2 Wire Receptacle, Seal and Wedglock-Grey
32-9607	72103-94BK 72143-94 72173-94	3 Wire Receptacle, Seal, and Wedglock-Black
32-9606	72123-94GY 72143-94 72173-94	3 Wire Receptacle, Seal and Wedglock-Grey
32-9609	72104-94BK 72144-94 72174-94	4 Wire Receptacle, Seal, and Wedglock-Black
32-9608	72124-94GY 72144-94 72174-94	4 Wire Receptacle, Seal and Wedglock-Grey
32-9611	72106-94BK 72146-94 72176-94	6 Wire Receptacle, Seal, and Wedglock-Black
32-9610	72126-94GY 72146-94 72176-94	6 Wire Receptacle, Seal, and Wedglock-Grey
32-9613	72108-94BK 72148-94 72178-94	8 Wire Receptacle, Seal, and Wedglock-Black
32-9612	72128-94GY 72148-94 72178-94	8 Wire Receptacle, Seal, and Wedglock-Grey
32-9615	72109-94BK 72149-94 72179-94	12 Wire Receptacle, Seal, and Wedglock-Black
32-9614	72129-94GY 72149-94 72179-94	12 Wire Receptacle, Seal, and Wedglock-Grey
32-9600	72693-06	Stamped Type Pin Terminal Pack of 100
32-9602	72192-98	Solid Type Pin Terminal Pack of 100
VT No.	OEM	Wiring Plugs
32-9617	72112-94BK 72152-94 72172-94	2 Wire Plug, Seal, and Wedglock-Black
32-9616	72132-94GY 72152-94 72172-94	2 Wire Plug, Seal, and Wedglock-Grey
32-9619	72113-94BK 72153-94 72173-94	3 Wire Plug, Seal, and Wedglock-Black
32-9618	72133-94GY 72153-94 72173-94	3 Wire Plug, Seal, and Wedglock-Grey
32-9621	72114-94BK 72154-94 72174-94	4 Wire Plug, Seal, and Wedglock-Black
32-9620	72134-94GY 72154-94 72174-94	4 Wire Plug, Seal, and Wedglock-Grey
32-9623	72116-94BK 72156-94 72176-94	6 Wire Plug, Seal, and Wedglock-Black
32-9622	72136-94GY 72156-94 72176-94	6 Wire Plug, Seal, and Wedglock-Grey
32-9625	72118-94BK 72158-94 72178-94	8 Wire Plug, Seal, and Wedglock-Black
32-9624	72138-94GY 72158-94 72178-94	8 Wire Plug, Seal, and Wedglock-Grey
32-9627	72119-94BK 72159-94 72179-94	12 Wire Plug, Seal, and Wedglock-Black
32-9626	72139-94GY 72159-94 72179-94	12 Wire Plug, Seal, and Wedglock-Grey
32-9601	72694-06	Stamped Type Socket Terminal Pack of 100
32-9603	72193-98	Solid Type Socket Terminal Pack of 100

Deutsch Connector includes wire harness to be spliced to replacement as listed.

VT No.	Type
32-0485	1996-up Side Switch
32-0487	Headlamp
32-0490	Starter Relay
32-0491	Tail Lamp
32-0492	Module End



## Delphi Connectors



Delphi Wire Connectors		
VT No.	Male Connectors With Wire Seals	Female Connectors With Wire Seals
32-9634	1 Wire	
32-9635	2 Wire	
32-9636	3 Wire	
32-9637	5 Wire	
VT No.	Female Connectors With Wire Seals	
32-9639	1 Wire	
32-9640	2 Wire	
32-9641	3 Wire	
32-9642	5 Wire	
32-9638	Replacement Wire Seals Pack of 10	
32-9643	Stamped Male Crimp Terminals Pack of 50	
32-9644	Stamped Female Crimp Terminals Pack of 50	

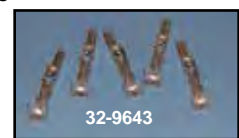

# Throttle by Wire "Plug-n-Play" Harness

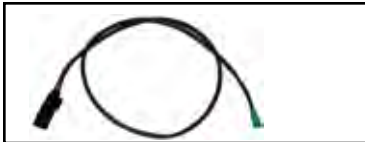

**Throttle-by-Wire "Plug-n-Play" Wiring Harness** is a no brainer when adding taller handlebars. It is longer than stock and is one size fits ALL handlebars. Simply remove the OEM harness and plug ours in. It comes complete with OEM connectors installed for simple installation. Fits all 2008-up Touring models. **VT No. 32-6651**



**Namz On Board Power Port** with dust cover. Plugs into on board diagnostic port. Fits 1994-11 FLT models.

**VT No. 32-6579**



**Headlamp Static Harness.**  
**VT No. 32-1721**



Turn Signal Kits.	VT No.	Length
	32-6672	4"
	32-6673	8"
	32-6674	12"
	32-6675	15"

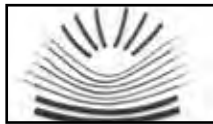

**Front Turn Signal Extension Harness** used for installing taller handlebars on all models when keeping turn signals mounted on handlebar switch housings on 1996-12 models.

No crimping required. De-pin factory harness and connector and install new extension harness.

VT No.	Extension Over Stock Length
32-6557	4"
32-6558	8"
32-6559	12"
32-6560	15"



**Ready to Install Handlebar Extension Harnesses**  
• All the items needed to successfully extend the wiring to a set of handlebar switches. Harnesses include both male and female Molex terminals crimped on each end. Feature color matching wire as per original harness.

**Fit 2011-up FXST, FLST, 2012-up FXD, 2014-up XL**

32-6676	+ 4"
32-6677	+8"
32-6678	+12"
32-6679	+15"

**Fit 2007-10 FXST, FLST, 2007-11 FXD, 2007-13 XL**

32-6656	+4"
32-6657	+8"
32-6658	+12"
32-6659	+15"

**Fit 1996-06 FXST, FLST, FXD, XL**

32-6664	+4"
32-6665	+8"
32-6666	+12"
32-6667	+15"

**Throttle by Wire Handlebar Wiring Extension Kits** includes factory type connectors for easy assembly.

32-6688	+8"	2016-up FLT, FXST, FLST
32-6689	+15"	2016-up FLT, FXST, FLST

## Wire Clamp



**Nylon Tie Straps, 25 pack**

Chrome	Black	Length
25 pack	100 pack	
28-0720	28-0710	4"
28-0721		7"
	28-0711	7 <sup>3</sup> / <sub>4</sub> "
	28-0712	15 <sup>1</sup> / <sub>8</sub> "



**Chrome Handlebar Wiring Clips** snap into handlebars with holes at bends, 10 pack.

VT No.	Inner Diameter
36-0613	3/8"
36-0614	1/2"

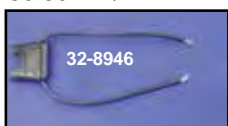

**In-Line Fuse Holder** has 6" long wire leads.

VT No.	Type
32-0410	Fuse
32-8946	ATC Type



**Vinyl Coated Cable Clamps** can be mounted to frame fork or fenders to help route cable wires or brake lines. Mount hole available in 1/4" or to fit #10 screws (.200).

VT No.	Qty.	Inner Diameter	Mt. Hole
37-8128	10	1/4"	1/4"
37-8129	10	3/8"	1/4"
37-8132	10	1/2"	1/4"
37-8904*	25	7/16"	.200"
37-0832	5	3/8"	.200"
37-8905	Each	1/2"	.200"

\*Note: Uncoated.



**Zinc Plated Strap Clamps** with 9/32" hole, sold in 10 pack.

VT No.	U Size
37-9139	7/16"
37-9141	9/16"
37-9142	5/8"

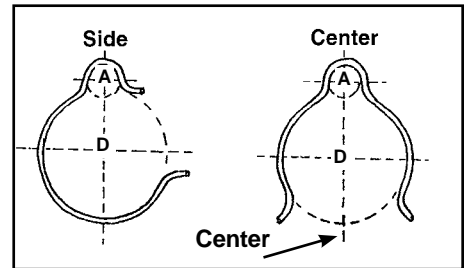

"D" is the diameter of the tube it fits. "A" is the size wire/loom that is secured.



37-8680

**Control Cable and Wire Clamps** are zinc plated spring steel, packs of 10.

VT No.	D-Tube Size	A-Wire Size
37-8677	1" Side	3/16"-7/32"
37-8678	1 1/4" Side	3/16"-7/32"
37-8679	1" Center	3/16"-7/32"
37-8680	1" Center	5/16"
37-8681	1 1/8" Center	5/16"



**Chrome Billet "G" Clamps** to hold wiring or line, 5 packs with 7/16" screw.

VT No.	Clamp Tube Size	Finish
37-1506	1/4" 1 1/16"	Alloy
37-1500	1/4" 1 1/16"	Chrome
37-1501	7/16" 1 1/8"	Chrome

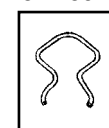

**Stainless Handlebar Wiring Clip** attaches wire to bars, at stock hole locations or can be drilled, 10 pack.

**VT No. 32-0343**





# Magnetos



**Joe Hunt H-4 Automatic Advance Vertical Magnetos** for Big Twins features include H4 automatic advance for easier starting and hotter spark, aluminum cam cover in either natural or polished finish (no frame, pipe, or-brake pedal modification are required) and rare Earth magnets that never need to be recharged.

VT No.	Fits	Finish
32-1296	1970-92	Natural
32-1250	1970-92	Polished
32-1251	1993-99	Natural
32-1252	1993-99	Polished
32-1299	TC-88 Carburetor Models Only	Natural
32-1253	TC-88 Carburetor Models Only	Polished
32-1254	TC-88 with S&S Gear Drive	Polished
32-1300	TC-88 with S&S Gear Drive	Natural
32-1255	1970-92	Drive
32-1275	1993-99	Drive

**32-0169 1966-69 Big Twin Distributor Mount Clamp Kit** includes zinc plated clamp, stud, O-ring and nyloc nut.

VT No.	Item
32-0169	Kit
12-0547	Stud only, 5 pack

**Fairbanks 1/2 Scale Magneto Model.** Pewter construction.  
VT No. 48-1675



**Magneto Assembly** with right hand rotation features internal female hex drive on rotors to fit all Joe Hunt, Morris and Fairbanks Morse drive units.

VT No. 32-1311

## Magneto Rebuilds

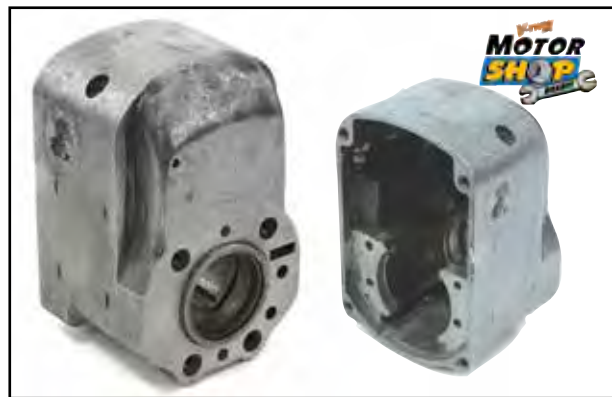

**Magneto Rebuilds.** Our Motor Shop will completely rebuild Joe Hunt, Fairbanks Morse or Morris Magnetos. We stock the most complete selection of replacement components.

VT No. 60-1957

**Got a Good Body with Good Magnets... We Can Rebuild!**



**Forged Aluminum Magneto Cap** features a recessed design to hold gasket in place and features a natural finish with Burkhardt logo. VT No. 32-0284



48-2292



48-1772



48-0472



48-1603

**Cloth Patches** available. Sold as a pair.

VT No.	Item
48-2292	Vertical Magneto
48-1772	Vintage Logo
48-0472	Rectangular Logo
48-1603	Buckhardt Logo

# Magneto

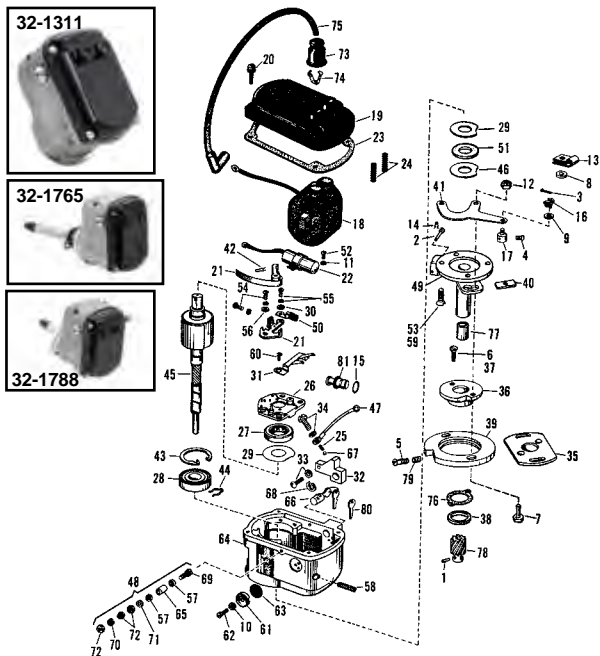

- 36-0513 92077-62 Tach Cable 1965-1969
- 32-1348 Adapter Plate Set (3 pc)
- 14-0107 12023 Magneto Base Plate Seal
- 32-0976 Magneto Rebuild Kit
- 32-1045 Tag, Points, Condenser Kit
- 32-1346 Magneto Base and Gear
- 32-1807 Magneto Tach Plug Kit
- 32-0971 Drive Kit
- 32-1057 29534-55A Condenser
- 12-0181 29562-55 Bearing Set  
29563-55
- 12-1114 Race
- 13-9208 Coil Springs, 10 pack
- 32-7784 Lighting Capacitor
- 32-0116 Points and Condenser Kit
- 15-1020 Top Gasket
- 15-0972 Magneto Neoprene Cap Gasket
- 32-0064 Screw Kit
- 32-1038 Metal Morse Tag
- 32-1081 Kill Button
- 32-1563 Kill Button Kit, 1959-70
- 32-1082 Bearing Kit
- 32-1102 Drive 1971-80
- 32-1247 Rotor and Magneto Shaft Assembly
- 32-1255 Angle Drive
- 32-1347 Base 1971-80
- 32-1490 Magneto Base
- 32-1664 Adapter Plate
- 32-0823 Cast Base
- 32-1284 Terminal Kit
- 32-1293 Magneto Base Mount Kit
- 32-1345 Magneto Base Kit
- 32-1298 Magneto Body
- 37-1030 Magneto Advance Screw
- 32-1425 Magneto Name Tag
- 32-1314 Insulator Block
- 32-0269 Rotor Kit
- 32-1146 Kill Switch Kit
- 32-1232 Magneto Ignition Points and Condenser Kit
- 32-1453 Kill Switch Kit
- 32-1563 Kill Switch Kit
- 32-1766 Vent Cap Kit (2)
- 32-0283 Magneto Drive Assembly
- 32-1356 Magneto Screw Set

VT No.	#	OEM	Description
32-0029	1	255	Pin, Drive Gear
12-1112	2	491	Pin, Tachometer Plug
37-8660	3	510	Cotter Pin 1/16 x 1/2
32-1027	5	1074W	Screw, No. 8-32 x 7/8 Fillister
32-1029	7	3791	Bolt, 1/4-28 x 3/4 Hex Head (2)
37-1020	8	6107B	Washer, 5/16 x 1/16 x 1/8
37-1021	9	6165	Washer, 3/16 x 3/8 x 1/32
37-1022	10	7010	Lockwasher, No. 6
37-8917			Lockwasher, No. 8, and Screws, 25 pack
37-1024	12	7683	Nut, 1/4-28 (2)
31-1031	13	9958	Clamp, on tappet guide
31-1030		9994	Clamp, on crankcase stud
31-1032	14	11024	Spring Clip, tachometer plug pin
14-0506	15	11110	O-ring, tachometer plug
13-0157	16	27291-32	Spring, wire block
2658-5	17	27450-36	Wire Block, magneto control
32-0716	18	29524-55A	Coil
32-0645	19	29530-55A	Cover, Black, each
32-0644		29530-55A	Cover, Clear, each
32-1564		29530-55A	Cover, Red, each
37-1025	20	29531-55	Screw, magneto cover (4)
32-0119	21	29533-55A	Circuit Breaker Points Set
32-0122	22	29534-55A	Condenser Only
15-0149	23	29550-55	Magneto Cover Gasket
32-1800	26	29561-55	Bearing Support, right hand
32-0026	27	29562-55	Rotor Cam End Bearing
32-0027	28	29563-55	Bearing, rotor shaft end
37-1027	30	29565-55	Contact Screw Washer (2)
32-0028	32	29590-62	Primary Insulator Block Kit for ground
37-1028	33	29591-62	Insulating Block Screw and Washer Set
37-1029	34	29593-62	Ground Wire to Block Screw and Washer
32-1292	35	29600-48	Magneto Base Adapter Plate
32-0646	35	29600-62	Magneto Base Adapter Plate
32-0515	36	29600-65C	Magneto Base Adapter Plate
37-1030	37	29601-48	Magneto Adapter Screw (2)
14-0528	38	29603-48	Timer Seal Ring Housing (5)
32-0516	39	29604-65	Magneto Advance Lower Adapter Plate
37-1031	40	29607-62	Washer, magneto adapter (2)
36-0514			Tach Cable Driven Gear
31-0485	41	29607-65	Magneto Control Arm
31-1033	42	29620-55	Breaker Spring Clip
12-1113	43	29621-55	Rotor shaft end Shaft End Snap Ring
31-1034	44	29622-55A	Rotor shaft end Spring Clip
32-2110	45	29623-55A	Magneto Rotor Assembly with Hex drive
37-1032	46	29624-55	Washer, rotor shaft end
32-0079	47	29625-55	Ground Terminal Wire
32-0080		29625-62	Ground Terminal Wire
32-0081	48	29626-55	Ground Terminal Assembly
32-0082	49	29626-62	Drive Housing and Screws
32-0036	50	29628-55	Wick and Holder
32-0037		29629-55	Breaker Arm Wick
14-0166	51	29630-55	Rotor Shaft End Seal
15-1539		29631-55	Magneto Gasket Kit
37-1033	52	29632-55	Condenser Mount Screw
2884-6	53	29632-66	Magneto Adaptor Plate Screw Kit
37-1035	54	29633-55	Breaker Arm Screw and Washer (2)
37-1036		29633-62	Breaker Arm Screw and Washer (2)
37-1037	55	29634-55	Breaker Arm Contact Screw and Washer
37-1038	56	29635-55	Breaker Arm Washer
37-1039	57	29635-62	Ground Terminal Washer (2)
37-1040	58	29636-55	Coil Set Screw (2)
37-1041	59	29632-62	Taper Screw Set (4)
37-1042	60	29638-55	Safety Gap Plate Screw
32-1002	61	29639-55	Vent Cover
37-1043	62	29640-55	Vent Cover Screw
32-1018	63	29641-55	Vent Screen
32-1229			Mount Kit
32-1019		29642-55	Magneto Housing
32-1801		29642-62	Magneto Housing
32-1022	65	29645-62	Ground Terminal Bushing
32-0073	66	29646-62	Ignition Ground Lock & Keys Kit
32-1037	67	29647-62	Ground Switch Ball
32-1033	68	29648-62	Ground Lock Retainer Clip
37-1046	69	29657-62	Ground Terminal Screw
37-1047	70	29658-62	Ground Terminal Lockwasher
37-1048	71	29659-62	Lockwasher, ground terminal, int. tooth
37-1044	72	29660-62	Nut, ground terminal (3)
15-0154	76	32522-37	Adapter Plate Gasket
15-1031	76	32522-37	Adapter Plate Gasket
10-0717	77	32525-36A	Bushing, drive housing
32-0198	78	32531-36	Drive Gear
32-0077	80	71626-62	Ground Switch Lock Key
32-1034	81	92077-62	Tach Plug and O-Ring

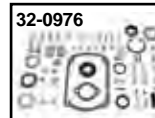
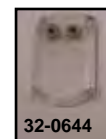





# Magnetos



**Magneto Assembly** fits Big Twin Overhead Valve 1936-69.

VT No.	Item	Brand
32-1765	Adjustable	BH
32-1452	Adjustable	JH
32-1301	Solid	JH

**Distributor Hold Down Clamp** fits 1965-69 BT.



VT No.	Finish
32-0135	Zinc
32-1342	Chrome

## For Sportsters



## Magneto.

VT No.	Year	Brand
32-1276	1957-64	Direct Drive
32-0285	1965-70	Direct Drive
32-1869	1957-70	Burkhardt
32-1302	1971-80	Joe Hunt
32-1305	1971-80	Burkhardt
32-1863	1971-80	Burkhardt
32-1346	1957-70	Shaft Assembly
32-1680	1957-70	Shaft Assembly, cad
32-1358	1971-80	Shaft Assembly



## Shaft Assembly

VT No.	Year	Base	Shaft
32-1490	1957-70		
32-0579	1957-70		



**Flathead Magneto** fits 1930-73 45 1936-48 Big Twin SV.

## VT No. Item

32-1788	Burkhardt
32-1276	Burkhardt
32-1297	Hunt
32-1741	Indian
32-1490	Base Drive Assembly
32-1137	SV Drive Assembly
32-1294	SV Shaft features snap ring groove and hex drive



**1973-92 Big Twin Nose Cone Magneto Assembly.** Full kit includes Joe Hunt magneto. Head has a vertical Burkhardt drive. Features adjustable manual advance.

## VT No. Item

32-1973	Complete Assembly
32-1860	Burkhardt Cover & Magneto Drive Assembly



**Joe Hunt Magneto.** Order related mount plates separately.

VT No.	Item
32-1311	Magneto Head
32-1303	Magneto Head without shaft, JH
32-1298	Magneto Head, JH
32-1290	Magneto Assembly
32-1803	Burkhardt Housing, 1970-84
32-1210	Shaft Kit, 1941-69
32-1970	Shaft Assembly Kit
32-1317	Gear Set
32-0971	Drive Kit, 1970-92
32-1357	Drive Cam Gear
32-0971A	Gear Set



## Cad Plated Components

VT No.	OEM	Item
32-0577	29600-62	Adapter Plate
32-0580	29604-65	Magneto Adapter Advance Ring
32-0582	29600-65C	Magneto Mount Base
32-0583		Replica Magneto Drive Shaft Assembly
32-0584		Magneto Drive Shaft and Gear Kit



## XLCH Tachometer Cables and Gears.

VT No.	OEM	Item	Years	Type
36-0873		Set		Gear and Cable
36-0514	92063-63	Gear	1962-70	Magneto
36-0513	92065-67A	Cable	1965-69	Magneto
36-2575	92062-65A	Cable	1965-69	XLH Dist.
36-0990	92065-70	Cable	1970-73	XLH-XLCH
36-2549	92097-71	Drive	1971-80	XLH-XLCH
12-1400	25517-71	Drive		Gear for Cam
			1971-80	XLH-XLCH
36-0991	92065-74	Cable	1974-80	XLH-XLCH
36-2573	As Above	Cable		Stainless XLH-XLCH
36-0999	+6"	Cable	1974-80	XLH-XLCH



# Battery Maintenance



**Dyna Charge Monitor.** The DCM-1 evaluates voltage in a charging system and indicates whether system voltage is too low or high. Unit is designed for 12 volt systems and features LED indicators. **VT No. 32-9088**



**Battery Hydro-meter** is a great tester for cycle batteries because of its small size. **VT No. 16-0864**



**"Activator" Battery Filler** attaches to any standard acid pack tube. Positive thumb release valve absolutely controls acid flow. No acid spills, burns or holes in clothing. **VT No. 16-0037**



**Custom Battery Cable Kit** includes 25' cable, (20) 1/4" terminals, (12) 5/16" terminals, (8) 3/8" terminals, 40 pieces black heat shrink and 12 pieces red heat shrink. Available with clear or black cable.

VT No.	Item
32-1350	Clear Kit
32-1351	Black Kit
16-0351	Crimping Tool



**Jims Main Drive Gear Case Seal Installer** ensures correct alignment and installs seal to the correct depth without damaging seal. Fits 1986-2006 FLST, FXST, 1991-2005 FXD, 1985-2005 FLT. **VT No. 16-1028**



16-1792



16-1870

**Super Smart Battery Tender** constantly monitors battery without the damaging effects of a trickle charger. Initial charge brings battery up to full charge then converts to a float charger, keeps a 12 volt battery at 13.6 volts.

VT No.	Type
16-1792	12 volt
16-1870	12 volt, Junior Tender
16-1794	Snap Cord



**Deka Power Sports Advanced Battery Charging System.** A 12 volt 2.0 amp automatic battery tender for both AGM and lead acid batteries. Features LED indicator lights. Reverse polarity protection, spark free operation and automatic switch to float mode. **VT No. 16-0086**



**AGM Battery Tender Lightweight Charger (Power Tender).** 6 amp features ring type terminals without quick disconnect. Available for standard lead/acid batteries or sealed AGM batteries. 12 volt batteries. **VT No. 16-1875**



**Battery Booster Cable Set.** 10 feet in length. 10 gauge in size. **VT No. 16-0350**



**V-Twin Inner Cam Bearing Tool** safely installs the inner cam bearings to the proper depth in the case without damaging bearings. **VT No. 16-1390**



**Rocker Arm Shaft Adjusting Tool** for use on Knucklehead models. **VT No. 16-0001**

## The First Catalog!



**Spring 1968 Catalog, 12 pages!**

©1969, 1972





# Bushing-Race Pullers



**Wheel Race Puller.** Replaces service tool 33071, for hubs with tapered races 1973-99. All models.

**VT No. Item**  
**16-0425** Puller and Installer  
**16-0065** Driver



**Cross Arm Puller** is 1" square bar 4¾" long slotted, with ¾" - 16 bolts, use any size bolt to pull gears and sprockets that have 2 tapped holes, or use with bearing separator 16-0602.

**VT No. 16-0499**

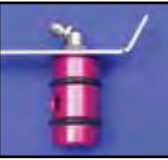

**Wheel Bearing Greaser.** Fitting and spigot greases 1973-99 tapered bearings without removing seals, use existing seal spacer or purchase separately.

**VT No. Item**  
**16-0803** Tool  
**44-0303** Collar

## 4-Speed Transmission Tools



**Big Trans Stud Installer Tool** for 1936-86 4 and 5-Speed Softail.  
**VT No. 16-0719**

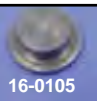

**16-0105**



**16-0036**

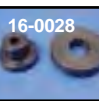

**16-0028**



**16-0057**

### Mainshaft/Drive Bearing Press Tools.

VT No.	OEM	Fits	Press
<b>16-0105</b>	33428A	1979-84 BT 4-speed	Shaft
<b>16-0036</b>	34734	1979-90 BT 5-speed	Seal
<b>16-0028</b>	34810	1984-90 XL	Drive
<b>16-0057</b>	34733	1977-84 Big Twin	Countershaft
<b>16-1755</b>	35820-86	1986-90 XL	Countershaft
<b>16-0117</b>	34735	1936-38	Gear



**16-0561**



**16-1641**



**16-0558**



**16-1371**



**16-0558 Shown in use**

### 2000-up Wheel Bearing Puller and Installer Tools.

Use on all 2000-up Twins. 16-0561 includes arbor to pull ¾", 1" and 25mm sealed bearings.

VT No.	Item	Fits
<b>16-0561</b>	Puller and Installer	2000-up (18 pc)
<b>16-0732</b>	Puller and Installer	2000-06
<b>16-0558</b>	Puller and Installer	2000-06
<b>16-1370*</b>	Puller	2007-up
<b>16-1371*</b>	Installer	2007-up
<b>16-1641</b>	Washer Puller Tool	

\*Note: Requires 16-0732 tool also for use.



**16-0740**



**16-0712**

**Mainshaft Starter Clutch Gear Puller** for 1936-84 4 Speed model.

**VT No. Brand**  
**16-0712** V-Twin  
**16-0740** Jims



**Mainshaft Ball Bearing Lock Nut Wrench** replaces 94635-41A. Fits 1940-up Big Twin models. Handle is not included.

**VT No. 16-0116**



**16-1798**

**Adjustable Reamers** use to fit I.D. on new bushings.

VT No.	Years	Fits
<b>16-1798</b>	1941-85	BT Main Drive Gear
<b>16-1799</b>	1936-84	BT-XL Kicker Shaft
<b>16-0878</b>	1936-57	BT Brake Cross Shaft
<b>16-1801</b>	1936-84	BT Clutch Release Shaft



**16-0155**



**16-0657**

**Wheel Bearing Wrench** removes the slotted lock nut on spoke wheels. Sportster and 1967-72 Big Twins. Replaces 94630-67.

**VT No. Type**  
**16-0155** V-Twin with Handle  
**16-0657** Jims with ½" Drive



**Bushing Puller Tool** will extract bushings in blind holes of cam covers.

**VT No. 16-0231**



**Jims Rear Wheel Compensator Bearing Remove/Installer Tool** used to remove or install the ball bearing in rear pulley on all 2008-up FLT models. Tool will center and guide the bearing for proper installation.

**VT No. 16-0315**



**16-1803**

**Big Twin Mainshaft Seal Remove and Installer** replaces 95660-42. Use to install and remove main seal. This tool will push seal in as flat and straight as possible to .050 below housing for a no leak fit.

VT No.	Years	Speed
<b>16-1803</b>	1936-76	4
<b>Additional Drivers for Above</b>		
<b>16-0702</b>	1977-86	4, (2.4 O.D.)
<b>16-0701</b>	1980-84	5
<b>16-0700</b>	1985-up	5

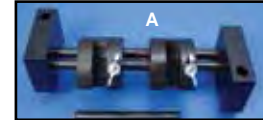

**A**

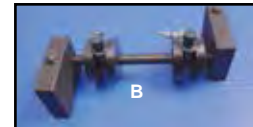

**B**

**Shifter Fork Gauge** is used to set and align shifter forks on Big Twin 4-speed models.

VT No.	Jims	#	Years
<b>16-0121</b>	<b>16-0641</b>	A	1939-78
<b>16-0120</b>	<b>16-0642</b>	B	1979-84

## Countershaft Sprocket Nut Tool



**4-Speed Transmission Arbor** replaces clutch hub nut to allow test rotation with ½" drill.  
**VT No. 16-1274**



**16-0821**



**16-0757**



**16-0054**

**Countershaft Sprocket Lock Nut Wrench** features an extra long two piece design inner collar which will retain wrench to nut. Fits 1936-2005 Big Twins, 1½" hex, 4 and 5 speed models.

VT No.	OEM	Brand
<b>16-0821</b>	94660-37A	V-Twin
<b>16-0054</b>	99660-37A	V-Twin
<b>16-1505</b>	Collar	V-Twin
<b>16-0757</b>	94660-37A	Jims ½" Drive



**16-0114**



**16-0823**



**16-0901**



**49-0366**

**Big Twin Countershaft Sprocket Nut Tool** is a factory style tool.

VT No.	Models	Use
<b>16-0114</b>	1937-84	4-Speed Big Twin 4th Gear Sprocket Nut
<b>16-0901</b>	All	Handle for above
<b>16-0823</b>	1941-73	45
<b>49-0366</b>	1936-40	Big Twin

# 5 & 6 Speed Transmission



**Big Twin Mainshaft Seal Remove and Installer** replaces 95660-42. Use to install and remove main seal. This tool will push seal in as flat and straight as possible to .050 below housing for a no leak fit.

VT No.	Years	Speed
16-1803	1936-76	4
<b>Additional Drivers for Above</b>		
16-0702	1977-86	4, (2.4 outer diameter)
16-0701	1980-84	5
16-0700	1985-up	5



**Jims Right Side Drive Transmission Trap Door Puller Tool.** Removes access door on all right side drive transmissions.  
VT No. 16-1356



**Transmission Main Drive Gear Nut Wrench Tool.** Use to remove the 2 1/4" hex nut from main drive gear which secures the rear drive trans pulley. Use with 1/2" drive ratchet. Use on all 2006-up Dynaglide and 2007-up FXST-FLT models.

VT No.	Brand
16-1359	Jims
16-1261	Sifton



**5-Speed Main Drive Gear Seal Installer Sets** seal to proper depth with transmission assembled. By Jims.  
VT No. 16-0664



**Shifter Shaft Sleeve Tool** fits 5 and 6 Speed transmission.  
VT No. 16-1664



**Countershaft Support Plate Tool** fits 1991-up 5-speed Sportster.  
VT No. 16-1756



**Transmission Door Puller Tool.** Fits 1957-90 XL and 1952-56 K.  
VT No. 16-0139



**Jims Transmission Countershaft Bearing Tool** will install and remove the closed end countershaft bearing on 5 and 6 speed Big Twin transmissions without using a press or tapping with a transmission shaft. Fits 1984-up FXST, 1986-up Flstn 1984-1994 FXR, FLT 1999-UP  
VT No. 16-1883



**Cruise Drive 6-Speed Maindrive Gear Remover Tool** removes the main drive gear from the main bearing correctly while in the transmission case. This eliminates the need of an arbor press and the risk of case damage. For use on all Twin Cam 6-Speed Cruise Drive models and all 2006 Dynaglide and all 2007 to present Twin Cam models.  
VT No. 16-2130



**Jims Transmission Door Removal Tool** use this tool to pull complete door with gears and shafts from transmission. Use on 2006-up Dynaglide and 2007-up FXST-FLT models.  
VT No. 16-1358



**Jims Main Bearing Installer Tool.** Allows proper installation of transmission case main bearing by holding bearing square to its bore. Use on 2006-up Dyna and 2007-up FXST-FLT models.  
VT No. 16-1355



**Big Twin 5-Speed Transmission Shift Pawl Adjuster Tool Set** fits mid 1992 and later. Includes a tool to loosen the jam nut on the pawl adjuster and the other to adjust the shifter pawl set. Replaces 41184.  
VT No. 16-0646



**Jims 5-Speed Transmission Main Drive Gear Tools.** Use 16-0994 to remove and install main drive gear and install main bearing. Use 16-0718 for remove main drive bearing. Both tools can be used without removing transmission case. Use on all 5 or 6-Speed 1980-up Big Twins.

VT No.	Type
16-0994	Main Drive Gear Installer
16-0718	Main Drive Bearing Remover



**Mainshaft/Drive Bearing Press Tools.**

VT No.	OEM	Fits	Press Shaft
16-0105	33428A	79-84 Big Twin 4-speed	Seal
16-0036	34734	79-90 Big Twin 5-speed	Drive
16-1767	37842	1991-up Big Twin-XL	

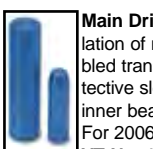

**Main Drive Gear Seal Installer** allows installation of main drive gear oil seal on assembled transmission to proper depth. The protective sleeve included is used for protecting inner bearings of main drive for installation. For 2006-up FXD and 2007-up FLST.  
VT No. 16-1363



**Big Twin Mainshaft Primary Bearing Race Remover and Installer** for use on all 1984-up Big Twins, replaces 34902.  
VT No. 16-1645 Sifton  
16-0877 Jims



**Cruise Drive 6-Speed Maindrive Gear and Bearing Remover/Installer Kit** for servicing the main drive gear or the main bearing on the latest 6-Speed transmission. This precision tool removes or installs both parts correctly without damaging the case. Use on all Twin Cam 6-Speed Cruise Drive models, 2006 Dynaglide and all 2007-up Twin Cam models.  
VT No. 16-2131



**Jims Main Drive Gear Installer Tool.** This tool will hold the main drive gear square to its bearing bore for proper main

drive gear installation. Use on 2006-up Dynaglide and 2007-up FXST-FLT models.

VT No. 16-1350



**Jims Main Drive Gear Bearing and Seal Installer.** This tool will hold bearings and seal square to its bore for proper installation and will also allow both to be installed to proper depth. Use on all 2006-up Dynaglide and 2007-up FXST-FLT models.  
VT No. 16-1353

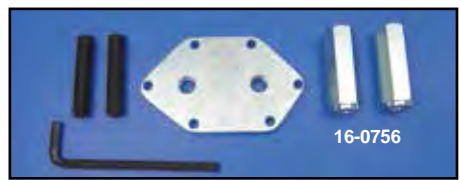

**5-Speed Transmission Door Remover and Installer** removes and replaces the door bearings Saves time as the complete transmission does not have to be dismantled allowing the mainshaft and countershaft clusters to remain in place for use when installing 5-Speed kicker kit.

VT No.	Item/Brand
16-0756	V-Twin Door Remover and Installer
16-0663	Jims Remover Only
16-0731	Jims Installer Only
16-0672	Bearing Remover/Installer



**Cruise Drive 6-Speed Trap Door Bearing Remover/Installer** will accurately install a lubed ball bearing into the transmission trap door. Also removes bearing without error and can be performed on a work bench, no need for an arbor press. Use on all Twin Cam 6-Speed cruise drive models, 2006 Dynaglide and all 2007-up Twin Cam models.  
VT No. 16-2132



**Jims Transmission Assembly Vise Stand** assists in the assembly of transmission gears and shafts. This tool holds the shafts in perfect alignment while protecting them from damage. Use on all 2006-up 6-speed transmissions.  
VT No. 16-1029





# Primary



**Outer Primary Cover Starter Bearing Removal Tool** removes 9063 Torrington Needle Bearing for Big Twin and XL covers. **VT No. 16-0717**  
**Note:** This tool will also remove the 35961-52 Bearing in Countershaft Gear (Late) 4 Speed Big Twin, and also the 4-Speed Sportster Clutch Gear.



**Big Twin Primary Drive Locking Tool** is used as a wedge type device to hold the primary drive gear while the proper torque is applied without damaging the primary gear. Constructed of nylon, OEM# 41214.  
**VT No. 16-0650**



**Ratchet Plate Riveting Fixture** securely aligns plate to drum while setting rivets on 1971-79 XL model clutch drum.  
**VT No. 16-0165**



**Starter Jackshaft Seal Installer Tool** will easily allow alignment and installation of starter jackshaft seal (OEM#12066) without distortion or damage to seal. For 1994-06 Big Twins except 2006 Dynaglide.  
**VT No. 16-1373**



**Inner Primary Cover Bearing and Seal Remover Installer Tool** safely removes and installs inner primary bearing (OEM# 9135) without damage to the new bearing by pushing on the outer perimeter of the bearing. Removes and installs inner primary and seal that the transmission mainshaft passes through (OEM#12052A). For L1984-06 FXST/FLST; 85-up FLT/FLHT/FXR/FXD/FXDWG.  
**16-1367** 1984-06  
**16-1027** 2007-up

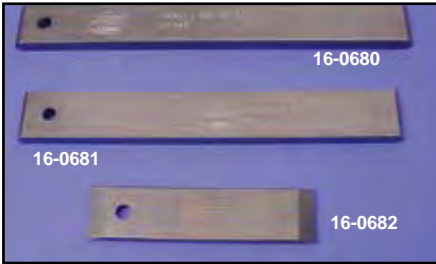

**Primary Locking Bars** use to lock primary for servicing.

VT No.	Use
<b>16-0680</b>	4-Speed BT's and 5-Speed FXST
<b>16-0681</b>	5-Speed FXR-FLT
<b>16-0682</b>	1991-up Sportster and Buell*
<b>16-1357</b>	2007-up Dyna
<b>16-0327</b>	2007-up FLT



**Clutch Adjusting Gauges** are used to find the correct distance between the outer drive plate and outer releasing disc for 1971-83 Sportsters, 1936-67 early and 1968-84 late Big Twins. Set of 3 tools. **VT No. 16-1807**



**Starter Pinion Gear Holder Tool** fits 9 and 10 tooth gears.  
**VT No. 16-0484**



**Starter Ring Gear Rivet Fixture Tool** removes the starter ring gear rivets from Big Twin clutch shells. For 2006-07 Big Twin except Dyna.  
**VT No. 16-1368**



**Primary Plug Wrenches** for Sportster models.

VT No.	OEM	Years
<b>16-0158</b>		1971-84
<b>16-0985*</b>	33186	1971-up
<b>8862-1</b>	Evolution	1986-up
<b>8862-1T</b>	Evolution	1986-up

\*Note: Uses 3/8 socket handle

# Belt



**Final Drive Tool** fits final drive pulley, so the nut can be properly set to torque specifications.

VT No.	Type
<b>16-0649</b>	Big Twin
<b>16-0588</b>	XL



**Belt Tension Gauge** designed to aid in properly adjusting belt tension on models with a secondary drive belt.  
**VT No. 16-1765**



**Calibrated Belt Tension Gauge.** Accurately measures belt tension.  
**VT No. 16-0589**

# Chain



**Standard Chain Puller** eliminates the annoyances of installing the master link in rear chain. Conveniently pulls chain halves together without loosening at rear wheel. Fits all sizes.  
**VT No. 16-0611**

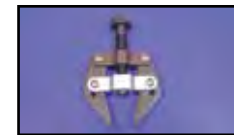

**Chain Puller Tool.**  
**VT No. 16-1615**

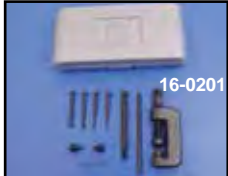

**Diamond Chain Breaker** is excellent for cutting 530 heavy chain.  
**VT No. 16-0255**



**Link Press Tool** presses the side plates on all 530 O-Ring Chains.  
**VT No. 16-1729**



**Chain Riveting Tool and Chain Breaker.**  
**VT No. Item**  
**16-1740** Breaker  
**16-1741** Riveting Tool Set  
**16-0201** Riveting Tool Set (V-Twin)



# Wheel Truing Stand



**Wheel Truing Stand** includes 3/4" and 1" shafts.  
VT No. 16-1525



**Wheel Truing/Balancing Stand** includes tapered adapters and hub arbors.

VT No. Type  
16-0867 Full  
16-1272 Bearings for centering



**Professional Wheel Truing Stand** includes roller stations to facilitate flywheels or crank shafts.  
VT No. 16-0799

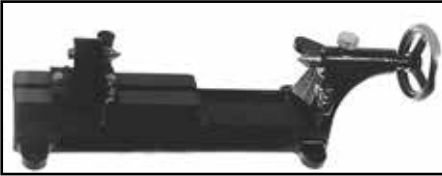

**Wheel Truing Fixture** of cast alloy construction. Adjustable width for all wheels, with or without axle in place. Order 16-0071 roller stanchions for use with flywheels and shafts or wheels with non-removable axle.

VT No. Item  
16-0586 Truing Machine  
16-0071 Roller Stanchions



**Spoke Wrenches.** Available as multi-fit 6 jaw type or 8 gauge forged.

VT No. Type  
16-0164 6 Jaw  
16-0200 1-piece, 8 gauge, forged  
2693-1 Spoke Nipple Wrench, Parkerized  
2662-1 Spoke Nipple Wrench, Cadmium

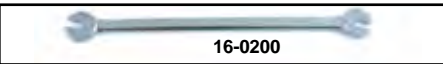

## Tire Tool



**Spoon Style Tire Iron.** 10 1/2" long.  
VT No. 16-0694

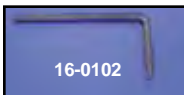

**Wheel Lug Allen Wrench** fits all front and rear wheels 1935-72 FL models.



16-1789

VT No. Item  
16-0102 Lug Wrench  
16-1730 Drive Socket  
16-1789 "T" Lug Wrench

**FLT Wheel Lug Wrench** is a 3/8" hex key shaft which fits all 1982-up FLT models. Sold each.

VT No. 16-0996



**Mini Air Compressor** powered by cigarette lighter socket or connects to battery with cables supplied. Features a compact design to fit inside a saddlebag.

VT No. 16-1634



**Motion Pro Bead Popper** designed to break the bead on all types of motorcycle tires. Made of durable high impact plastic that will not scratch the wheel.

VT No. 16-0542



**Tire Changing Tools.** Breezer Tools makes tire changing a breeze by its patented design which lifts the bead without bending the rim. Instructions included, use in conjunction with the breezer iron. Valve fishing tool combines core driver and deflating pin with full length cable to facilitate working valve through rim hole.

VT No. Item  
16-0163 8 1/2" Forged Iron  
16-1764 15" Forged Iron  
16-0973 240 mm  
16-0066 Valve Fisher



**Tire Pressure and Temperature Monitor.** The tire pressure and temperature monitor tool requires a pressure range of 10-70 PSI and a temperature range of -22 degrees to 185 degrees F.

VT No. 16-9725



**Digital Tire Gauge.** 0-150 PSI.  
VT No. 16-0997



**Bead Breaker** is made of heavy duty cast iron.  
VT No. 16-1778



**Tire Bead Starter** is a safe way to start and seat beads on all tire sizes. The linked straps apply even seating pressure to tire beads

without compressed air. Tool is portable for on the go use and is simple and effective for even mounting a new 300 Series tire.

VT No. 16-9016

## Brake



**Brake Drum Turning Arbor** for all 5-bolt Big Twin brake drums. Replaces 97280-60A.  
VT No. 16-0122



**Brake Caliper Piston Remover** Tool to aid in removal of piston from 2000-up front and rear caliper assembly. Replaces 43293A.  
VT No. 16-0541



**One Man Brake Bleeder** includes tubing and canister and complete instructions.  
VT No. 16-1784



**Front Low Pressure Master Cylinder Bleeder Covers** will allow one person to bleed brake lines or to check system for leaks and can drain the entire system to replace brake fluid.

VT No. Year  
16-7319 1972-81  
16-7320 1982-95  
16-7322 1996-98



**Flex Hone for Rotor** designed to produce a swirl or cross hatch pattern with a non-directional finish which reduces friction induced breaking noise: medium grit. Designed for low speed operation using a 3/8" drill. Available for master cylinder bore.

VT No. Use  
16-0640 Rotor  
16-0785 5/8" Master Cylinder  
16-0786 1 1/4" Master Cylinder  
16-0787 3/4" Master Cylinder

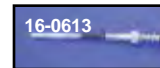

**Brake Cylinder Hone.** 3/4" to 3"  
VT No. 16-0613



**Snap Ring Pliers** are specially designed with long reach fingers for use on master cylinders.  
VT No. 16-0788





# Clutch Tool



**Clutch Assembly Service Tool** will safely disassemble and assemble the clutch shell assembly and also remove and install the clutch hub from the bearing. Safe removal and installation of clutch shell ball bearing (OEM# 37906-90) with no damage to new bearing.  
**VT No. 16-1366**



16-0967

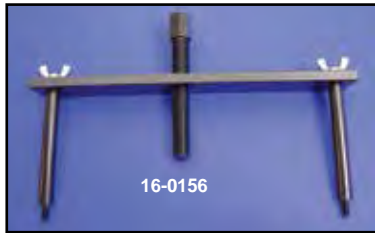

16-0156



16-0410



16-0059



16-1769

**Clutch Compressor Tools** allows disassembly of clutch pack.

VT No.	Year	Model
16-0410	1941-84	Big Twin
16-0967	1990-up	Big Twin
16-1769*	1991-up	XL's (Screw)
16-0156	1971-84	XL's
16-0059	1985-90	XL's

\*Note: Adapts 16-0967 to fit 1991-up XL.

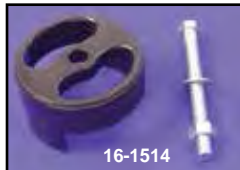

16-1514

**Clutch Compression Tool** fits 1990-up Big Twin and 1991-up XL models.  
**VT No. 16-1514**



16-1805



16-1849

**1990-up Big Twin Clutch Compressor Tool** features access windows to ease the removal and installation of snap ring, by Jims.  
**VT No. Fits**  
**16-1805** Big Twin  
**16-1849** Adapter to fit 1991-up XL



**Jims Clutch Adjusting Tool** allows mechanic to quickly and accurately tighten the clutch adjusting screw jam nut without having the screw change position. Includes wrench and correct hex key. Use on all 1985-up Big Twins.  
**VT No. 16-1030**



2556-1



16-0113



16-0115



16-0961



16-0310

**Clutch Hub Pullers.** 16-0113 pointed type pulls clutch hubs on 74" and 45", motor sprockets on 74" and XL transmission sprocket on XL, also rotor assembly on 74" and 80" Big Twin, 1970 and later. 16-0115 swivel style fits over clutch push rod on 1970-85 Big Twin so there is no need to remove the kick cover.

VT No.	Item	Type
2556-1	1936-40	Point
16-0113	1941-84	Point
16-0115	1941-84	Swivel
16-0961	1984-up Wet Clutch Type	
16-0310	Primo Brand Pro Clutch	Big Twin

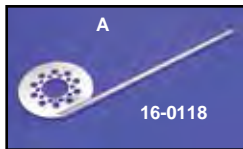

16-0118



D

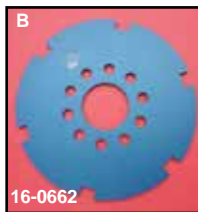

16-0662

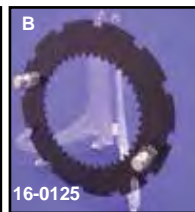

16-0125



E

**Clutch Drum Locking Tools** for removing clutch hub and motor nuts.

VT No.	#	Year	Model
16-0118	A	1941-84	Big Twin
16-0662	B	1941-84	Big Twin, Jims
16-1775	E	1984-89	Big Twin
16-0125	B	1952-70	XL
16-0159	D	1956-84	XL
16-0992	C	1971-84	XL



**Gasket Locator Tool (3 Pc Set)** will align primary, cam and transmission end cover gaskets, to prevent misalignment and oil leaks.  
**VT No. 16-1362**

## For V-Rod



16-1667

**V-Rod Clutch Hub Holder** by Jims.  
**VT No. 16-1667**

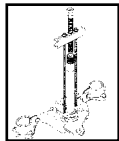

**Lower Neck Bearing Puller Set** includes cross arm puller, rods and lower puller claw. Simply remove roller from old bearing, install claw and turn puller.  
**VT No. 16-0073**



**Fork Bearing Installer Tool** fits over 1" stem allowing bearing to be "driven" on.  
**VT No. 16-0724**



**Hex Top Fork Nut Socket** has 3/8" drive, rubber protector on inside for Glide Forks, 35mm. By Jims.  
**VT No. 16-0670**



**Socket Wrench** is designed for easy removal and installation of stock 1 3/8 hex flat top fork tube plugs. Installed O-Ring eliminates damage to top of plug. Black oxide.  
**VT No. 2317-1**



**Fork Tube Spring Retainers and Pin Wrench Kit** includes 2 retainers for 1952-72 XL and pin wrench for installation removal of retainers.  
**VT No. 7700-3**



**FXSTS Fork Stem Bearing End Play Setup Wrench. Offset Handle** allows for proper clearance of fuel tank and other accessories.  
**VT No. 16-0444**



16-1768



16-0895

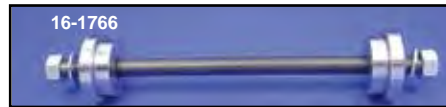

16-1766

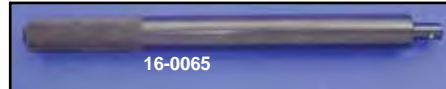

16-0065

**Steering Head Bearing Tools** fit 1988-up FXST, 1982-up XL, 1992-up FXDB-FLT to remove or install races.

VT No.	Item
16-1768	Remover
16-1766	Installer
16-0065	Driver Handle for A
16-0895	Driver Handle Adapter, 1992-up FLT-FXD



**Fork Stem Nut Wrench** fits FLT.  
**VT No. 16-1977**



**Fork Pre-Load Assembly Tool** allows pre-load to be set on 41mm forks during assembly.  
**VT No. 16-0745**

## Fork

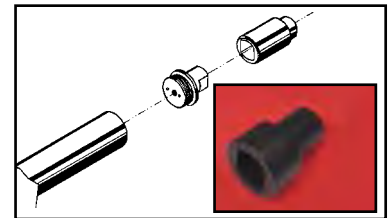

**Fork Tube Plug Tool** has a special socket which fits 1948-up Glide Fork Plug, 1/2" drive.

VT No.	Brand
16-0630	V-Twin
16-1008	Jims



16-1009

**Fork Spring Compressor Tool** puts pressure on top fork plug to compress spring to ease in assembly.

VT No.	Type
16-1009	Jims
16-1025*	Jims

\*Note: Use with 16-1009 for extended length fork tubes.



**Fork Cap Wrench.**  
**VT No. 16-1034**



**Fork Tube Assembly Stand Tool.**  
**VT No. 16-2600**

## Fork Seal Drivers



**Fork Seal Driver** for 41 mm bushing and seal installation.  
**VT No. 16-0557**



**Seal Driver Kit** quickly installs seal without damage, includes 16 adapters for seals up to 3 3/8" diameter. Includes special adapters for "shielded" seals.  
**VT No. 16-0069**



**Bearing Race and Seal Driver** includes driver handle and 6 machined aluminum collets to fit most bearings.  
**VT No. 16-0505**



16-0055



16-0056



16-0964

**Fork Seal Installer.** Installs bushing and seal without damaging components.

VT No.	OEM	Use
16-0055	34190	1983-up FXRT 1983-up XR 1984-up FX-XL
16-0056	34634	1984-Later FLT-FXWG
16-0964	36583	1987-up FXR-FXRS, 88-up XL



**49mm Fork Seal and Dust Shield Installer Tool** installs the lower leg 49mm fork seal squarely into the bore with no damage to the lip seal surface. Also installs dust shield cover. It is a two-price design to aid in some assembly applications.  
**VT No. 16-1369**



**Adjustable Split Fork Seal Driver Set** use on all 35mm, 39mm and 41mm forks. Includes seal drive and three seal guides.  
**VT No. 16-0074**



**Duo-Glide Nut Double Ended Wrench** used for removing and installing crenulated nuts and dust covers with internal thread.  
**VT No. 16-1344**





# Swingarm



16-0329 in use

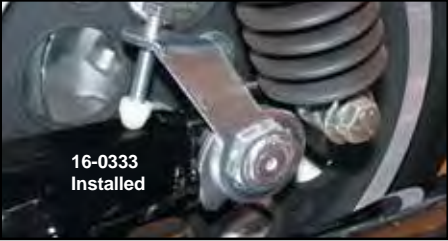

16-0333 Installed



Axle lock tool. This tool holds the axle in place and prevents movement of adjustment while you torque the rear axle on 2002 and up FLT

**3rd Hand Axle Locker Tool.** If you have noticed, as you are torquing down the axle nut after you set the proper belt tension, (Deflection) the welded axle nut will move to the low side of adjuster cam. This movement will allow the belt to lose adjustment. Now with **3rd Hand Axle Tool**, you will not need to find a helper to hold the nut or yourself having to reach around the tire and hold the nut from moving. Just place this tool over the welded nut on left side with the neck portion of tool resting over the swing arm. Hand screw the adjusting screw to take up any slack in tool. Torque the axle nut from right side knowing that the welded nut will not turn allowing the belt to lose its adjustment.

VT No.	Brand
16-0329	Jims
16-0333	VT



**Rear Swing Arm Section Bearing Remover/Installer** for use on 1986-99 FXST-FLST models.  
VT No. 16-0688



**Jims Powertrain Alignment Tool** aligns powertrain to proper position safely and easily on most touring models. Performing alignment service must be done when engine,

transmission or swing arm has been repaired or removed. This tool helps to provide the accurate alignment necessary for handling safety and performance. For 1993-97 FLHT; FLHR; FLHX and FLTR.

VT No. 16-1365



**Jims Rear Axle Nut Torque Adapter** for 2006-up FL Touring models. This tool is designed with a 1/2" drive receiver hole for inserting your torque wrench thus letting you torque the axle nut from an offset position. Removal of muffler is not required for use of this tool.

VT No 16-1906



16-1733



16-1734

**5-Speed Swing Arm Tools** cleve block spreading tool facilitates installation of swing arms on rubber mount models. Swing arm assembly tool removes and installs swing arm pivot components.

VT No.	OEM	Item
16-1733	33805	Spreading Tool
16-1734	96200-80	Assembly Tool



**Hollow Axle Plug Tool** will give the correct center point required for safe vehicle alignment. Lube the o-ring ends of these tools and insert in left and right ends of axle on Dynaglide and XL models. Use on all 2008-up Dynaglide and XL models.

VT No.	Brand
16-0328	Jims
16-0332	Sifton

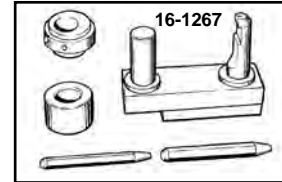

16-1267

**Rear Sprocket Rivet Tool.** This fixture will support sprcket for riveting. Fits 1930-48 U, 1957-78 XL, 1947-72 FL.  
VT No 16-1267

# Suspension



**Shock Absorber Tool.** Replaces 97010-52A to simplify shock absorber disassembly or assembly by holding spring in compression while disassembling parts. Includes 97019-52A block.

VT No.	Item
16-0079	Tool
16-1847	Bolt for Above



**Shock Tool Set** is a five piece set of each of the numbers listed below.

VT No.	#	OEM	Model
16-0136	A-E	Complete	Set
16-0101	B	94820-75	1975-78 XL's Gabriel
16-0409	C	94409-78	1979-up Sportster
		94448-82	1979-up FXR-FLT
16-0408	A	94408-78	1982-up FL-FLH
		94444-82	1982-up FX-FXE
16-0100	D	94700-65	1952-74 Sportster
			1958-81 FL-FX Scissor Type
16-0748	E	94555-89	1989-up FXST-FLST
16-0954	F	94448-82A	1989-up ST, 1979-up XL-FXR



**Shock Tool** for use with 3/8" ratchet drive. Fits 1989-up Softail.  
VT No. 16-0917



**Bead Breaker** will depress bead on mag or spoked wheels.  
VT No. 16-0570



**Evolution Ratcheting Intake Manifold Wrench** features ball end allen bit end for flexibility in tight areas.  
VT No. 16-5530

**Evolution Rocker Box Cover Ratcheting Wrench** features low profile to allow clearance between frame and engine, long handle for increases reach and replaceable bit.

VT No.	Item
16-6529	Wrench
16-6530	Replacement Bits

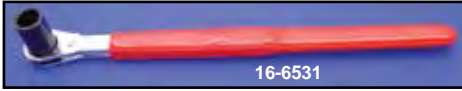

**Lower Rocker Box Wrench for Evolution and Twin Cam Models** is used to install and remove lower rocker  $\frac{7}{16}$ " mounting bolts.

VT No.	Fits
16-6531	Evolution
16-6532	TC-88



**Exhaust Bracket Wrench** used to remove and install front exhaust bracket bolts on all 1999-up TC-88 Dynaglide models.  
VT No. 16-6538



**Speedometer Sending Unit Wrench** features a shortened  $\frac{3}{16}$ " ball end hex bit for removal or installation of hex screw used on all Big Twin models. Equipped with electronic sending units.  
VT No. 16-6738



**Oil Pressure Gauge and Indicator Lamp Sending Unit Wrenches.** These reversible ratcheting wrenches are used to install and remove oil pressure indicator lamp or gauge sending unit on all FL Touring models 1999-up.

VT No.	Item
16-9723	Indicator Lamp
16-9724	Sending Unit



**Manifold-Side Car Wrenches** large type, heavy duty for shop use.

VT No.	OEM	Size	Use
16-0111	94536-18	1 $\frac{3}{4}$ "	Side Car
16-0110	94537-26	1 $\frac{7}{8}$ "	45 Manifold
16-0112	94538-30	2"	SV Manifold
16-0109	94538-48	2 $\frac{1}{8}$ "	Big Twin Manifold
16-0447		1 $\frac{5}{8}$ "	Panhead
16-0448	94538-48	2 $\frac{1}{8}$ "	Panhead



**Chrome "S" Wrench** is for  $\frac{5}{16}$ " &  $\frac{3}{8}$ " bolts.  
VT No. 16-0734

# Wrench

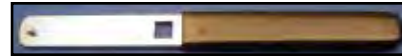

**Evolution Rocker Box Cover Wrench** is designed to reach  $\frac{3}{16}$ " allen on Evolution Big Twins and Sportster models. Features a  $\frac{3}{8}$ " drive for use with torque wrench and a vinyl covered handle. VT No. 16-0220



**FLT Rear Axle Nut Ratchet Wrench** for 36mm axle nut. Low profile design allows access to rear axle nut without removal of exhaust system.

VT No. 16-9636



**Spark Plug Socket Set** features  $\frac{3}{8}$ " drive to fit 12 and 14mm plugs.  
VT No. 16-0202



**Swivel Spark Plug Wrench** for all 12 and 14mm plugs. 180° rotation.  
VT No. 16-0824



**Standard Spark Plug Wrench** 14mm type with bar handle fits under FL tanks.  
VT No. 16-0825



**Twin Cam 24 Tooth Crankshaft Rotating Wrench** for use on all 2006-up Big Twins with 24T spline sprocket shaft to check engine timing and parts clearance.

VT No. 16-9280



**Three Piece Upper and Lower Valve Cover Wrench set** fits hex and clip style covers.  
VT No. 16-1864



**Jims Oxygen Sensor Wrench.**

VT No.	Fits
16-2755	2012-up FXD front and rear, 2012-up FXST
16-2756	2012-up FXST rear only



VT No.	Size
16-0833	$\frac{9}{16}$ x $\frac{1}{2}$
16-0834	$\frac{3}{8}$ x $\frac{7}{16}$



**Jims Seat Mounting Screw Tool**  
VT No. 16-1178



**11 Piece Open End and Box Wrench Set.**  
VT No. 16-1744



48-0498  
80" UL



48-0470  
Knucklehead



48-0030  
1340 cc



48-0033  
Dual Cam



48-0025  
Panhead



48-0044  
Shovelhead



48-0048  
Shovelhead



48-0372  
XLCH 1971



48-1824  
45"





# HELI COIL

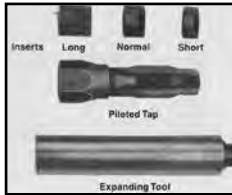

# Thread Repair Kit

## Heil-Coil Thread Repair Kits.

are individually packaged by size in either a special thread series or contain special length inserts for the specific applications listed below. All kits come with tap, installation tool, a quantity of size inserts and complete instructions.

### Heli-Coil Kits and Replacement.

Kits For HD	Thread Size	Length	Repair Kit	Inserts Per Kit	Inserts Only	Insert Qty.	Drill Size
Spark Plugs	18mm	.500	16-0906	24	16-0907	6	23/32
Pan D Rings	10-24	.285	16-0918	12	16-0919	12	13/64
Front/Rear Brake Drum Threads	3/8-20	.375	16-0921	6	16-0931	6	25/64
Head Bolt Threads	7/16-16	.656	16-0922	6	16-0932	6	29/64
XL Engine/Transmission Drain Plug, Early	1/2-13	.375	16-0923	6	16-0933	6	17/32
Drain Pl Big Twin Chain case, XL Transmission	1/2-20	.375	16-0924	6	16-0934	6	33/64
Timing Plug	5/8-18	.325	16-0925	6	16-0935	6	41/64
Case Bolt and Gen.	5/16-24	.469	16-0926	12	16-0936	12	21/64
Big Twin Trans Cover w/Locking Insert	5/16-18	.469	16-0927	12	16-0937	12	21/64
Cam cover screw, tappet guide, oil pump stud and timer, and mounting threads							
	1/4-24	.500	16-0920	12	16-0930	12	17/64
	1/4-20	.375	16-0941	12	16-0944	12	25/64
	3/8-16	.562	16-0942	12	16-0945	12	25/64
	3/8-24	.562	16-0943	12	16-0946	12	25/64



**18mm Adapter Set** allows 14mm plugs to be used in earlier heads with 18mm spark plug threads.  
VT No. 32-0057



**Spark Plug Hole Service.** Motors hop will HeliCoil 14 mm spark plug holes on head sets. 15 day turn around time. Chose Heli-Coil only or Weld-Up and Heli-Coil.

<b>VT No.</b>	<b>Type</b>
60-0168	Heli-Coil
60-0170	Weld/Heli-Coil



**Universal Thread Gauge Set** identifies USS, Metric, pipe size and spark plug size, four piece set.  
VT No. 16-1763



**14-18mm Spark Plug Hole Thread Chaser** renews damaged threads 13/16. Removes carbon and corrosion with a few turns. Allows firm seating of plugs. Assures metal to metal contact for effective heat transfer.

VT No. 16-0603



**Die Tool and Tap Set.** 8 piece set is for special threads. Set includes headbolt tap tool, tap brake drum tool, tap tool, mainshaft die left hand tool, Spring Fork handlebar end tap, linkert tap tool 1/4" x 40", 1/4" die tool and tap set.  
VT No. 16-0187



**Heli-Coil Sav-A-Thread** repairs spark plug holes for 14mm short or long reach plugs on aluminum heads. Includes items pictured. No drilling necessary.

<b>VT No.</b>	<b>OEM</b>	<b>Item</b>
16-0044		Kit, Complete
16-0043	16725-66A	1/2" Insert, each
16-0042	16725-75	3/4" Insert, each

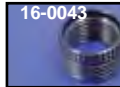

### Special Taps and Dies.

<b>VT No.</b>	<b>Thread</b>	<b>Use</b>
16-0807	3/8" x 20	1930-72 Brake Drum
16-0809	5/16" x 32	Grease Fitting, 9851
16-0416	7/16" x 16	UL-VL-45 Head Bolt
16-0014	1/4" x 24	Timing and Transtop Die
16-0407	1/4" x 24	Die
16-1263	1/4" x 24 Tap	Die Set
16-0904	13/16" x 24	1931-35 H Bars
16-0905	7/8" x 24	1936-48 H Bars
16-0865	9/32" x 32	Bendix Adjuster Jet
2282-1	11/16"	Timing Hole
16-1262	57/64" x 24	Handlebar Tap
16-0271	1/4" x 40	Linkert
16-0091	3/4" x 16	Tap



**Dies** are round type adjustable to restore damaged or mistreated threads.

<b>VT No.</b>	<b>Type/Use</b>
16-0836	1936-84 Big Twin 1" x 24T FL-FLH Fork Stem
16-0801	1971-84 FX-FXE, 54-85 XL 7/8" x 24T Fork Stem
16-0811	1936-84 Big Twin Mainshaft 3/4" x 18 Left



**Fork Stem Die Holder.** Order die separately.

<b>VT No.</b>	<b>Item</b>
16-0272	Holder Only
16-0051	Set
16-0836	Die Only 1" x 24



# Bushing

10-2515	35316-41	Low Gear 45 Side Valve
10-2517	35320-41	Second Gear 45 Side Valve
10-0728	35322-38	38-58 Big Twin Mainshaft Third Gear
10-2516	35787-52	54-72 All XL's Countershaft 1st Gear
10-0752	35787-72	73-84 XL Countershaft 1st Gear
10-0729	35789-36	41-85 Big Twin 4-Spd Countershaft Low Gear
10-0730	35791-36	41-85 Big Twin 4-Spd Countershaft 2nd Gear
10-2547	36035-26	29-73 45" Countershaft Left
10-2490	36042-41	41-73 45" Countershaft Side Cover
17-9830	37436-36	36-84 Big Twin 4-Speed Mainshaft End Bushing
10-0753	37458 41	Clutch Gear 45 Side Valve
10-0751	37458-52	52-85 All XL Models Clutch Gear
10-0733	40520-63	77-up XL Shifter Shaft In Right Crankcase 66-up XL Shifter Shaft In Chain Cover
10-0740	41685-37	37-57 Big Twin Brake Backing Plate Cam
10-2496	—	Same as above .015 O/S
10-1256	42443-80	80-up XL Brake Pedal All
10-2497	47094-58	58-84 Big Twin Seat Post
8859-1	47581-29	29-73 45's Seat Post
7708-1	47583-36	36-57 Big Twin Seat Post
10-0741	47755-31	37-57 Big Twin Brake Crossover Shaft
10-2505	47757-52	75-78 XL Shifter Cross Shaft
10-2500	51925-37	52-78 XL Brake Cross Shaft
10-2501	51925-65	37-64 Big Twin Seat Tee
10-0743	60593-74	65-80 Big Twin Seat Tee
		74-85 FX 4-Speed Inner Primary Shifter

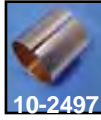

# Shim



12-0704



Shims. Check list for proper applications.

VT No.	OEM	Fits
12-0700	6743	Armature .030 1930-57 Big Twin
12-0701	6743A	Armature .060 1930-57 Big Twin
12-0702	6750	Shifter Fork .005 1941-85 Big Twin 4-Speed
10-1257	6750	.007 As Above
12-0703	6752	Shifter Fork .015 1941-85 Big Twin 4-Speed
12-0711	6762B	Pushrod Cover 1941-up all Twins
12-0704	6767	Rocker Arm .005 1966-84 Big Twin Rocker Arm .005 1957-84 Sportster
12-0710	—	Same as above .007
12-0715	—	Same as above .015
12-0705	6769	Cam Shaft .007 #1, 3, and 4 Cams 1957-85 Sportster, 1932-73 Flathead
12-0706	6770	Same as above .005
12-0716	6771	Same as above .015
12-0717	6773	Camshaft .005 #2 Cam 1957-85 Sportster, all 1932-73 Flatheads
12-0718	6775	Same as above .010
12-1258	6778	Same as above .015
12-0709	6802	Starter Crank 1954-79 Sportster
12-0712	23741-55	Sprocket shaft bearing .003 1955-84 Big Twin
12-0713	—	As Above .003 1952-76 All XL
12-0714	—	As Above .003 1977-up All XL
12-0708	43560-35	Wheel Hub Shim .007 1935-66 Big Twin
12-9917	—	As Above .015
10-1259	35404-74	Shift Lever Shim .030 1977-up

VT No.	OEM	Item
10-2498	413-30	30-36 74" 80" Right Case
10-2519	416-30	30-36 74" 80" Left Case
10-8524	662-29	30-36 Big Twin and 45 Timer Shaft
10-8525	662-30	30-36 Big Twin and 45 Cam Gear Shaft
10-8526	662-34VL	34-36 Big Twin and 45 Oiler Drive Shaft
10-0700	17428-57	66-up Big Twin 57-up XL Rocker Arm 8 pack
10-0760	24331-36	57-up XL 29-73 45" Std Pstn Pin, pair
10-0762	—	As above .005 Oversize
10-0763	24332-36	As above .010 Oversize
10-0756	24334-36	36-99 Big Twin Std Piston Pin, pair
10-0757	—	As above .002 Oversize
10-0758	—	As above .005 Oversize
10-0759	24335-36	As above .010 Oversize
10-0703	24641-36	36-99 Big Twin Oil Pump Shaft
10-0704	25581-36	41-69 Big Twin Crankcase Cover Gear Standard
10-2524	—	Same as above .005 Oversize
10-0705	25581-70	70-99 Big Twin Crnkse Cover Gear Standard
10-2525	—	Same as above .005 Oversize
10-0706	25582-36	41-54 Big Twin Cover Pinion Shaft Standard
10-2526	—	Same as above .005 Oversize
10-0707	25582-54	54-72 Big Twin Gear Cover Pinion Shaft Standard
10-0708	25582-73	73-92 Big Twin Gear Cover Pinion Shaft
10-2529	—	As above .005 Oversize
10-8536	25582-93	93-up Big Twin Gear Cover Pinion Shaft Standard
10-8556	—	As above .005 Oversize
10-0709	25586-37	57-up XL Cam Gear #1, 3, 4 Cams Cam Cover Front In L Ex Cam 74/80 Side Valve, Front Exhaust Cam 45
10-2540	—	As above .005 Oversize
10-0731	25588-37	45" 74" 80" Cam Cover Rear Intake Cam Side Valve
10-0710	25588-57	57-90 XL Cam Gear #2 Cam Standard
10-2541	—	As above .005 Oversize
10-0711	—	57-90 XL Gear Kit #1-2-3-4 Standard
10-8538	25588-91	91-up XL Gear #2 Cam Standard
10-2507	25590-37	45" 74" 80" Cam Cover Rear EX Cam
10-2512	25591-37	74" 80" Pinion Shaft Side Valve Standard
10-2503	25593-37	Pinion Shaft 45 Side Valve Standard
10-0712	25593-57	57-76 XL Cam Cover Pinion Standard
10-2544	—	As above .005 Oversize
10-0713	25593-74	77-up XL Cover Pinion Standard
10-8268	25594-75	77-81 XL Brk Pedal Operating Shaft
10-2506	25595-37	Cover Front In Cam 45 Side Valve
10-8271	25595-52	52-56 K Exhaust Cam
10-0714	25597-36	36-54 Big Twin Crankcase Cam Gear Standard
10-2527	—	As above .005 Oversize
10-0715	25597-57	57-E84 XL Idler Gear Standard
10-2546	—	As above .005 Oversize
10-2552	25598-91	1991-up XL Inner Cam
10-2504	25599-37	74" 80" Side Valve Crankcase Cam Shaft
10-2495	25601-37A	45 Side Valve Crankcase Cam Sft Bush
10-0716	25785-30A	41-69 Big Twin Idler and Circuit Breaker Gear
10-0749	26431-76	77-90 XL Oil Pump Cover
10-0750	26489-75	77-90 XL Oil Pump Body
10-0742	27290-24	Linkert Throttle Shaft, pair
10-0717	32525-36A	36-39 Big Twin Circuit Breaker Housing
10-0718	33099-52A	56-69 XL Magneto Housing
10-0719	—	54-79 XL Kick Starter Shaft
10-2493	33101-32	54-79 XL Kick Starter Shaft with Seal
10-2494	33213-30	Kick Starter Shaft 45 Side Valve
10-0720	33288-37	Kicker Pedal All Twins
10-0721	33438-50	41-69 Big Twin Kick Start Shaft with Seal
10-2486	—	50-85 Big Twin Mainshaft Starter Gear 4-Speed with Stock Gear
10-0722	33442-57A	As above .005 Oversize for Aftermarket Gear
10-0723	33442-73	57-72 XL Starter Ratchet Gear
10-8527	33445-89	73-79 XL Starter Ratchet Gear
10-8528	33446-89	89-93 Big Twin Prim Housing Starter Shaft
10-2502	33638-52	89-93 Big Twin Prim Housing Starter Shaft
10-2511	33638-70	52-69 FL-FLH Foot Shift Bracket
10-8529	33713-85	70-85 FL-FLH All FXWG-FXST Foot Shift Bracket
10-0724	34037-52	87-up FLT Prim Housing Shifter Shaft
10-2483	34037-75	54-74 XL Shifter Shaft Shifter
10-2518	34427-38	77-85 XL Shaft In Chain Cover
10-0732	34430-36	75-76 XL Shift Pedal Shaft
10-2514	34432-38	(Small) Shifter Shaft 45 Side Valve
10-0725	34435-52	37-76 Big Twin Hand Shift Shifter Shaft
10-0726	34498-52	(Large) Shifter Shaft 45 Side Valve
10-2488	34632-84B	41-79 Big Twin Shifter Shaft
10-0748	34898-79	52-79 Big Twin Pawl Carrier
10-0727	35094-65	84-up FXR All Shifter Shaft
10-2487	—	78 only, All XL Brake Pivot Shaft
		65-85 4-Spd Big Twin Mainshaft Drive Gear
		As above for Andrews Gear only

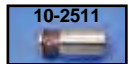
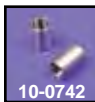





# Gasket

## COPPER HEAD GASKETS

GB No.	James	OEM
15-0739	—	11-30
15-0185	15-1084	16768-36
15-0228	15-1251	16769-36
15-0268	—	16770-36
15-1104	—	—

## CYLINDER HEAD GASKETS

GB No.	James	OEM
15-0574	—	469-15
15-0234	—	16768-39
—	15-1131	16770-36
—	—	16765-53
15-0337	—	16770-48
15-0103	—	—
15-0269	—	—
15-1241	—	—
15-0273	15-1011	16770-66
15-0104	15-1010	—
15-0266	15-0977	—
—	15-1442	—
15-1242	—	—
—	15-0599	Set
15-0366	—	16773-85
—	15-1082	16773-85
—	15-1132	—
—	15-1083	16773-85T
15-0643	—	—
—	15-1219	—
—	15-1443	—
15-1250	—	—
—	15-1196	16775-99
15-1298	—	16775-99B
15-0376	—	16787-99
—	15-1222	—
15-0272	15-1009	—
15-0257	—	—
—	15-0970	16665-86
15-0258	—	—
15-0366	15-1082	16773-86B
—	15-1083	—
—	15-1132	—
15-0643	—	—
—	15-1012	16769-57
15-0355	—	16769-57
15-0101	15-0973	16769-72A
—	15-1130	16769-73T
15-0102	15-0974	16769-73
15-0189	15-1015	16769-82

## CYLINDER BASE

GB No.	James	OEM
15-0412	15-0271	16774-21
15-1290	15-1227	—
—	15-0984	16774-86
15-1420	15-1121	—
15-0284	15-1133	16775-29
15-0725	—	16775-52
15-0107	15-0986	16776-48
15-0108	15-0987	16776-63
15-0109	15-0988	16777-48
15-0110	15-0989	16777-63
15-1289	15-1090	—
—	15-1440	—
15-1580	15-1087	—
—	15-1441	—
15-0222	15-0990	—
15-0235	15-0984	16777-83A
15-0735	15-1072	16774-94
15-0736	15-1101	—
—	15-1247	—
15-0460	—	—
15-1534	—	16789-04

## ROCKER COVER

GB No.	James	OEM
15-0221	14-0673	6114
—	15-1194	16719-99
15-0259	—	16778-84A
—	—	—
15-0251	15-0707	16779-84A
15-1229	15-1245	16800-99X
—	15-1252	16779-84X
15-0252	15-0995	17355-84
15-0651	15-0996	17355-84A
15-0652	15-0999	17356-84A
14-0945	15-0997	17355-92
14-0946	15-1000	17356-92
15-0253	15-0998	17356-84
15-0254	15-1001	17358-84
15-0653	15-1002	17358-84A
—	15-1195	17386-99
14-0172	14-0620	17535-38
15-0075	—	17535-38
15-0076	—	17537-38
15-0077	—	17539-38
—	15-1004	17540-69A
15-0113	15-1136	17540-69
15-1218	15-0705	17540-69X
—	15-1213	17540-99X
—	15-1203	17591-99
—	15-1444	17591-99
—	15-1204	17592-99
—	15-1445	17592-99
11-0584	—	63815-99
15-0663	—	63858-49
15-0112	15-1003	17536-70
15-0640	—	Beaded
—	15-1134	17353-86
15-0260	15-0991	17353-86
—	15-0993	17354-86A
15-0386	15-1135	17354-86A
14-0933	15-0992	17353-89
—	15-1449	17353-04
—	15-0994	17354-89
—	15-1447	17362-07
—	15-1448	17393-07
—	15-1446	17695-07

**Fits**  
 1930-35 74" ,VL  
 1939-73 45"  
 1936-48 74" and 80" Side Valve  
 1936-47 Knucklehead  
 883-1200 XL, .010

**Fits**  
 Knucklehead Rocker Shaft  
 1939-73 45"  
 1936-47 Knucklehead, Teflon  
 165cc  
 1948-65 Teflon  
 As Above Stock Type  
 1948-65 Copper  
 1966-84 Head Fire Ring  
 1966-84 Head Teflon  
 As Above Stock Type  
 1966-84 Multi Layered Steel  
 1966-84 Copper  
 1966-84 3% Big Bore Teflon  
 1984-99 80" Evolution Head, Blue Teflon (.062")  
 As Above Graphite with Fire Ring  
 As Above (.030") Teflon  
 1984-99 80" Evolution Head, Teflon Coated (.045")  
 As Above Graphite Stock Type  
 As Above .045 Blue Teflon Fire Ring  
 As Above Multi Layered Steel  
 As Above Black Teflon Fire Ring  
 1999-2000 Twin Cam 88  
 1999-2000 Twin Cam 88 .045" graphite  
 1999-up Twin Cam 95" (1550 Cylinders)  
 As Above with Armor Coating  
 1948-65 Panhead Fire-Ring  
 86-2000 883 XL Fire Ring™  
 86-87 1100 XL Blue Teflon  
 As Above Fire Ring™  
 88-2000 1200 XL Blue Teflon  
 As Above .045"  
 As Above .030"  
 As Above Graphite  
 1957-71 XL Teflon  
 1957-71 XL Copper  
 1972-E73 XL Copper  
 1973-85 XL Teflon  
 1973-85 XL Copper  
 1973-85 1000 XL Copper (.045")

**Fits**  
 1921-36 Big Twin SV and 1936-47 OHV  
 As Above, Coated Metal  
 1986-03 XL  
 As Above Metal with Silicone Bead  
 1929-73 45"  
 1952-56 K model  
 1948-62 Panhead; front  
 1963-84 Panhead, Shovelhead; front  
 1948-62 Panhead; rear  
 1963-84 Panhead/Shovelhead; rear  
 1948-62 Pan Metal, Silicone Bead  
 1948-62 Pan Foam® Set  
 1966-84 Shovel Metal, Coated  
 1966-84 Shovel Foam® Set  
 1966-84 3% Big Bore Shovelhead, (front or rear)  
 1984-99 Evolution; front or rear  
 1984-99 Evolution Metal with silicone bead (.017 thick)  
 1984-99 Evolution 3% Big Bore Cylinders; front or rear  
 As Above Paper Type without silicone bead  
 As Above, 3% Big Bore Cylinders; front or rear, metal w/fiber  
 2004-up XL

**Fits**  
 1984-99 80 Evolution Top Rocker Cover Washer, Copper  
 1999-up Twin Cam 88 Rocker Housing, Coated Metal  
 1984-99 Evolution Lower Right with Silicone  
 1984-99 Evolution Lower Left with Silicone  
 1984-99 Evolution Lower Left and Right Metal with Rubber Coating  
 As Above Paper with Silicone Beading  
 1984-91 80" Evolution Lower Cork  
 1984-91 80" Evolution Lower Rubber  
 1984-91 80" Evolution Upper Rubber  
 1992-99 80" Evolution Lower Rubber  
 1992-99 80" Evolution Upper Rubber  
 1984-91 80" Evolution Upper Cork  
 1984-91 80" Evolution Inner Cork  
 1984-99 80" Evolution Center Rubber  
 1999-up Twin Cam 88 Rocker Cover, Coated Metal  
 1938-47 Knucklehead Rocker Arm Shaft Housing  
 1938-47 Knucklehead Rocker Cover Front Intake and Rear Exhaust  
 1938-47 Knucklehead Rocker Cover Rear Intake  
 1938-47 Knucklehead Rocker Cover Front Exhaust  
 1966-84 Shovelhead (.30 thickness)  
 1966-84 Shovelhead without Silicone  
 1966-84 Shovelhead with Silicone  
 1966-84 Shovelhead Metal with Silicone  
 1999-up Twin Cam 88 Breather Case  
 As Above Foam®  
 1999-up Twin Cam 88 Breather Baffle  
 As Above Foam®  
 1999-2000 Twin Cam Rocker Cover Breather Element  
 1984-98 Evolution Rocker Cover Bolt Washer  
 1957-84 XL Rocker Cover  
 As Above  
 1986-88 XL Lower Rubber  
 1986-88 XL Lower Cork  
 1986-89 XL Upper Cork  
 1986-90 XL Upper Rubber  
 1989-03 XL Lower Rubber  
 2004-06 XL Rocker Cover  
 1991-06 XL Upper Rubber  
 2007-up XL Rocker Cover Upper  
 2007-up XL Rocker Cover Breather Seal  
 2007-up XL Center Rocker Cover

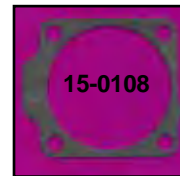
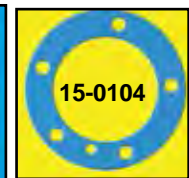
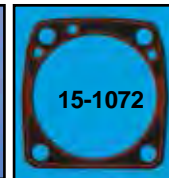
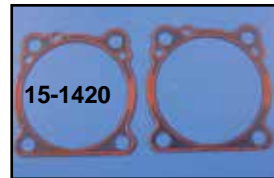
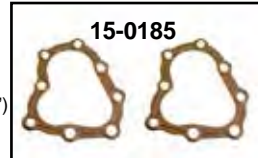

# Gasket



## CAM COVER

GB No.	James	
15-0334	15-0277	24921-37
15-0564	—	25224-52A
15-0300	15-1077	25225-36A
15-0122	15-0928	25225-36C
15-0122	15-0928	25225-36C
15-0122	15-0928	25225-36B
15-0567	—	25225-36B
—	15-1267	25225-36X
15-0390	—	25225-36C
—	15-0929	25225-70A
15-0123	15-1141	25225-70B
15-0741	15-0713	25225-70X
—	15-1434	—
15-0692	15-0930	25225-93
—	15-0722	25225-93X
—	15-1435	—
15-0879	15-0286	25226-37A
15-0407	15-0276	25227-37
15-1501	15-1198	25244-99
—	15-1432	—
15-0153	15-1031	32521-36
15-0154	15-1031	32591-37
15-0339	15-0214	24978-57
15-0121	15-1078	25224-52A
15-0564	—	Pair
15-0124	15-0931	25263-81
15-0245	15-0932	25263-86
—	15-1433	—
15-0308	15-0933	25263-90A
15-0365	15-1223	25263-00

## PUSHROD TUBE

14-0501	14-0904	11101
14-0905	—	11101X
14-0508	—	11118
14-0512	—	11118
14-0514	—	11133
14-0513	—	11133A
14-0550	—	11145
14-0532	—	11157
14-0803	—	11293
15-0116	15-1137	17955-36
14-0028	—	—
15-0348	—	—
15-0117	15-1138	17955-48
14-0029	—	—
15-0349	—	—

## STARTER-GENERATOR

15-0217	15-1143	25811-11
15-0226	15-1021	30138-30
15-0287	15-1022	30143-30
15-0150	15-1023	30143-58
15-0566	—	30143-30
15-0410	—	31015-30
15-0655	15-1024	31320-80
15-0656	15-0966	31321-80
15-0174	15-0916	60518-65
15-0290	15-1064	60559-80
15-0181	15-0917	60645-65

## OIL PUMP

15-0306	—	24990-52
15-0310	—	24994-52
15-0299	15-0935	26231-78
15-0333	15-0275	26244-37
15-0727	—	26245-41
—	15-0126	26245-41
15-0338	15-0274	26246-37
15-0294	15-0940	26246-68A
—	15-0939	26246-68D
15-0127	15-0128	26255-41
15-0740	15-0130	26257-41
15-0131	15-0944	26257-50A
15-0134	15-0948	26258-69
15-0293	15-0949	26258-68B
15-0295	15-0953	26273-80A
15-0177	15-0954	26273-80B
15-0682	15-0954	26273-80B
15-0198	15-0955	26276-80A
15-0296	15-0956	26276-80M
15-0683	15-0957	26276-92

## TAPPET GUIDE

15-0281	—	18245-39
15-0282	—	18257-39
15-0283	—	18259-39
14-0170	14-0621	18260-29
15-0255	—	18630-26
15-0330	15-0278	18631-30
15-0118	15-0925	18632-36
15-0119	15-0926	18633-48A
—	15-1438	18634-48
15-0120	15-0927	18634-48A
—	15-1439	18634-48
15-1542	—	—
—	15-1197	18635-99
—	15-1296	18635-99

## PRIMARY COVER GASKETS

—	15-1253	31434-06
15-0163	15-0909	34901-79
15-0743	15-1115	34901-85
15-0239	15-0904	34901-85
15-0050	—	—
15-0967	15-0937	34901-94A
15-0051	15-1336	—
15-1512	—	34901-07
15-1547	—	34901-07
15-0164	15-1080	34902-79A
15-0165	15-1081	34903-79
15-0229	—	60538-81
15-0176	15-0906	60538-81C
15-0401	15-0900	—
—	15-1338	—
15-0645	—	60539-89
15-0677	15-0902	60539-89X
15-0404	15-0921	60539-94
15-0452	15-1337	—
15-0175	15-0905	—
15-0644	15-1128	60540-36
15-0400	—	60540-65
15-1510	15-1254	60540-65A
15-1525	—	60547-06

1937-73 Flathead Cam Cover Breather  
 1952-56 K, 1957-80 XL  
 1936-40 Knucklehead  
 1941-69 Big Twin  
 1941-47 Knucklehead  
 1941-62 Big Twin  
 1936-47 Big Twin  
 As Above with Silicone Bead  
 1963-69 Big Twin  
 1970-92 Big Twin (white .030")  
 1970-92 Big Twin (black)  
 1970-92 Big Twin with Silicone  
 As Above Foamet® with Silicone Bead  
 1993-99 80" Evolution Big Twin, Black  
 1993-99 80" Evolution Big Twin with silicone  
 As Above Foamet® with Silicone Bead  
 1937-73 45" Flathead  
 1937-48 74" /80" Flathead  
 1999-up Twin Cam 88 Cam Cover Gasket  
 As Above Foamet® with Silicone Bead  
 BT OHV Knuckle Circuit Breaker Base  
 UL and 45 Circuit Breaker Base  
 1957-81 Oil Strainer  
 1954-Early 81 XL Cam Cover  
 1954-Early 81 XL Cam Cover  
 1982-85 XL Cam Cover  
 1986-90 XL Cam Cover  
 1986-90 XL Cam Cover Foamet®  
 1991-up XL Cam Cover  
 2000-up XL Cam Cover w/Bead

Late 1979-E81 Upper O-Ring  
 Late 1979-81 Upper O-Ring (oversized)  
 Late 1979-81 Upper Quad Seal  
 Late 1979-2000 Middle O-Ring  
 Late 1979-E81 Lower O-Ring  
 Late 1981-84 Lower Quad Seal  
 1984-2000 Lower O-Ring  
 11157  
 1984-99 80" Evolution Upper O-Ring  
 1999-2000 Twin Cam 88 Upper O-Ring  
 1936-Early 79 Small Cork  
 As Above Silicone  
 As Above Rubber  
 1948-Early 79 Large Cork  
 As Above Silicone  
 As Above Rubber

Generator stud washer for 1911-85 FL  
 1937-48 Generator End Cover  
 1930-57 Generator Mount Gasket  
 1958-69 Generator Mounting  
 Generator Gasket  
 1930-64 Generator Bearing End  
 1980-86 Belt Drive Starter Housing to Primary  
 1980-86 Belt Drive Starter (between two housings)  
 1965-86 Starter Hole Cover with Kicker only  
 1980-85 Chain Drive Starter Housing Oil Deflector Plate  
 Late 1965-88 Solenoid

1952-57 Tappet Oil Screen Plug  
 1952-92 Tappet Oil Screen Plug  
 1954-80 Oil Pump Cap Washer Blue Teflon  
 1937-59 W/WLA Body to Motor  
 1941-67 FL Oil Pump Body to Case (Mylar)  
 As Above Paper  
 Side valve Scavenger Pump Base  
 1968-80 Body to Motor, Mylar  
 1968-Early 80 Body to Motor, Paper  
 1941-Early 50 Cover (Governor Fitted), Paper  
 1941-Early 50 Cover, Black Paper  
 Late 1950-67 Cover, Black Paper  
 1968-Early 80 Cover, Black Paper  
 1968-Early 80 Cover, Mylar  
 Late 1980-91 Body to Motor, Mylar  
 Late 1980-91 Body to Motor, Black Paper  
 1992-99 80" Evolution Body to Motor, Black Paper  
 Late 1980-91 Cover, Black Paper  
 Late 1980-91 Pump Cover, Mylar  
 1992-99 80" Evolution Cover, Black Paper

1939-48 Flathead Upper Guide Cover  
 1939-48 Flathead Lower Guide Cover  
 1936-48 Tappet Block Fiber Washer  
 1929-68 Flathead Valve Spring Cover Seal  
 1926-73 45" Flathead Spring Cover  
 1930-73 Flatheads, Tappet Guide  
 1936-47 Overhead Valve Tappet Guide  
 1948-99 Rear Tappet Guide  
 1948-99 Rear Tappet Guide Foamet®  
 1948-99 Front Tappet Guide  
 1941-48 Front Tappet Guide Foamet®  
 1948-99 Set  
 1999-2000 Twin Cam 88 Tappet Cover Gasket  
 1999-up Twin Cam 88 Tappet Cover Gasket with Foamet®

2007-up Big Twin Inner Primary Mounting Bolt  
 1980-93 FXR/FLT Primary Cover (.030")  
 1980-93 FXR/FLT Primary Cover (.062")  
 1983-93 FXR/FLT Primary Cover (.062"), Beaded  
 As Above Metal with Foam Rubber Coating  
 1994-2006 FXR/FLT Primary Cover  
 As Above Metal with Foam Rubber Coating  
 2007-up FLT, Touring  
 2007-up FLT  
 1980-84 FXR/FLT Primary to Trans (large)  
 1980-84 FXR/FLT Primary to Trans (small)  
 1982-88 Rigid Mount Primary Cover 1/16" thick 9 hole  
 As Above 1/32" thick  
 Late 1982-88 Rigid Mount 9 Hole Primary, Beaded  
 As Above, Foamet® with bead  
 1989-93 Softail, Dyna Primary Cover (.062)  
 1989-93 Softail, Dyna Primary Cover, Beaded  
 1994-06 Softail, Dyna Primary Cover Beaded  
 As Above Metal with Foam Rubber Coating  
 1936-64 Primary Cover, cork  
 1965-80 FX/FL Primary Cover (8 hole)  
 1965-82 4 Speed, 8 hole Primary Cover Beaded  
 2006-up FXD Beaded, 2007-up FXST Primary Cover Beaded  
 Inner Primary Gasket

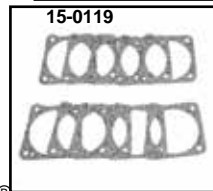
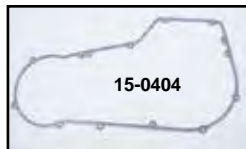
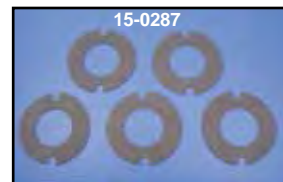
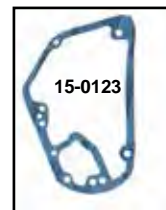
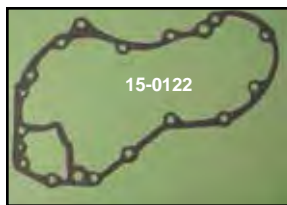





# Gasket

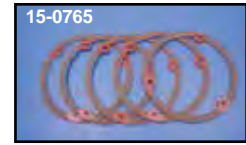
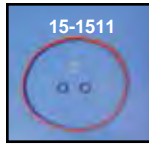
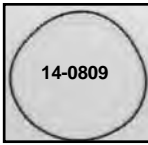

## DERBY COVER Gaskets

GB No.	James
15-1511	—
15-0125	15-0934
15-0882	—
—	15-1142
15-1249	—
—	15-1422
15-1248	—
—	15-1279
15-0765	15-0701
14-0535	—
14-0809	—
15-1286	15-1224
15-0883	—
37-8868	15-1150
37-8931	15-1151
15-0177	15-0919

OEM
17369-06
25416-70
25416-70B
25416-70-C
25416-99D
25419-99D
25416-70C
—
25416-70X
25416-84
25416-99A
—
25416-99B
31433-84
31433-84A
60565-36

Fits
2006-up FXD Derby
1970-Early 84 Derby Cover (.030")
1970-Early 84 with Bead
1970-Early 84 Derby Cover (Cork, .030")
1999-up Derby Beaded
1999-up Derby Foamet® with bead
1970-98 Derby Beaded
1970-98 Derby Molded Rubber
1970-Early 84 Derby Cover Gasket, Beaded
1985-98 Derby Cover O-Ring
1999-up TC-88 Derby Cover Seal
As Above Gasket with Silicone
1999-up with Bead Gasket
1984-98 Derby Cover Bolt Washer, Nylon
1984 98 Primary Cover Bolt Washer with Seal
1936-64 Derby Cover, Cork



## INSPECTION COVER Gaskets

GB No.	James
15-0167	15-0922
—	15-0704
15-0238	15-0702
—	15-1202
—	15-1278
—	15-0916
15-0178	15-0920
—	15-0700
15-0179	15-0915
15-1217	15-0703
—	15-0465
—	15-1421
15-0408	15-0180
—	15-1161

OEM
34906-79
34906-79A
34906-85
34906-85A
—
60518-65
60567-36
60567-65
60567-65C
60567-90
60567-90
60567-90
60629-55
63859-95

Fits
1980-84 FXR/FLT Inspection Cover (.030")
1980-84 FLT/FXR Inspection Cover (.062"), Beaded
1986-up FLT/FXR Inspection Cover with Bead
1986-up FLT/FXR Inspection Steel Core, two side bead, .045", beaded
As Above Metal with Molded Rubber
1965-69 Starter Plate
1936-64 Primary Inspection Cover, Cork
1965-84 4 Speed, 1991-up Dynaglide and 1984-up Softail Inspection Cover (.062") beaded on two sides
1965-84 4 Speed, Dynaglide and Softail Inspection Cover (.032")
1965-84 4 Speed, Dynaglide and Softail Inspection Cover(.062") beaded on one side
1965-84 4 Speed, 1991-up Dynaglide and 1984-up Softail Inspection Cover Metal with rubber coating
1965-84 4 Speed, 1991-up Dynaglide and 1984-up Softail Inspection Cover Foamet® w/bead
1955-64 Inner Primary to Crankcase
1994-up FXST/Dynaglide Inspection Cover Mounting Screw

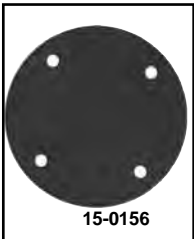
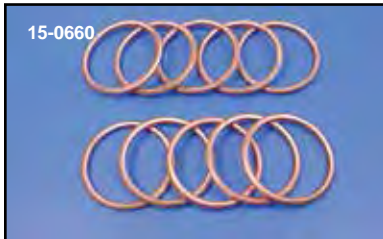

## EXHAUST

GB No.	James
15-0267	—
15-0227	15-0712
15-0732	—
15-0696	15-0968
—	15-1076
15-0191	—
15-0197	—
15-0198	—
—	15-1074
15-0195	15-1073
15-0196	—
15-0660	15-1098

OEM
65324-83
65324-83A
—
65721-85
65826-90
65834-68
65834-68A
—
65834-68C
65834-68C
—
—

Fits
1984-2000 Exhaust Port Mesh Type
1984-2000 Graphite Exhaust Port Tapered
As Above, 10 pack
1985-94 FLT Muffler junction
1991-2000 Dyna Glide Exhaust interconnect
1966-84 Shovelhead (plain)
1966-84 Shovelhead (all copper)
As Above, 50 pack
1966-84 Shovelhead Steel Core
1966-84 Shovelhead Fire Ring™, 10 pack
As Above, 50 pack
1966-84 Shovelhead Copper Donut



## IGNITION COVER/DISTRIBUTOR BASE

GB No.	James
15-0149	15-1020
15-0153	15-1030
15-0154	15-1031
15-0155	15-1032
15-0156	15-1033

OEM
29550-55
32521-36
32591-70
32591-70
32591-80

Fits
Magneto Cap
1936-64 Distributor (base)
1937-48 Flathead Circuit Breaker
1970-79 Point Cover
1980-99 Point Cover 4 hole

# Gasket



## TRANSMISSION

GB No.	James	OEM	Fits
14-0922	15-1129	6007	1980-up Transmission Drain Plug Nylon
—	15-1272	As Above	Rubber Bonded Washer
15-0411	—	2261-31	1930-36 VL Top Cover
15-0217	15-1143	25811-11	1952-85 Neutral Switch
—	15-1116	26072-90A	1991-98 Dyna Glide Oil Pan
—	15-1205	26072-90X	1991-98 Dyna Glide Oil Pan with Silicone Bead
—	15-1240	26072-99	1999-05 Dyna Glide Oil Pan with Silicone Bead
—	15-1117	26077-93	1993-99 FLT Oil Pan Transmission Housing
—	15-1206	26077-99	1999-2000 FLT Transmission Oil Pan Gasket
15-0685	—	33043-80	1980-97 Neutral Switch
15-0157	15-1034	33196-79	Late1979-86 4 Speed Side Shifter Shaft Cover
15-0158	15-1035	33295-36	1936-86 4 Speed Kicker Cover
—	15-0595	33295-36X	1936-86 4 Speed End Cover with Silicone
14-0633	14-0826	34459-26	Leather Shifter Shaft Washer
15-0331	15-0279	34825-41	1941-73 45" Top Cover
15-0332	15-0280	34826-41	1941-73 45" Side Cover
15-0159	15-1036	34552-52	1952-Early79 Shifter Cover
15-0160	15-1037	34565-52	1952-Early79 Shifter Adapter Plate to Transmission
15-0161	15-1038	34824-36	1936-Early79 4 Speed Shifter Cover Ratchet Lid
15-0162	15-1039	34824-79	Late1979-86 4 Speed Shifter Cover Ratchet Lid
15-0166	15-1040	34904-79	1980-85 5 Speed Transmission Top Cover
15-0237	15-1041	34904-86C	1986-2000 5 Speed Transmission Top Cover
15-1505	—	34904-86C	1986-06 Softail Top with Bead
—	15-1231	34917-90A	1991-98 FXD Top Cover with Bead
—	15-1049	36025-36	Countershaft End Plug
15-0184	15-1070	67141-36	1937-84 Speedometer Drive Unit

## 1999-UP TRANSMISSION GASKETS FOR TC-88. JAMES BRAND UNLESS NOTED.

GB No.	James	OEM	Fits
—	15-1129	6007	Nylon Drain Plugs
—	15-1116	26072-90A	1991-98 Dynaglide Trans Oil Pan
—	15-1205	26072-90X	As Above Silicone Beaded
—	15-1240	26072-99	1999-05 FXD Oil Pan Gasket
—	15-1117	26077-93	1993-98 FLT Trans Oil Pan
—	15-1206	26077-99	1998-06 TC-88 FLT Oil Pan
—	15-1041	34904-86	1986-06 Big Twin Trans Top Cover
—	15-1118	34917-90A	1991-98 Dynaglide Transmission Top Cover
—	15-1231	34917-90X	1991-87 FXD Transmission Cover Gasket with Silicone Bead
—	15-1232	34917-99	1999-05 FXD Transmission Top Cover with Silicone Bead
—	15-1257	34917-06X	Trans Top Cover 06-up Dynaglide, 07-up Big Twins with Silicone Bead
—	15-1258	34917-06	As Above Metal with Foam Rubber Coating
—	15-1263	35607-06	Transmission to Engine Interface 2006-up Dyna, 2007-up Big Twin
—	15-1048	35652-79A	1979-06 Big Twin 5 Speed Bearing Gasket
—	15-1207	35652-79X	1979-06 5-Speed Bearing Housing Gasket with Silicone Bead
15-1535	15-1259	35654-06-X	Bearing Housing 2006-up Dynaglide, 2007-up FXST with Silicone Bead
—	15-1260	35654-06F	As Above Metal with Foam Rubber Coating
—	15-1233	36801-79X	1979-85 FLT-FXR Clutch Release Cover with Silicone Bead
—	15-1230	36801-87X	1987-06 Big Twin Clutch Release Cover with Silicone Bead
15-1529	15-1261	36805-06X	Clutch Release Cover 2006-up Dyna, 2007-up Big Twin with Silicone Bead
—	15-1262	36805-06F	As Above Metal with Foam Rubber Coating
—	15-1155	37091-80	5 Speed Filler Plug Gasket
—	15-1120	62432-93	1993-up FLT Transmission Oil Washer
—	15-1275	63869-06	2006-up FXD Inner Chain Housing Shifter Shaft

## GLIDE/FLT

GB No.	James	OEM	Fits
—	15-1118	34917-90A	1991-98 Dynaglide Transmission Top Cover
—	15-1231	—	As Above with Silicone Bead
—	15-1232	34917-99	1999-05 Transmission Top Cover with Bead
15-0213	15-1048	35652-79A/B	1980-98 5 Speed Bearing Housing to Case
—	15-1207	35652-79X	1980-98 5 Speed Bearing Housing to Case with Silicone
15-1500	—	35653-98	1999-06 TC-88 Door
15-0171	15-1049	36025-36	1937-64 Countershaft End Cap
15-0172	15-1050	36801-79	1980-86 5 Speed Release End Cover
15-0346	15-1233	—	1980-86 5-Speed Release/End Cover with Silicone Bead
15-0240	15-1051	36801-87B	1987-06 Release/End Cover
—	15-1230	—	As Above with Silicone Bead
15-0225	15-1052	36821-68	1968-69 FL Transmission Cover Plug
—	15-1155	37091-80	1980-86 5 Speed Filler Plug
15-1538	—	62423-90	1990-99 FXD Filler
—	15-1120	62432-93	1991-2000 FLT, FXD Transmission Oil Sprout
15-0194	15-1158	62702-52	1941-86 Drain Plug Washer
15-0184	15-1070	67141-36	1937-84 Speedometer Drive Unit

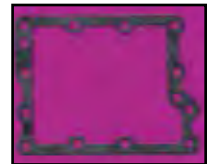

15-0161



15-0158

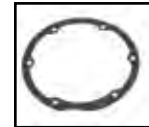

15-0159



15-0160



15-0157

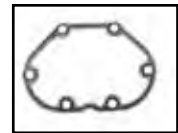

15-0240



15-0346



15-0172



15-1529





# Gasket

## GAS TANK/OIL TANK GASKETS

GB No.	James	OEM	Fits
14-0561	15-1065	61109-85	1983-up Gas Cap
—	15-1066	61111-77	1977-82 Gas Cap
15-0756	—	61114-36	1936-47 Gas Cap
—	15-1156	61114-48	1941-82 Gas Cap Thin
15-0183	15-1067	61116-65	1965-82 Gas Cap Left
15-0265	15-1068	62172-75	1975-up Fuel Valve
15-0676	15-1157	62270-32	1932-65 Fuel Strainer
15-0341	—	62617-52	1952-64 XL Oil Tank Cap
15-0192	—	62628-36	1936-64 Oil Tank Cap Copper Filled Style
15-0329	15-0200	62628-52	1952-65 XL Oil Tank Cap
15-0328	15-0201	62628-66	1966-82 Big Twin, 1966-79 XL Oil Tank Cap
—	15-1159	63809-48	1948-64 Oil Filter Cap
—	15-1378	63809-48	As Above Molded Rubber
—	15-1160	63848-48	1948-64 Oil Filter Cap Retainer



15-0756

## MASTER CYLINDER & RESERVOIR TOP GASKETS

Front	OEM	Year/Type
15-0188	45012-72	1972-81 Master Cylinder
15-0204	45012-82	1982-84 Master Cylinder
15-0242	45005-85	1985-95 Master Cylinder
15-0250	45005-96	1996-up Master Cylinder
Rear		
15-0202	41766-58	1958-78 Master Cylinder Top
15-0203	42455-80	1979-84 Master Cylinder Top
15-0248	42455-82	1982-84 Reservoir
15-0540	42455-99	2000-up Reservoir
15-0242	45005-85	1985-95 Master Cylinder Top

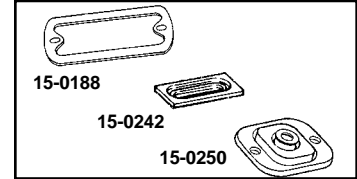

15-0188

15-0242

15-0250

## TURN SIGNAL/FENDER LIGHT/ TAILLIGHT GASKETS

GB Stock	GB Beaded	OEM	Fits
15-0325	15-0291	5056-39	1939-46 Beehive Mounting
15-0695	—	59181-80	Fender Tip Lens Front
—	15-0289	59266-68	1982-84 Front Fender Lamp
15-0303	—	67716-60A	1960-84 FL Head Lamp Mounting Ring
15-0320	—	67734-35	1935-48 Head lamp Lens
15-0206	—	68025-73	1973-up Tail lamp Lens
15-0413	—	68121-47	1947-54 Tombstone License Plate Lens
15-0302	—	68121-55	1955-72 Tail Lamp Top Lens
15-0305	—	68122-47	1947-54 Tail Lamp Lens
15-0301	—	68122-55	1955-72 Tail Lamp Lens
15-0323	15-0208	68123-47	1947-54 Tail Lamp Mounting
15-0322	15-0209	68123-55	1955-72 Tail Lamp Mounting
15-0224	15-0207	68123-73	1973-up Tail Lamp Mounting
15-0718	—	68125-25	1925-54 Tail Lamp Lens
15-0719	—	68126-36	1936-54 Tail Lamp Lens Inner
15-0724	15-0205	68459-47	1935-49 Front Fender Lamp Mounting
15-0742	—	68121-68	1968-85 FL Turn Signal Lens
15-0409	—	68124-39	1939-46 Tail Lamp Mounting
15-0667	—	68127-42	1942-46 Tail Lamp Top Lens
15-0342	—	68226-97	1997-up Tombstone
15-0723	—	68456-35	Front Fender Lamp
15-0678	—	68456-89	License Plate Mounting Bracket
15-0187	—	68481-73	1973-85 FX-XL Turn Signal Lens
15-0665	—	—	Cateye Tail Lamp Lens
15-0709	—	—	Sparto Tail Lamp Mounting

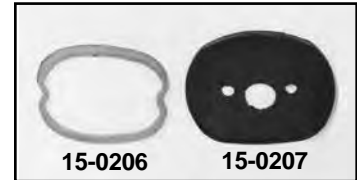

15-0206

15-0207

# Base and Head Gasket



15-0487



15-0475



15-1298

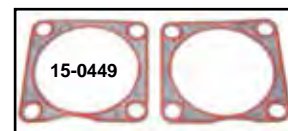

15-0449

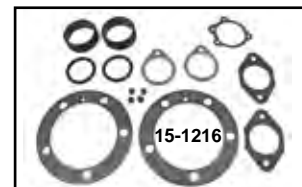

15-1216

## GB Cylinder Base Gaskets for XL

Size	3 1/2" Bore	3 3/8" Bore	3 13/16" Bore	3 3/4" Bore
1986-99 XL, 883-1200				
.010	15-0487	15-0489	—	—
.020	15-0488	15-0490	—	—
Head Gaskets 1986-99 XL				
.030	15-0475	15-0477	15-0479	15-0481
.040	15-0476	15-0478	15-0480	15-0482

Cylinder Gasket Set include head and base gasket for Evolution, with .040 head gasket.

15-0389	Metal Base
15-0392	Beaded

## Base Gasket Sets

VT No.	Brand	Size	Fits
15-0449			1936-52 W, 1935-75 G
15-1298	V-Twin		1996-up TC-88
15-0312	GB		1984-99 Evo 80"
15-0313	GB		1986-1991 XL
15-0414	James	.045"	1984-98 FXST, FLT, 1991-98 FXD, 84-94 FXR
15-0877	James	.062"	1984-98 FXST, FLT, 1991-98 FXD, 84-94 FXR
15-0376	V-Twin		1999-up FXST, FLST, FLT, FXD
15-1234	James	.045"	Special application for S&S 4" bore cylinders
15-1235	James	.045"	1999-up FXST, FLST, FLT, FXD
15-1293	GB .045		1999-up FXST, FLST, FLT, FXD
15-1216	Fire Ring		1966-84 FL, 1971-84 FX, 79-83 FLT, 82-83 FXR
15-0887	Fire Ring		1966-84 FL, 1971-84 FX, 79-83 FLT, 82-83 FXR
15-1193	Metal		1948-62 FL

All Service Products which include gaskets, pins bolts, rollers, bulk packs, hardware will be available for replacement only. No credit will be issued.

# Gasket



## CARB, AIR CLEANER AND MANIFOLD, BIG TWIN

GB No.	James	OEM	Fits
14-0180	14-0625	27002-89	1988-2000 Carburetor to Intake
15-0139	15-1085	27023-71	1971-75 Bendix Intake to Carburetor
15-0142	15-1086	27077-78	1978-89 Keihin Intake to Carburetor
—	15-1144	27077-78X	1979-89 Intake to carburetor
15-0744	—	27205-57	Linkert DC Body
15-0745	—	27329-57	Linkert DC Nozzle Vent
15-0746	—	27374-57	Linkert DC Float Bowl Nut
15-0232	15-1088	27376-28	1928-65 Float Bowl Lock Nut Gasket
15-0321	—	—	1952-65 Linkert Float Bowl
15-0747	—	27376-57	Linkert DC Float Bowl
15-0748	—	27386-57	Linkert DC Valve Seal
15-0304	15-1089	27391-36	1936-65 Float Bowl (Linkert)
14-0926	—	27402-33	Linkert Needle Valve
—	15-1145	27403-71	1971-75 FX/FL Main Jet Washer
15-0336	—	27410-21	Linkert Carburetor to Manifold 3 Bolt
15-0288	—	27410-29	Manifold, 1"
15-0146	15-0964	27414-61	2-Hole Manifold
15-0264	15-1091	27410-39	Linkert 3 Bolt 1.25
15-0144	15-1092	27410-57	1966 Intake to Carb
15-0145	15-1093	27411-40	1940-65 Big Twin Linkert to Carburetor
15-0262	—	27412-48	1948-65 Big Twin Linkert Carburetor Spacer
15-0147	—	27646-71	1971-76 Bendix Float Bowl
15-0148	15-1146	29058-77	L1977-89 Air Cleaner to Carburetor
—	15-1016	29058-77A	L1977-89 Air Cleaner to Carburetor (.062")
15-0285	15-1017	29059-88	1990-99 80" Evolution Air Cleaner to CV Carburetor
—	15-1148	29059-88A	1990-99 80" Evolution Air Cleaner to Carburetor, Adhesive
—	15-1147	29059-88X	1990-99 80" Ev Air Cleaner to Carburetor, Steel Core
—	15-1199	29062-95B	1999-2000 Twin Cam 88 Carburetor Back Plate Gasket
—	15-0596	29095-95	1995-99 FL Air Cleaner Back Plate
15-0263	15-1018	29242-83	1984-89 Compliance to Head
15-0141	15-1019	29250-78	Insulator Block, Carburetor to intake, Keihin/Bendix
—	15-1149	29313-95	1995-2000 Air Cleaner backplate
15-1536	15-1200	29368-99	1999-2000 Twin Cam 88 Induction Module Gasket
15-1537	15-1201	29463-99	1999-2000 Twin Cam 88 EFI Filter Element Gasket
15-0676	15-1157	62270-32	Fuel Strainer



Cometic AFM Gaskets feature a chemically blown compound nitrite synthetic rubber bonded to an aluminum core that has a temperature resistance of over 2500 degrees F. AFM does not require gasket sealers or silicone bead and re-torque of mounting bolts is not required.

### Big Twin Primary Gasket and Seal Kits

VT No.	Fits
15-1300	2006-up Dynaglide, 2007-up FXST
15-1326	2007-up FLT
15-1301	1994-06 FXST, 1994-05 Dynaglide
15-1302	1989-93 FXST, FXD
15-1303	1994-06 FLT, FLHT, FXR
15-1304	1980-93 FLT, FLHT, FXR
15-1305	1965-88 FX, FL, FXST

### Big Twin Primary Gasket

15-1327	2007-up FLT
15-1306	2006-up Dyna, 2007-up FXST
15-1307	1989-06 FXST, 1989-05 Dyna
15-1308	1994-up FLT, FXR
15-1309	1980-93 FLT, FXR
15-1310	1965-88 FX, FL, FXST

### Big Twin Primary Inspection Cover Gasket

15-1311	1965-up FX, FL, FXST, 1989-05 Dyna
15-1312	1985-up FLT, FXR

### Big Twin Derby Gasket

15-1313	2006-up Dynaglide, 2007-up All Twin Cam (O-Ring)
15-1314	1999-up FXST, FLT, FXD (Replaces O-Ring)
15-1328	1984-98 All Big Twins (Replaces O-Ring)
15-1315	1970-83 FX, FL

### Big Twin Cam Cover Gasket

15-1316	1999-up Twin Cam
15-1317	1993-98 Evolution
15-1318	1970-92 Shovelhead & Evolution

### Sportster Primary Gasket and Seal Kits

15-1319	2004-up All Models
---------	--------------------

### Sportster Primary Gasket

15-1320	2004-up All Models
15-1321	51991-03 All Models
15-1322	1986-90 All Models

### Sportster Cam Cover

15-1323	2004-up All Models
15-1324	1991-03 All Models
15-1325	1986-90 All Models

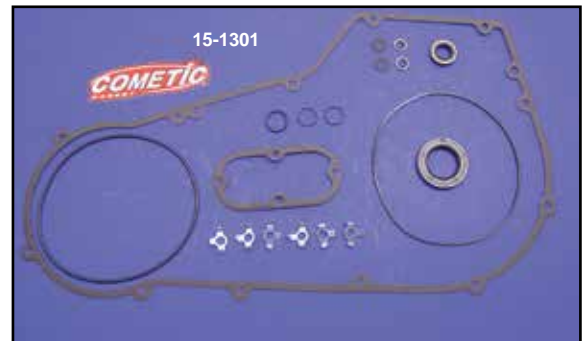





# O-Ring

Sold in 10 packs unless noted.

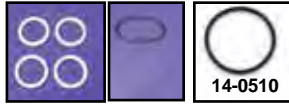

VT No.	OEM	Fits
14-0500	11100	1957-85 XL Tappet Guide
14-0501	11101	1957-85 XL, 1966-86 Shovelhead Rocker Shaft
14-0148		1957-85 XL, 1966-86 Big Twin Shovelhead No Leak Rocker Arm Seals
14-0904	11101	1966-84 Shovelhead, 1957-85 XL Rocker Arm, 100 pk
14-0905	11101X	As above Oversize, 100 pack
14-0527	11102	1966-69 XLH Timer Housing
14-0502	11103	1957-66 XL, 1967-69 XLCH Clutch Gear
14-0503	11105	1966-82 74" & 80" Oil Tank Cap 1970-99 Big Twin Tappet Screen Plug
14-0504	11106	1971-78 XL Primary Cover Filler Cap
14-0505	11107	1966-71 XL, 1967-70 FL Carburetor Adapter
14-0506	11110	1986-90 XL Tappet Guide Mt Screw 1962-69 XL Tach Plug
14-0507	11115	1965-85 FL-FX 4 Speed Trans Countershaft
14-0537	11116	1981-90 XLH Starter Motor Housing
14-0538	11117	1984-up FXR Shifter Lever Sleeve
14-0508	11118	1981-85 Big Twin, Quad, Flat Pushrod O-Ring Small
14-0509	11119	1967-70 XLH, 70 XLCH Clutch Gear
14-0510	11123	45" S.V. Valve Spring Cover
14-0511	11125	1970-82 74", 80" except FXB In. Prim.
14-0512	11132	1979-E81 74" Pushrod Middle 1984-up V2 Big Twin XL O-ring
14-0513	11133A	Late 1981-85 80" quad FLT Pushrod large
14-0514	11133	Late 1979-E81 74" and 80" Pushrod Low
14-0907	11133	As above, 100 pack
14-0515	11139	Late 1978-90 XL Primary Filler Cap
14-0539	11140	1984-up FLT Front Fork Air Control
14-0550	11145	1984-up V2 Big Twin, 1986-90 XL, quad Lower Pushrod Cover
14-0531	11147	1984-99 Big Twin Inner Chain Housing
14-0556	11148	1986-90 XL quad Oil Filter Mount
14-0540	11156	1984 FLT Front Fork Air Control Solenoid
14-0532	11157	1984-up V2 Big Twin, 1986-90 XL, O-Ring Upper Pushrod Cover
14-0908	11157	As above 100 pack
14-0541	11159	1984-85 FXST Oil Tank Fitting
14-0542	11162	1982-84 FXR-FLT Mainshaft Right
14-0534	11165	1984-up Big Twin 5-speed Quad Mainshaft Ball Bearing Clutch Side
14-0543	11166	1985-86 FXWG-FXEP 4 Speed Countershaft
14-0544	11167	1986-90 XL Tappet Guide, Upper
14-0545	11168	1986-90 XL Tappet Guide, Lower
14-0546	11170	1984-99 FLT-FXRT Front Fork Air Cap
14-0547	11171	1985-99 FLT-FXRT Front Fork Air Control Solenoid
14-0554	11173	1987-99 FLST Wheel Hub Cap
14-0910	11174	1987-94 FXR Fuel Tank
14-0911	11176	1991-99 XL Pushrod Anti-rotation 1989-up FLTCU-FLHTCU Radio knob
14-0552	11178	1982-up Big Twin Transmission Filler Plug
14-0553	11179	1987-up Big Twin, 86-up XL Clutch Cable End
14-0916	11187	1991-up XL Clutch Inspection Cover
14-0917	11188	1991-up XL Chain Inspection Cover
14-0912	11190	1991-up XL Pushrod Cover
14-0913	11191	1990-up FXST-FLST Shifter Lever
14-0583	11201	2006-up Main Drive
14-0974	11241	1992-99 Big Twin Oil Pump End Cap
14-0800	11256	1999-up TC88 Cylinder Base
14-0801	11270	1999-up TC-88 Rocker Arm Support
14-0802	11273	1999-up TC-88 Cylinder Head Locating Dowel
14-0814	11286	1999-up TC-88 Oil Pump Outer
14-0815	11288	1999-01 TC-88 Cam Position Sensor
14-0816	11289	1999-up TC-88 Crankshaft Sensor
14-0817	11290	1999-up TC-88 Neutral Switch
14-0975	11292	1999-up FL Breather Bolt O-Ring
14-0803	11293	1999-up TC-88 Upper Pushrod Cover
14-0818	11297	1999-up FLT Fork Air Control
14-0819	11298	1999-up TC-88 Cam Support Plate Plug
14-0820	11301	1999-up TC-88 Oil Pump Inner
14-0933	17353-89	1989-03 Rocker Box Lower
14-0934	17354-89	1989-03 Rocker Box Upper
14-0535	25416-84	1985-98 FX-FXE-FXR-FLT-FXST Clutch Cover
14-0809	25416-99	1999-up BT Clutch Cover
14-0570	25463-94	1994-up XL Primary Derby (5 pack)
14-0516	26432-76A	1977-85 XL Oil Pump Body 1986-up XL Cylinder Stud Insert
14-0517	26433-77	1977-85 XL Oil Pump Check Valve 1986-90 XL Oil Filter Check Valve
14-0518	26434-76A	1977-85 XL Oil Pump Cover
14-0914	26434-91	1991-up XL Oil Pump



14-0165	26995-86A	1991-up XL Intake Manifold
14-0519	27060-55	1955-77 FL-FX-XL Intake Manifold
14-0915	27157-89	1990-up All Twins Carburetor Drain Screws
14-0560	27324-83	1983-87 Twins Keihin Carburetor Float Bowl, 5 pk
14-0520	27326-71	Bendix Main Jet
14-0521	27336-76	1976-78 FL-FX-XL Carburetor Flange
14-0559	27358-76	1976-78 Twin Keihin Carburetor Float Bowl
14-0564	27577-88	1987-91 All Twins Float Bowl
14-0937	27577-92	1992-up All Twins Float Bowl
14-0557	27889-78	L78-82 Twin Keihin Carburetor Float Bowl
14-0528	29603-48	1965 only FL Timer Housing
14-0949	31695-90	1990-up Twins Starter Motor Twins
14-0960	33340-90	1990-93 Big Twin Starter Shaft
14-0533	34036-80	1980-85 Big Twin 4 speed Shifter Cam
14-0572	43947-79	1981-99 FL Caliper Piston
14-0563	44059-83	1983-99 FXR-FXST-XL Front Caliper
14-0555	44152-77	1979-81 XL Rear Caliper Piston
14-0551	44277-74	1974-77 FX-XL Caliper Piston Front
14-0536	45443-86	1984-up FLT-FLHT Front Fork Upper Plug
14-0522	45780-52	1954-70 XL-FX Fork Tube Cap
14-0523	45845-77	Late 1977-85 FL, 1980-85 FXWG 1984-up FXST-FLST Fork Tube Plug
14-0524	45982-73	1973-86 FX-FXR-FXRT-FXRS-FXRT XL-XLS-XLX Slider Tube Cap
14-0558	45984-87	1987-up FXR-XL Fork Tube Plug
14-0901	49028-85T	Large O-Ring Pegs, 100 pack
14-0900	49031-84T	Small O-Ring Pegs, 100 pack
14-0902	49029-85T	Flat Kick Pedal, 100 pack
14-0903	49030-84T	Shifter Peg, 100 pack
14-0561	61109-85	1983-up Twins Gas Cap
14-0525	62094-40	1940-65 45", 61", 74" Gas Tank Shut-off
14-0530	62360-50	1950-65 Big Twin Fuel Line
14-0529	63529-50	1949-64 FL Filter Oil Line
14-0147	63529-57	Rocker Oil Line Seal, 100 pk
14-0526	63879-53	1958-82 Big Twin, 67-78 XLH Oil Filter Cap
14-0562	68425-86	1986-up Twins Turn Signal Lens Screw
14-0548	68451-86	1986-up FLT-FLST-FXRT Front Turn Signal
14-0549	68455-86	1986-up FXR-XL Front and Rear Turn Signal Lens, FXST-FLST-FXSTC Rear only

### 100 Pack O-Rings

14-0904	11101	1966-84 Rocker Arm
14-0905	11101X	As above Oversize
14-0906	27060-55	1955-77 Manifold
14-0147	63529-57	Oil Line Seal
14-0907	11133	Lower Pushrod Cover
14-0908	11157	Upper Pushrod Cover
14-0901	49028-85T	Large O-Ring Pegs
14-0900	49031-84T	Small O-Ring Pegs
14-0902	49029-85T	Flat Kick Pedal
14-0903	49030-84T	Shifter Peg

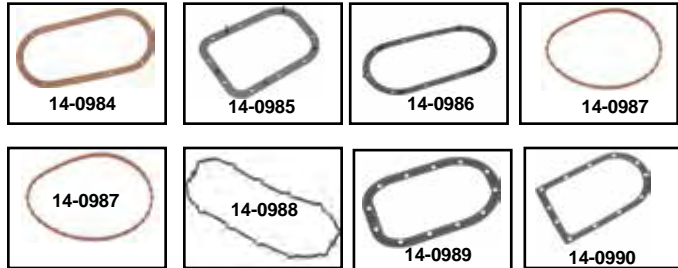

VT No.	OEM	Description
14-0984	61326-95	Top Plate Cork Gasket
14-0985	61381-02	Top Plate Gasket
14-0986	61402-08	Top Plate Gasket
14-0987	61402-02	Top Plate Gasket
14-0988	61402-08	Seal, Top Plate
14-0989	75245-04A	Seal, Fuel Tank
14-0990	75249-04A	Seal, Fuel Tank
14-0991	75301-07	Seal, Fuel Pump, Plate
14-0992	11324	O-ring 7.00 x 1.50 MM
14-0993	11345	O-ring
14-0980	12068	Oil Seal
14-0994	27444-00	O-ring
14-0995	34990-08	Gasket, Chain Inspection
14-0996	62673-90	O-ring FXDS
14-0997	11120	O-ring Dipstick



Seals are sold 5 pack unless noted other in U/M price list.

James	VT No.	OEM	Fits
—	14-0164	1400	1983-up Big Twin Evolution, TC-88, 1986-up XL Evolution Valve Guide, 10 pack
—	14-0143	1404	1954-85 XL Model Valve Guide Intake, 10 pack
—	14-0144	1405	1954-85 XL Valve Guide Exhaust 10 pack
—	14-0145	1408	1948-78 BT Valve Guide Intake-Exhaust 10 pack
—	14-0146	1427	1979-85 BT Shovelhead Valve Guide Intake/Exhaust, 10 pk
—	14-0255		1948-84 Big Twin Teflon Valve Guide
—	14-0256		1984-up Big Twin Teflon Valve Guide
14-0673	15-0221	6114	1984-99 All Twins Rocker Cover Copper
—	14-0031	6156	1941-69 Big Twin Chain Oiler Adj Screw
—	14-0178	6375	1946-57 Big Twin Oil Press Switch
—	14-0033	6377	1950-84 Big Twin Oil Pump Fitting
—	14-0032	6581	1954-78 Big Twin Oil Pump Relief Valve Plug
14-0674	—	7019	1991-up XL Shifter Lever
—	14-0100	11124	1954-up XL Cam Cover
14-0600	—	As Above	Double Lip
14-0675	14-0556	11148	1982-84 Big Twin Shifter Shaft
14-0687	—		Map Sensor 1999-up TC-88
14-0601	14-0101	12002	1961-73 XL, 1961-69 FL Generator Cover
14-0602	14-0102	12010	1979-85 4 Speed Big Twin Foot Shifter Cover
14-0603	14-0106	12013A	Late 1966-90 Big Twin 74"-80" Drive Gear
14-0604	14-0103	12014	1965-84 4 Speed Big Twin 74"-80" Clutch Nut
14-0605	14-0104	12018	1970-85 4 Speed Big Twin Inner Chain Housing
14-0606	14-0105	12021	1967-70 XLH Clutch Gear
14-0607	14-0107	12023	1962-69 XL Magneto Mount Plate
14-0608	14-0108	12026A	1970-99 74"-80" L Engine
14-0676	—	12026A	As Above Double Lip
14-0609	14-0918	12030	1991-99 5 Speed Trans Bearing
14-0821	14-0919	12035A	1991-06 Big Twin Mnsht 5th Gear
14-0821	14-0824	12035B	As Above Double Lip Metal
14-0611	14-0109	12036A	1977-90 XL Oil Pump
14-0612	14-0110	12043	1980-84 FLT-FXR Trans to Starter
—	14-0576	12044	1980-84 5 Speed Main Drive Gear, MTL
14-0613	14-0111	12044A	1980-84 FLT-FXR Main Drive Gear
14-0614	14-0149	12045	1980-up 5 Speed Shifter Shaft
14-0677	14-0825	12045	Double Lip Metal Outside Diameter
14-0664	—	12047	1980-81 FLT Wheel Bearing
14-0615	14-0150	12049	1984-90 XL Mainsht Sprocket
14-0616	14-0157	12050	1984-99 FXR-FLT, 91 XL Mainshaft Clutch Side
14-0617	14-0158	12051	1984-88 Big Twin Inner Chain Housing Start Shaft
14-0618	14-0159	12052	1984-up Big Twin Inner Chain Housing Mainshaft
14-0619	14-0920	12053A	1989-93 Big Twin Inner Chain Housing Start Shaft
14-0665	14-0961	12066	1994-up Big Twin Inner Chain Housing Starter Shaft
14-0972	14-0962	12067A	1994-up Front Pulley
14-0810	—	12068	1999-up TC-88 Sprocket Shft
14-0696	—	12074	Main Drive Gear Outer
14-0697	—	12077	2006-up Dynaglide, 2007-up Big Twin
—	7411-2	24776-40	As Above Inner
—	14-0177		1936-54 Big Twin Engine Seal Replacement seal
14-0622	14-0171	25414-82	For above, each
14-0623	14-0114	26227-58	1982-84 FLT Rear Chain Housing
14-0963	14-0925	26856-89	1958-76 XL, 1968-up Big Twin Oil Pump
14-0811	14-0805	26858-99	1991-99 BT, 91-up XL Rocker Cover Umbrella
14-0624	14-0165	26995-86B	1999-up TC-88 Umbrella
14-0573	—	26995-97X	1986-up Intake Manifold to Cylinder Head Evo & TC-88
14-0678	—	Oversize	As Above, Blue
14-0689	—		As Above
14-0625	14-0180	27002-89	As Above Metal with Rubber Standard Size
14-0626	14-0113	27062-78	1989-up Evolution Carburetor to Manifold
14-0679	—	27385-76	1978-85 Big Twin Shovelhead Intake Manifold to Cylinder Head Sleeve
14-0627	14-0168	29911-82	Low Speed Jet Plug 1976-up Keihin Carburetors
14-0628	14-0112	30145-46A	1982-84 XL Gen Gear End
14-0629	14-0156	31341-80	1958-69 74", 1958-81 XL Generator, Large
14-0630	14-0115	33076-37	1980-84 FXB, 84-85 FXWG Starter Shaft Housing
14-0631	14-0116	34035-52	L1937-84 FL-FX 4 Speed Starter Crank
14-0632	14-0117	34036-36	1952-85 XL Shifter Shaft
14-0635	14-0118	35151-52A	1941-79 Big Twin Shifter Cam Shaft
			1952-74 XL Engine, 1952-Early 74 XL Transmission

# Seal



Seals are sold 5 pack unless noted U/M price list. \*Note: Metal Outside Diameter

James	VT No.	OEM	Fits
14-0636	14-0119	35151-74	Late 1974-up XL Engine
14-0637	14-0122	35230-39	Late 1974-up XL Transmission
14-0638	14-0123	35231-36	1941-79 74" and 80" Transmission Mainshaft Double Lip
—	14-0186	As Above	1937-79 Transmission Mainshaft Cork Washer
14-0639	14-0160	37101-84	Rubber
14-0695	—	37107-06	1984-86 FXR-FLT Clutch Release Lever
—	14-0126	37335-41	1986-up XL Primary Cover Shift Shaft
14-0640	14-0124	37337-36	2006-up XL Primary Cover
14-0641	14-0125	37339-53	1941-73 45" Clutch Pushrod
14-0643	14-0127	37531-56B	1937-67 FL Clutch Pushrod Cork
14-0644	14-0128	37740-57	1954-70 XL Clutch Rod
14-0645	14-0129	37741-67	1955-69 XL Transmission Clutch Gear
14-0646	14-0130	37741-82	Late 1957-66 XLH-XLCH, 1967-69 XLCH Clutch Hub Oil
14-0822	—	37741-82	1967-70 XLH Clutch Hub
14-0647	14-0131	41210-55	1979-81 Big Twin Transmission Mainshaft
14-0648	14-0167	45378-87	1982-85 Big Twin 4 Speed Transmission Mainshaft
14-0649	14-0162	45387-83	As Above Double Lip Rubber Outside Dia
14-0650	14-0133	45400-75	1955-72 XL, 1967-71 Big Twin Wheel Hub
14-0651	14-0132	45733-48	1987-up FXLR-FXRSE Fork Slider
14-0652	14-0134	45843-77	1983-up FXR-FXRSE-FXRT, 1984-up XL Fork Slider
14-0653	14-0135	45852-48	1975-83 XL-FX Fork Slider, Showa
14-0654	14-0163	45875-84	1949-77 FL Model, 1987-up FLST-FXST Fork Tube Cap
14-0655	14-0136	45927-73	1977-83 FL, 80-86 FXWG Fork Slider
14-0656	14-0137	45975-71	1948-77 FL-FLH Fork Slider
14-0657	14-0138	47519-58	1984-up FXST, 1985-up FXWG, 1987-up FLT
14-0658	14-0139	47519-72	1973-74 FX-XL Fork Slider
14-0659	14-0140	47519-83A	1971-72 FX-XL Fork Slider
14-0660	14-0141	60641-74	1973-82 FX Rear Wheel, 1973-82 FL Front/Rear Wire Wheel (Double Lip)
40-9835	—	63525-92	1972-82 FX Front and Rear Wheel Seal, 1973-82 FL Front/Rear Mag Wheel
40-9833	—	63528-92	1983-99 FX-XL Front or Rear Wheel (Double Lip)
14-0662	14-0147	63529-57	1974-84 FX-74" All models Except FXWG, Shifter Shaft
14-0966	—	67096-87	1992-99 Big Twin Oil Line Feed Tube
14-0944	—	67098-87	1992-99 Big Twin Oil Filter Tube
14-0947	—	67118-87	1957-85 XL, 1966-85 Big Twin Rocker Oil Line
14-0663*	14-0682*	83162-51	1987-94 FLT Speedometer Drive
14-0680	14-0142	83162-51	1987-94 FXR-Dynaglide-XL Speedometer Drive
			1987-94 FXST-FLST Speedometer Drive
			1971-99 74"-80" All Cam Cover Single Lip
			As Above Double Lip





# Pin

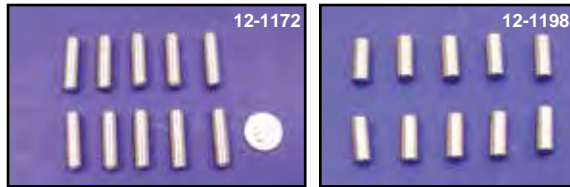

**Dowel Pin-Roll Pin.** Special pins in 25 packs. Check factory parts book for more applications.

VT No.	OEM	Fits	Use
12-1198	221	1990-up	Primary
12-1176	255	1971-76	Solenoid
12-1175	271	1941-up 74, 1954-up XL 1931-up 45"	Cam
12-1184	275	1941-up Big Twin	Cam Case
12-1185	327	1941-up Big Twin	Gear Case
12-1173	333	1937 UL and 45" 1957-81 XL	Oil Strainer, 10 pack
12-1174	334A	1965-up FL-FXE	Starter
12-1153	358	1970-83	Cam Cover
12-1172	375	1941-up Big Twin	Transmission
12-1166	377	1930-up Big Twin	Cam Cover
12-1177	600	1979-up	Solenoid
12-1178	601	Shifter Cam	Solenoid
12-1160	603	1976-84 Big Twin	Rotor
12-1181	614, 640	1971-Early 75 Big Twin	Solenoid
12-1163	615	1970-78 All	Points
12-1164	620	1970-78 All	Points
12-1162	623	1970-78 All	Points

**Cotter Pins** are zinc plated, sold in 100 pack.

VT No.	OEM	Size
37-8660	510	1/16" — 1/2"
37-8795	511	3/32" — 1/4"
37-8659	512	1/16" — 5/8"
37-9042	515	1/16" — 3/4"
37-8786	528	3/32" — 5/8"
37-8787	531	3/32" — 7/8"
37-8661	534	3/32" — 1"
37-8788	513	3/32" — 1 5/16"
37-8789	550	1/8" — 9/8"
37-8790	559, 520W	1/8" — 1 1/4"
37-8663	566	3/16" — 1"
37-0747	Parkerized	1/16" — 1/2", 50 pk
37-0749	Parkerized	3/32" — 1", 50 pk



# Rivet



**Replacement Fender Rivets** fit all FL front and rear fenders and FX front fenders, 25 pack.

VT No.	Fits
37-6368	Big Twin Fender Brace
37-6369	Big Twin Fender Top
37-6370	FX Front, 1973-up Stainless
37-0938	Inner Primary



VT No.	OEM	Type	Use	U/M
37-8805	—	Short 4-4 1/2	Brake	100 pack
37-8806	41871-31	Long 4-5	Brake	100 pack
37-8807*	8226	Short 7-4	Clutch	100 pack

\*Note: For clutch hub friction disc.

Fiberglass Saddlebag Rivets, pack of 50.			
VT No.	OEM	Length	
37-0566	90965-63	5/16"	
37-0567	90966-67	1/4"	
37-0568	90967-64	3/8"	

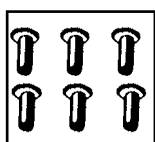

# Seal



**Big Twin Left Side Engine Case Seals**

VT No.	#	OEM	Year	Model
7411-2	A	24776-40	1936-54	61-74-80
7411-2T		24776-40	1936-54	61-74-80, V-Twin
14-0965		24031-55	1955-68	OE type
7410-1	C	24031-55	1955-68	Colony
7410-55T		24031-55	1955-68	V-Twin
7410-1-OS		Oversize	1955-68	Colony (+.002)
7410-1-US		Undersize	1955-68	Colony (-.002)
14-0177		Seal only	For above	
14-0185	B	24031-69	1969 only	Big Twin
14-0108	B	12026B	1970-99	Big Twin, 5 pack
14-0580	B	12026-B	1970-99	Big Twin, 5 pack
14-0810	B	12068	2000-up	TC-88
14-0980		12068	2000-up	TC-88

**Note:** 7410-1 and 7410-55T are a screw-in type insert with integral seal. 14-0965 is stock type screw-in without seal. 7411-2, 8211-2 both include seal, spacer & snap ring.

VT No.	OEM	Description
14-0984	61326-95	Top Plate Cork Gasket
14-0985	61381-02	Top Plate Gasket
14-0986	61402-08	Top Plate Gasket
14-0987	61402-02	Top Plate Gasket
14-0988	61402-08	Seal, Top Plate
14-0989	75245-04A	Seal, Fuel Tank
14-0990	75249-04A	Seal, Fuel Tank
14-0991	75301-07	Seal, Fuel Pump, Plate
14-0992	11324	O-ring 7.00 x 1.50 MM
14-0993	11345	O-ring
14-0980	12068	Oil Seal
14-0994	27444-00	O-ring
14-0995	34990-08	Gasket, Chain Inspection
14-0996	62673-90	O-ring FXDS
14-0997	11120	O-ring Dipstick



**Krommets** are available in traditional gold, chrome type or 10 point, 10 pack, 1/4" — 20 thread.

VT No.	Item
37-1954	Star Washer
37-0869	1 3/8" Outside Diameter Rubber Washer for Above
37-0503	Chrome Rocket with Fins
37-0501	Chrome Krommets
37-0502	Gold Krommets

**Krommets** feature 1/4" — 20 studs unless noted for decorative mounting. Available in 5 packs unless noted.

VT No.	Item
37-1100	Chrome
37-9076	Chrome Skull
37-9077	Gold Skull
37-2999	Chrome Skull, large, 5/16" — 18, no stud
37-9096	Chrome Skull, large 1/4" — 20, stud
37-9297	Chrome Skull large 5/16" — 18, stud
37-9218	Skull Valve Stem Cover, pair
37-1529	License Plate Skull Chrome Small, 1 1/8 x 1 1/8
37-1530	License Plate Skull Chrome Large, 1 1/4 x 1 1/4



# Stud



Factory Type Studs for stock applications.

VT No.	OEM	Fits
12-1197	11733	1984-up FX Transmission Stud Set
12-1187	16715-83	1985-up Evolution Exhaust, 5 pack
12-1192	16830-29	1929-up 45 Cylinder Base Set
12-2113	16830-54	1980-up Big Twin Inner Primary, Set
12-2100	16831-30	1930-77 Big Twin Cylinder Base Set
12-1188	16831-83	1985-up Evolution Top Mount
12-2107	16864-48	1948-84 Big Twin Top Mount 4 pack
12-2114	17647-48	1948-65 Panhead Rocker
9917-8	17647-48	1948-65 Panhead Rocker Arm
12-2106	17506-66	Shovelhead Rocker Box Cover Set
	17508-66	1 Head
	16864-48	10 piece Total
12-2524	Sifton	As Above
8741-19	24819-36	& 24820-36, 1936-67 Big Twin Oil Pump Set, Cadmium
12-2109	24823-80	1965-up Big Twin Kick Cover Set
12-2126	24824-67	1962-70 Carburetor 3/8"
12-1191	24914-58	1958-64 Big Twin Breather
12-2110	29254-78	1978-89 Carburetor Mount, 5/16"
12-2099	33298-36	1936-64 Big Twin Kick Cover Set
	33298-65	1965-77 Carburetor, 5/16"
12-2105	34723-47	1948-84 Big Twin Oversize Transmission, 4 pack
12-2104	34724-36A	1948-84 Big Twin Transmission Mount, 4 pack
37-6366	42301-79	1979-84 Big Twin Master Cylinder Mount, each
8813-4	45840-48	1949-76 Glide Leg, pair
8826-6	45998-73	1977 up Glide Leg, pair
	72341-48	1973-up FX Leg Stud, pair
12-2123	61605-36	1936-83 Rear Big Twin Tank Mount
8823-10	72341 48	1948-55 Big Twin Coil Mount, pair
8824-8	72341-56	1956-82 Big Twin Coil Mount, pair

# Key



Keys.	OEM	Fits
12-0213	11204	1980-85 XL Rear Intake Came
12-0209	11218	1981-90 XL-Big Twin Gear Shaft 1981-90 XL-Big Twin Crank Pin
12-0215	11219	1988-99 XL Oil Pump Drive Gear
12-0216	11220	1941-81 Big Twin, 1954-81 XL Gear Shaft
12-0200	23985-12	1954-81 XL, 1930-54 Big Twin Sprocket Shaft
12-0201	23985-18	1941-81 Big Twin, 1954-81 XL Gear Shaft
12-0202	23985-54	1954-90 Big Twin Gear Shaft Pinion
12-0203	23985-56	1956-80 Big Twin Sprocket Shaft
12-0204	26340-36	1941-67 Big Twin Oil Pump Gear
12-0214	26341-37	1937-73 45", 62-71 XL Oil Pump Retainer Half
12-0205	26348-15	1971-90 Big Twin Oil Pump Gear 1972-76 XL Breather Valve Gear 1975-86 Big Twin Pinion Shaft
12-0206	33393-50	1941-85 Big Twin Starter Clutch
12-0207	35175-38	1941-77 Big Twin Transmission Sprocket
12-0211	35196-26	1926-73 45" Transmission Sprocket
12-0208	37523-15	1941-84 Big Twin Clutch Hub
12-0212	37523-85	1985-90 Big Twin Clutch Hub
12-0210	40390-54	1954-60 Big Twin Compensator Sprocket

# Lock Tab

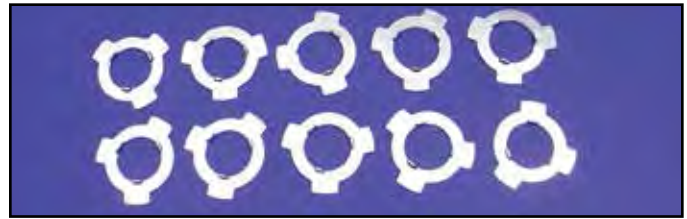

Replacement Lock Tabs.

VT No.	OEM	Fits
17-0918	7044A	Pinion Shaft 1979-up XL Gear End
17-9222	7402	1980-84 FLT-FXR Primary
17-0978	23970-36	Crank Pin 1936-40 61"
17-0914	23971-41	Crank Pin 1941-53 Big Twin, 1957-80 XL
17-0927	23971-54	Crank Pin 1954-80 Big Twin
17-0922	23982-12	45" Crank Pin 1929-73
17-0913	24015-36A	Pinion and Sprocket Shaft 1936-71 Big Twin Pinion only 1972-80 Big Twin, 1957-80 XL
17-0929	24016-29	Pinion/Spkt Shaft 1929-73 45" Side Valve
17-0917	24018-72	Sprocket Shaft Flywheel 1972-80 Big Twin
17-0908	25550-57	Cam Gear 1957-up Big Twin
10-1254	25554-84	Cam Gear .045 1957-up Big Twin
17-0921	25551-58	Cam Thrust Plate All 1958-up XL
17-0942	31479-65	1965-69 Big Twin Inner Primary
17-0937	—	1970-up Big Twin Inner Primary
17-0902	33082-16	Kicker & Countershaft 1941-84 Big Twin 4-Speed
17-0930	33125-89	Big Twin Starter Shaft 1989-up
17-0907	33197-79	Plunger Body Bolt 1978-84 Big Twin 4-Speed
17-0928	33318-85	Inner Primary 1985-up Big Twin
17-0905	33335-79	Transmission Sprocket 1980-83 FLT
17-0911	33362-52	Kicker Shaft All XL 1957-81
17-0903	33396-39	Kicker Clutch Gear 36-84 BT 4-Speed
17-0916	34066-52	Cam Follower 1952-78 Big Twin
17-0923	34067-52	Shifter Cam Retainer All 1957-85 XL
17-0919	34069-71	Shifter Cam 1954-up XL
17-0906	34180-33	Shifter Forks 1936-84 Big Twin 4-Speed
17-0943	34747-65	Transmission Plate 1965-84 Big Twin
17-0900	35050-40	Mainshaft Bearing 1940-84 Big Twin 4-Speed
17-0910	35050-52	Transmission Sprocket All 1952-up XL
17-0933	35216-26	45" Transmission Sprocket 1929-73
17-0901	35216-36	Transmission Sprocket 1936-84 Big Twin
17-0925	37462-41	45" Clutch Hub Nut 1936-84
17-0904	37503-41	Clutch Hub Nut 1941-84 Big Twin
17-0912	37533-52A	Clutch Hub All 1957-84 XL
17-0915	39996-65	Primary Adjuster 1965-up Big Twin
17-0934	40251-91	Pulley Lock Tab
17-0935	42575-30	Mechanical Brake Shaft 1936-57 Big Twin
17-0924	45717-63	Stem Nut 1960-85 FL's
17-0936	45752-50	Adjustable Fork Top Clamp
17-0909	47513-58	Swing Arm Bolt 1958-84 Big Twin
17-0920	47525-52	Swing Arm 1952-80 XL
17-0941	59166-80	FL Front Fender
17-0926	—	Transmission Lock Kit All Big Twin
39-0155	71069-47	Dash Stud L1947-67 Big Twin
49-2531	87136-36	Side Car Mount Lock Tab, 5 pack



Stud Installer Set. 9 Piece fits 1/4, 5/16, 3/8 and 7/16. VT No. 2398-9

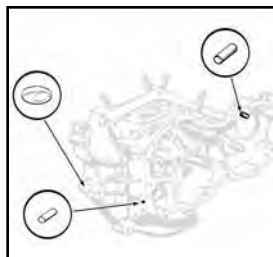

Hardware for Early Cases, 5 pack.

VT No.	Size
12-0599	1/2" Welch Plug
12-0595	9/16" Welch Plug
12-0596	3/8" Welch Plug
12-0623	.619 Welch Plug
12-1166	Timing Cover Pin





# Snap Cap™ Easy to Install!!!

*Yvette Jostling*



- Snap On
- Tight Fit
- Easy Installation

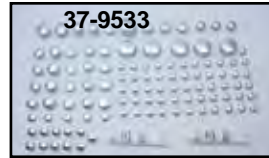
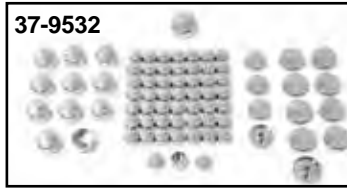
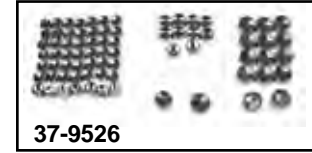

## Chrome Bolt Cap Cover Kit

VT No.	Model	Kit Quantity
<b>Touring</b>		
37-9526	2007-08	75
37-9539	2009-up	126
37-9540	1999-08	148
<b>Dyna</b>		
37-9541	1999-up	156
37-9528	2006-up	76
37-9529	1999-05	86
<b>Softail</b>		
37-9543	1999-up	175
37-9530	2007-up	81
37-9531	2000-06	87
37-9536	2009-up	125
<b>Engine</b>		
37-9535	TC-88	79
<b>Sportster</b>		
37-9532	2004-up	77
37-9534	2004-up Engine	63
37-9533	1984-03	74



These new bolt cover kits will make any bike look great and are also for custom builders use. Easy to install these new kits have beautifully designed pieces to cover the raw OE bolt heads on engine, transmission, primary and more, each kit includes detailed instruction for installation on each model as listed, all covers in each kit are individually packed and numbers for identification. installation has never been easier.



**Chrome Cap Assortment** includes 100 piece each 1/4", 5/16" and 3/8" caps.

VT No. 37-1505

## 100 Pieces!

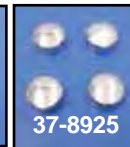

**Chrome Pasties** are allen head bolt covers which install with a set screw for positive hold. Sold in pairs, for screw thread size listed.

VT No.	Size	U/M
37-8923	1/4"	2
37-8925	3/8"	2
37-0962	3/8"	4 piece set

# Chrome Cap



**Chrome End Caps for Allen Bolts** fit 1/4", 5/16" and 3/8" allen bolts (thread size). Available in an assortment tray with 100 of each and in refill packs of 10 or 50 packs.

VT No.	Item	Quantity	Material
37-9198	1/4" Refill Bag	100	ABS
37-9199	5/16" Refill Bag	100	ABS
37-9200	3/8" Refill Bag	100	ABS

**Snap Caps™** snap on knurled allen screws for ease of installation. Packs of 25 or 100.

100 pack	25 pack	Fits
37-1502	37-1526	1/4"
37-1503	37-1527	5/16"
37-1504	37-1528	3/8"
300 Pieces		
37-1505	—	Assortment

- Snap On
- Tight Fit
- Easy Installation
- Universal Use



**Press in Caps** for allen screws.

VT No.	Size	Qty
2164-100	1/4"	100
2165-100	5/16"	100
2166-100	3/8"	100



**Chrome Hole Plugs** snap in as replacements.

VT No.	OEM	Use/Model
37-8349	60650-54A	1955-64 Primary Big Twin
28-0618	56238-62	1962-up Handlebar Grip
37-8994	Stainless	1962-up Spotlight Bar
28-1500	67830-59	Visor Plug
37-9304	68797-68A	1968-84 Big Twin Swing Arm Frame





# Chrome and Zinc Plated Bolt



**Chrome Plated Bolts** are sold in 10 packs.  
**Zinc Plated Bolts** are sold in 25 packs.

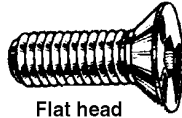

Size	CHROME Allen Button Head		CHROME Allen Flat Head		CHROME KNURLED Allen Socket Cap		CHROME Hex Cap Bolt		ZINC Hex Cap Bolt	
	Coarse UNC	Fine SAE	Coarse UNC	Fine SAE	Coarse UNC	Fine SAE	Coarse UNC	Fine SAE	Coarse UNC	Fine SAE
1/4 — 1/2	37-8700	37-8725	37-0153	37-0106	37-8356	—	—	—	—	—
1/4 — 5/8	37-8701	37-8726	37-0154	—	37-8300	37-8324	37-8602	37-8573	37-0600	37-0628
1/4 — 3/4	37-8702	37-8727	37-0155	37-0107	37-8301	37-8325	37-8603	37-8574	37-0601	37-0629
1/4 — 7/8	37-8703	37-8728	37-0156	—	37-8302	37-8326	37-8604	—	37-0602	37-0630
1/4 — 1	37-8704	37-8729	37-0157	37-0108	37-8303	37-8327	37-8605	37-8576	37-0603	37-0631
1/4 — 1	37-8704	37-8729	37-0157	37-0108	37-8303T	37-8327	37-8605	37-8576	37-0603	37-0631
1/4 — 1 1/4	37-8705	37-8730	37-0158	37-0109	37-8304	37-8328	37-8606	37-8577	37-0604	37-0632
1/4 — 1 1/4	37-8705	37-8730	37-0158	37-0109	37-8304T	37-8328	37-8606	37-8577	37-0604	37-0632
1/4 — 1 1/2	37-8706	37-8731	37-0159	37-0110	37-8305	37-8329	37-8607	37-8578	37-0605	—
1/4 — 1 3/4	37-8707	—	37-0160	—	37-8306	37-8330	—	—	37-0606	37-0634
1/4 — 1 3/4	37-8707	—	37-0160	—	37-8306T	37-8330	—	—	37-0606	37-0634
1/4 — 2	37-8708	—	37-0161	—	37-8307	—	37-8609	—	37-0607	37-0635
1/4 — 2 1/4	37-8709	—	—	—	37-8308	—	—	—	37-0608	37-0636
1/4 — 2 1/4	37-8709	—	—	—	—	—	—	—	37-0608	37-0636
1/4 — 2 1/2	37-8710	—	37-0163	—	—	—	—	—	—	—
1/4 — 2 5/8	37-8738	—	—	—	—	—	—	—	—	—
5/16 — 1/2	37-8711	37-8732	37-0164	—	—	—	—	—	—	37-0550
5/16 — 5/8	—	37-8798	—	—	37-8309	37-8331	37-8611	37-8582	37-0609	37-0637
5/16 — 5/8	—	37-8798	—	—	37-8309T	37-8331	37-8611	37-8582	37-0609	37-0637
5/16 — 3/4	37-8712	37-8733	37-0165	37-0115	37-8310	37-8332	37-8612	37-8583	37-0610	37-0638
5/16 — 7/8	—	—	37-0166	—	37-8311	37-8333	37-8613	37-8584	37-0611	37-0639
5/16 — 1	37-8713	37-8734	37-0167	37-0116	37-8312	37-8334	37-8614	37-8585	37-0612	37-0640
5/16 — 1 1/4	37-8714	37-8735	—	37-0117	37-8313	37-8335	37-8615	37-8586	37-0613	37-0641
5/16 — 1 1/2	37-8716	37-8736	37-0169	37-0118	37-8314	37-8336	37-8616	37-8587	—	37-0642
5/16 — 1 3/4	37-8717	37-8737	37-0170	—	37-8315	37-8337	37-8981	—	37-0615	37-0643
5/16 — 2	37-8718	—	—	—	37-8316	—	37-8617	—	37-0616	37-0644
5/16 — 2 1/4	—	—	—	—	37-8317	37-8339	37-8618	37-8590	37-0617	37-0645
5/16 — 3 1/2	—	—	—	—	37-8462	—	—	—	—	—
5/16 — 3 1/2	—	—	—	—	37-8462T	—	—	—	—	—
5/16 — 24 — 3 1/2	—	—	—	—	37-8463	—	—	—	—	—
5/16 — 24 — 3 1/2	—	—	—	—	37-8463T	—	—	—	—	—
5/16 — 24 — 3 1/4	—	—	—	—	37-8464	—	—	—	—	—
5/16 — 24 — 3 1/4	—	—	—	—	37-8464T	—	—	—	—	—
3/8 — 3/4	37-8719	37-8739	37-0173	37-0122	37-8318	37-8340	37-8619	37-8591	37-0618	—
3/8 — 7/8	37-8355	—	—	—	—	—	—	—	—	—
3/8 — 1	37-8720	37-8740	37-0174	37-0123	37-8319	—	37-8620	37-8592	37-0619	37-0647
3/8 — 1 1/4	37-8721	37-8741	—	37-0124	37-8320	—	37-8621	37-8593	37-0620	37-0648
3/8 — 1 1/2	37-8722	37-8742	—	37-0125	37-8321	37-8343	37-8622	37-8594	37-0621	37-0649
3/8 — 1 3/4	37-8723	37-8743	—	—	37-8322	—	37-8623	37-8595	37-0622	37-0650
3/8 — 2	37-8724	37-8744	37-0178	—	37-8323	—	37-8624	37-8596	37-0623	37-0651
3/8 — 2 1/4	—	—	—	—	—	37-8346	—	—	—	—
3/8 — 16 — 2 1/4	—	—	—	—	37-8354	—	—	—	—	—
3/8 — 2 1/2	—	—	—	—	37-8352	37-8347	—	—	—	—
3/8 — 16 — 3 1/2	—	—	—	—	37-8353	—	37-8682	—	37-8658	—
7/16 — 1	—	—	—	—	—	—	—	37-8597	—	—
7/16 — 1 1/4	—	—	—	—	—	—	37-8625	37-8598	37-0625	—
7/16 — 1 1/2	—	—	—	—	—	—	37-8626	37-8599	37-0626	37-0654
1/2 — 1 1/2	—	—	—	—	—	—	—	—	—	—
1/2 — 2	—	—	—	—	—	—	—	—	—	—
1/2 — 2 1/4	—	—	—	—	—	—	37-8627	37-8600	—	—
1/2 — 2 1/2	—	—	—	—	—	—	37-8980	37-8601	—	—
1/2 — 2 3/4	—	—	—	—	—	—	37-0793	37-0795	—	—





# Spacer

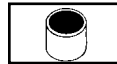

## Zinc Spacers

VT No.	ID	OD	L
37-0469	1/4	15/32	5/32
37-0404	1/4	9/16	3/4
37-0405	1/4	9/16	3/4, Black
37-0473	5/16	1/2	1/2
37-0406	5/16	5/8	1/4
37-0428	5/16	3/4	1/4
37-0408	5/16	3/4	1/4
37-0410	5/16	5/8	3/8
37-0411	5/16	7/8	3/8
37-0412	5/16	5/8	3/4
37-0413	5/16	5/8	1 1/8
37-0454	5/16	1/2	5/8
37-0455	5/16	1/2	1/2
37-0984	5/16	1/2	2 1/4, Black
37-0458	3/8	3/4	5/8
37-0414	3/8	1	1
37-0430	3/8	1	1 1/4
37-1018	3/8	1	1 5/16, Black
37-0417	25/64	1	1/2
37-0954	3/8	5/8	1/2
37-1210	7/16	1 1/8	1
37-0431	1/2	5/8	1 1/4, Black
37-0418	1/2	1	1/2
37-0418T	1/2	1	1/2
37-0439	1/2	3/4	1
37-0420	1/2	3/4	2 1/4
37-0421	5/8	1	1/4
37-0421T	5/8	1	1/4

## Chrome Steel Spacers.

Pack of 5.	VT No.	ID	OD	L
	37-0447	1/2	5/8	1 1/4
	37-0459	1/4	1/8	5/8
	37-0460	1/4	5/8	1
	37-0462	5/16	5/8	1/4
	37-0463	5/16	5/8	3/8
	37-0464	5/16	5/8	1/2
	37-0465	5/16	5/8	3/4
	37-0466	3/8	3/4	3/8
	37-0467	3/8	3/4	3/4
	37-0445	3/8	5/8	1
	37-0468	3/8	3/4	1

## Aluminum

VT No.	ID	OD	L
37-0422	1/4	5/8	5/8
37-0423	5/16	1 1/16	7/16
37-0424	3/8	1	7/8
37-0425	3/8	5/8	1 1/8

## Chrome Steel Spacer 10 pack.

VT No.	ID	OD	L
37-0433	5/32	1/4	1/2
37-0457	5/32	15/32	1/2
37-8628	1/4	7/16	3/16
37-8629	1/4	7/16	1/4
37-8630	1/4	7/16	3/8
37-0470	1/4	1/2	3/32
37-0435	1/4	3/4	1/2
37-8631	1/4	7/16	5/8
37-8632	1/4	7/16	3/4
37-8633	1/4	7/16	7/8

VT No.	ID	OD	L
37-8635	5/16	1/2	17/32
37-0400	5/16	3/4	1
37-0401	5/16	5/8	1 1/8
37-0401T	5/16	5/8	1 1/8
37-8636	3/8	9/16	1/8
37-8637	3/8	13/16	1/2
37-0402	3/8	3/4	1/2
37-0403	3/8	5/8	7/8
23-0600	3/8	9/16	1/4 (a)
23-1742	3/8	3/4	3/16 (b)
37-8638	7/16	1 1/16	5/16
37-0448	5/8	3/4	1

(a): Replaces 44132-72 Disc Brake Caliper Washer  
 (b): Replaces 50668-35 1958-78 Master Cylinder Spacer

Chrome Countersunk Washer Sets are the 82° type to accept flat head socket screws.

VT No.	Size	Quantity
9843-8	#10	8
9835-8	5/16"	8
9836-5	3/8"	5
9844-5	7/16"	5



Chrome Top Engine Mount Spacer Set for spacing out top mount or wide tire conversions. Spacers have 7/16" inner diameter with 1 1/8" outside diameter.

VT No.	Thickness
37-0419	3/4"
37-0419T*	3/4" *Note: Zinc
37-0437	1/2"

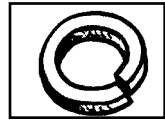
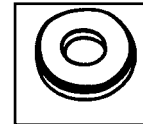

# Washer



Lockwasher Biter Assortment includes 50 pieces of each size.  
 VT No. 37-0535

## Lock Washers

Zinc	Chrome	OEM	Inner Diameter	Qty.
37-0689	37-9053	—	#8	100
37-0852	—	—	#10	25
37-0690	—	6998	1/4"	100
—	37-9054T	6998	1/4"	100
—	9516-12	6998	1/4"	12
37-0691	37-9055	7041	5/16"	100
—	9517-12	7041	5/16"	12
37-0692	37-9056	7038	3/8"	100
—	9518-6	7038	3/8"	6
37-0693	37-9057	7039	7/16"	100
—	9519-6	7039	7/16"	6
49-1499	—	—	7/16" Note: Parkerized, sold each.	—
37-0694	37-9058	7068	1/2"	100
37-0798	—	7238	1/2"	25
—	9971-5	—	1/2"	5
37-0695	37-9059	7022	5/8"	50

## Flat Washers

Zinc	Chrome	Inner Diameter	Type	Qty.
—	37-8557	#8	Standard	100
—	37-8558	#10	Standard	100
—	8166-12	1/4"	Standard	12
—	8166-12T	1/4"	Standard	12
37-0683	37-8559	1/4"	Standard	100
—	8167-12	5/16"	Standard	12
37-0684	37-8560	5/16"	Standard	100
—	37-8560T	5/16"	Standard	100
—	8168-6	3/8"	Standard	6
37-0685	37-8561	3/8"	Standard	100
—	8169-6	7/16"	Standard	6
37-0686	37-8562	7/16"	Standard	100
37-0687	37-8563	1/2"	Standard	100
—	9972-5	1/2"	Standard	5
37-0688	37-8564	5/8"	Standard	50
37-9273**	37-8565	5/8"	(Outside Diameter) OE	100
37-9272	—	1/4"	OE	25
—	9633-50	1/4"	OE	50
—	9633-50T	1/4"	OE	50
—	37-8567*	1/4"	Special	50
—	2115-12*	1/4"	Special	12
—	37-8568*	5/16"	Special	50
—	2110-12*	5/16"	Special	12
—	37-8569*	3/8"	Special	50
—	2114-6*	3/8"	Special	6
—	37-8570*	7/16"	Special	50
—	2112-6*	7/16"	Special	6
—	37-8571*	1/2"	Special	25
—	37-8572*	5/8"	Special	25

\*Note: Extra thick with tighter fitting inner diameter than standard SAE washers.

\*\*Note: 25 pieces per pack

# Nut



Thread Size Application Chart			
Fine Size	Thread Type	Coarse Size	Thread Type
1/4-28	SAE	1/4-20	UNC
5/16-24	SAE	5/16-18	UNC
3/8-24	SAE	3/8-16	UNC
7/16-20	SAE	7/16-14	UNC
1/2-20	SAE	1/2-13	UNC
9/16-18	SAE	9/16-12	UNC



6901-5



Hex Nuts sold either in zinc or chrome, Nyloc or Standard. Nyloc features a plastic insert for vibration proof mounting, 20 pack for chrome and 50 pack for zinc

### Pike Nuts, Fine

VT No.	Size
6901-5	10-32 SAE
6902-5	1/4-28 SAE
6900-5	1/4-24 HD
6903-4	5/16-24 SAE
6904-3	3/8-24 SAE
6905-2	7/16-20 SAE
6906-1	1/2-20 SAE
6907-1	9/16-18 SAE
6908-1*	5/8-18 SAE, (1")
6908-1T	5/8-18 SAE, (1")
6909-1*	5/8-18 SAE, (1 1/4")
6909-1T	5/8-18 SAE, (1 1/4")
44-0647*	3/4-16 SAE, (1 1/4")

### Pike Nuts, Coarse

VT No.	Size	U/M
6910-5	10-24	5 pack
6911-5	1/4-20	5 pack
6912-4	5/16-18	4 pack
6913-3	3/8-16	3 pack
6914-2	7/16-14	2 pack
6915-1	1/2-13	Each
6916-1	9/16-12	Each
6917-1*	5/8-11, (1")	Each
6918-1*	5/8-11, (1 1/4")	Each

\*Note: Hex Size  
\*Note: Hex Size



### Cap Nuts, Fine

VT No.	Size	U/M
8415-5	10-32,	5 pack
8416-5	1/4-28	5 pack
8417-4	5/16-24	4 pack
8418-3	3/8-24	3 pack
8419-2	7/16-20	2 pack
8420-1	1/2-20	Each
8422-1*	5/8-18, 15/16"	Each

\*Note: Hex Size

### Cap Nuts, Coarse

VT No.	Size	U/M
8423-5	10-24	5 pack
8424-5	1/4-20	5 pack
8425-4	5/16-18	4 pack
8426-3	3/8-16	3 pack
8427-2	7/16-14	2 pack
8428-1	1/2-13	Each
8429-1	9/16-12	Each
8430-1*	5/8-11 15/16"	Each

\*Note: Hex Size



6930-5

### Acorn Nuts, Fine

VT No.	Size	U/M
6930-5	1/4-24 HD	5 pack
6931-5	10-32	5 pack
6932-5	1/4-28	5 pack
6933-4	5/16-24	4 pack
6933-4T	5/16-24	4 pack
6934-3	3/8-24	3 pack
6935-2	7/16-20	2 pack

6936-1	1/2-20	Each
6937-1	9/16-18	Each
6938-1*	5/8-18, (15/16)	Each
6938-1T*	5/8-18, (15/16)	Each
6939-1*	3/4-16, (1 1/8)	Each
6939-1T*	3/4-16, (1 1/8)	Each
6940-1*	5/8-18, (1 1/4)	Each
37-0889	3/4-16, (1 1/4)	Each

### Acorn Nuts, Coarse

VT No.	Size	U/M
6941-5	10-24	5 pack
6942-5	1/2-20	5 pack
6943-4	5/16-18	4 pack
6943-4T	5/16-18	4 pack
6944-3	3/8-16	3 pack
6945-2	7/16-14	2 pack
6946-1	1/2-13	Each
6946-1T	1/2-13	Each
6947-1	9/16-12	Each
6948-1*	5/8-11 (15/16)	Each

\*Note: Hex Size

Chrome Standard	Chrome Nyloc	Zinc Standard	Zinc Nyloc	Size
—	—	39-0166	—	9/32
—	—	39-0167	—	9/32
37-8110	37-8119	37-0657	37-0666	1/4-20
37-8111	37-8120	37-0658	37-0667	1/4-28
37-8112	37-8121	37-0659	37-0668	5/16-18
—	37-8121T	—	—	5/16-18
37-8113	37-8122	37-0660	37-0669	5/16-24
37-8113T	37-8122T	—	—	5/16-24
37-8114	37-8123	37-0661	37-0670	3/8-16
37-8115	37-8124	37-0662	37-0671	3/8-24
37-8115T	—	—	—	3/8-24
37-8116	37-8125	37-0663	37-0672	1/2-20
37-8116T	—	—	—	1/2-20
37-8117	37-8126	37-0664	37-0673	7/16-20
37-8117T	—	—	—	7/16-20
—	37-8127*	—	37-0674	5/8-18
37-8145	—	—	—	5/8-11

\*Note: Sold in 10 pack.



37-9144

Flexloc Nuts Replicas are all metal, cadmium plated.

VT No.	Size	VT No.	Size
37-9144	10/24	37-0875	5/16-18
37-0850	10/32	37-9146	5/16-24
37-9150	1/4-20	37-0876	3/8-16
37-9145	1/4-28 Fine	37-9149	1/2-20
12-0571	5/16-24 Thin		
9918-8	5/16-24 Thin 8pc		

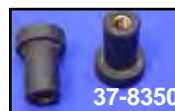

37-8350

Well-Nuts are rubber inserts which press in panels as threaded inserts.

VT No.	OEM	Thread	Type
37-9193	5210	9/32	Headlight
37-9194	5207	10/32	Module
37-8348	8099	1/4-20	FXR Cover
37-8350	8098	10/24	FXR Horn Mount



Red Cap Nuts are replica nuts as used on rocker shaft ends. Available in popular sizes for matching engine and transmission, SAE fine thread only.

VT No.	Size
37-8778	10-32
37-8783	1/2-20





# Factory Type Washer, Nut and Screw

**Replica Steel Washers.** Zinc plated unless noted. Check Parts Book for fitment.

VT No.	OEM	Size/Thickness
37-9307	6001	7/16 — 3/4 — 1/16, Black
37-9333	6002	5/16 — 5/8 — 1/16
37-9340	6011	3/32 — 5/16 — 1/32, Brass
37-9195	6016	11/32 — 11/16 — 1/16
37-9266	6019	3/8 — 29/32 — 1/16
37-0836	6026	3/8 — 7/8 — 7/64
37-0801	6033	3/8 — 9/16 — 1/16
37-0802	6052	9/16 — 5/16 — 1/16
37-9339	6053	3/16 — 7/16 — 1/16, Nylon
37-9338	6054	3/16 — 9/16 — 1/16, Nylon
37-9352	6072	3/8 — 1 1/4 — 1/16
37-0532	6083	3/8 — 2 — 3/50
37-9267	6099	1/4 — 7/16 — 1/16
37-9268	6109	5/16 — 11/16 — 1/8
37-9269	6113	1/2 — 13/16 — 1/32
37-9270	6115	13/32 — 23/32 — 1/16
9985-24	6150	3/16 — 3/8 — 1/16, Cadmium
14-0031	6156	3/16 — 3/8, Brass (5)
37-0843	6187W	13/64 — 9/16 — 1/16
37-9271	6189W	#8 — 3/8 — 1/32
37-9309	6192	#8 — 7/16 — 3/64
37-0856	6194	13/64 — 1 1/16 — 3/64
37-9337	6228W	1/4 — 1/2 — 1/16
37-9336	6229W	5/16 — 1 1/16 — 3/64
23-1700	6230	11/32 — 13/32 x 4/125
37-9043	6220W	1/4 — 7/16 — 1/32
37-9319	6235	1/4 — 23/32 — 1/16
37-9298	6237	5/16 — 1 1/2 — 5/64
37-9394	6239	1/4 — 1/2 — 3/32
37-9272	6242W	1/4 — 9/16 — 1/32
37-9523	6310	1/4 — 9/16 — 1/32
37-9273	6316HW	9/16 — 5/16 — 1/32
37-9335	6317	3/4 — 1 1/2 — 1/32, Nylon
12-1158	6320	5/16 — 5/8 — 1/16
37-9362	6324W	5/16 — 11/16 — 1/16
37-9274	6327B	5/16 — 3/4 — 3/64
37-9347	6329	5/16 — 7/8 — 5/64
37-0837	6332B	5/16 — 15/16 — 3/64
37-9275	6333	5/16 — 7/8 — 5/64
37-0811	6365	1/2 — 1 1/4 — 1/16
12-0418	6366	1/2 — 1 1/4 — 3/32
37-9310	6379W	3/8 — 5/8 — 3/64
37-0838	6388HB	3/8 — 23/32 — 1/16
37-9326	6341B	5/16 — 1 1/8 — 3/64
37-9276	6334	7/16 — 1 — 1/8
37-0838	6388HB	3/8 — 23/32 — 1/16
37-9277	6395B	3/8 — 13/16 — 1/16
37-0839	6408	25/64 — 55/64 — 1/8
37-0797	6408	25/64 — 55/64 — 1/8, Zinc
37-8858	6410	1/4 — 9/16 — 1/16, Nylon
54-0432	6415W	3/8 — 1 1/8 — 3/32
37-9278	6417W	3/8 — 1 1/8 — 1/8
37-9324	6418B	3/8 — 1 1/8 — 11/64
12-9918	6443W	13/32 — 11/16 — 1/16
37-9313	6440	13/32 — 11/16 — 1/32
12-1193	6466W	13/32 — 5/8 — 1/32
8170-10	6469HW	7/16 — 3/4 — 1/8
37-9239	6469	7/16 — 3/4 — 1/8
37-9279	6473HB	29/64 — 51/64 — 1/16
37-0570	6474	3/8 — 13/16 — 5/32
37-9280	6481	15/32 — 13/16 — 9/64
37-9281	6486HW	29/64 — 13/16 — 3/32
37-9283	6495HW	7/16 — 15/16 — 1/8
37-9133	6495HW	7/16 — 1 1/8 — 3/64
37-9320	6516W	7/16 — 1 1/8 — 1/8
37-9284	6521W	7/16 — 1 1/8 — 3/32
37-9285	6522HB	7/16 — 1 1/8 — 5/32

## Washers Continued

37-9286	6524W	7/16 — 1 1/8 — 1/32
37-0010	6543	31/64 — 3/4 — 1/64
37-0011	6565W	1/2 — 3/4 — 3/32
37-9305	6645	31/64 — 11/32 — 1/8
37-9291	6653A	5/8 — 1 5/16 — 3/32
37-9292	6655	5/8 — 1 1/2 — 3/32
37-9308	6663HB	9/16 — 1 1/8 — 3/32
37-0696	6701	3/8 — 13/16 — 1/16
37-9287	6702	5/16 — 11/16 — 1/16
37-0697	6703	1/4 — 5/8 — 1/16
37-9351	6716	#10 — 1/2 — 3/64
54-0437	6724W	21/32 — 1 1/16 — 1/16
37-9135	6736	9/32 — 5/8 — 1/16
12-1157	6737	57/64 — 1 3/64 — 1/32
37-9288	6738	17/32 — 7/8 — 7/64
37-9344	6758	3/8 — 37/64 — 1/16
37-9342	6759	3/16 — 3/8 — 1/32
37-9323	6771A	21/64 — 33/64 — 1/16
37-9361	6780	11/16 — 29/32 — 1/16
37-0791	6788	5/16 — 1 — 1/16, Stainless Steel
37-9353	6804	1/2 — 1 1/8 — 1/16
37-0857	6807W	1/2 — 3/4 — 1/32
37-9325	6846	29/64 — 71/200 — 1/16
37-0814	7400HB	3/8 — 13/16 — 7/64
<b>Nuts</b>		
37-0436	10-24 Hex Nut	
37-0701	1/4 -28 N.F. Thread Acorn Nut, Chrome	
37-0702	1/4 -20 N.C. — 1/4 — 1/2" Hex Nut	
37-0703	1/4 -24 N.S. — 5/32 — 7/16 Hex Nut	
37-0704	1/4 -24 N.S. — 1/4 — 1/2 Hex Nut	
37-0706	5/16 -18 N.C. — 17/64 — 1/2 Hex Nut	
37-0707	5/16 -24 N.F. — 17/64 — 1/2 Hex Nut	
37-0829	5/16 -24 N.F. — 17/64 — 1/2 Hex Nut	
<b>Cadmium</b>		
37-0708	5/16-24 N.F. — 5/16 — 9/16 Hex Nut	
37-0709	3/8 -24 N.F. — 1/4 — 9/16 Hex Nut	
37-0710	3/8 -24 N.F. — 21/64 — 9/16 Hex Nut	
37-0712	3/8 -24 N.F. — 1/2 — 9/16 Hex Nut	
37-0714	7/16 -20 N.F. Thread Flexloc Nut	
37-0715	7/16 -20 N.F. — 1/4 — 9/16 Hex Nut	
37-0716	7/16 -20 N.F. — 1/4 — 5/8 Hex Nut	
37-0717	7/16 -20 N.F. — 3/8 — 5/8 Hex Nut	
37-0718	7/16 -20 N.F. — 3/8 — 5/8 Hex Nut	
37-0719	7/16 -20 N.F. — 1/2 — 5/8 Hex Nut	
37-0720	7/16 -20 N.F. — 3/8 — 3/4 Hex Nut	
37-0721	7/16 -20 N.F. — 7/16 — 3/4 Hex Nut	
37-0862	7/16 -20 N.F. (7859) Hex Nut	
37-0871	7/16 -20 N.F. (7859) Hex Nut, Chrome	
37-0723	1 1/2"-20 N.F. x. 3/8 — 3/4 Hex Nut	
37-0724	1 1/2"-20 N.F. — 5/16 — 13/16 Hex Nut	
37-0725	1 1/2"-20 N.F. — 7/32 — 7/8 Hex Nut	
37-0726	1 1/2"-20 N.F. — 7/16 — 7/8 Hex Nut	
37-0727	1 1/2"-20 N.F. — 17/32 — 7/8 Hex Nut	
37-0728	9/16"-18 N.F. — 11/32 — 15/16 Hex Nut	
37-0729	9/16"-18 N.F. — 1/2 — 15/16 Hex Nut	
37-0731	5/8"-18 N.F. — 7/16 — 7/8 Hex Nut	
37-0733	1"-20 N.E.F. — 3/8 — 1 3/8 Hex Nut	
<b>Washers</b>		
37-0737	3/16 — 7/16 — 1/32 Plain Steel Washer	
37-0738	1/4 — 5/8 — 1/16 Plain Steel Washer	
37-0740	5/16 — 1/2 — 1/16 Plain Steel Washer	
37-0741	5/16 — 11/16 — 1/16 Plain Steel Washer	
37-0742	25/64 — 1 — 1/8 Plain Steel Washer	
37-0743	3/8 — 13/16 — 1/16 Plain Steel Washer	
37-0744	7/16 — 15/16 — 1/8 Plain Steel Washer	
37-0746	8-32 N.C. — 5/8 Round Head Screw	

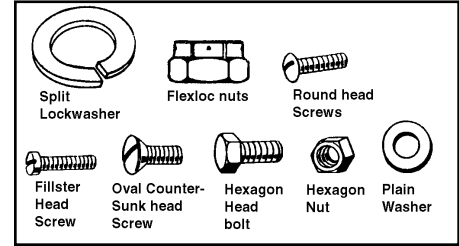

Parkerized finish unless noted otherwise.



## Screws

37-0739	8-32 N.C. — 3/8 Fillister Head Screw
37-0736	8-32 N.C. — 1/4 Round Head Screw
37-0750	10-24 N.C. — 1/2 Fillister Head Screw
37-0751	10-32 N.F. — 1/4 Round Head Screw
37-0752	10-32 N.F. — 3/8 Fillister Head Screw
37-0753	10-32 N.F. — 1/2 Fillister Head Screw
37-0851	10-32 N.F. — 1/2 Flathead Screw, SS
12-0583	10-32 N.F. — 5/8 Fillister
37-0755	1/4 — 15/32 Countersunk Shake Proof Washer, Parkerized
37-0756	10-32 N.F. — 5/8 Fillister Head Screw
37-0757	5/16 — 5/8 Countersunk Shake Proof Lockwasher, Parkerized
12-0583	10-32 N.F. x 5/8 Fillister Head Screw, Zinc
37-0953	12-24 N.C. x 1/2 Fillister Zinc
37-0758	10-24 N.C. x 1/2 Fillister Head Screw
37-0956	10-24 x 5/8 Fillister , Stainless Steel
37-0759	12-24 N.C. — 13/16 Oval Countersunk
37-0760	12-24 N.C. — 1/2 Oval Countersunk
37-0761	1/4-24 N.S. — 7/16 Round Head Screw
37-0762	1/4-24 N.S. — 1/2 Round Head Screw
37-0763	1/4-24 N.S. — 5/8 Round Head Screw
37-0764	1/4-24 N.S. — 5/8 Round Head Screw, Chrome
37-0834	1/4-24 N.S. — 5/8 Round Head Screw, Cadmium
37-0765	1/4-24 N.S. — 3/4 Hexagon Head Bolt
37-0766	1/4-24 N.S. — 1 1/8 Oval Countersunk
37-0767	1/4-24 N.S. — 13/16 Oval Countersunk
37-0768	5/16-24 N.F. — 3/4 Hexagon Head Bolt
37-0769	5/16-24 N.F. — 7/8 Hexagon Head Bolt
37-0770	5/16-24 N.F. — 1 Hexagon Head Bolt
37-0771	5/16-24 N.F. — 1 1/8 Hexagon Head Bolt
37-0774	3/8-16 N.C. — 1 3/8 Hexagon Head Bolt
<b>Flatwashers and Lockwashers</b>	
37-0777	1/4 Parkerized Flatwashers
37-0778	1/4 Parkerized Lockwashers
37-1022	#6 Lockwashers
37-1023	#8 Lockwashers
37-0779	#10 Parkerized Flatwashers
37-0780	#10 Parkerized Lockwashers
37-0781	#12 Parkerized Flatwashers
37-0782	#12 Parkerized Lockwashers
37-0783	3/8 Parkerized Flatwashers
37-0784	3/8 Parkerized Lockwashers
37-0785	5/16 Parkerized Flatwashers
37-0786	5/16 Parkerized Lockwashers
37-0828	5/16 Cadmium Lockwashers
37-0787	7/16 Parkerized Flatwashers
37-0788	7/16 Parkerized Lockwashers
37-0789	#8 Parkerized Flatwashers
37-0790	#8 Parkerized Lockwashers
<b>Cotter Pin</b>	
37-0747	1/16 — 1/2 Cotter Pin
37-0749	3/32 — 1 Cotter Pin

# Cloth Patches Sold as a pair except where noted.



- Cloth Patches can be ironed or sewn on. Sold as a pair unless noted.
- |                               |                             |                                    |
|-------------------------------|-----------------------------|------------------------------------|
| 48-0368 Sifton Handshake      | 48-1340 Super X             | 48-1481 B and M Shifter            |
| 48-0369 AEE                   | 48-1341 Yale                | 48-1482 Lodge Spark Plug           |
| 48-0472 Joe Hunt Rectangle    | 48-1342 Iver Johnson        | 48-1483 DuCoil                     |
| 48-0544 Tedd Cycle, 1969      | 48-1343 Linkert Air Dam     | 48-1484 POSA Fuel                  |
| 48-0634 Shovelhead            | 48-1346 VL Spark Plug       | 48-1485 McCulloch                  |
| 48-0930 Purple Heart          | 48-1347 V-Twin Customizer   | 48-1486 Daytona Race               |
| 48-0946 Sifton Pack           | 48-1348 Servi Cycle         | 48-1487 KLG                        |
| 48-1064 Knucklehead Wings     | 48-1349 Hap Jones 50 years  | 48-1488 Speed Industry             |
| 48-1163 Knucklehead           | 48-1350 British Patent Tag  | 48-1489 CZ Motorcycle              |
| 48-1164 Line Knucklehead      | 48-1354 Hap Jones Tank      | 48-1491 Stromberg Carb             |
| 48-1187 Knucklehead           | 48-1355 World's Fair        | 48-1492 Dover Drag                 |
| 48-1208 Sifton                | 48-1357 XLH 1000            | 48-1493 Montgomery Drag            |
| 48-1324 Buco                  | 48-1358 Anderson Supply     | 48-1494 Hallcrafts                 |
| 48-1325 Bates                 | 48-1359 Stewart Warner      | 48-1515 Bobber                     |
| 48-1326 Beck                  | 48-1360 FLH 1200            | 48-1523 Rowe                       |
| 48-1327 Sifton                | 48-1361 V-Twin Square       | 48-1531 Wall of Death              |
| 48-1328 R Racing              | 48-1362 Newburgh Lumination | 48-1533 Oil Fill                   |
| 48-1329 H Racing              | 48-1384 Stewart Warner      | 48-1603 Burkhardt Magneto          |
| 48-1330 BSA                   | 48-1432 Cycle Shack         | 48-1604 SAE 60 Weight Oil          |
| 48-1332 Split Dorf Plug       | 48-1472 Motorcyclepedia QR  | 48-1605 Johnson Motors             |
| 48-1333 Replica V-Twin Shield | 48-1474 Thor                | 48-1634 Motorcyclepedia Round      |
| 48-1334 True to Original      | 48-1475 Motorcycle Museum   | 48-1635 Iver Johnson Round         |
| 48-1335 V-Twin Product Sign   | 48-1476 Helligs Hollywood   | 48-1637 45 VW Army                 |
| 48-1336 V-Twin Motor Shop     | 48-1477 Delco Remy          | 48-1642 Beck 18mm Spark Plug       |
| 48-1337 Corbin-Gentry         | 48-1478 Guide Cycle Ray     | 48-1649 Lockhart                   |
| 48-1338 Wyatt Gatling         | 48-1479 Hastings Rings      | 48-1760 Tracy Products             |
| 48-1339 Pope                  | 48-1480 Stewart Warner      | 48-1672 Motorcyclepedia Wing       |
|                               |                             | 48-1764 Oilzum                     |
|                               |                             | 48-1772 Joe Hunt Early             |
|                               |                             | 48-1777 Avon Mud Plugger           |
|                               |                             | 48-1780 Matchless                  |
|                               |                             | 48-1781 York Drive Train           |
|                               |                             | 48-1782 1964 World's Fair          |
|                               |                             | 48-1783 Square V-Twin Mfg.         |
|                               |                             | 48-1785 National Custom Cycle      |
|                               |                             | 48-1786 Hurst                      |
|                               |                             | 48-1787 Flanders                   |
|                               |                             | 48-1788 Indian Time Line           |
|                               |                             | 48-1819 Motorcyclepedia            |
|                               |                             | 48-1889 V-Twin Motor Service       |
|                               |                             | 48-1890 International Car Show     |
|                               |                             | 48-1891 Sifton Cam                 |
|                               |                             | 48-1961 Doering Spark Plug         |
|                               |                             | 48-1962 Orange County New York     |
|                               |                             | 48-1968 Tedd Cycle                 |
|                               |                             | 48-1972 Drain Oil                  |
|                               |                             | 48-1973 Made in America            |
|                               |                             | 48-1974 FLH                        |
|                               |                             | 48-1975 KHK                        |
|                               |                             | 48-1977 Motorcyclepedia Spark Plug |
|                               |                             | 48-2123 Whizzer                    |
|                               |                             | 48-2176 Hunt Magneto Shape         |
|                               |                             | 48-2177 Newburgh Kleig             |
|                               |                             | 48-2288 Akront Rim                 |
|                               |                             | 48-2289 Stelling & Helligs Co      |
|                               |                             | 48-2290 Klieg Newburgh             |
|                               |                             | 48-2291 Hudson Valley AMCA         |
|                               |                             | 48-2292 Vertical Magneto           |
|                               |                             | 48-2293 Superior Dixie             |
|                               |                             | 48-2294 NYS License Plate          |
|                               |                             | 48-2296 Angola Roller Rink         |
|                               |                             | 48-2297 Oilzum Bike                |
|                               |                             | 48-2298 Triangle Chicago           |
|                               |                             | 48-2300 Vincent                    |
|                               |                             | 48-2301 Visco Motor Oil            |
|                               |                             | 48-2302 Police Eagle               |
|                               |                             | 48-2303 Penton                     |
|                               |                             | 48-2304 Norton                     |
|                               |                             | 48-2305 Well Made In Taiwan        |
|                               |                             | 48-2306 Wico                       |
|                               |                             | 48-2307 Washington's Headquarters  |
|                               |                             | 48-2308 Delivery Stamp             |
|                               |                             | 48-2309 1000 XLCH                  |
|                               |                             | 48-2310 Alphabet Exhaust           |
|                               |                             | 48-2311 1913 Motorcycle Stamp      |
|                               |                             | 48-2313 Motor Patrol               |
|                               |                             | 48-2314 Pit's Wall of Death        |
|                               |                             | 48-2318 Avalon                     |
|                               |                             | 48-2319 No One Has...              |
|                               |                             | 48-2320 New Parts Slogan           |





# Pewter



Pewter Motors are mounted on a wooden base.

VT No.	Type	VT No.	Type
48-1765	Flathead	48-0940	5 Piece Set
48-1766	Panhead	48-1372	Metal Box
48-1767	Knucklehead	48-1628	6 Piece Set
48-1768	Shovelhead	48-1771	Knucklehead
48-1770	Evolution	48-1798	TC-88 1999 Replica
48-1901	De Dion Bouton		



1/6" Motor Models.

VT No.	Type
48-1365	74" Indian Chief Model
48-1366	61" Powerplus Model

883 XL Model.  
Ironhead motor model features 1:10 scale with authentic 1957 Sportster 900cc details!  
VT No. 48-0746

Fairbanks 1/2 Scale Magneto Model.  
Pewter construction.  
VT No. 48-1675



1/6" Motor Models.  
48-1516 Knucklehead  
48-1517 Panhead  
48-0836 Flatside Shovel  
48-0742 45 WL  
48-1377 JD Racer Model  
48-1198 Metal Box  
48-1383 Metal Box

Linkert M Carburetor is a detailed 3/8" scale model! Fully pewter casted and mounted on a wooden base. VT No. 48-1467



1936 Knucklehead Model. Authentic details, 4.5" long.  
VT No. 48-0931



Lapel Pins with silver patina.

VT No.	Style
48-1501	Panhead
48-1502	Knucklehead
48-1503	Flathead
48-1511	Shovelhead
48-1513	Evolution
48-1518	Skull Set
48-1627	Evolution Gift Set
48-1370	Set

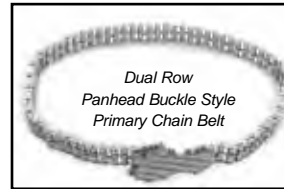

Dual Row Panhead Buckle Style Primary Chain.

VT No.	Size
48-0594	36"
48-0595	38"
48-0596	40"
48-0597	42"

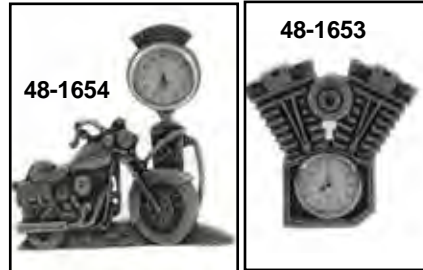
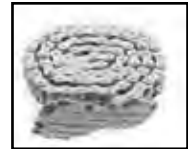

Pewter Clocks with silver patina. Battery included.

VT No.	Item
48-1654	Motorcycle
48-1653	V-Twin Motor



Key Chains.

VT No.	Type
48-0233	Wrench
48-0234	Shock Absorber
48-0235	Piston
48-0236	Spark Plug
48-0237	Hand Cuff
48-0238	Crankshaft
48-0240	Lever Blade
48-0241	Wheel
48-0243	Bearing

VT No.	Type
48-0244	Chain
48-1657	Motor
48-1661	Shovelhead
48-1662	Panhead
48-1663	Knucklehead
48-1664	45
48-1665	Evolution
48-1247	Knuck Motor
48-1469	Evo Motor
48-1468	1999 88" Engine



Motorcycle Key Holder has a bronze finish. Mounting hardware included.

VT No. 48-0947



Note: Fit standard size men's 1½" belt.

# Belt Buckles

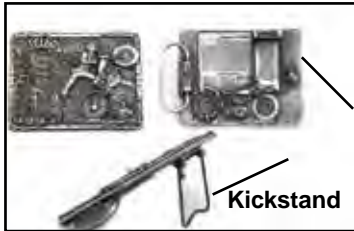

Note: Some belt buckles include kickstand which makes for easy displaying.

Belt Buckles fit standard size men's 1½" belt.

- | VT No.  | Item                           |
|---------|--------------------------------|
| 48-0297 | Laconia                        |
| 48-0448 | British Motorcycle             |
| 48-0471 | Panhead Cam Cover              |
| 48-0823 | Electra Glide                  |
| 48-0839 | 1999 88" Engine                |
| 48-0824 | Motorcyclepedia, Brass         |
| 48-0825 | Duo-Glide, Oval                |
| 48-0879 | Knucklehead 61" 1936-47        |
| 48-0901 | Skeleton Hand                  |
| 48-0929 | Tedd Cycle                     |
| 48-0934 | Chopper                        |
| 48-0937 | Live to Ride 75th Anniversary  |
| 48-0948 | Flatside Shovelhead Cam Cover  |
| 48-0949 | Knucklehead 1939 Cam Cover     |
| 48-0959 | Curtiss                        |
| 48-1112 | Oval First V-Twin              |
| 48-1113 | 1936 Knucklehead Bronze Accent |

- | VT No.  | Item                              |
|---------|-----------------------------------|
| 48-1115 | V-Twin Round Bronze               |
| 48-1193 | Hillclimber                       |
| 48-1351 | Ironhead 1972-85                  |
| 48-1352 | Shovelhead Round, Brass           |
| 48-1371 | 50th Daytona                      |
| 48-1473 | Ironhead XLH Electric Start Style |
| 48-1507 | V-Twin Round                      |
| 48-1508 | Teardrop                          |
| 48-1509 | Round Schebler                    |
| 48-1510 | 1948 Panhead                      |
| 48-1512 | Wyatt Gatling Sportster Gas Tank  |
| 48-1514 | Shovelhead                        |
| 48-1545 | XL Cam Cover                      |
| 48-1632 | Motorcycle Postage Stamp          |
| 48-1633 | Beck Spark Plug                   |
| 48-1645 | Linkert Carburetor                |
| 48-1655 | 45" Cam Cover                     |
| 48-1660 | Liberty 100 Year Anniversary      |

- | VT No.  | Item                           |
|---------|--------------------------------|
| 48-1674 | Liberty "Stand Up for America" |
| 48-1769 | Loud Pipes Save Lives          |
| 48-1773 | JD Motor                       |
| 48-1775 | Motorcycling "Greatest Sport"  |
| 48-1784 | Skull                          |
| 48-1892 | Motorcyclepedia                |
| 48-1928 | Indian 101                     |
| 48-1970 | Nose Cone Cam Cover            |
| 48-7779 | Skull with wings               |
| 48-7780 | Skull with wings               |
| 48-7783 | 1936 Knucklehead               |
| 48-7784 | Live to Ride, 75th 3" diameter |
| 48-7787 | XLCH 1957 Sportster            |



- | Skull Keychain |                 |
|----------------|-----------------|
| VT No.         | Finish          |
| 48-1820        | Brass           |
| 48-1821        | Chrome          |
| 48-1822        | Polished Pewter |
| 48-1823        | Black Pewter    |



- | Key Chains. Sold in sets of 4. |            |
|--------------------------------|------------|
| VT No.                         | Style      |
| 48-0233                        | Wrench     |
| 48-0235                        | Piston     |
| 48-0236                        | Spark Plug |
| 48-0244                        | Chain      |





# Gift Sets

48-1521



48-1522



48-1524



48-1526



48-1470



48-1527



48-1528



## Belt Buckle Series.

- | VT No.  | Item                   |
|---------|------------------------|
| 48-1521 | Shovelhead Series (5)  |
| 48-1522 | Ironhead Series        |
| 48-1524 | Motorcyclepedia Series |
| 48-1525 | Shovelhead Series      |
| 48-1526 | Beck/Linkert Series    |
| 48-1470 | Sportster              |
| 48-1527 | Chopper Series         |
| 48-1528 | Evo Series             |



Oilzum Novelty Oil Can Coin Bank with colorful graphic body, 6 pack. Top and bottom are non-removable.

VT No. 48-0534



48-1637



48-0837



48-8001



48-8002



48-8003



48-8004



48-8005



48-8006



48-8008



48-8009



48-8010



48-8003



48-0549



48-8011



48-0543

## Cloth Patch Series.

- 48-8001** Series 1, Joe Hunt Magneto, Vintage Style Oilzum Oil, AEE Chopper, V-Twin MFG Customizer, and an "I Bought American" patch.
- 48-8002** Series 2, Beck, Sifton Motorcycle Products, Sifton Handshake, V-Twin Motorshop, and a FLH patch, V Hap Jones 50 Years, Tedd Cycle
- 48-8003** Series 3, V Hap Jones 50 Years, Tedd Cycle, SAE 60 Weight Oil, and a Drain Oil
- 48-8004** Series 4, Linkert Air Dam, New Parts for an Old Standard, Replica V-Twin Shield, Guide Cycle Ray Logo, and a Lockhart
- 48-8005** Series 5, Flanders, Akront Rim, Joe Hunt Magneto Vintage, and Speed Industry, Hellings and Stellings
- 48-8006** Series 6, XL 1000, Joe Hunt Magneto Vintage, Akront Rim, Flanders
- 48-8007** Series 7, KHK, Made in America,
- 48-8008** Series 8, Wall of Death, World's Fair 1940, Motorcyclepedia Museum, Made in America, and a Hellings and Stellings
- 48-8009** Series 9, V-Twin Motorshop, Akront Rim, KHK, Joe Hunt Vertical Magneto, and a Lockhart patch.
- 48-8010** Series 10, V-Twin Product, V-Twin Motor Service, Replica V-Twin Shield, V-Twin MFG Customizer, and a Linkert Air Dam patch
- 48-8011** Series 11, Yale, Pope, Motorcyclepedia Museum, Made in America, and a Hellings and Stellings
- 48-0549** V-Twin Brands; Sifton Cam, Replica V-Twin Shield, V-Twin Product Sign, V-Twin Motorshop, V-Twin MFG Customizer, Hellings Company, New Parts for an Old Standard, Tedd Cycle, and Burkhart Magneto
- 48-0543** Vintage Brands; Oilzum, Alphabet Exhaust, Anderson Supply, Hellings Company, Hudson Valley AMCA, Sifton Handshake, AEE Chopper, Linkert Air Dam, Sifton Motorcycle Products, and Tedd Cycle
- 48-1637** Army Patch Set
- 48-1623** Tedd Cycle Local Patch Set
- 48-0837** Hot Rod Patch Set



# Gift Sets



48-1373



48-1374



48-1375



48-1530



48-1376



48-0371



48-1117



48-0781



48-0828



48-1525



48-0741



48-1627



48-1370



48-0224

- Gift Sets**
- | VT No.  | Model             |
|---------|-------------------|
| 48-1373 | Panhead           |
| 48-1374 | Shovelhead        |
| 48-1375 | Knucklehead,      |
| 48-1530 | Knucklehead,      |
| 48-1376 | Flathead          |
| 48-0371 | Oilzum            |
| 48-1117 | JD Racer          |
| 48-0741 | Sportster Set (6) |

- |         |                         |
|---------|-------------------------|
| 48-0828 | British Motorcycle Set  |
| 48-1627 | Evo                     |
| 48-1370 | Motor Lapel Pin Set (5) |
| 48-0827 | Motorcyclopedia         |
| 48-0224 | Twin Cam Set            |
| 48-0781 | Sportster               |
| 48-1525 | Shovelhead              |



48-0926

48-1383

48-1369



- V-Twin™ Metal Containers.**
- | VT No.  | Size                    |
|---------|-------------------------|
| 48-0926 | Round Can 6.61" x 3.94" |
| 48-1383 | 112mm x 112mm x 125mm   |
| 48-1372 | 89mm x 89mm x 98mm      |
| 48-1369 | 69mm x 69mm x 65mm      |
| 48-1690 | Waste Basket, 5 gallon  |



**Brando Style Hats.** Pleated top has button on top for detail. Yellow braided rope is fastened by button on each side. Visor is white trimmed with black.

- | VT No.  | Size   |
|---------|--------|
| 48-0871 | Child  |
| 48-0872 | Small  |
| 48-0873 | Medium |
| 48-0874 | Large  |



**Accel Floor Mat**  
VT No. 48-0201



**Wall of Death model by Faller.** Unassembled. This is an original reproduction of the breathtaking Pit's steep face show. It functions like the original with three motorcycles driving around the steep face, complete with drive motor and automatic electronic control unit (16v AC/DC). With truck and trailer. H-O scale.

VT No. 48-0867



**Matchbox Collector Set** includes five toys and one patch.  
VT No. 48-7627

Endorsed by  
Pit and Esther  
Lengner [www.steilwand.de](http://www.steilwand.de)  
For more information  
about the original.





# V-Twin™ Reference



V-Twin™ Catalog Racks are black with a V-Twin logo. Feature steel construction to firmly sit on countertop.

VT No.	Item
48-1702	18" Rack
48-1712	Turntable for Rack



V-Twin™ Dealer Promo Wall Banner Pack includes banner and (2) V-Twin Catalogs. The banner is in full color. Measures 3' x 6'. Heavy gauge vinyl.

VT No. 48-0068



Wyatt Gatling 18" x 24" features metal product logo.  
VT No. 48-0103



Tedd Cycle Metal Sign with embossed letters. 18" wide.  
VT No. 48-0945



VT No. 48-0004



VT No. 48-0001

V-Twin™ Dealer Promo Items. V-Twin™ Hours Open Sign in double faced for use on windows or opaque surfaces. V-Twin™ Authorized Dealer Decal is in full color on mylar.

VT No.	Decal
48-0004	Hours
48-0001	Dealer



V-Twin™ Shop Bag. Full color V-Twin™ Logo, 8" x 16" deep. Sold in 50 pack.

VT No.	Type
48-0040	White with logo
48-0054	Clear without logo



V-Twin Mouse Pad made of natural rubber. Measures 8 3/4" x 7" with 1/8" thickness. Purple and orange cloth.  
VT No. 48-1505



V-Twin Product Sign is constructed of 30 gauge steel measuring 18" x 18"  
VT No. 48-1114



Tedd Cycle, Inc. Company Profile Brochure includes credit card application and order forms.  
VT No. 48-0159



Bottler Opener  
VT No. Type  
48-0545 Tedd Cycle  
48-1965 Motorcyclepedia

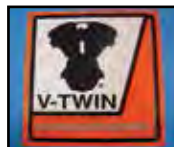

V-Twin Dealer Decal features full color on adhesive vinyl for indoor or outdoor display, measuring 14" x 14".  
VT No. 48-0164



Wire Tags in a pack of 25, 1 7/8" x 3 3/4" with wire attached.  
VT No. 48-0118



V-Twin Patches and Brand Set includes ten different patches. VT No. 48-0549



V-Twin Catalogs are available for dealers to supply to customers.

VT No.	Item
48-0035	Product Reference Guide (1328 pages)
48-1331	Knucklehead
48-1364	Panhead



48-1263



48-1264



48-1265

V-Twin™ Commemorative is 1/25" scale measuring 7" long, lockable coin bank and authentic Tedd Cycle, Inc., V-Twin™ logos and colors.

VT No.	Type
48-1263	Chevy Truck, 13th Edition
48-1264	Dodge Pickup, 14th Edition
48-1265	Coupe, 15th Edition



Cloth Patches available with V-Twin Mfg. and our brands. Sold as a pair.



V-Twin™ Counter mat features our colorful logo. Orange, purple and black on carpet.  
VT No. 48-0012

V-Twin™ Metal Containers.

VT No.	Size
48-0926	Round Can 6.61" x 3.94"
48-1383	112mm x 112mm x 125mm
48-1372	89mm x 89mm x 98mm
48-1369	69mm x 69mm x 65mm
48-1690	Waste Basket



48-0498  
80" UL



48-0470  
Knucklehead



48-0030  
1340 cc



48-0033  
Dual Cam



48-0025  
Panhead



48-0044  
Shovelhead



48-0048  
Shovelhead



48-0372  
XLCH 1971



48-1824  
45"

Motor Plaques measure 18" x 24" and are made of metal.

Motor Plaque Set includes 9 plaques. VT No. 48-1811